

# Approaches to Environmental Accounting



# Contributions to Economics

---

Albrecht Ritschl  
**Prices and Production**  
- Elements of a System - Theoretic  
Perspective -  
1989. 159pp. Softcover DM 59,-  
ISBN 3-7908-0429-0

Arnulf Grübler  
**The Rise and Fall of Infrastructures**  
- Dynamics of Evolution and  
Technological Change in Transport -  
1990. 305pp. Softcover DM 85,-  
ISBN 3-7908-0479-7

Peter R. Haiss  
**Cultural Influences on Strategic Planning**  
1990. 188pp. Softcover DM 65,-  
ISBN 3-7908-0481-9

Manfred Kremer/Marion Weber (Eds.)  
**Transforming Economic Systems:  
The Case of Poland**  
1992. 179pp. Softcover DM 69,-  
ISBN 3-7908-91415-3

Marcel F. van Marion  
**Liberal Trade and Japan**  
1993. 298pp. Softcover DM 90,-  
ISBN 3-7908-0699-4

Michael Carlberg  
**Open Economy Dynamics**  
1993. 203 pp. Softcover DM 75,-  
ISBN 3-7908-0708-7

Hans Schneeweiß/  
Klaus F. Zimmermann (Eds.)  
**Studies in Applied Econometrics**  
1993. 238 pp. Softcover DM 85,-  
ISBN 3-7908-0716-8

Gerhard Gehrig/Wladyslaw Welfe (Eds.)  
**Economies in Transition**  
1993. 292 pp. Softcover DM 90,-  
ISBN 3-7908-0721-4

Alfred Franz  
Carsten Stahmer (Eds.)

---

# Approaches to Environmental Accounting

Proceedings of the IARIW Conference on  
Environmental Accounting,  
Baden (near Vienna), Austria  
27-29 May 1991

With 37 Figures

Physica-Verlag

A Springer-Verlag Company

**Series Editor**

Werner A. Müller

Peter Schuster

**Editors**

Professor Dr. Alfred Franz

Austrian Central Statistical Office

Hintere Zollamtsstrasse 2b

A-1033 Vienna, Austria

Dr. Carsten Stahmer

Federal Statistical Office of Germany

Gustav-Stresemann-Ring 11

D-65189 Wiesbaden, Germany

ISBN 978-3-7908-0719-6

ISBN 978-3-642-49977-7 (eBook)

DOI 10.1007/978-3-642-49977-7

CIP-Titelaufnahme der Deutschen Bibliothek

Approaches to environmental accounting: proceedings of the IARIW Conference on Environmental Accounting, Baden (near Vienna), Austria, 27 - 29 May 1991 / Alfred Franz; Carsten Stahmer (ed.). - Heidelberg: Physica-Verl., 1993

(Contributions to economics)

ISBN-13: 978-3-7908-0719-6

NE: Franz, Alfred [Hrsg.]; Conference on Environmental Accounting <1991, Baden, Wienerwald>; International Association for Research in Income and Wealth

This work is subject to copyright. All rights are reserved, whether the whole or part of the material is concerned, specifically the rights of translation, reprinting, reuse of illustration, recitation, broadcasting, reproduction on microfilms or in other ways, and storage in data banks. Duplication of this publication or parts thereof is only permitted under the provisions of the German Copyright Law of September 9, 1965, in its version of June 24, 1985, and a copyright fee must always be paid. Violations fall under the prosecution act of the German Copyright Law.

© Physica-Verlag Heidelberg 1993

The use of registered names, trademarks, etc. in this publication does not imply, even in the absence of a specific statement, that such names are exempt from the relevant protective laws and regulations and therefore free for general use.

88/7130-543210 - Printed on acid-free paper



## **Foreword**

It is really no longer necessary to stress the importance of availing of sound statistical information on the environment. Originally limited to circles of insiders and experts this message has now fully reached political decision makers and the general public at large. In this procedure macro-economics has assumed a particular role, e.g. when evaluating related financial implications but also when propagating alarming overall figures on the harm this generation is doing to our environment.

Accordingly, the need is obvious to further promote the development of international standards and co-operation in the field of environment statistics in general and environmental economic accounts in particular.

Therefore, the Austrian Statistical Society (ASS) together with the Austrian Central Statistical Office (ACSO) with pleasure hosted the IARIW Special Conference on Environmental Economic Accounts, in May 1991. These institutions are similarly pleased that now this publication on the proceedings of this Conference can be presented. They connect this with grateful thanks to all those who contributed to the successful completion of this work, in particular the authors and the editors.

The impression seems warranted that the outcome of this coordinated overall endeavour was more than just better mutual understanding, viz. something like an increasing consciousness of the common denominator tending to expand.

The Chairmen of the Austrian Statistical Society

**E. Bader**

**President,  
Austrian Central  
Statistical Office**

**R. Viertl**

**Prof., University of Technology Vienna,  
Head of ASS's WP on  
Environmental Statistics**

## CONTENTS

	Seite
A. Franz, C. Stahmer INTRODUCTION .....	1
Henry M. Peskin NATIONAL ACCOUNTING FOR RESOURCE AND ENVIRONMENTAL DEGRADATION: ALTERNATIVE APPROACHES AND CONCEPTS .....	18
Roefie Huetting CALCULATING A SUSTAINABLE NATIONAL INCOME: A PRACTICAL SOLUTION FOR A THEORETICAL DILEMMA .....	39
R.G. Michaels, A.E. Grambsch, H.M. Peskin NEITHER FISH NOR FOWL? CAN ENVIRONMENTAL ACCOUNTS GUIDE ECONOMIC POLICY, ENVIRONMENTAL POLICY, BOTH OR NEITHER? CONCLUSIONS FROM A UNITED STATES CASE STUDY .....	70
Anthony M. Friend TOWARDS PLURALISM IN NATIONAL ACCOUNTING SYSTEMS .....	93
Mike D. Young NATURAL RESOURCE ACCOUNTING: SOME AUSTRALIAN EXPERIENCES AND OBSERVATIONS .....	111
Robert U. Ayres MATERIALS/ENERGY FLOWS AND BALANCES AS A COMPONENT OF ENVIRONMENTAL STATISTICS .....	126
A.J. de Boo, P.R. Bosch, C.N. Gorter, S.J. Keuning AN ENVIRONMENTAL MODULE AND THE COMPLETE SYSTEM OF NATIONAL ACCOUNTS .....	143
John M. Hartwick NOTES ON ECONOMIC DEPRECIATION OF NATURAL RESOURCE STOCKS AND NATIONAL ACCOUNTING .....	167
Thomas K. Rymes SOME THEORETICAL PROBLEMS IN ACCOUNTING FOR SUSTAINABLE CONSUMPTION .....	199
Jonathan Levin VALUATION AND TREATMENT OF DEPLETABLE RESOURCES IN THE NATIONAL ACCOUNTS .....	220
Salah El Serafy DEPLETABLE RESOURCES: FIXED CAPITAL OR INVENTORIES? .....	245
Gonzague Pillet ACCOUNTING FOR THE CONTRIBUTION OF ENVIRONMENTS TO ECONOMIC MACROPROZESSES .....	259

## VIII

R. Dell'mour, P. Fleissner, W. Hofkirchner, A. Steurer SUBSTITUTION OF TRANSPORT ACTIVITIES: AN INPUT-OUTPUT APPROACH TO DETERMINE ECONOMIC AND ENVIRONMENTAL EFFECTS .....	282
Josef Richter ENVIRONMENTAL ACCOUNTING: SOME NON-TECHNICAL REMARKS .....	295
Bent Thage THE NATIONAL ACCOUNTS AND THE ENVIRONMENT .....	314
Karine Nyborg "ECO DOMESTIC PRODUCT": THE ANSWER TO WHICH QUESTION? .....	337
Utz P. Reich APPLYING THE NOTIONS OF CAPITAL AND INCOME TO NATURAL DEPLETABLE RESOURCES IN ECONOMIC ACCOUNTS .....	348
J. Blazejcak, D. Edler A STYLIZED MODEL FOR CALCULATING AVOIDANCE COSTS .....	365
A. Franz, N. Rainer CLASSIFICATION IN ENVIRONMENTAL ACCOUNTING: SOME OBSERVATIONS ON THE PRESENT STATE .....	379
A. Giannone, M. Carlucci ENVIRONMENTAL VARIABLES IN NATIONAL ACCOUNTS: A CASE STUDY FOR ITALY .....	394
Stephan Fickl ENVIRONMENT IN A NATIONAL ACCOUNTS FRAMEWORK: THE AUSTRIAN APPROACH TO ENVIRONMENTAL ACCOUNTING .....	406
Jinchang Li CHINA'S RESEARCH ON RESOURCE ACCOUNTING AND ITS APPLICATION TO THE NATIONAL ECONOMIC ACCOUNTING SYSTEM .....	427
A. Aaheim, O. Lone, K. Nyborg NATURAL RESOURCE ACCOUNTING: THE NORWEGIAN EXPERIENCE .....	446
Leo Koittola NATIONAL RESOURCE ACCOUNTING IN FINLAND .....	458
M. Fischer-Kowalski, H. Haberl, H. Payer, A. Steurer, H. Zangerl-Weisz CAUSER-RELATED INDICATORS FOR STRESSES UPON THE ENVIRONMENT. A CONTRIBUTION TO THE ENVIRONMENTAL SATELLITE-SYSTEM OF THE AUSTRIAN SNA .....	475
P. Bartelmus, J. van Tongeren SELECTED ISSUES IN INTEGRATED ENVIRONMENTAL ECONOMIC ACCOUNTING .....	488
Carsten Stahmer SYSTEM FOR INTEGRATED ENVIRONMENTAL AND ECONOMIC ACCOUNTING (SEEA) OF THE UNITED NATIONS .....	511
<b>ANNEX</b>	
MAILING ADDRESSES OF AUTHORS .....	541

# INTRODUCTION

## 1. Preliminaries

Still young, the history of National Accounts (NA) as a worldwide applied system has achieved overwhelming progress, by extending the scope and increasing the detail as well as by intensifying the reporting frequency. At the same time old issues of theoretical controversy have been successively clarified and, if not solved, often settled by compromise. It has proved most productive with regard to the presentation of economic agents in terms of transactors and their activities in terms of transactions, whereas developments in functional terms and cross section presentations beyond the borders drawn by the economic paradigm are still somewhat lagging. All this is particularly true with a view to a subject like the environment, with widespread but often less obvious reference points in the system itself, and often complicated interrelations with contexts not covered by traditional economic statistics at all. While since about 20 years the environment has been increasingly addressed as a concern of NA, this development did not keep pace with the accelerating deterioration on the part of the environment itself nor with an increasing demand of the political actors for more purposeful overall information of this kind. Many different reasons on the part of scientific and statistical management as well as on the part of involved socio-economic interests have resulted into a variety of response which can not be fully pursued here. However, one particular reason for a new decisive initiative can easily be quoted. The revision of the UN's System of National Accounts (SNA 1968) and the concomitant intention to support the revised system by additional "Manuals", preferably in fields with urgent needs for statistical standardization and progress of concept like the environment, the Statistical Division of the United Nations (UNSTAT) itself had commissioned the work on a **Draft Manual on a System for Integrated Environmental & Economic Accounting (SEEA)**. Most distinguished in the field of scientific evaluation of concepts

of NA and its vicinities the IARIW, at the same time, recognized that it should play a particular role in this development. With broad support by the various international organizations interested as well as its immediate membership at the 21st General Conference, Lahnstein (Germany), 20 - 25 August 1991, the decision was taken that a Special Conference should be arranged to discuss the whole field of environmental accounting, thus supporting the drafting of the before-mentioned Manual.

It seemed most important that this Conference should become representative as regards the range of theoretical positions as well as practical exercises attempted so far. To be sufficiently productive with a view to contributions useful for the Manual it seemed at the same time important that the number of participants would not be too large and more or less homogeneous as regards their reputation in this discipline. It was felt that these aims could be more easily achieved by the principle that each participant should be (co-)author of a paper or otherwise involved by a particular function, as session organizer or as discussant. (The organizers were responsible for the selection of the individual contributions.) From the beginning it was envisaged that the proceedings of this Conference should be published to provide the greatest possible audience to this event.

## 2. Organization and contents

The Conference was organized in 6 sessions, each with a set of invited and contributed papers, presented by a discussant rather than by the author and later on discussed generally, as usual. The structure by sessions was as follows:

- (1) Concepts of Environmental Accounting (General Aspects)
- (2) Physical data and their links to national accounts
- (3) Depletable resources and their valuation
- (4) Estimation of environmental degradation and its welfare effects
- (5) Experiences in developed countries
- (6) Experiences in developing countries

However, for the present publication, this order has not been maintained, for several reasons: **First**, the attribution to sessions was often a bit arbitrary, due to inherent overlapping and un-

clear borderlines; **secondly**, the discussion and in particular the use of the argument with a view to the Manual sometimes led to different evaluations; **thirdly**, not all authors were prepared to redo their papers for publication; **lastly**, a possible parallel, selective publication of similar substance in the Review of Income and Wealth (the IARIW's quarterly) had to be taken into account also. Therefore, a new ordering was defined, more or less following the great blocks of theoretical positions taken and related empirical exercises. Still then, a variety of further criteria can be taken into account as attempted in the below overview, together with the names of the authors. (see **Diagram**)

This presentation may serve as a first guide to find out points (blocks) of particular interest, or preliminarily allocate to the various purposes in a greater context. The lasting main issues of economic environmental accounting are several, as follows: What should be taken into account (in terms of transactors, stocks and flows)? How can, and should, this be measured (in technical terms of statistical observation)? How should the interactions of the economy and the environment be represented (in terms of a model)? Answers on all these questions can be found in this book, although not unanimous and from different points of view as regards main concerns of interest, but with a large common denominator: the moral consternation about the progressive using up of environmental assets, not being unequivocally represented in our accounts; and the professional strive for a proper solution of the many theoretical and technical questions and relations involved. In such situation and with a view to the present state of the arts it may still seem to be more appropriate to show a variety of opinions rather than apodictically to put forward "only true" solutions.

The criteria considered in the above mentioned overview presentation are on the one hand the main attitude towards changes of the present SNA "to take into account" the environment. This may be a willingness either to adapt or to extend the system (or to do both) in order to integrate environmental aspects primarily by attaching values to objects or processes not represented in the present SNA, that way reflecting in monetary terms what happens to (and through) the environment. Obviously, there are different degrees of how far to proceed with such amendments and, accordingly, different types of "**progressivity**". Such valuations, any-

	Progressivists (adaptors of the system)	Skeptics & "Conservatives"	Pragmatists & "Statisticians"
Theoretical (Conception)	Hueting Bram de Boo et al. Friend Stahmer/UN	Richter Thage	Peskin Blazejczak/Edler
	Systems		
	Features	Nyborg Reich (L)	Franz/Rainer
Empirical (Case Studies)	Monetary (& physical)		Fickl Giannone/Carlucci Li
	Physical (only)		Lone Koltola Fischer et al.

how, lack the confirmation by manifest market exchange and, therefore, there is a point to question the valuation and to principally doubt a related analytical outcome, notwithstanding the often tremendous difficulties of compilation techniques alone. This argument is the concern of a more conservative group, which is here labelled as **"skepticist"**. Whether for more ethical reasons the overall assessment is shared or not, such reasoning being given space is not only a matter of scientific balance but should help to avoid one-sided or superficial solutions in the end. - A third group is less determined as regards theoretical argumentation but fully recognizes the need to provide statistical data in a more appropriate and useful way than so far done. This **"pragmatic"** attitude is often found in circles of practical statisticians which more than once in history had to develop statistical reporting patterns even if theory was still not at hand, or controversial. According to this basic attitude, they would most easily accept complementary and parallel systems not changing the core of the traditional SNA. It is perhaps interesting to add that the "skeptical" authors either themselves belong to the discipline of NA or are otherwise closely thereto related in their professional life. They may thus represent a certain mood not infrequently found in this branch when adaptation of the traditional system is at issue.

Further criteria useful in this context are the points mainly addressed in terms of universality (systems as a whole) or detailed features. Particularly in the latter respect the discussion sometimes reaches a considerable degree of theoretical abstraction. - A further distinction, which is in this context useful to obtain an idea of actual implementation is the theoretical vs. empirical character of the exercise involved. In the latter respect there is also the distinction between monetary vs. physical presentation, which is able to characterise the nature of the information primarily aimed at. Although surely useful as a first guidance, however, all these distinctions have not been felt to be sufficiently sharp and exclusive to serve as a basis e.g. of a classification by chapters of the whole set of papers: The various papers seem to be characterized rather than classified, due to a usually large degree of overlapping and common argument, and considerable arbitrariness remains that way. Therefore, the reader will find a sequence roughly following the above presented overall organization (see above Diagram), but without further organization. However, in organizing this book, the primary idea was to



present a "textbook" type collection, preferably to be read from the beginning to the end, and with a certain development of the basic issue. It seemed accordingly appropriate to start with a paper which gives a solid overview of the various theories and approaches to be found nowadays (PESKIN); and to end with an updated summary of the Draft of the SEEA-Maual, the very target reference of the whole Conference (STAHMER). - Altogether, with sometimes quite accentuated (not to say unconventional) positions taken, the papers placed in between these ends seem more or less to cover the entire range of the contemporaneous topical discussion.

To give further guidance, in the subsequent **Summary** a very brief appreciation of the various papers is attempted, also taking note of the discussion at the Conference itself and certain subsequent developments as well. Any statement of this kind, however, is within the responsibility of the editors.

### 3. **Summary on the papers presented**

As mentioned already, a quite comprehensive overview is found first, written by **H.M. PESKIN**, otherwise well known as one of the main advocates of the neoclassical valuation approach to integrate the environmental phenomena in greater contexts like NA. Starting from the widely felt deficiencies of the conventional accounts he summarily examines the various common approaches, evaluating not only their theoretical implications but addressing difficulties of primary statistics and other more technical questions. At the end he concludes that "something must be done", although the role of the traditional accounts as such he does not question. He would not see a risk of "money lost" by experimental work, in view of the huge amounts endangered anyhow. Altogether, this text may be well recommended as a starting point for all those who are not so familiar with the basic issues of the discipline nor the present state of the arts.

What follows next is a set of texts tackling the subject theoretically, and with a principal concern in favor of full account of the environment in terms of NA categories ("**progressivists**"). **R. HUETING**, one of the pioneers of this discipline, is quoted first. He starts with a lengthy explanation of the need of a change in the traditional accounts, to include the environment and

natural resources. Well aware of NA reservations about possibilities of valuation his key reference point is exactly this: to take the social preference for intact environment as a basis of valuation. To render this operational a societal standard must be found. On that basis the concept of **sustainability** is introduced, now widely accepted as a meaningful and even measurable reference scale. While Hueting only cursorily adds empirical evidence also, **G. MICHAELS et al.** give quite comprehensive account of a special study undertaken for the Chesapeake area (USA). On basis of this reference most of the "reasons why" as well as variants and forms of appropriate presentations involved in valuation are at least briefly addressed. The compilation of a special account of "natural services" is central. Against a theoretical, policy oriented background an illustrative overall picture is given of practice of this kind. However, there is still no fully satisfying answer on questions like: Can all damages be restored? Do costs of restoration and damage really converge? - A broad discussion of variants of adaptation of traditional NA can be found in **A.M. FRIEND**, who argues in favor of "pluralism in NA". The underemployment paradigm godfathering the birth of the NA must be replaced by a multidimensional design of the accounts. At least the physical dimension must be brought into the picture. This, however, will for many be more easily accepted than the proposition to replace "money value" by "user value". - Another study, with more empirical content is given by **M.D. YOUNG**. While in principle in favor of the extended NA systems as proposed by the previous authors he draws a somewhat pessimistic conclusion when considering the overall outcome for a country highly developed like Australia, in view of the small size of the adaptations and the accordingly unlikely political reaction made in such circumstances. Are perhaps attempts first to change political and management attitudes more promising? This, and the parallel compilation of coordinate physical systems, geocoding and the like is advanced to be the perhaps more useful option, by now. - On the lines of sustainability argues **R.U. AYRES** also. Mostly drawing on already existing international reference his recommendation is not so much theoretizing than practical, mainly to take measures to achieve a combined system of physical and economic data. If properly arranged existing data would largely suffice already, which is supported by series of exemplary tabulations.

The conceptual framework of a complete system to accommodate in an SNA-type way the various features of the environment is advanced by **DE BOO et al.** They do this within a greater project of the Netherlands' Central Bureau of Statistics (CBS), viz. to develop a full Social Accounting Matrix (SAM) type framework (on which they are writing another draft Manual also, on behalf of UNSTAT). That way, the present issue becomes embedded in an overall system's context, with consequential universal direct or indirect relations and analytical possibilities, in particular with a view to social implications also. The framework should include monetary as well as physical "modules" on the environment. It is not easy to summarize such comprehensive outline in a few sentences, but the approach is surely an attractive option even for those who would not immediately plan to establish such system in full but just develop certain priority areas possibly fitting in a greater systems context. In this respect, their presentation can be of clear didactical importance also, particularly for those which are not so familiar with SNA matrix accounting. Such use is additionally supported by the provision of a numerical example. -

A next group of authors, still tentatively subsumed under the heading "progressive", addresses particular features which are, or would become, relevant when such systems are to be implemented. **J.M. HARTWICK, J. LEVIN** and **S. EL SERAFY** each deal with the problem of valuing the depletion of environmental stocks, in particular mineral resources, while **T.K. RYMES'** exhibit is broader. **HARTWICK** is purely theoretical whereas the latter are closer to SNA type applications. **HARTWICK's** thoughtful exercise looks for the right formula to quantify adaptive Net National Product (NNP) deductions, and examines various related topics such as mineral discoveries, and exhaustion of various externalities, or transformation of forests into agricultural land and related complications, as "composite" stocks and market failure. Above all (and as usual in growth theory), to find out the "right price" perfect anticipation of the future would be necessary, the technical progress would have to be taken into account. A set of other questions put to further research is identified also. Expanding such kind of thoughts towards a more general basis of sustainability, **RYMES** points out the necessity to add to NNP an account of new finds and technical progress, and to take proper account of property rights and transaction costs in order to avoid distorted estimation of sustainable product. Otherwise (if

this is not possible), he would argue in favor of not to deduct or adjust at all! En passant, an interesting statement can be found on the economic meaning of the difference of the price index of consumer prices (CPI) vs. producer prices (PPI), viz. as a measure of technical progress: the CPI would be the proper means to deflate depreciation. An other interesting point is the increase in value of stocks going to be depleted, thus compensating economically the amounts reduced physically. LEVIN first addresses more technical questions arising in the course of the revision of the SNA and requiring standardized answer, therefore, anyhow. He then picks up the subsequent determination of value of material stocks and extractions, respectively. For this a treatment of material resources as neutral "imports" from the environmental account is suggested which enter the SNA in the economy's capital account, thus bypassing the production account (and, accordingly, GDP/NNP), by either deducting the "imports" from inventories and GDP (intermediate consumption model) or from NDP alone (depreciation model). LEVIN advances both solutions as equally possible. As regards evaluation he argues in favor of market price analogy. One strength of the carefully elaborated paper is, inter alia, a full review of the literature related to such more technical issue.

The proposal suggested by EL SERAFY may seem quite attractive for both economists and statisticians also, thanks to solid methodological advice. Starting from ideas advanced by Hicks and related concepts used by business accounting he argues that depletable resources like "working capital" are to be dealt with as inventories, extraction representing a substitution of the primary state of one asset by an other sort (e.g. financial asset). To maintain the original value of the asset an amount has to be "set aside" that ensures that at the time of complete exhaustion the owner of the asset is not worse off than at the beginning. Thus, yearly provisions of this kind must be deducted from current yields of extraction. They are determined by the overall stock and the extraction rates in physical terms, the yearly monetary yields, and an appropriate discount rate. Obviously most of these methodological preliminaries, at the same time, involve some arbitrariness also. However, from an environmental point of view it is the basically micro-economic view which is likely to be most critical because it does not enfocus the overall "existential" importance of depletion.

Aiming at more specific features two further papers are examples for the analytical possibilities of bringing together basic economic data with various corresponding non-monetary physical information. **PILLET** tries to get into the picture the "non-priced" resource inputs to which above all, solar energy is belonging. Asking for appropriate accounting possibilities some light is thrown on the interchange between nature and economy within the overall eco-system. This is illustrated by a case study for Switzerland. The extra-ordinary dependence of such economy on imported energy is shown in a broader context comprising the natural endowments also. - **R. DELL'MOUR et al.** base on an approach by Leontief-Duchin, which links economic and physical/technical layers in a comprehensive IO-analytical system. However, they recognize that it is often difficult to integrate traditional "emission coefficients", and therefore propose the simultaneous use of more specific measures, like intensities and emission factors shaped in more technical terms. The practical example they use refers to Austrian transportation systems which they examine for consequences of intersystem shifts.

The next group of authors takes a more **skeptical** if not negative position. Naturally in this group empirical evidence is hardly found whereas some of the arguments are directly derived from extreme difficulties if not impossibilities to technically carry out certain calculations, not seldom more or less carelessly suggested in general methodological recommendations. **J. RICHTER** gives a fundamental account of preliminaries and consequences of extensions of the SNA. Due to its already given multipurpose character an open-ended building block type (modular) system embracing new elements would seem more appropriate than imposing rigorous overall new valuation and definition concepts, like adjusted GDP. The model type assumptions necessarily to be made when the given scope of immediate observation of transactors and transactions is left is emphatically pointed out, thus expanding to the environment the often advanced Austrian view of the very task of empirical statistical exercises. While the model type evaluation is not refused a priori, clear consequences for appropriate presentation of information are concluded. - **B. THAGE** also takes a point of view very close to the basics of NA, like the original purpose and notions of welfare. A key point is the frequent confusion of the compilation of GDP with NA as a whole, thus over-emphasizing the former to the costs of the latter. He then considers the claims of the environmentalists to modify the accounts with

particular attention to the proposals on proper treatment of defensive expenditure and the use of environmental resources, and examining each with a view to its present treatment. Altogether he does not see a justification for changing concepts like GDP, and argues in favor of dealing with the specific environmental aspects in satellite accounts rather than in the traditional "core". The main rationale seems to be the imminent loss of the character of an overall closed system so useful for describing the actual mode of the functioning of a market economy.

Some more specific points as indeed faced by the national accountants are picked up by **K. NYBORG**, in connection with practical possibilities of valuing goods not entering markets, which is often requested to adjust GDP. It is not just the fact that information is missing but that in absence of markets no functioning mechanism is there at all to signal anything like a common market value. She concludes that the concurrently existing valuation options answer quite different questions, which has to be taken into account for a standardized environment-corrected national product. Even worse, in certain circumstances some of the valuation proposals would not seem to work at all, in particular the avoidance costs method because often damage can be avoided only if production is stopped completely. NYBORG still sees possibilities of model type approaches, and to produce interesting results complementary to NA but in physical units. - Starting from a review of basics like the purpose of NA or the notion of capital, and the related arising business accounting developments (cf. EL SERAFY'), **U.P. REICH** concentrates on how to treat depletable resources in integrated economic environmental accounts. His conclusion is quite restrained, viz. that the treatment according to present SNA standards is in order, due to the central point that depletion is possible only after prior appreciation in the accounts. In ultimate consequence, this is a plea for the ecological and the economic systems being treated separately rather than integrated.

However, national accountants have to cooperate in the endeavor of establishing systems responsive to environment concerns and more and more examples appear of conceptual and even numerical exercises which attain just this; and which are worked out by national accountants. A number of such elaborations are found in the last group, here characterized as

a "pragmatic" view, to announce their endeavor for solutions which try to satisfy all parties to the extent possible, often by compromise or integration of even contradictory concepts in a greater framework. Their importance may lie also in the fact that evidence is given that evaluation of this kind becomes increasingly popular, and this is true within the borders of official statistics also.

To start with a somewhat theoretical attempt, **J. BLAZEJCZAK/D. EDLER** speculate about the model type framework to calculate avoidance costs of environmental degradation. For this purpose, the existence and identification of interfaces and linkages between the environmental and the economic subsystems are crucial, mainly represented by technologies and protection policies. As a specific kind of information alternative technologies are recognized, for which data on functions or costs and consequences on the environment should be regularly stored and made available. More close to the work of official statistics in general, and NA and economics in particular, **A. FRANZ/N. RAINER** have written on classifications to be used in this context. First their diagnosis is such that systems designed for the present purpose are still almost non-existent although statistical progress is indispensably dependent thereupon. On the basis of an Austrian framework to develop integrated environmental economic accounts (see **FICKL**) they filter out which kind of requirements must be met in general, and which kind of classifications are to be established to be accordingly equipped with the tools necessary. Fortunately, it seems that in the meanwhile such ideas have found more general attention, hopefully looking towards international initiative.

Studies combining theoretical or conceptual discussions and presentations of definite national solutions in terms of figures are assembled in the last group of papers. **A. GIANNONE/M. CARLUCCI** report on an exercise for Italy, inter alia winning by its consequential evaluation of information already inherent in traditional accounts. - Due to a yet somewhat less developed general state of the respective statistical basis **S. FICKL** dwells more on conceptual than on numerical questions. Anyhow, after a presentation of the overall Austrian concept he provides quite comprehensive data of environment related monetary expenditure in this country. - Particularly remarkable, however, seems the report given by **J. LI** on the emerging structure

of such systems in China, basically aiming at an environmental adjusted GNP. He develops the concepts along a series of exemplary tabular presentations. - **A. AAHEIM et al.** as well as **L. KOLTOLA** report on the systems used in their home countries. In both cases they are made up as complementary physical systems closely related to NA but more or less narrowly restricted to issues felt to be worthwhile. In Norway, after hopeful beginning with comprehensive resource accounting in the 80ies, this is now mainly the case with energy and air pollution only; whereas in Finland wood is such core issue. Of course, adjustments of GDP are not a concern in either country. - **M. FISCHER - KOWALSKI et al.** have investigated the possibilities of identification of "cause-related" environmental indicators. Notwithstanding considerable preliminary theoretical and technological questions (to be solved by engineering and eco- and natural sciences rather than by statisticians), their attempt seems interesting, particularly because of their strong orientation on the series usually available in official statistics. As to the indicators themselves they have developed a primary classification into three groups, viz. those informing about the physical dimension of the economy in terms of matter, energy and space. Another group is a bundle of emissions while a third group involves indicators of purposeful interventions into life processes. Their concept is going to assume practical importance now for official work in Austria, too.

**P. BARTELMUS** and **J. VAN TONGEREN**, both members of UNSTAT (Statistical Division of the United Nations) and involved in the preparation of the SEEA-Handbook, give a comprehensive insight into basic preliminaries of this study. **BARTELMUS** first deals with the definition of "sustainable economic growth" (which is mainly resource-oriented) and of "sustainable and environmentally sound economic growth" (which additionally looks at environmental degradation). He then summarizes the various approaches of environmental accounting. In his view the difference between conventional NDP and certain versions of an environmentally adjusted net domestic product (EDP) would gradually vanish, as a result of a policy aiming at the internalization of environmental costs. He clearly states the limits of monetary valuation: in such cases social standards (in physical terms) must be set.

**VAN TONGEREN** mainly deals with the valuation issue. He describes the various versions of the concept of environmentally adjusted net domestic product (EDP) and environmentally ad-



justed net income (ENI) repeatedly using definition equations. Both concepts are shown to be simultaneously necessary because of the possibly substantial differences between "costs caused" and "costs borne". He then deals with related concepts of capital accumulation and their impact on EDP and ENI.

#### 4. Discussion

Not surprisingly, the discussion reflected the whole variety of standpoints and views as announced in the papers already. Discussion profited very much from different working fields and different viewpoints of the participants: Environmentalists, economists, NA experts, whether working in industrialized or in developing countries, for national or for international organizations, brought a variety of thoughts to the floor.

One of the repeatedly recurring themes was the implicit or explicit discussion about the objective of a System of Environmental Accounting. It was largely agreed that it is not the purpose of National Accounts to provide indicators of welfare. But there was a continuous debate throughout the whole Conference whether or not Environmental Accounting could and should generate indicators of sustainability. It was not at all clear whether sustainability is a sensible concept for a monetary system: Sustainability to be defined as **physical** limits to growth, in terms of conditions of survivability. So it was argued that it was a misuse of this term to put it in front of economic concepts such as income or growth. Consequently, this would lead to unuseful expectations of politicians and public opinion. In some way or the other scarcity of environmental reasons should be presented. There was long debate whether this is feasible at all; whether it could be done by shadow prices or by hypothetical protection expenditure only; whether the standards of tolerable emissions had to be set by political decisions or scientific expertise, etc.

Altogether, an "orthodox" view of the objectives and possibilities of Environmental Accounting clashed with more "charismatic" ambitions. In close connection to the discussion on objectives, the question emerged which assumptions and methodologies were tolerable for an Accounting System, and what was its relation to model building. There was support for the opi-

nion that an Environmental Accounting System should only try to describe things which **obviously** happened, thus representing an empirical, descriptive set of information, keeping away from assumptions and forecasting as much as possible. In the opposite, it was argued that depletion and degradation of natural capital is reality, too, and environmental functions are scarce. These facts must be represented in a System of Environmental Accounting, therefore. However, there was at least general agreement on that assumptions and forecasting should be clearly **earmarked**.

There was much debate also about whether **physical** or **monetary** data are more appropriate to describe environmental depletion and degradation. On the one hand, physical data are more appropriate to describe ecological relations adequately in their own terms. On the other hand, only monetary data can portray the change of social values. A further point made on several occasions was that in public debate only monetary data were recognized, but this view was opposed by many participants: Firstly, monetary data on damage costs are ambiguous and not comparable with GDP; therefore, such figures are defeatable and should not be given chance to play a role for political decisions in the long run. Secondly, some non-monetary data are already politically effective (e.g. unemployment rates) and especially in environmental policy physical data are meaningful and important.

One further point of the discussion was about the treatment of **natural capital** (or assets) in National Accounts. It was argued that the treatment of capital was inconsistent. Some types of capital such as human and natural capital were neglected, although these kinds are most important for the development of mankind. This argument got strong support from participants working on problems of developing countries where natural capital is most important and must be considered for investment decisions. The orthodox view was that there are tremendous problems in valuation and that degradation and depletion of natural capital should - if at all - be treated in the balance sheets rather than in the production accounts.

## 5. Conclusion

To resume, one of the main results of the Conference was the consolidation of a common "language of problems and viewpoints", which should be useful for further communication. As a particular outcome the common agreement turned out on the need to introduce in the precincts of NA additional information on environmental questions, and at the same time to provide for sufficient flexibility not to prejudice actual use. Thus the scope of a **common denominator** between the various schools is substantial and even larger than often anticipated: only from a certain point onwards the opinions are not any longer easily reconciled. This overall outcome is, though not revolutionary, of clear importance for the development of future standard systems. It has been accordingly internalized that way by **C. STAHMER** in the recent Draft on the SEEA. This paper suitably concludes, therefore, the series of documents given here, thus opening the view to the most important forthcoming international standard in that field. For obvious reasons, here only an abstract can be given of the whole Draft which really comprehensively treats the whole scope of this subject. Basically, it advances environmental accounting as a satellite system of the SNA, linking the conventional economic accounts with environmental and natural resource accounts. The full version consists of 6 Chapters: the introduction is essentially an overview of present approaches, the way how these are integrated in the SEEA handbook, and how it can be flexibly used without prejudice. The second Chapter uncovers SNA-internal building blocks and reference points useful for environmental accounting. The third Chapter develops the physical part; the fourth Chapter the monetary part of the satellite, both fully corresponding to SNA, however. In the fifth Chapter the possibilities are advanced of extending the SNA's production boundary to get the full picture of relevant activities. The sixth Chapter presents a series of IO based evaluations of such data basis. In the abridged **summary** given at the end of this book, of course, only a flavor of the full version can be given. This is mainly supported by means of tabular presentations following the extending

scope and argument as developed in the Handbook. For any details the Draft Handbook itself must be consulted.<sup>1</sup>

Finally, the editors would like to thank the authors, who cooperated so positively in the final editing procedure; Anne Harrison, who reviewed the text of non-natives for good English and assisted with valuable comments otherwise, too; S.Fickl, who summarized the discussion; and A. Steurer, who helped in organizing the volume editorially.

---

<sup>1</sup> On this occasion it would also have to be mentioned that the Draft Handbook was the subject of a separate 2-days **Workshop** also, which continued the Special Conference (30 and 31 May 1992).

# NATIONAL ACCOUNTING FOR RESOURCE AND ENVIRONMENTAL DEGRADATION: ALTERNATIVE APPROACHES AND CONCEPTS<sup>1</sup>

Henry M. Peskin

Edgevale Associates

## INTRODUCTION

The national economic accounts summarize the flows of services, materials, and products that characterize a nation's economic activity. Generally, and especially in industrialized countries, the flows accounted for are those reflected in monetary transactions.<sup>2</sup> From the earliest days of modern national accounting systems (that is, those systems developed in the first half of the 20th century), economists have emphasized the limitations of using monetary transactions to measure total economic activity, let alone to measure total societal well-being. These limitations can be especially serious in developing countries where nonmarket, household production can constitute the majority of total economic activity.<sup>3</sup> Nevertheless,

---

<sup>1</sup>This paper is a revision of a report originally prepared for the U. S. Congress, Office of Technology Assessment. A longer, more technical version of this paper may be found in Robert Costanza, ed. *Ecological Economics: The Science and Management of Sustainability* New York: Columbia University Press, Chapter 13, 1991.

<sup>2</sup>The major exception is the accounting for the depreciation of capital, where the relevant "transaction" is a bookkeeping entry. In addition, most national accounts cover a few "implicit" transactions for which money does not change hands. For example, the accounts usually include an entry for the implicit rent earned by the owners of owner-occupied housing and the implicit cost of own-produced food consumed by farm families. However, specific accounting practises may deviate from the norm, especially in less developed countries because of data limitations and special needs.

<sup>3</sup>Many developing countries include estimates of the imputed value of production

the national accounts—and especially certain sub-totals drawn from these accounts such as the Gross National Product—have gained popular status a key measure, if not the key measure, of a nation's economic and social performance.

Prominent among the critics who have expressed unhappiness with the status given to the national accounts as a barometer of societal performance, are members of the environmental community. In the 1960s environmentalists were especially concerned that the accounts failed to reflect pollution and general environmental deterioration. Perhaps because of this apparent neglect of environmental concerns, the environmental community looked upon the economics profession as more enemy than ally. There are, however, certain economists, especially those with experience in developing countries, who realize that while some environmental and economic goals may be in conflict, many other goals are complementary. These economists share the concerns about conventional economic accounting because the neglect of environmental activity means that the accounts are unable to shed any light on potential economic-environmental interactions, many of which are especially important in the developing world.<sup>4</sup> Moreover, since the conventional national economic accounts also ignore deterioration of the nation's environmental and economic resource base, they paint a falsely optimistic picture of a developing nation's prospects for sustainable economic growth.<sup>5</sup>

Because some environmental issues are attaining world-wide prominence, as evidenced by the concern about global warming and the transnational damage caused by acid rain, questions about the national accounts raised in the developing world are also being raised increasingly in the more industrialized nations as well.

However, before there can be any major governmental effort to address the deficiencies in the standard national accounts, there needs to be a clear understanding of just how these accounts react to environmental and natural in the "informal" subsistence sector in their national accounts.

<sup>4</sup>For example, according to a recent USAID study (Barbier, 1987), the costs of soil conservation efforts in Java (Indonesia) may be more than offset by gains in agriculture and fish production since soil sediment is a serious threat to both crop productivity and to spawning grounds. Similarly, improvements in the quality of water supply in many developing countries could lead to reductions in morbidity-type diseases (such as schistosomiasis) and, thus, could lead to an increase in worker productivity.

<sup>5</sup>See, in particular, Repetto, et al. (1989).

resource change; how the accounts might be altered to reflect these changes more adequately; and what are the practical implementation problems of effecting any such alterations. It is the purpose of this paper to address these three issues.

## DEFICIENCIES IN THE CONVENTIONAL NATIONAL ACCOUNTS

Critics have pointed to three deficiencies in the standard national economic accounts resulting from their inadequate treatment of the environment and natural resources: the conventional accounts provide a poor measure of social and economic performance, the conventional accounts treat different forms of national economic wealth inconsistently, and the conventional accounts ignore important variables explaining economic activity. These three deficiencies will be discussed in turn.

### *1. Inadequacies as a measure of environmental performance*

One of the most frequently heard criticisms of the conventional national accounts is that they respond poorly (some would say “perversely”) to changes in environmental and resource conditions. Certainly, it is true that pollution, congestion of parks and wilderness areas, and the depletion of natural resources are often unfortunate side effects of economic growth. Given such adverse conditions, it is disturbing to much of the public that economic data drawn from the national accounts point in a positive direction. To make matters worse, often the conventional economic indicators poorly reflect efforts to defend against environmental insult and efforts to clean up the environment. For example, it is quite possible that any increased expenditures on medical services or for household cleaning due to increased pollution levels could account for an increase in economic activity and, thus, an increase in the GNP. In addition, efforts to clean up the environment could lead to a decrease in GNP (measured in constant prices) to the extent that these efforts divert resources from the production of ordinary output.

Of course, it could be argued that over the long-term, a clean working environment and a sufficient stock of natural resources are necessary for healthy and sustained economic growth. Thus, the potential “perversities” suggested above may only exist in the short-term. However, because of the fixation on the GNP as *the* indicator of current social and economic well-being (against the wishes of most economists), the argument that if environmental conditions become bad enough, GNP indeed will

*eventually* go “in the right direction,” will not satisfy the critics.

## 2. *Inconsistent treatment of income and wealth*

As suggested earlier, the above criticisms of the national accounts as indicators of well-being may be readily dismissed by those who feel that the accounts were never intended to be an indicator of social and economic well-being. If the press and the public persist in believing otherwise, the problem is with public attitudes and their lack of understanding, but not with how the conventional accounts treat the environment. Thus, rather than altering the accounts to better reflect the environment, it could be argued that it would be better to educate the public in order to increase their appreciation of the limitations of the GNP as a welfare measure.<sup>6</sup> However, the criticism that the standard accounts are not consistent is not so easily dismissed.

The inconsistency has to do with how we define “income.” The national accounts provide the basic data that permit the calculation of a nation’s income. However, according to how income is conventionally defined, the income measure provided by the standard accounts is incomplete because of their neglect of environmental and natural resource degradation.

Conventionally, income is defined as the sum of consumption expenditures plus investment. However, the conventional definition further distinguishes between gross investment and investment less depreciation, or net investment. Accordingly, we distinguish between gross income and net income, where the latter is defined as consumption plus net investment.

Many, if not most economists feel that net income is the more relevant indicator of the economic well-being of society since it better represents the amount society can consume *after* allowing for the production of resources necessary to maintain society’s stock of capital.<sup>7</sup> Gross income, in contrast, may not be *sustainable* to

<sup>6</sup>This, indeed, may be a viable strategy. However, national accounting has to do with more than the development of aggregate income measures such as the GNP. See section 3. next page.

<sup>7</sup>This concept of income has been well-defended by Prof. Hicks. See Hicks (1946). However, net income is hardly a perfect indicator of a nation’s well-being. For example, two countries can have the same net income but where one country



the extent that its level is supported by a diminishing capital stock. Consequently, one of the most important entries in the standard economic accounts is “depreciation,” which allows the translation of gross income (or product) to net income (or product).

The inconsistency arises because the conventional national accounts measure the depreciation of certain forms of capital, such as plant and machinery, but neglect to account for the depreciation of other forms of capital such as natural resources and environmental capital, as represented by the nation’s stock of clean air, water, wilderness areas, etc. As both environmental and natural resource capital are crucial to the production of goods and services—especially in heavily resource-dependent developing countries—neglecting this sort of depreciation necessarily means that net or sustainable income is overstated.<sup>8</sup>

### *3. Neglect of important determinants of economic activity*

One important function of a system of national accounts is that it serves as an information system containing those statistics that determine and define the nation’s economic activity. This information role of the national accounts reflects the “management” function of accounting as opposed to the “scorekeeping” role of providing a measure of economic performance. Even if one were unconcerned about environmental issues *per se* and their effect on GNP (e.g., scorekeeping), one could still fault the conventional accounts if they overlook important determinants of economic activity. The services of natural resources and the environment influence production and consumption activities in much the same way as the services of human capital, plant, and equipment, which are already measured in the accounts.

In its role as an information system, the economic accounts provide a snapshot of the economy’s “production function”: an instantaneous picture of the transformation of factors of production into product and services. Neglecting environmental and natural resources distorts the picture of production in two ways. The oversight

has a high savings or investment rate and the other a high consumption rate. The long-term prospects of the former could be far better than that of the latter.

<sup>8</sup>Other forms of capital depreciation are also neglected in the standard accounts. Of particular importance is the neglect of the depreciation of (as well as investment in) human capital, even though the services of this capital (or “labor”) accounts for most of a nation’s income.

ignores the production of some undesirable outputs (e.g., pollution) and leaves out a number of crucial inputs to the production of both desirable and undesirable product.

This lack of a full accounting of all inputs and outputs complicates the nation's economic and environmental policy process. The availability of key environmental and resource inputs may be crucial in determining whether economic goals will be reached, especially in less-developed, resource-based economies. Thus, misconstruing the economy's production function—that is, neglecting these inputs—could lead to unfortunate and unsuspected policy outcomes.<sup>9</sup>

Yet, even in industrialized, non-resource based economies, while the neglect to account for environmental or natural resource inputs and outputs may not have as dire a result, it may hamper the ability to develop policy directed towards certain resource and environmentally dependent sectors. For example, we are unlikely to gain a full understanding of the response of the agricultural sector to agricultural policies without a complete accounting of *all* the inputs and outputs that are involved in agricultural production. Non-marketed inputs that may be missed in the accounts include such environmental services as the provision of ground water and disposal services for agriculturally-generated pollutants such as residual pesticides, fertilizers, and eroded topsoil as well as such non-environmental inputs as the provision of extension services and the services of unpaid family labor.<sup>10</sup>

## SUGGESTED APPROACHES FOR MODIFYING THE NATIONAL ACCOUNTS

Generally, suggested modifications to standard national accounting practice involve an expansion of the conventional accounts either by direct modification of these accounts or by the construction of separate "satellite" accounts. One of the more ambitious projects along these lines was undertaken in the early 1970s by the National Bureau of Economic Research in their Measurement of Economic and

<sup>9</sup>The neglect of other (non-environmental) non-marketed inputs may be equally or more important in developing countries. Probably the most significant non-market activity in the developing world is the production of goods and services and human capital investments which take place within households.

<sup>10</sup>Typically in the United States, about 88% of the approximately 2.0 per cent per year growth of agricultural output is "unexplained" by the growth of conventionally-measured factor inputs. (The 88% is derived from changes in total factor productivity indexes. See Ball (1985)).

Social Performance (MESP) program.<sup>11</sup> Figure 1 displays the coverage of the conventional U.S. and U.N. (SNA) national accounting frameworks and the proposed MESP extensions into activities that are non-marketed, including environmental activities.

Specific adjustments for deficiencies only with respect to the account's treatment of the environment and of natural resources need not be as ambitious as were the MESP plans. In fact, there is a spectrum of options for environmental accounting. These will be discussed briefly, starting, more or less, from those measures that make modest or little demands on existing national accounting systems to those that would entail major changes in the existing structure.

### *1. Identification of environmental expenditures*

In principle, both expenditures to clean up the environment and expenditures to "defend" against environmental insult are already covered in the conventional accounts, but they may not be identified as such. With regard to pollution control outlays, industrial purchases of pollution control equipment, such as scrubbers and filters, and the labor and materials needed to operate such equipment are usually co-mingled with other expenditures associated with the company's ordinary business activity. Production statistics also are not of much help since much pollution control products and materials are not the exclusive output of a single "pollution-control" industry. The data situation is slightly better with respect to non-military governmental pollution-control activities. Municipal sewage treatment, for example, is usually a separately-defined sector in most national accounting tables.

With respect to the identification of defensive outlays, such as for home air cleaners or for the purchase of protective coats of house paint, the accounts are of little help. While such outlays are covered (usually within the consumption expenditure totals), they are not distinguished from ordinary outlays for goods and services that serve non-defensive purposes. Thus, for example, while some portion of total expenditures for air conditioning is to "defend" against polluted air, another portion is simply for the air conditioner's major purpose of providing cooler air. The accounts provide no information to allow one to determine which portion is which.

---

<sup>11</sup>Many of the research outputs from this program are summarized and reviewed by Eisner (1988).

The mere collection of data identifying defensive outlays and pollution control expenditures would appear to be worthwhile and would not necessitate any modification to the conventional accounts. In the United States, at least, efforts have been made in this direction. For over 15 years the U.S. Bureau of Economic Analysis (BEA) has been publishing pollution-control expenditure data.<sup>12</sup> These data have been used to analyze the macro-economic effects of environmental policy of the U.S. economy.<sup>13</sup> However, since the BEA data do not distinguish between pollution-control outlays necessitated by environmental policy and outlays engendered by other reasons, such as corporate good will or simply tradition, they must be interpreted with care.

## *2. Physical resource and environmental accounting systems*

One of the more practical suggestions for rectifying the deficiencies with the conventional economic accounts is to develop separate or "satellite" accounts that describe the flows of resources, materials (including pollutants), and energy that underlie any economic activity. These accounts display input-output balances that are necessary consequences of physical conservation laws. Typically, the accounts show an initial stock (or "opening balance") of a resource, its diminution through use and degradation, its augmentation through discovery or, in the case of renewable resources, through natural growth, and, finally, the stock at the end of the accounting period (or "closing balance"). Thus, in principle, such accounts show the depletion of natural resources but also their transformation into goods and materials, some of which may find their way back to the environment in the form of pollutants. The material or energy accounts can be linked to the conventional economic accounts through the use of ratios (or input-output coefficients) that express units of energy or material use per unit of production or sales.

On a more or less "official" governmental level, this approach is being tried in France and Norway. However, it appears most fully implemented in Norway, where a number of resource accounting tables have been published.<sup>14</sup>

<sup>12</sup>These are published regularly in the *Survey of Current Business*.

<sup>13</sup>Generally the effects have been small. See Peskin et al. (1981). For a contrary view, see Jorgenson and Wilcoxon (1989).

<sup>14</sup>This is not to imply that the Norwegian and French approaches are the same. Indeed, the French approach is more ambitious in that it attempts to cover a broader range of environmental consequences of economic activity. Further discussion may

Because these physical accounting systems do not attempt to value material and energy flows in monetary terms, they can not directly provide the information to correct the “perverse” social and economic indicators generated by the conventional accounts. Nor can they address the economic inconsistencies discussed above. However, they do provide valuable information relating economic and environmental activity and, thus, go a long way towards filling in the missing items in the economy’s production function.

### *3. Depreciation of marketed natural resources*

Another approach to modifying the standard economic accounts is to focus on their failure to depreciate natural resource and environmental assets. This particular strategy has received recent popular attention through the work of Robert Repetto and his colleagues at the World Resources Institute.<sup>15</sup> Concentrating on the depreciation problem may make sense especially in resource-based developing countries where resource problems may be quantitatively more important than environmental problems. Thus, Repetto’s adjustments have been implemented in Indonesia and further studies are planned or are currently in progress in the Philippines, Costa Rica, and China.

The depreciation calculations have depended on estimates of changes in the physical stock of the natural resource and on the market values of commodities generated by this stock. Thus, the depreciated value of a forest is calculated in terms of the loss of the forest’s ability to generate marketed product such as hardwood. Estimates of the loss of the forest’s ability to generate “nonmarketed” environmental services (e.g., specie protection, specie diversity, esthetic services, CO<sub>2</sub> absorption, etc.) have yet to be made. Nevertheless, even though the estimates thus understate the full value to society of the depreciation of certain resources, the calculations do suggest that conventionally estimated net income may be grossly overestimated in resource-based economies. Repetto, for example, estimates that the Indonesian annual income growth rate over the period 1971-1984 would be reduced by about three percent were the effects of resource depletion accounted for.

---

be found for Norway in Alfsen, et al.(1987), and for France in Theys (1989).

<sup>15</sup>See Repetto (1989).

#### 4. Full environmental and natural resource accounts with valuation

The final approach to modifying the conventional accounts is to develop complete accounting systems that integrate natural resources and the environment into the conventional accounting framework. Examples of these efforts are provided by the UNSO system of Bartelmus, van Tongeren, and Stahmer (1989)<sup>16</sup> and the neo-classical approach of Peskin (1981 and 1989).

While these two systems share several objectives such as the need for close integration with conventional economic accounts while, at the same time, keeping conventional accounting entries visible, they differ in philosophical approach. The SNA system focuses on the *physical* aspects of environmental and natural resource use: the flows of materials, both “goods” and “bads” and the depletion of physical resources. In contrast, the Peskin’s neo-classical system focus on the economic aspects of environmental and natural resource assets: the flows of economic services, both beneficial and harmful, generated by these assets. To the extent that the economic services provided by environmental assets have a one-to-one correspondence with physical flows, the two systems provide similar information. Thus, for example, if a natural resource “depreciates” because of its physical decline, then this decline will be noted in both systems. However, in Peskin’s system, depreciation can occur with no physical change if the value of generated economic services decline. It should be noted that even when the two systems cover the same phenomenon, they may differ in how the phenomenon is valued in monetary terms.

The UNSO system is still under development and, therefore, there are no examples of its full implementation. However, some of the concepts have been applied experimentally in Papua New Guinea and in Mexico.<sup>17</sup> Peskin’s system has been implemented on a pilot basis for the U.S. as a whole and, more recently, for the Chesapeake Bay region of the U.S. In both cases, the modified aggregate account totals, such as the GNP, did not differ by more than 2 percent from the conventional income aggregates. However, the detailed environmental entries and the data used

<sup>16</sup>“UNSO” is being used as a term of convenience. While two of the authors are associated with the United Nations Statistical Office, the system has not been officially endorsed by the United Nations.

<sup>17</sup>The Mexico study has been published by the World Bank. See Van Tongeren et al. (1991).

to develop these entries proved quite valuable as input for a number of policy simulations by the U.S. Environmental Protection Agency and the Department of Agriculture.

## IMPLEMENTATION CONSIDERATIONS

Although the approaches that rely on the development of full accounting systems are clearly more difficult to implement than, say, those that concentrate only on the assembly of pollution abatement expenditures, all of them pose their own specific challenges.

### *1. Difficulties in estimating pollution-control expenditures*

The basic approach used in the United States to estimate pollution-control expenditures is to rely on surveys of firms and industrial establishments.<sup>18</sup> Unfortunately, the respondent is often unable to make a reliable estimate either because internal corporate accounts do not identify pollution-control outlays or because pollution control outlays cannot be separated from other expenditures. The latter problem often arises when the pollution control is brought about by process changes or by plant modernization. Also, it is not clear how "internal" transactions should be handled. A factory may use its own land for pollution control purposes while another might have to purchase the requisite land. Even though the first factory has incurred no expenditure for land, should an imputed value be assigned anyway?

Poor response rates are a source of additional statistical problems including bias: those responding may tend to be the firms experiencing the relatively larger pollution-control expenditures. If so, the resulting estimates may be biased in the upward direction.<sup>19</sup>

Even if the statistical problems are overcome, there will be difficulties in interpreting

<sup>18</sup>Another possible approach is to *infer* expenditures from engineering analyses of what pollution controls should cost. Estimates of this sort have been made by Gianessi at Resources for the Future. See Gianessi and Peskin (1975).

<sup>19</sup>For the U.S. survey, it has been estimated that less than 50 per cent of the questionnaires sent are both returned and usable. See Peskin (1978).

the data. In the first place, pollution abatement expenditures are not the same as pollution abatement costs. Economic costs that are not reflected in expenditures are not counted. Thus, shutting down a plant is a perfectly viable way of abating pollution. The true social costs of so doing may be quite high; the expenditures quite low. In the second place, even if expenditures mirror costs, they may not accurately measure net social costs. To the extent that the data cover intermediate expenditures by business, there may be double (or multiple) counting as these costs are passed through from one sector to another. Because of the double-counting problem, it is meaningless to compare these costs to GNP, although such comparisons are frequently made.

## *2. Difficulties with physical accounting*

There are both practical and conceptual difficulties associated with physical resource accounting. In addition to the obvious problem of having to assemble large amounts of data on the physical use of resources and their transformation into products and waste materials, there is the practical problem of just what to collect and in what detail. Lacking a common monetary unit of measure, it may be difficult to determine what is or is not important. As a result, even though the physical accounts of, for example, Norway are quite detailed, some may justifiably feel that relatively too much detail has been provided on, say, material resources such as forests and too little on industrial pollution.

The lack of a common monetary unit of measure creates conceptual problems as well. With different physical units, aggregation, of course, is impossible. And while one could find a non-monetary unit of measure that would be applicable to a large number of different resources (e.g., weight or volume), it is not obvious which *single* measure will convey the most useful information. Indeed, even ignoring the aggregation problem, it is not obvious which unit of measure is appropriate for any individual natural resource. For example, the reduction in the size of a forest could be measured in terms of the reduction in the number of trees, the number of trees of a particular type of species (e.g., hardwoods), the volume of available timber, or the acreage. It is not clear, however, whether any of these measures would satisfy, say, an ecologist interested in the potential decline of forest habitat or specie diversity.



The obvious response to this problem is to use a variety of units of measure. However, the more different units are used, the more complex the system and the greater are the difficulties in making useful aggregations. Perhaps, with more experience in actually implementing such systems will come a satisfactory compromise.

### *3. Difficulties in estimating natural resource and environmental depreciation*

As with physical resource accounting, depreciating natural and environmental resources presents both conceptual and practical problems. The principal conceptual problem involves an important distinction that must be made between physical deterioration and the loss of economic value. Only the latter, the true economic depreciation, is properly deducted from gross income to produce net income.

While physical deterioration of, say, a natural forest may imply that the forest depreciates in value terms, it need not necessarily be the case. For both economic and biological reasons, the smaller physical forest may show a gain in economic value—that is, it may show negative depreciation or “capital gain.” Such apparent anomalous behavior arises because the value of a resource depends not just on its short-term ability to generate output but also on its ability to generate something of value over its entire life. While, for example, the smaller physical forest may generate less product in the near-term, it might be biologically and economically more productive than a larger, perhaps more crowded forest, over the long-term. Also, it might happen that the demand for the output from a smaller capital stock rapidly increases over time. If so, again its economic value could grow as its physical size diminishes.

The conceptual problem of distinguishing between physical deterioration and true economic depreciation may not create major practical difficulties if the capital stock is traded in well-functioning markets. In this case, observed market values may suitably reflect the long-run, future economic productivity of the asset—or, at least, a market consensus of this long-run productivity. However, most natural resource and environmental assets are not traded in markets, even though certain products generated by these assets (e.g., hardwoods from a rain forest) may have market-determined values. Thus, both the current value of many natural resources and most

environmental resources and the change in this value, or depreciation, must be “imputed” or inferred.<sup>20</sup> While market-observed prices may provide valuable information for these inferential estimates, focusing only on the marketed outputs of an environmental or natural resource asset can lead to substantial underestimates of value and incorrect estimates of depreciation. Put simply, the value of a rain forest is greater than the value of all its salable hardwoods.

The depreciation methods suggested by Repetto are based on the fundamental assumption that the rate of return to the “owners” of a natural resource turns out to just equal the market rate of interest. Under this assumption, the discount term in the conventional present value formula for asset value disappears and, in addition, depreciation at any time equals the net rental value (sales value minus costs) of the exploitation. This assumption has been the subject of some criticism, the most important being that the depreciation calculation is independent of the lifetime of the asset. Thus, if a forest loses 10 trees, the depreciation calculated is the same regardless of whether the forest initially had 100 trees or 1,000,000 trees. However, there seems to be no fundamental reason why the assumption could not be replaced with one less strong by using a stream of actual and estimated rental values in the present value formula directly. Depreciation could then be estimated by computing present values over time.

Perhaps more troublesome are situations where observation of net rental values becomes extremely difficult and even conceptually impossible. For example, while selling price is often a matter of record, costs of production are not. These may have to be inferred or modeled. In addition, the selling price may include monopoly profits. In principle, these should be excluded from the rental estimate. Otherwise, the asset value and its depreciation may be overly influenced by market imperfections. Finally, if there is open access to the resource, such as is frequently the case with fishing grounds, rents may be dissipated. Yet it would be misleading to conclude that the asset has no social value (even though, technically, its private value to the users is zero).

---

<sup>20</sup>There are a number of inferential techniques that have been developed in the literature on the cost-benefit analysis of environmental policy. See, for example, Freeman (1979).

#### *4. Difficulties in estimating full environmental and natural resource accounts with valuation*

As suggested above, the most challenging modification to the conventional national accounts would be to include all the elements of physical and cost accounting but also to place monetary values on all the services generated by natural and environmental assets.

Implementation problems with the UNSO approach and the Peskin approach are similar. However, there is one key difference that should be noted. The UNSO approach starts with a physical accounting and then places value on the physical entries. This strategy assumes a one-to-one correspondence between physical change and value change. For example, any monetary valuation of natural resource depletion corresponds to a physical depletion. While this assumption may seem innocuous, it overlooks the fact that physical change and value change may not be one-to-one. It is quite possible for the value of *any* asset to change even if its physical properties stay constant, if, for some reason, the discounted stream of asset returns declines. The asset value of a wilderness area—at least in economic terms—depends on the future tastes for the services of the area as much as it depends on the area's size or quality.

The reliance on a simple physical basis for economic values also affects how the UNSO accounts reflect pollution abatement. The method assumes that explicit abatement activities can be identified and assigned to an abatement sector. However, in the U.S. at least, the one-to-one correspondence between abatement activity and pollution reduction fails. About half of our pollution reduction results form changes in process and changes in product mix. These pollution-reduction strategies could be reflected in the UNSO approach, but only by *ad hoc* adjustments to the accounting structure (e.g., through redefining product and activity categories).

The Peskin approach avoids these problems by foregoing the attempt to build a set of physical accounts that correspond to the value accounts. The system only focuses on the levels and changes in *economic* value due to the consumption and use of environmental and natural resource asset services. The principal problem, of course, is how to place values on these services and on any societal damages that may arise due to the consumption of these services such as pollution from waste disposal services. There are a number of methods for doing this but most rely on the

“consumer-sovereignty” concept: the value of the environmental service is equal to what consumers of the service would be willing to pay for the service. Similarly, the value of any damages to society for, say, pollution, is equal to what members of society would be willing to pay to avoid these damages.

While implementing this valuation principle presents many technical and data problems, the necessary data and the techniques for manipulating these data are continually being refined. Estimation is, in fact, possible.

There is, however, a conceptual problem that has little to do with data and technique: namely, the appropriateness of the consumer-sovereignty principal for determining societal valuations. Many justifiably fear that many services of the environment are too socially important to be determined by willingness-to-pay techniques. In the first place, these techniques favor the rich over the poor, since the empirical evidence is often based on observed expenditures for environmentally-related goods. In addition, there may be services of the environment whose long-term value to society may be under-appreciated by present-day consumers. The long-term ecological value of certain species or the opportunities for future generations to have the option to enjoy the gifts of nature may be two examples. For these sorts of environmental and natural resource services, it may be necessary to find alternative valuation principles.<sup>21</sup>

## ATTITUDES TOWARDS “ACCOUNTING” REFLECTED IN THE ALTERNATIVE APPROACHES

While the above approaches all have their origins in a shared dissatisfaction with the conventional accounts, they reflect different views on the concept and purposes of accounting.

If one views the practice of accounting as it applies to business operations, it is apparent that it serves two distinct purposes. One purpose—the one most apparent to those viewing the business from the outside—is the production of various balance sheets and financial statements. These documents are intended to provide unambiguous measures of performance: profits, income, net worth, etc.—what is

<sup>21</sup>If, as some claim, the under-appreciation is due to ignorance about the future ecological consequences of present-day actions, it may not be possible to find *any* valuation principles that are agreeable to all members of society.

referred to above as “scorekeeping.”

If, however, the accountant’s job were to be complete upon presenting the firm with these summary documents, the business will be ill-served. For the firm relies on the *process of accounting* just as much as it relies on the accounts themselves. This process generates a stream of cost, production and sales data that permit continual adjustment of business decisions and business policies. As noted above, this process epitomizes the “management” function of accounting.

Conventional national economic accounting serves a similar dual scorekeeping and management purpose. Like the income statements of a business, the accounts do serve to provide a measure of performance. At the same time, however, the accounting process—the continual assembly of a consistent body of economic data—provides a body of information that supports the continual formulation of and assessment of economic policy.

Accounting for the depletion of natural resources illustrates an emphasis on the first role of accounting. The work of Repetto and his colleagues was largely engendered by a belief that the conventional GDP measure greatly overstates sustainable income, especially in developing countries. Physical accounting, especially as practiced in Norway illustrates emphasis on the second, information-generation role of accounting. Indeed, without a monetary valuation, physical accounts cannot be used for adjusting the conventional measure of aggregate economic performance.

The approaches that rely on the development of full accounting systems, such as the UNSO approach or the Peskin neo-classical approach, could equally serve both functions. This fact should be kept in mind when assessing the value of these ambitious efforts. Even if time or data resources make it impossible to “complete” the final set of modified accounts, the efforts could still be justified in terms of the information generated for the development of rational environmental-economic policies.

## FUTURE DIRECTIONS FOR RESOURCE AND ENVIRONMENTAL ACCOUNTING

It should be clear from this overview that while there are severe deficiencies in the standard national accounting systems as to their treatment of natural resources and

the environment, overcoming these difficulties will not be easy. Each of the suggested approaches discussed above has its own deficiencies.

However, the current lack of perfect solutions should not be used as an argument for preserving the status quo. Even partial implementation of any of the above approaches generates information useful both for the development and assessment of policy. Moreover, none of the above approaches “destroys” the current national accounting system. Thus, even if the implementation efforts are only partially successful, we would be better off with the efforts than without them. This is apparently the attitude in Europe where certain countries have already initiated programs in the development of resource and environmental accounts, some of which are far more ambitious than the pollution-expenditure accounting in United States.

There is only the question of whether the benefits of a program and resource and environmental accounting are worth its costs. There is no self-evident answer to this question and it does deserve scrutiny. However, when considering whether the proposed data accounting development efforts are worth their costs, one should keep in mind the modest size of current data development efforts in most countries, especially as compared to other governmental activities. As experience has often shown and as economic theory argues, modest expansions to the smaller programs often lead to the bigger payoffs.

Therefore, it does not appear overly risky for industrialized countries to establish some modest resource and environmental accounting programs.<sup>22</sup> The chances that program benefits will exceed program costs appear good. The case for such programs in the developing world may even be stronger due to the importance of natural and environmental resources to their economies.

## REFERENCES

Alfsen, Knut H., Torstein Bye, and Lorents Lorentsen. 1987. *Natural Resource*

<sup>22</sup>In the United States a good start in this direction could be for the Bureau of Economic Analysis in the Department of Commerce to reestablish their non-market measurement program, abandoned in the mid-1980s.

*Accounting and Analysis: The Norwegian Experience 1987-1986.* Oslo, Norway: Central Bureau of Statistics of Norway.

Ball, V. Eldon . 1983. "Output, Input, and Productivity Measurement in U.S. Agriculture, 1948-79," *American Journal of Agricultural Economics*. Vol. 67, No. 3 (August) pp. 475-485.

Barbier, Edward B. 1987. "Natural Resources Policy and Economic Framework," Annex 1 from *Natural Resources and Environmental Management Review: Indonesia*. Draft Report, USAID, Jakarta, Indonesia (July, 15).

Bartelmus, Peter, Carsten Stahmer, and Jan van Tongeren. 1989. *SNA Framework for Integrated Environmental and Economic Accounting* paper presented to the 21st Conference of the International Association for Research in Income and Wealth, Lahnstein, Germany (August, 21).

El Serafy, Salah. 1989. "The Proper Calculation of Income from Depletable Natural Resources," in Yusuf J. Ahmad, Salah El Serafy, and Ernst Lutz, eds. *Environmental Accounting for Sustainable Development* Washington, D.C.: The World Bank.

Eisner, Robert. 1988. "Extended Accounts for National Income and Product," *Journal of Economic Literature* Vol XXVI, No. 4 (December), pp. 1611-1684.

Freeman, A. Myrick III. 1979. *The Benefits of Environmental Improvement: Theory and Practice*, Baltimore: John Hopkins Press for Resources for the Future.

Friend, Anthony. 1986. *Federal Government Data Bases Relevant for Environmental Risk Management*, Ottawa: Statistics Canada, Structural Analysis Division (February).

Gianessi, Leonard P. and Henry M. Peskin. 1975. *The Cost to Industries of Meeting the 1977 Provisions of the Water Pollution Control Amendments of 1972*, Report prepared for the U. S. Environmental Protection Agency, Washington: National Bureau of Economic Research (December).

- Hicks, J. R. 1946. *Value and Capital*. 2nd ed. Oxford: Oxford University Press.
- Hueting, Roefie. 1980. *New Scarcity and Economic Growth*. Amsterdam: North-Holland Publishing Company.
- Jorgenson, Dale W. and Peter J. Wilcoxon. 1989. "Environmental Regulation and U.S. Economic Growth," paper presented for discussion at the M.I.T. Workshop in Energy and Environmental Modeling and Policy Analysis, Cambridge, Mass. (July 31-August 1).
- Peskin, Henry M. 1978. *The Collection of Pollution Control Expenditure Data*, Discussion Paper D-44, Washington: Resources for the Future.
- Peskin, Henry M. 1989. "A Proposed Environmental Accounts Framework," in Yusuf J. Ahmad, Salah El Serafy, and Ernst Lutz, eds. *Environmental Accounting for Sustainable Development* Washington, D.C.: The World Bank.
- Peskin, Henry M., Paul R. Portney, and Allen V. Kneese. eds. 1981. *Environmental Regulation and the U.S. Economy* Baltimore: Johns Hopkins University Press for Resources for the Future.
- Repetto, Robert, William Magrath, Michael Wells, Christine Beer, and Fabrizio Rossini. 1989. *Wasting Assets: Natural Resources in the National Income Accounts* Washington, D.C.: World Resources Institute.
- Theys, J. 1989. "Environmental Accounting in Development Policy: The French Experience" in Yusuf J. Ahmad, Salah El Serafy, and Ernst Lutz, eds. *Environmental Accounting for Sustainable Development* Washington, D.C.: The World Bank
- Van Tongeren, Jan, Maria Gomez Luna, Ernst Lutz, Francisco Guillen Martin, and Stefan Schweinfest. 1991. *Integrated Environmental and Economic Accounting: A Case Study for Mexico*, Environment Department Working Paper No. 50, Washington, D.C.: The World Bank (December).



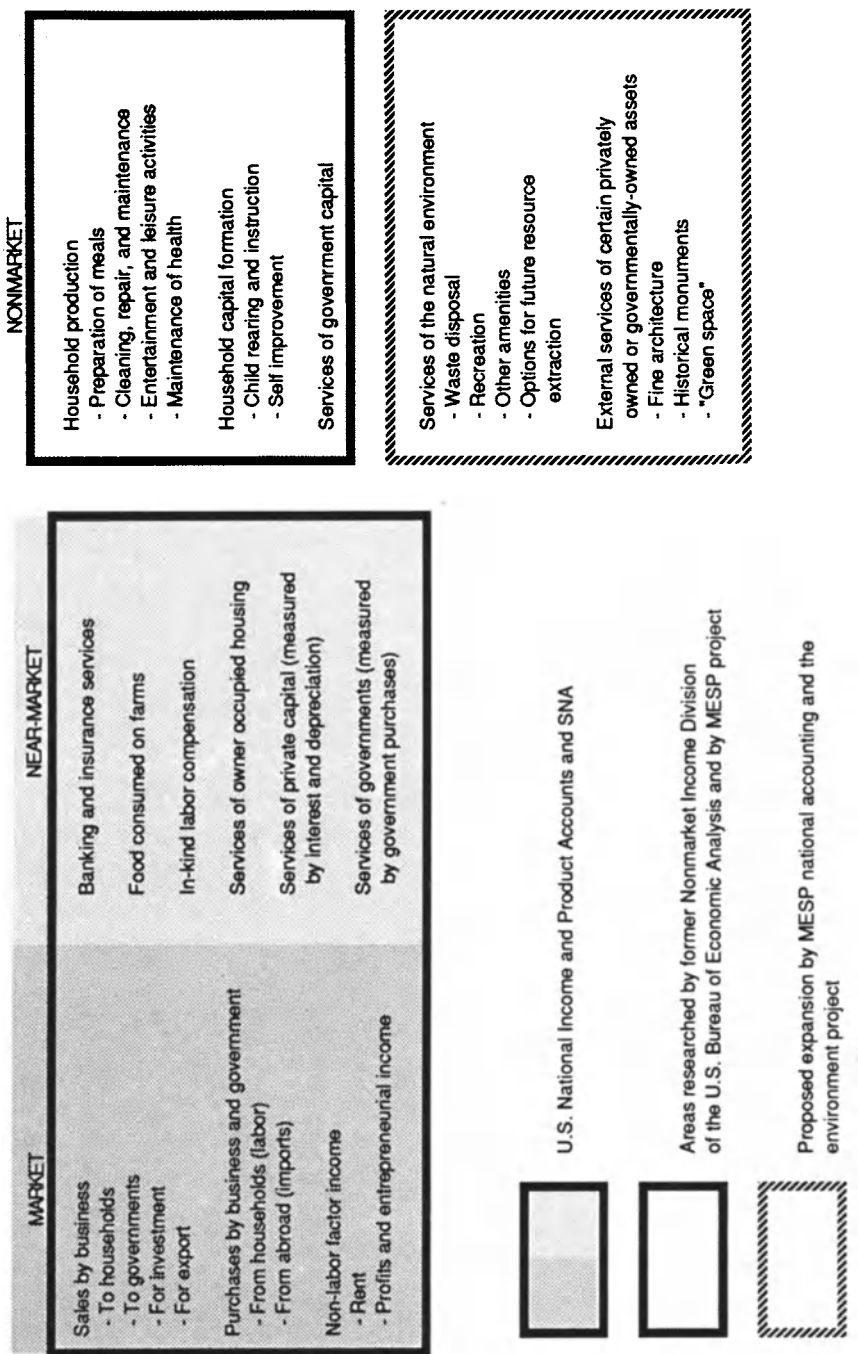

FIGURE 1: ECONOMIC ACTIVITIES COVERED BY NATIONAL ACCOUNTING FRAMEWORKS

CALCULATING A SUSTAINABLE NATIONAL INCOME:  
A PRACTICAL SOLUTION FOR A THEORETICAL DILEMMA

Roefie Hueting

Netherlands Central Bureau of Statistics

1. The Interaction between Environment and Production: the Urgency of Correction

In economic policy, the news media and, alas, also in some economic literature, the increase in *production* as measured in national income (or Gross National Product, GNP) is called economic growth, identified with increase in welfare and conceived as *the* indicator for economic success. Defining production growth as economic growth means defining economics as production. Such a definition excludes, among other things, the scarce environment from economics. Economic growth, defined in this manner, obtains the highest priority in the economic policy in all countries of the world. At the same time, across the world we see growth of national income in accordance with the present pattern being accompanied by the destruction of the most fundamental scarce, and consequently economic good at man's disposal, viz. the environment.

From this simple observation three conclusions can be drawn:

1. society is sailing by a wrong compass, at the expense of the environment;
2. the error is covered up by a wrong use of terms;
3. the belief in ever continuing exponential growth in production, as measured in national income, is the heart of the environmental problem.

The current terminology regarding growth and welfare is an expression of the strong belief that things go well, economically speaking, solely

when the production, as measured in GNP, increases. The notion that production should be increased in order to create scope for financing the conservation of the environment reflects this belief. This notion is widespread and highly popular in official economic and environmental policy. The proposition is disputable, because environmental deterioration is to a large extent precisely a *consequence* of production growth. The production growth attained in the North is largely the result of increases in productivity, in which the loss of scarce environmental goods has not been taken into account<sup>1)</sup>. Few people seem to be aware of the following. One quarter to one third of the activities making up national income (notably state consumption) do not contribute to its growth, because by definition no increase in productivity can result from them. Other activities result only in slight improvements in productivity. The 3% annual growth (a doubling of production in 23 years) desired by official policy, and also advocated in the Brundtland report (The WCED, 1987), must therefore be achieved by much higher growth among the remaining activities. Unfortunately, these are mainly the activities which, by their use of space, soil and resources or by the pollution they generate, in production or consumption, most harm the environment; notably the oil and petrochemical industries, agriculture, public utilities, road building and mining (Huetting, 1981).

A shift in human activities to reduce the burden on environment and resources can be achieved in two ways. First by dictating environment-saving measures for production and consumption and secondly by directly changing the production and consumption patterns.

The first method, e.g. applying end-of-line provisions or changing processes, mostly results in higher real prices of the products and thus in a decrease in the growth of national income<sup>2)</sup>. Of course, the price increases resulting from the environment-saving measures cause a shift towards more environment-friendly activities.

Technical measures often do not really solve the problem, because the growth of the activity overrides the effect of the measure, or because, owing to the persistent and cumulative character of the burden, the measure only slows down the rate of deterioration. In these cases, in addition to the technical measures, a direct shift in behaviour patterns

must ensue, forced by do's and don'ts and levies. Thus it is estimated that to stop its contribution to the acidification of forests and lakes, apart from applying all available technical means, the Netherlands must reduce the number of car miles and its farm livestock by 50%. A direct shift in production and consumption patterns (the second method) will usually also check the growth of GNP, as follows from the above mentioned analysis of the National Accounts (the environmentally most burdensome activities contribute most to GNP growth). Bicycling contributes less to GNP growth than the use of private cars. Saving energy and materials checks growth insofar as it either anticipates the rise in prices or it pays as a result of price increases. However, such a shift would increase our welfare (satisfaction of wants evoked by dealing with scarce means) and economic growth in the true sense (viz. increase in welfare) if we value (at the margin) the environment higher than production. Unfortunately there is no method to state whether or not this is the case, as we shall see in Section 2.

Two conclusions can be drawn from the above. First, it is unlikely that stimulating GNP increase in industrialized countries will solve the problems of the developing countries. For, such increase will most likely be possible only by accelerating encroachment on the limited energy stocks and the limited carrying capacity of the environment, which would be at the expense of developing countries. Secondly, growth of GNP and safeguarding the environment and resources are two conflicting ends. Sustainable use of our planet's resources requires a shift in priority from increasing GNP to saving the environment. This certainly does not mean "Stop production growth", but rather a shift in production and consumer activities in an environmentally acceptable direction in order to arrive at sustainable economic development, and then to wait and see what the increase in production would be. Those who advocate both ends are apparently either blind to present-day reality or are speculating on as yet uninvented technologies while putting at risk the basis of our existence. Such advice will likely do more harm than good to the environment, because it strengthens the forces behind the increase of national income, which are already much stronger than those defending the environment.

The recommended shift in priority in economic policy would avoid both risks and future financial losses. For, restoration after the event is usually much, often very much, more expensive than prevention, while a number of environmental losses are irreversible or may lead to overshoot. This shift would also stimulate the search for and application of environment-friendly technologies much more strongly than current policy.

## 2. The Unsolvable Problem of Shadow Prices for Environmental Functions

It follows from the above that the environment constantly risks falling victim to the misconceptions of economic growth and welfare, and the resulting one-sided stress of economic policy on the increase of production as measured in national income. Therefore, an adjustment of national income for environmental losses seems highly recommendable, provided that it is made clear in the presentation of the results that the figures found too do not constitute a complete indicator for society's welfare in the course of time (see Section 3). In view of the severe criticism and the pressure for carrying into effect such an adjustment, that has been going on now for decades, one might be surprised why up to now this work has not been completed, or even started. The main reason for this is that it is impossible to find a theoretically sound solution for one of the two problems involved in such correction.

First of all "*the environment*" has to be defined in a manageable way and the link between environment and economics must be made. This problem can be solved with the aid of the concept of environmental functions<sup>3)</sup>. Very briefly, the reasoning is as follows.

For an economic approach the environment can best be interpreted as the physical surroundings of man, on which he is completely dependent in all his activities. Within the environment a number of possible uses can be distinguished. These are called environmental functions or, for short, functions. When the use of an environmental function by an activity is at the expense of the use of another (or the same) function by another activity, or threatens to be so in the future, loss of function occurs. We

call this competition between functions, and make a distinction between qualitative, spatial and quantitative competition.

When competition of functions occurs, the environment acquires an economic aspect. Economics boils down to the problem of choice with regard to the use of scarce alternatively applicable means for the satisfaction of classifiable wants (the subject matter). A good is scarce if the demand for it exceeds its availability, or, which amounts to the same, when something else we would like to have (an alternative) has to be sacrificed to acquire it. Environmental functions meet this definition fully as soon as they compete. Competing functions are scarce goods. Losses of function form costs, irrespective of whether or not they are expressed in monetary terms; the terms 'money' and 'market' do not occur in the definition of the subject matter of economics.

Qualitative competition occurs when the use of the environmental function 'dumping ground for waste' (or: 'withdrawal or addition of species and matter') is at the expense of other functions. There is as it were an intermediate step. An activity introduces or withdraws an agent into or from the environment, as a result of which the quality changes: this may disturb other use or render it impossible. By agent is meant a constituent or amount of energy (in whatsoever form) which may cause loss of functions by its addition or by its withdrawal from the environment by man. An agent could be a chemical, plant, animal, heat, noise, radioactivity etc. In the case of spatial and quantitative competition the amount of space or matter is insufficient to meet the existing wants for it. Note that the use of a function also comprises the passive use of the function 'water and soil allowing the existence of natural ecosystems' in order to conserve the actual and potential utilities of ecosystems, now and in the future, and to retain the diversity of species of our planet. Competition between functions can take all sort of forms. But in most cases by far it is a question of the environment being used for current production and consumption activities at the expense of other desired use or (with a certain degree of probability) of future possible uses, including production and consumption. A well-known example of the latter is the loss of top soil resulting from deforestation<sup>3)</sup>.

The second problem pertains to the *construction of shadow prices*. National income is recorded in market terms. For confrontation of environmental losses with this figure it is therefore necessary to construct shadow prices for environmental functions that are directly comparable with market prices. For this a demand and supply curve have to be construed. In the period 1969-1974, the Netherlands Central Bureau of Statistics attempted to do this (CBS, 1972, 1973, 1975; Hueting, 1980), with, very briefly, the following results.

The supply curve can, in principle, always be constructed. It consists of estimates of the costs of measures for various degrees of eliminating the causes of the loss of function, as a result of which the function is partly or wholly restored. The measures will often be a mix of technical provisions, such as add-on technology (treatment plants and the like) and changes in processes, and reducing or halting the burdening activities (which also can be expressed in monetary terms). The supply curve is called elimination cost curve.

Constructing a complete demand curve, however, is mostly not possible. The reason for this is that only in exceptional cases can the intensity of the *individual preferences* for environmental functions be entirely expressed in market behaviour or other behaviour that can be translated into market terms (money)<sup>4</sup>. Loss of function can sometimes partly be compensated by provisions which act as a substitute for the original function and in some other cases cause financial damage. When, for instance, water is polluted by chemicals, compensation of the function 'drinking water' or 'water for agriculture' is possible to a certain degree and during a certain period by purifying the intake of the polluted ground or surface water. In the long run, however, elimination of the pollution is necessary, because of the cumulative effect. An example of financial damage is the damage by floods to crops and properties resulting from loss of the function 'regulator of the water management' of a forest.

Both compensation and financial damage can be interpreted as revealed preferences for a given function. As regards compensation, this will be immediately clear: after all, provisions are made to replace the function originally present. However, amounts of damage can also be conceived as

revealed preferences, since they are losses suffered as a result of the disappearance of the function. As stated above, preferences can seldom be manifested entirely via the market. It is clear that only a very small proportion of the losses of environmental functions are compensated, while in addition they are not always reflected in financial damage. Often, too, the possibility of compensation does not exist. Thus a compensatory measure like moving to a clean area is feasible only for the happy few. Moreover it evokes new traffic streams causing new losses of function. Financial damage through noise nuisance and air pollution is very incompletely reflected in the fall in value of the house, as a result of the tightness of the housing market and the immobilization caused by ties to work and the neighbourhood (Jansen and Opschoor, 1972). The construction of new forests and lakes is pointless as long as the process of acidification is not halted by elimination measures. The loss of soil by erosion cannot be compensated. Most important of all, much of the damage caused by losses of function will occur in the future, such as the damage caused by loss of the stability of the climate, by loss of the functions of tropical forests ('gene reserve', 'regulator of the water management', 'preventor of erosion', 'supplier of wood', 'buffer for CO<sub>2</sub> and heat', 'regulator of the climate' and the like), and by the disruption of ecosystems resulting from the extinction of species. The risks of future damage and the resulting poor prospects for the future cannot manifest themselves via the market of today<sup>5</sup>). Yet there is obviously a great need for unvitiated nature and a safe future.

Because of the limited possibilities for preferences for environmental functions to be manifested in market behaviour, efforts have been made to trace these preferences by asking people how much they would be prepared to pay to wholly or partially restore functions and to conserve them. Quite a lot of research is going on in the field of *willingness to pay* for the environment and *willingness to accept* environmental losses (an overview of the methods used, including quite a few results, can be found in Johansson, 1987; Kneese, 1984; Pearce et al., 1989). It is questionable, however, whether this method is suitable to arrive at the construction of a complete demand curve, certainly on a macro scale and certainly for functions on which current and future life



depends. Insofar as people are directly affected by environmental losses, the approach might be justified. Many environmental losses, however, constitute part of a process which may lead to the disruption of the life-support functions of our planet and endanger the living conditions of generations to come, and therefore cannot be considered separately. In all these cases the approach is pointless. Arguments for this view are listed in Huetting (1989)<sup>6)</sup>. See also Kapp (1972).

From the above it follows that the construction of shadow prices that are directly comparable with market prices, a prerequisite for a theoretically sound correction of national income, is mostly not possible.

### 3. What can be done immediately

In Section 4 a practical and defensible proposal will be put forward to overcome the problem of the impossibility of constructing shadow prices for environmental functions, comparable with market prices. However, elaboration of the method proposed will probably take at least three years for a country with a relatively well-developed system of environmental statistics like the Netherlands. For some other countries it might take longer. In expectation of the results one thing can be done immediately, viz. making clear in the publications of the National Accounts what changes in the level of national income do *not* mean, in order to prevent these changes giving wrong signals to society about the economic success of its activities. In addition to this, the costs of compensating, restoring and preventing environmental losses that are wrongly entered as final delivery (see below) can be made visible with relatively little effort.

### 3.1. *How to avoid misinterpretation of the national income figures.*

In order to prevent the wrong use of the figures that indicate the changes in the level of national income, the following information could be given about their limited significance for welfare and economic success, without, of course, denying their importance.

Economics boils down to the problem of choice with regard to the use of scarce means that can satisfy human wants. Welfare is defined as the satisfaction of wants evoked by dealing with scarce means. So welfare, or satisfaction of wants, is a psychical category, an aspect of one's personal experience. Economic theory assumes that when dealing with scarce means we try to maximize our welfare. Besides maximization of welfare with given means, the desire to raise the level of satisfaction of wants (welfare) in the course of time is also regarded as a motive of economic action.

It follows from this brief description of the subject matter of economics that economic growth and economic success can mean nothing other than increase in the level of welfare. Our economic actions have scored success when our satisfaction of wants has increased. Since satisfaction of wants is not directly observable "from the outside" and thus not in itself a cardinal measurable quantity, it seems logical to look at factors that are measurable in figures and that can arguably be supposed to determine the level of welfare. There are a number of objections to using the production of goods and services, as measured in national income, as the indicator for welfare, economic success and economic growth in this procedure.

These objections could be classed in three categories, which will be summarized very briefly.

The first category is of a theoretical nature. It encompasses five points.

1. The consumer surplus which relates to the difference between the total utility of a good and the product of price (as the criterion of marginal utility) and quantity is not expressed in the height of national income.

2. In national income the value added by production is calculated at market prices. This means that the (marginal) utility of goods of different subjects is added. This is already unallowable with equal income distribution because it is impossible to compare utilities between individuals: some people attach greater value to goods than others. With the existing inequality of incomes this is not allowed *a fortiori* on account of the diminishing marginal utility of money as income grows. The impossibility of comparing utilities between individuals further implies that if part of the population of a country regresses and the rest progresses, no pronouncement can be made on the final result.
3. The law of diminishing marginal utility applies to individuals. However, the same tendency is noticeable for the whole economy, as has been shown by recent research (Van Praag and Spit, 1982). It appears from this research that ever more extra goods are necessary for the attainment of the same increase in welfare as income rises. This relativises the importance for the welfare of an ever growing production.
4. Real national income is obtained by expressing the income in current prices in constant prices with the aid of a composite price index. This can only be done correctly for a constant package of goods. Because of the constantly changing package of goods the calculated value of the price index varies, depending on the solution chosen (Kuznets, 1948; Hicks, 1948; Pigou, 1949). This problem weighs especially heavily over a long period.
5. Not all production takes place in business enterprises or in government agencies. This may not only influence the level of national income but also the changes in it, if, for instance, the work of former housewives is taken over by paid domestic help, crèches, dishwashers and restaurants.

The *second category* of objections to identifying increase in national income with economic growth and economic success relates to the intermediate character of some elements of national income. In the calculation of national income in accordance with the present conventions,

a number of activities which have a cost character and therefore ought to be entered as intermediate deliveries are designated as final consumption. S. Kuznets (1947, 1948), emphasizes this, dividing these activities into three classes.

1. The first class is invoked by the fact that in industrial countries the dominant modes of production impose an urban pattern of living, which brings in its wake numerous services whose major purpose is to offset the disadvantages. Kuznets gives as examples the expenditure necessary for bridging the greater distance between home and work, and the money spent on compensation for the inconveniences entailed in living in dense agglomerations.
2. The second class distinguished by Kuznets relates to expenditure that is inherent in participation in the technically and monetarily complex civilisation of industrial countries. Payments to banks, employment agencies, unions, brokerage houses, etc., including such matters as technical education are not, according to Kuznets, payments for final consumer goods. They are activities necessary to eliminate the frictions of a complicated production system and not net contributions to ultimate consumption.
3. As a third class the major part of government activity is mentioned. The legislative, judicial, administrative, police and military functions of the state, according to Kuznets, are designed in order to create the conditions under which the economy can function. These services do not provide goods to ultimate consumers. It is wrong to count the whole of government activity as a net contribution to national income.

To this a fourth class can be added.

4. The expenditure on measures that compensate or restore the losses of environmental functions (see Section 2) or prevent losses of environmental functions from occurring. These expenditures are entered as intermediate deliveries insofar as the measures are taken and directly paid for by private firms, but as final consumption when the measures are paid for by private households or the government and

also when they are taken by private firms but financed via levies imposed by the government. All these outlays should be entered as intermediate when a long time series such as that for national income is composed. For, the losses of environmental functions are not entered as costs at the moment they originate; at that moment the environment is excluded from the System of National Accounts (SNA). When these losses are eliminated or compensated the environment is - be it partly - included in the SNA. This is generally considered as double counting. A better term is asymmetric booking. This procedure also makes figures of different years incomparable, at least when they are used as a measure for economic growth and welfare.

The *third category* of objections to the identification of increase in national income with economic growth (increase in welfare) relates to the fact that production is only one of the factors that determine the level of welfare. At least seven factors play a role.

1. The package of goods and services produced by man.
2. The scarce environmental goods in the broad sense, i.e. including space, energy, natural resources, plant and animal species.
3. (Leisure) time.
4. Income distribution.
5. Working conditions.
6. Employment.
7. The safety of the future insofar as this depends on our behaviour with regard to scarce goods (such as the life support functions of the environment).

All these seven factors play a part in economic action. They constantly have to be weighed against each other whenever the desired quantity or quality of a given factor is at the expense of one or more other factors. Seen from the point of view of those who choose, whether citizens or politicians, there is thus an unbreakable link between all the factors influencing welfare.

From this it follows that no judgement can be given on the development of welfare in the course of time, among other things because the factors influencing welfare cannot be brought under a common denominator. To give one example, the effect of an increase in production on our welfare depends on the importance we attach to a greater quantity of produced goods on the one hand, and to the resultant loss of environmental functions on the other. Depending on this weighting, an increase in production may lead on balance to economic progress, to a neutral effect or to economic decline (loss of welfare). If we rate (at the margin) the environment higher than the amount of produced goods and the government proceeds to lay down measures relating to production processes and consumption habits leading to a smaller quantity available goods and services, but to improvement in the environment, then the overall satisfaction of wants obtained from economic goods is enhanced as a result. In this case, less production leads to greater welfare.

### *3.2. Correcting national income for double counting.*

A correction for expenditure on compensatory, restoratory and preventive measures would be feasible without theoretical difficulties. This expenditure, which only re-establishes or maintains environmental functions that would remain available without the negative impact of our activities on the environment, is wrongly entered as value added, thus leading to an overestimation of the increase in national income and concealing what is going on in the environment: loss is not written off, restoration is written up. On the one hand, such a correction would be a step forward, as it would partly solve the well-known problem of double counting or asymmetric booking (see above) and provide more information about the relation between production and environment. Thus it appears from a study by Christian Leipert (1989) that between 1970 and 1985 the

defensive outlays in the Federal Republic of Germany increased from 5 percent to nearly 10 percent of GNP, which means that in this period about one fifth of the growth of GNP consisted of an increase in additional costs caused by the same growth <sup>7)</sup>. On the other hand, it would express the environmental losses very incompletely and introduce the pars pro toto problem: part of the information is conceived as the total environmental effect. For, as is well known, most environmental losses are not restored or compensated.

#### 4. A Practical Solution

##### 4.1. *The Basic Idea*

Since the period 1969-1974, in which the Netherlands Bureau of Statistics made an attempt to construct shadow prices for environmental functions with the intention to correct national income, the call for national income to be corrected to include environmental losses has been steadily growing. In the course of a working visit to Indonesia in 1986, the present author was provoked by the following remark made by the Indonesian minister for Population and Environment (Prof.dr. Emil Salim): "In my policy-making I need an indicator in money terms for losses in environment and resources, as a counterweight to the indicator for production, viz. national income. If a theoretically sound indicator is not possible, then think up one that is rather less theoretically sound".

The answer to this is obvious: an estimate based on standards. The setting of standards was also discussed during the above-mentioned period (Huetting, 1980), but the point was not elaborated then because the question "What standards are to be set and by whom?" could not be answered. This situation has now changed. Especially after the publication of the report of The World Commission on Environment and Development "Our Common Future" (The WCED, 1987) (the so-called Brundtland Report) politicians and organizations across the world have declared themselves in favour of a sustainable development. This can be conceived as a preference

voiced by society which opens up the possibility of basing a calculation on standards for a sustainable use of environmental functions, instead of on (unknown) individual preferences.

The present author has proposed (in 1986 and 1989) the following procedure, the feasibility of which is investigated at the Netherlands Central Bureau of Statistics. Define physical standards for environmental functions, based on their sustainable use. Formulate the measures necessary to meet these standards. Finally, estimate the amounts of money involved in putting the measures into practice.

In technical terms this means that in the familiar diagram of the supply and demand curve for environmental functions we have to determine a point on the abscissa which represents the standard for sustainability. A perpendicular on this point intersects the supply curve; *the perpendicular replaces the (unknown) demand curve*. The point of intersection helps to indicate the volume of activities, measured in terms of money, involved in attaining sustainable use of the function.



The above can be summarized in Figure 1.

Fig. 1 Translation of costs in physical units into costs in monetary units.

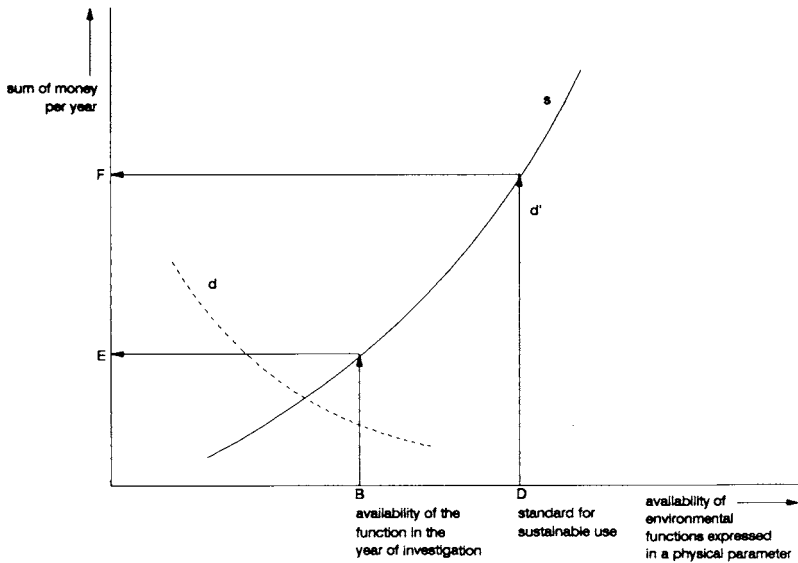

s = supply curve

d = incomplete demand curve based on individual preferences  
(emerging from expenditure for compensation of the function  
etc.)

d' = demand curve based on the sustainability standard.

BD = distance that must be bridged in order to arrive at sustainable  
use of environmental functions.

EF = costs of the loss of function, expressed in money.

*The arrows indicate the way via which the loss of environmental functions recorded in physical units is translated into monetary units.*

As figure 1 shows, the investigation, in addition to establishing the point of sustainability on the abscissa, amounts mainly to *formulating the measures* that are necessary for bridging the distance BD and for *estimating the costs* of those measures. By so doing the size of the loss

as already recorded in physical units in the year of investigation, for instance 1990, is then expressed in monetary units. This corresponds with the *minimal costs* that must be incurred to bridge the *distance* between the *present* situation and *sustainable* use of the environment. Comparison of this amount with the standard national income yields the *sustainable national income*.

The curve is composed of four categories of measures:

1. Costs of technical measures and their introduction.
2. Costs of developing alternatives for depletable natural resources, such as replacement of fossil fuels by forms of energy derived from the sun and of copper wire by glass fibre.
3. Costs of the direct shift from environmentally burdening to environmentally friendly activities when technical measures are not sufficient to reach the point of sustainability. "Shift" has been opted for, because the costs of reduction of the activities alone lead to an overestimation of the environmental loss in monetary units.
4. Costs of reduction of the population and the resultant drop (in reality with a time lag) in volume of the activities when categories 1 to 3 lead to an unacceptably low level of facilities per person.

This arrangement is based on the fact that the environmental burden is determined by the number of people, the amount of activity per person and the nature of the activities.

On the basis of the analysis mentioned in Section 3 (a relatively small part of the activities, that are the environmentally most burdensome, generate the greater part of growth of national income), the following outcome has been derived for the Netherlands (Huetting et al., 1992). Decreasing environment-burdening activities by 1 percentage point has a negative effect on national income of at least 1.8 percent; a shift from environment-burdening to environmentally friendly activities by 1 percent has on balance a negative effect on national income of at least 1.5 percent. This outcome makes it possible to determine quite accurately the point on the supply curve where technical measures will have to be

abandoned in favour of a direct shift (re-allocation) of activities. At this point, per unit of prevented burdening the cost of this shift will be lower than that of technical measures.

The basic assumption of the exercise is that the transition to sustainable activities is made in every country in the world at the same time and in the same way. This assumption has to be made because the greatest environmental problems occur on a worldwide scale. As a result no allowance has to be made for among other things transfer of activities to other countries.

Often what is proposed above is criticised with the comment that no allowance has been made for the development of technology. This criticism is not relevant because the investigation is directed towards the concrete situation in one year in the past. For that year a sum of money is calculated completely statistically with the aid of data on the costs of available technology. The difference between the sustainable income and the standard national income will of course work out smaller when, in a repetition of the investigation, new technologies have meanwhile been developed.

To be absolutely clear, it should be pointed out that this is a partial equilibrium and statistic approach. Effects on other sectors of the economy as a result of taking measures and reducing activities are not considered. Neither are future developments that might be expected involved in the approach. These are not taken into consideration, firstly because the exercise is aimed at a correction of the figure of national income and not at the development of a vision for the future, and secondly because, in the model to be used, a large number of assumptions would have to be incorporated.

The familiar objection to entering restoration measures as final delivery instead of as an intermediate (costs) does not apply to sustainable national income (SNI). The objection is to the fact that the environment remains outside the System of National Accounts when environmental losses occur (loss is not written off), but is included, albeit partially, in the SNA when the loss is restored (restoration is written up). This means in fact that a comparison cannot be made between various years. Hence the continual pressure for correction of double

counting which has been going on for decades now. Because environmental loss at SNI is written off, it is only logical that restoration should be written up. Naturally, an increase in SNI will also occur as clean technology and flow energy become cheaper. For then the deduction becomes less.

#### *4.2 How to determine the standards: the concept of sustainability.*

Standards and the measures based on them may relate to the occupation of space, the use of soil, the availability of stocks of natural resources, the composition of products, the consumption of raw materials and energy, the emission by activities and the concentration of chemical and other agents.

The standards can be related to environmental functions. Thus it is possible to formulate the way in which a forest should be exploited in order to attain a sustainable use of its functions such as 'supplier of wood', 'regulator of the water management', 'object of study for ecological research', 'supplier of natural products for the local population' and 'source of income from tourism'. The estimated expenditure on the measures required to meet those standards then tells us in monetary terms how far a nation has drifted away from its (supposed) end or standard of sustainable use of its forest resources. Likewise it is possible to formulate the way in which surface and groundwater should be exploited in order to arrive at a sustainable use of its functions such as 'waste-dumping site', 'water as raw material for drinking water', 'water for agriculture', 'cooling water', 'water for flushing and transport', 'process water', 'water for recreation', 'water for navigation' and 'water allowing the existence of natural ecosystems'. And the estimated expenditures on the measures required to meet those standards tell us in monetary terms how far a nation has drifted away from a sustainable use of its water resources. The same holds true for the use of air, soil and space.

The measures may range from selective cutting of trees, reforestation, building terraces, draining roads, maintaining buffers in the landscape, selective use of pesticides and fertilizers to building

treatment plants, recirculation of materials, introducing flow energy, altering industrial processes, making more use of public transport and bicycles instead of private cars and making use of space that leaves sufficient room for the survival of plant and animal species.

Of course, no measures can be formulated for irreversible losses. If plant and animal species become extinct, no restoration measures are possible. The same probably holds for the total loss of the top-soil of a mountainous area. An arbitrary value then has to be assigned to these losses, of which only one thing can be said for certain: the value is higher than zero.

With regard to the concept of sustainability points of application can be found in ecological literature. Thus E.P. Odum (1971) states that through human activities a development is increasingly taking place which results in mature, stable ecosystems being replaced by more recent, less stable stages. This is opposite to natural development. As fewer stable stages remain, restoration of impaired systems becomes increasingly difficult and of ever-longer duration, and the number of potential and actual possible uses falls steadily. An irreversible situation can come into being when harm is done on a large scale to predators<sup>8)</sup>, substantial numbers of species are lost or general biological activity is suppressed. This is a disruption of food chains that may lead inter alia to disruption of the life-support functions of our Earth. The process of the decline and disappearance of species can be seen as an indicator of the extent to which we are already on the way to disruption of the life-support functions. The chance of severe disruption can be minimized if human activities, through the use of recycling processes, (again) become part of the biological cycle, whereby the height of the level of activities is limited by the condition that the degree of stability of this cycle does not decrease. A sustainable activity pattern will amount to recycling of natural resources, changing to non-polluting sources of flow energy and a use of land that leaves sufficient room for natural ecosystems to function.

Sustainability is linked to environmental functions, possible uses of the environment, as described and listed in Huetting (1980). Sustainability means that functions must remain intact so that all present

and future uses remain available. As for renewable resources such as forests, water, soil and air, it holds that as long as the regenerative capacity remains intact the functions remain intact, e.g. the function 'supplier of wood' of forests, the function 'drinking water' of water, the function 'soil for raising crops' of soil and the function 'air for physiological functioning' of air. Practically this means that, for instance, emissions of cumulating matters such as PCB's, heavy metals, nitrates and carbondioxide may not exceed the natural buffering capacity of the environment and that the erosion rate may not exceed the regenerative power of the soil.

As for non-renewable resources, such as oil and copper, "regeneration" takes the form of research and bringing into practice flow resources such as energy derived from the sun (wind, tidal, collectors, photo-voltaic cells), the recycling of materials and the development of substitutes for these. This means that in a period as much may be withdrawn from the stock as substitutes for the resource and possibilities of re-use and saving of the resource (improvement of efficiency) have been developed. In this way the available stock of a resource, including the alternatives, remains the same. In a formula:  $e(t) \leq r(t) * S(t)$ , in which  $e(t)$  is the permitted extraction in year  $t$ ,  $r(t)$  the rate of reduction of consumption of the resource at a constant level of activities, and  $S(t)$  the stock in year  $t$  (Tinbergen, 1990). However, if the line, which is based mainly on improvement of efficiency because substitution and re-use are so small that they cannot be observed statistically and thus cannot be entered in the formula, is continued, this would mean that in a number of years we would reach the same level of production with a fraction of the present utilization of resources. For that reason it has been proposed that an additional reservation be made to render possible the development of additional substitutes (Tinbergen and Huetting, 1991).

#### 4.3 A practical example

At the request of the Minister of Population and Environment of Indonesia (see above), the author elaborated the method for the case of erosion, designing a co-ordinated set of tables in which the information

to arrive at the required figures would fit. The reasoning is as follows.

The *standard for erosion*, necessary to arrive at a sustainable economic development is equal to the natural rate of increment of the top soil. This means that the erosion rate in all regions of Indonesia has to be measured (quite a bit of measurement has been done already). For places where the erosion rate exceeds the natural rate of increment, measures to bring the erosion back to the natural rate must be formulated. These measures may differ from place to place. But let us suppose that in a certain region the following *measures* have to be taken to meet the erosion standard and to maintain the standard in the course of time <sup>9)</sup>.

1. Reforestation of the mountain above the agricultural zone or, when farm land has expanded too far uphill, above a certain, not too high, contour line.
2. Building terraces.
3. Setting up a drainage and irrigation system to prevent the origination of gullies.
4. Draining roads and, if necessary, rebuilding them as far as possible along the contour lines of the mountain.
5. Giving information on the necessity of the measures.
6. Installation of officials, chosen from the local population, to check that nobody obstructs the rules necessary to meet the standard.

The expenditure necessary to carry out these measures (and other similar measures) can be estimated.

In the case of erosion the following steps have to be taken to arrive at the figure with which the national income figures over a certain period have to be confronted (which period this should be is not discussed here, because it is not essential to get an idea of the method).

1. *Making a review of the erosion rate (for each province).*

This requires the information in Table 1.

Table 1. Erosion rate by region (per slope class) (in year x)

Erosion rate (times the natural rate of increment)	region (in km <sup>2</sup> )						Total km <sup>2</sup> in the province with a certain erosion rate
	1	2	3	..	..	n	
1 time	a km <sup>2</sup>	b km <sup>2</sup>	c km <sup>2</sup>				
2 - 3 times	etc.						
etc.							
Total km <sup>2</sup> of the region							

2. *Establishing the causes of the erosion (for each province).*

The findings should be collected in Table 2.<sup>10)</sup>

Table 2. Causes of erosion by region (in year x)

Main cause	region (in km <sup>2</sup> )						Total km <sup>2</sup> per cause in the province
	1	2	3	..	..	n	

Examples of the causes of erosion:

1. Agricultural mismanagement, using land not suitable for agriculture, e.g. on too steep slopes.
2. Overcutting of wood, e.g. for cooking.
3. Concessionaires not cutting according to rules etc.
4. Natural disaster.

More than one cause at the same time can lead to erosion in one area. This is not yet elaborated in Table 2.



3. *Formulation of the necessary measures (for each province) to meet the erosion standard.* These measures might differ by local geographic situation and by cause. The findings should be collected in Table 3.

Table 3. Measures to meet the erosion standard, by region (in year x)

Measure	region (in km <sup>2</sup> )						Total km <sup>2</sup> per measure in a province
	1	2	3	..	..	n	

Examples of measures are given above.

4. *Estimate of the costs to meet the erosion standard, including forgoing farm land, if necessary.* The results of the estimates should be collected in Table 4.

Table 4. Costs of the measures by province

Measure	costs per province						Total costs for Indonesia per measure
	1	2	3	..	..	n	

The necessary calculations of the costs of the measures to meet the standards for a sustainable use of environmental functions are not new. As for the Netherlands, the first publications of the Department for Environmental Statistics of the Central Bureau of Statistics resulted in estimates of the costs incurred by measures for various degrees of restoration of function (the supply curve, see above) (CBS, 1972, 1973, 1975; Hueting, 1980). Later the CBS did undertake such calculations for the Netherlands Scientific Council for Government Policy (1978) and for the scenario studies in the context of the Broad Social Discussion on the future energy supply (Hueting, 1987). In the chapter on costs and benefits of environmental measures in a recent report by the National Institute of Public Health and Environmental Hygiene (1988) a number of "supply curves" are included; the institute uses these data for scenario studies. In other

countries similar estimates have been carried into effect, for instance by the Economic Council of Japan (1974). Apart from these and other, more integral, approaches, numerous studies on notably the measures and costs involved in the reduction of emissions of harmful agents have been carried out in quite a number of countries.

The static volume estimates proposed here, based on standards for sustainable use, have the same character. The principal requirement is scientific and technical knowledge.

#### *4.4 Adjustment of national income: drawbacks and advantages.*

On the ground of the experiences mentioned above the present author believes that a correction of national income figures on the basis of standards for a sustainable use of the environment is feasible. The method has certain advantages and drawbacks.

The drawbacks (or imperfections) are as follows.

1. The results of the approach do not represent individual valuations in the true sense, as has been extensively explained above. For, among other things, the intensity of the preferences for a sustainable use of the environment cannot be measured. However, this simultaneously implies that the intensity of the preferences for the acceptance of the adverse effects and future risks involved in the present growth pattern of production and consumption, and thus for the growth of GNP, is equally unknown. Both of these aspects should be clearly mentioned in the presentation of the results of the method in the publications of the National Accounts.
2. The method ignores the loss of welfare suffered by those people who have a strong preference for the conservation of nature apart from its role in the maintenance of the life-support functions of our planet (which is a prerequisite for sustainable development). This preference could be compared with the preferences for creating and maintaining art or churches, which might not be considered indispensable for sustainable development and yields, but the loss of which would

constitute a decrease in welfare for those who need them. Another conspicuous example of the same kind is noise. Noise does not affect sustainability, but it can be very disturbing.

3. The results of the approach do not indicate the state of the environment. If, for instance, a cheaper anti-pollution technology is invented, the distance between national income ( $Y$ ) and the estimated sustainable activity level ( $Y'$ ) becomes smaller. But if the technology is not or not generally applied, the state of the environment changes hardly or not at all. Furthermore a decrease in costs does not necessarily run parallel with changes in physical parameters. Therefore environmental statistics in physical units remain indispensable.
4. For irreversible losses no measures can be formulated, of course. This holds true for any method.
5. The method is laborious.

The advantages are as follows.

1. As far as we can see, the method is the only way to confront the national income figures with the losses of environmental functions in monetary terms.
2. The method compels the definition of an exact content of the term "sustainable economic development". Without such a content the term remains vague and not operational in economic policy regarding the environment.
3. The physical data required for comparison with the standards come down to basic environmental statistics which have to be made anyhow if a government is to get a grip on the state of the environment. The formulation of the measures to meet the standards and the estimates of the expenditure involved are indispensable for policy decisions. Or in other words: the work for supplementing national income figures might be laborious, but it has to be done anyhow if one wants to practise a deliberate policy with respect to the environment.

On the strength of the arguments mentioned above, the present author recommends an adjustment of national income for environmental losses (including resources) on the basis of standards for a sustainable use of environmental functions, in order to arrive at a figure for national income alongside the current one.

NOTES

1. Polluting, degrading and depleting environment and resources is free of charge. Preventing this process, by levies or by regulations, means that, given the existing technology, more labour input is required for the production of a given number of goods. This reduces labour productivity and consequently checks production growth. Saving the environment without checking production growth (corrected for double counting, such as treatment plants), is only possible if a technology is invented that is sufficiently clean, reduces the use of space sufficiently, leaves the soil intact, does not deplete energy and resources (i.e. energy derived from the sun and recycling) and is cheaper (or at least not more expensive) than current technology. This is hardly imaginable for our whole range of current activities.
2. A disturbing factor is that provisions made by *others* than private firms are entered in the System of National Accounts (SNA) as final deliveries instead of as intermediate (costs). This is generally considered as double counting. When the text says: growth is checked, it always means: growth, corrected for double counting. The double counting, however, is marginal to the losses, because by far the greatest part is not repaired. (To be absolutely clear, this and other similar remarks are not meant as a plea for altering current SNA conventions, but for calculating alternative national income figures alongside the current ones, in order to improve the information on changes in the level of available scarce goods).
3. See for a detailed description and elaboration of this approach: Huetting (1980), which is based on Huetting (1970).
4. The possibilities for this are limited. An example is the costs of travel involved in visiting a nature area (see Huetting, 1980).
5. Calculating the net present value (NPV) of future damages, the current extent of which can be established via the market (e.g. damage by flooding resulting from loss of the function 'regulator of the water household'), breaks down on the unsolvable problem of the level of the discount rate in environmental costs and benefits (see Huetting, 1991).
6. To these arguments the following can be added.
  - A number of people will probably have their doubts about the participation of others (the Prisoner's dilemma from game theory) or prefer to wait and see (the Free Rider Principle from the theory of collective goods). Thus in developing countries (where the tropical forests are) the view is wide-spread that people from the rich countries should pay, because these countries a) have much more money to spend, b) nevertheless are destroying their own environment, e.g. what is left of their forests, by acidification, c) contribute considerably to global effects such as the greenhouse effect, d) have a clear interest in saving natural resources in the third world.
  - In cases where the whole community is involved the willingness to accept approach is pointless. For who is then paying whom?

7. The calculations comprise not only expenditure induced by environmental deterioration caused by man, such as restorative and compensatory outlays, but also defensive expenditure in the fields of traffic, housing, security and health.
8. A predator is defined as an animal organism that feeds on other living animal organisms. Predators form the crux of the feedback mechanism that maintains the natural equilibrium.
9. As a result of the measures the area of arable land and the employment in agriculture might decrease. This necessitates for instance investments for local industry or rehabilitation of waste land. Furthermore measures such as making tenancies more secure and other land reform measures may be necessary to maintain a stable situation. This kind of secondary measure is not taken into account because correction of national income allows only for the direct measures that are necessary to meet the standard for a sustainable use of the environmental functions.
10. From this and the following tables only the headings are given, in order to save space. The complete tables can be ordered from the author.

## REFERENCES

- Central Bureau of Statistics, 1972. *Waterverontreiniging met afbreekbaar organisch en eutrofiërend materiaal* (Water pollution by biodegradable organic and eutrophication matter). 's-Gravenhage.
- Central Bureau of Statistics, 1973. *Waterverontreiniging ten gevolge van verzilting, 1950-1970* (Water pollution caused by salinization, 1950-1970). 's-Gravenhage.
- Central Bureau of Statistics, 1975. *Luchtverontreiniging door verbranding van fossiele brandstoffen 1960-1972* (Air pollution resulting from the combustion of fossil fuels 1960-1972). 's-Gravenhage.
- Central Bureau of Statistics, 1975. *Functieverliezen in het milieu* (Losses of function in the environment). Statistische en econometrische onderzoeken no. 18, 's-Gravenhage.
- Economic Council of Japan, 1974. *Measuring Net National Welfare of Japan*. Tokyo.
- Hicks, J.R., 1948. On the Valuation of Social Income. In: *Economica*, August.
- Hueting, R., 1970. Moet de natuur worden gekwantificeerd? (Should Nature Be Quantified?). In: *Economisch-Statistische Berichten*, 21 January 1970.
- Hueting, R., 1980. *New Scarcity and Economic Growth*. Amsterdam, New York, Oxford (First edition 1974).
- Hueting, R., 1981. *Some comments on the report "A Low Energy Strategy for the United Kingdom"*, compiled by Gerald Leach et al. for the International Institute for Environment and Development (IIED). Paper prepared for the Working Party on Integral Energy Scenarios. The Hague, 20 May 1981, 10 pages. Also published under the title: De relatie tussen productiegroei en energieverbruik. Maakt groeifanatisme blind? (The relation between production growth and energy use. Does growth fanaticism blind?). In: *Economisch-Statistische Berichten*, 24 June 1981, pp. 609-611.
- Hueting, R., 1987. An Economic Scenario that Gives Top Priority to Saving the Environment. In: *Ecological Modelling*, 38, pp. 123-140.
- Hueting, R., 1989. Correcting National Income for Environmental Losses: Towards a Practical Solution. In: Y. Ahmad, S. El Serafy, E. Lutz (ed.) *Environmental Accounting for Sustainable Development*. The World Bank, Washington, D.C.
- Hueting, R., 1991. The Use of the Discount Rate in a Cost-Benefit Analysis for Different Uses of a Humid Tropical Forest Area. *Ecological Economics*, 3, 43-57.
- Hueting, R., Bosch, P. and De Boer, B., 1992 *Methodology for the Calculation of Sustainable National Income*, Statistical Essays, M44, Netherlands Central Bureau of Statistics, Voorburg.
- Jansen, H.M.A. and J.B. Opschoor, 1972. *De Invloed van Geluidshinder op de Prijzen van Woningen - Verslag van een Enquête onder Makelaars in en rond de Haarlemmermeer*. (The Influence of Noise-nuisance on the Prices of Houses - Report of a Survey among House-Agents in and around the Haarlemmermeer). Instituut voor Milieuvraagstukken van de Vrije Universiteit. Werknota No. 15. Amsterdam.
- Johansson, P., 1987. *The Economic Theory and Measurement of Environmental Benefits*. Cambridge University Press, Cambridge.

- Kapp, K.W., 1972. Social Costs, Neo-Classical Economics, Environmental Planning: A Reply, in: *Social Science Information*, Vol. 11, nr. 1, pp. 17-28.
- Kneese, A.V., 1984. *Measuring the Benefits of Clean Air and Water*. Resources for the Future, Inc., Washington, D.C.
- Kuznets, S., 1947. National Income and Industrial Structure. In: *The Econometric Society Meeting, September 6-18, 1947, Washington, D.C., Proceedings of the International Statistical Conferences, Volume V*. Calcutta, undated, p. 205.
- Kuznets, S., 1948. On the Valuation of Social Income. In: *Economica*, February/ May.
- Leipert, C., 1989. Social Costs of the Economic Process and National Accounts: The Example of Defensive Expenditures. In: *Journal of Interdisciplinary Economics*, 3(1), p. 27-46.
- National Institute of Public Health and Environmental Hygiene, 1988. *Concern for Tomorrow*. Alphen aan den Rijn.
- Netherlands Scientific Council for Government Policy, 1978. *The Next Twenty Five Years*. The Hague.
- Odum, E.P., 1971. *Fundamentals of Ecology*, 3rd edition. Philadelphia.
- Pearce, D., A. Markandya and E.B. Barbier, 1989. *Blueprint for a Green Economy*. Earthscan Publications Limited, London.
- Pigou, A.C., 1949. *Income*. London; p. 11.
- The World Commission on Environment and Development, 1987. *Our Common Future*. Oxford, New York, 383 pages.
- Van Praag, B.M.S. and Spit, J.S., 1982. *The Social Filter Process and Income Evaluation - an Empirical Study in the Social Reference Mechanism*. Rep. 82.08, Centre for Research in Public Economics, Leyden University, Leiden.
- Tinbergen, J., 1990. Bepalen van omslagtijdstip is van essentieel belang (Determining the cross-over point is of essential importance), *NRC-Handelsblad*, 16 October 1990.
- Tinbergen, J., and R. Huetting, 1991. GNP and market prices: wrong signals for sustainable economic success that mask environmental destruction. In: R. Goodland, H. Daly, S. El Sarafy and B. von Droste (eds), *Environmentally Sustainable Economic Development: Building on Brundtland*. United Nations Educational, Scientific and Cultural Organization, Paris. Also published by The World Bank, Washington, 1991, as World Bank Environment Working Paper No. 46.



NEITHER FISH NOR FOWL? CAN ENVIRONMENTAL ACCOUNTS GUIDE  
ECONOMIC POLICY, ENVIRONMENTAL POLICY, BOTH OR NEITHER?  
CONCLUSIONS FROM A UNITED STATES CASE STUDY<sup>1</sup>

R. Gregory Michaels, Abt Associates Inc.

Anne E. Grambsch, U. S. Environmental Protection Agency

Henry M. Peskin, Edgevale Associates

INTRODUCTION

Neither fish nor fowl. This expression carries with it the connotation that something appears not to fit easily into ordinary classifications. Think of a penguin. It cannot fly and yet it can swim. That would seem to make it a fish but it is not. A flying fish can fly but it is not a bird. How would an animal that could fly and swim be categorized?

This metaphor illustrates that it is the exceptions to ordinary practices which sometimes determine how meaningful conventional wisdom is. In the area of economic policy, conventional wisdom has been called into question by proponents of sustainable development, who advocate greater consideration of the economy's environmental effects. The analytical tools which have been used to guide economic policy, such as national economic accounts, are not adequate for this task. Environmental accounts have been proposed as a solution but these have met with opposition from national economic accountants because they do not mesh well with the standards of the current accounts. From the environmental side, the reception is warmer. Building environmental accounts draws heavily on economic information created expressly for the development of environmental policy. Yet that origin

<sup>1</sup> This research was funded by the U.S. Environmental Protection Agency. The views expressed are the authors own and do not represent the official position of the Agency.

in the environmental policy realm raises the question of whether organizing this information in environmental accounts offers any new insights for environmental policy. Furthermore, economic approaches to environmental issues have frequently been viewed skeptically by the environmental community.

Is there any home for this hybrid creature, the environmental accounts? This paper examines different aspects of environmental accounting, focusing on how they may be adequate and useful for different public policy purposes. The results from a US case study are judged against four criteria. The first is the one likely to be of greatest concern to national income accountants. It considers the question of how appropriate environmental accounting practices are for inclusion in national economic accounts. The second one asks whether environmental accounts would be useful to economic policymaking while the third one asks whether they would be useful to environmental policymaking. The fourth criterion considers the extent to which the accounts would support greater integration of economic and environmental policymaking. The paper closes with a presentation of possible future developments and a conclusion.

### RESULTS OF THE US CASE STUDY

The findings of this paper are based on a pilot project to create environmental accounts for the region surrounding the Chesapeake Bay, one of the largest and most productive estuaries in the United States. In the midst of the heavily populated East Coast, the Bay has been subjected to intensive demands by both industry and outdoor recreationists, making it a useful composite of a wide array of environmental issues. The region chosen for this study is defined by those counties that border the Chesapeake Bay and the estuarine portions of rivers that flow into the Bay. The District of Columbia is also included. This region is treated as if it were an independent nation with the name "Chesapeakea."

There are a number of strategies that have been put forth for introducing the environment and natural resources into the conventional economic accounting systems, generally by providing supplemental tables of information known as satellite accounts. These strategies

have been discussed elsewhere (e.g., in Peskin (1990)). They can be classified into four groups, identified as (1) cost accounting, (2) physical accounting, (3) depreciation accounting, and (4) input-output accounting.

While the approach adopted for the Chesapeake accounts shares certain characteristics with the above approaches, it differs from them in its comprehensiveness and in its close adherence to concepts consistent with modern economic theory. Its intent is to cover both traditional economic interactions as well as environmental-economic interactions as these interactions affect both current economic activity and the value of the stock of environmental and natural resource capital. In this respect, it shares the ambitions of the UNSO input-output approach. However, its valuation principles more closely follow the principles of neo-classical economic theory.

Basically, an accounting structure has been designed that treats these natural assets in a fashion that parallels the treatment of conventional marketed assets in the ordinary accounts. That is, the natural assets are accounted for *as if* their services were in fact marketed and *as if* they depreciated over time. An account for a nature sector is created that parallels the accounts for the household, industrial, and governmental sectors. A consolidated account, which reflects the contributions of all four sectors, is also developed along conventional additive accounting lines. This form permits both easy construction of modified accounting aggregates such as the GNP and easy identification of conventional accounting entries. Thus, the integrity of the conventional accounts is maintained.

### *Nature Sector Accounts*

Nature, as a provider of services to industry and households, is missed in the conventional accounting framework because there is no charge for its services. The basic power of environmental accounting lies in its revealing such economic values of the environment. There are five basic nature sector entries, (1) environmental waste disposal services, (2) environmental damages, (3) final consumption of nonmarketed environmental services, (4) net environmental benefit, and (5) environmental depreciation. Both waste disposal service

and environmental damage values are based on reductions in pollution to target levels. That is, waste disposal service values are estimated as the costs associated with the additional reductions in air and water pollution required to meet the target pollution levels while the environmental damage values are the benefits that would be expected from reaching those target levels. Final consumption of nonmarketed environmental service values are primarily the recreational benefits that flow to households at the current level of environmental quality. Since total services flowing from the nature sector may not equal the damages that flow to the nature sector from other sectors, a balancing entry is required. Net environmental benefit is this balancing entry and is defined as total services (waste disposal services plus final consumption of nonmarketed environmental services) less environmental damages.

A variety of data sources were used for compiling physical measures that reflect concerns about air and water quality. Survey data on participation in various recreational activities was also used extensively. Target reductions for water were based on a 20 percent improvement in ambient conditions over 1982 levels. The required effluent reductions consistent with this improvement assume a closed water body with perfect mixing. Water pollution control costs were determined by multiplying target reductions by dollar per pound cost estimates obtained from the Chesapeake Bay Liaison Office (U.S. EPA, 1988a). Water damages were based on assumed benefits from attaining the target reductions and were calculated from data in a study prepared for EPA (Bockstael et al., 1988).

Air emission target reductions were based on reports prepared for EPA (ICF Resources Incorporated, 1990; E.H. Pechan Associates, 1990) and the EPA Trends Report (U.S. EPA, 1991). Estimates of per ton air pollution control costs were derived from various EPA sources (U.S. EPA 1988b, U.S. EPA 1974, U.S. EPA 1985, and Pechan, 1990 Op. cit.). Air pollution damages are estimates of the benefits of attaining air pollution targets for each pollutant where such targets could be established and were also derived from EPA data (Energy and Resource Consultants, Inc., 1987; U.S. EPA, 1988b Op. cit.; Krupnick, 1988). A further benefit arises from reductions in air borne nutrient loadings to the Bay. As a result, the total damage estimate for water was prorated between air and water based on the percentage of nutrient reductions attributable to these sources.

The remaining entry, environmental depreciation, is defined as the change in the values of environmental and natural resource assets over the accounting period. The current value of an environmental or natural resource asset is defined as the discounted sum of the consumer-valued services generated by the asset over its lifetime. For Chesapeake, future returns were estimated by extrapolating the estimates of net environmental benefit. Combining environmental depreciation with conventional depreciation permits the calculation of a modified net product, equivalent to income after allowance for the replacement of both conventional and environmental capital. Income so defined is sustainable in that the supporting capital stock is preserved.

Table 1 summarizes the environmental activity for Chesapeake. Gross nature sector output is the sum of waste disposal and final demand services provided to other sectors in Chesapeake's economy. Nature sector input is the sum of environmental damages absorbed from other sectors and net environmental benefit. As Table 1 shows, environmental damages exceeded waste disposal services for both air and water. It should be noted that the nature sector only reflects the nonmarket component of the contribution the environment makes to the Chesapeakean economy. Certainly there are market transactions which reflect the services of the Chesapeake Bay, e.g. out-of-pocket expenditures for a fishing trip in the Bay, but these are already included in the traditional GNP measure.

#### *National Income and Product Accounts*

How the nature sector compares with the entire economy can be seen in Table 2, the 1985 modified national income and product accounts for Chesapeake. Elements ordinarily found in conventional accounts are shown in the top part of Table 2. The Chesapeakean economy is a very large one, with a conventional GCP (Gross Chesapeake Product) of \$142 billion. The environmental entries from the nature sector account are shown in the lower part of the table, below NCP (Net Chesapeake Product). Waste disposal services are treated as though they were a subsidy from the nature sector to the other sectors in the economy and

**Table 1. Nature Sector Accounts for Chesapeake - 1985**

(Millions of 1987 dollars)

Input		Output	
Environmental Damages		Final Demand for Nonmarketed Environmental Services	
Air	116.3	Beach Use	253.3
Water	343.3	Boating	140.1
Total	459.6	Recreational Fishing	41.1
		Hiking	184.6
Net Environmental Benefit (Disbenefit)	824.0	Camping	159.5
		Waterfowl, Deer, and Small Game Hunting	129.9
		Wildlife Observation, Photography, and Feeding	193.6
		Total	1,102.1
		Waste Disposal Services	
		Air	92.9
		Water	88.6
		Total	181.5
GROSS NATURE INPUT	1,283.6	GROSS NATURE OUTPUT	1,283.6
Environmental Depreciation (-)	64.8	Environmental Depreciation (-)	64.8
NET NATURE INPUT	1,218.9	NET NATURE OUTPUT	1,218.9

are shown as a negative entry on the input side of the consolidated account. Environmental damages appear on the output side of the account and are also shown as a negative entry, reflecting its status as a "bad". Final consumption of nonmarketed environmental services, primarily by households in the form of recreational activities, also appears on the output side of the consolidated account. Table 3 shows the breakdown of GCP by SIC code.

**Table 2. Modified National Income and Product Accounts  
for Chesapeake - 1985**

(Millions of 1987 dollars)

Input		Output	
Compensation of Employees	94,075.2	Personal Consumption	81,332.3
Proprietor's Income	9,977.7	Investment	17,860.0
Indirect Taxes	9,977.7	Inventory Change	883.7
Gross Return to Capital	28,507.6	Exports	14,382.1
		Imports	(11,317.5)
		Federal Government Goods and Services	22,620.8
		State Government Goods and Services	16,762.5
		Statistical Discrepancy	14.3
<b>GROSS CHESAPEAKA PRODUCT</b>	<b>142,538.2</b>	<b>GROSS CHESAPEAKA PRODUCT</b>	<b>142,538.2</b>
Capital Consumption	(17,194.6)	Capital Consumption	(17,194.6)
<b>NET CHESAPEAKA PRODUCT</b>	<b>125,343.6</b>	<b>NET CHESAPEAKA PRODUCT</b>	<b>125,343.6</b>
Environmental Waste Disposal Service		Environmental Damages	
Air	(92.8)	Air	(116.3)
Water	(88.6)	Water	(343.3)
Total	(181.5)	Total	(459.6)
		Final Consumption of Nonmarketed Environmental Services	
		Beach Use	253.3
		Boating (Chesapeakans only)	140.1
		Recreational Fishing	41.1
		Hiking	184.6
		Camping	159.5
		Waterfowl, Deer, Small Game Hunt	129.9
		Wildlife Observation, Photography, and Feeding	193.6
Net Environmental Benefit (Disbenefit)	824.0	Total	1,102.1
Environmental Depreciation	(64.8)	Environmental Depreciation	(64.8)
<b>CHARGES AGAINST MODIFIED NET CHESAPEAKA PRODUCT</b>	<b>125,921.3</b>	<b>MODIFIED NET CHESAPEAKA PRODUCT</b>	<b>125,921.3</b>
Capital Consumption	17,194.6	Capital Consumption	17,194.6
Environmental Depreciation	64.8	Environmental Depreciation	64.8
<b>CHARGES AGAINST MODIFIED GROSS CHESAPEAKA PRODUCT</b>	<b>143,180.7</b>	<b>MODIFIED GROSS CHESAPEAKA PRODUCT</b>	<b>143,180.7</b>

**Table 3. GCP by SIC Code for Chesapeake - 1985**

(Millions of 1987 dollars)

SIC	NAME	GCP
01-02	Agriculture	773.9
07-08	Agricultural Services	376.1
10	Metal Mining	1.7
11-12	Coal Mining	0.0
13	Oil and Gas Drilling	34.6
14	Nonmetal Mining	100.8
15-17	Construction	7,703.2
20	Food Products	2,201.0
21	Tobacco Products	1,656.6
22-24	Textiles and Apparel	565.6
25	Wood Products	125.5
26	Pulp and Paper	1,113.5
27	Printing and Chemicals	1,950.6
28	Chemicals	2,081.3
29	Petroleum Products	333.0
30	Rubber Products	760.0
31	Leather Products	17.3
32	Stone, Clay, and Glass	550.9
33	Primary Metals	1,364.2
34	Fabricated Metals	781.9
35	Machinery, except Electrical	1,323.2
36	Electrical Machinery	2,211.3
37	Transportation Equipment	2,458.3
38	Instruments	182.4
39	Miscellaneous Manufacturing	163.5
40	Railroads	870.3
41	Local and Suburban Freight	273.0
42	Motor Freight	1,563.0
44	Water Transportation	376.6
45	Air Transportation	544.6
46	Pipelines	7.8
47	Transportation Services	354.3
48	Communications	4,916.2
49	Utilities	4,136.6
50-81	Trade and Services	59,706.4
82-84	Education and Social Services	6,819.1
88	Households	488.5
91-97	Governments	33,651.2
	Total	142,538.2



## FOUR CRITERIA FOR EVALUATING ENVIRONMENTAL ACCOUNTS

### Criterion #1: Are They Appropriate for Inclusion in National Economic Accounts?

National aggregate economic measures such as GNP are frequently used to evaluate the adequacy of public policies targeted at traditional economic goals. National income and product accounts, which are the basis for GNP estimates, focus on goods and services that are exchanged in actual markets. The strict market orientation to the accounts has derived from one major motivation for the accounts - to characterize certain fundamentals of a national economy (income, output, investment, consumption and saving). In an economy where monetized exchanges are highly developed, all of these fundamentals can be described in a common metric - money.

The underlying basis for the accounts is the type of information one would expect to derive from actual transactions - information of the quantities of goods and services exchanged and their prices. National income accountants have placed a premium on using observed prices and quantities. This prerequisite is not a very stringent one for many market transactions, which is what the accounts purport to measure in the first place. There are however exceptions which require the use of imputations rather than observed transactions. In the United States, the imputed rental value of owner-occupied housing is included in the national income and product accounts. Certain commercially marketed assets appear to satisfy the national economic accountant's desire for market-based information. However, most of the environmental goods and services characterized in the Chesapeake environmental accounts do not.

Welfare economics in general and environmental economics in particular are not confined to observed market transactions. The common attribute of many problems in this domain is that they arise from cases where competitive market outcomes do not maximize social gains. This failure is due variously to the presence of externalities or to the existence of public goods, among other things. Environmental quality is such an important policy concern in part because its fate is determined outside of traditional markets. In this sense, the firm foundation of environmental accounting in welfare economics can add a signifi-

cant dimension to the understanding of a national economy which has been missing from national economic accounts.

While national economic accounting has evolved to provide "a picture of the Nation's economy" (U.S. Department of Commerce, 1985), applied welfare economic analysis has evolved in the course of trying to evaluate alternative public projects, policies, and regulations. Though smaller in scale than national economic accounting, individual applied welfare analyses, especially in the form of benefit-cost analyses, provide a large body of information when taken as a whole. The unit of measure is still money but they provide a picture of a nation's economy from a different perspective, that of social gains and losses rather than of, say, output.<sup>2</sup>

In practice, the concepts of social gains and losses require an understanding of supply and demand relations. These relations can be closely linked to actual market transactions in many cases, but still must be inferred rather than directly observed. Furthermore, when goods and services not traded on markets are involved, special methodologies for estimating values have been developed. It was precisely such estimations in the area of environmental benefit-cost analysis which this study set out to tap and integrate into a framework consistent with national economic accounting.

Whether environmental accounts are appropriate for inclusion in national economic accounts is likely to be foremost in the minds of many accountants. Certainly, current accounting conventions do not permit including environmental goods and services, except for commercially marketed natural resource assets. However, the conventions themselves need not be changed. They serve legitimate purposes in providing one picture of the economy. The imperative that comes from environmental accounting is to expand national economic accounting in the ways that the workings of the economy can be described. There is a good case for thinking that national economic accounting needs what environmental accounts have to offer. The next section outlines what environmental accounting has to offer.

<sup>2</sup> For further discussion of applied welfare economics, see, for example, Just et. al., 1982.

Criterion #2: Are They Appropriate for Informing Economic Policymaking?

Nature, as a provider of services to industry and households, is missed in the conventional accounting framework because there is no charge for its services. The basic power of environmental accounting lies in its revealing such economic values of the environment. Consequently, ignoring the nonmarket side of the environment offers a skewed perception of the composition of the economy.

Explicitly adding a nature sector reflects an attempt to correct that bias.<sup>3</sup> This information is instructive for economic policymaking because it shows that nature is a substantial sector of the economy. The size of the nature sector, gross nature sector output was \$1.3 billion (.9 percent of GCP) in 1985, only reflects the nonmarket component of the contribution that the environment makes to this economy. Yet, it is roughly comparable in size to each of the following sectors, shown in Table 3 - motor freight (\$1.6 billion or 1.1 percent of GCP) primary metals (\$1.4 billion or 1 percent of GCP), non-electrical machinery (\$1.3 billion or .9 percent of GCP), pulp and paper (\$1.1 billion or .8 percent of GCP) and the agricultural sector (\$1.1 billion or .8 percent of GCP).

Much of the interest in environmental accounting has been motivated by a desire to adjust conventional aggregate measures such as GNP to reflect the role of the environment. Two adjustments appear in the accounts developed for Chesapeake. The first reflects the net addition from environmental services and damages and results in a Modified Gross Chesapeake Product of \$143 billion, or a 0.4 percent increase over the conventional Gross Chesapeake Product. The second adjustment affects Net Chesapeake Product by incorporating environmental depreciation, which reflects changes in the value of Chesapeake's environmental assets during the current accounting period. In 1985, the consumption of environmental capital was \$65 million, which represents a reduction of approximately 5 percent from the gross output of the nature sector. Because Chesapeake's Modified Net Chesapeake Product, \$126 billion, reflects both environmental and manmade capital

<sup>3</sup> The expansion of national accounts to include a nature sector is described in Peskin, 1989.

consumption, it provides an indication of the level of national income that is sustainable, given current expectations about the future productivity of capital.

Although the information on which these estimates are based has been in the environmental policy domain for some time, this characterization of the environmental component of the economy is likely to come as news to most economic policymakers. With varying degrees of success, the US government has for some time considered the impact of *environmental policy on the economy*. Benefit-cost analyses are conducted on every major environmental regulation under development. What has been missing has been any reliable assessment of the impact of *economic policy on the environment*.

For mainstream economic issues, there has been much more information to support independent analysis for policymaking. The tools available to economic policymakers to evaluate environmental matters have been limited. For example, for individual federal projects that affect environmental quality, environmental impact assessments are required but these have not been applied to major federal economic policies, which may have greater environmental impacts. Without the kind of analysis embodied in the environmental accounts, inducing economic policy to account for environmental and other nonmarket considerations has often been left entirely to the political arena.

To illustrate how environmental accounts can provide a useful indicator for economic decisionmaking, consider an evaluation of the composition of an economy. From a conventional economic viewpoint, the demise of certain industries (e.g., large-scale manufacturing) and rise of others (high-tech) might be viewed primarily in terms of their roles in providing employment and maintaining international competitiveness. But environmental benefits might also be realized in such a transition, since it may imply the rise of industries that are inherently more efficient and less polluting. The information in environmental accounts can shed light on such linkages between environmental and the economic objectives. Table 4 compares GCP estimates and nitrogen discharges from selected sectors in Chesapeake's economy. Using this type of information, it would be possible, for example, to view an economic policy which induces changes in agriculture from the perspective of potential environmental benefits.

**Table 4. GCP and Nitrogen Discharges for  
Selected SIC Codes in Chesapeake - 1985**

(Millions of 1987 dollars, Metric tons)

SIC	NAME	GCP	Nitrogen
01-02	Agriculture	773.9	23,932.2
15-17	Construction	7,703.2	12,079.5
28	Chemicals	2,081.3	2,021.5
33	Primary Metals	1,364.2	2,261.7
49	Utilities	4,136.6	13,829.6

Criterion #3: Are They Appropriate for Informing Environmental Policymaking?

In the United States, bringing an economic perspective to environmental concerns is not new.<sup>4</sup> As a matter of fact, a large portion of the information base in the environmental accounts for Chesapeake is the legacy of past benefit-cost analyses of environmental policies under development. Clearly, the economic information presented in environmental accounts has a place in the evaluation of environmental policies. However, given their derivation from these earlier analyses, what new guidance to environmental policymaking can environmental accounts provide?

Ordinarily, a benefit-cost analysis in the area of environmental protection concentrates on a selected environmental problem and alternative solutions. The problem may for example be defined by medium (air, water, land), by substance (pesticide, toxic material), or by

<sup>4</sup> With regard to the early 1980's, see, for example (Smith, 1984) which considers the influence on environmental policy of the presidential order calling for benefit-cost analysis of major regulations. In particular, this book evaluates the development of methodologies for estimating the costs and benefits of environmental regulations. For a description of the influence of selected benefit-cost analyses on environmental regulations in the mid-1980's, see (United States Environmental Protection Agency, 1987) and in the late 1980's, see (Froehlich, 1989).

source (production, disposal, incineration). In the development of environmental regulations, the definition of the problem is determined in large part by legislative mandates. Rather than being forced to conduct a benefit-cost analysis for environmental protection in general, the government has the more feasible task of conducting a series of benefit-cost analyses, each of which can be directed at an individual regulatory decision. Desirable as this outcome is in terms of the information created for each individual environmental issue, it lends itself to an atomized view of environmental problems. Each benefit-cost analysis is considered in isolation. Although there are on-going efforts to make comparisons among alternative risks on the public agenda, there have not been many efforts to aggregate the results of many environmental benefit-cost analyses. Where they have appeared, they have either been restricted to one medium (air) or they are dated (Freeman, 1982).

Environmental accounts should in theory provide a comprehensive view of the costs and benefits of environmental protection. In practice, they are less than comprehensive, as can be seen from the current effort with Chesapeake where certain important environmental problems (e.g. pesticides, land disposal, toxic contamination of Bay sediments) were not assessed. Still, it was possible to present both air and water pollution problems in the environmental accounts. Consequently, it is possible to compare in economic terms both the relative magnitudes of their seriousness and their changes over time. For example, as Table 5 shows, air and water damages were comparable in 1982 (\$186 million vs. \$159 million) but water damages exceeded air damages by more than \$227 million in 1985. Thus, considering improvements in air pollution while ignoring the worsening of water pollution paints a brighter but misleading picture of the success of environmental protection. Because they are meant to be comprehensive, environmental accounts have the potential for presenting an aggregated evaluation of all environmental protection efforts.<sup>5</sup>

<sup>5</sup> A recent report of a public advisory group to the U.S. Environmental Protection Agency recommended that the Agency become more attuned to relative risks. "Because most of EPA's program offices have been responsible for implementing specific laws, they have tended to view environmental problems separately; each program office has been concerned primarily with those problems that it has been mandated to remediate, and questions of relative seriousness or urgency generally have remained unasked" (U.S. Environmental Protection Agency, 1990).

**Table 5. Changes in Nature Sector Entries 1982 - 1985**

(Millions of 1987 dollars)

<b>Nature Sector Entry</b>	<b>1982</b>	<b>1985</b>	<b>% change</b>
Environmental Damages	345.3	459.6	33%
Air	186.1	116.3	-38%
Water	159.1	343.3	116%
Waste Disposal Services	184.8	181.5	-2%
Air	127.8	92.9	-27%
Water	57.1	88.6	55%
Final Demand for Nonmarketed Environmental Services	1,059.6	1,102.1	4%
Net Environmental Benefit	898.9	824.0	-8%
Environmental Depreciation	65.9	64.8	-2%
<b>GROSS NATURE OUTPUT</b>	<b>1,244.1</b>	<b>1,283.6</b>	<b>3%</b>
<b>NET NATURE OUTPUT</b>	<b>1,178.3</b>	<b>1,218.9</b>	<b>3%</b>

There was a gain in final demand for nonmarketed environmental services of about 4 percent. Since most of the final demand services are more sensitive to changes in water pollution than to changes in air pollution, the gain in these services might have been far larger had there not been a deterioration in water quality between 1982 and 1985. This gain was partially offset by a loss of waste disposal services of about 2 percent, leading to a net increase in gross nature sector production of about 3 percent.

One of the real surprises for those conditioned to think of environmental programs as ones to remediate environmental damages is the magnitude of services which flow unimpeded from the environment. The results for Chesapeake suggest that environmental priorities should be less aligned with correcting environmental damages (approximately \$460 million in 1985) than with protecting environmental services to households (\$1.1 billion in 1985) which may be at risk. This indication seems consistent with the evolution of environmental programs in the US,

which were more concerned with restoring environmental quality (cleaner air, cleaner water) during the 1970's and 1980's but are being oriented more to protecting existing environmental assets (habitats, biodiversity).<sup>6</sup>

A caveat should be noted in this evaluation of the usefulness of environmental accounts for policy. Environmental accounts are only as comprehensive as the existing stock of knowledge of environmental problems allows. This caveat is especially true for knowledge of the economic valuation of environmental problems. As significant as the progress has been in estimating environmental service values, current results still reflect only a small subset of services from the environment - the ones connected to problems, such as air and water pollution, that have been studied for many years. For example, values for ecosystems and biodiversity are not yet adequately represented in the accounts. Consequently, progress in making the accounts more comprehensive lags behind and will depend on progress in analyzing newer environmental problems.

In the eyes of some critics of economic analysis of environmental policy, an inability to identify economic values for important aspects of the environment lends support to having other scientific disciplines set environmental priorities. Physical indicators of the health of the environment have been advanced as one approach. As useful as these may be for tracking changes in the environment, one result in the Chesapeake environmental accounts shows how these too may be inadequate for setting priorities. Nitrogen and phosphorus discharges to the Chesapeake Bay were 83,218 metric tons and 13,003 metric tons respectively in 1982. By 1985 nitrogen discharges had increased to 100,735 metric tons, an increase of 31 percent. Phosphorus loadings were 13,343 metric tons in 1985, an increase of 3 percent over 1982. Unsettling as these increases in effluent loadings may be, the picture is worse when expressed in economic values. The damages doubled, from \$159 million to \$343 million.

<sup>6</sup> For example, the U.S. Environmental Protection Agency was advised recently that it "should be as concerned about protecting ecosystems as it is about protecting human health" (U. S. Environmental Protection Agency, 1990).



Criterion #4: How Well Could Environmental Accounts Enhance Integrated Environmental and Economic Decisionmaking?

An integrated view entails evaluating policy-relevant information with different criteria. From users of conventional economic accounts, there may be reservations about the imputations used in environmental accounts (rather than actual market transactions). From advocates of physical accounts, environmental accounts may be faulted for not completely characterizing all environmental concerns. Still, environmental accounts offer something that neither conventional economic nor physical accounts offer.

This paper has already shown that an economic account which purports to describe all important economic activity while ignoring a significant sector will present a biased view. On the other hand, a physical account that describes different aspects of the environment in different physical units lacks a common metric. This shortcoming makes aggregation impossible and limits understanding of the relative magnitudes of various environmental problems.

Consequently, the reliability of environmental accounts should be measured in terms of an indicator like the mean squared error criterion. This criterion recognizes that there can be trade-offs in the quality of numerical estimates between statistical efficiency (minimum variance) and bias. Incorporating *estimated* values of environmental services into accounts that ordinarily use observed values of market transactions may increase the variance embodied in economic accounts but should also reduce those accounts' inherent biases with regard to the environment. Once environmental accounts are constructed, the potential size of such biases becomes more apparent.

Until more experience is accumulated the ultimate trade-offs like those discussed above with respect to the statistical reliability of the accounts will not be known. Accounts in the economic sphere have always been works-in-progress. Refinements in data and methodologies have been integrated, although less so as the accounting process matured. The same holds true for environmental accounts that are only being tested on a small scale now. It will take time to identify their full potential and the shortcomings that will remain even after more development.

In this regard, environmental accounts are perhaps most useful in the longer run. It is unlikely that a day will come when quarterly reports on environmental progress are met with as much anticipation as the quarterly reports of GNP changes. Apart from acute damages, it is most important to scrutinize environmental effects on a long term basis. Measuring and evaluating trends through environmental accounts lay a foundation for evaluating environmental progress and provide a starting point for more comprehensive assessment of economic and environmental policy.

The accounts make this possible by providing a body of information on the changing status quo of the environment and the economy. In this sense, the accounts serve a scorekeeping function. As important as this scorekeeping function is, the availability of this body of information to the public at large also permits a host of independent analyses evaluating what the environmental accounts have shown. The accounts describe what is. It is up to analysts to gauge where there is room for improvement in a society's economy and environment.

Only by integrating economic and environmental information will it be possible to evaluate the sustainability of long-term economic developments. Still, in the environmental accounts developed for the Chesapeake Bay, true integration is far from complete since the linkages between the environment and the economy are not fully explicit. The Chesapeake accounts can describe simultaneously what is happening to services from the environment and to economic activity but they do not always establish causal linkages between these trends. This shortcoming is not attributable to the accounting framework per se.<sup>7</sup> Instead, as others have noted, there is an absence of theoretical understanding which "relates the scale and configuration of an economy to the set of environment-economy interrelationships underlying that economy" (Pearce et. al., 1990, p.42). The body of information assembled in environmental accounts provide a proofing ground for further development of this understanding just as economic accounts have been for interpreting macroeconomic relationships.

<sup>7</sup> As a matter of fact, the imperative for further development of understanding the linkages became clearer in the course of building the Chesapeake environmental accounts. For example, the contribution of ecosystems to human welfare have been generally alluded to but the evidence has been sparse. Sometimes integration can be improved substantially by merely showing environmental-economic connections that were generally unknown. A modest input-output model of the relationship between elements of the Bay's marine ecosystem and commercial fish was developed to highlight potentially important linkages.

## FUTURE DEVELOPMENTS

A logical next step in developing environmental accounts would be to pursue them for the United States as a whole. Although building accounts on such a large scale would entail the loss of some resolution, it may actually be easier than the Chesapeake effort in terms of using existing economic and environmental information. The major difficulty in creating a set of national environmental accounts for the United States would be developing and managing the large data sets that would be required for such accounts. Another potential problem may arise when aggregating the heterogeneous types of services provided by the wide array of environmental and natural resource assets in the United States.

Undertaking environmental accounts at the national level would present the difficult, but interesting, challenge of characterizing transboundary pollution problems, which constitute a form of detrimental imports and exports. To the extent pollution is exported, it would be necessary to calculate the resulting damages abroad. In addition, there is the question of how to deal with global environmental problems (stratospheric ozone, climate change) in environmental accounts. Unique issues in the timing and distribution of benefits and costs will have to be addressed. Today's emissions of chlorofluorocarbons or CO<sub>2</sub> from the US could affect the well-being of people throughout the world at some point in the future. Furthermore, unilateral efforts by one country to reduce these emissions could benefit people throughout the world but the costs are borne by that country alone. Ultimately, such global environmental connections may raise questions about the adequacy of *national*, as opposed to *global* accounts.

In the face of such challenges, developing environmental accounts further on a smaller scale begins to look very appealing. Even without this motivation, there are good reasons for continuing to focus on a region like Chesapeake. Many environmental problems are inherently local in nature and the environmental accounting effort in Chesapeake provided an opportunity to examine in economic terms a regional entity defined by environmental imperatives. This hybrid political unit raises the question of whether there is a better way to address economic-environmental interactions than the usual federal-state relations. Chesapeake certainly gives that impression. There appear to be other untapped demands for examining this kind of environmentally derived economic entity. For example, ecological regions of the US have been defined for the purpose of assuring better management of ecological resources but these have

not yet been examined in economic terms much less in terms of environmental-economic connections. Also, the approach taken in the Chesapeake Bay region has generated interest in other regions of the US, especially where there are significant natural resource assets like the Chesapeake Bay.

## CONCLUSION

This paper presented results from a US case study of environmental accounting. These results call into question the conventional wisdom of how national accounts characterize an economy. Knowing more about the environmental attributes of economic activity can provide useful guidance to economic policymaking. Because environmental accounts can provide such information, old standards against which national economic accounts have been judged are no longer adequate and should be expanded. As the scope of economic policymaking evolves, so must the information in national economic accounts.

For environmental policymaking, environmental accounts are less of a break from the past. In the US, they fit into a strong tradition of applying economic analysis to environmental issues. The information from such analyses were used extensively to derive the environmental accounts described here. Nonetheless, organizing all of this information in one place can offer insights that could not be derived from the individual analyses themselves.

The standards against which environmental accounts ultimately should be judged will depend on the extent to which environmental and economic policymaking become more integrated. However, this evolution is itself endogenous. On the one hand, the better the information on environmental-economic interactions, the more likely that decisions will reflect its influence. On the other hand, the greater the imperative for integrated decisionmaking, the greater will be the efforts to integrate the information. In this context, even modest advances in developing environmental accounts have the potential for raising the significance of the accounts themselves and for heightening the momentum for further developments.

## REFERENCES

Bockstael N.E., McConnell K.E., and Strand I.E., 1988. Benefits from Improvements in Chesapeake Bay Water Quality, Vol II. Report prepared for Office of Policy and Resource Management, U.S. Environmental Protection Agency, contract # CR-811043-01-0, Washington, DC.

Energy and Resource Consultants Inc., 1987. Economic Benefits of NO<sub>x</sub> Control: Design and Application for the Eastern U.S. Draft report prepared for U.S. Environmental Protection Agency, Office of Policy, Planning, and Evaluation, Washington, DC.

Freeman, A. M., III, 1982. Air and Water Pollution Control: A Benefit Cost Assessment, Wiley, New York.

Froehlich, M., Hufford, D. J. C., and Hammett, N. H., 1989. "The Use of Environmental Benefits Estimates in Decision-Making - Experience in United States Regulation Development", manuscript prepared for the OECD Workshop on "Benefits Estimates and Environmental Decision-Making," Paris, April 1989.

ICF Resources Incorporated, 1990. Economic Analysis of Title IV (Acid Rain Provisions) of the Senate Bill (S. 1630). Draft Report prepared for U.S. Environmental Protection Agency, Office of Air and Radiation, Washington, DC.

Just, R. E., Hueth, D. L., and Schmitz, A., 1982. Applied Welfare Economics and Public Policy, Prentice-Hall, Englewood Cliffs, NJ.

Krupnick A.J., 1988. An Analysis of Selected Health Benefits from Reductions in Photochemical Oxidants in the Northeastern United States. Final report prepared for U.S. Environmental Protection Agency, Office of Air Quality Planning and Standards, Contract # 68-02-4323, Research Triangle Park, NC.

Pearce, D. W. and Turner, R. K., 1990. Economics of Natural Resources and the Environment, The Johns Hopkins University Press, Baltimore.

Pechan & Associates, Inc., 1990. Ozone Nonattainment Analysis: A Comparison of Bills. Report prepared for U.S. Environmental Protection Agency, Office of Air and Radiation, Washington, DC

Peskin, H. M., 1989. "A Proposed Environmental Accounts Framework", in Ahmad, Y. J., El Serafy, S., and Lutz, E., Environmental Accounting for Sustainable Development, The World Bank, Washington, DC, 1989.

Peskin, H. M. with Lutz, E., 1990. "A Survey of Resource and Environmental Accounting in Industrialized Countries", Environmental Working Paper No. 37, The World Bank, August 1990, Washington DC.

Smith, V. K., ed., 1984. Environmental Policy Under Reagan's Executive Order, University of North Carolina Press, Chapel Hill.

U.S. Department of Commerce, Bureau of Economic Analysis, 1985. "An Introduction to National Economic Accounting", Methodology Papers: U.S. National Income and Product Accounts, March 1985, Washington, DC.

U.S. Environmental Protection Agency, Office of Mobile Source Air Pollution Control. 1974. Medium Duty Vehicle Emission Control Cost Effectiveness Comparisons, Volume I - Executive summary. Report # EPA 460/3-74-004-a. NTIS PB82-242488.

U.S. Environmental Protection Agency, Air Quality Management Division, Office of Air and Radiation, 1985. Regulatory Impact Analysis of the National Ambient Air Quality Standards for Nitrogen Dioxide, Research Triangle Park, NC.

U.S. Environmental Protection Agency, Office of Policy, Planning and Evaluation, 1987. EPA's Use of Benefit-Cost Analysis: 1981- 1986, Washington, DC.

U.S. Environmental Protection Agency, Chesapeake Bay Program, 1988a. A Commitment Renewed: Restoration Progress and the Course Ahead Under the 1987 Bay Agreement. Report # CBP/TRS 21/88, Annapolis, MD.

U.S. Environmental Protection Agency, Air Quality Management Division, Office of Air and Radiation, 1988b. Regulatory Impact Analysis on the National Ambient Air Quality Standards for Sulfur Oxides (Sulfur Dioxide), Draft. Research Triangle Park, NC.

U.S. Environmental Protection Agency, Science Advisory Board, 1990. Reducing Risk: Setting Priorities and Strategies for Environmental Protection, Report to the Administrator, Washington, DC.

U.S. Environmental Protection Agency, Office of Air Quality Planning and Standards, 1991. National Air Pollutant Emission Estimates 1940-1990, Report # EPA-450/4-91-026, Research Triangle Park, NC.

## TOWARDS PLURALISM IN NATIONAL ACCOUNTING SYSTEMS

Anthony M. Friend

Institute for Research on Environment and Economy

The question addressed is the need for pluralism in National Accounting. This paper explores the conceptual foundation of income (flow) and wealth (stock). The frame of reference of the SNA is influenced by the concerns of the 1930s when there was a chronic "under-employment" of resources. This raises the question on whether the current measures of income and wealth are appropriate for describing the performance of the economy where the "overuse" of natural stocks is of growing concern.

It is argued that the one model, one value, approach (even when adjusted for resource depletion and environmental costs) is insufficient to describe important components of the "national product". National policies of sustainable development require, at a minimum, a system of physical accounting of natural wealth, its augmentation and depletion.

It is further argued that *use-value* is the appropriate numeraire for accounting for Sustainable Development. The dominance of *money-value* in the national accounts leads to distortions in evaluating the real output of multi-structured economies and non-market values inherent in environmental goods and services. State of the Environment indicators are suggested as a complementary reporting system to the established state of the Economy indicators. From another perspective environmental accounting describes the spatial dimension of human activity. This paper not only presents a case for pluralism but elaborates upon the inter-relationships between Natural Resource Accounting, Material-Energy Balances and State of Environment Reporting (see Figure 1).

The paper concludes with a discussion of the process in establishing the pluralistic approach to national accounting systems.

Pluralism:

*A theory or system of thought which recognises more than one ultimate principle: opposed to Monism*  
Oxford English Dictionary



## Introduction

Is national accounting a science? Is the scientific method of proof, or confirmation of theory applicable to the national accounts? Science requires that empirical observation is consistent with the laws of nature. Do such laws exist in the social sciences? Gunnar Myrdal thought not. To him the only distinction that counted was whether the observed "facts" were relevant, or more to the point, which facts were more relevant than others (Myrdal, 1973). Economic theory has the tendency to infuse ideology with empirical observations of social behaviour (Robinson, 1962). Is the SNA, therefore, an elaborate legerdemain to bolster the tyranny of growth in GNP?

Social scientists are acutely aware that interpretation (or meaning) of empirical evidence of social behaviour is contextual to a particular frame of reference. This was not always acknowledged when the Newtonian framework dominated the world of science. The eighteenth century political economists believed that universal economic laws could be discovered in the manner of celestial mechanics. The laws that govern supply and demand of commodities, for example, could be empirically determined by observing human buying and selling behaviour in competitive markets. In this way, all rational economic decisions, so it appeared, could be deduced from mechanistic behaviour not too different from the dynamics of physical equilibrium states found in nature. In other words, an economy viewed as an elaborate homeostatic system, an image epitomized in the concept of self-regulating markets and further encapsulated in Adam Smith's metaphor of the "Invisible Hand".<sup>1</sup>

The economic model, particularly in its micro-economic guise, dictated the behaviour of the explanatory variables for the wealth of nations. The theory of comparative advantage (the ideology of free trade) extended the "invisible hand" to the global economy. With the abandonment of the gold standard, and most severely in the Great Depression of the 1930s, the self regulating mechanisms appeared to break down. Thus, economic behaviour, which appeared to be imbued with natural laws, were seen, as they always should have been, as human responses to a consciously designed economic system. When the supporting institutions collapsed so did the self-regulating market, the success of which could be largely

---

<sup>1</sup> As a philosopher of morals Adam Smith found it convenient to rationalise the ethics of greed by drawing upon the paradox of the individual's pursuit of personal gain in a competitive environment benefits the individuals of the society as a whole.

attributed to the historical anomaly of the pax Britannica and the enforcement of the gold standard. This framework created the unique institutional conditions for the free flow of finance exemplified in nineteenth century capitalism (Polanyi, 1944).

The neo-classical synthesis established a paradigm for the SNA. While the national accounting community is aware of alternative interpretations (e.g., Material Product Accounts), they, nevertheless, defend the SNA framework on essentially positivist grounds, assuming for instance that statistical surveys of economic variables are confirmation of empirical facts. Yet, it is well known that there is no singularity in the conceptual basis of such key economic variables like production, consumption and capital accumulation nor, for that matter, has the notion of what constitutes the national product ever been satisfactorily clarified. Indeed, the question of what should be included, or excluded, from GNP has been in dispute ever since the inception of national accounting. In spite of the lively controversy among the profession, GNP is still regarded as an objective indicator of economic performance. As has been noted in the many critiques on the measurement of GNP this could be cited as a good example of Whitehead's fallacy of misplaced concreteness (Daly and Cobb, 1989).

The purpose of this paper is to explore aspects of economic thought that explains this "misplaced concreteness" and argues for a pluralistic approach. An underlying leitmotif is that of the importance of the measure of income in assessing economic performance, emphasizing in particular the distinction between *money* and *use value* with respect to the evaluation of environmental goods and services.

#### **National Accounting as a Measure of Wealth**

The Roman Census was, in essence, a stock accounting of the population for the purpose of estimating the potential tribute expected to flow into the coffers in Rome, and perhaps in later years, also a baseline estimator for recruitment quotas required to replenish the depleted Legions. Norman England further expanded stock accounting to include the number of serfs, livestock, and area of ploughland of the manorial estates. This vast data collection programme was cynically viewed as the *Domesday Book*, but nonetheless with prescience on the future of statistics.

Thus, while the origin of national accounting can be traced to measures of stock, it was Adam Smith who first recognised the importance of the combination of stock and flow factors (i.e., capital, labour, and land), as the instrumental causes of the wealth of nations. Nonetheless, he noted the fundamental functional role of natural resources when he stated that "the earth furnishes the

means of wealth".<sup>2</sup> The creation of national product by combining factors of production (economic flows) with natural resources (economic stocks) became a major preoccupation of the new science of political economy. The classical framework treated natural resources, i.e., soils, as a limiting factor in economic growth models. The Malthusian theory of the geometric growth in population and arithmetic growth in food output led to the inescapable conclusion of the inability of the labouring class to rise above subsistence level. The models of the "dismal sciences" of diminishing returns from the soil led to another inescapable conclusion: the increasing appropriation of wealth claimed in the form of (unproductive) Ricardian rent.

The tradition of physical stock accounting is now largely ignored in modern national accounting systems. This is replaced by a flow concept referred to as The National Income which measures the value of the (unduplicated) annual output of goods and services produced in the economy. Apart from the perplexing problem of evaluation, a concept representing production between two points in time is far more difficult to pin down than that of an accumulated stock of wealth at a point in time. The latter does not require an opening and closing inventory in order to allocate the year-to-year transfer of wealth nor does it need to distinguish trans-boundary flows of goods and services, i.e., balance of trade. The elimination of all intermediate flows in order to avoid the sin of double counting provides yet another quandary for "national flow accountants" to resolve. For instance, should one distinguish the proportion of the car used for travel to work from that of use for pleasure? Since one cannot measure income directly ambiguities arise from the interpretation of surrogate measures, like assuming the equivalence between payments to factors of production, (i.e., labour, capital and land) and the level of income.

These accounts also play an important instrumental role in fiscal and monetary policies. Thus, financial flow accounts have been developed to monitor some of the vital signs of economic health represented by such abstract concepts as the rate of savings, the level of investments, and liquidity of the money supply. Oddly, it is the inter-industry I/O Table in the SNA that comes closest to a meaningful measure of national product from an environmental perspective, i.e., material-energy throughputs. Yet, within the context of the SNA this is regarded as *intermediate product* which is conveniently cancelled out in the measurement of GDP. The structure of the SNA (conceived of as a two-way production-consumption flow among business, households, governments and the rest-of-the-world) effectively closes the system from accounting for direct environmental contributions to the economic

---

<sup>2</sup> "Inquiry into the Nature and the Causes of the Wealth of Nations", first published in 1776.

process. Thus, foreclosing an opportunity to link the health of the economy to the health of the environment (Daly and Cobb, 1989).

### **The Problem of Value: Money or Use-value**

The requirement of a common denominator is a *sine qua non* to producing a single figure of the national product. The obvious choice is money the medium of exchange. The alternative of *utiles* was wisely ruled out. Thus, *money-value* became the undisputed numeraire of the SNA. Nonetheless, the credibility of the GNP as a measure of economic welfare stems, in part, from the implication of money as the basis of the value system. As Joan Robinson pointed out, dispute on the nature of value is deeply embedded in economic discourse. This, she referred to as "the metaphysics of economics."

*"One of the great metaphysical ideas in economics is expressed by the word 'value.' What is value and where does it come from? It does not mean usefulness - the good that goods do to us.... It does not mean market prices...it is something which will explain how prices come to be what they are. Like all metaphysical concepts, when you try to pin it down it turns out to be just a word." p. 29, (Robinson, 1962).*

One dire consequence of *money-value* accounting is that it equates income with the quantity of *market* goods and services produced. The difference between exchange value and use value is clearly distinguishable in economic literature. Utility, or satisfaction derived from consumption, is a measure of *use-value*; in essence a stream of services obtained from stocks. For many economists the latter is a superior indicator of economic well-being than is the flow measure used in national accounting (Fisher, 1906, Boulding, 1949, Daly, 1976).

While the assumption in "consumer choice theory" that market values (under certain conditions) can subsume all other values has some validity, it has proven difficult to defend in the case of environmental externalities, cultural values in nature, and most conspicuously in problems associated with the inter-generational transfers of natural resources (Martinez-Alier, 1987). In order to encompass non-market values in consumer choices a new domain of economic discourse aimed at finding socially acceptable methods of evaluating the contribution of *environmental goods and services* to economic welfare has been developed. The discourse focuses on methods to calculate values for common property by creating "artificial markets" for allocation of scarce environmental resources. The economic tool kits include shadow prices, willingness-to-pay, option values, contingency evaluations, present time social discounting and so forth. However, with perhaps a few exceptions (such as the application of cost-benefit

analysis of specific project ) environmentalists tend to be highly suspicious of these techniques believing them to be merely a trick to turn high order cultural values into low order *money-values* (Huetting, 1980, Naess, 1989).

Apart from the metaphysical value issue, there are several other objections to the empirical basis of the *money-value* approach. These fall into the following categories:

(a) The assumption of a single market. Economic systems are complex and multi-layered. GNP, in essence, is a normative concept conforming to an institutional viewpoint of "markets". In Third World economies these blur into self-sufficient village economies and familial obligatory arrangements; so aptly called the "informal economy". Thriving markets for illegal goods and services, e.g., the drug trade, tax evasion activities, and barter arrangements suggest the existence of a dual (underground) economy among the industrial nations. The emerging globalization of the economy described by footloose multinationals and the round-the-clock electronic stock markets is yet another conundrum in defining what should constitute the "boundaries" of a single market.

(b) The assumption of truth-value in survey questionnaires. In modern industrial states we have come to trust the responses of business, household, and governments to statistical surveys. In these surveys degrees of error are calculated on such innocuous factors as sample size rather than on assumptions about outright lies. In countries where businesses habitually under-invoice and where there are wide discrepancies between budgeted and actual disbursements of public funds (e.g., flows to Swiss bank accounts) the problem goes beyond the notion of under-reporting and borders on deliberate deception. The reporting of (unfulfilled) production quotas in the centrally planned economies must, at least until recently, have created havoc to the measurement of GNP. Suspicion, even in market economies, of the use of survey information (despite assurances of statistical confidentiality) may result in distortions in survey response. Another factor that is rarely examined is the variance in business accounting and the means employed to reconcile this with national accounting concepts. Valuation of capital assets is clearly a major problem here.

(c) Price adjustment assumption. Compensating for inflation/deflation is the bane of national accountants. Comparisons of time series of real income become increasingly dubious as consumer tastes change over time and shifts in relative prices affect consumer buying habits. Attempts to maintain real income series might hide fundamental structural changes in the economy.

(d) The assumption of the relationship of income and access to goods and services. There are compelling reasons to believe that growth in money-incomes (in constant prices)

is not always positively correlated to economic well-being. This, in essence, is the non-inflationary part of the "money illusion." One factor that may account for this is the cost incurred by maintaining increasingly complex (and potentially unstable) systems (Prigogine and Stengers, 1984). Thus, growing bureaucracies in government and business, general inefficiencies of physical crowding e.g., traffic jams, and costs engendered by social and technological instability i.e., security and risk, can add to money-income without equivalent compensation of desired goods and services.

**What information is needed to manage the economies of the 1990s and beyond?**

The well known Keynesian equations  $Y = C + S$  and  $S = I$  define the relationship of income, consumption, saving, and investment. Nonetheless, these relational insights are not truth statements about the real world, but identities. The significance of the Keynesian model is its potential to link economic policy to a formal equilibrium structure described by the SNA. One should be reminded, however, that the dispute in his famous treatise entitled **The General Theory of Employment, Interest, and Money** (1936) was the neo-classical assumption that equilibrium forces of supply and demand (for labour) made the existence of involuntary unemployment impossible. The major part of his treatise was to demonstrate the mechanism of how a permanent state of high levels of unemployment is possible in a modern economy. A very pertinent issue at a time when much of the industrial world's factories were laying idle and governments felt impotent in reviving their morbid economies. The solution, according to Keynes, was for governments to stimulate the growth in effective demand through the power-boost of new public investment expenditures (i.e., the multiplier effect). The Keynesian model of economic management set the agenda for policies directed at full employment which, in effect, are indistinguishable from the objectives of growth in GNP. We should recall however that rate of unemployment is correlated to the trade cycle and the level of employment (or proportion of the population employed) to the structure of the economy. Thus, the popular view that jobs and economic growth run in parallel stems from the confusion between short term cyclical movements in trade and long term structural changes in the economy.

How relevant is this frame of reference to the concerns of the 1930s in the 1990s? Over-employment of natural resources and environmental externalities of production and consumption are reaching crises proportions. Popular demand for political accountability for the maintenance of ecological and natural resource assets today seems to parallel the popular demands for full employment in the 1930s. Placing the principles of sustainable development on the political agenda has raised the question of the adequacy of economic intelligence and should be taken as a

signal for a new frame of reference in national accounting (Friend and Rapport, 1991).

Income, expenditure and financial flow accounts of the SNA provide information about the level of market activity which can be used to monitor the trade cycle phenomenon. These data are clearly important for the short term management of market forces and evaluation of the effects of countervailing actions of monetary and fiscal policy. The I/O accounts and the national balance sheets provide, in essence, intelligence on the structural characteristics of the economy and thus serve the needs for more long term economic strategies. The proposed Environmental Satellite Accounts would also provide further intelligence on environmental externalities of production/consumption processes and macro-level monitoring of depletion rates of natural resources (Stahmer 1990). It would seem, *a priori*, that the revised SNA (when complete) is, in fact, a well balanced economic information source for managing the economies of the 1990s and beyond.

The question that needs to be raised, however, is whether the revised SNA is a sufficient information base for the holistic management of the economy. The distinction between *use-value* and *money-value* is also a distinction between an accounting of the capacity to produce goods and services and an accounting of the enjoyment of economic product. These distinctions imply two different frames of reference for national accounting. The SNA framework is deficient in providing insight into many of the concerns about linkages between the environment and the economy. The missing links are accounts which measure:

- (a) efficiency in the use of physical stocks and energy flows particularly as it pertains to the evaluation criteria for sustainable development (i.e., the system material-energy balance accounts) ;
- (b) the contribution of the "free-gift-of-nature" to the national product (i.e., system of natural resource accounts) ;
- (c) the non-market contribution of the informal economy to the national product;<sup>3</sup>
- (d) the state of the environment.<sup>4</sup>

---

<sup>3</sup> The SNA deficiencies in the informal sector is particularly significant in Third World economies. An accounting based on use-value seems highly relevant in understanding the economic structures of these countries. For example the self-sufficiency of the village economy in India.

<sup>4</sup> National State of Environment Reports have been included here because it seems to the author that this should be considered as the environmental dimension of national

The alternative use-value approach emphasizes the stream of benefits obtained from the accumulated stock of human artifacts and ecological assets. *Use-value* is enhanced by the maintenance of natural resource stocks and by durability and use-intensity of human artifacts. Income is conceived of as a flow of services obtained from stocks. The use-value accounting framework is in essence "wealth accounts" made up of the physical stocks of man-made and natural resources, and material-energy flow accounts.

### **The Case for Pluralism in National Accounts**

The major flaw in the SNA is its single-value bias. The philosophy of hermeneutics claims that observations of events are not independent of their interpretive frame of reference upon which conclusions are drawn. This seems to be a universal condition in the social sciences and is increasingly so in the case of the physical sciences (Ricoeur, 1981, Miller, 1987). Thomas Kuhn in "The Structure of the Scientific Revolution" also recognised the critical role of the establishments of "paradigms" in science. This, as in hermeneutics, provides a particular frame of reference for scientific research, acceptance of theory, and esteem and recognition among colleagues (Kuhn, 1972). Heisenberg's uncertainty principle finally put to rest the idea that one can ever obtain completely objective observations of the fundamental particles of matter. The social sciences similarly recognise that there are no objective, or value-free facts, in social observations (Myrdal, 1973).

The validation criteria are reduced to: (a) consistency in the model; (b) non-contradiction of observed facts; and (c) the plausibility of the underlying premise. What is notable is that the traditional criterion of predictability is no longer considered as either a necessary or sufficient condition of scientific proof. Economics, supposedly the most "predictable" of the social sciences, assumes a level of rationality in human behaviour that is clearly not borne out by social observation. Pluralistic approach to national accounting provides decision-making with alternative frames of reference for evaluating social performance and, perhaps more importantly, makes room for ethical values in assessing the state-of-the-nation.

---

accounts. This begs the question of whether social accounting should also be part of the SNA. In view of the author a good case can be made for this as well.



Richard Norgaard argues that:

*"...the use of a single framework disenfranchises or disqualifies the majority, facilitates the tyranny of the technocrats and encourages centralization. Openness to multiple frames of analysis is a prerequisite to democracy and decentralization."* (Norgaard, 1989).

The criticism of GNP as an indicator of economic performance would be greatly ameliorated if alternative measures of economic well-being were available. This aggregate could then be relegated its proper role as an indicator of the health of the market economy. The concept of net domestic product, where resource depletions are subtracted to generate a "sustainable income measure," is a start towards pluralism (Bartelmus et al, 1989). Indeed, in the early debate, before SNA production boundaries were etched in stone, there was more openness to the concept of what constitutes national product. Kuznets, for one, thought that expenditure on public administration and security should be excluded from GNP on the grounds that it was a prerequisite for production (Kuznets, 1952).

Forty years later the controversy on what should be considered "prerequisites for production" has shifted towards questions of conservation of ecological capital and availability of exhaustible resources. One issue at hand is the introduction of environmental accounting and its linkage to concepts of production, consumption, and capital accumulation in the SNA. In order for this to happen nothing less than a shift in the "economic production paradigm" is required. Thomas Kuhn points to resistance to change in well-established paradigms. The following passage could well be describing the national accounting community:

*"Their achievement was sufficiently unprecedented to attract an enduring group of adherents away from competing modes of scientific activity. Simultaneously, it was sufficiently open-ended to leave all sorts of problems for the redefined group to resolve" p.10, (Kuhn, 1972).*

The opportunity for a pluralistic approach to the development of official government national accounts is greater today than at any time since their most active developmental phase between 1940s and 1960s. A major breakthrough must clearly be the development of the new science of "systems analysis". This has greatly facilitated the capacity to develop conceptual models describing complex hierarchical structures and formal sub-component linkages. Computerized data management systems has further added a quantum jump in the ease of manipulating and reorganising data on both temporal and spatial planes. Thus allowing for alternative re-aggregation no longer constrained by hand cranking of statistical data.

## Environmental Accounting

Two views have emerged out of the current debate on how to introduce environmental and natural resource parameters in the national accounting framework. One reflects essentially the "single value" bias of converting environmental externalities and resource depletions to *money-values*. The other is to focus on *use-value*. This implies the need for physical accounting of material/energy use, the physical stock and flow of natural resources, and state-of-environment indicators. The essence of pluralism is not to consider these as alternatives but as complementary. Indeed, physical accounts would be a prerequisite database even for calculating the *money-values* of environmental goods and services (Friend, 1989).

The remainder of this paper consists of a brief discussion of the *use-value* approach to national accounting. **Figure 1** shows the schematic circular flow of materials and energy in the economic process. The system requires an accounting of natural resource stocks and flows, a description of economic processes in terms of material-energy balance accounts, and a stress-response account which links the economic process with the state of the environment. A feedback loop connects the condition of the environment with the qualitative state of natural resource stocks.

The Ayers/Kneese paper "Production, Consumption, and Externalities" introduced the notion of material-energy balance accounts (Ayers, Kneese, 1969). The idea of a Material-Energy Balance Statistical System (MEBSS) was presented by the United Nations Statistical Office (ECE Meeting on Environment Statistics, Geneva 1976) as the basis of a framework for the development of environment statistics (UN, 1976, Friend, 1981). MEBSS provided a detailed stock/flow accounting of materials and energy in production and consumption processes. A concept of mass-balance in economic processes defines a total accountability of the weight/volume of inputs and outputs. These are further distinguished between "economic commodities" and "waste residuals." The core of MEBSS is a tracking system of physical flows from raw materials to finished products. Raw materials are extracted and/or harvested from the biosphere's stocks of natural resources defined broadly as the atmosphere, hydrosphere, lithosphere and flora and fauna. Production processes are defined by their physical, chemical and engineering attributes. These include refining, smelting, shaping, weaving, chemical reactions, assembly, packaging, and so forth. Transportation, storage, and construction activity are also represented in terms of physical processes. The consumption of finished goods is similarly treated as physical flows of materials and energy. Household consumption, for example, could be defined as maintenance of homes, travel to work, recreational activities, and consumption of material artifacts such as cars, clothes, toys, furniture, and electronic equipment. Since MEBSS is

Figure 1: Material-Energy Flows, Natural Resource Accounts & State of Environment Reporting

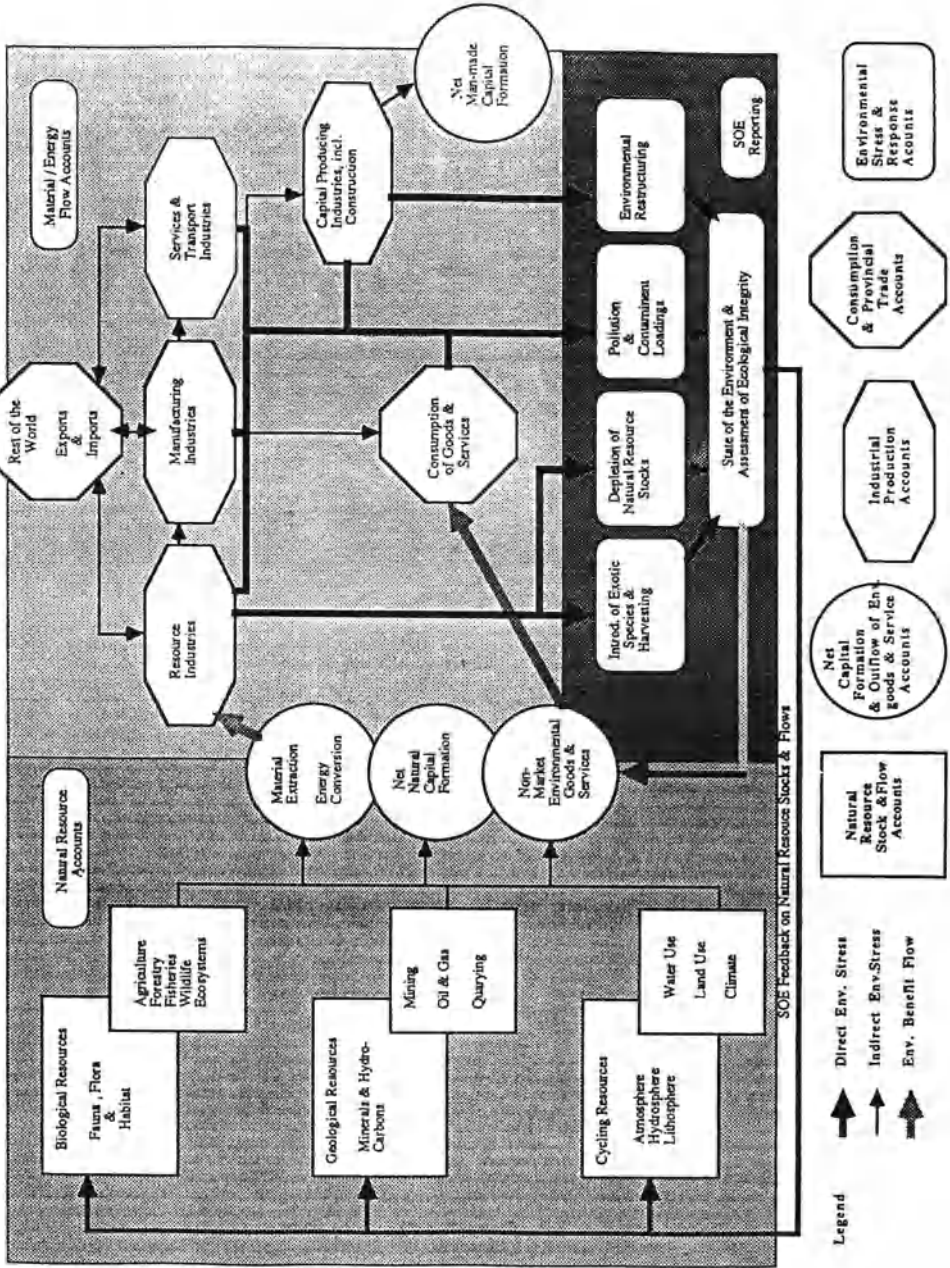

defined by national boundaries, the export and imports of materials and energy is also accounted for in this system.

The generation of waste residuals are tracked from sources in production/consumption processes to deposition in air, water, and land. Thus, MEBSS, when suitably expanded, can account for the linkages of environmental pollution loadings with the level and structure of the economy. While the system was rejected as an approach for developing environment statistics, being too complex, and perhaps too demanding on data needs, it remained an attractive conceptual framework for the development of natural resource accounting. The Norwegian, French and Canadian approaches to natural resource accounting were influenced by MEBSS in subsequent developmental work. With an increasing interest in implementing sustainable development policies it can only be a matter of time before MEBSS is rediscovered.

Natural Resource Accounts (NRA) are part of a broadly based material-energy balance information system. NRA, however, focuses on depletion, replacement, and maintenance of "in-place" natural resources as opposed to the "throughput" of material-energy in the economy. This distinction should not be overdrawn since the two are intimately connected. Reduction in material/energy throughput is a major policy objective in conservation and protection of natural resources.

A review of world-wide activity in environmental accounting reveals different approaches and considerable confusion, about what should be covered under the rubric of NRA (Peskin 1990). In some cases NRA are viewed as extensions and/or modifications of the SNA. A perspective that defines natural resources in economic terms for the purpose of integrating resources into the economic production system. Others see these accounts as broadly based, multi-purpose information systems depicting the quantitative/spatial distribution of natural resource stocks and flows. In the latter case the main objective is to design a relevant information system for macro-level management of the nation's ecological assets. This call for an accounting system which not only records the economic variables but also describes quantitative values to the ecological and social functions of natural resources, such as wildlife habitat or tribal hunting grounds.

While the interest of the economic constituency is in the development of NRA as a framework to assess sustainable development, the environmental constituency is concerned about public accountability with respect to the use and the qualitative state of natural resources. **Figure 1** shows how both interests are accommodated by linking the extraction and harvesting of natural resources (i.e., energy/material flows in the economic production system) with the state of the environment. Further distinctions arise from alternative approaches to indicators of economic

performance and efficiency. A means, moreover, of revealing incompatibilities in national socio-economic objectives, such as assessing economic performance directed, on the one hand, at international competitiveness and growth and, on the other, at conservation and sustainable development.

The desire for monetary evaluation of natural resources stem, in part, from the mistaken belief that political commitment towards a more enlightened resource management agenda requires a demonstration that the "monetary values" assigned to social costs are greater than economic benefits. Public opinion polls, however, show that economic trade-offs are not necessarily a factor in peoples' evaluations of priorities for nature conservation or environmental quality.<sup>5</sup> It is noteworthy that the French *Compte du patrimoine naturel* recognises the essential economic bias in these accounts and has consciously counter-balanced this by providing for (non-monetary) social and ecological "functional values" (Weber, 1986).

State-of-Environment (SOE) Reporting has by now a well-established technique for macro-level assessments of environmental conditions and trends. This work is supported by a growing body of environmental statistics and indicators linking human activities with the physical state of the environment. While one can see many parallels between economic and environmental accounting, there are also many differences. These become evident when one considers the vastly different time scale of environmental transformation compared to the monthly, quarterly and annual indicators of economic trends. Moreover, data obtained from environmental monitoring are unique to time and space and therefore do not always assume the normal distribution of statistical aggregates.

In spite of the complexity of integration of human activity and environmental change, the underlying logic in systems analytic techniques provides the basis for the linkage of environmental and socio-economic databases. The schematic **Figures 1 & 2** illustrate the linkage parameters between SOE Reporting, natural resource accounting, material-energy balances and the income/expenditure accounts of the SNA. What is required now are policies aimed at the development of complementarity and compatibility in the vast national data collection programmes currently carried out in the field of natural resources, environmental monitoring and socio-economic surveys (Friend, Rapport, 1991). A

---

<sup>5</sup> A recent opinion poll taken in Canada had rated employment as the prime concern but when asked if environmental standards should be reduced in order to create more work, the respondents overwhelming rejected this proposal. It should be noted that this poll was taken when Canada was entering an economic recession and environment had dropped from first to second place in the order of national concerns.

**FIGURE 2. Linkage of Databases and a Pluralistic Approach to National Accounting**

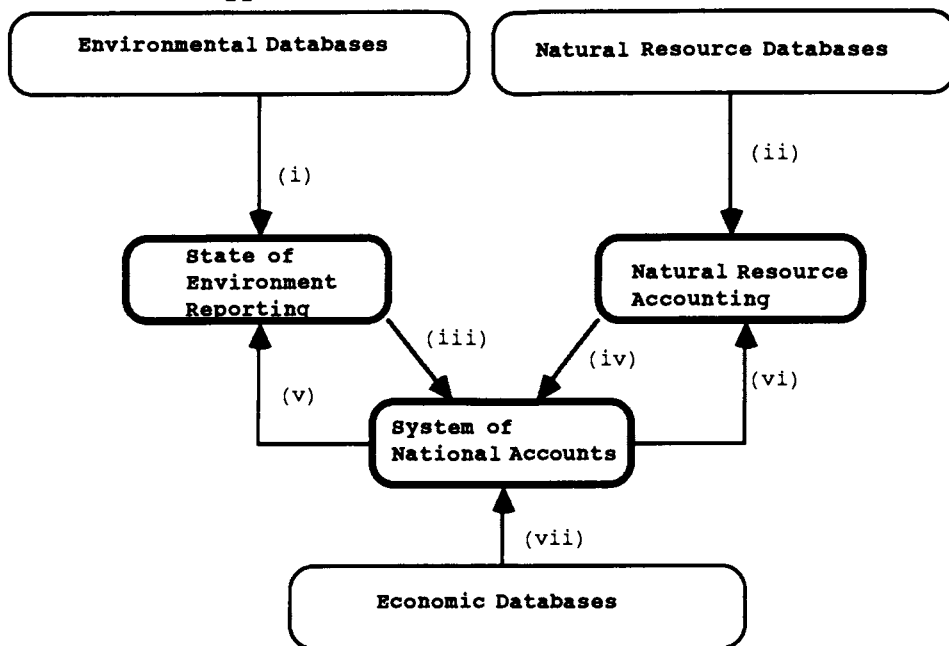

### Linkage Parameters

- (i) Indicators of environmental quality and ecosystem health.
- (ii) Physical stock and flow of natural resources.
- (iii) Economic value of environmental goods and services.
- (iv) Economic value of natural resource stocks (i.e., wealth) and flows (i.e., resource inputs in production).
- (v) Environmental (defensive) expenditures.
- (vi) Cost of maintenance of natural resource stocks.
- (vii) Goods and services produced in the economy.

pluralistic approach to National Accounting Systems provides, in fact, a formal framework for the integration of these databases.

Public policies aimed at internalising externalities and conserving materials and energy do, indeed, recognise the reality of complex interactions between environment and economy. The responsibilities, however, for management of the economy, the environment, and natural resources, are spread among different government agencies. Therefore, one can hardly be surprised that governments pursue inconsistent policies. A pluralistic approach to national accounting should not be viewed as a panacea for purging inconsistency from the national agenda, although an integrated framework encompassing the SNA, MEBSS, NRA, and SOE Reporting might help to reveal them.

### Conclusion

Pluralism in national accounting may be considered a *sine qua non* for good decision-making in a complex world of environmental threats and the pervasive influence of the global economy. This paper argues for environmental and natural resource accounting to be regarded as an integral component of the SNA. These would be composed of physical databases describing material-energy stock/flow balances, natural resource accounts, and state of the environment reports. The last differs in that national aggregates are absent. Nonetheless, SOE reporting is included because of its capacity to link the economy and the environment and provides the relevant spatial indicators for assessing ecosystem integrity.

A world of over-employed natural resources, threats to the integrity of ecosystems, and globalization of national economies, raises the question of the compatibility of a national accounting system based on 1930s model of the economy underpinned by values reflecting the experience of the Great Depression. This paper contends that emerging social values emanating from the environmental movement and desires for sustainable development have subordinated the single-purpose growth objective symbolized by the GNP. The proposals in the revised SNA to accommodate the social values of the 1990s by including environmental degradation and resource depletion is not only insufficient, but could prove highly controversial when justifying a particular evaluation methodology; whose discount rate? Physical measures of natural resource stocks and flows are the relevant indicators for assessing sustainable development and the impact of the economy with the state of the environment.

This paper further contends that sustainable development demand a broader economic and social measure of human well-being than is currently contained in the concept of GNP. In the future greater emphasis will be placed on the durability and material-energy efficiency in production and consumption processes. Thus, focussing on the concept

of income as a flow of services derived from stocks as opposed to income generated from the employment of the factors of production. Indeed, we may say that sustainable development policies imply the reorientation of the current flow management economy towards a stock management economy. Finally, pluralism in national accounting does not imply the demise of the SNA but rather its enhancement by explicitly recognising multi-dimensional perspective of social, ecological and ethical values in the measurement of the *national product*.

#### References:

- Ayers, R.U., Kneese, A.V. 1969. "Production, consumption, and externalities," American Economic Review. pp 282-297.
- Bartelmus, P. Stahmer, C and Van Tongeren, J. 1989. "SNA Framework for Integrated Environmental and Economic Accounting". Paper presented at the IARIW Meeting, Lahnstein, W.Germany, August 1989. (in ms)
- Boulding, K.E. 1949. "Income or Wealth", Review of Economic Studies., 17. pp. 77-86.
- Daly, H.E., and Cobb, J.B.1989. For the Common Good. Beacon Press, Boston.
- Fisher, I., 1906. The Nature of Capital and Income. Macmillan, New York.
- Friend, A.M. 1981. "Conceptual Framework and a Unified Approach to Environmental Statistics", Canadian Statistical Review, October, Ottawa.
- Friend, A.M., Rapport, D.J., 1991. "Evolution of macro-information systems for sustainable development", Ecological Economics, 3. pp. 59-76.
- Friend, A.M., 1989. "UNEP/World Bank expert meeting on environmental accounting and the SNA, Paris, 21-22 November 1988." Ecological Economics,1. pp. 283-285.
- Huetting, R. 1980. New Scarcity and Economic Growth, (trans. Preston, T.) North Holland, Amsterdam.
- Kuhn, T.S. 1970. The Structure of Scientific Revolutions. University of Chicago Press, Chicago.
- Kuznets, S. 1952. "Government Product and National Income", Income and Wealth Series 1, pp. 193-194, Bowes and Bowes, Cambridge.
- Martinez-Alier, J. 1987. Ecological Economics. Basil Blackwell, Oxford, UK.



- Miller, R.W. 1987. Fact and Method. Princeton University Press, Princeton.
- Myrdal, G. 1973. Against the Stream, Pantheon Books, New York.
- Naess, A., 1989. Ecology, community and lifestyle, Translated and edited by David Rothenberg, Cambridge University Press, Cambridge.
- Norgaard, R.B., 1989. "The case for methodological pluralism". Ecological Economics, 1:37-57.
- Peskin, H. 1990. "A Survey of Resource and Environmental Accounting Practices in Industrialized Countries", Draft Report for the World Bank, (in ms.).
- Polanyi, K. 1944. The Great Transformation. Boston, Beacon Press.
- Ricoeur, P. 1981. Hermeneutics and the Human Sciences, (trans. Thomson, J.B.), Cambridge University Press. Cambridge, U.K.
- Prigogine, I. Stengers, I. 1984. Order Out of Chaos. Bantam Books, New York.
- Robinson, J. 1962. Economic Philosophy, Penguin Books, Harmondsworth, U.K.
- United Nations, 1976. "Draft Guidelines for Statistics on Material/Energy Balances. E/CN.3/492. 29 March (Authored by R.U. Ayers).
- Weber, J.L. 1986. "Le patrimoine naturel", Les Compte du Patrimoine Naturel, des Collection de l'INSEE, série 137-138, décembre. pp 35-62.

## **NATURAL RESOURCE ACCOUNTING: SOME AUSTRALIAN EXPERIENCES AND OBSERVATIONS**

**Mike D. YOUNG**

CSIRO Division of Wildlife and Ecology  
Canberra, Australia

### **INTRODUCTION**

Within Australia, the environment is high on the political agenda and natural resource accounting is an idea that has political attention. The country is in the process of setting up a new Federal Environmental Protection Agency and our national statistical agency has just established a new environment section. Australia is mid-way through a major review of national policy changes necessary to promote ecologically sustainable development. Natural resource accounting has been identified as one of the 15 cross-sectoral issues for examination.<sup>1)</sup>

Within Australia, natural resource accounting has been interpreted to mean a number of different things. Somewhat arbitrarily, all these different interpretations can be grouped into four broad categories:

- . modifications to the national accounts so that they include environmental considerations and more accurately describe changes in national income;
- . a variety of satellite accounting systems that account for changes in the value of natural resources and the environment;

---

1) For review purposes the Australian economy has been divided into 9 sectors - agriculture, forest use, fisheries, mining, manufacturing, energy production, energy use, tourism and transport - and a working group appointed to review each sector. Each working group comprises approximately 15 representatives from government, industry, conservation, union and consumer groups. To improve co-ordination only three chairmen have been appointed. Each of these chairmen chair three working groups and at the completion of the process will produce a chairmen's report on cross-sectoral issues.

- . physical or environmental accounting systems that bring together large amounts of environmental data into a coherent framework; and
- . geographic information system (GIS)-based accounting systems that have both a spatial and temporal dimension, and organise physical data into an economic framework that is relevant to decision making.

All these different systems have much in common. Fully-developed natural resource accounting systems are rare and most of the work that has been done is of a theoretical nature. One could also observe that, as yet, none of the above systems have had much influence on natural resource management, nor the management of the Australian economy. This does not mean that they will not have a major impact in the future. It does, however, emphasize that, at least within Australia, natural resource accounting is still in its infancy.

Some people are also becoming increasingly disillusioned with the idea. They perceive that changing national accounting systems is a very indirect way of changing the policies that cause environmental problems. Many would simply prefer to change the policies. There is also considerable confusion about the information contained in Australia's national accounts. Those who are informed understand that GDP, as presently measured, reports changes in the volume of economic activity. Unfortunately, many other people mis-interpret GDP as an index of national welfare.

### **AUSTRALIAN PERSPECTIVES**

As a result of the above developments a number of people have begun to express a wide range of views about natural resource accounting. The most significant of these are that:

- there is a case for modifying Australia's national accounting system but that it is wiser to wait for further research and debate to indicate how this should be done (Australian Bureau of Statistics 1990);
- modifying the national accounts is not a necessary condition for sustainable development and may even be counter-productive as
  - . there is a lack of any clear relationship with sustainability objectives,
  - . existing national economic-modelling systems fail to recognise sustainability constraints, and

- national accounts adopt market values rather than values that recognise social costs and benefits (Common 1990);
- improving Australia's national accounting system may be a very indirect way to force the policy changes necessary to promote sustainable development;
- there is a need for the regular release of a coherent set of environmental, economic and social indicators of sustainability (Odgers 1991); and
- the data which feeds into any national accounting system must be organised so that the system helps to improve policy analysis as well as providing commentators with an overview of the economy (Young 1990).

### **EXTENDING AUSTRALIA'S NATIONAL ACCOUNTING SYSTEM**

Brushing aside the important debate about which national accounting approach is more appropriate, I would like to focus upon the likely policy impacts of modifying Australia's national accounts so that revenue obtained through resource depletion or environmental degradation is capital depreciation, rather than income. This is dangerous as much of the data is of very poor quality. Take soil erosion for example. As far as I am aware no-one has ever tried to estimate the annual rate at which soil erosion is occurring throughout Australia. The best we have is an assessment of the extent to soil erosion and the cost of restoring land to its pre-European condition some 200 years ago (Woods 1982).

Table 1 details the assumptions that are made in order to estimate the annual costs of environmental degradation and changes in the value of mineral and petroleum stocks. In cases of doubt, estimates have been biased to increase the magnitude of the modification to be made. Many of the estimates may be over estimates and, hence, the approach is described as "environmentally generous". Figure 1 summarises the resulting information. The methodology is similar to that developed by Repetto *et al* (1989) for Indonesia. Note that methodology is a partial one: noise, congestion, landscape amenity and many quality of life considerations are ignored.

The answer for environmentalists, who perceive that Australia's environment and its landscape have been poorly managed over the previous decade, is not very pleasing. In the context of the national economic management, environmental considerations appear irrelevant. Australia has an urban, not a renewable-resource based economy. In 1950-51 farming, forestry, fishing and hunting accounted for 26.1% of GDP but by

1987-88 it had declined to only 4.5% of GDP. The story for exports is similar. In 1950-51 farming, fishing and forestry accounted for 85.7% of the value of exports, today they account for 29.5%.

The bottom line is that correcting for renewable-resource depletion and environmental degradation in the accounts of a developed economy that only employs 5.7% of its work force in its renewable-resource sectors, is not likely to change the economic signals that are used to judge how well the Australian government has been managing the economy. **If one wishes to improve resource management within Australia, much more than a simple correction of the national accounts is needed.**

Thus, in national terms, the costs of existing environmental degradation appear trivial in comparison with the value of final goods and services produced throughout Australia. The converse, however, is not necessarily true. The benefits of stopping degradation and improving environmental quality may be substantial. Its just that partially "fixing up" Australia's quarterly estimate of GDP will not show how much pollution and land degradation is costing Australia. **Extension to include non-market transactions and the development of regional and sector based accounts is necessary.** Following on from this, it would also be necessary to develop models that estimate the nature of the social and economic benefits of environmental improvement. Organising the existing data into a coherent accounting framework is a necessary precondition for improved environmental policy but it is not a sufficient one.

Incorporating changes in the value of mineral deposits is a different matter. If one accepts the idea that there should be symmetry between capital and income accounts then increases in the value of mineral stocks should be treated as income that is invested rather than consumed. Over the last decade, changes in the value of Australia's mineral resources have swamped all environmental considerations. One can only speculate as to the reason why such accounts are not kept. Depending on one's point of view, they give a very different picture of changes in national welfare. In 1987, for example, the value of mineral stocks appear to have jumped by \$43 billion and led to a 50% increase in GDP adjusted for changes in mineral and petroleum stocks, resource depletion and environmental degradation.

One final observation needs to be made. **Simply deciding to report GDP per capita rather than GDP gives a very different perspective on national welfare.** Australia's population is increasing at roughly 2% per annum. Metaphorically

speaking this means that the yeast in the national cake must keep on rising by 2% per annum so that all Australians remain as well off as they were in the previous year (see Figure 1c). Population and immigration policies appear vital to our future. If nothing else, the Australian Bureau of Statistics and our national media could begin to make changes in GDP per capita the prime focus of political attention.

A better approach, however, might be to develop a reliable and meaningful index of national welfare along the lines that have been suggested by Daly and Cobb (1989) or, following Pigou's original suggestion, develop separate indices of gross national benefits and costs and then try to maximise net benefits. Accounts of this nature are appropriately viewed as umbrella accounts that assemble information contained within national economic accounts, the satellite accounts that feed into them, and other indices of national welfare like indices of unemployment health and so forth. Perceptions of the nature of opportunities for economic development (and growth) might then change radically.

In summary, the conclusion from the above analysis is that simple environment-driven modifications to Australia's national accounting system are unlikely to change the way Australia manages its economy. Greater returns are much more likely from firstly, the collection of improved data; secondly, its efficient organisation and presentation in frameworks that recognise national economic objectives; and finally, its incorporation into models that account for changes in national welfare and recognise sustainability constraints. This last point is important. It is possible, some would say likely, that stricter pollution control policies; greater attention to the costs of soil erosion; and more habitat conservation could bring about a significant increase in the rate of growth in economic welfare. These benefits, however, will come from the multiplier effects of more socially efficient resource use and development policies, not a modified accounting system.

### **GIS-BASED NATURAL RESOURCE ACCOUNTING**

Any successful set of natural resource accounts (NRA) must accurately describe the interaction between the environment, natural resources and land use. Conceptually, it is now possible to combine physical and economic data within geographic information systems and produce maps of the annual costs and benefits of all land use within a region. Within the CSIRO Division of Wildlife and Ecology, we are trying

to develop such a system. The approach combines accounting and modelling technologies. For agriculture the maps would show

- . the value of agricultural production per annum;
- . less the cost of land degradation;
- . corrected for the off-site costs of salinity etc. imposed by other land holders;
- . less the cost of government subsidies and programs; and
- . plus a series of corrections to account for interactions with other sectors.

TABLE 1. AN ENVIRONMENTALLY-GENEROUS BACK OF THE ENVELOPE ESTIMATE OF THE LIKELY INFLUENCE OF ADDING RESOURCE DEGRADATION AND APPRECIATION ESTIMATES TO AUSTRALIA'S NATIONAL ACCOUNTS. SOME ESTIMATES MAY BE OUT BY SEVERAL 100%.

(All figures are in millions of 1985 Australian dollars. Those in brackets are negative.)

Year	GDP (Real 1985 Dollars)	Land degradation (On + Off farm)		Habitat Decline	GDP Corrected for Environment & Renewable Res.	Change in Mineral Stocks (Discoveries + price change- extraction)	GDP Corrected for Env. Ren. Res. & Mineral stocks	Population (Millions)
	(a)	Erosion (b)	Salinity (c)	(d)	(a-b-c-d) = (e)	(f)	(e + f) = (g)	(h)
1980	183,432	731	283	230	182,189	(21,842)	160,346	14.8
1981	189,130	1,058	285	230	187,557	3,544	191,101	14.9
1982	196,715	1,013	287	230	195,184	19,358	214,542	15.1
1983	190,244	2,461	290	230	187,263	9,702	196,966	15.4
1984	199,101	663	292	230	197,916	33,977	231,894	15.6
1985	214,270	820	297	230	212,923	9,700	222,623	15.8
1986	223,426	893	299	230	222,004	(41,175)	180,829	16.0
1987	229,585	788	301	230	228,265	43,071	271,337	16.3
1988	239,588	1,040	304	230	238,015	(1,762)	236,253	16.5
1989	247,849	1,325	306	230	245,988	na	na	16.8

(a) Commodity Statistical Bulletin, 1989, Australian Bureau of Agricultural and Resource Economics, Canberra.

(b) On-site productivity losses are guessed to average \$5,000 per farm across Australia's 126,500 farms that produce more than \$20,000 per annum. Off-farm costs are assumed to be 50% of productivity losses. Productivity and off-farm costs are then weighted by the inverse of Australia's annual wheat yield (tonnes per hectare) on the assumption that land degradation is higher in years of low rainfall.

(c) We guess that irrigation and dryland salinity reduces the value of farm land by 90 million dollars per annum and increases household costs for non-farm people by \$2 per person per week in two major cities.

(d) This is a very imprecise but environmentally-generous estimate. We have taken the greatest of all the estimates that we could find and assume that native forests are being cleared at a rate of 230,000 hectares per annum. It is assumed that the mean habitat value of this land is \$1000 per hectare.

(e) This is like an NDP but, as the depreciation for man-made capital items has not been subtracted, it would be deceptive to call it an NDP.

(f) Economically demonstrated resources. Discoveries that are economic to mine, plus stock revisions due to new technology, information etc, less extractions during the previous 12 months. The data are incomplete and derived from a variety of sources. The value of each mineral stock was obtained by multiplying the physical quantity of each resource by 20% of the ex-mine price per ton. The assumed 20% of ex-mine value guesstimate was derived by asking people what they thought average rent across all Australia's mineral resources was. Royalties are usually in the vicinity of 0.5% to 10%.



**Figure 1a Real GDP adjusted for some renewable resource depletion. The bars sum to real GDP as in column (a) in Table 1**

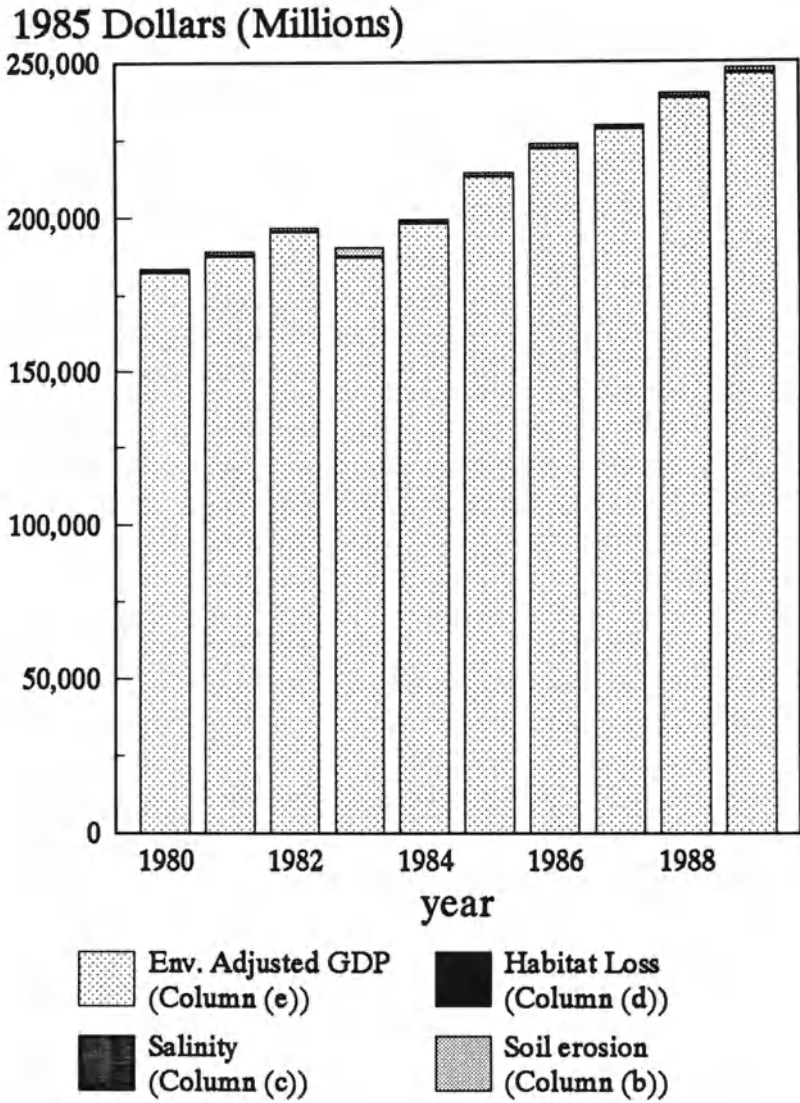

Figure 1b Real GDP adjusted for some renewable resource depletion and some changes in the value of mineral stocks (Column (g)) in Table 1

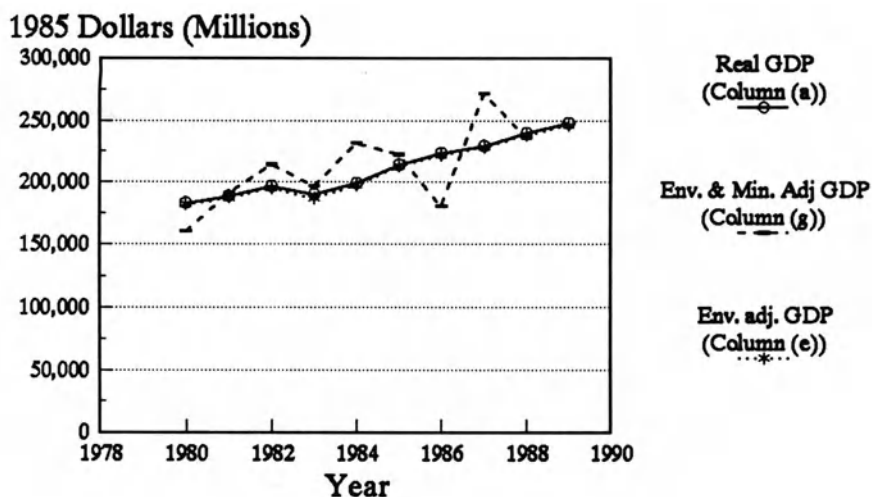

Figure 1c The effect of reporting various estimates of GDP on a per capita basis

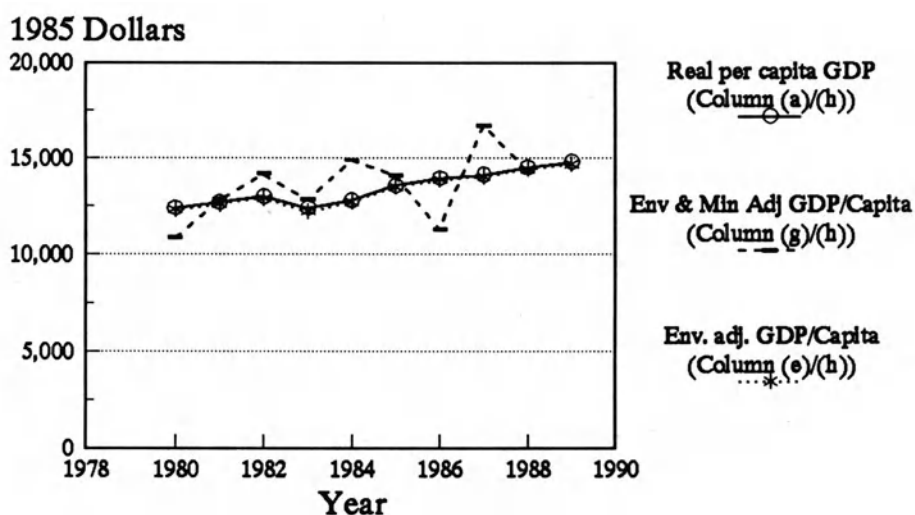

Table 2 and Figure 2 indicate the nature of the conceptual framework we are developing. Two conceptual innovations are involved:

- a) If one is serious about modelling linkages between the environment and the economy, it is necessary to dis-aggregate economic data to the scale at which most ecological models operate; and
- b) By taking an accounting approach which adds and subtracts existing and derived data together, the entire system can be kept relatively simple and most of the cumulative errors common to pure modelling systems avoided.

To date we have struck two problems with the development of this system. The first is that much environment and resource data tends to be inconsistent across large areas and inconsistent with other data sets. Considerable work is required to transform these data into consistent spatial and temporal databases. This is expensive and time consuming. We now recognise that in order to model interfaces between the economy and the environment, economic data must be geo-coded. The second problem is one that has surprised us. In a number of areas we have found quite strong resistance to the entire concept. Land administrators and resource managers appear to be frightened by the prospect of accounting systems that might highlight the effectiveness of their programs and policies. They seem to prefer systems that indicate the general but not the specific locational impacts of "their" policies.

Another advantage of the GIS-based natural resource accounting approach is its power to assist with policy analysis. The system we are trying to develop is driven by production data distributed across a series of maps of soil type, land use etc. Estimates of annual rates of land degradation etc. are then derived from the data that underlie these maps. Thus it should be possible to take output from a general equilibrium model and then use the accounting system to predict the spatial impacts of a proposed policy change.

TABLE 2

**CONCEPTUAL FRAMEWORK FOR NRA ACCOUNTS THAT DESCRIBE THE COSTS AND BENEFITS OF AGRICULTURAL LAND USE IN THE MURRAY-DARLING BASIN**

(The numbers are in thousands of dollars and are for a hypothetical GIS cell about the size of one farm. By re-allocating ABS production data to soil type, land-use etc and then combining these data with models that predict rates of soil loss etc. it is possible to produce maps showing each of the variables listed below. The spatial impact of various policies and programs could then be assessed and subsequent ones more effectively targeted. As the framework explicitly links ecological, environmental and economic production data, efficient analysis of trade-offs between conservation and production values is also possible.)

<u>CONVENTIONAL ACCOUNTS</u>			
Farm cash receipts			100
less: Intermediate goods & services purchased			<u>70</u>
NET AGRICULTURAL CASH OPERATING SURPLUS			30
Plus: change in farm inventory, including land		10	
Less: depreciation of Farm buildings and equip.		<u>4</u>	<u>6</u>
CONVENTIONAL NET AGRICULTURAL INCOME			36
<u>NATURAL RESOURCE MODIFICATIONS</u>			
LESS DEGRADATION associated with land use within cell			
Soil sediment		1	
Irrigation salinity		1	
Dryland salinity		8	
Soil fertility		3	
Soil acidity		0	
Soil structure decline & compaction		0	
Waterlogging		1	
Shrub invasion		<u>0</u>	<u>14</u>
NET AGRICULTURAL INCOME corrected for degradation			22
CORRECT FOR OFF SITE COSTS			
Less: Net off-site effects (transfers back from other cells)			
Irrigation salinity			
Agriculture	9		
Other sectors	<u>3</u>	12	
Dryland salinity			
Agriculture	2		
Other sectors	<u>1</u>	3	
Soil erosion			
Agriculture	-1		
Other sectors	<u>2</u>	1	
Other			
		<u>2</u>	<u>18</u>
Add back degradation induced by other farms and sectors			4
Other cells			
Agriculture	10		
Other sectors	<u>3</u>	13	
This cell but other sectors			
		<u>1</u>	<u>14</u>
ENVIRONMENTALLY CORRECTED NET AGRICULTURAL INCOME			18
ADD EFFECTS OF GOVT. AGRIC. PROGRAMS AND POLICIES			
Plus: indirect farm taxes			20
Less: farm subsidies			
water delivery	3		
water infra-structure	20		
other	<u>5</u>	28	<u>-8</u>
REAL NET AGRICULTURAL PRODUCT			10
ADD NET CHANGE IN OTHER RESOURCE VALUES			
Agricultural assets			1
Non-agricultural assets			
Timber production	-1		
Conservation (?)	<u>-1</u>	<u>-2</u>	<u>-1</u>
REAL NET SOCIAL PRODUCT FROM AGRICULTURAL SECTOR WITHIN CELL			<u>9</u>

**Figure 2** Conceptual framework for a GIS-Based natural resource accounting system

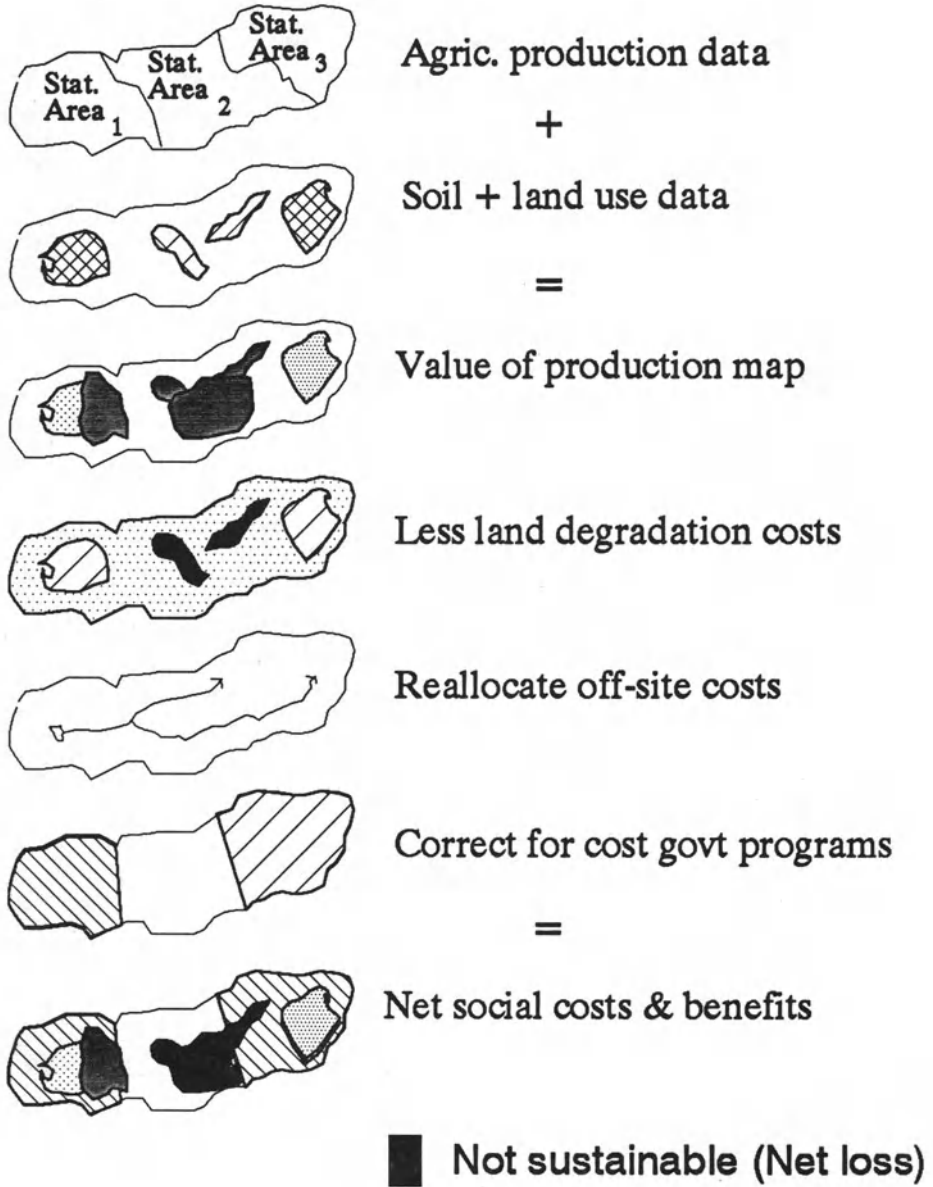

Perhaps we should also observe that in the process we build a structure which resembles an input-output system which contains resource and environment sectors and thousands of regions. Moreover, because the system retains a geographic focus and links to renewable-resource data bases, it is possible to use the accounting system to estimate switching values and, hence, identify trade-offs between production and unpriced conservation objectives. Most data that describes the distribution and abundance of species, vegetation alliances, ecosystems etc. have already been geo-coded. This means that a GIS-based accounting system could be used to quickly answer a question such as: "How much land has to be taken out of agricultural production in order to preserve 5% of all Australian ecosystems?" The system could also be used to target conservation programs with much greater precision and less cost.

## **CONCLUDING COMMENTS**

This paper has touched upon several different types of natural resource accounting from the perspective of a developed economy where most people live within a city. Perhaps the most important observation is that **In a developed economy with a large service sector, extension of national accounting systems to include more information about renewable resources and its environment is unlikely to improve environmental quality, nor the management of the economy.** Indeed, there is a risk that resource-modified accounting systems may develop a false sense of policy security by implying that all the environmental problems faced by the nation are being adequately dealt with when, in fact, most of the impacts of these problems fall outside the market and near-market boundaries of the national accounting system used to report on the status of the economy.

A second observation is that if one defines changes in the value of capital assets as income, changes in GDP lose their relationship with the impact of short-term economic policies.

Thirdly, it must be recognised that national accounting systems are largely reports to shareholders, which give a very biased and incomplete picture of national welfare, and are not very useful for management purposes. In the short term, greater progress could be made through

- the periodic release of a set of indicators of the per capita welfare, economic performance, and environment quality in a coupled "umbrella" accounting system;
- the development of the analytical systems, models and data bases necessary for people to understand the complex linkages between the environment and the economy; and
- the use of these systems to demonstrate the benefits and costs of alternative policy options and to enable natural resource managers to implement resource policies with greater precision.

At the same time and, hopefully in parallel with it, others should begin to develop reporting systems that will enable countries to determine how well their policies are promoting sustainable development and where and how they could do better.

## **REFERENCES**

Australian Bureau of Statistics (1990a) "Natural Resource and Environmental Accounting in the National Accounts" In "Australian national accounts; National Income and Expenditure Catalogue 5206.0, Canberra.

Australian Environment Council (1988) *Report on natural resource accounting*. Canberra.

Common, M. (1990) "Natural resource accounting and sustainability." Unpublished paper presented to a joint Centre for Economic Policy Research/Resource Assessment Commission Conference on the Economics of Environmental Policy, Canberra.

Common, M. (1991) "Natural resource accounting and sustainability." Unpublished paper presented to an intersectoral working group on ecologically sustainable development, Canberra, May 1991.

Daly, H.E. and Cobb, J.B. Jr. (1989) *For the common good: redirecting the economy towards community, the environment and a sustainable future*. Beacon, Boston, 482pp.

Odgers, B. (1991) Environmental indicators and state of the environment reporting. Unpublished paper presented to an intersectoral working group on ecologically sustainable development, Canberra, May 1991.

Repetto, R., Magrath, W., Wells, M., Beer, C. and Rossini, F. (1989). *Wasting Assets: Natural resources in the national income accounts*. World Resources Institute, Washington.

Woods, L.E. (1983) *Land degradation in Australia*. AGPS, Canberra.

Young, M. D. (1990) "Natural resource accounting." In *Moving toward global sustainability: Policies and implications for Australia*. Australian National University, Canberra.

Young, M.D., Cocks, K.D. and Humphries, S.E. (1990) "Australia's environment and its natural resources: An outlook." CSIRO, Canberra.



# **MATERIALS/ENERGY FLOWS AND BALANCES AS A COMPONENT OF ENVIRONMENTAL STATISTICS**

**R. U. Ayres**

**Carnegie Mellon University**

## **0. INTRODUCTION**

The relevance of statistical work to the broader United Nations effort to address environmental concerns was recognized by the European Conference of Statisticians in 1970. A first paper was prepared and discussed at a meeting of experts in Geneva in 1973 [UN 73]; a follow-up paper was discussed at a seminar sponsored jointly by the Conference of European Statisticians and the Senior Advisors to ECE governments on Environmental Problems, in Warsaw [UN 73a]. At the Warsaw Seminar the following primary classification of elements of a system of environmental statistics was suggested:

1. Natural elements of the environment (atmosphere, hydrosphere, land surface and biosphere, lithosphere)
2. Man made elements of the environment (anthroposphere)
3. Pollutants and wastes
4. Biomes (ecological systems)
5. Natural disasters.

The outcome was a Report of the Secretary-General to the 18th session of the Statistical Commission, in Geneva, outlining a set of objectives and a phased program of work, including detailed study and definition of (i) the data, classifications and tabulations required for environmental monitoring, studies and policies, and (ii) the structure of the

system, its internal and external links, etc. [UN 74]. The proposed program was accepted by the Statistical Commission with the understanding that support for UNSO activities in this area would be underwritten by UNEP.

However, needed financial support was not forthcoming and work continued thereafter on a reduced basis. The potential use of materials/energy balances was described in a paper prepared for the 19th session of the Statistical Commission, held in New Delhi [UN 76a]. UNSO also supported work to reshape and update the many international statistics and accounts into a global System of Integrated Energy Statistics (SIES) [UN 76]. However, the original program was never implemented. In retrospect, it seems likely that this failure can be attributed to the lack of a clearly articulated need for the proposed statistical data and tabulations, in contrast to the situation with regard to the SNA [UN 69].

The SNA has been of value to government economists as a basic tool for macro-economic management at the national level. This is a central government function that has been accepted since the 1930's, at least. Until recently, at least, there has been no corresponding center of governmental responsibility for the environment in most countries. Hence the demand for a system of environmental and resource accounts (SERA) was weak and unfocused, at best.

Today, because of the increasingly acute environment crisis and, especially, the emergent conflict between environmental imperatives on the one hand, and development imperatives on the other -- as emphasized by the Report of the Brundtland Commission [Brundtland 87] -- the outlook for international support for SEEA is (ironically) somewhat better. The World Bank and UNEP have jointly sponsored workshops [Ahmad *et al* 90]; the World Bank has also sponsored continuing work [e.g. Peskin & Lutz 90]. UNSO is in the process of preparing a new draft SNA Handbook, to reflect the higher priority now attached to environmental concerns [Stahmer 90]. The conference of the IARIW (Baden, 27-29 May, 1991) was an outgrowth of the renewed interest in environmental accounting.

The real need for SEEA has been particularly underlined by a recent and continuing case study of Indonesia by the World Resources Institute [Repetto & Magrath 89]. This study makes the point very clearly that inappropriate accounting methodology can lead government decision-makers to counter-productive policies. In particular, the existing SNA takes credit for the value of exhaustible resources extracted and processed as a contribution to current national income, but fails to assign any corresponding capital asset value to

exhaustible resources. Hence extractive income is not balanced by a decline in the corresponding resource stock. This strange accounting blind spot results in consistent overstatement of the economic performance of resource-based economies, and thus tends to encourage further investment in extractive activities<sup>1</sup>.

Obviously the omission of extractive resource stocks from the capital accounts is not the only serious flaw in the SNA. The failure to include extractive resources as an asset is "balanced" by a similar failure to include environmental assimilative capacity as an exhaustible resource. Nor does the SNA allow for the negative value of environmental disservices (damage costs). In fact a complete review of the salient criticisms that have appeared in the literature would be extensive indeed. It will not be undertaken here.

It is the purpose of this paper to address a somewhat narrower topic, namely the need for supplementary statistics, linked to the SNA but based on physical data. There are a number of ways such a system might be structured. One proposal is illustrated in *Figure 1*. This paper will not address structural issues, however. It will focus, instead, on the uses of physical data in constructing aggregate measures (and trends) of the state of the environment.

To put this into perspective, recall that the most widespread use of the SNA is to compute a single aggregated surrogate measure of welfare, the GDP. Economic performance is normally measured in terms of derived measures such as labor and capital productivity, or total factor productivity. These measures have achieved such wide acceptance that they have a kind of independent life of their own. However, there is also a need for quantitative measures of environmental change and -- to the extent possible -- measures of the "distance" of the environment from a hypothetical state of long term sustainability. The nature of such an hypothetical measure is discussed next.

## 1. CONDITIONS AND MEASURES OF LONG TERM SUSTAINABILITY

The argument of this paper proceeds from several assumptions which must now be made explicit. In the first place, there is a considerable controversy over the appropriate definition

---

<sup>1</sup> Repetto has also shown that there is an analogy at the industrial level. For instance, if regulated public utilities were permitted (or required) to take explicit credit on the "bottom line" for benefits of pollutants not emitted as a result of their investment in pollution controls, their apparent economic performance would be improved significantly [Repetto 90].

of sustainability. There has been much academic debate on the exact meaning that should be ascribed to the term 'sustainability'. Repetto states that "current decisions should not impair the prospects for maintaining or improving future living standards" [Repetto 85 p.16]. The World Commission on Environment and Development suggests, in the same vein, that sustainable development "meets the needs of the present without compromising the ability of future generations to meet their own needs" [Brundtland 87]. The fundamental problem with such vague definitions is that they are inherently vague, non-operational and open to self-serving interpretations. They are also essentially incapable of objective verification.

Traditional SNA	Disaggregated Traditional SNA	Additional Physical Data	Additional data in Monetarized Terms
Traditional Flow and Asset Accounts	Environmental Protection Activities	Natural Resource Accounts	Depletion of Natural Resources
	Actual Damage Costs Caused by Environmental Deterioration	Residual Flow Accounts	Degradation of Environmental Media by Residuals
		Product Flow Accounts (Material/Energy Balances)	Comprehensive Damage Analysis

Figure 1. Satellite System on Environmental Accounting  
 Source: [Stahmer 90]

There is, in addition, a considerable disagreement with respect to the extent to which environmental assets can be sacrificed to economic objectives within the general criterion of sustainability. Most economists have tended to assume (at least implicitly) that all environmental and economic goods and services are effectively substitutable, and that economic measures of welfare (e.g. GNP) are sufficient<sup>2</sup>. For instance, Tietenberg suggests that sustainability means "future generations remain at least as well off as current generations", based (implicitly) on economic measures of welfare [Tietenberg 84 p.33]. In more formal language, the above formulation implies that sustainability means "non-declining utility".

<sup>2</sup>The inadequacy of GNP as a unique measure of social welfare is well known. However, most economists regard the omissions and double-countings as being sufficiently minor in quantitative importance to justify their continued neglect. However, the justifications for continuing to use the present version of GNP are much more robust in the context of making short-term performance comparisons than they are in the context of assessing long-term problems. This is one of the other reasons for restructuring the SNA and incorporating environmental elements explicitly.

However, the traditional approach, as noted above, assumes essentially complete substitutability of both inputs and outputs, at some price. In other words, it assumes that capital, labor, land and other environmental inputs are substitutable for each other effectively without limit [e.g. Dasgupta & Maler 90]. Similarly, it assumes that man-made goods and services are possible substitutes for environmental services.

Some economists have recently acknowledged what seems obvious to many non-economists: that man-made capital is not necessarily or always substitutable for natural capital. Nor can man-made services, regardless of price, always replace the services provided by nature [e.g. Ayres 78 p. 6]. Similar ideas have been articulated more recently. For instance, Solow proposed that "an appropriate stock of capital -- including the initial endowment of resources -- (be) maintained intact" [Solow 86]. This notion has been considerably expanded in recent writings by Pearce and his colleagues [Pearce 88; Barbier & Markandya 89; Pearce *et al* 89].

In this "ecological perspective", a separate and necessary (but not sufficient) condition for sustainability is the maintenance of an adequate "environmental resource endowment". This endowment constitutes the environmental assets necessary to provide needed and wanted environmental services. The most critical environmental services include the basic conditions of life-support on the earth, namely climate stabilization (temperature, rainfall, etc), food supply (the 'food chain'), and biological waste disposal and materials recycling. It is noteworthy that climate, the ozone layer, the carbon-oxygen cycle, the balance between alkalinity and acidity, mature forests, soil fertility and bio-diversity are not technologically replaceable by other forms of capital (nor are they repairable) to any meaningful degree, at least for the planet as a whole<sup>3</sup>.

I have argued elsewhere, and it will be assumed hereafter in this paper, that sustainability in the long run implies the achievement of several specific conditions, in addition to population stabilization [Ayres 91 AAAS]. These include:

---

<sup>3</sup> At first sight, the use of fertilizers and other technological inputs can be regarded as a partial substitute for soil fertility. However there is no known (or imaginable) way of removing toxic elements from soil or ground water on a large scale. Similarly, sewage and industrial wastewater treatment can provide 'clean' and relatively safe water for human consumption. However, such treatment generates sludges that are increasingly contaminated by viruses, toxic chemicals and heavy metals. No technology yet exists for permanently disposing such sludges in a safe manner.

1. No further (anthropogenic) change in the climate. This means no further accumulation of greenhouse gases in the atmosphere beyond some limit of safety (to be determined). An unavoidable implication is an end to fossil fuel use and an end to the general use of synthetic nitrogenous fertilizers and chlorofluorocarbons (CFC's).
2. No further net increase in the acidity (i.e. decrease in pH) of the environment, especially the fresh water lakes and rivers and forest soils, beyond some undetermined safety limit. This means imposing strict limits on levels of emissions of sulfur and nitrogen oxides (which tend to oxidize to the corresponding acids in the atmosphere), especially in regions where soils have little or no buffering capacity.
3. No further net accumulation of toxic heavy metals, radioactive isotopes, or long-lived halogenated chemicals in soils or sediments, beyond some undetermined safety limit. This implies an end to virtually all dissipative uses of scarce metals and most other extractive resources i.e. closing the materials cycle. It also implies a restriction on the use of synthetic chemical pesticides in agriculture.
4. No further net withdrawal of fossil groundwater.
5. No further net loss of topsoil by wind or water erosion, beyond the rate of natural soil formation. (This implies a radical change in agricultural practices, worldwide.)
6. No further net loss of estuarine zones, wetlands, old-growth forest or biological diversity, among other biological resources, beyond some (undetermined) limit of safety.

Measures of the extent to which conditions 4-6 are being met or violated clearly fit -- and probably belong -- in a supplement to an idealized SEEA. However, they will not be considered further in this paper, for lack of space. On the other hand, the first three conditions are undeniably central to economic accounting.

As indicated above, the first three listed conditions for sustainability essentially require the elimination of most non-renewable energy sources<sup>4</sup> and most dissipative uses of toxic heavy metals and halogens. Hence, the degree of economic dependence on non-renewables (mainly fossil fuels) is one key indicator of its "distance" from long-run sustainability. Another such measure is the efficiency with which the economic system recovers and reconditions used goods and recycles waste materials.

---

<sup>4</sup> This restriction may or may not apply to fission-based nuclear power, due its dependence on highly toxic and hazardous heavy metals, depending on whether the waste disposal problem can be solved in a satisfactory manner. The case of fusion power is difficult to evaluate at present.

There are only two possible long-run fates for waste materials: recycling and re-use or dissipative loss<sup>5</sup>. (This is a straightforward implication of the law of conservation of mass). The more materials are recycled, the less will be dissipated into the environment, and vice versa. Dissipative losses must be made up by replacement from virgin sources. A long-term sustainable state would be characterized by near-total recycling of intrinsically toxic or hazardous materials, as well as a significant degree of recycling of plastics, paper and other materials whose disposal constitutes an environmental problem. Heavy metals are among the materials that would have to be almost totally recycled to satisfy the sustainability criteria. The fraction of current metal supply needed to replace dissipative losses (i.e. production from virgin ores needed to maintain a stable level of consumption) is thus a plausible static measure of the absolute "distance" from a condition of long run sustainability.

It is also helpful for purposes of environmental management to have measures of change. Evidently a time series of static measures such as the above could serve this purpose. Aggregate national measures of energy and materials productivity (gross output, in value terms, per unit of physical input) -- such as the inverse of the well-known E/GDP measure -- are not reliable measures of progress, due to the confusion of technical improvements with structural changes. Specifically, some of the most energy-intensive processes in the industrial economy tend to be associated with the early stages of ore beneficiation and reduction. But, for obvious reasons, there is a strong economic incentive to carry out these processing stages as near as possible to the source of the raw material. As the best quality resources are exhausted in the industrialized countries, there is a tendency for such energy-intensive activities as primary steel, copper and aluminum, as well as petrochemicals production, to migrate "south". From a statistical perspective, this results in an apparent reduction in energy inputs per unit output in the "north" with a corresponding increase in the "south". However a shift of this sort does not signify any overall improvement. Therefore, a simpler set of productivity measures, based on economic statistics, has been suggested by Peter Fleissner and his colleagues<sup>6</sup>.

---

<sup>5</sup> The special case of indefinite storage in deep underground mines, wells or caverns, currently being considered for nuclear wastes, is not really applicable to industrial or consumer wastes except in very special and rare circumstances. Surface landfills, no matter how well designed, are hardly permanent repositories although little consideration has been given to the long run disposal of leachates.

<sup>6</sup> Personal communication, June 1991. Also, see Dell'mour et al, 1991 (this volume).

Increased output per unit input *within* a given industrial sector is much more significant than aggregate measures for the economy as a whole. While intrasectoral structural shifts can still confuse the interpretation, such shifts are considerably less significant in practice. Moreover, it is possible, with some effort, to derive measures of output per unit input using input-output methodology and underlying economic transactional data <sup>7</sup>. This approach deserves much greater attention than it has received to date.

To recapitulate the discussion above, one major objective of the new SEEA (or its satellites) should be to permit construction, at the national (or regional) level, of certain statistical measures of the long-term sustainability of sources of energy and metals, especially the toxic heavy metals. As will be demonstrated hereafter, some of the measures in question can be constructed from data that is already readily available in most OECD countries, and a number of others.

## 2. ENERGY SUSTAINABILITY MEASURES

Consider, first the case of energy. The starting point is the gross energy consumption data for non-renewables (coal, lignite, petroleum, gas) plus nuclear fuel. In the case of fossil fuels, data is normally given in terms of the energy (actually, heat of combustion) content of the fuel in convenient energy units. For nuclear fuel, however, only electric power actually generated is normally counted. This is misleading, of course, so the first adjustment that should be made is to calculate the nuclear heat generated (working back from known efficiency data) in the reactors. The sum total of non-renewable thermal inputs (NR) is the sum of the above components.

For renewables (R), the problem is more complicated by problems of incomparability. First of all, data on biomass (e.g. wood) burned for heating, cooking or electric power generation (e.g. in the paper industry) is not normally obtainable through the same administrative channels as data on fossil fuels. It must be obtained from special surveys or by indirect means. In the case of the U.S. this category was not separately included in official statistics between 1960 and 1975. However, it should be presented in terms of potential heat of combustion, as is the case with other fuels.

---

<sup>7</sup> This approach was pioneered by P. Becker. See [Becker 75, 76, 77].



In the case of hydro-electricity, as with nuclear electricity, only the electrical output is normally published. However, for consistency and comparability the potential energy theoretically available from the falling or moving water should be given. This can be done, at least approximately, by working back from outputs to inputs on the basis of known or estimated conversion efficiency data. In practice, however, it is more usual to assume that hydraulic energy conversion efficiency is the same as thermal energy conversion efficiency, and impute a hydraulic "equivalent" on that basis. The same thing can be done for wind power plants or geothermal power plants. It can also be done for photovoltaic cells.

The sum of all of these renewable inputs is  $R$ . The sum of  $R + NR$  is the total of all primary inputs  $T$ . One can also compute the sum of all primary inputs to electric power production. The fossil component is readily available in published statistics. The biomass, nuclear, hydro, wind and solar components have already been identified and estimated above. Let the sum of all such inputs be  $P$ .

It is now possible to derive three aggregate measures of interest. The first is the ratio of renewable primary energy sources  $R$  to total energy consumed  $T$ , by year. As noted above, this ratio is a measure of long-term sustainability. The higher the fraction of total energy inputs is obtained from renewable sources, the less traumatic and disruptive the conversion to totally renewable energy will be.

The second useful measure is the fraction  $P/T$  of primary energy resources being used to generate electricity. Since electricity is the most convenient form of energy, it is generally expected that this ratio will gradually increase over time (as it has already increased for a number of decades). The third useful measure is the efficiency of electric power generation. The sum of all electric power outputs is  $E$ . The ratio of  $E/P$  is the average aggregate efficiency of electricity production. This measure rose rapidly in the early years of this century, but it has levelled off in recent decades. This probably reflects the fact that thermal electric power generation is a mature technology, approaching its physical limits.<sup>8</sup>

---

<sup>8</sup> The apparent average efficiency of thermal electric power generation (around 34%) underestimates the actual thermodynamic efficiency currently being obtained, since it also reflects mechanical losses in the turbo-generators and resistance losses in the electric power distribution system. State of the art steam generators today achieve around 48% thermodynamic efficiency, which is very close to the theoretical maximum that can be achieved without raising the temperature of the steam. The latter would require new turbine blade materials that are not currently practicable. In short, further improvements in efficiency will be very costly.

Table I below shows U.S. energy data organized to produce the above measures. Table II exhibits the three derived measures. Thermal efficiency (E/P) is actually given in Table I, while R/T and P/T are calculated from the R, T and P rows of Table I.

<b>Table I:</b>						
<b>U.S. Energy Data Organized to Illustrate Sustainability Issues</b>						
<b>(units = quads)</b>						
<b>Year</b>	<b>1960</b>	<b>1970</b>	<b>1975</b>	<b>1980</b>	<b>1985</b>	<b>(e) 1988</b>
Coal & lignite	9.8	12.3	12.7	15.4	17.5	18.8
Petroleum	19.9	29.5	32.7	34.2	30.9	34.0
Natural gas	12.4	21.8	19.9	20.4	17.8	18.6
Nuclear heat (gross)	-	0.2	1.9	2.7	4.1	5.7
Total, non-renewable (NR)	42.1	63.8	67.2	72.7	70.3	77.1
Wood & biomass	(e) 2.0	(e) 2.0	2.0	2.5	2.6	2.5
Hydraulic work	1.7	2.7	3.2	3.1	3.4	2.6
Geothermal, wind, solar	-	-	0.1	0.1	0.2	0.3
Total, renewable (R)	(e) 3.7	(e) 4.7	(e) 5.3	5.7	6.2	5.4
T=R+NR	(e) 45.8	(e) 68.5	(e) 72.5	78.4	76.5	82.5
Thermal efficiency of electric generation (E/P)	31.7%	32.5%	32.8%	32.8%	33.0%	33.3%
Primary energy for electricity generation (P)	8.6	16.8	20.9	25.3	27.4	29.5

Source: [USDOE-EIA various years, Table 3]. Biomass use for earlier years estimated by author.

<b>Table II: Derived Measures of Sustainability</b>						
<b>Year</b>	<b>1960</b>	<b>1970</b>	<b>1975</b>	<b>1980</b>	<b>1985</b>	<b>(e) 1988</b>
Renewable fraction (R/T)	8.1%	6.9%	7.3%	7.3%	8.1%	6.5%
Primary electric fraction (P/T)	18.7%	24.5%	28.8%	32.3%	35.8%	35.8%
Thermal Efficiency (E/P)	31.7%	32.5%	32.8%	32.8%	33.0%	33.3%

### 3. MATERIALS SUSTAINABILITY MEASURES

Most past discussions of sustainability in regard to materials has focussed on availability. Data on several categories of reserves (economically recoverable, potential, etc.) is routinely gathered and published. However, as is well known, such figures are a very poor proxy for actual reserves. In most cases the actual reserves are much greater than the amounts actually documented. The reason, simply, is that most such data are extrapolated from test borings by mining or drilling firms. There is a well documented tendency for firms to stop searching for new ore bodies when their existing reserves exceed 20 to 25 years' supply. Only in the case of petroleum (which has been the subject of worldwide searches for many decades) is it possible to place much reliance on published data of this kind.

However, sustainability as discussed earlier in this paper, is less a question of resource availability than of recycling/re-use efficiency. As commented earlier, a good measure of unsustainability is dissipative usage. This raises the distinction between *inherently dissipative* uses and uses where the material could be recycled or re-used, in principle, but is not. The latter could be termed *potentially recyclable*. Thus, there are really three important cases: (1) uses that are economically and technologically compatible with recycling under present prices and regulations, (2) uses that are not economically compatible with recycling but where recycling is technically feasible e.g. if the collection problem were solved, and (3) uses where recycling is inherently not feasible. Admittedly there is some fuzziness in these classifications, but it should be possible for a group of international experts to arrive at some reconciliation.

Generally speaking, it is arguable that most structural metals and industrial catalysts are in the first category; other structural and packaging materials, as well as most refrigerants and solvents, fall into the second category. This leaves coatings, pigments, pesticides, herbicides, germicides, preservatives, flocculants, anti-freezes, explosives, propellants, fire retardants, reagents, detergents, fertilizers, fuels and lubricants in the third category. In fact, it is easy to verify that most chemical products belong in the third category, except those physically embodied in plastics, synthetic rubber or synthetic fibers.

From the standpoint of elements, if one traces the uses of materials from source to final sink, it can be seen that virtually all sulfur mined (or recovered from oil, gas or metallurgical refineries) is ultimately dissipated in use (e.g. as fertilizers or pigments) or

discarded, as waste acid or as ferric or calcium sulfites or sulfates. (Some of these sulfate wastes are classed as hazardous). Sulfur is mostly (75-80%) used, in the first place, to produce sulfuric acid, which in turn is used for many purposes. But in every chemical reaction the sulfur must be accounted for -- it must go somewhere. The laws of chemistry guarantee that reactions will tend to continue either until the most stable possible compound is formed or until an insoluble solid is formed. If the sulfur is not embodied in a "useful" product, it must end up in a waste stream.

There is only one 'long lived' structural material embodying sulfur: plaster-of-Paris (hydrated calcium sulfate) which is normally made directly from the natural mineral gypsum. In recent years, sulfur recovered from coal-burning power plants in Germany has been converted into synthetic gypsum and used for construction. However this rather obvious recycling loop is currently inhibited by the very low price of natural gypsum. Apart from synthetic gypsum, there are no other durable materials in which sulfur is actually physically embodied. It follows from materials balance considerations that sulfur is entirely dissipated into the environment. Globally, about 61.5 million metric tons of sulfur *qua* sulfur -- not including gypsum -- was produced in 1988, of which less than 2 million was recycled (mainly as waste sulfuric acid), as indicated schematically in *Figure 2*. Very little is currently used in building materials.

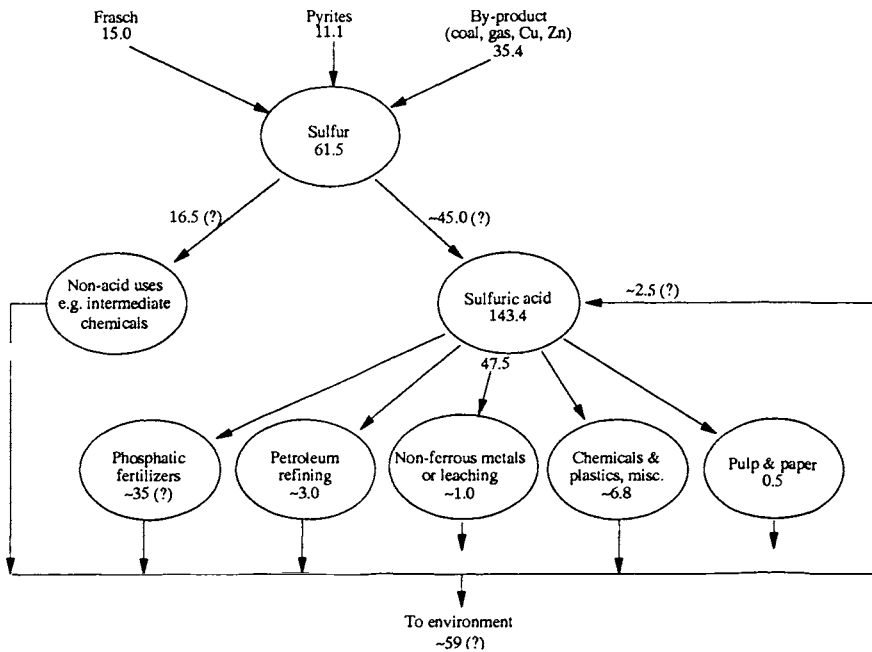

Figure 2. Dissipative Uses of Sulfur, 1988 (million metric tons)

Source: author [data from UN Industrial Statistics Yearbook, 1988]

Thus, most sulfur chemicals belong in class 3. Following similar logic, it is easy to demonstrate that the same is true of most chemicals derived from ammonia (fertilizers, explosives, acrylic fibers), phosphorus (fertilizers, pesticides, detergents, fire retardants). In the case of chlorine, there is a division between class 2 (solvents, PVC) and class 3 (hydrochloric acid, chlorine used in water treatment, etc.). Chlorofluorocarbon refrigerants and solvents are long lived and non-reactive. In fact, this is the reason they pose an environmental problem. Given an appropriate system for recovering and reconditioning old refrigerators and air-conditioners, the bulk of the refrigerants now in use could be recovered, either for re-use or destruction, so they belong in class 2. However CFC's used for foam-blowing are not recoverable. *Table III* shows world output of a number of materials -- mostly chemicals -- whose uses are, for the most part, inherently dissipative (class 3). It would be possible, with some research, to devise measures of the inherently dissipative uses of each element, along the lines sketched above. Sustainability, in the long run, would imply that such measures decline. Currently, they are probably increasing.

Table III

Production of (Selected) Dissipative Products (units = million metric tons except where indicated)		1979	1980	1981	1982	1983	1984	1985	1986	1987	1988
Chlorine		24.83	24.03	23.53	21.84	23.39	24.45	24.47	24.65	25.21	25.93
HCl		8.03	7.94	7.82	7.98	8.19	9.42	9.63	9.45	10.32	10.29
H <sub>2</sub> SO <sub>4</sub>		130.8	133.8	130.5	122.0	129.6	137.3	133.0	131.8	135.5	143.4
HNO <sub>3</sub>		27.59	27.69	27.70	25.93	26.22	28.11	28.23	27.50	28.16	27.18
H <sub>3</sub> PO <sub>4</sub>		15.71	17.00	16.45	15.31	17.48	19.35	18.19	21.72	22.87	23.93
Lead oxides		0.235	0.242	0.246	0.243	0.249	0.258	0.248	0.234	0.228	0.242
NH <sub>3</sub> , as 100%N		71.76	75.05	73.14	70.70	78.30	83.68	85.81	85.83	92.13	93.65
NaOH		31.95	31.41	30.45	29.17	30.85	32.97	33.27	33.80	35.53	35.79
Copper sulfate, CuSO <sub>4</sub> ·5H <sub>2</sub> O		0.146	0.147	0.133	0.124	0.119	0.124	0.127	0.120	0.120	0.114
Sodium bichromate as Cr <sub>2</sub> O <sub>3</sub>		0.258	0.242	0.250	0.260	0.255	0.250	0.251	0.269	0.263	0.263
Lithopone, ZnS		0.426	0.437	0.437	0.432	0.431	0.440	0.443	0.456	0.468	0.460
Zinc oxides		0.488	0.465	0.479	0.415	0.419	0.414	0.421	0.396	0.417	0.417
Insecticides, fungicides, etc.		3.09	3.11	3.06	3.09	3.08	3.15	2.97	2.91	2.83	2.93
Detergents		10.39	10.98	11.42	12.01	12.46	12.70	13.29	13.91	14.56	14.94
Soaps		6.88	7.28	7.54	7.46	7.81	7.96	8.50	8.68	9.02	8.95
Titanium oxide, TiO <sub>2</sub>		1.297	1.261	1.297	1.217	1.360	1.457	1.524	1.697	1.794	1.878
Carbon black, C		4.23	3.92	4.03	3.76	4.00	4.35	4.36	4.31	4.35	4.52
Aluminum sulfate, Al <sub>2</sub> (SO <sub>4</sub> ) <sub>3</sub> in terms of Al <sub>2</sub> O <sub>3</sub>		3.478	3.487	3.609	3.427	3.395	3.555	3.758	3.756	3.861	3.964
Soda ash, Na <sub>2</sub> CO <sub>3</sub>		25.57	25.90	25.67	24.89	26.66	27.56	27.55	28.04	29.92	29.91
Sodium silicate in terms of SiO <sub>2</sub>		2.25	1.90	1.90	1.76	1.70	1.75	1.79	1.90	2.13	2.03
Synthetic dyes		1.19	1.16	1.12	1.18	1.14	1.16	1.17	1.24	1.26	1.25
Activated carbon & mineral catalysis inc. diatomite, clay, etc.		0.71	0.79	0.65	0.64	0.67	0.73	0.78	0.79	0.78	0.75

Material	<i>Total Consumption (million short tons)</i>			<i>Percent of Total Consumption in Recycled Scrap</i>		
	1977	1982	1987	1977	1982	1987
Aluminum	6.49	5.94	6.90	24.1	33.3	29.6
Copper	2.95	2.64	3.15	39.2	48.0	39.9
Lead	1.58	1.22	1.27	44.4	47.0	54.6
Nickel	0.75	0.89	1.42	55.9	45.4	45.4
Steel/Iron	142.40	84.00	99.50	29.4	33.4	46.5
Zinc	1.10	0.78	1.05	20.9	24.1	17.7
Paper	60.00	61.00	76.20	24.3	24.5	25.8

*Source: Institute of Scrap Recycling Industries, Washington D.C. 1988*

With regard to materials that are potentially recyclable (classes 1 and 2) the fraction actually recycled is a useful measure of the approach toward (or away from) sustainability. A reasonable proxy for this, in the case of metals, is the ratio of secondary supply to total supply of final materials. This can be calculated from data in *Table IV* which shows, incidentally, that recycling ratio has been rising consistently in recent years only for the cases of lead and iron/steel. In the case of lead, the U.S. ban on using tetraethyl lead as a gasoline additive (an inherently dissipative use) is responsible. These data are not comparable (or even available) in all countries for every metal, but it should not be difficult to resolve the differences. Estimates compiled by industry sources are often more reliable than government data.

#### 4. CONCLUSIONS

Useful aggregate measures of the state of the environment *vis-a-vis* sustainability can be constructed from physical data that is already collected and compiled in many countries. To derive these aggregates and publish them annually would provide policy-makers with a valuable set of indicators at little cost.

It is clear that other interesting and useful measures based on physical data are possible. Moreover, if similar data were collected and published at the sectoral level, it would be possible to undertake more ambitious engineering-economic systems analyses and forecasts -- of the kind currently possible only for energy -- in the entire domain of "industrial metabolism".

## REFERENCES

- [Ahmad *et al* 90] Ahmad, Yussuf J., Saleh el-Sarafy & Ernst Lutz (eds), *Environmental Accounting for Sustainable Development*, World Bank, Washington DC, 1990.
- [Ayres 78] Ayres, Robert U., *Resources, Environment & Economics: Applications of the Materials/Energy Balance Principle*, John Wiley & Sons, New York, 1978.
- [Ayres AAAS 91] Ayres, Robert U., *Eco-restructuring: Managing the Transition to an Ecologically Sustainable Economy*, Humankind in Global Change Symposium, AAAS Annual Meeting, Washington DC, February 17-19, 1991. [Proceedings to be published.]
- [Barbier & Markandya 89] Barbier, Edward & Anil Markandya, "The Conditions for Achieving Environmentally Sustainable Development", (89-01), 1989.
- [Becker 75] Becker, Peer E., *Materials, Engineering & the Economy: An Input-Output Study of Technical Decisions in the U.K.* PhD Thesis, [University of Aston in Birmingham, Birmingham, UK], 1975.
- [Becker 76] Becker, Peer E., Title missing, *Resources Policy* 2, 1976 :193.
- [Becker 77] Becker, Peer E., "The Interdependence of Materials & Resources in the U.S. Economy", *Materials & Society* 1, 1977 :239-247.
- [Brundtland 87] Brundtland, G.H. (ed), *Our Common Future*, Oxford University Press, New York, 1987. [Report of the WCED]
- [Dasgupta & Maler 90] Dasgupta, Partha & Karl-Gorgan Maler, *The Environment & Emerging Development Issues*, Annual Conference on Development Economics, World Bank, Washington DC, April 1990.
- [Pearce 88] Pearce, David W., "Economics, Equity & Sustainable Development", *Futures* 20, December 1988 :598-605.
- [Pearce *et al* 89] Pearce, David W., Anil Markandya & Edward Barbier, *Blueprint for a Green Economy*, Earthscan, London, 1989.
- [Peskin & Lutz 90] Peskin, Henry M., with Ernst Lutz, *A Survey of Resource & Environmental Accounting in Industrialized Countries*, Environmental Working Paper 37, World Bank, Washington DC, August 1990.
- [Repetto 85] Repetto, Robert, *Natural Resource Accounting in a Resource-Based Economy: An Indonesian Case Study*, 3rd Environmental Accounting Workshop, UNEP & World Bank, Paris, October 1985.
- [Repetto 90] Repetto, Robert, *The Concept & Measurement of Environmental Productivity: An Exploratory Study of the Electric Power Industry*, Towards 2000: Environment, Technology & the New Century (Symposium), World Resources Institute & the OECD, Annapolis MD, June 199 [Background Paper]
- [Repetto & Magrath 89] Repetto, Robert & William D. Magrath, *Wasting Assets: Natural Resources in the National Income Accounts*, World Resources Institute, Washington DC, 1989.



[Solow 86] Solow, Robert M., "On the Intergenerational Allocation of Natural Resources", *Scandinavian Journal of Economics* **88**, 1986 :141-149.

[Stahmer 90] Stahmer, Carsten. "Towards Integrated Environmental & Economic Accounting", in: *SNA Handbook (Draft)*, Chapter 1, UNSO, New York, May 1990.

[Tietenberg 84] Tietenberg, Tom, *Environmental & Natural Resource Economics*, Scott, Foresman & Company, Glenview IL, 1984.

[UN 69] United Nations, *A System of National Accounts*, UN Document ST/STAT/Ser.F/2/Rev.3, United Nations, New York, November 1969.

[UN 73] United Nations, *Statistics for Environmental Studies & Policies*, UN Document CES/AC-40/2, United Nations, New York, February 13, 1973.

[UN-a 73] United Nations, *Steps Toward a System of Environmental Statistics*, UN Document CES/SEM 6/2 ENV/SEM 1/2, United Nations, New York, September 4, 1973.

[UN 74] Report of the Secretary General to the Statistical Commission, *Statistics of the Environment*, UN Document E/CN.3/452, United Nations, New York, June 14, 1974.

[UN 76] Report of the Secretary General to the Statistical Commission, *Economic Statistics, Energy Statistics, Towards a System of Integrated Energy Statistics*, UN Document E/CN.3/476, United Nations, New York, March 15, 1976.

[UN-a 76] Report of the Secretary General to the Statistical Commission, *Environmental Statistics. Draft Guidelines for Statistics on Materials/Energy Balances*, UN Document E/CN.3/492, United Nations, New York, March 29, 1976.

[UN 88] *Industrial Statistics Yearbook, Volume II, Commodity Production Statistics* United Nations, New York, 1988

[USDOE-EIA annual] *EIA Annual Energy Review* DOE/EIA-0384 (86), U.S. Government Printing Office, Washington D.C.

## AN ENVIRONMENTAL MODULE AND THE COMPLETE SYSTEM OF NATIONAL ACCOUNTS

Abram J. de Boo, Peter R. Bosch, Cor N. Gorter, Steven J. Keuning

### 1. INTRODUCTION

The standard System of National Accounts (SNA) is an integrating framework for the description of monetary activities and the balance sheets in an economy. This does not imply that it gives an account of all economic events in society. On the other hand, broadening the scope of the SNA by introducing large-scale imputations in order to account for non-monetary phenomena like unpaid household services, the use of natural resources and so on would affect the relevancy for many practical purposes of largely financial parameters like GDP. A solution to this dilemma has been found in the development of so-called satellite accounts. Satellite accounts can be defined as data sets on particular subjects which supplement the central economic data as described by the SNA. Their purpose is to enable more detailed analyses than is possible with the information contained in the SNA or analyses using different definitions, while maintaining an explicit link with the core overall system. A major advantage of this approach is that the results of detailed studies can be put in the perspective of the full (financial) economy.

Originally satellite accounts served to describe in monetary and non-monetary terms a particular group of goods and services from three different angles: production, beneficiaries and financing (Vanoli, 1986). Following this approach, satellite accounts were for instance constructed on research, education, health and transport. Later on supplementary accounts were constructed which did not fully comply with this approach. Indeed, a whole range of different types of supplementary data sets round a core set of economic data can be distinguished (Gorter and Van der Laan, 1989). That is why we prefer to use the more general word of 'modules' to the SNA instead of satellites, the satellites being a particular kind of module.

In this paper, we shall advocate a comprehensive approach by linking systematically all kinds of environmental information to the complete (revised) SNA. We hope that in this way a clearer view of the entire impact of the economic system on environmental phenomena and vice versa can be obtained. At the same time, great stress is laid on applicability. By syste-

matically distinguishing between physical data and their valuation we hope to have adopted a practical and flexible approach to one of the most intricate problems connected with the construction of an environmental module.

The general features of the environmental module will be discussed more extensively in Section 2. Section 3 introduces environmental accounts in the framework of a National Accounting Matrix. These accounts are subsequently illustrated with physical data in Section 4. In Section 5 an elaboration of the National Accounting Matrix with respect to environmental expenditures is presented. Finally, Section 6 discusses the use of the matrix in relation to the debate on supplementing the national accounts with an additional, adjusted national income figure. However, methods for the valuation of non-monetized environmental transactions fall outside the scope of this paper.

## 2. GENERAL FEATURES

### 2.1 Aims of an Environmental Module to the SNA

In general terms, the aim of the environmental module is to provide a complete account of all links between the environment on the one hand and the transactions, 'other changes in assets' and balance sheets recorded in the main National accounts on the other hand. This implies that the module should provide information, first on the human-induced flows of matter, species and energy (commodity flows), secondly on the resulting effects on the environment (changes in ecosystems), and thirdly on the nuisance experienced by the population. In this way the module links economy, environment and society and shows these links where they occur in reality.

Within this general framework, our first objective is to provide a systematic and complete account of the effects of economic activities on the environment. In this respect, the environment is defined as the physical surroundings of man on which he completely depends for all his activities (CBS, 1990). In the environmental module a clear connection between data on production, consumption etc. and data on all kinds of changes in the environment will be made. These changes in the environment can take many different forms, such as the depletion of a resource, changes in the use of space or the pollution of the environmental media water, soil and air.

In the first instance the basic tables of an environmental module should contain all changes in the environment in physical units. These are supplemented with a systematic survey of all current expenditures to prevent, reduce or repair damage to the environment in relation with the entries of these data in the SNA. Also all damage to the assets as they are defined in the standard accounts is included.

Summarizing, the following aspects should be considered for inclusion in a full-fledged environmental module:

- A. The change of the environment stemming from economic activities in the registration period. This encompasses the elements:
  - A.1 Net pollution;
  - A.2 Net depletion.
- B. Current costs and incomes with respect to the environment. This category can be subdivided into:
  - B.1 Actual outlays and benefits: prevention, cleaning and compensation;

## B.2 Non-restored damage.

### C. The stock of environmental assets and liabilities.

This paper focusses on A and B.

Because of its completeness and because of the linkage between production/consumption activities and environmental data, the environmental module may provide information in a format which is suitable to further analysis and modelling exercises. In particular, it is our objective to provide analysts and policy makers with a data framework which can be used to sketch the trade-offs between the objective of environmental sustainability and other macro-economic policy objectives. This has led us to pay much attention to the linkage of indicators of environmental change not only to GDP-growth, but also to other important policy objectives like income distribution, balance of payments equilibrium etc. The environmental module proposed by us contains cross-classifications which are relevant for specific purposes, like analysis of the impact of taxation alternatives or a quantification of the income generated in the 'environmental industry'.

Building upon the full integration of different kinds of data, the environmental module should also provide basic material for designing indicators on the relation between production and environment. Examples may be sectoral indicators or performance indicators, like energy or environment efficiency of production processes (OECD, 1991).

Finally, an environmental module should be presented in a clear and easily accessible format. This implies that there is a need for one or two schemes which provide an overview of the whole module. These can then be complemented with a set of tables which follow the same pattern for each environmental problem. This is elaborated in the next section.

## 2.2 A matrix approach to the SNA including environmental accounts

The environmental module centres around a set of tables which give an overview of all relevant relations between the SNA and an environmental data system. As the burden on the environment originates from the emission of a multitude of agents into a whole range of ecosystems on the one hand, and from the extraction of many different resources on the other, a detailed picture cannot be given in one table. Therefore, a coherent, generally applicable system should be designed where specific tables for each relevant substance can be easily related to the overall picture.

For this purpose, it is most suitable to put the national accounts in a matrix format (see Table 1). This means that the whole system at the macro-level can be shown on one sheet of paper. This in turn facilitates substantially the understanding of the interrelations between various types of (monetary and physical) flows and their impact on each of the balancing items (NDP, NNI, Savings, Changes in Net Worth etc.) distinguished within the system.

Subsequent, more detailed tables then serve to elaborate a single vector or cell in the macro-matrix. These tables are labelled according to their position (row and column account number) in the reference matrix. In this way, the link between detailed figures and the overall system remains transparent throughout the whole set of tables. The subtables use the type of classifications given in parentheses in the row and column headings of the

Table 1. SAME: A National Accounting Matrix Including Environmental Accounts

ACCOUNT (Classification)	1	2	3	4	5	6	7	8	9	10	11	12	13	14	15	16	17	18	TOTAL	
	Goods and Services (Compos. Purposes)	Production (Production Activities)	Production (Production Activities)	Production (Production Activities)	Production (Production Activities)	Production (Production Activities)	Production (Production Activities)	Production (Production Activities)	Production (Production Activities)	Production (Production Activities)	Production (Production Activities)	Production (Production Activities)	Production (Production Activities)	Production (Production Activities)	Production (Production Activities)	Production (Production Activities)	Production (Production Activities)	Production (Production Activities)	Production (Production Activities)	Production (Production Activities)
1) Trade Items																				
2) Intermediate Consumption																				
3) Output (Net)																				
4) Household Consumption																				
5) Primary Income																				
6) Secondary Income																				
7) Total Income																				
8) Net of Taxes																				
9) Net of Taxes (incl. VAT)																				
10) Net of Taxes (incl. VAT) (incl. VAT)																				
11) Net of Taxes (incl. VAT) (incl. VAT) (incl. VAT)																				
12) Net of Taxes (incl. VAT) (incl. VAT) (incl. VAT) (incl. VAT)																				
13) Net of Taxes (incl. VAT) (incl. VAT) (incl. VAT) (incl. VAT) (incl. VAT)																				
14) Net of Taxes (incl. VAT) (incl. VAT) (incl. VAT) (incl. VAT) (incl. VAT) (incl. VAT)																				
15) Net of Taxes (incl. VAT) (incl. VAT) (incl. VAT) (incl. VAT) (incl. VAT) (incl. VAT) (incl. VAT)																				
16) Net of Taxes (incl. VAT) (incl. VAT) (incl. VAT) (incl. VAT) (incl. VAT) (incl. VAT) (incl. VAT) (incl. VAT)																				
17) Net of Taxes (incl. VAT) (incl. VAT) (incl. VAT) (incl. VAT) (incl. VAT) (incl. VAT) (incl. VAT) (incl. VAT) (incl. VAT)																				
18) Net of Taxes (incl. VAT) (incl. VAT) (incl. VAT) (incl. VAT) (incl. VAT) (incl. VAT) (incl. VAT) (incl. VAT) (incl. VAT) (incl. VAT)																				
TOTAL																				

1) 'Free' extraction refers to goods and services (from a net price (in real) or a net price (in constant quantities)).  
 2) 'Free' extraction refers to goods and services (from a net price (in real) or a net price (in constant quantities)) but excluding indirect taxes which apply only to some specific (final) demand categories (like VAT).  
 3) Including the transfer of 'free' emissions.

main matrix (cf. Keuning and de Ruijter, 1988).

Another advantage of the matrix format is that it always reveals which entities and which accounts are involved at both ends of all monetary and physical flows (origin and destination), and this has clear advantages if the data in the environmental module are to be used in subsequent (general equilibrium) modelling exercises (Pyatt, 1988; Barker, 1990). Finally, a matrix delivers data in the required format for 'tracing back' the origins of certain transactions and for some 'quick and dirty' simulation experiments with the help of (fixed) multiplier analysis (Keuning and Thorbecke, 1989). In this way, it is possible to simulate the effects of alternative valuation procedures on the conventional macro-economic aggregates.

Therefore, the module has been based on the Social Accounting Matrix (SAM) approach. Originally, SAMs were designed to incorporate concerns of inequality and poverty within the production-oriented national accounts and input-output tables (Pyatt and Round, 1985; Alarcon et al, 1990; Barker, 1990). Later, it was shown that in fact a complete system of national accounts can be transformed into a SAM-format (Keuning, 1991). This allows for considerably more flexibility than in the traditional format, especially regarding the classifications applied. This flexibility is particularly important in an environmental accounting system with its emphasis on the links between environmental effects and various types of transitions. Moreover, an important consequence of introducing disaggregated links between production, incomes and expenditures within our accounting system is that the effect of environmental degradation and of the costs involved in preventing this on the income distribution can be traced. In addition, the analysis of employment issues in conjunction with the environmental accounts comes within reach.

This is worked out in Table 1, which shows a so-called National Accounting Matrix including Environmental Accounts (NAMEA). This matrix is based on a design for the standard accounts as proposed by Keuning (1991) in his paper on a Social Accounting Matrix which fits into the revised SNA. In Table 1, this SAM has been expanded and slightly re-arranged. As a consequence, Table 1 integrates a) the SNA sequence of accounts as well as a set of supply and use tables, and b) separate accounts for the relations between the economic flows and changes in the environment. A crucial aspect of these interactions is that the eventual effect on ecosystems is transmitted through all kinds of environmental 'agents': pollutants (including noise and radiation) on the one hand and natural resources (including species) on the other. This transmission is included in our framework by inserting a separate account for all kinds of environmental 'agents' in between the conventional accounts and the account for environmental assets (i.e. ecosystems).

The distinction between an environmental agents account (#16 in Table 1) and an environmental assets account (#17) is expedient to both the supply and the use of the data. Often, emission and waste statistics can be detailed by discharging industry or final demand category, but it is almost always impossible to attribute the degradation of ecosystems directly to certain economic activities (United Nations, 1990: 22). In addition, environmental policy instruments will generally also focus on certain environmental agents instead of directly on ecosystems.

Therefore, account #16 in our framework serves to register the emissions and extraction of all kinds of environmental agents, while account #17

serves to sketch the effects on ecosystems and to provide a general description of changes in the state of the environment. Eventually, this may yield a rough indication of the total effects of economic activities on environmental assets which are not absorbed during the current period: changes in net worth of ecosystems. This balancing item is combined with the changes in conventional balance sheets to arrive at a final evaluation of our economically relevant position at the end of the current period.

Separating these accounts is also advantageous because part of the environmental effects has a current character, while another part precipitates on (the value of) assets already distinguished in the standard national accounts. In our system, this is catered for by recording first e.g. the (total negative value of) all kinds of emissions by a certain activity, air transport say, and then their impact on a) current accounts - in this example, the 'consumption' of noise by household groups neighbouring the airport, b) conventional assets - such as a decrease in the value of houses as a consequence of the enlargement of a nearby airport, and c) environmental assets - like air quality.

Generally, Table 1 reflects our thinking that the interrelations between national accounts and the environment are not limited to the production accounts, and that these effects should be shown where they actually occur. This means that in a simulation experiment with (shadow) prices all major national accounts balances would be affected. These effects cascade down the balancing items until finally, in the total changes in net worth, all (lasting) effects have been incorporated. In Table 1, all important balancing items have been framed.

An essential feature of Table 1 is that it represents a consistent, closed system of accounts. In this system both the linkages among production, income and expenditures are maintained and the sum of incomes, expenditures etc. of all subsectors always agrees with the total figures for the nation as a whole. This implies, however, that national aggregate figures can only be adjusted if the incidence of the adjustments is known or simulated.

As shown in Table 2, a possible adjustment of the *net product* measure incorporates, as far as possible, all environmental effects of current production. An adjusted *income* measure may focus on those effects which are currently absorbed; that is, including present effects of past disposals and excluding future effects of present disposals. Analogous to these intertemporal flows, cross-national flows are also settled in the income accounts. The distinction between these concepts corresponds with an interest in the environmental effects of current domestic production and consumption on the one hand and in the current quality of the national environment on the other hand. Although not elaborated here, it is also possible to analyse a countries' share in the burden of the global environment by including the environmental burden embodied in imports and exports in the income accounts. Obviously, adjusted *savings* should incorporate all those effects not absorbed in the present period. Finally, adjusted changes in *net worth* should take into account all changes in the condition of the environment. In this way, each balancing item has a different purpose to serve. The balancing items and some other concepts are elucidated step by step in the next sections which provide a concise explanation of the specific features of the NAMEA matrix presented in Table 1. For a discussion of the general features of a Social Accounting Matrix reference is made to Keuning (1991) and to a previous, more extended version of this paper (de Boo et al, 1991).

TABLE 2. Adjusted national accounts aggregates, related to 'free' emissions

I. Generation

1. 'free' emissions by production activities (-)<sup>1)</sup>
2. 'free' emissions by consumption activities (-)
3. Transformation of 'free' emissions by collection and treatment of waste activity (+,-)
4. (1..3) Total 'free' emissions generated (-)
5. DOMESTIC PRODUCT (+)
6. (4+5) Adjusted DOMESTIC PRODUCT

II. Distribution

7. Exports of 'free' emissions (+)
8. Imports of 'free' emissions (-)
9. (4+7+8) 'free' emissions on the economic territory (-)
10. Current effects of 'free' emissions in previous periods (-)
11. Future effects of current 'free' emissions (+)
12. (9..11) Effects of 'free' emissions which are absorbed in current period (-)
13. DISPOSABLE NATIONAL INCOME (+)
14. (12+13) Adjusted DISPOSABLE NATIONAL INCOME

III. Absorption

15. Natural cleansing (+)
16. Absorption by defensive outlays (+)<sup>2)</sup>
17. Absorption by consumption (+)
18. CONSUMPTION
19. (15..18) Adjusted CONSUMPTION
20. SAVING
21. (=11) Future effects of current 'free' emissions (-)  
a. to economic assets; b. to eco-systems
22. (20+21) Adjusted SAVING

IV. Other events

23. Correction due to registration in transaction accounts of referable damage on economic assets (+)
24. Changes in eco-systems not referable to transactions (-)

V. Balance sheets (changes)

25. (21a+23) Damage to economic assets (-)
26. (21b+24) Changes in worth of eco-systems (-)

1) Between brackets: sign of valuation (in welfare or monetary terms).

2) The value of the absorption of free emissions by way of 'defensive outlays' is to be valued for environmental accounting purposes as the net benefit of these outlays over and above monetary costs. This is because the latter are already included in conventional National Accounts.



### 3. A SET OF NATIONAL ACCOUNTING MATRICES INCLUDING ENVIRONMENTAL ACCOUNTS

#### 3.1 Goods and services account

The first row and column of Table 1 above contain the 'traditional' goods and services account. All the entries are valued at purchasers' prices excluding indirect taxes minus subsidies which apply to some (final) demand categories only. The various types of indirect taxes are recorded in separate rows and columns (account 9). This creates the possibility to use the module for a simulation experiment on incidence of specific instruments of government regulation. For instance one may want to distinguish between taxes or subsidies on products on the one hand and taxes on production processes on the other.

If an environmentally adjusted value added (say GDP) were computed, this should take into account the pollution caused by final consumption too. Since value added can only originate in production, this must imply that production processes also occur within households. In our environmental module, this amounts to a transformation of their consumption expenditures into household output plus various types of 'free' emissions. The 'value added' resulting from these emissions is equal to the (non-positive) value attached to the disposals.

The 'free' emissions are delivered to the environment and the other household 'output' accrues to the producing households as final consumption. Apart from the disposals, the physical appearance of the input and output of these production processes is the same. However, there is no need to apply the same classification twice. It is even expedient to show household consumption not only by commodity type but also by purpose. In that case, comparisons (between household groups, countries or periods) can be made concerning the consumption patterns by purpose (e.g. budget share spent on transport) and concerning the allocation to goods and services for each purpose (e.g. riding a bicycle or driving a car).

This is worked out in the second and fourth account of Table 1. The second row registers the use of this household output and the second column how it is produced. Whereas the first row registers consumption expenditures excluding VAT etc., the second row contains the market values. The fourth account is discussed together with the ordinary production accounts.

#### 3.2 Production account

In addition to the output for sale, most production processes also generate less wanted 'by-products' in the form of substances which are dumped into the environment. Usually, there is no direct relationship between the amount of a certain pollutant emitted by a certain firm and any monetary settlement. The statistical approach, i.e. a registration of the way things actually happen, as followed in this environmental module, requires that these flows are recorded accordingly. This means the registration of a monetary value in cell (3,16) equal to zero. In this way, the equality of row and column totals is also maintained.

However, at the same time the emission in physical terms is registered too. The essence of our accounting method lies in subsequent disaggregations, not only by production activity and type of agent emitted, but also into volumes and prices. Cell (3,16) is thus blown up into two separate sub-

matrices, of which one is filled with volumes using units which are relevant to the type of emittant under consideration, and another is filled with prices. The latter matrix is actually not at all interesting in our statistical system, since it contains only zeros. However, the system as portrayed here serves, among other things, to provide a suitable framework for simulation experiments. A principal feature of those experiments should be to analyze the effects of replacing the zeros in the second submatrix above by various sets of negative (shadow) prices. Naturally, an essential consequence of replacing the zeros in row and column 16 by negative numbers is that all balancing items in Table 1 are adjusted as well, in order to maintain the equality of row and column totals. However, we view the estimation of these price sets as a distinct, second step.

The third column registers the inputs in production. Apart from intermediate inputs obtained from other firms, the environment delivers unpaid resources which are used up in production processes. These amounts appear in cell (16,3) in this matrix. It is probably most convenient to book this extraction of depletable resources net of the natural growth which may be expected under average circumstances. In this way the net depletion of fish etc. is recorded here. As in the case of emissions, their monetary value remains equal to zero and the balancing items are not affected, in the first instance.

The fourth account shows the transformation of household consumption expenditures into household output (i.e. the same products as were bought) and 'free' emissions. As soon as the disposals are valued, value added generated by these household waste production activities becomes negative. The consumption taxes recorded in the column of this account may also include some environmental levies which are treated as direct taxes in the standard accounts (United Nations, 1968: 6.89-6.90 and 7.65).

### 3.3 Income distribution and use accounts

The income accounts should focus on the current effects. This implies that current effects of past disposals should be added, as a kind of (negatively valued) transfer from the past to the present (cell 6,17), and that future effects of present disposals and extraction should be singled out (in cell 7,6), because they entail a transfer from the present to the future. In this way, one arrives at an adjusted concept of Disposable Income. To remain consistent, this procedure should also be followed for the 'ordinary', positive intertemporal transfers. This implies that consumption of fixed capital (production in the past, consumption now) is added (cell 6,3) and that the future effects of present investments (production now, but consumption in the future) are also shown separately (in cell 7,6).

The way of recording described above presumes the possibility of valuing the currently experienced nuisance. This is probably less complicated than a valuation of the total expected nuisance of current economic activities. In this respect, it is important to record the experienced nuisance in relation to a realistic reference period. The grief over the deteriorating water quality should refer to this year's change in water quality only. The implication is that once consumed nuisance will not reappear again in a later year.

However, in physical terms it is difficult enough to separate changes in the environment induced by pollution in the previous years from those in

the current year. Usually, one only knows the total environmental burden which is currently 'consumed': cell (16,7) + cell (17,7). Only in a few situations, such as the release of pollutants in the soil, it is possible to judge changes in the quality of groundwater as the effect of past disposals, while the current pollution is still under way in the soil above the aquifer. In many cases, it is not feasible to estimate how large the future effects of present emissions will be, their valuation is anyhow needed in a consistent approach.

The use of income account (#7) records that the environment absorbs some of the pollution by means of natural cleansing; this is shown in the row with a positive sign. Column 7 contains items called 'current consumption of pollutants', originating from the environmental agents account, and naturally the absorption of the current effects of past disposals. These cells may need some further explanation. Most environmental effects of economic actions have a capital character, in the sense that the impact is not, or not only, felt during the current period. A notable exception is noise, where at least part of the effect disappears when the noise stops. Noise can be seen as a particular kind of environmental 'agent', emitted by production and consumption processes (and included in column 16). The (immediately) experienced nuisance is entered as consumption in column 7.

Another example of current consumption of pollutants refers to the current effects of past disposals. An adjusted concept of final expenditures would thus add the current consumption of past disposals to the ordinary final consumption as shown in the first two cells of this column. By now, it may be clear that our registration method ensures that current effects of past disposals would be taken into account in adjusted current income and final expenditures, but not in adjusted net product and saving measures.

In accordance with international practice, the income distribution and use accounts for the rest of the world (in Table 1 sometimes abbreviated as ROW) have been combined. The traditional registration method of national accounting systems is followed here: current receipts of the rest of the world appear in the row and current outlays in the column. The balance is transferred to the capital account of the rest of the world. The framework in Table 1 can easily accommodate physical flows of pollutants across the border. In row 8 various disposals, emitted abroad, float into the national territory (cell 8,16). Obviously, the shadow price of these imports is negative. This should then also be reflected as a (non-positive) monetary transfer from the rest of the world (cell 6,8). Reversely, pollutants are exported too, as shown in cell (16,8), and this is counterbalanced by a transfer to abroad (cell 8,6). Also the 'transit' of waste can be recorded in this way. The balance of these flows affects Disposable Income as well as all other balancing items further 'down' the system.

Subsequently, indirect taxes are specified in a separate account. The classification of this account will have to pay special attention to various types of environmental levies and subsidies.

### 3.4 Capital accounts

Because the registration of all effects on the balance sheets is an important objective of our matrix, the capital account is quite extensive. The first capital account describes the generation of net worth due to net savings and actual capital transfers received (from other institutional

units and from abroad) minus capital transfers paid. Capital transfers include a (negative) imputation for the flow of 'free' emissions with a capital character, from the dumping sector (in the column) to the stricken sector (in the row). If the latter cannot be identified, it may be assumed that the national or even global common heritage is affected, and this may or may not be combined with the government sector. Like ordinary saving, the net environmental effects of present activities which are not completely absorbed during the present period, are transferred to the changes in balance sheet accounts.

The second capital account (#12) records the use of funds for the accumulation of assets as defined in the standard accounts. The environmental effects are taken up again in the other changes in assets and changes in environmental assets accounts. In the column, the environmental effects consists of net losses of environmental assets to natural causes, non-referable degradation of environmental assets and the 'other' changes in environmental assets, which are included in the other changes in assets.

Net losses in environmental assets due to natural causes refer to capital gains and losses not resulting from human activities, or which are an unexpected result of human activities. This refers to e.g. the consequences of natural disasters or a reduction in the number of seals in the North Sea. It also includes net growth of uncultivated species. The item non-referable degradation of environmental assets has been added because demonstrable deterioration of an ecosystem may not be attributable to *specific* economic activities or even to a specific period. Therefore, it has not been included in the environmental effects of any activity. However, this deterioration should be incorporated when assessing total changes in net worth. The solution is to put this damage in cell (17,12) for the moment, with a counterbalancing value in the changes in net worth of ecosystems (cell 17,18).

### 3.5 Financial and other changes in assets accounts

Subsequently, the financial accounts (#14) are presented. These indicate which sectors (including the rest of the world) have acquired the various types of assets (and liabilities) during the reference period.

The row and column 15 of Table 1 contain the other changes in assets accounts. The character of this account differs from the others since it does not really relate to flows (consequences of actions), but to changes in states (other economic events). Not elsewhere classified changes in the volume and price of assets *claimable* by institutional sectors and the rest of the world are recorded here, as well as the balance of those adjustments, called changes in net worth due to other changes in assets. On the credit side, it concerns economic appearance of non-produced assets (e.g. discovery of subsoil resources), nominal holding gains of all kinds of assets etc. On the debit side, the destruction of assets by non-insurable risks, disappearance of non-produced assets, nominal holding losses etc. are recorded.

In the standard national accounts, changes in national worth due to environmental effects are already partially shown here, at least in theory. This concerns for instance holding losses and destruction of capital goods which are demonstrably due to pollution. An example is the fall in house prices when the enlargement of a nearby airport has been approved. In the environmental module, these losses are singled out and shown as a separate

(negative) item, called referable damage due to environmental effects, in the column of this account. In this way, the balance of this account does not change.

An interesting consequence of this registration method is that if a) the size of the damage to these non-environmental assets can be estimated from actual data, and b) this damage can be clearly attributed to a certain economic activity, this value can be re-routed within the *statistical* framework of the environmental module. It implies putting a negative value in e.g. cell 3,16, and concomitantly reducing NDP (cell 5,3), NNI (cell 6,5), Future Effects (cell 7,6), Net Savings (cell 10,7), Capital Transfer Flows (cell 10,10), Net Worth Changes due to Saving and Capital Transfers including Net Environmental Effects (cell 18,10), and Holding Losses and Destruction (cell 15,12). The same negative value then appears in cell 16,15, while Net Worth Changes due to Other Changes in Assets including Net Environmental Effects (cell 18,12) is increased with a positive amount. It can be easily checked that in this sequence all account numbers appear just as frequently in the rows as in the columns, except for accounts #12 and #18 where a negative adjustment is compensated by an equally large positive adjustment. This ensures that the equality of all row and column totals is maintained in this re-routing. Therefore, the consistency of the system is not affected by the adjustment of the balancing items.

A similar procedure can be followed for the appraised value of the depletion of natural resources which are subject to ownership (e.g. standing wood, some mineral resources). Only in this case the capital loss is usually not thrust upon another party (cell 10,10 remains empty). Here, cell 16,3 contains a positive value and various balancing items are reduced. Note that in this way a written off depletion of natural resources subject to ownership is recorded as other changes in (non-produced) assets and not as changes in environmental assets (ecosystems). This is in accordance with the treatment in the standard national accounts.

Environmental damage to the standard assets which is not referable to specific economic activities in the present period remains included in cell 15,12 (holding losses and destruction).

### 3.6 Environmental changes and changes in balance sheet accounts

Above the interrelationships between the economy and the environment have been discussed where they actually occur. This means that now it suffices to sum up the balances which are implicit in the accounts 16 and 17. The sign of the variables in simulation experiments with non-zero prices is given in parentheses in front of each term. The balancing items, which are computed residually, have been printed in bold letters. We start with account #16:

- 1) for natural resources (e.g. fish, trees of various kinds, mineral deposits):
  - (+)net 'free' extraction (cell 16,3) + (+)net losses due to natural causes (cell 16,12) + (-)referable damage of owned assets due to environmental effects (cell 16,15) =
  - (+)net depletion of (not owned) environmental assets (cell 17,16)**

- 2) for environmental agents without a capital character (e.g. noise):  
 (-)'free' emissions by production (cell 3,16) + (-)'free'  
 emissions by consumption (cell 4,16) =  
 (-)**current consumption of pollutants (cell 16,7)**
- 3) for environmental agents with a capital character (e.g. acid rain,  
 carbon dioxide, waste):  
 (-)'free' emissions by production (cell 3,16) + (-)'free' emissions  
 by consumption (cell 4,16) + (-)'free' emissions from abroad (cell  
 8,16) =  
 (-)'free' emissions to abroad (cell 16,8) + (-)referable damage of  
 owned assets due to environmental effects (cell 16,15) +  
 (-)**immission into ecosystems (cell 16,17)**

It is clear that in simulation experiments all (shadow) values in the first equation are positive, with the exception of the referable damage, while those in the last two are negative. Finally, the equalities underlying account 17 are given here:

- 4) for national ecosystems (e.g. air, seas etc.):  
 (-)current effects of past disposals (cell 6,17) + (+)natural  
 cleansing (cell 7,17) + (-)immission (cell 16,17) =  
 (-)current effects of past disposals (cell 17,7) + (+)non-  
 referable degradation (cell 17,12) + (+)net depletion (cell 17,16) +  
 (-)**changes in worth of ecosystems (cell 17,18)**

Current effects of past disposals appear both on the left-hand side and on the right-hand side of this equation. For the rest, it can be seen that total worth of national ecosystems decreases in proportion to an absolute increase of all other elements in this equation, except natural cleansing. It goes without saying that filling in this equation is a lot easier said than done.

At the bottom and at the right-hand side, changes in the balance sheets close the full sequence of accounts and balancing items. The totals of this account reflect in principle all changes in net worth, including changes in worth of ecosystems. Total changes in net worth should be added to the opening balance sheets to arrive at the closing balance sheets.

It is obvious that at present insufficient data are available to fill this matrix completely, even in physical terms. For that purpose, an abbreviated table focussing on a few environmental agents with a known origin and destination may be more practical at present. In such a matrix, some of the accounts could be deleted. This is illustrated in section 4.

### 3.7 Matrices behind the cells 16,17 and 17,16.

In the module, agents and the natural resources are described in column and row 16 as physical quantities. The agents and natural resources are included because the immission (cell 16,17) and net depletion (cell 17,16) cause changes in the ecosystem. These effects are described in column and row 17 as changes in the quality of the ecosystem.

At the intersection of columns and rows 16 and 17 we find two very important cells in our module, because there the relation can be found between the immission or net depletion on the one hand and the consequences of this for the quality of the ecosystem on the other hand. The problem with these

cells is however that depending on the side from which one looks at them, they have a different dimension: along column and row 16 physical changes and along column and row 17 ecological changes. In our module this has been solved by imputing two figures in the same cell: one gives the immission or net depletion (cause) and the other the changes in the ecosystem that is caused by this immission or net depletion (effects). So immediately the relation between these two is shown. In case of a complete monetarisation there will be only one figure, because the value of the immission and net depletion and of the effect of it on the ecosystem are the same: one is the result of the other.

The two figures in the cells 16,17 and 17,16 are the summations of respectively all immissions or net depletions and all effects on the ecosystem. The detailed information behind these totals is given in matrices. The two matrices behind cell 16,17 (immission) have as column heading environmental assets change with a subdivision into ecotopes, and natural resources (see figure 1). As row heading these matrices have environmental matter which is subdivided into agents and natural resources. The two matrices behind cell 17,16 (net depletion) have as column heading environmental agents and as row heading environmental assets change. Both column and row heading of the matrices behind cell 17,16 are subdivided as those behind cell 16,17.

Confrontation of both pairs of matrices gives a detailed picture of the relation between causes and effects of the use of the environment.

The construction of the detailed cause and effect matrices for immissions (cell 16,17), which concerns mainly the top left side of the matrices (agent/ecotopes), will be a difficult task: all the agents must be spread over the ecotopes on which they cause effects and all the ecotopes that are influenced by agents, must be analysed to see which agents are causing these effects. These difficulties could be reduced by accepting some aggregation (e.g. to ecozones) or the introduction of dummy columns. Such additional columns can 'absorb' various agents which have a collective effect on one or more ecotopes.

Figure 1: Matrices behind cell 16,17

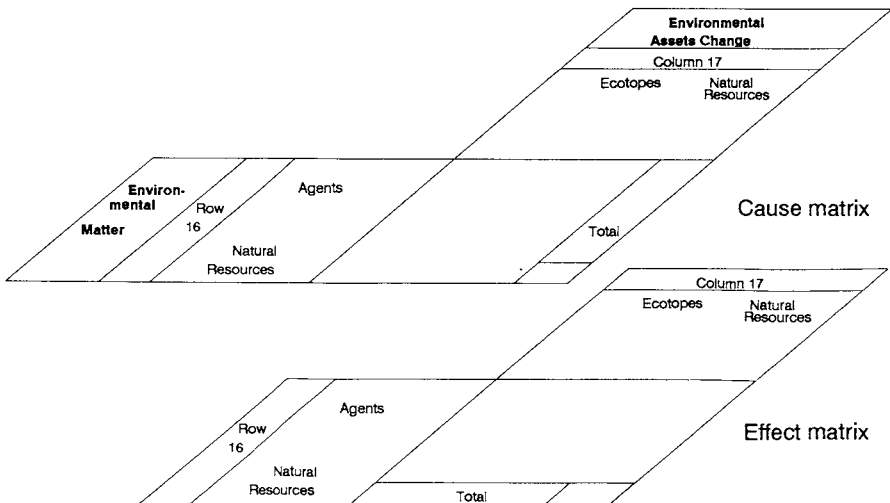

The construction of the cause and effect matrices for net depletion (17,16) will be relatively easy because the relation between net depletion and changes in the stock of resources (bottom right side of the matrices) is a direct one. Only when the depletion affects also ecotopes (top right side of the matrices), e.g. damage to the vegetation by the production of groundwater, the same problems will arise as with the construction of the cause and effect matrices for immissions.

#### 4. AN ILLUSTRATION OF THE ENVIRONMENTAL MODULE IN PHYSICAL TERMS

By way of example, a condensed complete matrix for waste is presented in Table 3. Tables could be presented covering various other agents (substances, species or physical changes) in water, soil and air in a similar way. Waste has been chosen because with this agent many entries of the matrix can be highlighted. Also the extraction of resources could be dealt with in this way.

The data that are presented are derived from official statistics for the Netherlands. The waste amounts in Table 3 are shown in brackets; for the corresponding money amounts 0.0 has been added, representing a zero price-matrix as was argued in section 3.2. In this way, it is still possible to add the data in the matrix to row and column totals.

The 'free' waste emission from production, that amounts to 104,370 mln kg, is shown in cell 3,16 of Table 3. Through a magnifying glass this cell looks like Table 4; here any total of a cell like 3,16 can be subdivided according to substances on the one hand and production activities on the other hand. In this example waste is not further subdivided into various substances but by method of disposal.

Similarly the 'free' emission from consumption (5,310 mln kg) is presented in cell 4,16 and specified in Table 5. This waste encompasses all waste delivered by households including small portions of chemical waste collected separately.

The transport of waste across national boundaries is not yet incorporated in the Dutch statistics on waste. Some data are however available on the import and export of hazardous waste, which have been entered in Table 3 in the cells 8,16 and 16,8 respectively.

We have used the 'free' extraction entry in the matrix also to account for the part of the waste stream that re-enters the economic process. In column 16 of the matrix the total production of waste is recorded. Part of this amount is used as input in processes aiming mainly to reduce the volume of waste. This waste can be considered to re-enter the economic system as (free) inputs for waste incineration plants and the like (4,220 mln kg is entered in cell 16,3). And consequently it does not enter into the environment (account #17) in the form it was delivered to the waste collecting service. After being processed (burned) the remains of the waste (1,200 mln kg) show up in our matrix in cell 3,16 as the 'free' emission of waste processing services. Of course, the same re-routing should be carried out for waste which is not dumped or incinerated, but treated otherwise. To keep Table 3 easy to understand this has not been done.

The most important balancing item in the waste example is the immission, the total load on the environment within the country's borders (#16,17). This amount (106,560 mln kg) is build up out of the 'free' emission by production (104,370 + 1,200 mln kg), by consumption (5,310 mln kg) and from



Table 3. MMEA: A National Accounting Matrix Including an Environmental Account for Waste, fictitious data for the Netherlands based on 1000 estimates; National accounting data in mid bid, waste data in mid kg

ACCOUNT (Classification)	1	2	3	4	5	6	7	8	9	10+12	14	16	17	TOTAL
	Goods and Services (Consumption Purposes)	Production (Household Activities)	Production (Commercial Activities)	Production (Waste)	Primary Inc. (Secondary Inc.)	a. National (Sectors)	Income Distribution and Use (Distribution)	b. Rest of the World (ROW)	Indirect Taxes (Imp/SDAs)	Capital (National)	Financial (Financial Assets)	Environment (Agents/ Resources)	Environmental Assets (Change/Eco)	
1. Marginal and other purposes	0.0	389.9	389.9	233.0	0.0	399.3	71.2	246.4	9	90.1	11+13	16	17	1030.5
2. Output (basic prices)	801.2					48.0	268.9			GrossCapEx				FinalInvUse 268.9
3. Household (Net)Prod	268.9													1030.5
4. In (to) Income														
5. In (to) Income														
6. In (to) Income														
7. In (to) Income														
8. In (to) Income														
9. In (to) Income														
10. In (to) Income														
11. In (to) Income														
12. In (to) Income														
13. In (to) Income														
14. In (to) Income														
15. In (to) Income														
16. In (to) Income														
17. In (to) Income														
TOTAL	1030.5	268.9	801.2	233.0	268.9	560.6	443.8	275.1	42.1	344.4	160.8	0.0	0.0	1030.5

8) mp, excl. VAT = valued at market prices, but excluding indirect taxes which apply only to some specific (final) demand categories (like VAT).

abroad (90 mln kg) and with a minus sign the 'free' emission to abroad (190 mln kg) and the extraction by incineration (4,220 mln kg). This immission finally influences the state of the environment, which is registered in cell (17,12).

Table 4. 'Free' emission by production: Waste<sup>1</sup>, 1988, part estimates (#3,16)

ISIC category	Total mln kg	by method of disposal:		
		dumped	incinerated	other
Agriculture and fisheries <sup>2)</sup>	17,500	17,500	-	-
Mining and quarrying x <sup>3)</sup>	x	x(98%)	x	x
INDUSTRY (incl. mining and publ.ut.)	7,240	6,240	530	470
among which				
Food, beverage and tobacco industry	2,200	2,070	70	70
Wood and furniture industry	130	70	60	0
Paper and paper products industry	370	280	x	x
Chemical industry, manufacture of artificial filaments and staple fibres	3,000	2,610	x	x
Manufacture of building material, earthenware, glass and glass products	510	480	10	20
Basic metal industry	410	270	10	120
Manufacture of metal products, machinery and transport equipment	160	110	20	20
Public utilities	x	x(94%)	x	x
Trade, hotels, restaurants, repair of consumer goods <sup>4)</sup>	490	130	280	80
Transport, storage and communication <sup>4)</sup>	2,140	50	90	2,000
Other services and n.e.c. <sup>4), 5)</sup>	75,660	74,070	920	670
Total	104,370	99,230	1,840	3,290

- 1) Excluding radioactive waste, but including earthy wastes such as polluted soil and sludges
- 2) 1986 data
- 3) 'x' means confidential figure
- 4) Hospital, office and shop waste: 1986 data; waste from shipping: 1985 data
- 5) Also consists of the bulky wastes: dredging sludge (65,000), sewage sludge (2,860) and polluted soil (220).

Table 5. 'Free' emission by consumption: Waste, 1989 (#4,16)

	Total	by method of disposal:		
		dumped	incinerated	other
Households	5,310	2,180	2,290	890

## 5. MONETARY FLOWS SPECIFIC TO THE ENVIRONMENT MODULE

### 5.1 Introduction

Several transactions registered in the core of the SNA are related to the environmental problem. These monetary flows can be separated into outlays for environmental control, for the compensation of the loss of environmental functions and for the repair of environmental damage. The way these outlays are treated in the SNA depends on the kind of activity and sector. In our module, the usual concept of production has been expanded and the system of make and use tables, which is part of Table 1, is shown as a framework with which these outlays can be easily analysed. In this section, a more detailed make and use system for environmental outlays is demonstrated. The figures refer to the outlays to diminish environmental pollution, because this part of the environmental problem is best documented.

### 5.2 Environmental control

Measures to prevent or diminish environmental pollution or the depletion of scarce natural resources or measures related to land-use problems are called environmental control. In this module environmental control is taken into account only when it causes extra costs to the economy. Measures that pay for themselves by way of savings on inputs or by selling by-products are not shown separately.

#### 5.2.1 Internal versus external environmental control

Environmental protection measures can be divided into internal and external measures. Environmental control is called internal when it aims to reduce the environmental pollution caused by the production establishment or the household itself. In our module, internal environmental control is seen as a consumption by the establishment of its own production. So the production boundary as used in the SNA has been extended to include a specific within-unit transaction. When environmental control is done to diminish the pollution caused by another unit, it is called external.

Although many firms recommend their products as "environmental", external environmental control in our module is performed only by enterprises classified in division 90 of ISIC or NACE (Sewage and refuse disposal, sanitation and similar activities) or by the government (division 75). The "environmental" products of establishments outside this division are considered as inputs into internal environmental control.

The reason for this way of booking is that the classification of establishments in ISIC and NACE is based on the character of the products and not on the use of them. For example, there is no technical reason to divide the services of private R&D enterprises into environmental and non-environmental, so all these enterprises are classified in division 74.2 of ISIC.

According to CPC-rules, part of the goods and services that are used for internal environmental control cannot be classified as environmental goods and services because these goods and services are environmental by purpose of use and not by character. The use of these products is however shown separately in the module by the inclusion of the demand side of this market.

### 5.2.2 Recycling

A special form of environmental control is the recycling of used products. Often this is a technical or costs-saving part of production and does not belong to environmental control. Only when non-profitable recycling takes place with the intention to decrease environmental pollution or the use of natural resources it is included in this module. Like other environmental control, environmental recycling can be divided into internal and external recycling. When it takes place within the enterprise, the extra costs are shown in Table 6 under the internal costs of environmental control. When environmental recycling takes place as an external activity, it could be done by specialist enterprises which are classified in division 37 of ISIC and NACE (Recycling). These enterprises mostly recover materials for economic reasons. The (non-profitable) environmental recycling they perform cannot be financed completely by selling the regained materials. The additional costs are financed by the unit which wants to dispose of the recycled products or by subsidies from the government. These former payments are in exchange for the delivery of a service by the recycling establishments to the disposing units, and thus entered in Table 6 (cell 1.3).

### 5.2.3 Make and use table

Using the principles mentioned above, Table 6 was constructed. This table is directly related to Tables 1 and 3, but contains more detail, for instance regarding the production of internal and external environmental control (subcolumns in column 1). In column 3, an extra sub-column has been added to show the input structure of the production of external environmental control. In row 1, extra subrows have been introduced to show the use of internal and external environmental control and the use of other products for environmental purposes. A further extension can be made when also other categories of products are used for environmental purposes. As mentioned before, the totals in #3.1 and #1.3 differ from those in the standard SNA because production and intermediate consumption have been enlarged with internal environmental control, which is seen here as being produced and consumed by the same establishment.

The costs which have been made by producers of internal environmental control (5.3 mld gld) may have been passed on to the users of their products. These effects may be calculated with the help of input-output analysis. Since internal environmental control amounts only to about 0.5 % of total production, the effects will be minimal.

### 5.3 Compensating and repairing environmental damage

When environmental damage is not prevented it will lead to a loss of environmental or other assets. Sometimes the loss of an environmental asset is such that it is compensated for by extra activities (e.g. the extra treatment of polluted groundwater that is used for the production of drinking water). In other cases the loss can be partly repaired (e.g. monuments). Common to these losses is that they cause additional costs. These expenses which are already included in the SNA will be shown explicitly in separate tables in this module. This is not elaborated here.

Table 6. Environmental Control Activities in a System of Make and Use Tables, 1988 (mid-est. estimates)

	Goods & Services			Production		Income distribution & use			Gross fixed capital formation	TOTAL
	(1)	(2)	(3)	(4)	(5)	(6)	(7)	(8)		
	o.w. environmental control	internal external	Production activities	Households	Government	Rest of the World				
Goods & Services										
(1) Agriculture, hunting, forestry, fishing			18.0					14.0	-0.3	31.7
Mining and quarrying			3.0					8.0	0.3	11.3
Manufacturing products for environmental purposes			187.4	1.3				169.1	7.1	486.6
Manufacturing n.e.c.			12.3	0.1				0.0	1.5	13.8
Public utilities			37.1	0.3				0.0	2.1	2.1
Construction products for environmental purposes			37.2					1.1	56.5	94.7
Construction n.e.c.			19.2					26.4	10.4	101.5
Trade, hotels, restaurants, cafés, repair of consumer goods			5.3					20.0	0.7	83.5
Transport, storage and communications			0.2					1.4	5.3	5.6
Internal external			73.2				4.0	67.2	10.9	213.3
External environmental control										
Other services and n.e.c.			389.9	1.7			71.2	246.4	90.1	1030.5
Total	36.7	0.6								
(3) Agriculture, hunting, forestry, fishing	19.6	0.2								36.7
Mining and quarrying										19.6
Recycling										
Manufacturing n.e.c.	270.3	1.4								270.3
Public utilities	41.0	0.2								41.0
Construction	61.0	0.6								61.0
Trade, hotels, restaurants, cafés, repair of consumer goods	108.2	1.8								108.2
Transport, storage and communications	46.0	0.2								46.0
Environmental Services by government	5.3									5.3
Environmental Services by division 90	0.3	0.3								0.3
Other services and n.e.c.	232.2	0.1								232.2
Total	801.2	5.3	5.6							801.2
Primary inputs			239.1	1.5						
Salaries and social charges			120.2	0.6						
Operating surplus			359.3	2.1						
Total			48.0	1.6						
Income distribution										
(6) Consumption of fixed capital										
Rest of the world			227.1							
Imports										
Indirect taxes			2.1							
Net Gross production tax										
TOTAL	1030.5	5.3	5.6	801.2	5.6					5.6

As both the losses of assets and the outlays for compensation and repair are part of this module, double counting should be prevented. Therefore it is important to discern when the losses become manifest and if and how they have been valued: inclusive or exclusive of the costs of repair or compensation.

Not explicitly shown in the module are the losses of present production due to environmental pollution. This financial damage manifests itself in lower production figures in the outcomes of the national accounts. A separate presentation is difficult, however, because often these losses can only be measured indirectly.

## 6. SUPPLEMENTING THE NATIONAL ACCOUNTS

### 6.1 Indices

An essential feature of this module is the recording of environmental figures in relation to the outcomes of the national accounts. In this way, a detailed picture arises of the consequences of production and consumption for the environment and reversely of the effects of environmental degradation on production and consumption. These consequences, like the consequences on other fields of interest, manifest themselves in so many ways that it may be difficult to draw a general conclusion. Therefore some aggregation could be desirable.

Aggregation of physical data about the environment is often difficult because many different aspects of the environment must be put together. A first step to facilitate the interpretation of the data is to aggregate wherever the character of the data permits it or to select a small number of representative indices. So the aggregates of the national accounts can be supplemented with relatively few indices on the quality of the environment. Such a limited set of indices together with indices from the SNA or about other fields of interest can give an impression of the direction society is heading.

### 6.2 An Adjusted National Income

Although the environmental indices that supplement the national accounts can give a good image of the consequences of production and consumption, one may even want to bring all this information together in one figure. A reason for this could be the wish to construct an indicator that for a wide public is simple to interpret. A way to achieve this could be the construction of an adjusted income figure that serves as an indicator of sustainable economic development (Daly, 1989, Hueting, 1989 and 1991, Peskin, 1989, Repetto et al, 1989).

Starting from the conventional national accounts, an environmentally adjusted net product measure could be found by subtracting the consumption of environmental capital leading to substantial future costs. These costs are not fully taken into account in the conventional national accounts, which reflect the actual exchange values which prevailed in a particular institutional setting. Once the incidence of these costs is estimated, in our module the adjustments should be made throughout the accounts in Table 1.

The costs of consuming environmental assets consists of the costs caused by the depletion of natural resources and the degradation of the envi-

ronment. Natural resources are mostly valued at exploration costs whereby the depletion of stocks has not been taken into account. For the degradation of the environment no price is charged because no explicit property rights have been claimed. The result of this neglect is a higher net national income. The neglect of these costs could be amended by putting a value on the depleted natural resources that reflects the (future) scarcity. For the costs of the environmental pollution an adjustment should be made by putting a value on (future) environmental degradation. It goes without saying that in this way only first-order effects are taken into account. Subsequent substitution effects will probably reduce the costs again.

In our module, the problem of defensive expenditure (Kuznets, 1971) does not arise since the generation of agents and the damage to the environment is booked as a negative attribute to the production and consumption activities. The treatment of these agents by the government and the compensation or repair of the losses then results in an enlargement of environmental functions so the outlays for this can still be booked as final consumption.

The construction of an adjusted net product measure will be a process of extensive computation, involving many assumptions and, depending on the method, more or less intricate modelling for which this module delivers the necessary statistical information as well as a framework for presentation. The adjustment however only takes into account environmental aspects of production and consumption, so that the constructed indicator does not become an index of human welfare. Nevertheless, its changes over time might be juxtaposed with the conventional set of macro-economic aggregates, which remain intact, so that a proper evaluation can be made.

## REFERENCES

- Alarcon, J.V., van Heemst, J., Keuning, S.J., de Ruijter, W. & Vos, R., 1990. The Social Accounting Framework for Development: Concepts, Construction and Applications. Gower, Aldershot.
- Barker, Terry, 1990. The Treatment of the Environment in a SAM for Europe. Paper presented at the Conference A SAM for Europe, Valencia, Spain.
- Boo, A.J. de; Bosch, P.R.; Gorter, C.N. and Keuning S.J. An Environmental Module and the Complete System of National Accounts, National Accounts Occasional Paper, No. NA-045 (1992), Voorburg, Netherlands Central Bureau of Statistics.
- CBS, 1990. Environmental Statistics of the Netherlands 1990. Netherlands Central Bureau of Statistics, 's Gravenhage.
- Daly, H.E. 1989. Toward a Measure of Sustainable Social Net National Product. In: Ahmad Yusuf J., Salh El Serafy, and Ernst Lutz. Environmental Accounting for Sustainable Development UNEP/Worldbank, Washington D.C.
- Gorter, C. N. and P. van der Laan, 1989. An economic core system and the socio-economic accounts module for the Netherlands. Paper for the twenty-first General Conference of the International Association for Research in Income and Wealth, Lahnstein, West Germany.
- Hueting, R., 1989. Correcting National Income for Environmental Losses: Toward a Practical Solution. In: Ahmad Yusuf J., Salh El Serafy and Ernst Lutz (eds), Environmental Accounting for Sustainable Development. (UNEP/World Bank, Washington D.C.)
- Hueting, R. 1991. Calculating a Sustainable National Income: a practical solution for a theoretical dilemma. Proceedings of the special IARIW Conference on Environmental Accounting. 27-29 May 1991.
- Keuning, S. J., 1991. A Proposal for a SAM which fits into the next System of National Accounts. in: Economic Systems Research (forthcoming) and as National Accounts Occasional Paper, No. 37 (1990), Voorburg, Netherlands Central Bureau of Statistics.
- Keuning, S. J. and W. A. de Ruijter, 1988. Guidelines to the Construction of a Social Accounting Matrix, The Review of Income and Wealth, 34, pp. 71-101.
- Keuning, S. J. and E. Thorbecke, 1989. The Impact of Budget Retrenchment on Income Distribution in Indonesia: a Social Accounting Matrix Application, OECD Development Centre Technical Paper, No.s 3 and 3A, Paris, Organization for Economic Cooperation and Development.
- Kuznetz, S., 1971. Economic Growth of Nations: Total Output and Production Structure. Cambridge Massachusetts
- OECD, 1991. Environmental Indicators, progress report. Environment Committee Meeting at Ministerial level, 30th-31st January. Background Paper no. 4. Paris.



- Peskin, H.M. 1989. Accounting for Natural Resource Depletion and Degradation in Developing Countries. Environment Department Working Paper No. 13. The World Bank, Washington, D.C.
- Pyatt, Graham, 1988. A SAM Approach to Modelling. Journal of Policy Modelling, Volume 10, Number 3, pp. 327-52.
- Pyatt, Graham and Jeffrey Round, 1985. Social Accounting Matrices: A Basis for Planning. The World Bank, Washington.
- Repetto, Robert, William Magrath, Michael Wells, Christine Beer and Fabrizio Rossini, 1989, Wasting Assets, Natural Resources in the National Income Accounts, Washington, D.C. World Resources Institute.
- United Nations, 1968. A System of National Accounts. Studies in Methods, Series F, No. 2, Rev. 3, United Nations, New York.
- United Nations, 1990. SNA Handbook on Integrated Environmental and Economic Accounting. Preliminary draft of the part I. General Concepts. New York.
- Vanoli, A., 1986. Sur la structure générale du SCN à partir de l'expérience du système élargi du Comptabilité nationale française. Review of Income and Wealth, Series 32, nr 2.

**Notes on Economic Depreciation of Natural  
Resource Stocks and National Accounting**

**John M. HARTWICK \***

Queen's University at Kingston

INTRODUCTION

In Hartwick [1990] I presented a methodology and formulas for incorporating changes in values of natural resource stocks in an economy's national accounts. The aim was to account for the depletion of stocks from extraction (e.g., oil), from "overuse" (e.g., fishing) and from degradation (e.g., pollution). Essential to the analysis was the assumption that (a) prices reflected true scarcity (perfect competition or optimal planning) (b) property rights were well defined and universal (this is related to (a) via the notion of market failure or departures from perfect competition) and (c) technological progress was, in possibly a statistical sense of averaging, correctly anticipated.

When the first two assumptions fail to hold, one is in the world of the third best, a world in which observed market prices generally fail to reflect basic scarcity. In practice one cannot make good policy prescriptions with observed prices in a world of the third best. When the third assumption fails, current prices again fail to reflect basic scarcities and policy actions are of dubious merit when based on those current prices. Much of the analysis below circles back to this theme of national accounting with "imperfect" prices. But early on we actually make

\* I am indebted to John Livernois, Ngo van Long, and Gerard Gaudet for helpful comments.

use of some prices to calculate economic depreciation of oil stocks in the U.S.

First, I will set out my approach (derived from arguments of Cass and Shell [1976], Weitzman [1976], Solow [1986] and others). An essential ingredient of formulas for depreciating natural resource stocks in the national accounts is the marginal cost of using the resources over the current period, e.g., marginal extraction costs and/or extraction costs and discovery costs. Adelman [1986] presents such rarely reported costs. Another peculiarity of mineral stocks is that new commercially attractive deposits are being discovered each period usually by the purposeful expenditure of resources. We discuss how to incorporate these increments to stocks in the national accounting measures incorporating economic depreciation of natural resource stocks. We also observe how to treat durable exhaustible resources such as gold, silver, copper, etc., as opposed to nondurable resources such as oil, coal, uranium, etc. An important durable non-renewable resource is land and we discuss "mining" land held in virgin forests and transforming it to use in agriculture.

We then consider explicit externalities such as mining activity as it pollutes a fishery and how these externalities show up in our formulas for economic depreciation. Curious "netting effects" show up in our formulas. We discuss the issue of incorporating pollution as a bad in alternate possible places; in particular introducing the stock in the utility functions of agents. And we take up another externality, namely mining directly polluting the environment. We note that property rights failures, non-competitive behavior, and improperly priced pollution activity result in third best outcomes and we relate these equilibria to second best equilibria analogous to the second best equilibria in static analysis. However we do not pursue this tangled issue. We do however note emphatically that actual prices used in national accounting are distorted from true scarcity prices and we discuss difficulties in this terrain.

#### THE MODEL OF DYNAMIC COMPETITIVE GENERAL EQUILIBRIUM

In order to develop principles of national accounting, one needs a benchmark economy and the usual standard is that of a well-behaved

competitive general equilibrium. However the static general equilibrium model of the Arrow-Debreu sort will not do because investment plays an essential role in national accounting. We need an inherently dynamic competitive general equilibrium model. The simplest of these is the aggregate Solow-Koopmans-Cass optimal growth model. The solution path in such an economy reflects efficiency or competitive price-taking behavior by agents. Moreover the savings-consumption decision is made endogenous so that the levels of investment period by period (or instant by instant) are derived from behavioral assumptions and not a consequence of rules-of-thumb. These optimal savings rules imply general time paths of investment and different parameterizations of the underlying tastes and technology will imply distinct investment for a real economy. We can envisage an abstract optimal growth problem which can reproduce the observed economy "on paper". The main point is that optimal growth models can be viewed correctly as dynamic competitive general equilibrium models. We are not contending that any real world economy is optimal. Rather we are arguing that a competitive economy with an essential savings-investment decision can be interpreted as a realization of an abstract optimally growing economy. Aggregate optimal growth models lump the thousands of distinct commodities (e.g., apples, tires, computers, etc.) into a composite commodity and focus essentially on the tradeoff at each instant between allocating produced output to current consumption and current investment. Routine extensions of these early models permit one to focus in addition on the trade-off between dis-investing in exhaustible resource stocks (current consumption of say oil) and "investing" in such stocks by not consuming from them currently. The same notion carries over to renewable and environmental stocks: stock reduction is associated with consumption in excess of the renewal "output" from nature's bounty and non-consumption or investment is associated with stocks increasing because use is less than the natural renewal "output". The unifying notion is that at each instant agents purposefully decide to split various flows into current consumption (a form of disinvestment) and current investment (generally associated with capital stock growth).

These prefatory remarks are intended to explain why we leap into basic optimal growth theory when we wish to discuss national accounting principles. We need a benchmark economy in order to see what notions of

GNP (gross national product), NNP (net national product), NI (national income) etc mean in principle and that benchmark economy is a competitive general equilibrium model with endogenous savings and investment decisions. In competitive general equilibrium, we have a fairly good idea what relative prices mean and how they reflect basic scarcity. In other contexts the meaning of prices is less clear and thus accounting entities constructed with such prices are difficult to interpret. This point of course is not new. Kuznets [1948], Samuelson [1950], Weitzman [1976] and others worked out the meaning of national accounting concepts and that meaning derives essentially from meaningful prices which are really meant to be those observed in the context of an abstract competitive general equilibrium.

Let us take up the simplest case - commodities aggregated to one composite, say "wheat" which is durable and can be consumed or added to a capital stock of existing "wheat", and citizens aggregated to one "agent" with a specific single utility function and discount rate  $\delta$ . The optimal growth problem is to find a sequence of  $C(t)$ 's (and outputs  $Q(t)$  and investments  $\dot{K}(t)$ ) which maximize the agent's present value of felicity into the indefinite future. We'll suppose that the population (labor force) moves in an exogenous way, so that  $L(t)$  is a given time path.

We have then output  $Q(t) = F(K(t), L(t))$  where  $F(\ )$  is the production function and  $K(t)$  the current stock of accumulated "wheat". Commodity balance has use equal to production,

$$C(t) + \dot{K}(t) = F(K(t), L(t))$$

or

$$\dot{K}(t) = F(K(t), L(t)) - C(t)$$

This is our so-called equation of motion for our dynamic system, relating investment to consumption. The present value  $\int_0^{\infty} U(c) \exp(-\delta t) dt$  is maximized by choice of path  $\{C(t)\}$ , where  $U(\cdot)$  is the utility function of the society. Associated with this problem is the current value Hamiltonian

$$H(t) = U(C(t)) + \lambda(t) [F(K(t), L(t)) - C(t)]$$

where  $\lambda(t)$  is a shadow price of  $K(t)$  labelled the co-state variable (essentially a time varying Lagrange multiplier). The problem is an optimum when the Hamiltonian satisfies certain necessary conditions (the

canonical equations). For our purposes the key canonical equation is: the first order condition corresponding to maximizing  $H(t)$  at each date with respect to "control"  $C(t)$ . That is  $\partial H/\partial C = 0$  implies  $U_c = \lambda$  at each date.

Thus

$$\frac{H(t)}{U_c(t)} = \frac{U(C(t))}{U_c(t)} + \dot{K}$$

If in addition we approximate  $U(C)$  by  $CU_c$ , we obtain

$$\frac{H(t)}{U_c(t)} = C(t) + \dot{K}(t)$$

or the normalized current value Hamiltonian defines at each date the NNP function,  $C + I$ .  $H(t)$  is measured in utils and  $H/U_c$  is measured in dollars. This transformation is our "normalization" of the current value Hamiltonian. We have demonstrated that in optimal growth, the current value Hamiltonian represents NNP. This is the basic fact which we dilate upon when we consider natural capital goods in addition to man-made capital goods.

We have glossed over the labor market to this point. This is reasonable since it is assumed to be functioning optimally at each date given the exogenous supply,  $N^S(t) = \bar{N}^S(t)$ . We can be more precise and formal about this. So doing will help later on when we consider an economy with pollution. Labor supply equals labor used or hired in our economy. This can be treated formally as a static constraint on the current value Hamiltonian

$$\mathcal{H} = U(C) + \lambda(t) [F(K, N) - C] + \Omega(t)[\bar{N}^S(t) - N]$$

where  $\Omega(t)$  is a Lagrangian multiplier (distinct from co-state variable  $\lambda(t)$ ) and  $\bar{N}^S(t) - N = 0$  is the labor supply equals labor demand constraint. Now  $\frac{\partial \mathcal{H}}{\partial N} = 0$  implies  $F_N = \frac{\Omega(t)}{\lambda(t)}$ . Recall that  $\lambda(t) = U_c$ . Thus  $F_N = \frac{\Omega(t)}{U_c} = w$ , i.e., the marginal product of labor equals the util shadow price  $\Omega(t)$  normalized by the util value of a unit of consumption. If, as before, we write  $U(C) = CU_c$  and divide  $\mathcal{H}$  by  $U_c$ , we get the NNP function

$$\text{NNP}(t) = C + \dot{K}$$

Note the labor constraint takes value zero in equilibrium, since labor demanded equals labor supply, and so the labor constraint does not show up in the NNP function, as we expect. We will continue to ignore the labor variable until we discuss pollution and property rights.

NNP AND EXHAUSTIBLE RESOURCES

Suppose now output uses say oil  $R(t)$  from a known stock in the ground  $S(t)$ . That is  $Q = F(K, L, R)$  at each date. Stock size  $S(t)$  declines by an amount equal to current extraction, or

$$R(t) = -\dot{S}(t)$$

Let us assume that  $f(R)$  is the amount of "wheat" required to extract oil,  $R(t)$ . Then,

$$\dot{K} = F(K, L, R) - C - f(R)$$

We now have two state variables,  $S(t)$  and  $K(t)$ , and two control or decision variables  $C(t)$  and  $R(t)$ . Our current value Hamiltonian is now

$$H(t) = U(C) + \lambda(t) [F(K, L, R) - C - f(R)] + \psi(t) [-R(t)]$$

where  $\lambda(t)$  is a co-state variable or shadow price of  $K(t)$  and  $\psi(t)$  is a co-state variable or shadow price of  $S(t)$ . Optimality requires that  $\partial H/\partial C = 0$  and  $\partial H/\partial R = 0$ . These conditions imply that  $\lambda(t) = U_c$  and  $\lambda(t)[F_R - f_R] = \psi$  and  $\psi/U_c = [F_R - f_R]$ . Then,

$$\frac{H}{U_c} = C + \dot{K} - [F_R - f_R]R$$

given  $U(C) \approx CU_c$ . Our new NNP,  $H/U_c$ , has a price,  $F_R$ , minus marginal extraction cost  $f_R$ , multiplied by current extraction  $R$  (equal to stock diminution -  $\dot{S}(t)$ ).  $F_R - f_R$  is called rent or user cost on the marginal ton extracted. Thus  $[F_R - f_R]R$  is an aggregate rent on the stock of the exhaustible resource which is currently used up or "wasted". Since  $F_R - f_R$  is sometimes called dynamic or Hotelling rent,  $[F_R - f_R]R$  is total Hotelling rent on the amount currently extracted. This rent is to be netted out from  $C + \dot{K}$  to allow for the using up of the exhaustible resource stock  $S(t)$  over the period.<sup>1</sup> We have

<sup>1</sup> An early reference to the relationship between GNP, NNP and natural resources is A. Marshall [1936, Book VI, Chapt. I, pp. 523-24].

"The labour and capital of the country, acting on its natural resources, produce annually a certain net aggregate of commodities, material and immaterial, including services of all kinds. The limiting word "net" is needed to provide for the using up of raw and half-finished commodities, and for the wearing out and depreciation of plant which is involved in production: all such waste must of course be deducted from the gross produce before the true or net income can be found. And net income due on account of foreign investments must be added in. This is true net annual income or revenue; or, the national dividend: we may, of course, estimate it for a year or for any other period".

*PRINCIPLE ON DEPRECIATING NATURAL RESOURCE STOCKS IN THE NATIONAL ACCOUNTS:*

To depreciate natural resource stocks, subtract from "basic" NNP the amount of stock used up over the accounting period weighted by the marginal value of a unit, namely its price net of the marginal cost of "producing" a unit of the stock.

An abbreviation of this rule is: deduct the quantity of stock used up weighted by its dynamic rent per unit. This rule presumes that markets are competitive so that price minus marginal cost includes no monopoly or oligopoly component.

What is the intuition underlying economic depreciation? It is simply the loss in value of a durable asset from optimal use. The change in the market value of a mine at date  $t+1$  and at date  $t$  after the mine has been extracted from efficiently is precisely economic depreciation. In taxation, the principle followed is to allow mining companies a "depletion allowance" because the market value of their company is shrinking each year as extraction proceeds. Taxation is based on the current market value of the company, the value net of the "depletion allowance". That is, taxes are levied on profits corresponding to a firm of a specific size or value, namely one for which shrinking or a "depletion allowance" has been factored in the estimated value of the firm. These considerations seem in principle straightforward for mining companies because one can readily see the physical shrinking of the deposits owned and conceptualize a decline in value for the firm in a world of zero inflation. In an ideal world "depletion allowances" would be correctly calculated economic depreciation.

For non-mining firms, the notion of optimally using one's durable assets and calculating their loss in value from optimal use seems too tricky to arrive at. But this is what economic depreciation is in fact for such firms. One can see why tax authorities end up with somewhat arbitrary rules of thumb for actually allowing depreciation of durable capital to be written off. With mining firms it is somewhat easier to conceptualize the decline in the value of the firm as the known reserves are worked or run down. In Hartwick and Lindsey [1989] I demonstrated that Hotelling Rent does capture the decline in value of a firm, for the particular case of a known, homogeneous stock of reserves. In Hartwick [1991] I addressed this



issue for the case of a firm which jointly explores and extracts. In this latter case Hotelling Rent will not quite equal economic depreciation.

The now standard procedure for introducing heterogeneity in stocks is to postulate that each ton of extracted and refined ore involves a distinct cost of extraction and processing. The well behaved cases involve unit costs rising as the deposit is worked. Formally one has extraction and processing costs depending on where one is in the deposit or extraction and processing depend on the amount of stock remaining at a given date. In our model we will have extraction (and processing) costs  $f(R)$  now depend on stock remaining or  $f(R,S)$  with  $f_s(\ ) < 0$ . This formalizes the idea that stocks are heterogeneous. Remarkably enough our rule for depreciating stocks is unchanged. We still must deduct  $[F_R - f_R]R$  from "gross" NNP as before. The formula remains unchanged; we do not claim that the time path of variables is the same with or without heterogeneity in the stock.<sup>2</sup>

The issue of getting unit costs correct in economic depreciation measures can be made clear with a familiar diagram. At any date in a program of on-going extraction, extraction costs might be as in Figure 1.

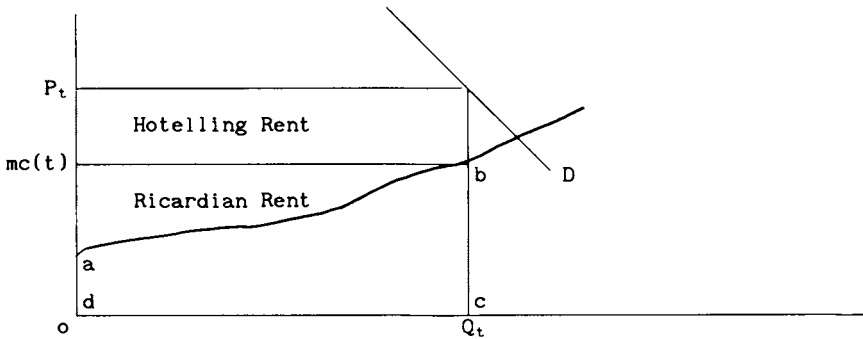

Industry Snapshot

Figure 1

<sup>2</sup> In work with partial equilibrium models of the classic Hotelling sort (e.g., Hartwick and Lindsey [1989]), we did not observe "heterogeneity-of-stock" effects washing out of the economic depreciation formulas. It is unclear why this is so.

We assume each producer has slightly different costs of extraction per ton. One can think of each unit of homogeneous, processed output as coming from more ore as the total stock in the economy is worked. More ore means increased cost per unit of salable output. The deposit as an aggregate is becoming thinner in terms of useful output as it is worked. The correct unit cost figure for our calculations is  $mc(Q(t))$  in Figure 1.  $[p_t - mc(Q_t)]Q_t$  is of course Hotelling Rent and is the basic entity in measures of stock depreciation. Any cost other than  $mc(Q(t))$  will not yield the current basic economic depreciation measure. The correct marginal cost can be interpreted as the unit cost of operating the marginal deposit, that with the currently highest unit extraction cost. Any averaging of extraction cost will yield "Hotelling Rent" in excess of what it should be.

Figure 1 provides a convenient guide as to how a national accounts would be in an economy specialized in extraction of mineral. The large quadrilateral  $pQ$  is the gross national product (GNP) concept. It corresponds on the income side to dynamic rents (Hotelling Rent in Figure 1), Ricardian Rent and payment to other inputs such as wages and rentals to machine owners (area  $abcd$ ) representing total direct extraction costs. NNP is GNP net of economic depreciation or  $pQ$  minus Hotelling Rent.

Discoveries of new stock represent increments to known supplies and should be incorporated in a figure for net changes in stock size and value. Suppose stock on any date is represented by known stock,  $S$ , discovered earlier plus current discoveries,  $D(t)$ . Then  $\dot{S} = -R + D$  and extraction costs—from-inventory are as before  $f(R,S)$ . But discoveries depend on how difficult or costly it is to locate remaining ore. A simple formulation of this idea is to say current discovery costs rise as an increasing function of remaining potential discoveries. Let cumulative discovery to date  $X(t)$  be a proxy for potential discoveries. Then discovery  $D(t)$  costs  $g(D, X)$  and of course  $\dot{X}=D$ . Our Hamiltonian is now:

$$H = U(c) + \lambda(t) [F(K(t), L(t), R(t)) - C(t) - f(R,S) - g(D,X)] + \psi[D-R] + \phi D$$

Then

$$NNP = C + \dot{K} - [F_R - f_R]R + Dg_D$$

Clearly discovery costs  $Dg_D$  "dissipate" the earlier depreciation charge,  $[F_R - f_R]R$  somewhat. This is intuitively correct of course. Discoveries

make depreciation charges arising from resource "use", less than when no discoveries exist.<sup>3</sup>

Actually  $-[F_R - f_R]R + g_D D$  turns out to be the sum of the depreciation charge associated with a unit of  $S(t)$  namely  $-[F_R - f_R][R - D]$  and the charge associated with a unit of cumulative discoveries,  $X(t)$ , namely  $\{g_D - [F_R - f_R]\}D$ . In an efficient, competitive economy exploration will be pursued until its marginal cost  $g_D$  equals the gross marginal profit  $[F_R - f_R]$  plus a marginal profit term for future discoveries. Then the depreciation term associated with  $X(t)$  should be negative. Static marginal benefits of exploration equalling marginal costs imply  $g_D - [F_R - f_R] = 0$ . This static approach leaves economic depreciation at  $-[F_R - f_R][R - D]$ , an intuitively plausible entity. The correct value however is  $-[F_R - f_R]R + Dg_D$ .<sup>4</sup>

#### AN EXAMPLE

U.S. Production in 1978 was 2353.91 million barrels. Discoveries were 562 million barrels. Thus R-D was 1791.91 million barrels. Price in 1978 was \$12.15 per barrel and in 1979 rose to \$23.50. We will take the average as an estimate of true 1978 value: i.e. 1978 price is estimated at \$17.80. The extraction cost for the marginal barrel was \$8.06 (Adelman [1986; Table 3]). Hence net price, rent, or unit royalty was \$9.74.

We obtain a value for  $-[F_R - f_R]R + Dg_D$ .  $F_R - f_R$  is 9.74.  $g_D$  is \$3.83 per barrel in 1978 (Adelman [1986; Table 3]).  $R$  was 2353.91 million barrels. Then the economic depreciation term is  $-2353.91 \times \$9.74 + 562 \times \$3.83 = -\$20774.6$ . The Capital Consumption Allowance for the U.S. in 1978 was \$225,500. Thus economic depreciation of oil is  $\{20774.6 / [225,500 + 20774.6]\} \times 100 = 8.4\%$  of the enlarged capital consumption allowance. NNP excluding natural resource stock adjustments was \$1,941,400 million in

<sup>3</sup> Imports of exhaustible resources represent an "outside" supplier depleting its capital or current stock. Thus one must deal only with domestic production, including exports, if one is going to obtain domestic economics depreciation of natural resource stocks.

<sup>4</sup> I am indebted to John Livernois for the above formulation of exploration. He may well disagree with my emphasis in the above rendering.

1978. Our oil depletion stock adjustment is  $20,774.6 / [1,941,400 - 20,774.6] = 1.1\%$  of NNP.

#### MARKET FAILURES

It is well known that observed market prices only reflect basic welfare-optimizing scarcities when there are no market failures anywhere in the economy. This proposition is often expressed by the assertion that perfect competition must prevail. For our purposes this is a very distressing proposition. The Adelman data we used were taken from an article whose central theme was that resource stock owners do not follow wealth maximizing extraction programs. We might add that world oil markets are generally regarded as oligopolistic or are imperfectly competitive. These factors suggest that the prices and probably the marginal costs we used above are not true measures of scarce resources in the economy. Thus on a priori grounds we believe that our estimates of economic depreciation of oil stocks in the U.S. in 1978 are flawed. How do we proceed?

There are two courses of action: easy and difficult or practical and impractical. We can assert that distortions in the economy move in opposite directions and on average cancel each other out leaving observed prices as good approximations to competitive or socially optimal prices. This is the easy or practical approach. A variant of this approach is to make adjustments to prices in the sector under study when obvious distortions are known. Such a procedure runs counter to the message of the theory of the second best which here might be summarized as "two wrongs repaired in isolation, do not make a right". The alternative approach is to analyze the complete economy as a web of distorted prices and to derive a series of adjustments or corrections to be made to observed prices, so that adjusted prices reflect genuine scarcity (as in Mirrlees [1969]). This is the hard and seemingly impractical approach, though researchers have been pursuing it with the aid of computable general equilibrium models in recent years [as in Whalley [1982]]. But let us reflect on further evidence of the basic economic efficiency or lack of it in the oil extraction sector.

Using data for a cross-section of U.S. oil and gas producers, Miller and Upton [1985] indicate that a reasonable conclusion is that firms are following competitive wealth maximizing extraction strategies. Roughly speaking, if one assumes Hotelling's  $r\%$  rule for efficient extraction is being met by the firms, then the data have a plausible interpretation. A purist can fault the empirical analysis in Miller and Upton in many places but the criticism might be termed nit-picking by an optimist. In another study, Nordhaus [1974] constructed an intertemporal global energy supply and demand model and concluded that the then prevailing retail price of oil in the U.S. was unreasonably high relative to prices generated in a socially optimal extraction and use program. Nordhaus transformed the intertemporal multi-source, multi-use trajectory into the solution of a linear program, easy to solve on large computers. He conjectured that the observed price departed from the true scarcity price for one or more of these reasons: actual energy supply was not competitive, but rather oligopolistic; futures markets for oil, coal, natural gas etc. were not complete and this incompleteness could distort future prices which are projected backwards by agents as current prices; or speculative activity could cause observed price trajectories to depart from true scarcity future price paths. Of interest is that Nordhaus did not consider that the wrong choice of key parameters of his analysis were resulting in anomalous results. He performed sensitivity tests and was satisfied with his estimates of key parameters.

We could add other reasons for efficiency in energy markets failing to prevail. For example, common pool situations generally involve some form of extractive racing by competitors. No extractor wishes to defer exploitation and end up with a disproportionately smaller overall "take". Stock size uncertainty and uncertain technical progress can each tilt extraction paths away from those calculated under the assumption of certainty in stock size and technical change. Unanticipated (drastic uncertainty) shocks in the form of new discoveries or new techniques of extraction or a new technology for a substitute imply that current prices are not precise measures of scarcity over the longer term. If one believes that such unanticipated shocks are common, then all calculations done with current prices will be in error; to an extent that is difficult to pin down in general. We remind ourselves that the inadequacy of current prices to

reflect true scarcity makes not only the calculation economic depreciation suspect but makes the meaning of traditional national accounting procedures extremely difficult to work out.

#### ECONOMIC "DEPRECIATION" OF DURABLE EXHAUSTIBLE RESOURCES

Economic depreciation of durable exhaustible resources raises a special issue. In this case, though the stock in the ground shrinks and as such represents a decline in value of a capital good, the stock above ground is augmented by mining, and being durable, represents a rise in capital value. The market analysis of these two opposing tendencies yields a net rise in society's capital or an economic appreciation as a result of extraction. The increment in stock and value above ground more than compensates for the decline in value below ground. For perfectly durable exhaustible resources, the actual economic appreciation is the change in valuation of the amount extracted from being below ground to being above ground at the appropriate scarcity or shadow prices and this change in value turns out to equal the amount currently extracted, weighted by the marginal cost of extracting it. We demonstrate this.

For a durable exhaustible resource, we have  $S(t)$  tons below ground at date  $t$  and  $B(t)$  tons above ground. Then  $-\dot{S} = R(t)$  when  $R(t)$  is current extraction and  $\dot{B}(t) = R(t)$ .  $B(t)$  and  $S(t)$  are state variables.  $R(t)$  is a control variable. Extraction costs are  $f(R, S)$  as before. We will assume that cumulative gold (the durable exhaustible resource) is used as an input in production as in electronics. Then aggregate output is  $F(K, N, B)$ . Our current value Hamiltonian is now

$$\mathcal{H} = U(C) + \psi(t)[F(K, N, B) - C - f(R, S)] + \phi[-R] + \eta[R]$$

Now  $\frac{\partial \mathcal{H}}{\partial C} = 0$ , yields  $U_C = \psi$  and  $\frac{\partial \mathcal{H}}{\partial R} = 0$ , yields  $f_R = \frac{\eta - \phi}{\psi}$ . Expressing  $U(C)$  as  $CU_C$  allows us to write  $\mathcal{H}/U_C$  as

$$NNP = C + \dot{K} + Rf_R.$$

Now  $f_R > 0$  is extraction cost of the marginal ton. Hence "gross" NNP,  $C + \dot{K}$ , must be augmented by  $Rf_R$  to reflect a gain to society from moving a part of a capital good  $S(t)$  from below ground to above ground as a new capital good,  $B(t)$ .

If the gold deteriorated above ground at rate  $\rho(t)$  then  $\dot{B}$  would equal  $R(t)$  minus  $\rho(t)B(t)$  and economic depreciation would become  $Rf_R - [\eta(t)/\psi(t)]\rho B$ . That is economic appreciation would be less, other things being the same. The polar case is of course one with no deterioration or perfect durability and this case involves net economic appreciation in national income from extraction. Mining gold is analogous to investing in new plant and equipment since NNP is augmented by the activity.

#### LAND IN VIRGIN FOREST TRANSFORMED TO LAND IN AGRICULTURE

A particular durable exhaustible resource is land in a virgin state. Typically in economic growth with an increasing population, land is brought out of virgin forests and transformed to use in growing non-forest crops. Often this transformation is known as "slash and burn" and frequently occurs with imperfect property rights on the land in virgin forest. This is assuming that the pace and style of land transformation would be different if private property rights were secure. Then the transformation would typically be slower and take place under say: "harvest and clear" rather than "slash and burn". Our investigation here assumes perfect private property rights. A consequence is that land is only transformed to agriculture when there is a net increase in its value as a capital good. This can be diluted if agricultural use degrades the land's quality (i.e., opens the land to erosion). We combine land use change with potential quality decline in the following sketch.

There is a fixed amount of land  $\bar{L}$  and at any date  $L$  is the amount in agriculture ( $\bar{L} - L$  is in virgin forest).  $\dot{L} = R$  is the amount shifted to agriculture at cost  $f(R)$  in terms of composite produced good, wheat.

$A$  is a fertility index for land in agriculture. The quality adjusted agricultural land is then  $AL$ . Fertility increases naturally at exponential rate  $b$ . Fertility can be increased  $\rho(Z)$  by fertilizing land with  $Z$  units of fertilizer. Fertility is diminished by wheat production  $F(\cdot)$  in amount  $\gamma F(\cdot)$ . The net fertility change at a date  $t$  is then

$$\dot{A} = bA + \rho(Z) - \gamma F(K, N, AL).$$

Thus land  $L$  in agriculture and fertility level  $A$  are two state variables. Fertilizer level  $Z$  is a control variable.

We also have produced capital  $K$  and the increase in  $K$  at level  $\dot{K}$  results from foregoing consumption of wheat currently as in

$$\dot{K} = F(K, N, AL) - C - f(R) - g(Y)$$

where  $C$  is current consumption of wheat,  $R$  is the amount of land brought into agriculture ( $R = \dot{L}$ ) from virgin forest use at cost  $f(R)$ , and  $g(Y)$  is the cost of fertilizing at level  $Y$ .

There are consumption services to citizens from having virgin forests. These might be the sap and nuts gathered. The utility function for society is  $U(C, G(\bar{L} - L))$  where  $G(\bar{L} - L)$  are the services from the virgin forest.

Our current value Hamiltonian is now

$$\mathcal{H} = U(C, G(\bar{L} - L)) + \phi(t) [F(K, N, AL) - C - f(R) - g(Y)] + \psi(t)[R] + \eta(t)[bA + \rho(Y) - \gamma F(K, N, AL)]$$

Now  $\frac{\partial \mathcal{H}}{\partial R} = 0$  implies  $\frac{\psi}{\phi} = f_R$ .  $\frac{\partial \mathcal{H}}{\partial C} = 0$  implies  $\phi = U_C$ .  $\frac{\partial \mathcal{H}}{\partial Y} = 0$  implies

$\eta = \phi g_Y / \rho Y$ . We represent  $U(C, G)$  as  $CU_C + GU_G$ . Then our NNP function  $\mathcal{H}/U_C$  is

$$NNP = C + \frac{U_G}{U_C} G + \dot{K} + f_R R + \frac{dg}{d\rho} \dot{A}$$

The first two terms capture static aggregate consumption at prices 1 for wheat and  $U_G/U_C$  for virgin forest services. The next term is net investment in new buildings, infrastructure and machines and  $f_R R (= f_R \dot{L})$  is economic appreciation arising from bringing virgin forest into agricultural use (assuming  $\dot{L} > 0$ ).  $f_R$  is the marginal cost of transforming a hectare to agricultural use and this marginal cost can be viewed as a wedge between the shadow price of a unit of land in virgin forest and the shadow price of a unit of land in agriculture.  $f_R$  captures the net increase in the value of a unit of land.

$\dot{A}$  will generally be negative during economic growth as erosion and soil degradation takes place with intensive use in agriculture.  $dg/d\rho (= (dg/dY)/(d\rho/dY))$  is the marginal cost of fertilizer in terms of wheat with fertility effect  $\rho$ . Alternatively, it is the marginal cost of increasing the fertility index  $A$  one unit when the current improvement level from fertilizer is  $\rho$ . Then  $(dg/d\rho)\dot{A}$  is the cost of degradation  $\dot{A}$



(negative) in terms of wheat. It is the economic depreciation in the quality of land in agriculture.

The striking result is of course that a unit of land in agriculture is implicitly more valuable and hence here costly "slash and burn" yields an economic appreciation. Instead of costly clearing, one can envisage profitable clearing as the virgin forest is harvested and the land cleared ("harvest and clear"). One can envisage the value of the forest harvested and marketed as exceeding harvesting and clearing costs. Then our costs  $f(R)$  above become net benefits. For  $f(R)$  a net benefit, one observes that the economic change in the capital value of land in agriculture is now negative and thus that "harvest and clear" introduces economic depreciation of agricultural land in amount  $Rf_R$ . Again  $f_R$  is capturing the difference between the shadow price of a unit of land in agriculture and in virgin forest. However now the unit value wedge of land at the margin declines as measured by the marginal benefit of harvesting the virgin timber.

Fertility deterioration is formally similar to environmental stock deterioration from pollution caused by economic activity. In our formulation above, there are implicit Pigovian taxes being charged on inputs to wheat production to reflect the marginal damage caused from increases in wheat production. We discuss these sorts of optimal taxes below when we discuss pollution or degradation of environmental capital.

#### RENEWABLE RESOURCES (NO MARKET FAILURES)

In a growing economy it may be optimal to harvest fish at rates which erode the current stocks. In the very long run, this would involve extinction or an asymptotic variant of extinction and we will not pursue this issue here. We are simply interested in factoring in economic depreciation of the renewable resource stocks as the stocks are run down from rational harvesting.

The price of fish in the market will emerge from the interaction of supply and consumer demand. Thus the aggregate utility function will depend on wheat consumed  $C$  and fish  $H$  as in  $U(C,H)$ . The stock at any date is  $Z(t)$ . Natural processes result in the stock increasing by  $\phi(Z)$  in a period

including a  $\phi_z(Z_{\max}) = 0$  for a carrying capacity corresponding to  $Z_{\max}$ . At any date  $\dot{Z} = \phi(Z) - H$  is the net change in fish stock. With exhaustible resources  $\phi(Z)$  is not present because there is no natural growth in the stock as there is with fish reproducing. Thus we have two differences here from the analysis with exhaustible resources. First we have fish harvested appear as a consumer good with implicit price (which will be the market price)  $U_H/U_C$  and secondly our stock has a capacity to renew itself. Harvesting does not necessarily reduce the current known stock over the period in question. Natural growth can offset the effect of harvesting. Despite these changes, economic depreciation of the stock turns out to be the rent on the net stock decline  $\dot{Z}$ . To see this we write down our current value Hamiltonian corresponding to the socially optimal or competitive markets solution.

$$\mathcal{H} = U(C, H) + \lambda(t) [F(K, N) - C - h(H, Z)] + \eta(t) [\phi(Z) - H]$$

where  $h(H, Z)$  is the cost of harvesting  $H$  units of fish given stock size  $Z(t)$ . The two local in time maximizing conditions  $\frac{\partial \mathcal{H}}{\partial C} = 0$  and  $\frac{\partial \mathcal{H}}{\partial H} = 0$  yield  $U_C = \lambda$  and  $U_H = \lambda h_H + \eta$ . Thus  $\eta(t) = \frac{U_H}{U_C} - h_H$  and the

$$NNP = C + \frac{U_H}{U_C} H + \dot{K} + \left[ \frac{U_H}{U_C} - h_H \right] \dot{Z}$$

where we approximate  $U(C, H)$  by  $U_C C + U_H H$ . Since  $\dot{Z}$  will generally be negative in a growing economy, gross NNP is reduced by the price of fish,  $\frac{U_H}{U_C}$ , minus its marginal cost  $h_H$  or rent per unit of fish multiplied by stock diminution  $\dot{Z}$ . Obviously this is in principle identical to the concept we obtained for economic depreciation exhaustible resource stocks.

Gordon [1954] made clear how property rights failure in fish stock ownership (common property) resulted in over-fishing. Inadequate property rights implies an inefficiently low shadow price on stock (rent dissipation). To a rough approximation, this property rights failure will show up as an observed harvest in excess of the socially optimal level and an excessively small unit rent  $[U_C/U_H - h_H]$ .  $Z(t)$  will be awry also, probably smaller than its socially optimal level. These guesses are bothersome enough to make, but we know that the property rights failure will spill over into all other magnitudes, e.g.,  $\lambda$ , the shadow price on  $K$  and  $\dot{K}$  the level of investment in new produced capital  $K$ . In addition the time path  $\{C(t)\}$  will be distorted by the property rights failure in fish

stocks. The observed "equilibrium" would be a third best; i.e., one in which social welfare unconstrained or constrained is not being maximized. A second best involves maximizing social welfare subject to constraints. With a rent dissipation constraint each scarcity price or shadow price would differ from its market price by an optimal "wedge", essentially emanating from the price equals average cost constraint. Such an outcome is a second best economy. The real world is however a third best equilibrium in which there are no optimal "wedges" or true scarcities reflected in market prices. We return to these issues below. Immediately below we introduce an explicit distortion in the form of pollution and solve the implicitly competitive solution with optimal "wedges". This will illustrate a second best equilibrium.

#### RENEWABLE RESOURCES (POLLUTION FROM MINING)

A well-circulated idea is that extraction of minerals frequently pollutes the air and the water. Chemicals used in extraction often end up in nearby rivers and kill off aquatic life. Perhaps more pervasive is the pollution caused by the refining per se of ores. Let us formalize these external costs and see how they affect our formulas for economic depreciation of natural resource stocks. We have our formulas above derived under the assumption of no externalities as benchmarks.

We assume that R tons of exhaustible resource extracted inhibits growth of the renewable resource stock by P(R), P( ) for pollution.  $P_R > 0$  or more mining results in greater choking off of fish growth. To keep matters transparent, we will ignore exploration activity in the exhaustible resource sector. Our current value Hamiltonian is now

$$\mathcal{H} = U(C, H) + \lambda(t) [F(K, L, R) - C - f(R, S) - h(H, Z)] + \psi(t)[-R(t)] \\ + \eta(t)[\phi(Z) - H - P(R)]$$

Maximization with respect to C, H and R for each date yields

$$NNP = C + \frac{U_H}{U_C} H + \dot{K} - \left\{ \left[ \bar{F}_R - f_R \right] - \left[ \frac{U_H}{U_C} - h_H \right] P_R \right\} R + \left[ \frac{U_H}{U_C} - h_H \right] \dot{Z}$$

Two observations are in order concerning this new statement of NNP. First the shadow price of mineral is lower because each unit mined causes pollution, i.e., has negative economic consequences. This new shadow price

is  $F_R - f_R - \left( \frac{U_H}{U_C} - h_H \right) P_R$  where  $\frac{U_H}{U_C} - h_H$  is the shadow price on the fish stock. Since  $P_R > 0$ ,  $\left[ \frac{U_H}{U_C} - h_H \right] P_R$  is positive. This translates into each unit of mineral stock being worth less than before because each unit causes pollution as it is extracted. Given R the same in a model with and without pollution, we have the result that economic depreciation is smaller in the polluted economy! A lower value should be netted out from "gross" NNP when pollution is caused by mineral extraction.<sup>5</sup> We observe this again below when we consider mineral extraction polluting "the environment". Our second observation is that the formula for economic depreciation of the fish stock is unchanged.

The formulas point to economic depreciation of stocks being less when there is pollution caused by mineral extraction. However the time paths of endogenous variables will be much different in the different cases; namely an economy with a pollution "cycle" and one without. Thus we cannot assert that actual economic depreciation of mineral stocks will be lower in the polluted economy. Both the formulas and the values of the variables differ between the economies in the two cases.

This is a second best economy because (a) social welfare is being optimized albeit in the face of an externality or pollution constraint and (b) the solution values (C, H,  $\dot{K}$ , R, K, Z) reflect a constrained optimal program because optimal "wedges" are present. In this case each resource owner is treating his or her stock as if its marginal value was  $[F_R - f_R] - \left[ \frac{U_H}{U_C} - h_H \right] P_R$  and not simply  $F_R - f_R$ . The optimal wedge here is  $\left[ \frac{U_H}{U_C} - h_H \right] P_R$ . Immediately below we take up another second best equilibrium, a generic pollution scenario in which productive activity causes pollution as a negative by-product.

#### DEPRECIATION OF ENVIRONMENTAL CAPITAL

Pollution or stress on environmental capital is, from an economic point of view, an intrinsic by-product of otherwise productive economic activity.

<sup>5</sup> This result "goes through" at the level of the firm and as such implies that the tax base for polluting mining firms should be larger than that for non-polluting mining firms. That is allowable depreciation is smaller for a polluting mining firm than for a non-polluting mining firm.

One's reflex is to say pollution should be eliminated; but zero emissions or residuals can usually only be associated with zero productive activity. The negative by-products will always be present. Pollution control is asking that the flow of emissions or residuals be set at a level such that natural dispersal and natural degradation prevent build up of the emissions of residuals in the environment. Constraining the flows of emissions and residuals involves the familiar array of instruments: taxes or prices for flows or quantity controls (standards). A useful view is that instruments of control change the institutional setting from one of no property rights enforced on the environmental capital (common property) to one of enforced rights. Since environmental capital can correctly be viewed as a capital good useful in production in the sense that it cleans the production process and leaves the production process in good order for additional production, it should be rationed so that its services go to the highest bidder and secondarily its services are not choked off by over-use. One interpretation of rationing the services of a capital good is that an owner "lets out" its services as in a piece of land so as to maximize the present value of "surplus" from the capital good. In a well-functioning economy rationing via the granting of secure private property rights is generally enough to cause an optimal use of resources in the economy. With environmental problems there is the problem of assigning the property rights and having such rights enforced. Economists generally view property rights enforcement as approximately costless but with environmental capital, one needs an administrative apparatus to set "prices" and/or standards and collect charges and/or ensure that standards are being met.

A short-hand way for expressing degradation of environmental capital is to say that the stock of pollutants suspended in air and/or watersheds has increased. Since pollution is more easily measured than environmental capital, we pursue our analysis of economic depreciation of environmental capital in terms of pollution levels. The environment is used to dump residuals from productive economic activity and it becomes polluted as long as it cannot dissipate the residuals as fast as they are "dumped". We might have, then,  $\dot{E} = -bE + \gamma Q$  where  $E$  is the amount of pollution suspended (a stock notion) and  $Q$  is productive output elsewhere in the economy.  $\gamma Q$  is pollution added to airsheds and watersheds by output  $Q$  and  $-bE$  is the "evaporation" of pollution by natural processes. In this

formulation b is the rate of "radioactive decay" of the pollution stock by natural processes. More generally we might postulate  $-b(E)$  as the amount of "evaporation" of pollution per unit time given current pollution stock  $E$ . Pollution here is a negative by-product of other productive economic activity.

By pollution abatement we might mean taking action to make  $\gamma$  a smaller number, corresponding to each unit of productive output causing less pollution. We can introduce flow costs  $\alpha(\gamma)$  to keep  $\gamma$  at same current level. The larger is  $\alpha(\gamma)$ , the lower will be  $\gamma$ .

Pollution can reasonably impinge negatively in two places. It can constrain current production in the sense that the larger is the pollution stock  $E$ , the lower is the output of "wheat",  $Q$ . In addition we might argue that pollution has direct negative effects on welfare so that  $U(C, E)$  reflects the fact that a larger  $E$ , more pollution, corresponds to a lower level of utility, given  $C$  constant. The current value Hamiltonian for this problem is

$$\mathcal{H} = U(C, E) + \lambda(t)[F(K, N, E) - C - \alpha(\gamma)] + \psi(t) [-b(E) + \gamma F(K, N, E)]$$

Key first order conditions,  $\partial \mathcal{H} / \partial C = 0$  and  $\partial \mathcal{H} / \partial \gamma = 0$  yield  $\lambda(t) = U_C$  and  $\psi(t)/U_C = \frac{d\alpha}{d\gamma} / \left( \frac{d\gamma F}{d\gamma} \right)$ . Since  $\gamma F$  is units of pollution (the extra residuals resulting from current "wheat" production  $F$ ) we can express  $\psi(t)/U_C = \Delta\alpha/\Delta E$  which is the wheat value of an extra unit of pollution. We approximate  $U(C, E)$  by  $CU_C + EU_E$ . Then the current value Hamiltonian ( $\mathcal{H}/U_C$ ) can be expressed as

$$NNP = C + EU_E/U_C + \dot{K} + (\Delta\alpha/\Delta E)\dot{E}.$$

Since  $d\alpha/d\gamma < 0$ ,  $\Delta\alpha/\Delta E < 0$ . Thus  $(\Delta\alpha/\Delta E)\dot{E}$  is the economic depreciation of environmental capital as the pollution stock  $E$  increases during economic growth. I.e. gross NNP must be reduced by the increase in the pollution stock valued at its marginal "draw-down" of wheat or amount of wheat foregone at the margin.  $\dot{E}$  is the increase in pollution stock over the accounting period.

In addition there is a netting out of the consumer disutility from having to live with the current stock. That is,  $U_E < 0$  and  $(U_E/U_C)$  is the wheat

price of a unit of pollution and  $E U_E/U_C$  is the consumer value (negative) of the current stock,  $E$ . There are then two nettings out: one for economic depreciation of environmental capital, namely  $(\Delta g/\Delta E)\dot{E}$  and one for damages to "consumers" from the pollution stock, namely  $E U_E/U_C$ .

What about the general result of stock reduction weighted by price minus marginal cost? First our environmental stock reduction is here pollution stock increase. This results in price being negative (i.e.,  $U_E/U_C < 0$ ), marginal cost being negative (i.e.,  $\Delta g/\Delta E$ ), and stock size change being positive (i.e.,  $\dot{E} > 0$ ). Thus symmetry with early economic depreciation results obtains, though with sign reversals throughout. One other variation. Here marginal cost and stock size change are flows. This is what we observed for earlier economic depreciation formulas. Now however price ( $U_E/U_C$ ) relates to the stock and not to the flow. This causes our adjustment to the national accounts to segment into a separate stock value component ( $E U_E/U_C$ ) and a separate stock increment component ( $\dot{E} \Delta \alpha/\Delta E$ ). This separation is new to us because we are dealing with market prices related to stocks for the first time and not market prices related to flows as we did earlier.

Usher [1981; pp. 130-134] has reservations about introducing certain variables representing "atmosphere" (our term) into agents utility functions. He takes average hours of sunshine as an example. First he objects to having items in the utility function which are largely unaffected by human activity. Since ultimately it is economic activity vis-a-vis human welfare one is interested in measuring, one should omit variables largely unaffected by human activity, such as average hours of sunshine. If however human activity does alter average hours of sunshine, even in a once over change, then the resulting change in welfare for those who "consume" sunshine should be calculated. (This first contention of Usher is present but not emphasized in his book but has been explained to me in helpful discussions with him). The second reservation he has is that calculations of the growth of welfare with average hours of sunshine included can be less meaningful than the same calculation with hours of sunshine omitted. Thus suppose we do a calculation and average hours of sunshine remain approximately constant over the interval.

"When sunshine is treated as an environmental condition, the fact, if it be so, that hours of sunshine have not increased over the years...has no effect whatsoever on our measure of the rate of economic growth. If sunshine were inputted as an ordinary commodity, we would have to say that the failure of the number of hours of sunshine to increase means that the true rate of economic growth is lower than a computation that did not take sunshine into account would show it to be". (p. 133-34)

And further on Usher defends the introduction of pollution as an argument in the utility function if there are definite changes in the levels of pollution over time. Pollution as an "environmental variable" (Usher's term) is principally a result of human activity and as such passes Usher's first hurdle for introduction in the utility function. Whether to put changes in levels in the utility function or levels per se is not an issue provided the correct implicit "price" is assigned to the variable. The "price" in question should be different for stocks and for flows. In earlier analyses of economic depreciation of environmental capital (Hartwick [1990], [1991a]), I introduced changes in the stock of pollution into the utility function. This "worked" but is not elegant and upsets those who feel intuitively that it is the stock which matters to consumers and not just increments in the stock. Netting out a valuation of current disamenities such as pollution and traffic congestion seems practicable and appropriate. These nettings out are however distinct from those involved with economic depreciation of environmental capital.

To carry out a correct accounting with degrading environmental capital, one needs consumer prices  $U_E/U_C$  as well as a solid measure of pollution stock  $E$ .  $E$  is presumably easier to quantify than is  $U_E/U_C$ . This price is the dollar value of the disutility of an extra unit of pollution. Careful observers have been pondering how to estimate such prices for at least a decade and good progress has been made (see for example Pearce and Turner [1990]). Small scale empirical studies have been done in many instances. In national accounting, one needs agreed upon prices for a diversity of pollutants, "averaged" over different types of consumer and those in different regions. Questionnaires have been used by some to obtain such prices. These surveyors get estimates of willingness-to-pay to have a pollutant reduced at the margin and willingness-to-receive marginally more



pollution with appropriate dollar transfers as compensation. Appropriate prices emerge in these exercises.

The other price we require is the marginal reduction in NNP or in output of wheat required to reduce the pollution stock by a unit. This is a measure of marginal "defensive" expenditure in pollution control: for current emissions to decline by one unit, we require a commitment of  $k$  dollars to new technology of emissions control.  $k$  is the datum we require.  $k$  corresponds to the best technical approach (least cost) for achieving a unit reduction in emissions. In fact "pollution" is a vector of diverse emissions and/or residuals and so we would be in fact considering the least cost way of reducing a group of pollutants, each by a unit. It is this number  $k$ , weighting current pollution stock increases, which is our measure of economic depreciation of environmental capital.  $\Delta\alpha/\Delta E$  is a marginal cost entity. There is no price counterpart because the flow  $\dot{E}$  appears neither as an input in production ( $E$  might however) nor as an argument in the utility function (again where  $E$  has been placed).

#### THE REAL WORLD IS THIRD BEST

A general welfare result is the following: if sector  $i$  is not competitive and all other sectors of the economy are, observed prices do not reflect a quasi optimal allocation of resources. Either all sectors must be competitive in order for market prices to reflect genuine scarcities or if one is distorted, all remaining prices must, in general, be adjusted by a planner in order for the allocation occurring at those adjusted prices to reflect a constrained social optimum (a second best).

One might be inclined to say: we know sector  $i$  is a monopoly and so we will lower its observed price before we construct NNP. Lowering the price requires that an adjustment also be made in its quantity. This is a perilous procedure because in general equilibrium a distortion in sector  $i$  spills over, implying distortions in most other sectors in the economy. They also need adjustments in their prices and quantities. The directions and magnitudes of the changes are very difficult to estimate or to guess at intelligently. A variant of this problem is known in the literature as "piecemeal welfare analysis". (See Hatta [1977].)

Some idea of "the distorted pricing problem" can be obtained from considering second best economies in more detail. Our economy with a pollution sector has in fact been modeled as a second best economy. In our situation, we introduced a distortion in the form of production yielding output plus a "bad" or negative externality, namely pollution. Implicit in our modeling was that correct Pigovian taxes for pollution effects were being charged to make the resource allocation (physical flows of goods and services) a second best optimum.

The easiest way to see that prices reflect marginal pollution effects is to consider the wage rate. Recall that the labor supply  $\bar{N}^s(t)$  equals labor demanded in the production of wheat. Formally the wage rate is the Lagrangian multiplier on this constraint, normalized by marginal util value, and now adjusted for the pollution damage caused by an increase in labor in the wheat sector. That is, with the labor constraint, our current value Lagrangian (constraint Hamiltonian) is

$$\mathcal{L} = U(C, E) + \lambda(t)[F(K, N, E) - C - \alpha(\gamma)] + \xi(t)[-b(E) + \gamma F(K, N, E)] \\ + \Omega[N^s - N]$$

Now  $\frac{\partial \mathcal{L}}{\partial N} = 0$  implies  $F_N + \frac{\xi}{\lambda} \gamma F_N = \frac{\Omega}{\lambda}$ . The wage rate defined inclusive of corrective taxes for internalizing the pollution damage caused by a larger  $F$  induced by a marginal increase in labor is  $w = \frac{\Omega}{\lambda} - \frac{\xi}{\lambda} \gamma F_N$  where  $-\frac{\xi}{\lambda} \gamma F_N$  is a tax on a unit of labor. (Recall that  $\xi < 0$  because more pollution reduces welfare). Implicit in this formulation is the notion that the marginal product of labor,  $F_N$ , overestimates labor's true worth because besides producing output, labor indirectly causes more pollution. As our model economy operates, labor is implicitly priced to reflect its contribution at the margin to pollution. It is as if perfect property rights on pollution rights or environmental capital are in effect. A lack of property rights on environmental capital would be reflected in wage rates not being defined inclusive of marginal pollution damage. That is labor is overused or under-priced when its indirect pollution effect is not taken account of in the price charged for labor.

In order to incorporate the more realistic case of property rights failure we need to constrain the shadow price on pollution to lie below its first best value. Pollution "problems" are generally associated with an

underpricing (over-use) of the environmental capital. To formally capture these real world pricing situations, we need to add a constraint to our model indicating that the price charged for pollution is artificially (non-first best) low. This is an exercise in the theory of the second best (see for example Green [1961] or Dixit [1975]) and we leave such an investigation for another occasion.

The technology of abatement is treated as state-of-the-art and given. Presumably technical change in pollution abatement technology may be the principal source of gains in environmental cleanliness in the future. The whole subject of R & D and technical change requires explicit treatment in our framework and will be taken up at a future date. We turn to an explicit externality involving environmental capital and the associated economic depreciation formulas.

#### MINING CAUSING POLLUTION

We illustrate the derivation of formulas for depreciating environmental capital when there is an explicit negative spillover from mineral activity, in addition to our generic pollution spillover from the production of "wheat". Somewhat paradoxically, our new formula suggests once more that the economic depreciation of mineral stocks should be valued less when mining not only produces minerals but also pollution. We do not see double damage being calculated: namely damage from stock depletion per se and additional damage from pollution produced in mining. Rather, we see that minerals are somewhat less valuable when their use results in pollution and the same diminution in mineral stocks is treated as causing less "damage" (net economic depreciation) when mining involves pollution than when mining causes no pollution. There remains as before, terms for the damage caused by pollution to consumers and a term for economic depreciation of the stock of environmental capital.

Our new problem includes a pollution production process  $\beta(R)$  increasing with the amount of mineral  $R$  currently mined. Our new current value Hamiltonian is

$$\mathcal{H} = U(C, E) + \lambda(t) [F(K, N, R, E) - C - f(R, S) - g(\gamma)] + \psi(t)[-R] \\ + \xi(t)[-b(E) + \gamma F(K, N, R, E) + \beta(R)]$$

Then  $\frac{\partial \mathcal{H}}{\partial C} = \frac{\partial \mathcal{H}}{\partial \gamma} = \frac{\partial \mathcal{H}}{\partial R} = 0$  yield  $\lambda = U_C$ ,  $\frac{\xi}{U_C} = \frac{g_\gamma}{F}$  and  $\frac{\psi}{U_C} = [F_R - f_R] + \frac{dg}{d\gamma} F [\gamma F_R + \beta_R]$ . Representing  $U(C, E)$  by  $U_C C + U_E E$  and substituting yields our NNP function

$$\frac{H}{U_C} = C + \frac{U_E}{U_C} E + \dot{K} + \left\{ [F_R - f_R] + \frac{\Delta g}{\Delta E} (\gamma F_R + \beta_R) \right\} \dot{S} + \frac{\Delta g}{\Delta E} \dot{E}$$

where  $\frac{\Delta g}{\Delta E} \equiv \frac{dg}{d\gamma} F = \left( \frac{dg}{d\gamma} \right) / \left( \frac{d\gamma F}{d\gamma} \right)$ . Recall  $\dot{S} = -R$  or  $\dot{S} < 0$ . The new term is  $\frac{\Delta g}{\Delta E} (\gamma F_R + \beta_R) \dot{S}$  a positive entry, since  $\dot{S} < 0$  and  $\frac{\Delta g}{\Delta E} < 0$ . Mining causes pollution in two ways. First mining produces say "oil" which increases the output of "wheat" and "wheat" production causes pollution. Hence the term  $\frac{\Delta g}{\Delta E} \gamma F_R \dot{S}$ . Secondly mining causes pollution directly via  $\beta(R)$ . Hence the term  $\frac{\Delta g}{\Delta E} \beta_R \dot{S}$ . Economic depreciation of mineral stocks is

$$[F_R - f_R] \dot{S} + \frac{\Delta g}{\Delta E} (\gamma F_R + \beta_R) \dot{S}$$

The first term is our familiar Hotelling rent term and is negative since  $\dot{S} < 0$ . The second term relates to pollution caused by mining and is positive because  $\dot{S} < 0$  and  $\Delta g/\Delta E < 0$ . Economic depreciation for a given stock depletion  $\dot{S}$  is less when mining causes pollution! Roughly speaking each ton mined is worth less to the economy in utils because each ton mined causes pollution. In the absence of pollution effects from mining, for a given  $\dot{S}$ , each ton mined is worth more to the economy. The higher valuation per ton mined under no pollution effects means of course for any stock diminution  $\dot{S}$ , economic depreciation is more. Recall that  $\left( [F_R - f_R] + \frac{\Delta g}{\Delta E} (\gamma F_R + \beta_R) \right)$  is the dollar-value shadow price of an extra unit of mineral stock to the economy. It is this  $\psi/U_C$  which is the valuator for the  $\dot{S}$  used up over an accounting period.

Note that we still deduct  $\frac{U_E}{U_C} E$  from a measure of gross NNP to allow for the negative effects on utility directly from the stock of pollution. Also the environmental stock depreciation term  $(\Delta g/\Delta E) \dot{E}$  is unchanged. Also we must keep in mind that though the formulas may be the same, the competitive dynamic paths of the economy will be different for the case of pollution introduced into the model or not introduced. Thus the time paths of  $C$ ,  $\dot{K}$ ,  $\dot{S}$ ,  $\dot{E}$  etc will be different if pollution is present. We cannot say that because the economic depreciation term for pollution is unchanged from one

form of the economy (without mining pollution) to another (with mining pollution) that its magnitude will be the same in the two cases.

#### CONCLUDING REMARKS

In this paper, we have outlined a "method" for calculating economic depreciation of natural resource stocks and we have taken up a number of complications. However we have not dealt explicitly with general property rights failures or oligopoly problems. These require an extension of our method or the incorporation of new static constraints into the model. We have seen how exploration activity and externalities caused by mineral extraction affect our basic economic depreciation measures. The basic rent measures become complicated with externality or price "wedges". As a practical matter how should one proceed? Should one search for good measures for the refinements or proceed with basic unrefined rent formulas? The answer turns on the magnitudes anticipated. Will unrefined measures be poor or good approximations to refined measures?

There are two additional practical problems. Our formulas presume that environmental capital is being efficiently rationed or the Pigovian user charges are in effect and are reflected in the observed prices for inputs and outputs as well as in the quantities used in the calculations. In actual economies these Pigovian "taxes" are generally not in effect and thus observed prices and quantities are distorted versions of true scarcity or efficiency prices and quantities. These distortions generally spill over to all sectors of the economy. That is, distortion in sector  $i$  imply that the satisfaction of efficiency conditions in sector  $j$  will generally not yield a constrained optimal allocation. One distortion generally requires further departures from efficiency in other sectors in order for a constrained optimum to obtain. How should the practicing national income accountant proceed?

One approach is to make calculations with observed data which certainly are distorted prices and quantities. Assume the distortions are small and that economic depreciation magnitudes are good approximations to correct values. Another approach is to attempt to correct the distorted prices a priori and then to calculate economic depreciation magnitudes. This latter approach

is sometimes referred to as the shadow price approach and has been used to try to estimate the true value of foreign exchange in an underdeveloped country with many departures from competition in its economy. In our case the distortions are rooted in unpriced use of environmental capital, possible property rights failures in the fishery and oligopoly behavior likely in the resource extractive sectors. The current way to deal with the shadow pricing approach in practice is to construct a computable general equilibrium model of the economy in question (as in Whalley [1982]) and to obtain estimates's directly from perturbations to the empirically articulated economy. Clearly other ad hoc procedures could be used at lower cost to arrive at adjusted distorted prices. Reliability is the obvious desideratum.

The other issue involves technical change or unanticipated shocks to the economy in the future. It is only when one focuses directly on NNP as an artifact of a growing economy that one confronts the issue of the meaning of shadow prices on the capital stock (e.g., Weitzman [1976]). The focusing becomes more pronounced when one considers changes in natural resource stocks, obviously, over time. Shadow prices on resource stocks (co-state variables) become an intrinsic part of deriving expressions for economic depreciation. Our main point is that these efficiency prices reflect a discounting back of the entire future history of the economy. Thus any change in the future history of the economy will be reflected in the calculation of correct scarcity prices on capital stocks. (These prices influence the values of "non-dynamic" prices as well.) Provided the future history is correctly anticipated, current prices will accurately reflect basic scarcities. Correctly anticipated involves anticipating future changes arising from technical progress. If technical change (or any other future shock) is incorrectly anticipated, current prices and quantities inadequately reflect basic scarcity. Prices and quantities will jump to new values when the unanticipated shock occurs. But the pre-shock prices will in no way reflect the post-shock prices and in an important sense are inadequate reflections of fundamental scarcity.

To repeat, these difficulties with unanticipated shocks become clear when one considers national accounts in an inherently dynamic context. They have always been present in arriving at a meaningful estimate of aggregate

economic activity but become focal points when one considers an economy as an entity changing over long periods. The matter can be expressed most simply if one ponders the fact that today's price of oil reflects currently known world reserves. Unanticipated discoveries will cause the current price of oil to drop suddenly, other things being the same. Thus the current price before the discoveries fails to reflect the basic scarcity of oil in the economy.

How is one to deal with this problem? By definition the shifts cannot be anticipated. The best one can say is that our estimates of NNP net of economic depreciation of natural resources are approximations subject to future uncertainty. Of course anticipated shifts in the "environment" of the economy will be capitalized in current prices and quantities - the more accurate the anticipation, the more precisely will current prices reflect basic scarcities.

National accountants may do with the prices they observe in the market place. The less distorted these prices are in the sense that they emerge in an economy characterized by perfect competition and complete property rights, the better will these prices reflect basic scarcities. Undistorted prices permit us to attach welfare significance to NNP and the economic depreciation terms as in Weitzman [1976] and Solow [1986].

We summarize. We have explored "variations" on the theme that rent on current stock use (diminution) should be deducted from gross NNP to obtain NNP net of economic depreciation of natural resource capital. The variations include considerations of exploration activity for new mineral stocks, new estimates of economic depreciation of oil stocks in the U.S., incorporating durable exhaustible resources in our formulas, incorporating externality effects such as mining polluting fisheries and mining polluting the environment directly. New formulas were presented and interpreted. We also considered transforming land in virgin forest to land in agriculture. Open for subsequent research is dealing further with explicitly distorted economics via systematic use of the theory of price distortions. Then we could relate the distortions from say imperfect property rights in the fishery to prices and quantities used in calculating economic depreciation from natural resource stock diminution. Also open is a more detailed

examination of how technical change affects measures of economic depreciation. And no doubt patient readers can think of a host of other matters to explore and/or clarify.

#### REFERENCES

- Adelman, M. [1986] "Scarcity and World Oil Prices", Review of Economics and Statistics, 68, pp. 387-397.
- Cass, D. and K. Shell [1976] "The Structure and Stability of Competitive Dynamical Systems", Journal of Economic Theory, 12, pp. 31-70.
- Dixit, A.K. [1975] "Welfare Effects of Tax and Price Changes", Journal of Public Economics, 4, pp. 103-123.
- Gordon, H.S. [1954] "Economic Theory of Common Property Resources", Journal of Political Economy, LXII, April, pp. 124-142.
- Green, H.A.J. [1961] "The Social Optimum in the Presence of Monopoly and Taxation", Review of Economic Studies, 29, pp. 66-78.
- Hartwick, J.M. [1991] "The Non-renewable Exploring-Extracting Firm and the  $r\%$  Rule", Resources and Energy (forthcoming).
- Hartwick, J.M. [1991a] "Degradation of Environmental Capital and National Accounting Procedures", European Economic Review, 35.
- Hartwick, J.M. [1990] "Natural Resources, National Accounting and Economic Depreciation", Journal of Public Economics, 43, pp. 291-304.
- Hartwick, J.M. and R. Lindsey [1989] "NNP and Economic Depreciation of Exhaustible Resource Stocks", Queen's University, Department of Economics Discussion Paper, No. 741.
- Hatta, T. [1977] "A Theory of Piecemeal Policy Recommendations", Review of Economic Studies, 44, pp. 1-21.
- Kuznets, S. [1948] "On the Valuation of Social Income - Reflections on Professor Hicks' Article", Economica, pp. 1-16 and pp. 116-131.
- Marshall, Alfred [1890] Principles of Economics, 8th ed. [1936] London: Macmillan.
- Miller, M. and C. Upton [1985] "A Test of the Hotelling Valuation Principle", Journal of Political Economy, 93, pp. 1-25.
- Mirrlees, J. [1969] "The Evaluation of National Income in an Imperfect Economy", Pakistan Development Review, 9, pp. 1-9.
- Nordhaus, W. [1973] "The Allocation of Energy Resources", Brookings Papers on Economic Activity, 3, pp. 529-570.



- Pearce, D.W. and R.K. Turner, [1990] Economics of Natural Resources and the Environment, Baltimore: Johns Hopkins.
- Samuelson, P.A. [1950] "Evaluation of Real National Income", Oxford Economic Papers, pp. 1-29.
- Samuelson, P.A. [1961] "The Evaluation of 'Social Income': Capital Formation and Wealth" in F.A. Lutz and D.C. Hague, eds., The Theory of Capital, New York: St. Martin's.
- Solow, R.M. [1986] "On the Intergenerational Allocation of Natural Resources" Scandinavian Journal of Economics, 88, No. 1, pp. 141-149.
- Usher, D. [1981] The Measurement of Economic Growth, Oxford: Blackwell.
- Weitzman, M.L. [1976] "On the Welfare Significance of National Product in a Dynamic Economy", Quarterly Journal of Economics, 90, pp. 156-162.
- Whalley, J. [1982] "An Evaluation of the Tokyo Round Trade Agreement Using General Equilibrium Computation Methods", Journal of Policy Modeling, 4, pp. 341-361.

# SOME THEORETICAL PROBLEMS IN ACCOUNTING FOR SUSTAINABLE CONSUMPTION<sup>1</sup>

Thomas K. Rymes

Carleton University  
OTTAWA

## I INTRODUCTION

Are we using up exhaustible resources at an unsustainable pace? Will economic growth eventually grind to a standstill because of mounting degradation of the environment? If National Accountants could provide acceptable measures of the economic depletion of exhaustible natural resources and the economic degradation of our natural world, these, added to those for economic depreciation and deducted from Gross Product, would yield measures of Net Product which might show whether or not we have been experiencing sustainable consumption. (See Ahmad, el Serafy and Lutz 1989)

There are severe problems standing in the way of obtaining measures of economic depreciation, depletion and degradation which permit theoretically meaningful estimates of sustainable consumption. Though problems of data are extremely important and themselves constitute a serious impediment to obtaining such estimates, I shall argue, in ascending order of importance, that theoretical problems associated with technical progress should make us careful of measures of economic depreciation and particularly those for the depletion of exhaustible

---

<sup>1</sup> A revision of a paper presented at the Special IARIW Conference on Environmental Accounting, Austria, 27-29 May 1991. I wrote drafts of this paper on sabbatical leave from Carleton University enjoying the hospitality of the Fellows of Wolfson College in Cambridge and the members of the Economics Discipline at The Flinders University of South Australia. I am grateful to Drs. Bent Thage, D. Damania and John Hartwick for comments and discussion, to Dr. A. Franz for editorial comments and to the SSHRCC and Dr. John ApSimon, Dean, Faculty of Graduate Studies at Carleton for a travel grant.

natural resources. Most importantly, the economic theory of property rights suggests that to deduct the value of economic degradation from our measures of Net Product may result in measures of sustainable consumption which are systematically too low!

## II ON NOTATION

Expressing everything in terms of present consumption goods (Weitzman 1976), the System of National Accounts would show Net Product or sustainable consumption as

$$WL + RPkK + RPnN^* - dzPzZ = Y(\text{or } SC) = \\ C + Pk(\Delta K - dK) - dnPnN - dzPzZ$$

where sustainable consumption, SC, equals the value of current consumption, C, plus the value of net capital formation,  $Pk(\Delta K - dK)$ , or gross capital formation,  $Pk\Delta K$ , less economic depreciation,  $dPkK$  (a rate of depreciation times the value of the stock) less the value of economic depletion,  $dnPnN$ , and less the value of economic degradation,  $dzPzZ$ . Such measures show the using up of the stocks of reproducible capital, depletable resources<sup>2</sup>, and environmental capital. Sustainable consumption also equals WL, the returns to labour, RPkK, the net returns to reproducible capital, RPnN\*, the rent on inexhaustible natural resources such as land, less the value of economic degradation. If the amount of net capital formation was just sufficient to replace depletion and degradation, so that  $Pk(\Delta K - dK) - dnPnN - dzPzZ = 0$ , then the economy would be exactly following Hartwick's Rule<sup>3</sup>. Then C would be the value of

---

<sup>2</sup> Some natural resources, N\*, such as inexhaustible and inalienable powers of the soil, may not, it might seem, experience depletion with no difference between gross and net rents for such resources. For depletable resources, the net rents will be the value of economic depletion.

<sup>3</sup> See Hartwick 1989 and 1990 and Solow 1986. One would want to adjust Hartwick's Rule for the growth of population and, I should argue, for the rate of Harrodian technical progress, such that the rule is even more demanding. We are concerned with the sustainable consumption of the current population, given its current predilection for population growth, so that more capital formation is necessary to preserve consumption in natural per caput terms and given the current advance in technology even more capital formation would appear to be necessary to preserve consumption not only in natural but in Harrodian efficient terms. The faster the population is growing, the greater, other things being equal, one would expect the depletion and the degradation of the environment to be, the less could be devoted to consumption and the more which would have to be devoted to capital accumulation in order to hold consumption per caput at sustainable levels. In terms of our notation, we would have

$$C + PkgK - dnPnN - dzPzZ$$

where g is greater than, less than or equal to n (the rate of Harrod

present and sustainable consumption. The extent to which depletable resources and environmental stocks were being drawn down would just be counterbalanced by the growth in reproducible capital stocks.

Present consumption is sustainable, then, if gross capital formation equals economic depreciation, depletion and degradation. If it is less, then the present level of consumption cannot be sustained. If it is greater, then not only can the present level of consumption be sustained, it could be rising. We don't know if our present measures of net capital formation are adequate to ensure present consumption is sustainable because we do not have, in general, acceptable measures of economic depletion and degradation. Can acceptable measures be conceived?

An old issue in National Accounting, 'maintaining capital intact', is thus rejoined only now capital is not just non-human and human but includes as well exhaustible natural resources and the natural environment. The difficulties confronting National Accountants in finding measures which purport to show how much savings, that is, how much present consumption must be foregone, to maintain 'capital intact' are, not surprisingly, compounded when the concept of capital is so widened.

### III ON ECONOMIC DEPRECIATION

Though cars rust and light bulbs 'burn out', the 'wear and tear' on capital arises not so much because of depreciation by evaporation (decay) or by sudden death but rather because capital goods are used with a certain intensity and are being superseded by better capital goods, i.e., user cost depreciation and depreciation by obsolescence. Though Keynesian user cost depreciation<sup>4</sup> is important because it relates to measures of depletion for exhaustible natural resources, I shall discuss only depreciation by obsolescence.

The most important reason why capital goods fall in value over time and are eventually replaced is that they are made obsolete by newer and better capital goods. With depreciation by obsolescence we first resolve the small point as to why there is no choice between deductions from Gross

---

population growth) plus  $n'$  (the rate of Harroddian technical progress) plus  $d$  (the rate of economic depreciation). Thus, if  $n$  and  $n'$  are zero and if  $g = d$ , net capital formation is zero and is insufficient to make up depletion and degradation. If  $n > 0$ , then if  $g > n + d$ , net capital formation is positive and may grow at a rate sufficient to maintain consumption per head with capital per head rising while the stocks of depletable and degradable capital per head are falling. A similar argument applies if  $n'$ , the rate of technical progress, is positive.

<sup>4</sup> On the general concept of user cost, see Keynes 1973 and for its application to the input-output part of the SNA, see Torr n. d.

Product for replacement as distinct from depreciation. The question pertains to a growing economy with technical progress, generating the obsolescence, being the source of growth. Why should we deduct from Gross Product an allowance for depreciation when all that is happening is that the value of capital goods is falling while their productive capacity may be remaining unimpaired? Old capital goods can be renovated to be as good as new ones, that is, to have the same characteristics of the new capital goods but again at increasing marginal renovation costs. Given such costly renovation, the prices of vintage capital goods will decline to the point where renovations costs just separate those prices from those of new models. The extent of the decline will be modified by the extent to which resources can be substituted away from them to be used with the new models coming on stream. We must, however, charge off against Gross Product the larger of the amounts of depreciation and not the smaller of the amounts of the loss and withdrawal of capacity. Sufficient consumption must be foregone to ensure that the labour force is being associated with the required amount of capital, that amount of capital to keep sustained the current level of Harrodian consumption or to keep consumption per caput growing in natural units. Indeed if the older models are being discarded from the stock when their market price is zero (or scrap value) because of the extent of the substitution of resources away from them, then the market is correctly valuing the loss of their productive capacity as zero. There is no choice between replacement and depreciation. It is the economic value of depreciation which we want to deduct from Gross Product in arriving at our measures of Net Product or sustainable consumption.

In the National Accounts, with technical progress embodied in new capital goods, the price index of gross capital formation would be falling relatively to the price index for consumption goods.<sup>5</sup> The most dramatic illustration of this phenomenon is the decline, relative to that for consumption goods, in the price index of computers (Gordon 1990). Assume no inflation in the price of consumption goods and the share of gross fixed capital formation in Gross Product is constant. Then gross fixed capital formation in constant capital goods prices must be rising relatively to gross fixed capital formation in constant consumption good prices! Gross Product in constant consumption good and constant capital goods prices would be growing more rapidly than Gross Product in constant consumption good prices.

---

<sup>5</sup> I ignore here fluctuations in which the consumption good price of capital goods could rise. Indeed, Hennings (1987) argues that economic depreciation is a measurable phenomenon only when balanced steady state growth and no technical progress are assumed.

How then should we measure capital consumption in constant price terms as a negative output<sup>6</sup> in arriving at our desired measure of 'real' sustainable consumption? What is happening is that the fraction of potential consumption which has to be given up to obtain a unit of consumption good characteristic of the new model of the capital good is falling but the fraction of consumption which has to be given up to obtain the new model is not.

The fact that the price indexes of capital goods are falling relatively to those for consumption goods because of the improvement in consumption good-producing characteristics of capital goods and that Net Product in constant consumption and capital goods prices is rising more rapidly than in constant consumption goods prices is simply the result of the method of construction of the capital goods price indexes. It is correct in that it portrays the assumption that the base period price for the current period capital good would have been higher than the base period price for the base period capital good.<sup>7</sup> In constant price terms, the fraction of resources devoted to net capital formation is rising and for the economy as a whole the measured rate of change of the combined prices of consumption and capital goods is less than that for consumption goods alone.

Since, in current price terms, the fraction of Net Product being saved is unchanged, in constant consumption goods prices, the fraction of resources devoted to net capital formation is also constant and in terms of consumption goods prices there is no deflation.

Should the decline in the value of older vintages of capital goods, arising from obsolescence, be deducted from Gross Product? So long as it is remembered that the capital consumption should be expressed in consumption good prices, the answer is yes. With substitution possibilities, capital consumption exceeds capital replacement and would measure the output which must be set aside for capital formation if both the level and expansion rate of consumption is to be sustained.

The important points are two: (a) First, the construction of capital good price indexes, when they are adjusted for the changing consumption

---

<sup>6</sup> For measures of capital inputs, including capital consumption allowances or depreciation, measured in constant **input** prices, a fundamentally different problem from the one discussed in the text, see Cas and Rymes 1991.

<sup>7</sup> Index number problems and general inflation aside, the assumption also states that the current period price for the base period capital good would be lower than the current period price of the current period capital good. The prices of 'quality adjusted' capital goods are falling relatively to the prices of consumption goods.

good-producing characteristics (direct and indirect) of the new capital goods, entails that producers's goods price indexes must be tending to fall relative to consumers' goods price indexes. In our context that means that, in constant consumers' and producers' good prices, Net Product will be rising relatively to Net Product or sustainable consumption expressed in constant consumption goods prices. Second, the newest capital goods, embodying the latest techniques, require resources in their production (the consumption which must be given up) to add them to the stock of potential consumption. That consumption must be given up to acquire the newest capital goods makes it meaningful to deduct capital consumption or depreciation in constant consumption goods prices to arrive at measures of Net Product or sustainable consumption. For meaningful estimates of sustainable consumption, depreciation on reproducible capital must be measured in terms of constant consumption good prices.

Technological change renders obsolete human capital and stocks of knowledge as well. Aside from very severe empirical problems, all the conceptual difficulties associated with the need to express depreciation in terms of consumption foregone pertain to such extensions beyond the non-human capital concepts.<sup>8</sup> Thus, even at the trivial conceptual level so far advanced it would appear that estimates of economic depreciation, with narrow or wide definitions of reproducible non-human and human capital, face considerable difficulties, which stand in the way of measures of Net Product or sustainable consumption. More serious problems await us.

#### IV ECONOMIC DEPLETION

Stocks of reproducible natural agents are being depleted all the time. Yet, the consumption of fish stocks, for example, is a problem for sustainable consumption only when the stock of fish is so over-exploited by consumption that the level of such consumption of fish cannot be maintained. If the natural equilibrium is such that fish stocks are not depleted then, clearly, no deduction from Net Product is required to show sustainable consumption. If consumption exceeds natural growth, then fish stocks are being depleted and that component of consumption cannot be sustained. [Of course, consumption in general, can be sustained if net capital formation at the Hartwick rule in alternative consumption goods is sufficient to offset the depletion.] It is generally recognized that such depletion due to overconsumption arises from imperfect property rights. Depletion of reproducible natural agents such as fish, timber stocks and so forth is part of economic degradation and is dealt with in section V.

---

<sup>8</sup> For a discussion of such problems, see US Bureau of Labour 1989 and Adams 1990.

By depletion, I mean the using up of nonreproducible, exhaustible natural agents such as ore bodies, oil pools, natural gas reserves and the like. One would at first assume that there is no depletion of land. (Harberger, 1987) Assuming positive recovery costs, such nonreproducible natural resources will only have value if the state of technology or the size of the population renders them so.

Consider first the highly unrealistic case of population growth and unchanging technology. The rise in value or revaluation of such nonreproducible natural resources, accompanying growth and accumulation, will move with their consumption or depletion. As the present values of the additional streams of consumption they represent become positive or higher as rates of return to capital fall (as growth rates fall), the net rents earned by the natural resources will be at the expense of others as the growing economic system drives the efficient price of such resources higher. The rights to such resources, privately owned, as population expanded, would take on positive values, such values being the present value of the consumption streams. The using up of these natural resources means their rights owners earn rents. The overall increase in consumption will be just equal to the depletion and sustainable consumption would remain unchanged.<sup>9</sup>

Since the value of the exhaustible stocks must equal the present value of the additional consumption they represent, then if Product is taken net of depletion after such stocks are valued and entered into National Wealth then the sustainable consumption before, during and after the 'discovery' and full depletion of such natural resources must be the same.

Provided National Accountants have information on the value of such stocks of natural resources in a world where technical progress does not include the "discovery" of hitherto valueless resources, then current and constant price depletion, when valued in terms of present consumption goods, represent a correct deduction to be made in arriving at estimates of Net Product or sustainable consumption.

The examination of the measurement of depletion of exhaustible natural agents in a world of capital accumulation where technical progress does not occur is extremely artificial. Yet our willingness to deduct depletion from Gross Product to arrive at measures of sustainable consumption seems largely based on considering conceptions of the using up of exhaustible resources in a world haunted by the Malthusian spectre.

---

<sup>9</sup> The classical argument would be that such growth induced scarcity would eventually so reduce the earnings of labour and capital (or, more generally, reproducible capital) that the growth in population would come to a standstill. See Hicks 1985.



When it is technical progress which gives rise to the scarcity of depletable natural agents, it is not obvious that an allowance for the depletion of such natural agents should be made as a charge against Net Product or the measurement of sustainable consumption.

Advances in technology are associated with increases in the value of exhaustible resources which may have been hitherto of no value whatsoever. What is extremely important to note, however, is that the increase in the wealth of the community with respect to such 'new' exhaustible resources, that is, the rise in the value of the stream of consumption, because of the technical progress, does not require any savings, that is, any consumption to be foregone.<sup>10</sup>

The initial positive revaluation of the hitherto perhaps zero-valued natural agents should, of course, be recorded in the National Accounts as a positive entry in the Revaluation Accounts. It should not be included as part of the Gross and Net Product in the period of time in which the advance in technical knowledge occurs. If the additions to Wealth arising from the revaluations in nonreproducible natural agents, associated with the technical advance, are not added to the Product, then even though consumption and Net Product will be higher there is no reason to deduct from that Product the depletion experienced. If the technical progress comes to a standstill then, of course, the Product will fall back over time just as it did in our discussion of the classical case.

There is no reason, however, to show that fall back in Product being even greater by deducting depletion from Product. If it is deducted, then, over time, the logic of the deduction is to extract from the economy the gain in consumption, even if finite in amount in time, which accompanies the technical advance. Sustainable consumption would be measured by the National Accountant as if resource-generating technical advance had never occurred. This would be meaningless. The depletion of the stock of exhaustible agents, i.e., their decline in value, is not to be charged against Net Product but are, however, properly recorded as capital losses in the Revaluation Accounts and in the National Balance Sheets.

If one assumes that advances in knowledge are ongoing, then if such increases in the value of depletion of exhaustible agents were always deducted from Product, sustainable consumption will never reflect the rising consumption enjoyed by the members of the economy because of the

---

<sup>10</sup> Again, it may be such technical advance is costly and the associated costs, such as research and development expenditures, could be capitalized. There will as well be capital recovery costs. Then, problems of measuring the depreciation of the stock of human capital and such components of knowledge as research and development and reproducible capital reappear.

advances in knowledge. One can never guarantee the future. That is not the point! If the present period's measures of sustainable consumption reflect advances in knowledge in that period which raise the value of exhaustible natural resources then to deduct the depletion of the resources in that period when consumption of them is due to advances in knowledge results in an understatement of sustainable consumption and an overstatement of the costs of advances in knowledge and economic growth. The appreciation in the value of natural resources requires no foregone consumption, the unrecorded depletion of them does not result in an overstatement of sustainable consumption requiring the depletion to be deducted from Product. Since no consumption is foregone to 'acquire' the exhaustible natural resources, no consumption has to be foregone to cover the cost of their depletion.

A simple model, of the Weitzman-Hartwick type, may be employed to expose the essentials of the argument. Imagine there exists an individual with an infinite horizon who is endowed with a given manna-bush, from which it is costless to pick (zero extraction costs) and consume manna. At what rate should the individual consume the manna?

$$\text{From } W = \int_0^{\infty} U(C_t) e^{-\rho t} \text{ subject to } K_0 \text{ and } \dot{C}_t = -K_t$$

where  $U(C_t)$  is the instantaneous utility flowing from consumption of manna at any time  $t$ ,  $K_0$  is the endowed manna and  $\dot{C}_t = -K_t$  is the constraint facing the individual, showing that any consumption involves depleting the stock of manna. The individual will follow the Keynes-Ramsey rule (See Blanchard and Fischer 1989, 41-43) such that  $U_c(C_t)/U_c(C_t) = \rho$ , i.e., the marginal utility of consumption of manna, or the 1931 Hotelling rental rate on manna, will be rising at the rate of time preference. Since

$$\dot{C}_t/C_t = \rho \eta_c^{u_c}, \text{ where } \eta_c^{u_c} \text{ is the elasticity of the intertemporal}$$

substitution across consumption streams, and  $\eta_c^{u_c}$  is negative (if, for example, it is  $-1$ ), then consumption will be falling through time (at the rate  $\rho$ ).

In terms of the Weitzman-Hartwick National Accounts, we have

$$C_t + \dot{K}_t = 0$$

or, consumption equals the depletion of the stock of manna (equal to the Hotelling rentals on the stock of manna). In short, the existing National Accounts (SNA) would be, for this simple economy,

	GNP		GNE
(Depletion or	$\dot{K}$		C
(Consumption)		or	
Hotelling Rentals)	NNP		NNE
	0		0

where C would be falling at the rate  $\rho$ , whereas for the Weitzman-Hartwick Accounts net product, or sustainable consumption, would be zero! The total amount of consumption over time equals  $K_0$  and the history of the simple economy would show, by the SNA, consumption falling throughout its history, approaching zero while for the Weitzman-Hartwick NA, sustainable consumption would always be zero. (See Dasgupta and Heal 1979)

Imagine now at some time in the history of the individual a discovery of another manna-bush, or technical progress transforms a poisonous or useless tree into another manna-bush. The new manna-bush, together with what is left of the old, becomes the new initial stock of manna and we can repeat our simple story, though while the level of consumption of the individual will be higher, it will still always be declining at the rate  $\rho$ . The SNA will record the higher declining path consumption while sustainable consumption will remain always equal to zero. We can repeat the analysis for any additional discoveries and/or any further technical progress. The SNA net product and sustainable consumption for the simple economy could be illustrated in Figure 1.

Figure 1



In Figure 1, sustainable consumption never rises above zero, even though SNA consumption and net product would be rising through time. The Weitzman-Hartwick net product could be changed if the rents arising from the discoveries and/or increased value of bushes owing to technical progress were added to the SNA accounts. One would not add the discoveries for even with the depletion or Hotelling rentals deduced from the revised SNA, the net product would behave erratically. If the additional rentals were called appletion and were added to the SNA and if the rentals, treated as depletion, were deducted from the SNA, then the Weitzman-Hartwick accounts would be exactly equal to the current SNA - that is, what would be taken away as depletion would be added as appletion. If the appletion is not added and if depletion is deducted from the SNA, once again sustainable consumption would always be zero. With respect to economic depletion, there appears to be only two choices: i) adhere to the SNA where the rental value of discoveries, i.e. appletion is not added to net product, and depletion is not deducted from the net product (since the Weitzman-Hartwick procedure, given the optimal treatment of discoveries, amounts to exactly the same thing); or ii) deducting depletion from the SNA to get sustainable consumption, in the simple case outlined, always equal to zero. The latter treatment, in a world of discoveries and resource-augmenting technical progress (cf., Stiglitz 1979), seems of questionable meaning since it implies that knowledge is limited and bounded.

#### V ON ECONOMIC DEGRADATION

There would appear to be no doubt that air and water could be 'cleaner and clearer', that, in some sense, these stocks, these parts of 'social' capital have been, and are being, degraded. (Yet there are cases of air and water rejuvenation such as the improvement in the air quality in London's rail stations and the water of the Thames River.) Similarly, stocks of wildlife such as whales, whooping cranes and many other kinds of animal, plant and insect life are approaching extinction levels. Should all this degradation of our 'natural environment' be a debit against sustainable consumption? (Should rejuvenation be a credit?)

The question of whether National Accountants should deduct economic degradation from Gross Product is connected with the economics of property rights.<sup>11</sup>

---

<sup>11</sup> For a recent treatment, see Barzel 1989. For an extension to the theory of institutions and organizations, see North 1990. Indeed, some students of transactions costs would argue that currently measured Net Product, if it is conceived of as a measure of sustainable consumption on the basis of the ability of the economy to transform resources into a flow

Consider a simple case, designed to show how even our earlier assumption that the inalienable and inexhaustible powers of the soil should experience no economic depletion is false. Homogeneous labour producing wheat is allocated across two different types of land. Wheat output is maximized when the labour allocated is such that the marginal products of labour are equalized. Under competitive conditions, this is brought about (in the usual text book story) if competitive rents are charged to use the two types of land to produce wheat.<sup>12</sup>

If the rights to one of the types of land are costly to define and measure so that no rents for the use of the land are charged, then labour will so relocate that the average product of labour on that type of land (the land, that is to say, in the public domain) will be equal to the marginal product of labour on the other type (in the private domain). Total product will fall and it may even be the case that there will be so much labour on the land with the ill-defined rights, so much congestion, that the marginal product of labour on that land will be negative.

Congestion is akin to pollution. If the migration of labour onto the crowded land was so great that the inexhaustible powers of its soil were, in fact, weakened by the congestion, we should say that that land was being 'degraded', that such 'degradation' ought to be measured and deducted to get 'true' Net Product. In our simple case, the relocation of labour on the land with ill-defined rights is associated with a level of output, a level of sustainable consumption, which would be already below that which would result if competitive rents were charged for the use of the lands. The congestion which results, if it weakens the supposed inexhaustible powers of the soil, is illustrated by adverse shifts of the average and marginal product of labour functions. A further reduction in output would therefore be actually recorded.

---

of consumption, is substantially overstated and the relative overstatement is growing. See Wallis and North 1986 and the comments by Lance E. Davis.

<sup>12</sup> As Gordon's classic 1954 analysis would suggest, property rights to harvest fish in the international seas are not well-defined. Almost no rents are charged for the use of such rights. The amounts of labour and capital in the fishing industry are too big, congestion results and stocks of fish are being depleted. If such depletion could be measured then, again, it would seem appropriate to deduct it from International Gross Product since some net capital formation in other lines would have to be undertaken to replace the diminishing stocks of fish in order to sustain overall consumption.

Figure 2

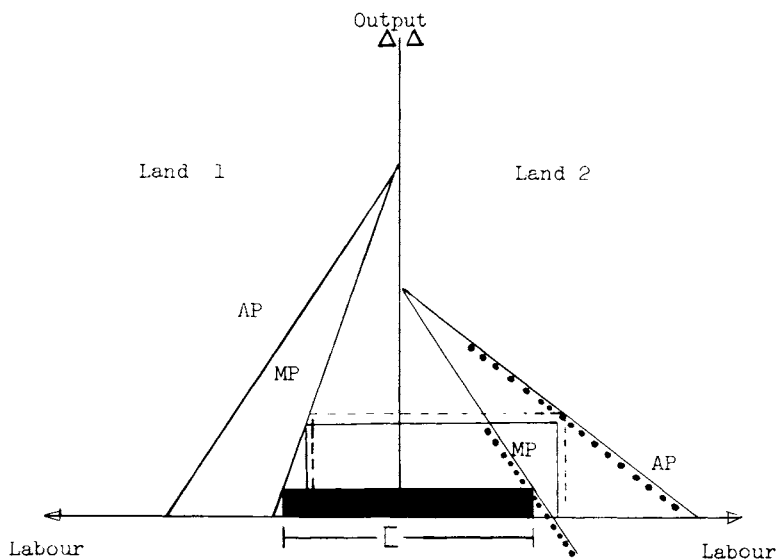

Illustrated in Figure 2<sup>13</sup>, the shift in the production functions on the land with the ill-defined rights might so result in a limited reverse reallocation of labour such that the marginal product of labour on the land with the ill-defined rights ceases to be negative. Thus, the effect of the congestion on the continuing 'degradation' of the land with ill-defined property rights might be eliminated. [If the damage to the land were irreparable in the sense that even if competitive rents for the rights to use the land were returned to force and labour efficiently allocated, output would not return to its former level without some consumption being foregone to reconstruct, by fertilizers and so forth, the 'inexhaustible powers of the soil'.]

It would appear that the depletion of the soil is a legitimate

<sup>13</sup> In Figure 2, a given amount of labour is initially allocated across two types of land such that the marginal products of labour are equalized. The returns to labour are shown by the dark rectangle. With the removal of rents on land 2, labour relocates so that the marginal product of labour on land 1 equals the average product of labour on land 2. The returns to labour are shown by the dashed rectangle. In that allocation the marginal product of labour on land 2 is negative which 'causes' downward shifts in the average and marginal products of labour, illustrated by the dotted schedules. Labour relocates again so that the marginal product of labour on land 1 equals the reduced average product on land 2 and the returns to labour are shown by the regular rectangle.

charge against Gross Product. The 'depletion' or 'degradation' charges, however, as this simple example makes clear result from the failure of property rights to be well defined, measurable and in existence.<sup>14</sup>

The total reduction in output from the case where property rights are costlessly defined to that where the land without the property rights turns into a common property resource can be decomposed into two parts: (i) that part which is the effect of the costly property rights in one of the lands, and (ii) that part owing to the once-over degradation of the land. The National Accounts, however, would actually show, in this simple case, sustainable consumption lower by the two amounts. Net Product, without the National Accountant making any allowance for the deterioration in the quality of the land, would show a reduction equal to the sum of the two effects.<sup>15</sup> It would be incorrect for the National Accountant to make a further deduction for the 'degradation' of the land. The decline in Net Product would have already registered such degradation and to deduct it again, as a measure of the depletion of the inexhaustible powers of the soil, would be to understate sustainable consumption.

The central problem is though that there are no such things as costless property rights and that the qualities of the soils are not independent of the determination of costly property rights. Even with well-defined property rights, degradation will take place. Is it a legitimate charge against Gross Product?

A manufacturer who has the right to pump chemicals into a river passing his plant prevents downstream users from swimming in clean water. The downstream swimmers might be able to offer the manufacturer a sum of money for a measurable and therefore monitorable reduction of the chemicals put into the river. If the opportunity cost to them of the money (and time) so involved is less than the value of the perceived increase in swimming then such payments will be offered. If the money paid to the manufacturer exceeds the value of the product to be foregone by a reduction in output, the offer will be accepted. Given the time and the

---

<sup>14</sup> The Coase theorem (conjecture?) states that, if property rights can be costlessly defined, measured and maintained, the efficient outcome would be maintained regardless of who owned the rights. [It is understood that the assumption of costless property rights is the same as assuming zero transactions costs, costless price systems, or costless political allocation mechanisms.] See McManus 1975.

<sup>15</sup> In Repetto 1989, it is stated, inter alia, that 'A country could exhaust its mineral resources, cut down its forests, erode its soils, pollute its aquifers, and hunt its wildlife and fisheries to extinction, but measured income would not be affected as these assets disappeared'. As the simple example illustrated by Figure 2 makes clear, this statement is false.

costs of monitoring the chemical content of the product and of the river, the amounts of money offered by the swimmers for additional swimming possibilities will diminish. The amounts which will be required by the manufacturer for producing such additional swimming possibilities by reducing the flow of its product will increase until the one is deemed to equal the other and no further payments will be made.<sup>16</sup>

The time and monitoring costs and payments made will be just sufficient to determine the output of the manufacturing plant, the amount of chemicals put into the water and the quality of the swimming possibilities the swimmers downstream enjoy. Some chemicals will still be being dumped into the river and 'pollution' of the water continues. [In the property rights approach, the optimum in the sense of the Paretian efficient rate of pollution occurs.]

In the National Accounts, the usual place to record such transfers [i.e., from the swimmers' association to the manufacturer as their 'subsidy' to encourage the manufacturer to lower the level of the manufacturer's polluting output or, if the swimmers have some rights to clean waters, payments from the manufacturers to the swimmers in the form of license-to-pollute fees] is in the Income and Expenditure sector accounts. The level of consumption, fees paid by the swimmers' association, transfers from the firms to the swimmers, would all be a function of the costs of measuring and enforcing the property rights of the manufacturers and the swimmers. The recorded level of Net Product will in this case provide a measure of sustainable consumption.

Suppose it is possible, by means of examining the transfer payments, to say that a unit of 'pure' water was worth  $P_n$  units of consumption. Suppose it were possible to conceive of the river as a stock,  $N$ , of pure water and the Paretian efficient equilibrium rate of pollution as  $dn$  (the proportional difference in the hypothetical or imputed<sup>17</sup> price per unit flow of pure water and the price paid for a unit flow of polluted water.) One could then impute a value to the pollution occurring,  $dnP_nN$ , and deduct that from Net Product to get a 'true' Net Product or 'true' level of sustainable consumption.

---

<sup>16</sup> The complexities of the real world are endless. What are good swimming possibilities will be ill-defined, there will be costs of coordinating payments among swimmers and the elimination of 'free riders', the manufacturer may find it difficult to monitor the connection between production and chemicals in the river, there may be many manufacturers dumping the chemicals into the river and governments and courts may or may not enforce contracts. All such complexities would have to be taken into account.

<sup>17</sup> One needn't stress the great problems of obtaining such "efficient" prices. For such difficulties in the case of banking, see Rymes 1989.



**THIS WOULD BE AN ERROR.**

The resultant Net Product estimate would underestimate sustainable consumption. The members of the economy have ascertained that amount of pollution which, given the benefits [higher or lower manufacturing output] and costs [lower or higher swimming activity], taking into account the costs of determining property rights costs, determines the level of sustainable consumption. The National Accountant can provide (imperfect) measures of that level. It would be quite wrong, however, if the National Accountant, observing that some pollution defined as chemicals in the water was occurring, imputed a measure of that pollution (even marginally) and deducted that imputed measure of economic degradation from measured Net Product. The resultant measure of sustainable would be too low!

There is an analogy between the National Accountant arriving at a measure of sustainable consumption that is too low and Coasean criticism of the imposition of a Pigovian 'pollution' tax. Suppose, in our example, a wider community, ignorant of the transfer payments ongoing between manufacturer and the swimmers, imposed a tax on the manufacturers to encourage a further reduction in the 'polluting' output. To the manufacturer, the marginal costs have risen and the level of output would be reduced. To the swimmers, the quality of the water has improved and the swimmers activity would be increased. The level of manufacturing output and swimming would be 'distorted' from the previous levels by the additional taxes levied on the use of water by the manufacturers. Such a tax yields the result that sustainable consumption would be reduced not increased by the imposition of the tax. This is exactly the same result as if the National Accountant deducted his imputed estimate of the value of pollution as part of the value of economic degradation from the measures of Net Product which would hold when the manufacturer and the swimmers had already made the appropriate or consumption maximizing transfer arrangements amount themselves.

The swimmers and manufacturer may not have been able, given negotiation costs, to arrive at an acceptable set of transfers and may well ask the wider community, whose costs of enforcing property rights may be lower, to set the license fees and/or the transfer payments involved in what is essentially the ascertainment of costly, imperfectly measurable and enforceable property rights. It is the set of license fees, taxes and subsidies and transfers which the State is using to obtain the most efficient level of sustainable consumption.<sup>18</sup> The State may thus

---

<sup>18</sup> Again, these fees, taxes, subsidies and transfer would appear in their appropriate places in the System of National Accounts but should not appear as part of measures of economic degradation.

efficiently be involved in the determination of property rights.<sup>19</sup> As such, that State may ask the National Accountant to try to impute a measure of the costs of pollution, radiation damage, extinction of species and so forth, on the grounds that the National Accountant may provide the best independent measures of such costs. The State may use that information in setting the set of fees and transfer it uses. Such measures, however, may not, in the form of measures of economic degradation, be deducted from existing measures of Net Product for then sustainable consumption would be understated.

In terms of our accounts for sustainable consumption and returning to the simple illustration of the overcrowding on land, in the case of perfectly defined property rights, measured sustainable consumption would entail a level of consumption, C. The imperfect property rights would involve a lower level of consumption, C\* and the degradation of the land would result in an even lower level of consumption, C\*\*. To deduct the value of the degradation of the soil which, in present value terms, would be C\*-C\*\* would be to deduct the degradation twice. In the case where property rights cannot be costlessly defined, if one should impose an additional constraint upon the manufacturer, then while it is true that the marginal valuation of the extra swimming would be positive the marginal value of the loss of the manufacturer's output would be greater. If sustainable consumption had the two components, PsS and PmM, the value of the swimming and the 'polluting' output, then, the result of the additional constraint would be that sustainable consumption had the two components, PsS\* and PmM\*. While P(S\*-S) would be positive, P(M\*-M) would be negative by a larger amount since the original set of prices took into account the tastes, technical conditions and the costs of ascertaining property rights. Sustainable consumption would be lower than the level at which the swimmers and the manufacturer determined in maximizing the joint value of their two activities. A deduction of the value of economic degradation of the water from measured Net Product would have the same result as the additional constraint on the manufacturer. Measured sustainable consumption would be too low.

---

<sup>19</sup> For an (incorrect) argument to the effect that the Coase conjecture implies that there is no role for the State in resolving 'externalities' or 'the problem of property rights', see Stiglitz 1989, especially p. 36 The Coase Fallacy. Contrast Stiglitz's view with that of Barzel where he states (Barzel, 1989, 107), in the allocation of property rights by the public and private sectors "Each must be efficient." The transactions cost and property rights literature has problems with the concept of economic efficiency. North (1990) allows institutions to be inefficient in the Paretian sense which, since he builds on Barzel, seems inconsistent. Indeed, some have argued that the transactions costs literature suffers from the tautology that whatever is, is efficient. See Buchanan 1987.

It is sometimes argued that rather than making the mistake of deducting measures of economic degradation from SNA net product measures we should add them to get measures of Product which would show how much higher our Net Product would have been had the degradation not occurred. (See Harrison 1989). Such a suggestion amounts to saying we can construct Net Product measures which would be 'true' for a world in which property rights were costlessly and, therefore, perfectly defined. No such world exists. The resulting higher than SNA product estimates would be those which would be impossible to achieve and therefore a nonsense. Moreover, as the swimming example illustrates, it would really amount to the same thing as imposing the additional restraint on the manufacturer. In the addition to the SNA Net Product, the value of swimming would be higher but if the calculation were correctly done one would have to deduct the loss in the value of the manufacturer's output. The addition to SNA Net Product, purporting to show how much higher sustainable consumption would be if property rights were costless, would be, in any meaningful economic sense, illusory.

#### VI CONCLUSION

'Maintaining capital intact' has had a long discussion in economics and National Accounting. It would appear that, however tenuous the empirical measures may be, when expressed in terms of consumption goods, current and constant price estimates of reproducible capital consumption allowances are conceptually defensible deductions from Gross Product in arriving at measures of sustainable consumption.

Should we, given market and imputed measures of the depletion of exhaustible natural resources and the economic degradation of the natural environment, use them to produce even lower measures of Net Product?

With technical progress giving rise to valued exhaustible natural resources, if the depletion of such resources is written off against Net Product then sustainable consumption would never reflect that technical advance. Perhaps it should not because there is a sense in which consumption levels, which take advantage of the technical advance, cannot be sustained - unless the advance also permits at the same time higher levels of net reproducible capital formation to offset the depletion. If such technical advance is ongoing, however, then to include all the using up of the natural resources whose values were created by the advance, would result in levels of sustainable consumption more and more below those growing levels which the economies are experiencing. The National Accountant's measures of sustainable consumption would not only be too low but the difference between the consumption levels actually experienced and the National Accountant's measures of sustainable consumption would be

continually widening.

With respect to the economic degradation of the environment, the theory of the costs of measurement and transactions and property rights would suggest that, since people by both market and non-market means, have subjected themselves to the costs of the "externalities", such costs are already therefore showing up in measured levels of consumption. If the National Accountant should impose the cost again so to speak by deducting from Net Product measures of economic degradation, then the Accountant would be negatively double-counting. If the National Accountant should then add measures of economic degradation to Net Product to show what Gross Product would have been had the degradation not taken place, then the Accountant would be constructing Product estimates for a world in which property rights were costless.

## REFERENCES

James D. Adams, "Fundamental stocks of knowledge and productivity growth", *Journal of Political Economy*, XCVIII, August 1990, 673-702.

eds. Y. J. Ahmad, S. El Serafy and E. Lutz, **ENVIRONMENTAL ACCOUNTING FOR SUSTAINABLE DEVELOPMENT** (Washington, D. C.: IBRD/World Bank, 1989)

Yoram Barzel, **ECONOMIC ANALYSIS OF PROPERTY RIGHTS** (Cambridge: Cambridge University Press, 1989).

Olivier Jean Blanchard and Stanley Fischer, **LECTURES ON MACROECONOMICS** (Cambridge: The MIT Press, 1989)

James M. Buchanan, "Rights, efficiency, and exchange: the irrelevance of transaction cost", eds. R. D. Tollison and V. J. Vanberg, **ECONOMICS: BETWEEN PREDICTIVE SCIENCE AND MORAL PHILOSOPHY** (College Station, Texas: Texas A. and M. University Press, 1987)

Alexandra Cas and Thomas K. Rymes, **ON CONCEPTS AND MEASURES OF MULTIFACTOR PRODUCTIVITY, CANADA, 1961-80** (New York: Cambridge University Press, 1991)

P. S. Dasgupta and G. M. Heal, **ECONOMIC THEORY AND EXHAUSTIBLE RESOURCES** (Cambridge: Cambridge University Press, 1979)

H. Scott Gordon, "The economics of a common property resource: the fishery", *Journal of Political Economy*, LXII, 1954, 124-142

R. J. Gordon, **THE MEASUREMENT OF DURABLE GOODS PRICES** (Chicago: University of Chicago Press for the NBER, 1990)

Arnold Harberger, "Depletion", **THE NEW PALGRAVE DICTIONARY OF ECONOMICS**, I (London: Macmillan, 1987), 805-7.

Anne Harrison, "Environmental issues and the SNA", *Review of Income and Wealth*, XXXV, December 1989, 377-88.

John M. Hartwick, "Natural resources, national accounting and economic depreciation" and "Pollution and national accounting", Queen's University Institute for Economic Research Discussion Papers 771 and 772, January 1990

John M. Hartwick, **NON-RENEWABLE RESOURCES EXTRACTION PROGRAMS AND MARKETS** (Chur, Switzerland: Harwood Academic Publishers, 1989), especially Chapter 6 Economic Growth and Exhaustible Resources.

K. H. Hennings, "Maintaining capital intact", **THE NEW PALGRAVE DICTIONARY OF ECONOMICS**, III (London: Macmillan, 1987), 277-79.

John Hicks, "Primitive growth models - Adam Smith and Ricardo", **METHODS OF DYNAMIC ECONOMICS** (New York: Oxford University Press, 1985).

H. Hotelling, "The economics of exhaustible resources", *Journal of Political Economy*, XXXIX, 1931, 137-75, reprinted in ed. A. C. Darnell, **THE COLLECTED ECONOMIC ARTICLES OF HAROLD HOTELLING** (London: Springer-Verlag, 1990)

J. M. Keynes, **THE GENERAL THEORY OF EMPLOYMENT, INTEREST AND MONEY**, VII, **THE COLLECTED WRITINGS OF JOHN MAYNARD KEYNES**, Appendix on User Cost (Cambridge: Macmillan for the Royal Economic Society, 1973)

John McManus, "The costs of alternative economic organizations", **Canadian Journal of Economics**, VIII, August 1975, 334-350.

Douglass C. North, **INSTITUTIONS, INSTITUTIONAL CHANGE AND ECONOMIC GROWTH** (Cambridge: Cambridge University Press, 1990).

R. Repetto *et. al.*, **WASTING ASSETS: Natural Resources in the National Income Accounts** (Washington: World Resources Institution, 1989)

Thomas K. Rymes, "The theory and the measurement of the nominal output of banks, sectoral rates of saving and wealth in the National Accounts", eds. Robert E. Lipsey and Helen Stone Tice, **THE MEASUREMENT OF SAVING, INVESTMENT AND WEALTH** (Chicago: University of Chicago Press for the NBER, 1989).

R. M. Solow, "On the intergenerational allocation of natural resources", **Scandinavian Journal of Economics**, LXXXVIII, 1, 1986, 141- 149.

J. E. Stiglitz, "A neoclassical analysis of the economics of natural resources", ed. V. Kerry Smith, **SCARCITY AND GROWTH RECONSIDERED** (Washington: Johns Hopkins University Press for the Resources for the Future, Inc., 1979).

J. Stiglitz, **THE ECONOMIC ROLE OF THE STATE** (Oxford: Blackwells, 1989)

Christopher Torr, "The inclusive and exclusive roles of user cost in the derivation of Keynes's aggregate supply function", mimeo n. d.

US Bureau of Labour, **THE IMPACT OF RESEARCH AND DEVELOPMENT ON PRODUCTIVITY GROWTH** (Washington, D. C.: Superintendent of Documents, September 1989)

J. J. Wallis and D. C. North, "Measuring the transaction sector in the American Economy, 1870-1970", eds. S. L. Engerman and R. E. Gallman, **LONG-TERM FACTORS IN AMERICAN ECONOMIC GROWTH** (Chicago: University of Chicago Press for the NBER Studies in Income and Wealth, LI, 1986)

M. L. Weitzman, "On the welfare significance of national product in a dynamic economy, Quarterly Journal of Economics, XC, 1976, 156-162.

VALUATION AND TREATMENT OF DEPLETABLE RESOURCES  
IN THE NATIONAL ACCOUNTS

Jonathan LEVIN 1/  
Fiscal Affairs Department  
International Monetary Fund

INTRODUCTION

From the earliest times, as the bronze and iron ages testify, the extraction of natural resources for human use has been an important part of man's relation to nature. At the very beginnings of American history, English explorers searched the New England coast for what Richard Haklyut, in his classic Discourse Concerning Western Planting of 1584, had called "merchantable commodities," goods that were scarce in Europe and would pay the cost of transporting them across the ocean. 2/ In our own day, as a growing awareness of the human interaction with nature draws greater attention to its economic measurement, appropriate characterization of this relationship poses a significant challenge. As Carl Sauer wrote of soil and species destruction in 1938, "We have not yet learned the difference between yield and loot. We do not like to be economic realists." 3/

This issue has come more clearly into focus as part of the current effort to adjust the national accounts' measurement of overall economic activities so as to better reflect interaction with the environment. Attention has focused

---

1/ The views expressed are those of the author and do not necessarily represent those of the Fund. The author thanks Carol Carson, Arnold Katz, and Timothy Muzondo for helpful discussions.

2/ Cronon (1983) 20.

3/ Sauer (1963) 154.

on national accounts treatment of three issues: depletion of natural resources extracted for sale, "defensive" expenditures to prevent or correct environmental damage, and degradation of the quality of the environment as a result of economic activity. On the first issue, it is argued that the extraction of depletable natural resources should be viewed as the use of an existing asset rather than as an addition to income, constituting instead either the use of an inventory carried over from previous periods, which should not be counted as a part of production -- Gross Domestic Product -- in the current period, or the depreciation of a capital asset which, though contributing to production, should not be counted in Net Domestic Product or income.<sup>4/</sup> To help assess the feasibility of such a change, and the alternative means by which it might be implemented, this paper deals with specific aspects of this issue, that is, the valuation and treatment of nonrenewable natural resources extracted for sale.

Whether or not the nonrenewable resources extracted from nature should be counted as part of economic production and income can have wide implications for the evaluation and conduct of development in many countries, and particularly those countries which are dependent upon the extraction and sale of such products. In considering solutions to the conceptual problems involved, one important question is how such economic interactions could be measured, what values can be put on the flows between nature and economic activity, and how they may be entered in the accounts.

This issue presents difficulties because, while the eventual sale of the extracted product provides a market price, this may not be true of its natural resource component, as distinct from the value added by its subsequent costs. Having crossed the line between geological accretion and economic exploitation without the benefit of market price, the natural resource component poses a number of questions which are examined here in turn: 1) what is to be valued, only withdrawals or also additions to economic reserves? 2) at what stage in the nature-to-market process could valuation of such additions to reserves take place? and 3) how could valuation be carried out?

---

<sup>4/</sup> Levin (1990) 161, 168-169.



This paper examines varying perspectives on these three issues, drawing upon earlier works concerned with measuring the value of natural resources, and advancing its own suggestion as to how this value may be entered in the national accounts. It does not deal with possible future costs, such as those for mine land restoration, which, like imputed employer contributions to unfunded pension schemes, could conceivably be counted as current period costs.<sup>5/</sup> Nor does it deal with the externalities of social costs or the contingent costs of possible future occurrences, such as oil spill damage, for example.<sup>6/</sup>

#### TREATMENT OF ADDITIONS TO RESERVES

The impetus for revised national accounts treatment of depletable resources extracted for sale comes from a belief that, since their existence precedes the accounting period in which their extraction takes place, their depletion constitutes a reduction in wealth rather than an addition to income. It is argued that extraction should therefore be reflected in either a subtraction from income to show depreciation, like that of a fixed capital asset, or a subtraction also from production to show use of preexisting inventories, since the natural resource component was not produced in the current period.<sup>7/</sup> Either view requires valuation and subtraction of the natural resource component of the product extracted for sale.

The need for this subtraction follows from application of the Hicksian concept of income, that is "maximum potential consumption while maintaining capital intact." This is contrasted by Michael McElroy with the Irving Fisher (1930) definition of income as the sum of pure consumption expenditures and the implicit rental value of consumer durables, counting only the economic "ends" rather than "changing prospects for future consumption resulting from current expenditures on economic means," that is, capital. The difference between Fisher and Hicksian definitions, McElroy

---

<sup>5/</sup> Berger (1986) 91-93.

<sup>6/</sup> Hubbard (1991) 36-42.

<sup>7/</sup> Levin (1990) 168; Bartelmus (1989) 18; Ahmad (1989) 3-4; and Bartelmus (1991) 4.

explains, lies only in periodization, that is, the allocation of these events in specific intervals of time. The Fisher definition counts neither capital formation nor its subsequent depreciation. The Hicksian definition, on the other hand, counts both current consumption and the present value of expected net increments in future production (or consumption) possibilities, but avoids double counting by subtracting depreciation allowances as the value of the capital stock "embodied" in current production.<sup>8/</sup>

Implied in strict adherence to the Hicksian definition of income as potential consumption plus changes in net worth is symmetry between additions to wealth and their subsequent subtractions from wealth, or, more to the point, between subtractions from wealth, as in depletion or depreciation, and their previous addition to wealth. Besides valuation of the natural resource component extracted for sale, therefore, valuation of the natural resource as it becomes a part of wealth would also be necessary.

Questions arise, however, as to whether such symmetry in the registration of natural resources as they enter the national wealth is possible, necessary, and advisable. Unlike private mineral holdings, which can be entered as increases in wealth at the time of acquisition, a nation's subsoil mineral wealth predates existence of the nation. One could conceivably view such mineral wealth as having entered the balance sheet in a previous period, or at the opening of accounts, with no addition to the production or income accounts symmetrical to subsequent subtractions.<sup>9/</sup> Alternatively, to maintain symmetry, one could take the occasion of their discrete entry into economic affairs to mark the addition of such natural resources to the nation's wealth. As noted in the next section, this could

---

<sup>8/</sup> McElroy (1976) 228-229. James Bonbright describes a third concept of income, referred to as the accounting concept, which is a compromise between the other two. It pro-rates receipts and disbursements over the years to which they are deemed applicable, values inventories at the lower of cost or market so that their unrealized losses but not their unrealized gains are registered, carries the book value of fixed assets at original cost minus depreciation, and charges unrealized capital gains and losses not to income but to some special surplus account. Bonbright (1937) Vol. 2, 902-906.

<sup>9/</sup> Dan Usher refers to this possibility as follows: "At one extreme, the stock of subsoil assets is looked upon as given at the beginning of time, and all production represents a kind of depreciation." Usher (1980) 12.

come at discovery, at the establishment of proved reserves, or even at recognition of the economic worth of a natural resource as a result of technological developments.<sup>10/</sup> The addition of such economic reserves would distinguish a country which possesses them from a country in which the prospect of their impending extraction and sale does not exist.

In the past, the uncertain value of mineral resources at the time of their addition to national wealth, the uneven impact of such additions upon production and income, and perhaps hesitation over attributing to production and income resources emerging from nature, have prompted the exclusion from the national accounts' production and income accounts of both the addition of natural resources to national wealth and their subsequent depletion.

Given the increased importance now attached to reflecting the interaction between the economy and the environment in the national accounts, however, a solution to this dilemma may now be possible. This would lie in the growing recognition of the environment or nature as constituting a separate sector or account, similar to the rest-of-the-world account. In this context, the national economy may be viewed as "importing" natural resources from the environment, through discovery or development, for example. These "imports" would enter the capital account as an addition to inventories, or fixed capital, paid for by a corresponding capital transfer from the environment.<sup>11/</sup> The import of the natural resource would not enter the production account, thus avoiding distortionary effects upon GDP. However, the value added to reserves by expenditures for the discovery or development of the natural resource would enter the production account, with its product added to the value of the reserves in the capital account as a form of saving.

Upon extraction and sale, the value of the reserves utilized would be netted from GDP as intermediate consumption if treated as use of inventories, or

---

<sup>10/</sup> As James Bonbright writes in his classic work on valuation, "Certainly, for the purpose of monetary valuation, property has no value unless there is a prospect that it can be exploited by human beings." Bonbright (1937) Vol. 1, 21.

<sup>11/</sup> Andre Vanoli proposes the concept of capital transfers in kind from nature. Vanoli (1991) 11.

from Net Domestic Product alone if treated as consumption of fixed capital, since use of inventories is excluded from GDP, NDP, and income, while consumption of fixed capital is excluded only from NDP and income. The value of the utilized reserves would not result in an increase in the operating surplus in the production account but in a decrease in inventories, or fixed capital assets, in the capital account, giving rise to a corresponding increase in the financing account. Any use of the proceeds from sale of the reserves for current, rather than capital, expenditures, therefore, would be reflected in dissaving.

The requirements of symmetry would be satisfied by this treatment. The symmetry would come in the addition and subtraction of inventory in the capital account, however, and not in the production account. This would be appropriate, since it is not the production and subsequent use of natural resources that is to be measured but their addition to available supplies and subsequent use. The parallel with imports added to inventories is thus instructive.

#### STAGES OF VALUATION

While depletion of the natural resource is necessarily valued when extraction and sale occurs, valuation of its addition to national wealth may come at various points between its pre-discovery existence in nature and eventual extraction. A number of stages have been delineated and at times used for measurement purposes in the past.

Valuation of all existing supplies of a mineral in the earth is discouraged by M. A. Adelman, who finds the total mineral in the earth to be "an irrelevant, non-binding constraint. If expected finding-development costs exceed the expected net revenues, investment dries up, and the industry disappears. Whatever is left in the ground is unknown, probably unknowable, but surely unimportant; a geological fact of no economic interest."<sup>12/</sup>

---

<sup>12/</sup> Adelman (1990) 1.

A somewhat less inclusive measure is referred to by J. Steven Landefeld and James Hines as the "resource base" and includes reserves capable of being extracted under both current and future economic conditions and technology. They view such estimates as being very uncertain, relying on forecasts of prices, demand, and technology 50 to 75 years into the future and including undiscovered reserves inferred from geological information.13/

A more limited variation of total existing minerals is utilized by Michael Boskin and associates, who are concerned with measuring government wealth (and debt) as it affects taxpayer behavior in anticipation of future revenue requirements. They base their valuation of U.S. government wealth from future mineral lease and royalty payments on U.S. Department of Interior estimates of "economically recoverable undiscovered reserves . . . estimated to be recoverable and profitable to extract at current prices and technology."14/ They point out that ignoring undiscovered reserves can cause the government's sale of mineral rights leases, which precede exploration, to be treated in the income and wealth accounts as an increase in government receipts and wealth rather than as an assets sale.15/

To provide a comprehensive classification of mineral deposits, a diagram developed by V. E. McKelvey arrays gradations in their economic feasibility along one side and degrees of geologic assurance along another. Economic feasibility is indicated as either economic, paramarginal, or submarginal while geologic assurance is divided between identified and undiscovered. Identified is subdivided between demonstrated -- either measured or only indicated -- and inferred, and undiscovered subdivided between hypothetical (in known districts) and speculative (in undiscovered districts). Resources may be characterized as moving from speculative resources, to possible resources, to probable reserves, to proved reserves.16/

Proved reserves, sometimes referred to as developed reserves, of oil and gas are defined as those which "geological and engineering data demonstrate with

13/ Landefeld (1985) 3.

14/ Boskin (1985) 923-924.

15/ Boskin (1985) 926.

16/ Adelman (1983) 13-16.

reasonable certainty to be recoverable in future years from known reservoirs under existing economic and operating conditions," that is, under current prices and costs. Probable reserves cover what may be produced from the undrilled portions of known reservoirs, from the new horizons in those reservoirs, and from adjacent pools. In the U.S., probable reserves were reported to be two to three times the total of proved reserves. Probable reserves are defined by the Canadian Petroleum Association as "a realistic assessment of the reserves that will be recovered from known oil or gas fields based on the estimated ultimate size and reservoir characteristics of such fields."17/

An additional concept referred to as "oil in place" in particular oil fields, meaning the total amount of oil remaining in a field regardless of the cost of extracting it, is discussed by Hendrik Houthakker.18/

Physical parameters of deposits are used to identify the reserves of some resources. For coal, the U.S. Bureau of Mines has defined a "demonstrated reserve base" consisting of measured and indicated reserves in bituminous seams greater than 28 inches and subbituminous and lignite seams greater than 5 feet, which are up to 1,000 feet below the surface and can be economically mined at the time of determination.19/

For uranium, unlike other minerals, reserves and resources are presented by a particular measure of cost, "forward cost," denoting all expected future costs associated with production from the time of analysis. Reserves comprise known deposits, whose grade and physical shape are usually delineated by developmental drilling, that can be recovered at costs equal to or less than the selected forward cost category. A resource, inferred by some process that gives an expectation of ore occurrences, is converted into reserves by the exploration and development phase.20/

---

17/ Adelman (1983) 33, 49, 52. A comparison of the characteristics of proved and probable reserves is presented on pages 50-51.

18/ Houthakker (1980) 335.

19/ Adelman (1983) 298-300.

20/ Adelman (1983) 338, 346-347.

Particularly in the oil and gas mining industries, only a small part of proved reserves is established at discovery, roughly one-seventh during the 1946-1974 period in the U.S., for example.<sup>21/</sup> Most additions to reserves come through extensions of existing reservoirs through the drilling of additional development wells after the year of initial discovery, or through revisions arising from additional information concerning the performance of a reservoir, from new processes that increase recovery, or from other cost or price changes that affect feasibility of recovery.<sup>22/</sup> John Soladay refers to the resulting proved reserve figures as "a working inventory" of oil that can eventually be produced under current operating conditions.<sup>23/</sup> M. A. Adelman refers to proved reserves as a measure of "shelf inventory."<sup>24/</sup> To delay costly exploration and development expenditures, firms "prove" only enough of an inventory to meet short- and intermediate-run demand.<sup>25/</sup> Bain notes that for technical and financial reasons, it is sometimes inadvisable to develop ore reserves too far in advance. Under conditions in the great Mother Lode gold mine in California, for example, it was frequently "difficult and expensive to hold a drift for more than two years without retimbering," so that ore reserves in sight would seldom show more than a two years' supply.<sup>26/</sup>

In mining industries other than oil and gas, Landefeld and Hines state that additions are generally equal to new discoveries.<sup>27/</sup> Adelman states, however, that not only in oil, but also in uranium, copper and iron ore, a discovery initiates a long sequence of reserve additions.<sup>28/</sup>

One significant aspect of the various possible stages at which natural resources may be recognized as additions to national wealth is the information available on each. Estimates of the resource base, as noted above, are very uncertain. As regards U.S. data for proved reserves,

---

<sup>21/</sup> Soladay (1980) 354.

<sup>22/</sup> Soladay (1980) 354; Adelman (1983) 63.

<sup>23/</sup> Soladay (1980) 354.

<sup>24/</sup> Adelman (1983) 27.

<sup>25/</sup> Landefeld (1985) 3.

<sup>26/</sup> Bain (1950) 239.

<sup>27/</sup> Landefeld (1985) 3.

<sup>28/</sup> Adelman (1990) 4.

Landefeld and Hines concluded that while company-to-company reserve estimates are subject to random variation, it appears that aggregate oil and gas reserve statistics are more reliable. They found that proved hard-mineral reserves, though also subject to uncertainties, are known with more certainty than proved oil and gas reserves.<sup>29/</sup> A summary of the estimating procedures for proved reserves in the U.S. and Canada in earlier years is provided by Adelman and associates.<sup>30/</sup>

The United Nations' Guidelines on Statistics of Tangible Assets recommends including in the stock of tangible assets only those subsoil resources which are economically exploitable at the current level of technology, as they are more closely linked to current production than the total discovered resources.<sup>31/</sup>

#### VALUATION METHODS

The first question in the valuation of natural resources in the national accounts is whether they are to be assigned any value at all, it being understood that it is their role in economic activity, rather than any inherent physical quality, that would be valued. To simplify, one may ask whether a natural resource discovered, extracted, and sold within a single accounting period is to be assigned any part of the value at which it is sold. With the present national accounts production boundary, which counts only produced goods in production, no value is assigned to the natural resource; all of its value is assigned to the operating surplus, or profits. As George Jaszi wrote in 1958, positing, for the sake of simplicity, the sale of coal which requires neither labor nor capital for its extraction, this gives rise to the anomaly of "the inclusion in consumption of the value of natural resources that have not been counted as production."<sup>32/</sup>

---

<sup>29/</sup> Landefeld (1982) 167.

<sup>30/</sup> Adelman (1983) 29.

<sup>31/</sup> United Nations (1979) 6.

<sup>32/</sup> Jaszi (1958) 94.



This difficulty can be overcome by the treatment of natural resources as imports from the environmental account added to the capital account as inventories, or fixed capital, and subsequently utilized in the production process as intermediate consumption, or depreciation, as outlined above.

The fact that discovery, development, and extraction generally take place over more than one accounting period complicates the valuation of natural resources, which by providing returns in future periods take on the character of capital assets. Like other capital assets, natural resources may be valued as additions to capital at the time they enter the economic system and as subtractions from capital in the later periods when they are used. Consistent accounting requires symmetry between the addition and subtraction, so that the full value of a building, for example, is written off over its useful lifetime.

For purposes of the national accounts, to measure the values of production, income, and capital, both the addition and subtraction of the capital asset are registered at current value, whether it is a fixed capital asset or inventories acquired at one price and disposed of at another.<sup>33/</sup> Holding gains or losses accumulated between acquisition and disposal are not counted as production or income and enter the balance sheet valuation of assets only through the reconciliation (or revaluation) account. This procedure would apply also to the valuation of additions and subtractions of natural resources to economic reserves, requiring the use of the current value at whatever stage addition or subtraction is registered. In physical terms, and at base year prices but not current prices, the amount of a given addition to reserves would be equal to the total amount of extractions subtracted as it is used over the life of the reserves. To be consistent with the measurement of production, income, and capital in each period, measurement of depletion would have to be in current value even if additions to reserves were not to be registered.

Ideally, the current value of natural resources would be identified from the price they fetch, or would fetch, in a market sale. Though eventually sold

---

<sup>33/</sup> United Nations (1990) Annex 5.

in their extracted state, however, many natural resources may not be bought and sold at earlier stages, while they remain in the ground. Instead, to estimate their current value when no market price exists, the natural resources' share of the extracted sales price has been calculated as either 1) the residual after the subtraction of other costs, 2) the equivalent of a particular element of the price, such as royalties, 3) some fraction of the final sales price based on an industry rule-of-thumb, or 4) a value representing expert opinion or market consensus. Because both additions and subtractions impact fungible reserves whose extraction extends over a period of years, their in-ground market price reflects a discounting of prospective earnings over the useful life of the reserves, as well as expectations of future prices, costs, and the time path of production. In the absence of a market price, estimates of current value would reflect similar considerations.

These alternative approaches are evident in a number of studies estimating the value of reserves, particularly in the United States, in recent years. One approach has been based on the market price for a natural resource before the addition of other costs. Attempts have been made to identify such a value in the payments made to landholders for their lands or for the mineral rights to their lands, on the theory that "under conditions of long-run equilibrium in perfect competition the purchase price for a piece of physical capital or land should be equal to the present value of that asset."<sup>34/</sup> Extending this method to payments for lands leased, rather than purchased, for oil and gas exploration and extraction in the U.S., Landefeld and Hines emerge with estimates of the economic value of oil and gas reserves only 15 to 50 percent of the values they arrive at by alternate methods. They attribute these low estimates, however, to several factors: 1) incomplete coverage, since some firms owned lands and most production on federal onshore lands came from noncompetitively leased lands for which firms paid no bonuses; and 2) the competitive advantage of large integrated oil and gas companies dealing with individual landowners and even in bidding

---

<sup>34/</sup> Landefeld (1985) 12. Adelman, however, refers to lease bonuses or lease rentals not as costs but transfer payments, that is shares of past or expected profits paid to the landholders. Adelman (1986) 10.

for federal mineral rights.<sup>35/</sup> Boskin and associates attribute the low estimates also to Landefeld and Hines' use of royalties, in their valuation equation, as a percentage of net rather than gross revenue.<sup>36/</sup>

Most market sales of natural resources entering the economic sphere come after their mixture with other costs and in later time periods. This poses two problems: identifying the natural resource component of the market sales price, and determining the present value of its receipt over a string of future years.

As natural resources advance from an undiscovered state, through discovery, development, extraction, and sale, other expenditures are added to the natural resources' original value.<sup>37/</sup> While extraction costs may come in the same period as sale, earlier costs, for development for example, are generally attributable to sales in later periods, implying the need to treat them as capital. Some development expenditures may be capitalized separately, and depreciated as structures forming a part of fixed capital assets, for example. Others may be assimilated to the natural resource and reflected in a higher valuation of reserves to be treated as capital assets.<sup>38/</sup> This could be as the costs of inventories carried over to future periods, or as the components of capital assets which will produce in future periods, depending upon whether use of the natural resource at sale is to be treated as a reduction in stocks<sup>39/</sup> or as depreciation, similar to that of fixed capital.<sup>40/</sup>

Estimates of oil development and operating costs for 41 oil-producing nations from 1955 to 1985 have been prepared by M. A. Adelman and Manoj

<sup>35/</sup> Landefeld (1985) 12-14,16.

<sup>36/</sup> Boskin (1985) 925.

<sup>37/</sup> Usher, for example, identifies one alternative approach to counting natural resources as "recognizing both proved and unproved reserves as part of the capital stock, but unproved reserves would have a lower shadow price, so that discovery increases the quantity of capital." Usher (1980) 12-13.

<sup>38/</sup> Treatment of mineral exploration expenditures is discussed in Carson (1988).

<sup>39/</sup> Bartelmus (1989) 18.

<sup>40/</sup> Ahmad (1989) 3-4.

Shahi, using U.S. drilling costs and publicly available data on drilling.<sup>41/</sup> Several works noted below have utilized subtraction 1) of dollar per barrel extraction costs to obtain net prices, 2) of discounts to obtain the in-ground value of developed reserves, and 3) of development costs to estimate the value of undeveloped reserves.

Data on worldwide exploration expenditures are presented in a recent study by Phillip Crowson.<sup>42/</sup> Identification of dollar per unit finding or exploration costs, however, is more difficult, since the extent of discoveries is not fully identified until subsequent development.<sup>43/</sup> Unsuccessful exploration expenditures, that is, those which do not lead to discovery, may be treated as losses expensed in the period in which they are made, or aggregated with successful exploration expenditures, in which case they could lead to possible negative operating surpluses at sale. H. Foster Bain has stated, for example, that while U.S. gold mining brought profits to particular companies or individuals, it was not enough to return the invested capital plus a profit to the industry as a whole.<sup>44/</sup>

The market price -- and current value -- of in-ground natural resources is likely to reflect a somewhat different valuation of future income streams than valuation of other capital assets. A potential purchaser of natural resource reserves, comparing their rate of return with that on other investments of comparable risk, would note that the return on other investments, such as manufacturing or real estate, would be calculated after provision for the maintenance of the capital itself, through the use of funds made available by regular depreciation allowances. The capital value of other investments, therefore, would be maintained and available in the future, should their sale become necessary. Comparable returns on the mining investment -- where exhaustion of the mined resources makes maintenance of the capital impossible -- would have to provide for the replacement of capital instead through regular contributions to a sinking fund whose investment, at a more moderate, lower-risk, rate, would replace

---

<sup>41/</sup> Adelman (1989) 2-10.

<sup>42/</sup> Crowson (1988) 21-103.

<sup>43/</sup> Adelman (1989) 7.

<sup>44/</sup> Bain (1950) 257.

the initial value of the investment when the resource is exhausted.<sup>45/</sup> Valuation of mining properties on this basis, referred to as the Hoskold formula, is similar to capitalization of the annual net income of an ordinary enterprise, with an annual allowance for depreciation computed on a sinking-fund basis.<sup>46/</sup> To facilitate such calculation, for example, Herbert Hoover included in his 1909 book, Principles of Mining, a table showing the "Present Value of an Annual Dividend over 1 to 40 Years at 5 to 10 Percent and Replacing Capital by Reinvestment of an Annual Sum at 4 Percent."<sup>47/</sup>

Some more recent works estimating the value of total national reserves of particular natural resources, rather than of individual mining properties, have provided for an annuity-like sinking fund<sup>48/</sup> while others have not.<sup>49/</sup>

Besides such differences in the setting of appropriate interest rates, various approaches have been taken also toward the projection of future prices and costs and of the production time path along which this net revenue will be realized.

The difficulties of projecting future prices, costs, and production time paths are avoided in studies of past periods, an outstanding example being John Soladay's measurements for the U.S. oil and gas mining industries for the 1948-1974 period. Soladay derived the average production time paths for oil and gas from data for reserves, new additions to reserves, and production for each of 18 oil producing states representing 98 percent of U.S. production and reserves. Applying these time paths to national data for total reserves, new additions to reserves, mining companies' acquisition costs (including both expensed and depreciated capital outlays), and

<sup>45/</sup> Hoover (1909) 42-50.

<sup>46/</sup> Bonbright (1937) 256 n.25 citing Hoskold (1905).

<sup>47/</sup> Hoover (1909) 46.

<sup>48/</sup> Bain, for example, uses investment and sinking-fund rates of 12 and 4 percent, 10 and 4 per cent, and 8 and 3 percent, respectively in calculating the present value of recoverable U.S. gold reserves in 1929, 1939, and 1947. Bain (1950) 256.

<sup>49/</sup> For example, Landefeld (1985) 16.

subsequent net revenues, he was able to attribute to each year a string of subsequent net earning, valued at alternative rates of discount. This yielded values, that is, the present value of discounted future net revenues, for total reserves and for new additions to reserves each year.

By subtracting acquisition costs from the value of new additions to reserves, Soladay derived the value of the underlying natural resource, which he referred to as capital gains on acquisition. At a 5 percent real rate of discount, acquisition capital gains averaged 61 percent of the value of new oil acquired each year. Depreciation, estimated as the change in the value of the existing stock of developed oil reserves (net of new additions), averaged 13 percent of the mean value of oil stocks.50/

Another approach, based on a presumed resource share of sales price rather than the subtraction of acquisition costs, was followed by H. Foster Bain. To estimate the value of proved U.S. oil and gas reserves in the ground in 1929, 1939, and 1946, exclusive of values added by drilling and equipping wells, he used the average royalty rates paid to landowners -- 12.5 percent for oil and 10 percent for natural gas -- as an approximation of the natural resource share. Applying these rates to the dollar value of production in 1929, 1939, and 1946, he obtained an annual amount assignable (on the assumption of constant prices and a straight-line time path of production) to each subsequent year in which production from existing reserves at the current year's rate could continue -- 13, 19, and 14 years, respectively. The present value of the reserves in the three base years, was then calculated assuming an 8 percent return on invested capital with sinking fund rates at 4 percent in 1929, 3.5 percent in 1939, and 3 percent in 1946.51/

For the valuation of iron ore, Bain applied to 1945 reserve tonnage the value fixed by another source, the 12.5 cents per ton assessed by the Minnesota Tax Commission in its taxation of reserves in the ground between discovery and production.52/

---

50/ Soladay (1980) 364.

51/ Bain (1950) 265-266.

52/ Bain (1950) 268.

An approach using a rule-of-thumb ratio to move from sales price to the in-ground value of developed reserves, which reflects the discount element, was used by Adelman. He prepared "very rough" estimates of reserve values in the United States using for the years 1970-73 an industry rule-of-thumb that developed oil reserves in the ground were sold for about one-third of the market price, a ratio regained, after some interruption, by the mid-1980s.

In an additional set of estimates, Adelman also subtracted identified costs from sales price to arrive at resource value. By subtracting from the market price the sum of operating plus development costs, he calculated for the 1970-1986 period the resource value of an undeveloped unit in the ground. This he utilized as an explanatory and predictive indicator, which, when it is above finding costs, serves to stimulate exploration efforts.<sup>53/</sup>

A comparison of several approaches was undertaken by Landefeld and Hines. They subtracted extraction costs, but not the discount element, to move from sales price to the net price, but employed various projections of future net price and a standard discount rate to estimate the in-ground value of developed reserves. They presented several sets of estimates for the value of U.S. oil and gas reserves during the 1948-79 period, in addition to the estimates based on mineral rights payments discussed above. They calculated the net price per unit of oil and gas, after removal of both variable costs and the current replacement value of producers' net stock of physical capital, and applied it with specified adjustments to the physical quantity of proved reserves and to changes in proved reserves.

One set of estimates employed no real increase in net prices and a constant real 10 percent rate of discount, the assumptions required of companies' supplementary disclosure forms by the U.S. Securities and Exchange Commission. Another assumed that future net prices would increase or decrease at a rate equal to the average change over the previous five years, and applied a constant real 10 percent rate of discount. A third set of estimates, which they referred to as the net price method and which was based on the Hotelling Theory, assumed increases in net prices equal to the

---

<sup>53/</sup> Adelman (1986) 30-32, 35.

rate of discount, so that valuation of total reserves, additions to reserves, and depletion, could be calculated by multiplying their physical quantities by the current net price.<sup>54/</sup>

Considerable simplification is brought to valuation by the assumptions of the Hotelling Theory, which was formulated in 1931 by Harold Hotelling and forms the basis for most subsequent theoretical work. This holds that "the unit price of an exhaustible natural resource, less the marginal cost of extracting it, will tend to rise over time at a rate equal to the return on comparable capital assets," the upward trend serving to guide resource owners in their choice between current and future extraction.<sup>55/</sup> Application of the Hotelling Theory obviates the need for discounting or forecasting prices, makes the production time path irrelevant, since the net return rises with the interest rate, and permits valuation of reserves at the net return in the current period.

These assumptions have been challenged on several grounds, however. Houthakker has noted that "empirical studies of mineral prices have found little or no support for Hotelling's proposition," suggesting rather that "for a wide range of minerals net prices have remained constant in real terms when averaged over long periods of time."<sup>56/</sup> Other objections, by Adelman, center on the model's "major implicit premise [of] ... zero investment," that is, neglect of the development phase, which can involve considerable investment, between discovery and extraction.<sup>57/</sup> While higher interest rates lower the discounted value of future alternative use and hence the opportunity cost of earlier extraction, they also increase the opportunity cost of investment in the development of discovered reserves, thus discouraging earlier extraction. On balance, Adelman concludes, interest rates have a minor and indeterminate effect on resource owners' choice between present and future extraction. It is increasing marginal costs that limit the expansion of extraction in the current period to avoid the interest cost of waiting.

---

<sup>54/</sup> Landefeld (1985) 14-16.

<sup>55/</sup> Miller (1985) 1-2.

<sup>56/</sup> Houthakker (1980) 337-338.

<sup>57/</sup> Adelman (1990) 5.



Rather than the Hotelling problem of a fixed stock of available reserves to be divided between periods on the basis of net returns and interest rates, Adelman sees flows from unknown resources into a reserve inventory, influenced by rising marginal costs offset by increasing knowledge of new fields, geological conditions, and improved technology, with the result that in the long run practically all mineral prices have declined.

To illustrate the discounting of future returns influenced by the interplay of increasing costs, the depletion rate of reserves, and the discount rate, Adelman cites the case of U.S. oil in the post-World War II period, during which the depletion rate -- extraction divided by reserves -- was approximately equal to the discount rate. Reflecting a relationship between in-ground value and net price roughly equal to the depletion rate divided by the sum of the depletion rate and the discount rate, he writes, "the in-ground value per barrel [of proved reserves] has long fluctuated around a mean near one-half of the net price (one-third of gross wellhead price), in conformity with an industry rule of thumb."58/

One possible illustration of a relationship between resource values at various stages may be constructed -- without any claim as to its validity -- by combining these proportions with Soladay's findings, discussed above, of acquisition costs averaging 39 percent and acquisition capital gains 61 percent of the value of new additions to proved oil reserves in the U.S. in the 1948-74 period. This yields the following proportions:

Wellhead price	3
Minus extraction costs	1
Equals net price	2
Minus discount to present value	1
Equals in-ground value of proved reserves	1
Minus acquisition costs	0.39
Equals resource value	0.61

---

58/ Adelman (1990) 6.

The value of the resource, before the addition of other costs, in this case equals 20 percent of the gross wellhead price, 30 percent of the net price, and 61 percent of the in-ground value of proved reserves.

While these relationships vary between wells, mines, minerals, countries, and periods, the calculation of similar relationships for other minerals, countries and periods may suggest one approach to valuation in the absence of continuing availabilities of complete data on market prices and costs.

In the valuation of depletion, that is the withdrawal of natural resources from reserves, it is important that the same principles be used as in arriving at the current value of additions to reserves. The acquisition costs incurred in previous periods for resources sold in the current period would be reflected in either the separate depreciation of fixed capital assets or in the value of reserves to be treated as depletion. The current value of the withdrawn reserves would be determined by either market price or its various approximations -- subtraction of costs<sup>59/</sup>, use of rule-of-thumb ratios or expert opinions, identification with particular elements such as royalties, or the discounting of net price with assumptions on its future movement. Whether withdrawn reserves fully offset the physical amount or base year value of previous additions would depend on how closely the estimates of the volume of added reserves turn out to match the volume of eventual extractions. In any case, and even without the registration of additions to reserves, valuation of withdrawals by market price, or by the other approximations of current value, is necessary for consistent measurement of production and income.

A number of suggestions have been advanced for the estimation of depletion in the absence of more complete information. Salah El Serafy, to indicate the amount a nation should invest so as to replace the income it received from a nonrenewable asset, proposes a depletion allowance calculated as a proportion of total receipts, net of extraction costs, on the basis of the ratio of total reserves to current period extraction (the life expectancy in

---

<sup>59/</sup> Stauffer raises the question of full economic costs including a rate of return with some premium for exploration risk. Stauffer (1985) 73.

years) and a discount rate chosen to approximate a market parameter for prudent behavior.60/

Michael Ward has proposed an annual depletion fund appropriation equal to the present discounted value of total reserves at current prices, or at a base year price, divided by the number of years' output in reserves at the current annual physical output.61/

Robert MacNamara, former president of the World Bank, is cited by Thomas Stauffer as proposing an arbitrary adjustment to oil exporters' incomes of 25 percent to reflect the otherwise elusive measure of depletion.62/

### CONCLUSION

While persuasive arguments have been advanced for the registration of additions to reserves symmetrically with withdrawals, the appropriate point of addition and subtraction would appear to be the capital account rather than the production account, since the natural resource is not produced by the economy but imported from the environment. Only the value added by expenditures for exploration or development would pass through the production account before registration as an addition to assets in the capital account. There need be no concern, therefore, over a possibly uneven impact of additions to reserves upon production and income totals since both would be unaffected by the addition of natural resources as assets in the capital account. The use of reserves, moreover, would be appropriately reflected as the use of a capital asset, giving rise to dissaving if the proceeds are used for consumption rather than investment.

Additions of reserves may be recognized at various stages in the nature-to-extraction process, but there are advantages in registering entry at a stage representing a close involvement in the economic system. At the stage of proved or developed reserves, for example, the quantity of reserves is

---

60/ El Serafy (1989) 13-16.

61/ Ward (1982) 63.

62/ Stauffer (1985) 74.

delineated by economic activity and their status is viewed by some in the mining industry as a kind of working inventory.

The availability of data may be expected to vary substantially from country to country. The commercialized nature of the extraction and sale of depletable resources, however, should add materially to the possibilities for valuing natural resources added and withdrawn from reserves. Though standardized methodologies remain to be developed, the variety of approaches demonstrated in the studies cited above suggests that the valuation of depletable resources by procedures related to market price should be feasible.

REFERENCE

- Adelman, M.A., Houghton, John C., Kaufman, Gordon, and Zimmerman, Martin B., Energy Resources in An Uncertain Future: Coal, Gas, Oil, and Uranium Supply Forecasting, (Cambridge, Massachusetts: Ballinger Publishing Company, 1983).
- Adelman, M.A., Finding and Development Costs in the USA 1945-1985, MIT Energy Laboratory Working Paper No. MIT-EL 86-008WP (Cambridge, Massachusetts: December 1986).
- Adelman, M.A., and Shahi, Manoj, "Oil Development-Operating Cost Estimates, 1955-85," Energy Economics, Vol. 11, No. 1, (January 1989), pp. 2-10.
- Adelman, M.A., "Mineral Depletion, With Special Reference to Petroleum," The Review of Economics and Statistics, Vol. LXXII, No. 1, (February 1990), pp. 1-10.
- Ahmad, Yusuf J., El Sarafy, Salah, and Lutz, Ernst, eds., Environmental Accounting for Sustainable Development, (Washington, D.C.: The World Bank, 1989).
- Bain, H. Foster, et al., "Subsoil Wealth," Studies in Income and Wealth, Vol. 12, (New York, National Bureau of Economic Research, 1950), pp. 235-273.
- Bartelmus, Peter, Stahmer, Carsten, and van Tongeren, Jan, "SNA Framework for Integrated Environmental and Economic Accounting," Paper delivered to the Twenty-first General Conference of the International Association for Research in Income and Wealth, Lahnstein, West Germany, (August 1989).
- Bartelmus, Peter, Stahmer, Carsten, and van Tongeren, Jan, "Selected Issues in Integrated Environmental-Economic Accounting," Paper delivered to the Special Conference on Environmental Accounting of the International Association for Research in Income and Wealth, Baden, Austria, (May 1991).
- Berger, John J., Restoring the Earth. How Americans Are Working to Renew Our Damaged Environment, (New York: Alfred A. Knopf, 1986).
- Bonbright, James C., The Valuation of Property, Vols. 1 and 2, (New York: McGraw-Hill Book Company, Inc., 1937).
- Boskin, Michael J., Robinson, Marc S., O'Reilly, Terrance, and Kumar, Praveen, "New Estimates of the Value of Federal Mineral Rights and Land," The American Economic Review, Vol. 75, No. 5, (December 1985), pp. 923-936.

- Carson, Carol S., "Mineral Exploration," paper prepared for the January 1989 meeting of the SNA Expert Group meeting in Luxembourg, (December 1988).
- Cronon, William, Challenges in the Land: Indians, Colonists, and the Ecology of New England, (New York: Hill and Wang, 1983).
- Crowson, Phillip C. F., "A Perspective on Worldwide Exploration for Minerals," Tilton, John E., Eggert, Roderick G., and Landsberg, Hans H., eds., World Mineral Exploration, Trends, and Economic Issues, (Washington D.C.: Resources for the Future, 1988), pp. 21-103.
- El Serafy, Salah, "The Proper Calculation of Income from Depletable Natural Resources," Ahmad, Yusuf J., El Serafy, Salah, and Lutz, Ernst, eds., Environmental Accounting for Sustainable Development, (Washington, D.C.: The World Bank, 1989), pp. 10-18.
- Hoover, Herbert C., Principles of Mining, Valuation, Organization, and Administration, Copper, Gold, Lead, Silver, Tin and Zinc, (New York: McGraw-Hill Book Company, Inc., 1909)
- Hoskold, H. D., Engineer's Valuing Assistant, 2d ed., ( London, 1905), cited in Bonbright, James C., The Valuation of Property, (New York: McGraw-Hill Book Company, Inc., 1937), Vol. 1, p. 256, n. 25.
- Houthakker, Hendrik S., "The Use and Management of North Sea Oil," Caves, Richard E., and Krause, Lawrence B., eds., Britain's Economic Performance, (Washington D.C.: The Brookings Institution, 1980), pp. 331-380.
- Hubbard, Harold M., "The Real Cost of Energy," Scientific America, Vol. 264, No. 4, (April 1991), pp. 36-42.
- Jaszi, George, "The Conceptual Basis of the Accounts, A Re-examination," A Critique of the United States Income and Product Accounts, Studies in Income and Wealth, Vol. 22 (Princeton: National Bureau of Economic Research, 1958), pp. 15-127.
- Landefeld, J. Steven, and Hines, James R., "Valuing Non-Renewable Resources: The Mining Industries," Measuring Nonmarket Economic Activity, Bureau of Economic Analysis Working Paper 2 (Washington D.C.: U.S. Department of Commerce, December 1982), pp. 136-168.
- Landefeld, J. Steven, and Hines, James R., "National Accounting for Non-Renewable Natural Resources in the Mining Industries," The Review of Income and Wealth, Ser. 31, No. 1, (March 1985), pp. 1-20.
- Levin, Jonathan, "The Economy and the Environment: Revising the National Accounts", IMF Survey, (June 4, 1990), pp. 161,168-169.
- McElroy, Michael B., "Capital Gains and Social Income," Economic Inquiry, Vol. XIV, No. 2, (June 1976), pp.228-229.

- Miller, Merton H., and Upton, Charles W., "A Test of the Hotelling Valuation Principle," Journal of Political Economy, Vol. 93, No. 1, (February 1985), pp. 1-25.
- Sauer, Carl, Land and Life, (Berkeley: University of California Press, 1963).
- Soladay, John J., "Measurement of Income and Product in the Oil and Gas Mining Industries," The Measurement of Capital, Dan Usher, ed., (Chicago: The University of Chicago Press, 1980), pp. 347-376.
- Stauffer, Thomas R., "Accounting for 'Wasting Assets': Measurements of Income and Dependency in Oil-Rentier States," The Journal of Energy and Development, Vol. XI, No. 1, (Autumn 1985), pp. 69-93.
- Tilton, John E., Eggert, Roderick G., and Landsberg, Hans H., eds., World Mineral Exploration, Trends, and Economic Issues, (Washington D.C.: Resources for the Future, 1988).
- United Nations, Guidelines on Statistics of Tangible Assets, Statistical Papers, Ser. M, No. 68, Sales No. E.80.XVII.2 (New York: United Nations, 1979).
- United Nations, Annex 5, "Changes in Stocks and Holding Gains," Revised System of National Accounts: Draft Chapters and Annexes, Provisional, United Nations Document ST/ESA/STAT/SER.F/2/Rev.4, 1990, (New York: United Nations, 1990).
- Usher, Dan, Introduction, The Measurement of Capital, Usher, Dan, ed., (Chicago: The University of Chicago Press, 1980), pp. 1-21.
- Vanoli, Andre, "Some Notes on Various Issues Concerning Environmental Accounting," Uncirculated draft originally prepared for the Special Conference on Environmental Accounting of the International Association for Research in Income and Wealth, Baden, Austria, (May 1991).
- Ward, Michael, Accounting for the Depletion of Natural Resources in the National Accounts of Developing Economies, (Paris: Organization for Economic Cooperation and Development, Development Centre, June 28, 1982).

## DEPLETABLE RESOURCES: FIXED CAPITAL OR INVENTORIES?

Salah El Serafy

Environment Department, The World Bank

### *Natural Resources as Capital*

The notion that environmental resources should be viewed as capital is certainly gaining acceptance. Such resources, even if they are not appropriable, do contribute to the productive process, or otherwise yield utilities for which users are willing to pay a price, either directly or indirectly.<sup>1</sup> Practically all natural resources are depletable, but some of them are also renewable, i.e. capable of being regenerated by nature, or more often by nature with human assistance. Sometimes even renewable resources can rationally be "mined" to extinction by their owners in deliberate acts of capital consumption.

Seeking to recognize environmental degradation in national accounting has emanated largely from the observable fact that natural capital is being depleted without such depletion being reflected adequately in income and wealth

---

<sup>1</sup> El Serafy, S. [1991] "The Environment as Capital," in R. Costanza (ed.), *Ecological Economics: The Science and Management of Sustainability*, Columbia Press, New York.



measurements. In other words "income," as conventionally measured, is often inflated by elements of capital that should be expunged from it. Such inflation, apart from reflecting faulty measurements, also indicates unsustainable levels of consumption which can artificially be maintained only through implied disinvestment, and would lead inevitably to future income decline. If such capital elements can be identified and purged from income measurements, a more accurate level of income would emerge which would better reflect economic performance and provide an improved basis for economic policy prescriptions. Mixing capital with income in the accounts is not a minor matter, either in economics or accounting.

Should the depletion of non-renewable resources in the process of their exploitation be reckoned as depreciation in parallel with the treatment of wear and tear and obsolescence of fixed capital? Or, alternatively, should such depletion be treated as using-up of inventories in the process of production? The answer to this question should determine the treatment of depletion of non-renewable resources in the national accounts. Most people who have expressed a view on this issue seem to favor the fixed-capital-depreciation approach, preferring that GDP should be left unadjusted as conventionally reckoned, claiming that all that is required is to adjust NDP for the "depreciation" of depletable resources. This paper seeks to refute this view, building on two papers I already published [1981; 1989] where I proposed a formula indicating the true level of income derived from the exploitation of a depletable natural resource, and identifying the "user cost" of such exploitation.<sup>2</sup>

---

<sup>2</sup> El Serafy, S. [1981] "Absorptive Capacity, the Demand for Revenue and the Supply of Petroleum," *Journal of Energy and Development*, Volume VII, No. 1, Autumn; and El Serafy, S. [1989] "The Proper Calculation of Income from Depletable Natural Resources," in Ahmad, Y. A. *et al.*, a UNEP World Bank Symposium, Washington, D.C.

### *Inventories, Not Fixed Capital*

Why should depletable resources be treated as inventories rather than fixed capital? There are at least three arguments. First, while fixed capital needs to be maintained for the purpose of sustaining future activity, depletable natural capital, by its very nature, cannot be maintained if it is exploited at all. From the accountant's perspective, there is no sense in attempting to "keep it intact" in the manner fixed capital needs to be kept intact for the calculation of income. Second, we have to reflect on the genesis of both kinds of capital to realize how very different the two types are. Fixed capital derives originally from previous income flows, being an embodiment of part of the savings that were cut from (past) current income and sunk in investments. Seeking to maintain the stock of past investments through deductions for depreciation from current income, seems quite straightforward. Natural capital, on the other hand, had existed all along, and the human and other contributions in locating and developing it, though involving some cost, that cost is not at all on a comparable scale with the human and other factors' contribution to the formation of fixed capital. The surplus or rent that natural capital yields over and above the cost of locating and developing it is often not commensurate with the efforts made and opportunity costs incurred, and derives in large part from the "Bounty of Nature," a bounty which is rapidly diminishing as the scale of human activity grows. A third argument is that fixed capital is not normally meant to be sold by its owners, and is sold only in exceptional circumstances such as bankruptcy of the productive unit, or consequent upon serious and unexpected obsolescence. Inventories, on the other hand, including raw materials, goods in progress, as well as finished products are held specifically to be either "used up" or traded in the normal course of business. Changes in inventories in standard accounting are treated at the gross income (or gross profits) determination stage, not at the net income (or net profits) calculation stage. Furthermore, unlike the depreciation of fixed capital, reductions in inventories during the accounting period are directly observable, and whereas depreciation of fixed capital can only be roughly estimated, usually by imputing an arbitrary life span to the asset concerned, the using up of inventories can be readily estimated, and

usually bears some relationship to the level of production. Such "using-up" approximates that element in fixed capital depreciation which Keynes identified as a "user cost."<sup>3</sup>

### ***Holistic versus Partial Approaches***

This paper will focus on those aspects of the subject captured in the title, but I do not wish to pass this opportunity without addressing another relevant tendency that also appears to be misguided. This relates to the seemingly popular tendency to seek an integrated, "holistic" system of balance sheets and flow accounts, starting from the "wealth" end, by listing all natural resources at a point of time before ascertaining annual changes in this wealth in an attempt to bring these changes into the flow accounts. I submit that we will never be able to make a complete list of the *physical* stock of natural resources extant at any point of time, let alone attach a *money value* to them in order that we might capture the annual changes of such a value in the flow accounts. Any pretense that we shall be able to do so shortly or even, I assert, eventually, should be dismissed as wishful thinking. What is feasible in this area is to identify in individual country situations those aspects of measurable environmental degradation that are of the most importance, and be content with adjusting the conventional accounts, particularly *income*, to reflect such partial degradation. Forestry, fisheries, petroleum and other minerals, singly or severally, play a formidable role in the prosperity and future development of certain countries whose national income measurement should reflect the degradation of their natural resource base to the extent that these resources are economically significant for the countries concerned.

We should therefore be content to present better measurements of partially corrected income (e.g. for forestry; or for forestry and petroleum; etc.) in the knowledge that total correction, covering all aspects of the environment, is beyond

---

<sup>3</sup> Keynes, J. M. [1936] *The General Theory of Employment, Interest and Money*, Macmillan and Co., London, Chapter 6: "Appendix on User Cost."

reach. In this I walk in the footsteps of Pigou [1924] who, writing on economic welfare two generations ago, decided that human welfare was too vast an area to lend itself to meaningful economic analysis, and selected from it those aspects which could be brought into some "relationship with the measuring rod of money." Pigou thus identified a subset of welfare considerations that he called "welfare economics" in the hope that as time went by more aspects of human welfare will be economically measured so that the subject matter of economic welfare will expand.<sup>4</sup> Analogously we should aim at partial adjustments of the accounts in the expectation that our information about the environment will improve, thus gradually improving *income* measurements as we increasingly bring into the adjustment a wider environmental coverage. I emphasize income rather than wealth, because wealth measurement in money terms is much less necessary for economic purposes, and we gain little by assigning to indeterminate quantities of natural assets dubious valuations that either elude the marketplace altogether, or inevitably gyrate with fluctuating market prices.

### ***Windfalls and Re-estimation***

Once we have conceded that the holistic approach is not practicable, the case for approaching income estimation from the stock end, I believe, becomes seriously undermined. In size, stocks of natural resources are often of a higher order of magnitude than annual extraction, and the imputed change in wealth consequent upon price changes and the re-estimation of the stock, if this is reckoned as a direct contribution (negative or positive) to income, can be so large as to be destructive of meaningful income measurements. We have only to look at the work of Repetto *et al.* of WRI on Indonesia [1989] to realize the inadequacy of such an approach.<sup>5</sup> Not only does the adjustment proposed there for petroleum dwarf the

---

<sup>4</sup> Pigou, A.C. [1924] *The Economics of Welfare*, Second Edition, Macmillan and Co., London, pp 10-11.

<sup>5</sup> R. Repetto *et al.* [1989] *Wasting Assets, Natural Resources in the National Income Accounts*, World Resources Institute, Washington D.C.

adjustments for other natural resources (forestry and soil) but the bulk of the adjustment for petroleum stems from reserve reassessments. With upward re-estimation of reserves vastly exceeding extraction during the relevant accounting periods, the WRI study ends up with the anomalous result that *net* income in some years is greater than *gross* income, and the so-called natural asset depreciation is allegedly *appreciation*. We have only to reflect upon any usefulness of such income estimation, either for indicating a sustainable level of consumption (which should be viewed as the primary purpose of income estimation) or to provide a benchmark for gauging economic performance (in order to guide economic policy) to realize the inadequacy of such an approach which--as illustrated by the WRI study of Indonesia--rendered fluctuating estimates of income, totally unrelated to performance and devoid of economic significance. Windfalls in the form of upward re-estimation of known reserves of natural stocks (and their obverse: downward re-estimation) must not directly be brought into the flow accounts, though the accountants, of course, have to acknowledge them indirectly as I have proposed under my "user cost" approach.

### *Conceptual Arguments*

Once we have accepted the notion that depletable resources are capital, or in the accountant's language, "assets," we must be clear how the economist and the accountant deal with sales of assets. For the economist sales of assets do not generate value added, and for him it would be wrong for such sales to be mixed with income at all, however "gross" the income is claimed to be. As to the accountant, do we expect him to show the gross proceeds from the sale of real estate owned by a firm in the "profits and loss account" which is the venue for calculating gross income? And do we expect him later to take out the same value (which represents a decline in the firm's asset portfolio) from the inflated gross income or profits in order to reckon net income? If a firm converts one asset (say, a building) into another (say, cash) we would expect this to show up in the accounts as *asset substitution*, and the balance sheet will eventually portray this. Only that part of the receipts which can somehow be assessed as "profits" realized

on the asset sale, can have any claim to being described as income. If a country has a stock of forests or proven reserves of petroleum, it theoretically can liquidate (i.e. convert into cash) such a stock in one go, and generally speaking it has the freedom to do so over a variable time horizon at the owners' discretion. This discretion is available without penalty if the owners' market-share is small and accelerated sale would thus not depress the market price. If we follow the WRI approach for Indonesia, gross income in the year of sale would be inflated by the value of the stock liquidated, and net income (from the asset itself) after adjustment for the so-called depreciation, will amount to nil. In subsequent periods no income from the resource will be reckoned at all since the asset itself will have vanished. In a sense WRI have shown the way how *not* to adjust income for depletable natural resources.

### *The Proposed Method*

As mentioned earlier, I elaborated what I believe to be the correct approach to income accounting for depletable resources in 1981 and again in 1989.<sup>6</sup> Inasmuch as depletable resources are ascertainable in volume terms (taking account, as far as possible, of quality differences), we should ask the basic question: what is the proportion of the total stock that is being liquidated in the present accounting period? In this respect I viewed such a stock as "working capital" or inventories. The implications for income reckoning hinges fundamentally on the answer to this question. Clearly if the asset is being liquidated in one go, the effect on income is different from its being liquidated in stages over twenty years or a hundred years.

While the answer to this question is simple, the technological background (e.g. quality differences; costs as a function of extraction; etc.) may be far from simple. However, as a first step we can observe unequivocally whether the proven reserves of a mineral would last twenty years at the current rates of extraction. If we were to double the exploitation rate the same stock of the natural resource would last ten

---

<sup>6</sup> See note (2) *supra*.

years. Sticking with the latter profile, we can say that extraction is one-tenth of the stocks in that particular year. Entrepreneurial behavior (i.e. the level of extraction) and the size of reserves (which may be freshly reassessed from year to year) will always indicate to the accountant the proportion of the stock that is being liquidated in the current year.

Since we know the quantity extracted, we will know from the current year's market price the value of this extracted quantity. Thus valuation is not a problem if the asset has a market price. From this we must deduct extraction costs. But not all the net sales proceeds can be reckoned as income, since if extraction proceeded at the same quantity year after year the resource would be extinct in ten years; and if the rate of exploitation is doubled, the resource will be extinct in five years. I followed up on a proposal made by Hicks [1946] in respect of income from a "wasting asset," to the effect that part of the proceeds from such an asset should be set aside and reinvested so that the yield on the investments would compensate for the dwindling resource.<sup>7</sup> I set out to find out how much from a depletable resource should be set aside and reinvested (the remainder being legitimately considered as income) so that the total return, both from the new investments and from that part of current extraction that can truly be reckoned as income, would continue undiminished indefinitely, thus satisfying the fundamental characteristic of income, i.e. its sustainability over time. I was able to indicate determinate levels of true income from the sales proceeds of wasting assets. This method has been applied in several places, and continues to yield what I believe to be satisfactory estimates of income from depletable resources, and its complement, the "user cost," or depletion factor that should be set aside and reinvested.<sup>8</sup> The

---

<sup>7</sup> Hicks, J. R. [1946] *Value and Capital*, Second Edition. Oxford: Clarendon Press, Chapter XIV (Income).

<sup>8</sup> Applications of the "El Serafy method" to re-estimate national or regional income include for the United States Herman E. Daly and John B. Cobb, Jr. *For the Common Good* (Boston: Beacon Press, 1989, pp. 419 and 437-40); and George E. Foy, "Accounting for (continued...)"

implications for macroeconomic--as well as microeconomic--policy of such income re-estimation can be considerable.

Aside from life expectancy of the reserves at current extraction rates, the only other value that is required to estimate true income is the interest rate that will be earned on reinvesting this "user cost" or depletion factor. Such a rate will obviously have to be arbitrary. If we use a high interest rate like 10%, the owner may not in fact be able to obtain from the market such a return on the new investments. On the other hand, the owner might be expected to be able to earn a real rate higher than, say, 2%. If, however, the owner were to get only a 2% return on the new investments, this would involve counting as a user cost, to be reinvested, a much larger slice of current receipts in order that such a larger quantity could generate

---

<sup>8</sup>(...continued)

Non-Renewable Natural Resources in Louisiana's Gross State Product" (*Ecological Economics*, Volume 3, No. 1, March 1991). See also World Bank, Environment Department Working Papers on Mexico and on Papua New Guinea both being case studies for "Integrated Environmental and Economic Accounting" (December 1991 and February 1992, respectively). The El Serafy method has also been applied to Ecuador's energy sector, and led to the recommendation that an Investment Fund be set up to embody the user cost of Ecuador's energy resource exploitation for the purpose of generating future income. (See Chapter V by Ulrich Thumm: "Energy Developments and Policy Issues," in World Bank's *Ecuador: Country Economic Memorandum* (Report No. 7321-EC, Latin America and the Caribbean Regional Office, August 1988). Among several applications in Canada has been the estimation of the user cost of replacing old growth forestry species (Douglas fir) by an equal volume of younger growths yielding lower value timber (see Gary Robinson and G. Bowden, "Forest Resource Management Alternative Study," prepared by Robinson Consultancy & Associates as part of Fortrends Consultancy Inc. for British Columbia Forest Resource Commission, Victoria, B.C., March 1991). Also Peter A. Victor's adjustments of the economic accounts for the depletion of mineral resources (lead, zinc, silver and gold) in the Yukon Territory (see "Supplementary Economic Accounts for the Yukon Territory," report submitted to the Bureau of Statistics Executive Council Office and the Department of Economic Development, Yukon, by VHB Research and Consulting Inc., Toronto, Ontario, July 1990.)



sufficient future income. According to the Hotelling Rule, a scarce resource net price (i.e. net of extraction costs) should be rising at the market interest rate in order that the owner would be in equilibrium. Too high a market rate available for converting a user cost into future income would accelerate exploitation, and too low a rate would induce the owner to keep the natural resource in the ground since the Hotelling Rule would give him higher returns. I have advocated a 5% discount rate as a reasonable rule of thumb of a moderate level, fully realizing that the calculation of user cost would have an arbitrary element in its determination, and as Keynes [1936] perceived, would always inevitably involve "the whole pack of perplexities which attend the definition of income."<sup>9</sup>

Some of the advantages of this method are the following. First, we need not put a value on the stock: all we need is to ascertain the proportion of the stock that is being liquidated in the accounting period. Second, we should not count in income windfalls of new discoveries, or downward reassessments of reserves. Such changes in stock, whether positive or negative, will be reflected in the reserves-to-extraction ratio and do not require any special treatment. A third advantage is that the whole method is totally flexible from year to year, capable of being adjusted to accommodate a different extraction profile, a different interest rate, technical change or other changes in circumstances. Because of the importance of this latter point, I elaborate my argument in the next section.

### *The Exploitation Profile*

The method I have proposed for converting depletable resources into a non-depleting income stream has sometimes wrongly been viewed as constrained by an exploitation profile that relies on constant annual extraction. Such criticism is unwarranted. The accountant normally accounts for income or profits one year at a time. His function is to interpret entrepreneurial behavior that has already taken place, and such behavior may--in fact should be expected to--change from year to

---

<sup>9</sup> Keynes, J. M. [1936], *op. cit.* p. 67.

year depending on entrepreneurial judgments. Viewing a liquidation profile that indicates a 10-year horizon in the current year (reserves-to-extraction ratio = 10) does not imply that extraction would necessarily remain constant in the following years. In fact it would be unrealistic to expect an entrepreneur's extraction profile to remain unchanged for such a long time. The method is flexible and adaptable, though trying to make sense of it in a forward context, some critics have assumed that the summation of discounted future extractions depended on my assumption of equal extraction every year throughout the life of the asset. Such an assumption is not made and is totally unnecessary.

While I modeled my method on the accountant's approach to the problem in the manner the accountant usually accounts for inventory utilization, and dealt with depletion over discrete time, divided into accounting years, Hartwick [1991] using continuous time, was able to demonstrate that my user cost conformed to "economic depreciation in the general case of a variable profit (and extraction) profile, including the basic case of an optimal extraction (and profit or surplus) profile." For me, Hartwick's work has confirmed that my user cost conforms to the proper level of "depreciation" of a depletable resource, and that it yields such a level irrespective of the extraction profile.<sup>10</sup> However, I remain convinced that viewing the user cost as depreciation for the purposes of national income estimation implies a conceptual confusion which we should try to avoid.

### *Calculation of the User Cost*

The attached annex shows the user cost element as a ratio of the proceeds from depletable asset sales at selected life expectancies of the asset and three alternative levels of interest rates. As previously explained, the user cost is a capital

---

<sup>10</sup> Hartwick, J. M. [1991] "Economic Depreciation of Mineral Stocks and El Serafy's User Cost." (Mimeographed). See also Hartwick, J. M. and Hageman [1991] "Economic Depreciation of Mineral Stocks and the Contribution of El Serafy," Environment Department Divisional Working Paper No. 27, The World Bank, November 1991.

element in depletable resource proceeds that should be set aside and reinvested in order to maintain the asset owners' income. It is calculated according to my formula [El Serafy, 1981] on the assumption of zero extraction costs:

$$1 - \frac{X}{R} = \frac{1}{(1 + r)^{n+1}}$$

where X is true income; R receipts from sale (net of extraction costs); r the interest rate; and n the life expectancy of the resource at the current extraction rate.<sup>11</sup>

### *Conclusion*

In conclusion let me sum up as follows. While consensus is developing that natural resources should be regarded as capital (or in the accountant's language assets), and viewed by their owners as part of their wealth, there is no consensus yet on what kind of capital they should be treated as. Treating them in parallel with fixed capital has many pitfalls. This paper argues that it is wrong conceptually to include sales of assets in gross income, and then equally wrong to remove their contribution (equivalent to the entire value of asset decline) from the gross income in order to reckon net income. It is both faulty accounting and improper economics to confuse asset sales with income, albeit gross income, as if asset sales generated value added. And if our main objective is to reckon net income properly without regard to whether or not gross income is measured correctly, the proper quantity to use for making the adjustment is not the change in the resource stock during the accounting period, but that part which I have identified as a "user cost" which would indicate the correct level of "depreciation." I insist, however, that depletion

---

<sup>11</sup> El Serafy, S. [1981], *op. cit.* There I listed the assumptions on which this formulation was based, including the assumption that exploitation in period n does not yield income until period n + 1. If, however, exploitation and income are simultaneous, falling within the same year, the formula indicating the user cost becomes:

$$1 - \frac{X}{R} = \frac{1}{(1 + r)^n}$$

This latter formula appeared also in El Serafy, S. [1981].

of natural resources is very different from capital depreciation and requires a different treatment.

Finally, and as a summing-up, I would offer the following set of recommendations for the treatment of depletable resources in the national accounts.

- a) The asset end is not the best end from which to make the adjustment. It is not useful--neither is it necessary--to put a money value on environmental stock.
- b) Comprehensive measurements of environmental change should not be attempted. Adjustment should focus only on those few relevant resources that would make a difference to the economy concerned.
- c) Asset sales should not be mixed with income, whether gross or net. This is because asset sales do *not* generate value added.
- d) If asset sales are included in gross income, the correct adjustment for reckoning net income is *not* the change that has occurred in the value of the asset during the accounting period.
- e) Windfalls resulting from new discoveries should not be included in the flow accounts; nor should downward re-estimation of reserves be deducted from income.
- f) The adjustment needed to reach a correct level of *net* income is the quantity I have identified as a "user cost." Ideally this should be eliminated from gross income and no further correction will be necessary for reckoning net income.
- g) If, however, such asset sales are incorrectly included in gross income, the correct level of adjustment, or "depreciation," for the estimation of net income is the "user cost." This will capture both asset declines due to extraction, and any reassessment of reserves, upward as well as downward. Using up inventories, however, is not depreciation.
- h) Mixing asset sales with income implies a conceptual confusion. For the proper accounting of depletable resources the gross domestic product itself has to be adjusted.

**ANNEX****USER COST AS A PERCENTAGE OF SALE PROCEEDS**

(At Seven Levels of Life Expectancy and  
Three Alternative Interest Rates)

<i>Life Expectancy</i> (Years)	<i>User Cost</i> (Interest Rate)		
	<u>2%</u>	<u>5%</u>	<u>10%</u>
2	94	86	68
5	89	75	56
10	80	58	35
15	73	46	22
25	60	28	8
50	36	8	1
100	14	1	0

---

Source: El Serafy [1989]

# ACCOUNTING FOR THE CONTRIBUTION OF ENVIRONMENTS TO ECONOMIC MACROPROCESSES

GONZAGUE PILLET

PAUL SCHERRER INSTITUTE  
University of Fribourg  
ECOSYS LTD

ON BEHALF OF THE SWISS STATISTICAL OFFICE

## 1 THE MICRO AND THE MACRO DOMAIN

### *1.1 The Micro Domain*

Standard microeconomics consists in an approach to actors. This paradigm coincides with choices individual agents make and preference-related value which accompanies these choice-makings. The basic fact is that the market solves allocation tasks by providing information and incentives. Yet, it functions within the economic realm only. Environmental microeconomics, therefore, attempts to supplement market shortcomings using standard cost-benefit analysis (CBA), and situations involving irreversibility and uncertainty using extended CBA and related valuation techniques — see Table I.

Basically, efficient allocation is a policy *per se*: Prices serve efficiency in the micro domain just as income distribution serves equity in the macro domain. Whether the allocation problem is purely economic or a mix of market and nonmarket characteristics (it is the case in environmental microeconomics) only adds a complication to the problem and the way to deal with it. Basically once again, this is matter of micro analysis, be it environmentally oriented or not. Once an activity is identified, be it production of goods or use of environmental functions, then the optimal scale of a single activity is defined. Quoting Daly (1990): «A cost function and a benefit function for the activity in question are defined. Good reasons are given for believing that marginal costs increase and marginal benefits decline as the scale of the activity grows. The message of microeconomics is to expand the scale of the activity in question up to the point where marginal costs equal marginal benefits, a condition which defines the optimal scale [of the activity in question]. All of

microeconomics is an extended variation on this theme». Indeed, individual agents are involved in making choices among scarce means provided in the marketplace; environmental goods do not escape these choices once they are acquired by foregoing something else; here is the very foundation of the alternative usage of environments from the environmental microeconomic perspective.

**Table I**  
CBA VS MACROECONOMIC EVALUATION VS ECOLOGICAL MACROECONOMICS

	CBA	Macroeconomic Evaluation	Ecological Macroeconomics
Modelling of the economic regime	no	yes <sup>a</sup>	yes <sup>a</sup>
Welfare economic foundation	yes	no	partial <sup>b</sup>
Modelling of energy systems	no	partial	yes
Modelling of environmental characteristics	yes	no	yes <sup>c</sup>

<sup>a</sup> See Nentjes (1989).

<sup>b</sup> Welfare gains, opportunity costs level (the costs of the environmental project are conceived as opportunity costs).

<sup>c</sup> Cf. eMergy analysis overview of Switzerland, below.

After Nentjes (1989), *modified*.

However, a major exception is raised in so far as one wants to know whether or not the conservation strategy is superior to the development strategy in situations involving uncertainties. We have shown that this cannot be determined at the level of individual agents — using conventional marginal analysis and interpersonal welfare comparisons (Pillet *et al.*, 1990b). This is a question of macro-level decision making — regulation must be based on a unique decisional body.

Accordingly, the integration of a given environmental function into micro analysis raises the question of both the ecological information associated with the function and the relevant size of the economy. Indeed, considering how to account for the assimilative capacity of the environment needs special emphasis to be placed on the dynamics of the natural accumulation and absorption of pollutants, the feedbacks to the economy, and irreversibility and uncertainty associated with such environmental usages. These considerations show that we are no longer dealing with the optimal scale of a single activity, but with *the size of the larger part of human economy*. The analysis made can still be micro-oriented in its

foundation but it soon develops into macroeconomic aggregates like employment and activity levels (e.g., what does 'optimal pollution level' mean relative to the activity level of a nation?). In other words, the analysis goes beyond the micro allocation problem of opportunity costs when assessing conditions to control pollution under global environmental constraints or a sustainable ecological-economic policy framework. Yet, sustainability, like distributive justice and full employment can be a macroeconomic goal. If this is so, microeconomic tools are of no help at putting human economy in perspective with nature's work.

### *1.2 The Macro Domain*

The standard view on macroeconomics is that of the Gross National Product (Y), as being made up of consumers expenditure (C), gross private domestic investment (I), and governmental purchases (G) — then  $Y = C + I + G$ .

GNP is a measure of the economic activity conducted through organized markets. It is the sum total of the money value of all final goods and services produced during one year and sold on organized markets (National Income corresponds to GNP minus depreciation and indirect taxes).

Bads (which involve final consumption costs) get counted in GNP along with goods and are not netted out. Ecological damage is not netted out from GNP either (market-related activities only get counted). To some extent, this can be corrected by means of satellite accounting systems. A first aim of satellite accounting schemes is to allow environmentally-oriented market expenditures to get counted appropriately (as an aggregate) in GNP. There are ways and means for doing this.

*Yet, organized markets are themselves only part of a larger system as are money values of all final goods and services, including marketed environmental goods. The aggregate economy is part of a larger system, the natural ecosystem. In addition, when we pay for environmental regulation (environmentally-oriented expenditure), what are we really paying for? Indeed, some environmental expenditure is made for the use of the environment — e.g., for its limited capacity at assimilating waste flows — although we do not know for sure the worth of this contribution. We do not know either how to account for the work of ecosystems in sustaining national economic activity. This is the number one question addressed in this paper; that is, we would like to go beyond the scope of standard schemes devoted at netting out environmental expenditures to explore the still controversial question of macro-'pricing' the contribution of the environment to macroeconomic processes.*



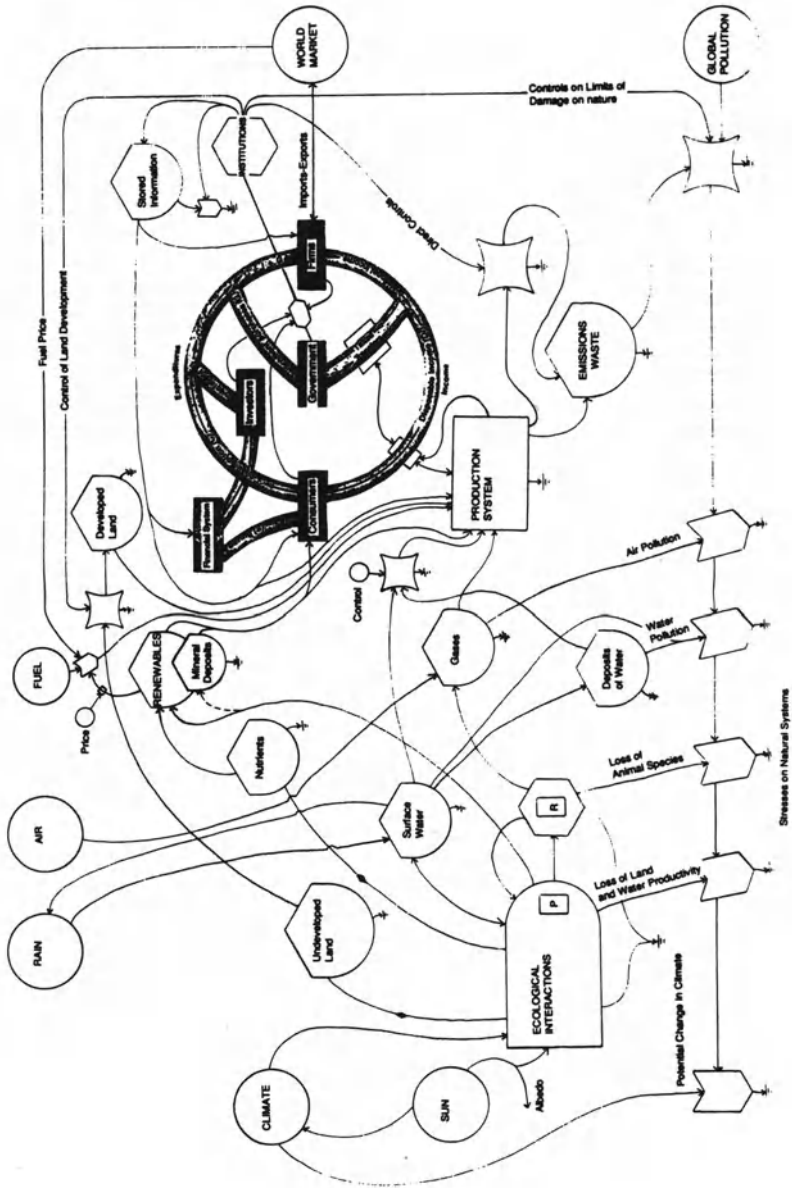

**FIGURE 1: JOINT OVERVIEW OF THE MACROECONOMY AND THE ENVIRONMENT**  
Circular Flow of Expenditure and Income after Baumol & Blinder (1982)

This task consists in looking for a metric we could apply to these contributions at an aggregated environmental-economic level. On the evidence, the value of these contributions over time comes closer to the value of the bridged system than to preference-related micro-values.

Getting back to modern standard macroeconomics, the latter is viewed as a circular flow of expenditure and income — although it is a regulatory system. This can be represented by the large «wheel» which appears on Figure 1. Now, the scale of the wheel is determined by the money value flowing in organized markets only — to the extent that the macroeconomy is seen as a system artificially isolated from exchanges of matter and energy with its environment.

In man-made real world industrial systems, the macroeconomy is to be viewed as an open *subsystem* of the ecosystem with physical exchanges crossing the boundaries between the subsystem and the parent system and constraining the former with respect to both inputs of low-entropy matter-energy and outputs of high-entropy matter-energy (see Figure 1). These environmental-economic exchanges constitute the subject matter of ecological macroeconomics.

## 2 MATERIAL-ENERGY BALANCES AND THE SCALE OF MACROECONOMIES

Figure 1 has been drawn using Odum's energy language (Odum, 1983) to help grasp environmental-economic exchanges which constitute the foundation of ecological macroeconomics. These flows, it is suggested, must be considered in terms of their scale or total volume relative to the ecosystem and the economy, and not in terms of the (micro-) pricing and allocation of each part of the total flow within the human economy (Daly, 1990). In addition, macroeconomics are not concerned with indigenous environmental flows only but with the scale of the physical exchanges crossing national boundaries, too.

Now, in order to illustrate how environments interact with economies, we place emphasis in this section first on the comparison between two static views of Switzerland: «Wild» and «1990» Switzerland, using gauges from ecology. Then, we introduce a formal model aimed at keeping track of environmental and economic international trade. In the next section, we introduce the analysis of resources that appear as nonpriced inputs of natural environments in economic macro-processes. The last section is devoted to some concluding remarks.

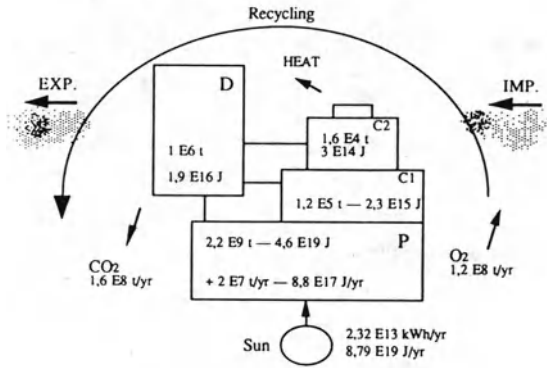

**FIGURE 2: "WILD" SWITZERLAND**  
After Greppin, in Pillet *et al.* (1990b)

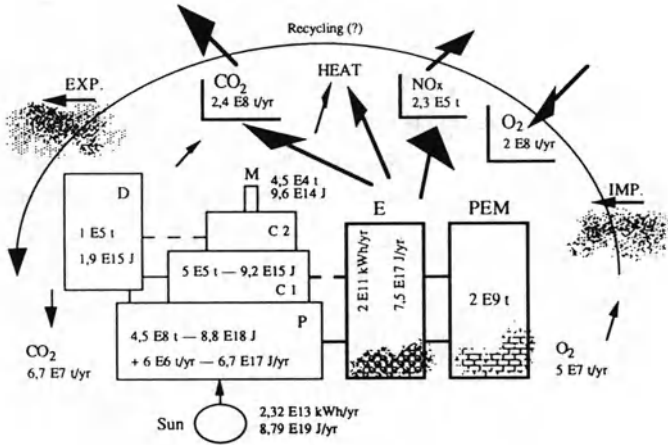

**FIGURE 3: "1990" SWITZERLAND**  
After Greppin, in Pillet *et al.* (1990b)

### 2.1 «Wild» Vs «1990» Switzerland

These case-studies are intended to give an overview of the characteristics of the Swiss ecosystem in the absence of human beings, on the one hand, and with their presence in 1990, on the other. We are interested in the comparison between these two states of the Swiss environment; that is, in the calibration of the transformation of the latter due to economic development.

*«Wild» Switzerland.* Figure 2 shows the possible state of the environment in Switzerland at its past climax; that is, at its maximum growth and diversity stage. This picture is to be viewed as some initial picture of the country, and not as an idealized state of the 'Swiss' environment. The diagram depicts the volume of primary producers (**P**), consumers 1 and 2 (**C1**, **C2**), and soil living organisms (**D**).

At each step of this ecological hierarchy, biomass have been estimated in tons (dry weight) and joules when stocks. For flows, annual turnover rates have been added. Finally, net O<sub>2</sub> production and CO<sub>2</sub> fixation have been estimated according to the scale of ecosystem work.

*«1990» Switzerland.* Figure 3 shows figures of the current environmental economic system of Switzerland. On the one hand, the natural environment is decreased by a factor of ten, especially with respect to soil living organisms. Since domestic animals have been substituted for wild animals, and planted areas for natural ones, **C1** and **C2** have decreased less in aggregate terms. The biomass of humans is relatively small.

Yet, economy participates in the game by means of the energy use (**E**) and the 'permanent economic mass' (**PEM**) — which is more or less the man-made capital a society builds over time (see also Sagoroff, 1970). In addition Switzerland is now a net O<sub>2</sub> consumer and net producer of CO<sub>2</sub> and other air and water pollutants.

*Implications.* These analyses raise the following question: How far can we go in reducing the natural capital — and consequently locally available environmental functions — of a human economy? How much do local environments contribute to the latter?

Diversity, complexity and the carrying capacities of the environment in assimilating waste and providing useful functions to humans has drastically shrunk in Switzerland (per capita natural biomass has been estimated to be 50 tons in the Geneva region, 400 tons in Switzerland, and 5000 tons worldwide — Greppin, 1990). According to this figure and to the fact that humans manipulate much more energy than they exchange with their life-support system (mainly non-renewable resources), developed economies are nearly reaching

the saturation point of nature. «As long as the human economy was infinitesimal relative to the natural world, then sources and sinks could be considered infinite, and therefore not scarce, and if not scarce then safely abstracted from by economics» (Daly, 1990). As a consequence, scale and sustainability of human economies are no longer strange questions (Pillet, 1990b).

A useful index of the scale of human economy relative to the environment is the percentage of human appropriation of the net product of photosynthesis. The amount of solar energy captured in photosynthesis by primary producers less the energy used in their own growth and reproduction is the net primary production (NPP). The basic food resource for everything on earth not capable of photosynthesis is thus NPP. Vitousek *et al.* (1986) calculated that 25% of potential global (terrestrial and aquatic) NPP is now appropriated by human beings. If only terrestrial NPP is considered the fraction rises to 40%. According to this, appropriation of terrestrial NPP allows only a bit over one doubling time of the human scale in the future (cf. Daly, 1990). Now, what can be said about international trade and the environment?

## *2.2 International Trade*

One other question environmental macroeconomics raises is: To which extent do imports/exports affect the size of human economy relative to available environments and in particular with respect to 'home' environments?

We shall show in the next section that Switzerland currently drains more solar embodied energy from other countries through foreign trade than it exports. Indeed, macroeconomics are not only concerned with indigenous environmental flows but with the scale of the physical exchanges crossing national boundaries. Moreover, countries cannot be altogether net importers of environments. In short, just as resources from one place can be consumed elsewhere, waste and emissions from one country can be discharged into or affect other environments. Figure 4 is intended to tackle this problem.

On Figure 4 the boundaries of the parent system are shown as planetary constraints expressed as biological and environmental limits of viability (e.g. from absolute temperature to Net Primary Production). Countries are viewed as compartments with an attached society structure. Thus to compartment 1 and society structure 1 corresponds a given country or set of countries. To compartment 2 and society structure 2 corresponds another country or set of countries, and so on.

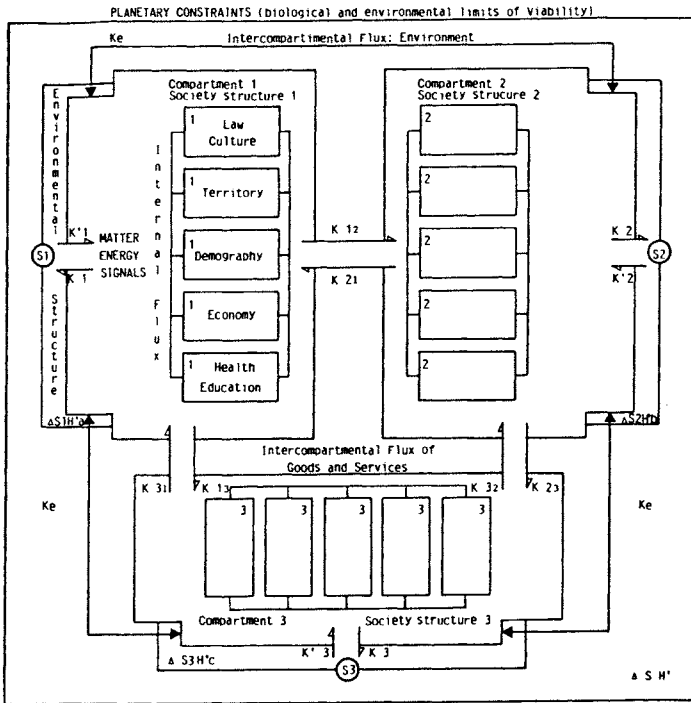

FIGURE 4: INTERCOMPARTMENTAL TRADE OF ENVIRONMENTAL GOODS  
H. Greppin, com. pers.

Each compartment has physical flows of matter/energy crossing its environmental-economic boundary. This is expressed by  $K_1$  for inputs of low-entropy matter-energy (available energy) and by  $K_1$  for outputs of high-entropy matter-energy (energy no longer available for the system).

The same is true for  $K_2$  and  $K_2$ , and for  $K_3$  and  $K_3$ .

The measure of the scale of compartment 1 relative to its environment is  $s_1$ , of compartment 2,  $s_2$ , and so on,  $s$  being the entropy of the system. Foreign trade of goods and services through organized markets is accounted for as  $K_{12}$  (exports to compartment 2 from compartment 1) and  $K_{21}$  (imports to compartment 1 from compartment 2), and so on. Yet the key fact of this intercompartmental representation of general trade between nations or groups of nations is  $K_e$ : the intercompartmental flows of environments which are considered to modify the entropy ( $\Delta s_1$ , and so on), the diversity index ( $H'$ , etc.) of each subsystem relative to its environment. Finally, an entropy and diversity index of the whole system (parent plus subsystems) is supposed to be measured by  $\Delta s H'$ .

### 3 MACRO-PRICING RESOURCES THAT APPEAR AS NONPRICED INPUTS INTO ENVIRONMENTAL-ECONOMIC MACROPROCESSES

The role of environmental resources in specific economic activities is little appreciated or even understood. Consequently, we do not know how much environments contribute to economic production processes in the same way that we know this for goods and services provided on the marketplace. Therefore, assuming that a non-negligible part of the energy resources which contribute to the economic output are not acknowledged by the price mechanism — and that consequently a misuse of these resources occurs due to the absence of any economically-oriented signal — the approach given here deals with the following question: How does the environment contribute to the production of a given economic good or service, and what is the contribution relative to those valued by the marketplace?

Let us mention that many economists guess that proportion to be no more than 2.5%. However, nobody ever made an effort to assess this result. As a matter of fact the economy is seen as an isolated system in which exchange value circulates between firms and households in a closed loop. There is no explicit recognition of the exchanges of matter or energy and the support of ecosystems sustaining economies. Nor is there a tool from an economic perspective to investigate these exchanges and the way ecosystems sustain economies.

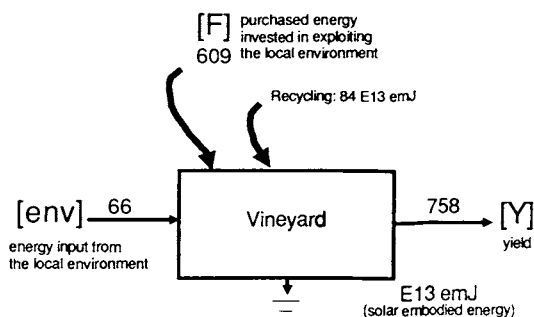

**FIGURE 5: ROLES OF NATURAL ENDOWMENTS INTO PRODUCTION PROCESSES.**  
 The roles of the natural endowments into production processes are evaluated at the interface between the economy and the environment by means of two mutually necessary parts: the environment-driven inputs  $[env]$  and the market-driven inputs  $[F]$ . Ratios and indices are inferred from such an energy diagram. Pillet (1991)

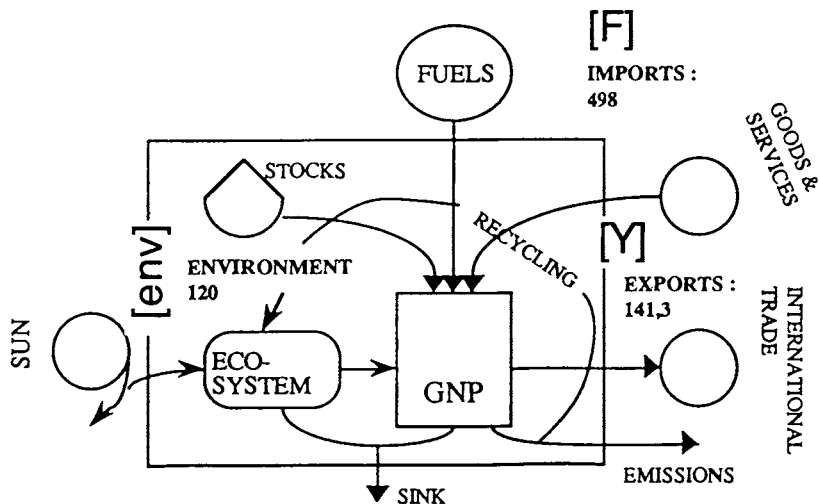

**FIGURE 6: AGGREGATED VIEW OF SWITZERLAND**  
 Pillet and Odum (1984)



### 3.1 The Method

Ecological-economic valuation procedures are mainly based on embodied-energy theories, or eco-energetic analyses. Among these is the *emergy method*, namely Howard T. Odum's conceptualization of embodied energy theory (see Odum, 1983, 1984, 1986; Pillet & Odum, 1984, 1987; Pillet, 1986a, 1986b, 1987, 1989, 1990a, 1991; Pillet & Baranzini, 1988a, 1988b). The *emergy method* aims at aggregating energy and building an energy-quality hierarchy for analyzing ecosystems and environmental-economic bridged systems. A special case exists in shadow-pricing environmental goods and services which appear as energy externalities to economic subsystems (see Pillet, 1986a,b, 1991). In this section, we clarify the *emergy* accounting of these external, non-priced contributions to economic processes.

*Prerequisites.* The analytical idea behind the *emergy method* is that, at each step of an energy-chain, much of the energy is used in the transformation, but only a small amount is converted into a higher quality of energy—that is, into a more concentrated form which is capable of catalytic action when fed back. Then, the ratio of one form of energy that is required to generate another form of energy by a transformation, is a measure of efficiency according to the First and Second Laws of Thermodynamics, under the Maximum Power principle (or, maximum energy-flux per unit of time according to the Lotka-Odum autocatalytic characterization of living as well as man-made non-living processes). In other words, this ratio is a measure of energy quality in real systems when the latter tend to operate at that efficiency which produces a Maximum Power output. This ratio of one (source) form of energy required to develop another (high-quality) form of energy by a transformation has been called *transformity* (symbol: Tr). The term 'transformity' thus names a ratio describing the quality of a form of energy and its measurable ability to amplify as feedback relative to the source-energy consumed in its formation, and under the Maximum Power principle.

Embodied energy (now, *emergy*; symbol: C) is defined by Howard T. Odum as a way to measure the cumulative action of energies in chains or webs (Odum, 1983). It is the source-energy required to produce a form of energy. As a result, if different-form energies are to be compared with respect to the energies required in their formation (or their effect), they may be converted into the same source-*emergy* (that is, into equivalents of the same form) by multiplying their actual energy content by their (source) transformity.

If the joule is the current unit for actual transformation work, it is not qualified for dimensioning *emergy*, the unit of which is the source equivalent joule. This new unit has

been called *emjoule* (symbol: emJ).

Thus, the analysis of ecological-economic subsystems requires that every energy-form participating in the product be first evaluated in actual joules, and then converted into emergy (emJ) by means of the appropriate (*in situ*) transformity.

Finally, a special ratio is used in ecological-economic systems which characterizes the period-to-period relationships between the emergy used by a country and its GNP. This emergy/\$ ratio has been called *monergy*. It is used for calculating macro-prices as well as for calibrating human services by means of emergy units. It is defined by the global emergy used within the country (in emJ) divided by the GNP of the country (in \$); it is thus expressed as an emJ/\$ ratio.

*Accounting for Unpaid Prices.* Macro-prices (symbol:  $P$ ) for environmental goods (symbol: *env*; otherwise called energy externalities) can be taken into account, using the concepts of the emergy method given above.

Based on Odum (1983; cf. also Lavine & Butler, 1982), our general hypothesis is that the macro-price of environmental goods, per surface unit and period of time, is in proportion to the GNP in this period, as is the emergy of these goods per surface unit and period of time in proportion to the global emergy used by the country within the same period.

This gives us:

$$P_{env} \cdot \text{ha}^{-1} \cdot \text{yr}^{-1} = C_{env} \cdot \text{ha}^{-1} \cdot \text{yr}^{-1} \times \$\text{GNP} \cdot \text{C}^{-1}$$

for  $\$\text{GNP} \cdot \text{C}^{-1} = \$/\text{emJ}$  ratio, or the reverse ratio of the monergy of the country.

In other words, the macro-price of environmental goods per hectare per year is obtained by dividing their emergy by the monergy of the country. Note that if the output is more than 10% of the GNP, we use a corrected monergy.

This model of emergy calculation may be used to calibrate human labour within environmental-economic subsystems with necessary modifications. In this respect, the emergy of human labour is obtained by multiplying wages by the monergy of the country (or of a subsystem).

These calculations should apply to any emergy analysis of ecologic-economic systems, including the macro-pricing of energy externalities within economic subsystems. Such macro-prices should be considered as indicators of ecosystems' work in economic

calculations.

### *3.2 Case-study of the Role of Environment in Geneva Vineyard Cultivation and Wine Production, 1972-1986*

We use here the study of Pillet *et al.* (1990a) to pursue a more complete assessment of a former analysis of the role of the working of natural processes in vineyards and wine production (Pillet, 1986a). The objective of the former analysis was to calibrate the role of the environment reflected through its input of natural energy in vineyard cultivation and wine production, and to derive a macro-price for this indirect, environmental contribution for some fictitious vineyard cultivation and wine production located anywhere in the lake of Geneva region. The latter analysis is more ambitious. First data used have been collected specifically for the study from *Canton de Genève* vineyard cultivation and official wine production statistics. Second, the study empirically covers a series of 15 years, from 1972 to 1986. In addition, the aim was to know what was going on with such a multiperiod analysis with respect to the effectiveness of the emergy method.

We used field data from vineyards and wineries in the canton of Geneva, situated in the Western, French-speaking part of Switzerland. Geneva's vineyards total around 1,300 hectares, and constitute 9% of all Swiss vineyards. The production of must (unfermented wine) is about 9% of all the must produced in the country. Data are mainly from cantonal and federal agencies (*see* Table II). The transformity ratios mainly are from Odum & Odum (1983).

A spreadsheet to be run on PCs as an aid to computation has been developed. This computer program calculates yearly summaries of flows, monergies (i.e., solar embodied joules per dollar ratios) to be used for calibrating capital and human services, and useful basic ratios and indices. The outcome of the study is presented in 15 inventory diagrams, tables of flows, aggregated views of vineyard cultivation and of wine production, and sets of ratios, from which we develop our interpretation. They can be found in Pillet *et al.* (1990).

*Results and interpretation.* The energy that was directly derived from the local environment (*energy externality*) to produce **grapes** ranges from 18% in 1986 to 39% in 1974, and the energy that was derived from the environment to produce **wine** ranges from 13.3% in 1986 to 29.4% in 1974. 1974 is a low yield year (minimum yield: 1978). In 1986, yield was still high albeit down from 1982 (highest yield). From 1978 to 1982, *organic matter* inputs doubled. *Total emergy* was very low in 1974-75; it was much higher from 1984 to 1986. On the contrary, *direct fuels* were high before 1980 (oil: 4 [I] per hectare; must yield: 90 [I] per hectare) and less after 1980 (oil: 3 [I]; must yield: 120 [I]). *N, P, K, and pesticides* have also

been declining since 1980. Finally, what has been much higher especially since 1983 are *services and capital* both on the vineyard and in the winery.

The *net useful economic contribution ratio*  $[Y/F]$  — for derivation see Fig. 5 — was at a minimum in 1986 with 1.21, and at a maximum in 1974 (1.64). The higher the energy derived from the environment—or, the smaller the contribution from the marketplace—the higher the ratio. *Ceteris paribus*, this could mean that what is not directly contributed by the local environment is compensated via inputs from the marketplace. In reality, capital and services went up while fertilizers and pesticides went down after 1980. Altogether, the trend is thus towards worse net useful economic contribution ratios. In other words, capital and services (including the free natural energies sustaining them) supplement the environment more than before. And this is not compensated, on the environmental side, by the recycling of bines (the flexible stem of grapevines) which has been assumed constant over the 15 years because of lack of practice and data. However, recycling could be the way to follow if one wants to get better economic yield ratios.

The *emergy investment ratio* computes the degree of intensity of market-driven energy forms relative to the use of direct environmental energy inputs  $[F/env]$ . It is another indicator aimed at grasping the relationships between energy inputs bought on the marketplace and those derived from the local environment. This ratio was at a minimum in 1974, and at a maximum in 1986.

The cost of generating wine production can be expressed as  $[env/F]$ , which can be thought of as an *emergy* measure of efficient use of the environment.

Finally, the roles of the natural endowments into the production processes are evaluated at the interface between the economy and the environment by means of two mutually necessary parts: the environment-driven inputs, on the one side (17% in must processing and 13% in wine production in 1986), and the market-driven inputs, on the other (83% and 87%, respectively). Over the full period, environmental values range between 9 and 14 % for wine production, and the reciprocal for market-driven inputs (still for wine production).

To sum up, a measure of only the market-driven quantities of energy spent in agricultural work would undervalue the assessment of the final environmental effect of the economic activity in question.

Any economic activity *alters* the environment because it is a part of this environment.

**Table II**  
ENERGY AND EMERGY IN GENEVA VINEYARD CULTIVATION AND WINE PRODUCTION — 1986

#	Energy Form	Units	Data	Actual J/ha/yr	Quality emJ/J	Embodied J E13 emJ
1	Direct Sun	J/m <sup>2</sup> /yr	3.44 E9 . . .	3.44 E13 . . . . .	1.00 . . . . .	3.4
2	Rain	m <sup>3</sup> /m <sup>2</sup> /yr	8.89 E-1 . . .	4.36 E10 . . . . .	1.50 E4 . . . . .	65.3
3	Soil Used up	kg/ha	7.00 . . . . .	1.58 E8 . . . . .	6.24 E4 . . . . .	1.0
4	Organic Matter	kg/ha/yr	7.13 E2 . . .	3.22 E9 . . . . .	6.24 E4 . . . . .	20.1
5	Recycled Bines	kg/ha	1.50 E3 . . .	1.02 E10 . . . . .	6.24 E4 . . . . .	63.5
6	Nitrogen (N)	kg/ha/yr	66.0 . . . . .	1.43 E8 . . . . .	1.69 E6 . . . . .	24.2
7	Potassium (K)	kg/ha/yr	1.32 E2 . . .	9.27 E7 . . . . .	2.62 E6 . . . . .	24.3
8	Phosphate (P)	kg/ha/yr	67.0 . . . . .	1.07 E7 . . . . .	4.14 E7 . . . . .	44.4
9	Magnesium	kg/ha/yr	30.0 . . . . .	3.78 E7 . . . . .	2.00 E5 . . . . .	0.8
10	Pesticide	kg/ha/yr	53.0 . . . . .	8.05 E8 . . . . .	6.60 E4 . . . . .	5.3
11	Direct fuels	l/ha/yr	3.97 E2 . . .	1.27 E10 . . . . .	6.60 E4 . . . . .	83.9
12	Machines & wires	kg/ha/yr	4.38 E2 . . .	3.96 E7 . . . . .	1.01 E7 . . . . .	40.0
13	Services & capital	fr/ha/yr	1.61 E4 . . .	— . . . . .	— . . . . .	385.3
14	<i>Must yield</i>	hl/ha/yr	86.8 . . . . .	2.94 E10 . . . . .	2.58 E5 . . . . .	758.1
15	Sugar added	kg/hl/yr	1.5 . . . . .	2.19 E9 . . . . .	8.39 E4 . . . . .	18.4
16	Energy in winery	kWh/hl	8.5 . . . . .	2.66 E9 . . . . .	1.59 E5 . . . . .	42.4
17	Materials	kg/hl	0.8 . . . . .	6.28 E3 . . . . .	1.01 E7 . . . . .	> 0
18	Cellulose filters	kg/hl	0.3 . . . . .	3.24 E8 . . . . .	1.57 E5 . . . . .	5.1
19	Water	hl/hl must	2.0 . . . . .	8.51 E7 . . . . .	1.50 E5 . . . . .	1.3
20	Services	fr/ha/yr	1.02 E3 . . .	— . . . . .	— . . . . .	24.6
21	Capital	fr/ha/yr	5.10 E3 . . .	— . . . . .	— . . . . .	123.5
22	<i>Wine yield</i>	hl/ha/yr	86.8 . . . . .	2.38 E10 . . . . .	4.09 E5 . . . . .	973.1

Source : Pillet *et al.*, 1990

[F] represents the imported power invested in the environment and spent to grow grapes within the system; [env] represents the energy input from the *local environment*. In the year 1986, [env] accounted for 11% of the imported *power* (consisting of capital and economic goods and services, including free natural energies sustaining them) invested for must and 8% for wine production. In 1972, these ratios were 29% and 18%, respectively. This suggests a declining role of the local environment in generating the final output — which is consistent with the observation that the growing of grapes in Geneva has become increasingly industrialized. Basically, this also means that, as the natural environment is degraded, more fossil fuels must be used to compensate for this. This is valid under the assumption that transformities (the quality factors in table I) really match and measure efficiency and maximum power of such an energy system. Yet, it proves helpful and important to know how much the necessary energy derived from the environment is worth from within the present economic framework.

### *3.3 Energy Analysis Overview of Switzerland*

#### *Objectives*

Although market transactions may allocate priced resources among production activities, the services of nonpriced environmental resources go unnoticed in any general economy. Thus, the important question is: What are the respective contributions of environment-oriented inputs vs market-driven inputs to gross national product? What is the energy throughput of the Swiss economy? The answer to this question can be determined by analyzing ecological processes and economic inputs as two mutually necessary components to the general production process. Such a result cannot be obtained through economic analysis in as far as the work of ecosystems is blind to the willingness to pay of individuals. Therefore, one cannot put any cash value on environmental inputs. The question still is: How much are environmental inputs vs. priced resources worth to the economic world? One way that this task may be carried out is by using the eMergy method, or solar embodied-energy analysis overview. We use this method in this section to evaluate the contribution of the natural environment to the Swiss economy besides that of marketed and imported energy inputs. We clarify this with respect to evaluating the contribution of the environment to the economy, both for Switzerland alone, and for Switzerland as a trading partner on the international scene.

#### *Energy Externalities*

The vitality of a national economy does not deal with only the productive work of people

(labor) and machines. It also depends on the productive work and carrying capacity of the natural processes of the environment (see Figure 1). Therefore, production includes some work of natural processes from outside our present system of economic accounting and that is in addition to inputs (capital and labor—and fuels) from inside the economy. Indeed, the productive contributions of the environmental endowments to the economy are indirect and not adequately recognized. They are external to the economy. As their flows can be calculated in energy units like any other flows, including economic goods and services, these contributions have been called energy externalities (Pillet and Odum, 1984, Pillet, 1986a,b). For example, stocks of good soils, forests, minerals, water resources, and favorable climates may contribute to the reduction of the human costs of living and the economic operations that would be required if environmental services were less. We don't know if all flows of nature contribute equally, per joule—or emjoule—, to the economy. Even their energy efficiency as usually measured in *exergy* terms for fuel or electricity used in production process has never been done in this respect. Therefore, when one wishes to evaluate the energy externalities of an economic process, it is necessary to stipulate that the result will be a calibration of all energy flows from nature to the economy according to the hypotheses that all flows both from nature and from the economy can be measured on the same solar energy basis and that consequently their contribution is estimated in proportion to their emergy content only.

### *Results*

**Emergy Stocks & Flows.** In order to achieve a national energy analysis of Switzerland we first calculated the flows and stocks of nature and of economy. Then, we evaluated this nation's main inputs, products and stocks in emergy units, and have drawn an energy diagram (Figure 6). The main energy stocks within a country include natural materials such as stocks of soils, minerals, forests, glaciers, lakes and groundwater. Only items with turnover times longer than one year are included and evaluated in emergy in a table of stocks (stocks used up faster than replaced on an annual basis are counted as flows). Energy flows include external inputs, such as environmental inputs of rain, rivers, geological inputs, etc., as well as economic inputs such as labor, investments, foreign trade, etc. Those sources are calculated in actual energy units, then converted to emergy units and included in a table of flows together with the flows of those stocks used up faster than replaced on an annual basis.

The aggregate view of Switzerland in Figure 6 summarizes those flows where the environment [*env*] interfaces with the economy [F and Y]. The nation's embodied energy

stocks and flows are a measure of the real standard of living that can be considered a parallel accounting to GNP. However, unlike GNP, this measure takes into account inputs of natural energy; that is, energy externalities that are indirect and unpaid contributions from the environment to the economy.

The resource flow [*env*] in Figure 6 is the use that comes from natural processes and hence is free, although it contributes to economic production. It corresponds to 16% of the total emergy use within the national economy. In comparison, this ratio is 1% in Western Germany, and 27% in the United States. This is an index of self reliance on an emergy basis. The lower the percentage, the more the economy depends on imported energy flows. A decreasing proportion might mean that more fossil-fuel based economic operations are required to maintain the standard of living at its current level, which is the case when environmental endowments are deteriorating (less useful work can be done), or population grows. This could also be a useful index for the follow-up of environmental policies aimed at reducing  $CO_2$  emissions to a very large extent.

**Table III**  
EMERGY, GNP, AND ENERGY — DATA FROM VARIOUS STUDIES

Country	Monergy* 1E12 emJ/\$	Emergy Use per capita* 1E16 emJ/year	GNP 1E9 \$ <sup>b</sup>	Primary Energy Consumption Mtoe <sup>c</sup>	Energy Intensity GJ/\$1,000 <sup>d</sup>	CO <sub>2</sub> 1E6 t carbon 1990
Dominica	8.7	0.8	75			
Australia	12.1	7.6	90			
Brazil	6.9	1.6	216			
USSR	3.4	1.5	1300	1449	42.11	1,020
USA	2.4	2.9	2380	1932	32.06	1,460
FRG	2.5	2.8	715	279	.....	
Spain	1.6	0.6	134	76	.....	
Switzerland	0.7	1.2	102	23	23.58	920

\* Odum and Odum (1983); Pillet and Odum (1984)

<sup>b</sup> 1979, US\$

<sup>c</sup> Total Primary Energy / Mtoe = million t oil equiv. = 41.87E14 J

<sup>d</sup> 1983, US\$

Switzerland (1990 - estimated): 12.3 E6 t of carbon, or 2 t C per person (USA: 5 t C per person).

Sustainable Development. If the economy were hypothetically running only on its own renewable sources (part of [*env*] in Figure 6), Switzerland could support only 14% of the population, or 900,000 people, at its 1983 standard of living (the same percentage is true for



the USA, but the ratio decreases to 1.1% for West Germany), and 19% if we consider both indigenous renewable and nonrenewable resources [env]; that is, 1.2 million people. If Switzerland develops this carrying capacity in order to support 6 million people (which is its actual population) in the nineties, at present standards and structure of the economy though without the use of the imports, it would have to expand its own renewable resources eightfold. Nevertheless, the Swiss economy is a relatively energy-efficient one: every Swiss inhabitant uses  $1.15E16$  emJ per year (1983) in contrast with 2.8 in West Germany — maybe because all fossil - fuels are imported ones —, and 2.9 in the USA, and emits 7 t of  $CO_2$  per year compared with 12 for West Germany and 20 in the USA (annual emissions, 1990).

**Monergy of Switzerland.** We calculated the monergy of Switzerland (its emergy/dollar ratio) in the early eighties based on the chemical potential energy of rain, nonrenewable indigenous resources, hydroelectricity used within the country, imported fuels, minerals, goods and services, over the Gross National Product. The Swiss monergy in 1983 was  $0.72E12$  emJ/\$, less than that of other countries (see Table III).

The monergy column in Table III suggests that people in rural countries use more services from the environment directly, without money payments, than the people in urban countries, or that poor people cannot afford oil. Rural countries have higher emergy per dollar because the work of natural processes contributes proportionally more energy externalities. A consequence may be that those with money seek to use the dollar-free environmental functions of the less developed regions — à tort ou à raison — for making money by buying more emergy with a potential for doing more work than it does at home — this concerns renewables, but also waste disposal. In other words, a rural country is subsidizing urban countries when supplying them with raw products or waste disposal at market prices. In this respect, the Swiss economy benefits from a favourable overall trade ratio when calculated on an emergy basis: in 1983, imports were 3.5 times exports. Last, any large cut back of the environmental flows in rural countries would turn out uneconomic both for rural and urban countries.

#### 4 CONCLUDING REMARKS

Switzerland is dependent on nonrenewable as well as renewable imported emergy (two times more than the USA, but thirteen times less than West Germany), but it sends about 3.5 times less emergy out of the country than it imports. According to this analysis, if the economy were hypothetically running only on its own renewable sources (with no further

development), Switzerland would be able to support only 1 million people at the present cost of living and economic operations. If the objective were a more equitable trade with rural countries while running at the current standard of living—that is, if the objective were to return to those countries the energy difference (imports minus exports) in some form (information, education, foreign aid, etc.)—Switzerland would have to exploit much more of its own environment than at present to compensate for this. If the objective were to cut the emissions of pollutants to a large extent—in particular  $CO_2$  and other greenhouse gases—Switzerland would have to exploit more of its own environment, too. Indeed, Switzerland is currently 'importing' environmental functions, directly or indirectly, from other, less developed countries.

According to this analysis, making local and short-term goals consistent with global and long-term goals calls for the development of an ecological macroeconomics in addition to environmental economics which is largely based on applied microeconomics. Ecological macroeconomics would consist in bringing forth macroeconomic considerations on environmental issues—such as the calibration of macro-prices for nonmarket goods and services—to accompany standard analyses, allowing environmental goods and services (as flows) and environmental capital (as a stock) to get counted in decision-making processes. An energy macroeconomics already exists, but says nothing about natural environments.

New management tools and environmental-economic criteria are needed in the macro-domain to tackle problems such as the reduction of  $CO_2$  emissions, and other, related environmental-macroeconomic issues. For example, macroeconomic assessments would be useful for a carbon tax. We know that, at the international level, a uniform carbon tax could prove uneconomic. Yet, in order to compute differentiated taxes, environmental endowments of different countries must get counted along with their commercial energies.

Finally, environmental-economic rating criteria are to be developed both in the micro (single firms, micro allocation, micro-prices) and in the macro domain (national and international levels, scale of human economy, macro-prices). Indices based on commercial energy production and consumption contain little information on the essential, environmental—though dependent on human decision—beginning and ending points of the material-energy chain. The beginning points are the mineral deposits and the energy sources (to be exploited). The ending points are the emissions into the environment—see Figure 1. An ecological macroeconomics would be devoted to the analysis of the optimal size of that macro-chain, allowing new facts and figures to be incorporated into national accounting frameworks.

## 5 SYMBOLS

Symbols used in the paper are from Odum's energy language diagrams (Odum, 1983):

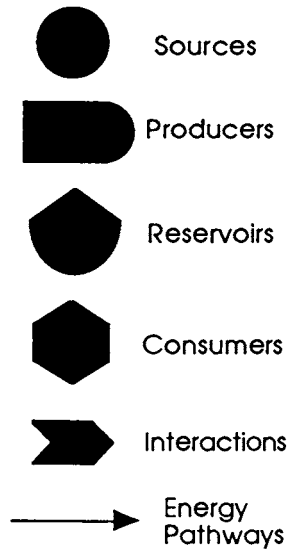

## 6 REFERENCES

- Baumol, W.J., and A.S. Blinder (1982), *Economics — Principles and Policy*. Harcourt Brace Jovanovich, New York - San Diego - Chicago - San Francisco - Atlanta - London - Sydney - Toronto, 836 pp.
- Daly, H. E. (1990), Towards an environmental macroeconomics. Paper presented at the International, Interdisciplinary Conference: *The Ecological Economics of Sustainability*. The World Bank, Washington, D.C., 21-23 May 1990, 25 pp.
- Greppin, H. (1990), La nouvelle donne écologique. *Campus*, University of Geneva, pp. 14-15.
- Kypreos, S. (1990), *Energy Scenarios for Switzerland and Emission Control, Estimated with a Normative Model*. Paul Scherrer Institute, Report No. 70, June 1990, 98 pp.
- Lavine, M.J., and T.J. Butler (1982), *Use of Embodied Energy Values to Price Environmental Factors: Examining the Embodied Energy/Dollar Relationship*. Report, Center for Environmental Research and Department of Environmental Engineering, Cornell University, Ithaca, NY, 25 pp. + Appendices.

- Nentjes, A. (1990), Macroeconomic cost-benefit analysis of environmental programmes. In: Folmer and van Ierland (Eds), *Valuation Methods and Policy Making in Environmental Economics*. Elsevier (Studies in Environmental Sciences, 36), Amsterdam, pp. 187-216.
- Odum, H. T. (1983), *Systems Ecology — An Introduction*. Wiley, New York - Chichester - Brisbane - Toronto - Singapore, 644 pp.
- Odum, H. T. and E. C. Odum (1983), *Energy Analysis Overview of Nations*. IIASA Working Paper, Laxenburg (Austria), 469 pp.
- Pillet, G. (1986a), Case-study of the role of environment as an energy externality in Geneva vineyard cultivation and wine production. *Environmental Conservation*, **14** (1), pp. 53-58.
- Pillet, G. (1986b), From external effects to energy externality: New proposals in environmental economics. *Hitotsubashi Journal of Economics*, **27** (1), pp. 77-97.
- Pillet, G. (1987), Externalities en environmental macroeconomics. In: Pillet and Murota (Eds), *Environmental Economics — The Analysis of a Major Interface*. Leimgruber, Geneva (Switzerland), pp. 129-153.
- Pillet, G. (1989), Energy externalities as indicators of ecological work in economic macroprocesses. In: *Environmental Protection — A Movement*. Nature Conservators, Muzaffarnagar (India), pp. 97-114.
- Pillet, G. (1990a), Prix non payés en écologie et en économie de l'environnement. *Revue économique*, **41** (2), pp. 321-334.
- Pillet, G. (1990b), *Towards an Inquiry into the Carrying Capacity of Nations*. Ecosys Ltd, Geneva, Report to Swiss Federal Department of Foreign Affairs, Berne, 28 pp. Revised English and French Versions, Berne, 1991. German Translation, Berne, 1992.
- Pillet, G. (1991), Shadow-pricing for natural resource goods and services, using the emergy method. In: Guvenen, Labys, and Lesourd (Eds), *International Commodity Market Models — Advances in Methodology and Applications*. Chapman and Hall, London - New York - Tokyo - Melbourne - Madras, pp. 91-100.
- Pillet, G. and H. T. Odum (1984), Energy externality and the economy of Switzerland. *Schweizerische Zeitschrift für Volkswirtschaft und Statistik*, **120** (3), pp. 409-435.
- Pillet, G. and H. T. Odum (1987), *E<sup>3</sup> Energie, Ecologie, Economie*. Georg, Geneva (Switzerland), 257 pp.
- Pillet, G. and A. Baranzini (1988a), Procédure d'évaluation de la part de l'environnement dans un produit économique. *Economie Appliquée*, **41** (1), pp. 129-150.
- Pillet, G. and A. Baranzini (1988b), Shadow-pricing environmental goods and services, using the 'emergy' method. *Environmental Conservation*, **15** (3), pp. 263-264.
- Pillet, G., M. Villet, A. Baranzini, G. Collaud, R. Leimgruber and S. Sandoz-Terraz (1990a), *Analyse du rôle de l'environnement dans les macroprocessus économiques*. Report # 1.378-0.86 to the Swiss National Science Foundation, University of Geneva, 622 pp.
- Pillet, G., A. Baranzini, W. Hediger, S. Sandoz-Terraz, C.A.S. Hall, and H. Greppin (1990b), Methods and models for valuing environments: With special reference to Switzerland. Paper presented at the International, Interdisciplinary Conference: *The Ecological Economics of Sustainability*. The World Bank, Washington, D.C., 21-23 May 1990, 35 pp.
- Sagoroff, S. (1970), *Die Energetische Struktur der Oesterreichischen Volkswirtschaft im Jahre 1964*. Physica Verlag, Wien-Würzburg.
- Vitousek, P.M., P.R. Ehrlich, A.H. Ehrlich, and P.A. Matson (1986), Human appropriation of the products of photosynthesis. *BioScience*, **34**(6), pp. 368-373.

# **SUBSTITUTION OF TRANSPORT ACTIVITIES: AN INPUT-OUTPUT APPROACH TO DETERMINE ECONOMIC AND ENVIRONMENTAL EFFECTS**

René DELL'MOUR  
Austrian National Bank  
Peter FLEISSNER, Wolfgang HOFKIRCHNER  
Vienna University of Technology  
Anton STEURER  
Institute for Interdisciplinary Research and Continuing Education

## **1. INTRODUCTION**

Although it is not the whole story, in analytical terms the relationship between the socio-economic system and the environment can be described as a *network of interrelations* or, more simplified, as a *feedback loop*.

The steps of the feedback loop are: Economic activities produce "goods" on the one hand and deplete resources and release pollutants or "bads" on the other. Pollutants are transmitted or relocated and end up as immissions, leading to environmental damage and decline of environmental quality. Decline of environmental quality causes negative feedbacks on the socio-economic system, which are partly measurable, e.g. avoidance costs, income losses, etc.<sup>1</sup> Depletion of resources, occupation of space (e.g. buildings, roads, hydroelectric power plants), and certain activities not primarily related to pollution (e.g. consolidation of farmland) more or less follow the same path.

To find a chain of causation – activity → pollution → immission → damage → costs – often involves the coordination of many scientific disciplines. An example for this difficulty was and still is the debate on the causes for the dying of forests and their respective shares.

This paper deals with one step of the cycle only: the possibility of *linking economic activities and pollution*, as demonstrated in the case of traffic.

"Pollution" marks a "crossing of the border": matter/energy leaves technosphere and society more or less loses control. At this point environmentalists and economists meet. Economists learn many substances that should not be released into the environment any more, or at least should be reduced. This is also one of the main points for measuring success in environmental policy.

---

<sup>1</sup> See UN-STATISTICAL OFFICE 1990, 57.

To link economic *activities* and environmental loads (*emissions*) one needs to work on *two* fields of data.

- The *economy* must be represented by data which can be gathered easily and accurately *and* which are as near as possible to environmental impacts. The zero-growth debate has shown that monetary aggregates like GNP or turnover of branches or companies are not an appropriate indicator for pressures on the environment. For the purpose stated the consequence is to use data in terms of *physical* rather than monetary units, that is to use indicators like cement or steel consumption, transport volumes and energy consumption.<sup>2</sup>
- *Environmental loads* can be represented by data about amounts of *pollutants released* including waste deposited, data on land use and so on. Since economic statistics as a rule do not contain output data concerning "bads", pollution-concerned macro-data usually are based on special surveys or on estimations by experts.

In Leontief's and Duchin's models<sup>3</sup> the linkage is established by "emission coefficients", a simple division of the volume of pollution in physical units by gross production.

The main disadvantage of this method is that a *direct link* between economic indicators and pollution is assumed, implying that economic activity and pollution is proportionate, which is not true so generally. Because of the highly aggregated economic activities one factor usually represents not only one source of pollution but a spectrum of different sources and causes guided by different laws of behavior. Therefore a different approach is proposed here by splitting the emission coefficients into physical "*emission factors*" and "*intensities*", which represent a more stable monetary-physical relation. Thus one can expect a better performance in policy simulation and forecasting.

## 2. EMISSION FACTORS AND INTENSITIES

An *emission factor* describes the amount of specific emissions in the form of a vector going with the use of a certain amount of *physical* input (e.g. input of energy by type of source and by type of equipment used) or the *production* of a certain amount of output. Such factors are usually based on technical studies and experiments. In the case of air pollution emission factors based on energy consumption are widely used to estimate emissions.<sup>4</sup> These factors should be reasonably accurate and stable.

Using emission factors, the general formula for calculating the amount of emission is: specific emission factor per base unit times the amount of base units.

<sup>2</sup> See also OECD 1991a, 58 f.

<sup>3</sup> LEONTIEF 1970; LEONTIEF 1973; DUCHIN 1990, 252-253.

<sup>4</sup> Emission factors were published by AHAMER 1989; ORTHOFER and URBAN 1989; LENZ and AKHLAGHI 1989; BUNDESMINISTERIUM FÜR WIRTSCHAFTLICHE ANGELEGENHEITEN 1990 and others.

Two effects are obvious, a *technology effect* (changes of the emission factor, e.g. advances in abatement technology), and a *growth effect* (changes in the amount of base units), which in the case of disaggregation divides into a *structural effect* and a *pure growth effect*.<sup>5</sup>

*Intensities* on the other hand represent a *bundle of auxiliary variables* as a *measure of social activities* which affect the environment in a very general meaning of the word and are closely related to economic activity. According to chapter 1 it is necessary to select from economic data those which are *best able to represent* environmental loads. Such *indicators* represent mainly volume data of *input* or *production*, for example energy consumption, steel or cement production, land use, transport volumes, insurance payments and so on. These data – disaggregated by branches – are *divided by turnover, value added, or number of employees*. Thus specific *intensities* for every branch are obtained.

The following intensities<sup>6</sup> seem to be sufficiently general for environmental accounting: Energy intensity<sup>7</sup>, transport intensity<sup>8</sup>, matter intensity, area intensity and risk intensity. Each of these figures should be disaggregated into several categories. For example one could calculate energy intensity by energy source (fossil, renewable, solar...) or transport intensity by means of transportation (car, tram, bus, rail, truck...) for freight and persons separately.

As a result one gets a matrix of say, 40 branches times 30 indicators and subindicators, which constitute an "eco-profile" of every branch and of economy as a whole. The purpose of such a matrix is to measure the relative environmental performance of each branch. Pollution can be interlinked with intensities by using emission factors.

Therefore "emission coefficients" (see chapter 1) can be split into two parts. Emission factors in physical units relate pollution to goods produced or inputs used, e.g. the use of 1 terajoule of energy in sector X "produces" 500 kg SO<sub>2</sub>, 200 kg NO<sub>x</sub> and so on. Intensities relate goods produced or inputs used to some output indicator, e.g. sector X needs 1 megajoule of energy per 1000 AS gross output.

Emission coefficients are the result of a simple multiplication:

Formula:	<i>emission coefficient</i>	=	<i>emission factor</i>	*	<i>intensity</i>
Relation:	pollution/gross product		pollution/indicator		indicator/gross product
Units:	physical/monetary		physical/physical		physical/monetary
Example:	kg SO <sub>2</sub> /AS		kg SO <sub>2</sub> /TJ		TJ/AS

By combining intensities and physical emission factors in the framework of an I-O model, the effects on the emissions-situation of predicted structural changes or planned political steps can better be evaluated than by using conventional emission coefficients.

<sup>5</sup> Among others see RWI 1987, 95 f.

<sup>6</sup> For more details see the paper of FISCHER-KOWALSKI et al. in this volume; FISCHER-KOWALSKI et al. 1991; JÄNICKE and MÖNCH. 1990.

<sup>7</sup> See OECD 1991a, 54 f.; OECD 1991b, 225; MILLER and BLAIR 1985, 227-235.

<sup>8</sup> See OECD 1990.

### 3. THE GENERAL INPUT-OUTPUT MODEL

The general model that has been started from is based on Leontief's extended input-output model where economic variables are combined with environmental indicators. *Figure 1* shows the basic structure of the full model.

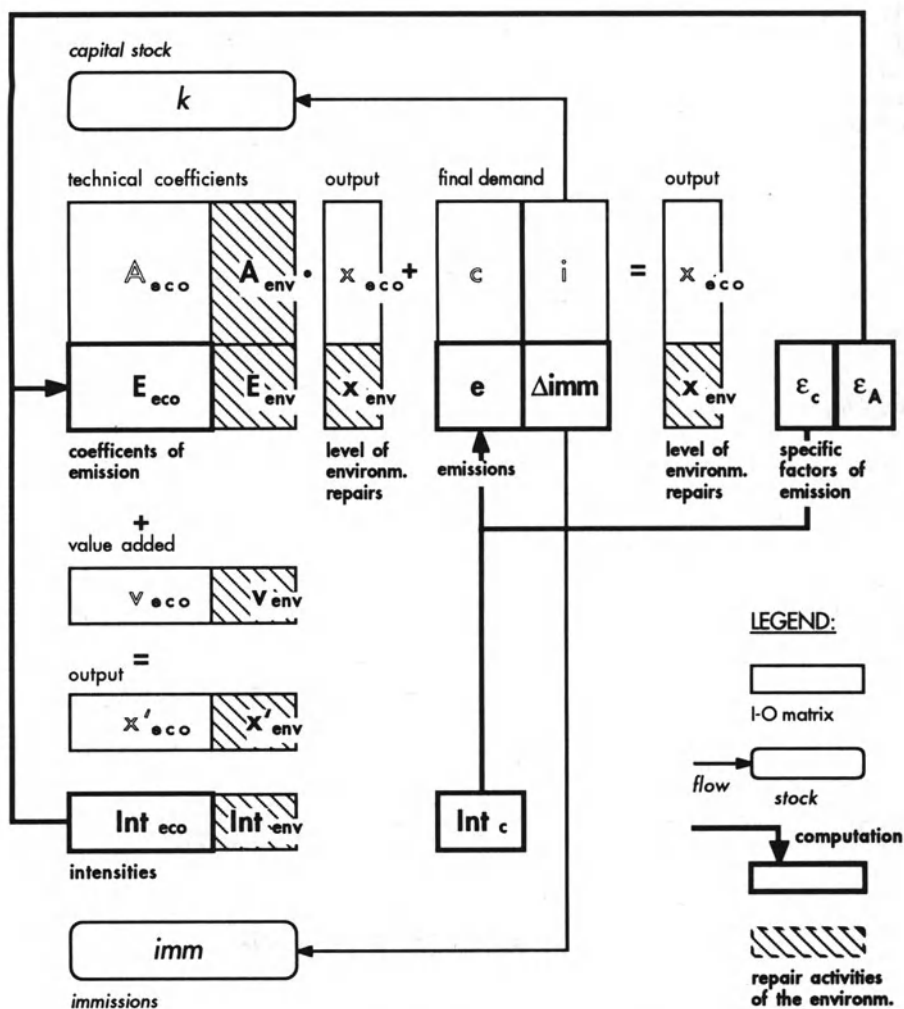

Fig. 1: The Basic Structure of the Full Model

The upper parts of the arrays shown in the upper half of the figure represent economic activities ( $k$ ,  $x_{eco}$ ,  $c$ ,  $i$ , measured in currency units, and the coefficients of the matrices  $A_{eco}$  and  $A_{env}$ ), the lower parts represent environmental variables ( $e$ ,  $\Delta imm$ ,  $x_{env}$ , measured in physical units, and the coefficients of the matrices  $E_{eco}$  and



$E_{env}$ ). The right half of the matrix of technical coefficients ( $A_{env}$  and  $E_{env}$ ) is devoted to repairing activities of the environment on a physical level of  $x_{env}$  (cleaning water, recycling etc.). Value added  $v$  is split correspondingly. The model is not restricted to comparative statics but may be used to describe the dynamic process as well. Stocks are included in two ways, economic and environmental: fixed assets,  $k$ , increased by net capital investment, represent the means of production available; the level of immissions,  $imm$ , is changed by  $\Delta imm$ , the net pollutants set free to the environment.  $imm$  can also be interpreted as a potential of risks (e.g. in the case of stored radioactive waste). In the case of persistent substances like heavy metals a simple addition is performed. To describe the mechanism of autonomous or natural reduction (e.g.  $CO_2$ , most chemical compounds) lifetimes can be applied and depreciations can be made.

While the economic variables are applied and connected in the *standard input-output* manner and work continues with both economic and environmental indicators *intensities*  $Int$  and *emission factors*  $\epsilon$  are used to determine the desired *emission coefficients*  $E$  for the determination of environmental effects. In *Figure 1*  $\epsilon_c$  refers to consumption and  $\epsilon_A$  to production.

#### 4. AN APPLICATION: FREIGHT TRANSPORT SERVICES

As an example to *illustrate* the pros and cons of the above approach freight transport is studied. By using the augmented input-output model one is able to determine the economic and environmental effects of shifting a fraction of freight transport from road to railway. Of course the results are very rough estimates, as a 10-sectors I-O model and only one of the five intensities mentioned above are used.

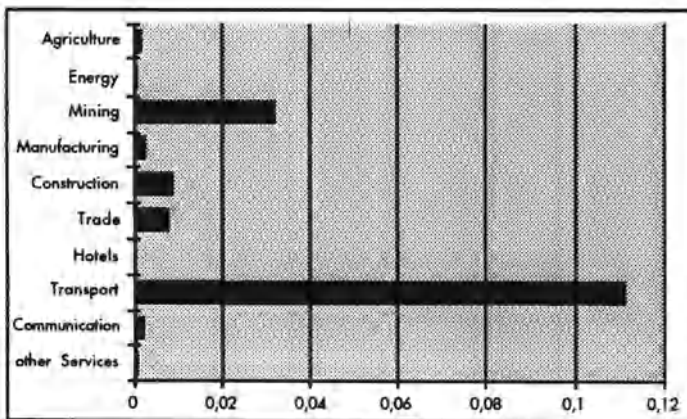

Figure 2: Transport Intensities by Trucks (tkm per 1 AS output)

#### 4.1. Transport Intensities

Transport intensities are defined as annual transport activities of a certain kind over an economic indicator, measuring the level of activity of a certain branch of production. In this example ton-kilometers (tkm) on road and on railway, respectively, are used as numerator, and gross economic output is used as denominator. *Figure 2* shows transport intensities by trucks.

#### 4.2. Classifying Transport Activities

According to the goal of investigation total transport activities may be subdivided by the following criteria:

1. By the *supplier* of the service: Internal activities are organized by the companies themselves (company transport) and, in accounting terms, are part of gross production of the specific industry. External activities are bought by companies on the market (commercial transport): Commercial transport constitutes a separate industry, company transport is distributed among all the other sectors of the economy.
2. By the *carrier*: Transport by trucks, by railroad and by others.
3. By the *type of transported entities*: Transport of persons, transport of commodities (freight).
4. By the *range* of transport: Long-range transport and short-range transport.

#### 4.3. Substituting Transport Activities

Only a fraction of transport activities by road can be substituted by railway (access to rail networks is necessary, local transport cannot be done by rail). Therefore the present task is to study the effects of substituting *long-range*<sup>9</sup> freight transport via trucks by railroad only. Even then the results have to be considered as estimates of an upper bound of possible effects. Of course one will not arrive at these results immediately. The substitution depends on a time consuming and costly conversion of the infrastructure.

#### 4.4. Relative Prices

Since in Austrian input-output statistics data are available on the aggregate of total truck transport activities only, one has to find out the share of long-range services within this subgroup. Fortunately, special data on the amount of services split into long-range and short-range activities are available (measured in ton-kilometers). By means of a relative price,  $r$ , in terms of short-range activities the volume of long-range transport by trucks in million AS ( $r$  was assumed as 0.6) can be computed.

---

<sup>9</sup> More than 70 kilometers.

$$\begin{aligned}
 \mathbf{x}_l &= \mathbf{x} - \mathbf{x}_s \\
 \mathbf{x}_s &= \mathbf{p}_s \cdot \mathbf{c}_s \\
 \mathbf{p}_s &= \mathbf{x} / (\mathbf{c}_s + r \cdot \mathbf{c}_l) \\
 \mathbf{p}_l &= r \cdot \mathbf{p}_s
 \end{aligned}$$

Thus the gross output for long-range commodity transport is given by

$$\mathbf{x}_l = \mathbf{x} [ 1 - \mathbf{c}_s / (\mathbf{c}_s + r \cdot \mathbf{c}_l) ],$$

where

$\mathbf{x}$  is the gross output of the total truck transport sector,  
 $\mathbf{c}$  is the volume of services of the total truck transport sector,  
 $\mathbf{p}$  is the unit price for services of the total truck transport sector.

The indices  $s$  and  $l$  denote short- and long-range transport.

#### 4.5. Shifting Company Transport to Commercial Transport

To illustrate the reallocation from company transport into commercial transport the following simplified input-output scheme is used (*Figure 3*).

$x_{11}$	$x_{12}$	$y_1$	$x_1$
$x_{21}$	$x_{22}$	$y_2$	$x_2$
$v_1$		$v_2$	
$x_1$		$x_2$	

*Figure 3: Simplified Input-Output Scheme before Reallocation*

Let sector 1 represent an industry which applies company transport, and sector 2 the commercial transport industry. The volume of company transport of sector 1 is denoted by  $t_1$  (in currency units). The respective values for intermediate inputs are denoted by  $t_{11}$  and  $t_{21}$ . These values have to be subtracted from the original intermediate inputs  $x_{11}$  and  $x_{21}$ , respectively. After reallocation one ends up with *Figure 4*.

$x_{11}-t_{11}$	$x_{12}+t_{11}$	$y_1$	$x_1$
$x_{21}-t_{21}+t_1$	$x_{22}+t_{21}$	$y_2$	$x_2+t_1$
$v_1+t_{11}+t_{21}-t_1$		$v_2-t_{11}-t_{21}+t_1$	
$x_1$		$x_2+t_1$	

*Figure 4: Simplified Input-Output Scheme after Reallocation*

As a first step the original data are transformed in the way described above. Standardizing the input values results in a matrix  $A_1$  of technical coefficients (see *Appendix*). They represent a situation where the *long-range* company transport on trucks is reallocated to the transport sector. Its services are bought on the market at the actual price of long-range services in the transport sector.

#### 4.6. Defining Technology

The next step is to replace the actual average technology in the transport sector by a technology where long-range transport is done by railway alone instead of trucks.

The starting point of the substitution is the standard input-output model with the actual mix of different transportation technologies. This average standard technology is considered as standard technology. In mathematical terms it is characterized by a column vector  $\mathbf{a}_{st}$ . A more disaggregated version of the I-O table provides with technology vectors for transport by railway,  $\mathbf{a}_{rl}$ , and for road transport,  $\mathbf{a}_{rd}$ . The technology vector,  $\mathbf{a}_{res}$ , representing the residual categories of transport, that is the technology used by transport other than railway or road, is computed by the following formula:

$$\mathbf{a}_{res} = (\mathbf{a}_{st} \cdot \mathbf{x}_{st} - \mathbf{a}_{rd} \cdot \mathbf{x}_{rd} - \mathbf{a}_{rl} \cdot \mathbf{x}_{rl}) / \mathbf{x}_{res}$$

The aggregated gross product  $\mathbf{x}_{st}$  is split into three parts:

$$\mathbf{x}_{rd} + \mathbf{x}_{rl} + \mathbf{x}_{res} = \mathbf{x}_{st}$$

$\mathbf{x}_{res}$  actually includes tram and bus, taxi and other personal transport, auxiliary services for roads, lift transport, ship transport, air transport, services for airports, transport by pipelines, carrier services and travel agencies.

The empirical values for the gross output and the technical coefficients are shown in *Table 1*.

Kind of Technology	Average $a_{st}$	Road $a_{rd}$	Railway $a_{rl}$	Residual $a_{res}$
Agriculture	0,00100	0,00021	0,00164	0,00106
Energy	0,02163	0,00570	0,03799	0,02116
Mining	0,00257	0,00156	0,00405	0,00233
Manufacturing	0,15615	0,26013	0,09727	0,13603
Construction	0,01268	0,00515	0,02093	0,01221
Trading	0,01921	0,03293	0,01023	0,01714
Hotels	0,03997	0,01756	0,00536	0,06721
Transport	0,08754	0,02126	0,08252	0,12098
Communication	0,00756	0,00468	0,00250	0,01136
Other Services	0,06934	0,08326	0,03477	0,07957

Output (Million AS)	$x_{st}$	$x_{rd}$	$x_{rl}$	$x_{res}$
	47.700	11.431	11.832	24.437

*Table 1: Technical Coefficients of Standard, Road and Railway Technology and Gross Output*

To interpret this table it is necessary to clearly define some sectors. The energy sector includes electric energy but excludes gasoline, which is counted under the head of manufacturing industries. The mining sector includes extraction of crude oil. Railways use about seven times more (electric) energy per million AS gross output than truck

transport, while transport by trucks needs nearly three times as much input from manufacturing industries per unit of gross output.

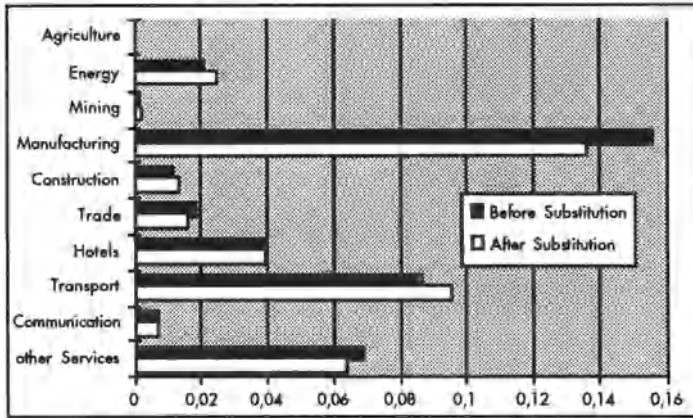

Figure 5: Technical Coefficients of the Transport Sector before and after Substitution

#### 4.7. Changing Technical Coefficients

Under the assumption of constant final demand,  $\mathbf{y}$ , the I-O system is solved for gross output,  $\mathbf{x}$ , under changed technology. By this the original technical coefficients of the transport sector are replaced by modified ones. In particular a technology vector has to be determined where long-range transport via trucks is replaced by transport via railroad. By the above definition, the technology vector of the actual (standard) transport technology is composed as follows:

$$\mathbf{a}_{st} = (\mathbf{a}_{rd} \cdot \mathbf{x}_{rd} + \mathbf{a}_{rl} \cdot \mathbf{x}_{rl} + \mathbf{a}_{res} \cdot \mathbf{x}_{res}) / \mathbf{x}_{st}$$

Now one has to change the weights of the specific technologies.  $\mathbf{x}_{rd}$  has to be corrected for its long-range component.  $\mathbf{x}_{rl}$  has to be increased by the revaluated amount of long-range transport via trucks. This amount is a sum of the former long-range component of company transport and the component of the above commercial transport, both revaluated at unit prices of railroad transport (see Fig. 5).

As expected energy consumption of the new composed technology increases (mainly electric energy), while input from manufacturing (because of reduced gasoline consumption) decreases considerably.

#### 4.8. Determining the Substitution Effect on Gross Output

The output vector  $\mathbf{x}$  now is a function of technology. It is the result of the pre-multiplication of the (constant) vector of final demand,  $\mathbf{y}$ , by the Leontief inverse of  $\mathbf{A}_2$ , the matrix of changed technical coefficients:

$$\mathbf{x}_2 = [\mathbf{I} - \mathbf{A}_2]^{-1} \mathbf{y}.$$

The technological change results in a change in gross output (structural effect of technological change, see *Figure 6*).

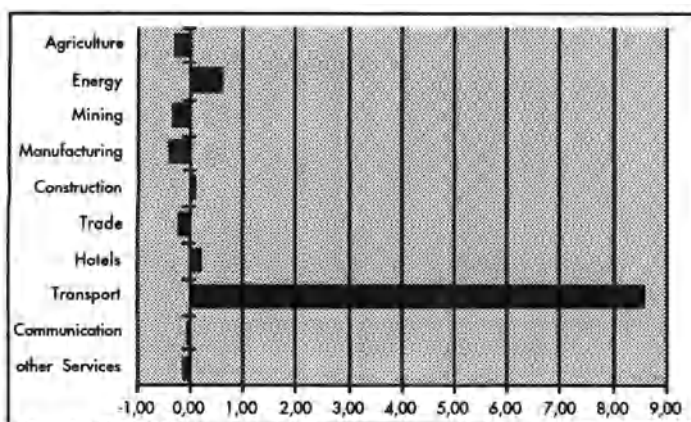

*Figure 6: Structural Effect of Substitution on Output per Industry (Percent)*

Obviously the gross product of the transport sector is increased most because of additional market activities of this sector. On the second rank is the increase in electric energy.

#### 4.9. Emission Factors

Specific emission factors,  $\epsilon_{rd}$  and  $\epsilon_{rl}$ , are used for the determination of the effect of substitution on emissions. The emission factors refer to *long-range* freight transport by road and to railway freight transport, respectively. The base unit is ton-kilometers. *Table 2* shows the assumptions.

Pollutant (grammes per ton-km)	$\epsilon_{rd}$ (road)	$\epsilon_{rl}$ (rail)
SO <sub>2</sub>	0,172	0,0077
NO <sub>x</sub>	3,088	0,1320
CO	0,632	0,0580
C <sub>x</sub> H <sub>y</sub>	0,510	0,0400
Dust	0,283	0,0216
CO <sub>2</sub>	197,391	8,8400

*Table 2: Specific Emission Factors of Road and Railway Technology*

Multiplication of the vectors by the annual amount of transport services (measured in ton-kms) results in an estimate of the direct total pollution produced by road and railway transport, respectively.

#### 4.10. Determining the Substitution Effect on Pollution

To first evaluate the *direct* effect on pollution after substitution the following path is chosen: the amount of direct pollution of long-range transport by road is determined and subtracted from total pollution; the amount of additional direct pollution by the increased railway transport is determined and added to the above sum; new emission factors for the complete system,  $E_{econew}$ , are determined. Finally, the direct effect on pollution by a change in technology has to be combined with the growth effect determined above. The total effect, the matrix of total pollution,  $P$ , is given by

$$P = E_{econew} \text{diag}\{ [ I - A_2 ]^{-1} y \},$$

where  $\text{diag}(x)$  means a diagonal matrix consisting of the vector  $x$  in the main diagonal.

Figure 7 shows the relative effects on total pollution. Without involving the private households motor vehicles a seven percent reduction of  $NO_x$  emissions and a five percent reduction of particles (dust) due to the decreased emissions by diesel engines could be achieved. Referring to emissions from traffic that is a reduction of eleven and seventeen percent, respectively.

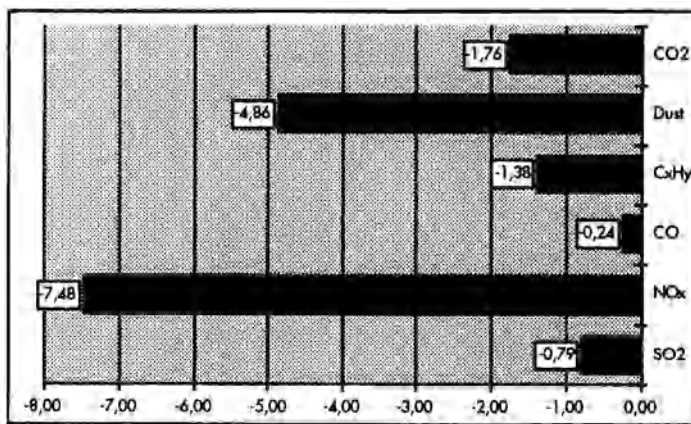

Figure 7: Effect of Substitution on Emissions (Percentage Change)

Although the railroad technology needs higher inputs from agriculture, energy, mining, construction and transport, thus resulting in higher activities (and emissions) of these sectors, the effect of the substitution as a whole more than compensates for these increases of emissions.

While about 45 percent of the volume of freight transport by road (measured in ton-kms) is transferred to rail emissions by trucks are reduced by less than 30 percent (CO is reduced by less than 10 percent). This is due to the fact that the remaining short-range transport is performed by smaller trucks with much higher specific emissions per ton-km.

## APPENDIX

## MATRIX OF TECHNICAL COEFFICIENTS, FINAL DEMAND, Y (MIO. AS), AND GROSS OUTPUT, X (MIO. AS), 1976:

TECHNICAL COEFFICIENTS	1	2	3	4	5	6	7	8	9	10	Y	X
1 AGRICULTURE	0,00897	0,00035	0,00270	0,08142	0,00106	0,00206	0,03240	0,00100	0,00008	0,00198	10891	56098
2 ENERGY	0,00995	0,27709	0,02492	0,01865	0,00599	0,01303	0,02966	0,02163	0,00450	0,01443	12477	44373
3 MINING	0,00213	0,09205	0,02243	0,04297	0,01694	0,00058	0,00166	0,00257	0,00051	0,00197	-17496	11729
4 MANUFACTURING	0,22153	0,08776	0,19257	0,34423	0,29128	0,10213	0,29364	0,15615	0,05163	0,09411	230739	518427
5 CONSTRUCTION	0,00552	0,01336	0,00789	0,00450	0,02801	0,00489	0,02331	0,01268	0,00542	0,02934	76790	94141
6 TRADE	0,03602	0,00933	0,01448	0,03661	0,03876	0,02897	0,04519	0,01921	0,00662	0,02152	89315	127892
7 HOTELS	0,00124	0,00116	0,00334	0,00328	0,00355	0,00720	0,00074	0,03997	0,00549	0,00489	37225	43878
8 TRANSPORT	0,00982	0,01795	0,00460	0,01526	0,03762	0,00591	0,00662	0,08754	0,01938	0,01090	25955	47700
9 COMMUNICATION	0,00533	0,00224	0,00402	0,00509	0,00394	0,01874	0,00476	0,00756	0,01394	0,00947	6416	15976
10 OTHER SERVICES	0,04493	0,04137	0,05649	0,05444	0,06011	0,11609	0,07608	0,06934	0,03697	0,14837	201548	308269

## MATRIX OF TECHNICAL COEFFICIENTS AFTER SHIFTING COMPANY TRANSPORT TO COMMERCIAL TRANSPORT:

TECHNICAL COEFFICIENTS	1	2	3	4	5	6	7	8	9	10
1 AGRICULTURE	0,0090	0,0003	0,0027	0,0814	0,0011	0,0021	0,0324	0,0009	0,0001	0,0020
2 ENERGY	0,0099	0,2771	0,0244	0,0186	0,0059	0,0130	0,0297	0,0200	0,0045	0,0144
3 MINING	0,0021	0,0921	0,0223	0,0430	0,0169	0,0006	0,0017	0,0025	0,0005	0,0020
4 MANUFACTURING	0,2201	0,0875	0,1712	0,3436	0,2876	0,1005	0,2934	0,1666	0,0505	0,0937
5 CONSTRUCTION	0,0055	0,0134	0,0075	0,0045	0,0279	0,0049	0,0233	0,0119	0,0054	0,0293
6 TRADE	0,0358	0,0093	0,0118	0,0365	0,0383	0,0288	0,0452	0,0206	0,0065	0,0215
7 HOTELS	0,0011	0,0011	0,0019	0,0032	0,0033	0,0071	0,0007	0,0377	0,0054	0,0049
8 TRANSPORT	0,0151	0,0187	0,0050	0,0178	0,0514	0,0119	0,0074	0,0809	0,0238	0,0124
9 COMMUNICATION	0,0053	0,0022	0,0036	0,0051	0,0039	0,0187	0,0048	0,0073	0,0139	0,0095
10 OTHER SERVICES	0,0445	0,0413	0,0497	0,0542	0,0589	0,1156	0,0760	0,0707	0,0366	0,1482

## ENERGY CONSUMPTION IN 1987 (IN 1000 TONS):

	GASOLINE	DIESEL
1 AGRICULTURE	31,3	294,6
2 ENERGY	6,3	7,2
3 MINING	10,2	94,2
4 MANUFACTURING	112,5	130,8
5 CONSTRUCTION	44,0	136,5
6 TRADE	80,0	75,7
7 HOTELS	9,7	3,8
8 TRANSPORT	89,4	712,3
9 COMMUNICATION	5,7	7,3
10 OTHER SERVICES	40,0	49,0
11 RESIDENTIAL (RESIDUAL)	2076,3	83,2

## TRAFFIC VOLUMES IN 1987 (ON NATIONAL TERRITORY):

	MIO PKM	MIO TKM
1 AGRICULTURE	370	141
2 ENERGY	87	54
3 MINING	110	872
4 MANUFACTURING	1306	1233
5 CONSTRUCTION	468	741
6 TRADE	1036	875
7 HOTELS	148	23
8 ROAD TRANSPORT	--	5330
8B RAILWAY	7570	10680
8C OTHER TRANSPORT	12020	--
9 COMMUNICATION	45	51
10 OTHER SERVICES	725	302
11 RESIDENTIAL	57204	197

## CARS, TRUCKS AND BUSES: EMISSIONS IN 1987:

	AGR- CULTURE	ENERGY	MINING	MANU- FACTURING	CONSTRU- TION	TRADE	HOTELS	TRANSP- PORT	COMMU- NICATION	OTHER SERVICES	PRIVATE CARS	SUM	TOTAL * EMISSIONS
SO2 IN 1000 t	0,04	0,01	0,22	0,32	0,19	0,23	0,01	1,80	0,01	0,08	0,74	3,66	119,3
NOx IN 1000 t	1,15	0,38	4,59	7,82	4,33	5,68	0,29	47,42	0,31	2,39	67,36	141,72	208,7
CO IN 1000 t	3,27	0,86	4,54	14,71	6,56	11,22	1,16	50,75	0,54	6,52	412,72	512,84	1171,8
CxHy IN 1000 t	0,69	0,20	1,82	3,87	1,97	2,87	0,21	19,49	0,15	1,40	64,45	97,12	175,1
DUST IN 1000 t	0,08	0,03	0,51	0,73	0,44	0,52	0,01	5,24	0,03	0,18	0,35	8,14	28,4
CO2 IN Mio t	0,10	0,03	0,33	0,62	0,33	0,45	0,03	3,68	0,02	0,20	7,34	13,13	56,5

\*...ALL SOURCES OF POLLUTION

SOURCES: ÖSTAT (AUSTRIAN CENTRAL STATISTICAL OFFICE); BUNDESMINISTERIUM FÜR WIRTSCHAFTLICHE ANGELEGENHEITEN (FEDERAL DEPARTMENT OF ECONOMIC AFFAIRS); OWN CALCULATIONS



**REFERENCE**

- AHAMER, G. (1989): Emissionsfaktoren, Diplomarbeit, Graz
- BUNDESMINISTERIUM FÜR WIRTSCHAFTLICHE ANGELEGENHEITEN (1990): Energiebericht 1990, Wien
- DUCHIN, F. (1990): The Conversion of Biological Materials and Wastes to Useful Products. In: Structural Change and Economic Dynamics, Vol. 1, No. 2, 243-261
- FISCHER-KOWALSKI M., HABERL, H., PAYER, H., STEURER, A., VYMAZAL, R. (1991): Verursacherorientierte Umweltinformationen, Wien
- JÄNICKE, M., and MÖNCH, H. (1990): Ökologische Dimensionen wirtschaftlichen Strukturwandels, Berlin
- LENZ, H. P., and AKHLAGHI, M. (1989): Schadstoffemissionen des gesamten benzin- und dieselbetriebenen Straßenverkehrs in Österreich sowie zu erwartende Entwicklungen 1970-2000; Forschungsarbeiten aus dem Verkehrswesen, Band 18, Wien
- LEONTIEF, W. (1970): Environmental Repercussions and the Economic Structure: An Input-Output Approach. In: Review of Economics and Statistics, Vol. 52, No. 3, 262-271
- (1973): National Income, Economic Structure, and Environmental Externalities. In: Moss, M. (Ed.), The Measurement of Economic and Social Performance, Vol. 38, New York, 565-576
- MILLER, R. E., and BLAIR, P. D. (1985): Input-Output Analysis, New Jersey
- OECD (1990): Statistical Trends in Transport, Paris
- (1991a): The state of the environment, Paris
- (1991b): Environmental Indicators – A Preliminary Set, Paris
- ORTHOFFER, R., and URBAN, G. (1989): Abschätzung der Emissionen von flüchtigen organischen Verbindungen in Österreich, Forschungszentrum Seibersdorf
- RWI – RHEINISCH-WESTFÄLISCHES INSTITUT FÜR WIRTSCHAFTSFORSCHUNG ESSEN (1987): Strukturberichterstattung 1987, Bd. 4: Strukturwandel und Umweltschutz, Essen
- UN-STATISTICAL OFFICE (1990): SNA Handbook on Integrated Environmental and Economic Accounting, New York, Oct. (Draft)

## ENVIRONMENTAL ACCOUNTING: SOME NON-TECHNICAL REMARKS

Josef RICHTER

Federal Economic Chamber, Vienna, Austria

### 1. INTRODUCTION

According to the list of papers, most of the contributions to this conference deal in a highly specialized way with topics of environmental accounting. The following considerations can add nothing to any of the sophisticated aspects of environmental accounting. They are devoted to some non-technical, rather basic issues.

The following paragraphs will present (almost) no new ideas or considerations. Old ideas and views, some of which have been published or expressed in connection with problem areas of national accounting other than environmental accounting, will be rearranged and reformulated. Special attention will be given to the Draft of the SNA Handbook on Integrated Environmental and Economic Accounting (Draft SEEA, UNITED NATIONS 1990). No attempt is made to provide a complete list of "problem areas". The following selection of six closely interconnected issues is a very personal one.

The present paper makes a plea in favour of an open-ended system of interrelated building blocks linked to a central system. Building blocks of different analytical orientation and different nature should be treated and presented separately. In order to

avoid false signals to decision makers and misinterpretation in general, a high priority should be given to an active information policy.

## 2. ANALYTICAL ORIENTATION

One of the big problems of the current and the future SNA is that it has to serve so many different purposes. It has been pointed out several times (e.g. HOLUB (1981), HOLUB (1983), VAN BOCHOVE, VAN TUINEN (1986), SUNGA (1988)) that the multitude of purposes necessarily leads to conflicting demands and to compromise solutions, which do not serve all or possibly any of the aims in an optimal way. Any extension of the coverage of the accounting system adds a new dimension to the multi-objective character of the overall system. Needless to say, if the general approach of a single accounting system for many purposes is not changed, any extension also adds new compromises to the system.

The adequacy of a certain way of bookkeeping, a certain concept of valuation or a certain system of classification cannot be discussed in a meaningful way without having defined the purpose of the accounting system before. That is why part of the discussion on the extension of the present accounting system is so misleading and sometimes even confusing: The discussants concentrate on **how** to treat specific elements in the system, whereas their basic disagreement results from **what** should be accomplished with the system. Their preference for one or the other analytical goals can often only be identified in a very indirect way.

Before going into all the technical problems of environmental/economic accounting the analytical orientation of the system has to be absolutely clear. It should be made explicit whether the systems primarily aims at the

- analysis of production (net/gross)
- measurement of income (net/gross)
- measurement of welfare
- to organize data on economic activities

- international comparability
- other purposes.

International comparability is an analytical concept which also entails many additional elements of ambiguity. Do we intend to achieve comparability despite different legal/institutional regulations or do we want to analyze the role of different regulations?

The decision in favour of one of these goals has many implications for the "overall design" of the accounting system and goes far beyond including one additional imputation or another. If we are interested in the analysis of production and in the implications of production on environment we need one type of narrowly defined statistical unit. If we focus on the measurement of income by sectors we need a different type of statistical unit, irrespective of the concept of sustainability we have. The same basic decision determines which kind of classification scheme should be adopted, which degree of disaggregation is needed, etc.

The focus of most of the more recent attempts to include environmental aspects into the accounting structure seems to be laid on measurement of income (e.g. DALY 1989, EL SERAFY 1989, HUETING 1989, PESKIN 1989, UNITED NATIONS 1990). This preference is so central that even a plea is made to consider the impacts of household activities and of man-made assets on environmental quality, "despite of the fact that the respective environmental costs are not directly associated with production activities" (Draft SEEA, UNITED NATIONS 1990, p. 133). Although the accent is on income and on "sustainable income" in particular, other analytical viewpoints are also present. The element of providing not just a single income indicator but an analytical tool to study the final "destiny" of a certain natural resource, the ultimate cause for a certain type of residual etc. deserves special attention (Draft SEEA, UNITED NATIONS 1990, Par. 3.2).

According to its preface, it is the objective of the Draft SEEA (UNITED NATIONS 1990) to provide a conceptual basis for a

satellite system which describes the interrelationship between the natural environment and the economy (p. ii). This definition covers many of the analytical goals mentioned above. A closer examination of the Draft SEEA shows that two objectives play a dominant role. The physical flow accounts ("Level B", to use the term of STAHER (1991) and described in Chapter 3) are primarily oriented towards the analysis of the environmental effects of production. To some extent these physical accounts are also necessary to establish a monetary accounting system (Level "C" as described in Chapter 4). The monetary accounting system primarily aims at the measurement of net income. Last but not least the element of international comparability is present too.

The Draft SEEA (UNITED NATIONS 1990) tries not only to cope with quite a number of analytical purposes, but also attempts to provide a synthesis of the different schools of thinking (p. 2). As far as the elements are complementary to each other there are no problems. But is it worthwhile considering a synthesis of concepts, if these concepts differ because of the different analytical orientation of different systems? As has been pointed out earlier, it might appear that different analytical requirements call for different treatment of various elements in the accounting framework. Can one single comprehensive system serve so many different purposes?

In the case of one monolithic system of integrated environmental/economic accounting, the critique which was already raised because of the multi-objective character of the present SNA, will gain momentum. The alternative of creating a flexible system along the lines proposed by VAN BOCHOVE and VAN TUINEN (1986) for the SNA, has many advantages for environment/economic accounting too. As long as the link to the central core can be established, different building blocks serving different analytical goals can be established. The same information can show up in various building blocks (or modules) in different ways, classifications, etc. according to the specific analytical viewpoint.

### 3. THE ROLE OF LEGAL AND INSTITUTIONAL CIRCUMSTANCES

The present SNA relies on **and** ignores prevailing legal and institutional circumstances at the same time. As far as the observed transactions and observed prices serve as the empirical basis of the various aggregates, these data reflect a variety of legal and institutional circumstances. Prices are dependent on the system of taxation, the social security system, the laws governing labour protection, safety regulations, the rules governing competition, etc. Many of these factors are also highly relevant to the level of wages. Regulations and other institutional rules determine whether an industry has to use certain inputs (e.g. because of the fact that a specific technology is compulsory) or whether the use of other inputs is against the law (e.g. certain fuels). To some extent regulations determine the level and the type of investment. Examples are mandatory standards for new buildings as regards insulation, standards for filters, standards for the noise produced by trucks, etc. Other regulations, such as standards for private cars, influence the level and the structure of consumers' expenditure, etc.

Besides their direct effects, all these factors have implications for absolute and relative prices. Via prices they influence almost the entire economy and thus all the aggregates shown in national accounts. None of the aggregates can be interpreted in a meaningful way without having the institutional background in mind.

As regards commodity taxes and subsidies the SNA - conceptually - provides a second set of tables at approximate basic values. This second set of tables removes the effects coming from different commodity taxes from the data and makes them more homogenous. Despite the elimination of the taxes the entries still reflect the institutional background. Because of the taxes (and/or subsidies) the volumes are different from a situation without these taxes.

The set of tables at approximate basic values can be seen as a clear step from a purely descriptive to an analytical system<sup>1</sup>. The same statement holds for "Value Added at Factor Values".

Other elements of the SNA depart from the institutional background. A well known and very important example (especially in the context of environmental/economic accounting) is the valuation of depreciation. Because of a certain analytical orientation (a specific - Hicksian - income concept and probably because of a very specific concept of international comparability) the rules for depreciation existing in the different countries are neglected. In the commercial accounts depreciation is calculated from historical (acquisition) costs, applying rates which are granted by tax authorities, etc. National accounts rely on replacement costs calculations and on theoretical rates. It cannot be denied that this procedure has a number of **analytical** advantages. On the other hand it entails inconsistency. Under the regime of a replacement cost regulation, prices would probably have been different, gross capital formation would have reached a different level, imports would have been higher or lower as a consequence of higher or lower gross capital formation, etc. Furthermore the solution which is adequate for one analytical goal, needs not be appropriate for other analytical purposes. A number of arguments could be raised for the valuation of depreciation on the basis of acquisition costs if one is - for example - interested in the investigation of sectoral investment behaviour.

The way depreciation is handled in national accounts - although it represents an "alien element" in the system - plays an important role in many of the concepts for environmental/economic accounting. The idea of treating the use of natural capital analogously to the use of man-made capital is the central idea of most of the approaches and proposed in the Draft SEEA (UNITED NATIONS 1990, Par. 4.4.3). One of the arguments against this analogy is that natural capital - in contrast to man-made capital -

---

<sup>1</sup> As regards the distinction between "descriptive" and "analytical" system see RAINER (1989) and RAINER, RICHTER (1989)

is not part of the output of one of the sectors within the production boundary.

In the context of the present contribution another argument is even more important. The treatment of depreciation in the SNA is already a major departure from a descriptive statistical system and introduces a certain degree of nonhomogeneity and inconsistency into the overall system. Any extension of the approach in order to cope with the use of natural resources and with environmental damage necessarily will lead to more and more non-homogeneity and inconsistency.

The motivation for the proposals to treat the use of natural resources as a kind of use of capital is quite clear and understandable: The case that natural resources can not longer be regarded as free gifts of nature is one being accepted by an increasing number of economists (HARRISON 1989b). On the other hand we observe that most of these resources still **are** free goods in the sense, that legislators and government authorities do not share the views of environmentalists and thus have attached no price to them. Irrespective of whether we agree to these decisions, they are or were effective.

Because of the crucial role of institutional regulations in understanding the content of the data, VAN BOCHOVE and VAN TUINEN (1986) stress the importance that the core "must be parsimonious in the use of constructions that are intended to capture the reality behind the perceptions of the economic agents" (p. 141). The concepts of the core should be free from the influence of hypotheses.

Any departure from the legal and institutional circumstances governing the use or abuse of natural resources and the environment changes the entire character of the results. If we introduce norms and standards other than those which were effective in order to measure income, measurement turns into a complicated *ceteris paribus* analysis. An attempt is made to simulate



different background conditions, keeping all the other elements of the interrelated system constant.

Such a procedure necessarily leads to rather complicated models. If it is the intention to go in this direction, it should be taken into account that such modeling experiments cannot rely on the assumption of a one-way-dependency. In reality environmental values change as a result of political measures (NORGAARD 1989). There is a mutual dependency which is difficult to grasp in a simple *ceteris-paribus* framework.

The question to what extent we attempt to abstract from the institutional background of the activities is closely inter-related with the nature of the various elements, which will be discussed in the following paragraphs.

#### 4. NATURE OF THE VARIOUS ELEMENTS OF AN ENVIRONMENT/ECONOMIC ACCOUNTING SYSTEM

One of the most fundamental questions is what does the accounting system intend to achieve. Three options are open:

- to provide a purely descriptive data set
- to offer an analytical data set, derived from the descriptive data set and oriented towards a well defined analysis
- to provide the results of the analysis itself

The present SNA contains all three elements, although the first option is predominant. The notion of a "descriptive data set" has much in common with the "core concept" as proposed by VAN BOCHOVE and VAN TUINEN. The wish to avoid any arbitrary valuation implies that the central system, the core, has to be restricted to flows which are directly connected with market transactions and for which a price can be observed (VAN BOCHOVE, VAN TUINEN 1986). To preserve as far as possible the initial set of data that go into the construction of the published accounts (POSTNER 1986), is an important aspect if the results of the compilations

are to be accepted by the broad public. National accountants have to offer evidence of how they have derived their estimates.

Besides descriptive data, analytical elements are also present in the SNA. The treatment of services provided by insurance companies is one example. In this case observed information is transformed and modified from a specific analytical viewpoint. Final demand at producers' prices, as shown in input-output tables, is another example. The overruling argument for producers' values instead of purchasers' values comes from the theoretical side (REICH 1986). In this case the analytical goal of homogeneous valuation leads to the redefinition and re-allocation of distributive margins.

Imputations, as they are found in the SNA, clearly represent the outcome of analysis. Total output of public services, for example, results from a combination of a specific hypothesis and observed data. These aggregates belong to the third category.

Most environmental/economic accounting systems also comprise all three elements, although the weights attributed to the three basic options differ. The Draft SEEA (UNITED NATIONS 1990) is more or less descriptive in its proposals for physical accounting (Level B). Its monetary accounting system (Level C) primarily belongs to the third category. Many parts of the proposed system have the characteristics of simulations under given norms, pre-conditions, which **did not** prevail in the period under consideration. The hypothetical character of elements of the proposed calculations is explicitly mentioned in the Draft SEEA (UNITED NATIONS 1990) in the case of the "maintenance cost approach". Another example is given in how the use of natural assets could be treated by **assuming** that the net value of degradation equals the potential abatement costs.

The problems which arise from any combination of observed data and model results in one single monolithic system have already been discussed in the previous section. Two aspects of

consistency deserve special attention with respect to the proposals included in the Draft SEEA (UNITED NATIONS 1990):

- we should not use the **observed** prices and **assumed** legal /institutional settings at the same time in one system
- we should not combine observed consumption or observed capital formation which we observed under a given legal/institutional setting and model results which are based on a different legal/institutional setting

To some extent the problem with consistency is a question of degree. A small imputation based on a ceteris-paribus model is not likely to violate consistency in a significant way. However, the integration of estimates on environmental degradation into the system can not be considered to be a insignificant imputation.

NORGAARD (1989) has pointed out that if the ultimate objective were to change the direction of economic development, all market values would be subject to significant changes. The standard technique for valuing non-market goods, however, is based on the assumption, that these goods are a marginal problem. Since only in this case can existing market prices be used in order to estimate the value of non-market goods.

Special attention should also be given to the role of **estimation**. Although the techniques used might be very similar or even be the same, a clear distinction should be drawn between:

- Estimation of elements which are of descriptive nature. Here we have to cope with problems arising from missing observations, underreporting, need for reconciliation, etc. Under more favourable statistical circumstances direct observation would be possible.
- Estimation of elements which belong to the category of model results and for which direct observation will never be possible.

When we are discussing valuation methods in the context of environmental accounting we should be aware that the "weak data basis" (e.g. Draft SEEA, UNITED NATIONS 1990, Par. 1.9) has

nothing to do with unreliable or missing data, circumstances which are usually associated with the term "weak data basis". In most cases it is the lack of generally accepted hypotheses for modeling purposes, with which we are confronted. Using the terminology coined by Richard STONE in his Nobel Memorial Lecture 1984 (STONE 1986), we should always be aware whether our figures still belong to the box called "Facts" or whether they should not be included in the box termed "Model". This "Model" is the result of combining the facts (organized in a coherent set of accounts) and theories.

The different nature of the various elements in the accounting system is relevant in the case of aggregation. Under all circumstances aggregation of dissimilar entities should be avoided. In a system of material accounts the argument against such kind of aggregation is always present since it would entail aggregation over different units such as tons and litres (e.g. PESKIN 1989). In the case of a single closed environmental/economic accounting systems we always have to deal with different "units". Some of them belong to the sphere of facts, others to the category of "model results". Observations and model results might be expressed in identical units (e.g. monetary terms). Nevertheless they are not "ready for aggregation".

##### 5. THE ECONOMIST'S VIEWPOINT

It should be noted that the present considerations reflect the typical view of an economist. Since most of the approaches for environmental/economic accounting start from the same background, this is not necessarily a big disadvantage. Other angles of looking at the interrelationship between economy and environment could, however, lead to more insight than the economist's viewpoint.

The concept of "sustainability" is a good example for the dominance of the economic viewpoint. No doubt, "sustainability" (the "keep capital intact" principle) is the key concept of all

attempts to improve the measurement of income. According to the famous definition proposed by HICKS, it is the purpose of income calculations "to give people an indication of the amount which they can consume without impoverishing themselves" (HICKS 1946, p. 172).

In many discussions Utz-Peter REICH has underlined the fact that the capital concept of HICKS is not one expressed in physical units, but one expressed in money terms and that it stands for what might be called "purchasing power for production factors". The analogy to the way depreciation of man-made capital is handled in national accounts is omnipresent in the discussion (e.g. Draft SEEA, UNITED NATIONS 1990, Par. 4.29). Natural assets are treated as factors of production only. It should, however, be noted that such a viewpoint represents the typical approach of economists in addressing a problem which is not of economic nature only.

In the case of depletable resources one can argue that (at least to a certain extent) one source of future consumption can be substituted by a different source of future consumption. Both types of future consumption, coming in one case from a natural resource like oil and from man-made equipment in the other case, can be measured by the same unit. Both factors of production are used to produce commodities, which have (or will have) a market price. In the case of the natural environment such a common yardstick is usually completely missing. How can we compare the extinction of a certain species of a plant to the value of the grain harvested in the same spot some years later? Is there any meaningful way to compare two different "states of nature" over time? How do we treat a significant loss in environmental quality in one specific area which is associated with an improvement in many other areas?

No (economic) measures can be attached to irreversible losses such as the extinction of certain animals or plants. How can we solve the problem of symmetry raised by ADLER (1982) and not only

concentrate on the "baddies" but also include some of the "goodies", which might arise from economic activities?

A clear distinction between the notion of capital stock and the heritage concept, which says that future generations should benefit from the same natural environment as previous ones (e.g. BARTELMUS 1989), has to be drawn. This distinction shows that the concept of sustainability is so multidimensional and contains so many non-economic aspects that it would be misleading to rely on one (economic) methodology only (NORGAARD 1989).

Another characteristic of most of the proposed extensions of the accounting system (e.g. FRANZ (1988), Draft SEEA (UNITED NATIONS 1990)) is the emphasis put on flows and stocks. This emphasis stands in the tradition of the economists' way of viewing transactions and helps to arrive at a closed system. The recording of flows facilitates the linkage of data on emissions to the economic system and is quite feasible as long as the interdependencies between the economic system and the environment are to be studied. It provides the basis for modeling emissions and for calculating the impact on economic variables of measures taken to protect the environment.

The emphasis on annual flows is by no means appropriate if one is interested in emissions and in the impact of economic activities on the state and the quality of the environment. Biologists for example argue that such aggregates are of little use for the kind of analysis they want to perform. In order to assess the impacts of a certain economic activity, they would prefer to have maximum and minimum concentrations of various pollutants, information on the joint presence of effects, data on distributions. All this information should come in a detailed breakdown by regions.

## 6. DISSEMINATION AND PRESENTATION OF RESULTS

Many environmentalists argue that the concept of GDP is abused, and therefore GDP (or a similar dominant general indicator) has to be brought into line with the interpretation which is often attached to it. Not much can be said against this diagnosis. Many arguments, however, can be raised against the therapy they propose. Instead of changing an instrument, which has - if used in a proper way - many advantages, efforts should be devoted to all activities to facilitate the proper interpretation. No medicine may be sold without attaching a little piece of paper to it which informs the qualified reader (the doctor) and the broad public (the patient) about the purpose of this specific drug, its side-effects and which offers a number of caveats, which have to be taken into account.

National accountants should go into the same direction. They should provide a maximum of information on the pros and cons and on the limits of their products. In addition to a well elaborated documentation for the highly qualified users (which does exist) little compendia on the main characteristics of the product for the "standard user" should also be disseminated. Such a publicity campaign could be more effective than any attempt to turn a highly efficient drug against influenza into a multipurpose drug (with a number of severe side-effects) which also cures pains caused by the stomach just because an ill-informed public has used the drug in this inappropriate way.

In order to facilitate the interpretation and the proper use of the aggregates, building blocks of different nature (as described in the previous chapter) should strictly be separated in all publications. The clear distinction made between "Industries" and "Other producers" is a good example. In the case of more complex accounting systems (such as the Draft SEEA, UNITED NATIONS 1990) such a clear distinction between elements of different nature would be extremely helpful to avoid additional misunderstanding and misinterpretation. The problem of "false signals" (to use the term of BARTELMUS 1987) should be taken seriously.

## 7. CONCLUSION: SOME PRACTICAL CONSIDERATIONS

The discussions on the overall design and the details of environmental/economic accounting systems should start by defining the analytical orientation and deciding the question of whether the system is intended to provide a profound basis for analysis or whether the system should already lead to the result of the analysis directly. A clarification of these two basic issues would help to make further discussions much more efficient. If it turns out that too many needs have to be satisfied, the idea of having one single comprehensive system should be rejected in the same way as the idea of one single aggregate to measure all aspects of economic activities. As SUNGA (1988) has argued with respect to the alternative ways of treating depreciation, it is not useful to discuss the appropriateness of the various concepts, because we need data on both. The proposal put forward in the Draft SEEA (UNITED NATIONS 1990) to provide physical accounts and monetary satellite accounts is in line with this idea.

Also for pragmatic reasons, much should be done to improve the "state of knowledge" among the users of accounting systems. As already pointed out, misinterpretation of the aggregates defined by the SNA is a major source for the critique on the present system. It has often been stated that the question of what the aggregates of national accounts actually measure have been largely ignored (ROMANS 1977). The public tends to use the standard (and often not appropriate) indicators such as gross product even in the presence of more appropriate measures such as the net product (HARRISON 1989b). There is an obvious need for using GDP and other aggregates with proper caveats and to offer additional facts in national accounts publications (HUETING 1989).

If national accountants have failed to inform decision makers and the broad public about the scope and limits of the indicators they provide, can they really hope that the users will avoid the crucial problem of misinterpretation in the case of an intellectually much more demanding expanded system which comprises observed facts and sophisticated model results? According



to a statement by Richard RUGGLES (1990) with respect to the revision of the SNA in general, there is the danger that such a system might become a statistical behemoth independent of its creators and with an illogic of its own - not unlike a Frankenstein monster. This statement seems to be of special relevance in the case of economic/environmental accounting. Some of the problems could be solved by a better presentation of the data, but not all.

Any extension could again lead to a simplistic answer through a single aggregate which is then (mis)interpreted as "true income" or even "welfare". Instead of providing for such a simplistic answer or a single all-embracing information system, which primarily serves popular demands, much can be said in favour of a reasonably differentiated and integrated "information strategy" (MOSS 1980). The argument in favour of supplementing national account aggregates by sets of physical, chemical, biological and other indicators was already put forward by authors such as HERFINDAHL and KNEESE (1973) and DRECHSLER (1976). Even the publication of open-ended presentations (as proposed in the UNITED NATIONS study of 1977) of all kinds of data should be encouraged, as long as a link to the central system can be established. The integration of physical data (which is always to some extent incomplete) into the Draft SEEA (UNITED NATIONS 1990) is already an important step in this direction.

Generally speaking such well elaborated systems as the Draft SEEA (UNITED NATIONS 1990) or the Austrian system (FRANZ 1988) include so many extremely valuable elements that they should not be restricted to produce one single overall indicator. Indeed, they rather should be extended to provide a number of interlinked data systems which comprise information of different nature which are designed to serve different analytical needs. A variety of such analytical tools could be of significant help for the well informed policy maker who is aware of the multi-dimensional character of environment/economic interrelationships.

7. REFERENCES

- ADLER Hans (1982)  
Selected Problems of Welfare and Production in the National Accounts; The Review of Income and Wealth 2/1982
- AL Pieter, VAN BOCHOVE Cornelis (1988)  
A Synoptic Structure of the System of National Accounts  
The Review of Income and Wealth 1/1988
- BARTELMUS Peter (1987)  
Accounting for Sustainable Development  
UNITED NATIONS, Department of International Economic and Social Affairs, Working paper No 8, New York 1987
- BARTELMUS Peter (1989)  
Environmental Accounting and the System of National Accounts; in AHMAD Yusuf, EL SERAFY Salah, LUTZ Ernst (eds.): Environmental Accounting for Sustainable Development, Washington D.C. 1989
- BLADES Derek (1989)  
Measuring Pollution within the Framework of the National Accounts; in AHMAD Yusuf, EL SERAFY Salah, LUTZ Ernst (eds.): Environmental Accounting for Sustainable Development, Washington D.C. 1989
- DALY Herman (1989)  
Towards a Measure of Sustainable Social Net National Product; in: AHMAD Yusuf, EL SERAFY Salah, LUTZ Ernst (eds.): Environmental Accounting for Sustainable Development, Washington D.C. 1989
- DRECHSLER Laszlo (1976)  
Problems of Recording Environmental Phenomena in National Accounting Aggregates; The Review of Income and Wealth 3/1976
- EL SERAFY Salah (1989)  
The Proper Calculation of Income from Depletable Natural Resources; in: AHMAD Yusuf, EL SERAFY Salah, LUTZ Ernst (eds.): Environmental Accounting for Sustainable Development, Washington D.C. 1989
- FRANZ Alfred (1988)  
Grundzüge einer ökologischen Gesamtrechnung für Österreich; in: Österreichisches Statistisches Zentralamt: Österreichs Volkseinkommen 1987, Wien 1988
- HARRSION Anne (1989a)  
Introducing Natural Capital into the SNA; in: AHMAD Yusuf, EL SERAFY Salah, LUTZ Ernst (eds.): Environmental Accounting for Sustainable Development, Washington D.C. 1989
- HARRSION Anne (1989b)  
Environmental Issues and the SNA  
The Review of Income and Wealth 4/1989

HARRISON Anne (1990)

Major Changes Proposed for the Next SNA: An Overview  
The Review in Income and Wealth, 4/1990

HERFINDAHL Orris, KNEESE Allen (1973)

Measuring Social and Economic Change: Benefits and Costs of Environmental Pollution, in: MOSS Milton (ed.): The Measurement of Economic and Social Performance, New York 1973

HICKS John (1946)

Value and Capital, Oxford 1946

HOLUB Hans Werner (1981)

Some Reflections on a Universal System of National Accounting  
The Review of Income and Wealth 3/1981

HOLUB Hans Werner (1983)

Some Critical Reflections on Measures of Net Economic Welfare  
The Review of Income and Wealth 3/1983

HUETING Roefie (1989)

Correcting National Income for Environmental Losses: Toward a Practical Solution; in AHMAD Yusuf, EL SERAFY Salah, LUTZ Ernst (eds.): Environmental Accounting for Sustainable Development  
Washington D.C. 1989

MARIN A. (1978)

National Income, Welfare, and the Environment  
The Review of Income and Wealth 4/1978

MOSS Milton (1980)

Social Challenges to Economic Accounting and Economic Challenges to Social Accounting; The Review of Income and Wealth 1/1980

NORGAARD Richard (1989)

Linkages between Environmental and National Income Accounts  
AHMAD Yusuf, EL SERAFY Salah, LUTZ Ernst (eds.): Environmental Accounting for Sustainable Development, Washington D.C. 1989

PESKIN Henry (1989)

A Proposed Environmental Accounts Framework; in: AHMAD Yusuf, EL SERAFY Salah, LUTZ Ernst (eds.): Environmental Accounting for Sustainable Development, Washington D.C. 1989

POSTNER Harry (1986)

Microbusiness Accounting and Macroeconomic Accounting: The Limits to Consistency, The Review of Income and Wealth 3/1986

RAINER Norbert (1989)

Descriptive versus Analytical Make-Use Systems; Some Austrian Experiences; in: MILLER Ronald, POLENSKE Karen, ROSE Adam (eds.): Frontiers of Input-Output Analysis, New York, Oxford 1989

RAINER Norbert, RICHTER Josef (1989)

The SNA Make-Use Framework as a Descriptive Basis for IO Analysis; in FRANZ Alfred, RAINER Norbert (Hrsg.): Compilation of Input-Output Data, Wien 1989

- REICH Utz-Peter (1986)  
Treatment of trade and valuation of flows in input-output tables;  
in FRANZ Alfred, RAINER Norbert (Hrsg.): Problems of Compilation  
of Input-Output Tables, Wien 1986
- RICHTER Josef (1987)  
Nettowohlfahrtsmaß - eine Alternative zur herkömmlichen  
Volkseinkommensrechnung?; in : Österreichisches Statistisches  
Zentralamt: Österreichs Volkseinkommen 1986, Wien 1987
- ROMANS Thomas (1977)  
Welfare Economics and the Measurement of the NNP  
The Review of Income and Wealth 3/1977
- RUGGLES Richard (1990)  
A Note on the Revision of the United Nations System of National  
Accounts; The Review in Income and Wealth 4/1990
- SCHÄFER Dieter, STAHMER Carsten (1990)  
Conceptual Considerations on Satellite Systems  
The Review of Income and Wealth 1990
- STAHMER Carsten (1991)  
Integrierte volkswirtschaftliche und Umweltgesamtrechnung  
Beitrag zum 2. Stuttgarter Input-Output Workshop 1991
- STONE Sir Richard (1986)  
The Accounts of Society, Journal of Applied Econometrics 1/1986
- SUNGA Preetom (1988)  
Conceptual Incongruity in the National Accounts  
The Review of Income and Wealth 4/1988
- UNITED NATIONS (1977)  
The Feasibility of Welfare-Oriented Measures to Supplement the  
National Accounts and Balances: A Technical Report  
Studies in Methods, Series F, No 22, New York 1977
- UNITED NATIONS STATISTICAL OFFICE (1990)  
SNA Handbook in Integrated Environmental and Economic Accounting  
Preliminary Draft of the Part I: General Concepts (SEEA)  
New York 1990
- VAN BOCHOVE C.A., VAN TUINEN H.K. (1986)  
Flexibility in the Next SNA: The Case for an Instrumental Core  
The Review of Income and Wealth 2/1986

# THE NATIONAL ACCOUNTS AND THE ENVIRONMENT

BENT THAGE

Danmarks Statistik<sup>1</sup>

## 1. PURPOSE AND STRUCTURE OF THE NATIONAL ACCOUNTS

The national accounts have been established with the object of providing an overall picture of the economy within the framework of a coherent system. They show how income, which is generated as a result of a production process, is distributed and redistributed, prior to resulting in demands for commodities and services for consumption and investment. The system also makes it possible to describe the financial transactions linked hereto, as well as the stocks of real and financial assets and liabilities which exist at the beginning and end of the period, respectively.

The main structure of the national accounts is presented in figure 1. It will be noted that there are two main groups of flows in the system. These concern on the one hand production and income and on the other hand accumulation. The latter transactions show the changes in stocks from opening to closing balance.

---

<sup>1</sup>This paper was originally prepared by the author for a Danish government report: "Statistical analysis of economic activity and the environment". The main report, which was published in October 1990, is in Danish only, but an English summary is available.

It is only the underlined parts of the system that are fully implemented in Denmark, i.e. the flow accounts which lead to the central concept, net lending of the nation. The net lending shows how much each sector and the nation as a whole, through current transactions, have improved or deteriorated their financial balance. As outlined in figure 1, net lending can also be obtained on the basis of the financial transactions.

The present Danish national accounts system is based on United Nations' "A System of National Accounts", SNA, from 1968. Although this system, in principle, comprises the whole structure as shown in figure 1, it is only the contents in the inner frame that are fully specified.

**Figure 1. The Main Structure of the National Accounts**

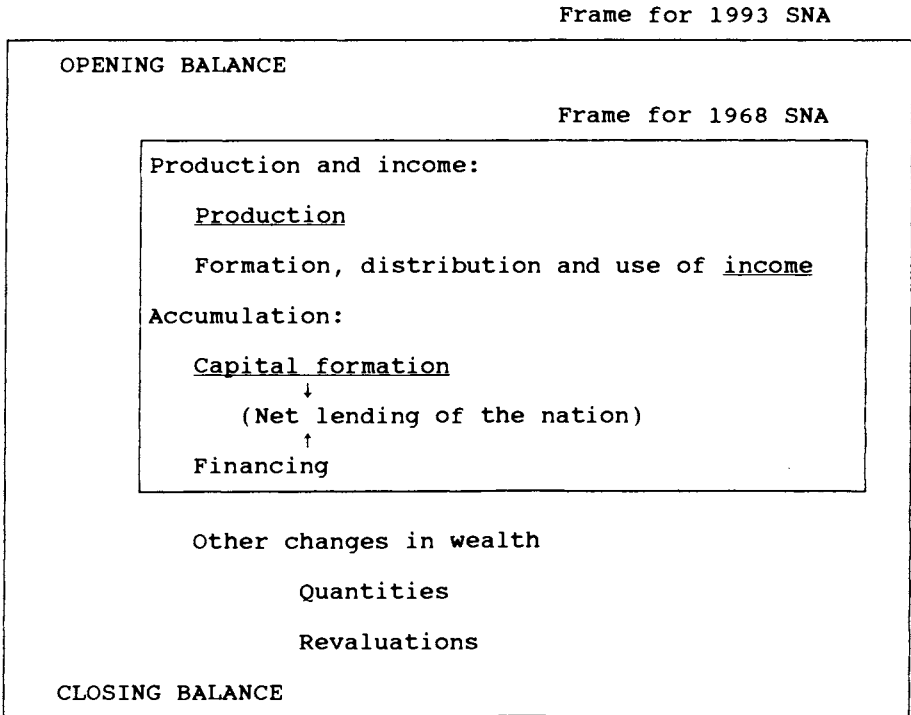

Note: The underlined parts have been implemented in the Danish national accounts.

During recent years, work has been carried out on a revised version of the SNA, which is expected to be approved by the Statistical Commission of the United Nations in the beginning of 1993, cf. the draft version UN (1990c). One of the most important innovations will be a full specification of the part of the system concerning "other changes in wealth" and the balance accounts hitherto only outlined. The emphasis on the combined contents of the system will then be shifted somewhat from flow items to stock items. The scope of the system's production and income concepts etc. is only expected to be subject to minor modifications of a mainly technical character.

At present, it is not possible to say when the revised SNA will be implemented internationally or in Denmark. But the planned extensions will require considerable work, including the field of primary statistics, and it can be mentioned that no country has yet implemented a consistent version of the complete system, although some countries have carried out work on this for many years, more or less on basis of UN (1977b). In practice, it must therefore be expected that it will be a long time before the new system is generally applied. As a step in this direction, Danmarks Statistik is now working on the first official estimates of the real capital stock by industry.

The national accounts figures are primarily compiled with a view to providing data for the assessment of structural and cyclical trends in the economy. In principle, this restricts the accounts to include the economic phenomena (flows and stocks), which have an observable economic value. For goods and services this normally implies using a value determined by the market or a value, which is defined in relation to the ruling price on an adjacent market (for example, owner-occupied dwellings priced as similar rented dwellings or the production of government services, which are calculated as the market value of the resources used). As regards the remaining transactions (distribution of income etc.) the market aspect is less predominant, and it should be stressed that the national accounts, as it also

appears from figure 1, have other purposes than those which relate to the compilation of the production and gross domestic product (GDP).

## 2. THE NATIONAL ACCOUNTS AND WELFARE

In its most detailed form, a well-developed system of national accounts contains thousands of data, which within the definitional framework of the system shows the economic value of the transactions between the units (enterprises, households, the public sector etc.) making the economic decisions. It is this comprehensive description of the economic transactions, which constitutes the actual contents of the national accounts and which determines its value in connection with economic analyses.

Unlike the accounts of a private enterprise, the national accounts do not show a result or surplus, which can be indicated by a single figure, and which has extensive consequences for the future of the enterprise, including its very existence.

Nevertheless, in the public debate the gross domestic product (GDP) is frequently presented as almost synonymous with the national accounts, and has also been attributed a normative interpretation to the effect that an increase is "a good thing" and a decrease is "a bad thing". However, in the structure of the national accounts system and the definitional scope, there is nothing indicating that the GDP concept has to play such a central role, nor that it should constitute the result of the national accounts. On the contrary, it would be possible to construct the whole national accounts without necessarily having to define the GDP and the other aggregated concepts.

The decisive reasons why the GDP cannot be considered as the result of the national accounts or the economy are that the GDP is *highly dependent on the scope of the production concept*, which it has been considered appropriate to employ in the national accounts, and on the manner in which the dividing line between



intermediate consumption and final uses has been determined. These dividing lines have been drawn on the basis of an overall assessment of the purposes of the system, statistical feasibility and an ultimate logical coherence. In the light of the above-mentioned considerations concerning the character of the GDP, it is obvious that an even more extensive interpretation of the GDP as a measurement of the social welfare or the economic welfare has no foundation, nor is in any way incorporated in, or intended by, the national accounts system (cf. also the draft SNA, chapter 1, UN (1990c)). The attachment to the actual transactions means that the conceptualization of the national accounts is mostly based on elementary common sense, where e.g. the income and consumption concepts correspond reasonably well to the everyday meaning of the concepts. The national accounts deliberately abstain from including a variety of factors, which in many ways undoubtedly have a decisive influence on social or personal welfare. This is true of, for example, health, mortality, unemployment, criminality, political freedom, illiteracy etc. and many environment related factors.

The popular view of the GDP as the economic result or as an expression of the economic welfare takes as a starting point highly simplified economic theories or the notion that it should be statistically possible to aggregate all economically relevant factors into a single figure. In the political debate as well as in the summary international comparisons there is probably an inducement to seek such a single measurement as indicator of a country's level of prosperity. And although nobody will deny that the GDP is an important indicator, it is only one among many others, and the international system of national accounts is not based on a one-dimensional notion of the problems of economic and social measurement. The construction of the so-called "human development index" based on life expectancy at birth, adult literacy rate and real GDP (PPP) per capita, in UN (1990a) is also an interesting contribution to this debate.

### 3. CRITICISM OF THE NATIONAL ACCOUNTS

As mentioned, the national accounts cover, as a general rule, only the actual economic transactions. The production values are thus compiled on the basis of the ruling market prices, whereas the non-market production, primarily government services, is compiled on the basis of market values of the resources used. As owner-occupied dwellings do not enter into private consumption in the period during which they were constructed owing to practical and analytical considerations, they are treated as if the owner were a self-employed person, and rents are imputed on the basis of the rent charged for similar rental property. The construction of new owner-occupied dwellings thus becomes part of the gross fixed capital formation in the same way as the construction of rental property.

Intermediate consumption is also compiled on the basis of market prices, and this also applies, in principle, to the costs involved in the consumption of fixed capital (depreciation). As the different vintages of capital goods are not currently sold on a market, and there are no available statistics relating hereto, this item must be estimated by combining the historical acquisition values with price developments and expected life, and depreciation profiles in a model of calculation. The estimated consumption of fixed capital is subject to great uncertainty, and this is the reason why the gross concepts, including the GDP, are also used in contexts where the net concepts would be more relevant, e.g. in respect of compilations of value added by industry.

The popular and/or political criticism of the national accounts over the years has been particularly concentrated on the scope of the production concept owing to the circumstance that the gross domestic product is considered by many as a measurement of welfare. The critics have not surprisingly found out that the GDP, in this respect, was inadequate. It has been argued that the production values of a range of activities performed by the households should be imputed, such as household work, "do-it-

yourself" activities, and the value of leisure time. Similarly, it has also been argued that deductions should be made for commuting to and from work and other "regrettable necessities", such as health expenditure, the police and the military, environment related additional costs and/or inconveniences etc. Such "corrected" national products have actually been estimated for some countries (cf. summaries in UN (1977a)), but as the contents of the imputed values predominate, the results are widely dependent on the chosen principles of valuation, and it is generally difficult to say how these results are to be interpreted. Also, it is not at all obvious that the currency unit is the relevant unit of measurement of welfare, and as previously stated, the conceptualization of the national accounts has not been made with a view to conducting measurements of welfare.

In connection with the debate about the environment, criticism of the national accounts has concentrated on the more environment related aspects of the above-mentioned arguments. The main argument is that by introducing some additional "costs" in the national accounts it would be possible to arrive at a domestic product concept, which is more relevant as regards welfare and at the same time can be interpreted as a "sustainable" income concept in the technical Hicksian sense: Income is what can be consumed during the period without reducing one's wealth - a definition, which in this form reduces itself to a "common sense" consideration, which was already clearly expressed by Adam Smith, (cf. Milot et al.(1989)).

The three following areas have especially played a part in the discussion about a change in the present national accounts system towards a "greener" system:

1. *Depletion of non-renewable resources, which are extracted on a commercial basis;*
2. *"Defensive" expenditure with a view to preventing or repairing environment related damage;*
3. *Reduction of the environmental quality as a result of economic activity.*

The first two areas relate to market transactions, and are therefore already included in the national accounts, but a

different treatment is suggested. The third area is not included in the present scope of the national accounts.

Re. 1. Extraction of non-renewable resources (e.g. oil and gas) is now included in the gross output at their full market value, when they are extracted, and the corresponding intermediate consumption consists of the actual expenditure for extraction and exploration. The consumption of fixed capital in the mining activity relates exclusively to the produced capital in the form of oil rigs etc. The value of newly discovered resources as well as the decrease in value of the resources because of extraction is entered under the quantity item of "other changes in wealth" (draft revised SNA), and has thus no immediate consequences for either the GDP or the NDP. In this respect, the critics argue that the decrease in value which corresponds to the extraction should be moved "upwards" in the system, either as depreciation or reductions in stocks, whereas arguments relating to new discoveries are more vague.

Re. 2. Since it is assumed that it is possible to identify the current expenditures which the industries, the public sector or the household effect in order to prevent or redress the environment related damage, it is argued that as the expenditure of the industries has already been excluded from the GDP by the deduction of intermediate consumption, it would be consistent also to exclude similar expenditure effected by the public sector or the households from the GDP, which could be done by deducting these expenditures as a lump-sum from the GDP.

Re. 3. The "uncompensated" deterioration of the depletable natural resources (forests, fish stocks) and of the natural environment (land, air and water), which is caused by economic activity in industries, public sector and households, is not immediately covered by the national accounts. Here, the critics argue that these deteriorations should be valued and deducted from the GDP ( or rather: the NDP) as an expression of the costs involved in the use of the natural capital.

These proposals are summarized in figure 2.

**Figure 2. Derivation of sustainable national income**

	GDP (the SNA definition)
-	Consumption of reproducible fixed capital
-	Consumption of non-renewable natural resources
-	Environmental deterioration caused by production
-----	
=	Environment adjusted net domestic product (EDP)
-	environment related expenditures actually paid by the public sector and the households
-	Environmental deterioration as a result of consumption
-----	
=	Environment adjusted net income (ENI)

It is noted that apart from the environment related expenditure actually paid by the public sector and the households the corrections relate to new types of consumption of capital. The corrections made prior to the environment corrected concepts are based on a modified and extended scope and treatment of the capital concept, as it has been proposed to treat natural capital - whether it has a market value or not - in the same way as produced fixed capital. "The green national accounts" can be considered as a joint designation for the whole complex of problems which corrections of the above-mentioned type give rise to. The expression "sustainable GDP", which is frequently heard in the debate, will not be used here, as it would, in any case, be illogical to operate with a concept, where only the consumption of *natural capital*, but not the consumption of *man-made capital*, is deducted.

In the following the three areas of criticism will be dealt with one by one:

#### **4. ENVIRONMENT RELATED EXPENDITURE ACTUALLY PAID BY GOVERNMENT AND HOUSEHOLDS**

As mentioned above, the argument in favour of deduction of this kind of expenditures is that "matters must be put in order", which is claimed not to be the case at present, as such expenditures are included in the GDP if they are effected by the public sector or the households, but not when they are effected

by the industries. Another reason why this "order" must be made by means of a deduction is that this type of expenditure does not contribute towards prosperity, but falls under the category of "regrettable necessities". There are many conceptual problems attached to the above argument as well as the proposed entry in the national accounts.

Firstly, a distinction has to be made between an alternative bookkeeping for a past period and the effects of an alternative financing of environment related expenditure. Only in the first case can something definite be said as to the influence on the GDP. If an amount, which was originally entered as a public (non-market) environmental cost, instead were entered as paid by an artificial market industry (and the direct wage content were equal to zero), the GDP will be reduced with this amount. On the other hand, if it is decided that some environmental expenditures, previously paid by the public sector, in the future have to be paid by the industries, it cannot then be concluded that the GDP will be reduced. If, for example, it is possible for the industries to fully shift forward the increase in costs to prices, the GDP at current prices will remain unchanged. A distinction has to be made between book-keeping and model, and seen from an economic point of view all types of costs will ultimately be borne by the final users.

Secondly, it is important to distinguish between discussion of levels and discussion of growth rates. For a great deal of the reference to sustainability, it is unclear whether a sustainable level is meant, or whether it is possible to have a growth rate that can be termed sustainable.

Without going into any details about the complicated technical problems in connection with the constant price calculations in the national accounts, it can be mentioned that the real GDP, in both cases outlined above, will be smaller than that in the alternative situation. In a situation, where the environment related expenditure increases faster than the economic activity, the growth measured can thus be influenced by the institutional

conditions relating to the financing of the expenditure. Although this may call for a special treatment of certain types of expenditure, it will, however, be difficult to justify such an adjustment for the environment related expenditure only.

Thirdly, there are major conceptual difficulties in incorporating such a deduction in the overall national accounts system, as an artificial production sector has to be set up, to which the deduction is allocated as input, and - as it has no output - will end up with a correspondingly negative value added. The construction will contravene the basic distinction of the national accounts between intermediate consumption and final use. The intermediate consumption is deducted in the calculation of the GDP, not because it is something that is unwanted or deplorable, but because it constitutes an input in a production process, whose output will ultimately be sold to a final consumer. Moreover, it must be decided to which institutional sector the artificial sector has to be allocated, as otherwise the national accounts cannot be balanced.

In this connection another argument can be mentioned, which has played a certain part in the environment inspired criticism of the national accounts. The national accounts are claimed to function in an inexpedient manner, because the production, which the environment related cleaning-up activities cause, increases the GDP. Again it is necessary to distinguish between book-keeping and model. The resources used for clearing-up, must be transferred from another activity, as it must realistically be assumed that the *overall degree of employment* in the society is *not determined by the environmental policy*. When more resources are allocated for the cleaning-up, the society as a whole becomes less productive than would otherwise have been the case. Even in the extreme case where the public sector accounts for the total increase in the cleaning-up activity, the GDP will, at best, not be affected, while private consumption will increase more slowly. Consequently, the national accounts will not react in an abnormal manner to an increase in the environment related expenditure.

## 5. NON-RENEWABLE RESOURCES EXTRACTED ON A COMMERCIAL BASIS

As mentioned, depletable natural resources (minerals, oil and gas), which are extracted, are within the scope of the national accounts, and should be entered in the balance sheet account as assets. There is thus no doubt that these assets, which will normally have a positive market value, are covered by the national accounts. The main question is how the entry of changes in the quantity and value of the resources are to be effected, as there has to be coherence in the national accounts regarding the book-keeping between the value at the beginning of the period (estimated at prices at beginning of the period) and the closing value (estimated at prices at end of the period) for each item in the balance account.

Changes in the balance sheet items can (financial items are here excluded) be attributable to real changes or price changes. The real changes can again consist of either reproducible or non-reproducible capital. It is an important principle in the SNA that *capital gains or losses should not affect the production and income concepts*, and in the present as well as in the future SNA, quantity changes in non-reproducible capital are treated as capital gains or losses, which through entries in the account for "other changes in wealth" affect the balance sheet, but not the flow items in the system.

The value of a *depletable natural resource* (in the following named "reserves") is linked together from opening to closing balance as shown in *figure 3*, cf. OECD (1985).

The values stated at the beginning and end of the period are the market prices for the reserves in question, excluding all forms of produced capital goods, such as production platforms and oil rigs, shafts etc. It is, in other words, *the price for the knowledge of the existence of a reserve, and the right to use it according to further specified rules concerning royalties, taxation, environmental demands, speed of extraction etc.* As mines and oil wells are not currently sold under such conditions,



the value is somewhat abstract, and it would not normally be possible to obtain information from the mining companies about the value.

**Figure 3. Relationship between opening and closing stock**

1. Value of proven reserves at beginning of period (prices at beginning of period)
2. plus      New discoveries during the year (prices at beginning of period)
3. plus      Already known reserves, the use of which have become economical, because during the year the following has occurred (prices at beginning of period):
  - (a) improvements in the technique of extraction
  - (b) changes in the economic conditions
4. minus     Proven reserves, which have become uneconomical due to changes in the economic conditions (prices at beginning of period)
5. minus     Extraction during the year (prices at beginning of period)
6. plus      Revaluations from prices at beginning of period to end of period (positive or negative)
7. Value of proven reserves at end of period (prices at end of period)

From a theoretical point of view the present-day value of a capital asset is equal to the discounted value of the future (expected) net yield. As the reserve can only be exploited in connection with the use of produced capital goods, the net yield of the deposit in each period can only be estimated if a "normal profit" is allocated a priori to the produced capital, a profit, which presumably on account of the risky character of mining must be set comparatively high. In practice, the procedure should therefore be to deduct from the net operating surplus (as defined in the national accounts) of the industry (the mining company) the above-mentioned normal profit of the produced capital goods in order to arrive at the net yield of the reserve for each period. When this net yield is divided by the extracted quantity of minerals, the price for each physical unit is arrived at for

the period in question. By discounting the estimated net yield (expected) for the life of the whole deposit an estimate of the value of the deposit at the beginning and the end of the period can be made. It goes without saying that such an estimate must, by all means, be made under highly simplified assumptions, and that the result will be considerably influenced by the "normal profit rate" used, by price expectations, by the chosen discount rate, and by the expected rate of extraction.

It must be noted that while an actually recorded market price for a deposit (if this were possible) would be affected by the rules concerning payment of royalties, corporation taxation etc., then the theoretical method, which has been outlined for calculation of the value of the deposit on the basis of the future net yield, is not so affected. The reason is that the starting point in the latter case is here taken in the net operating surplus of the national accounts, which is compiled prior to payment of royalties and taxes. The latter method will therefore lead to a higher value than the former for the deposit as a whole. If royalties and other types of taxes are sufficiently high, the actual market price for the deposit will be close to zero, whereas the national accounts-oriented estimate will show a kind of social market value for the deposit. It is by no means clear how this dilemma is to be treated. At first sight, the actual market price (seen from the mining company's point of view) is the theoretically correct one, as normally the hypothetical value of wealth, in the absence of the existing taxation, will not be estimated in the national accounts. But the extreme case constitutes a taxation, which involves a de facto expropriation, and thereafter the mining company can be considered to operate on a state-owned deposit.

In order to illustrate the problems, which will be linked to the redefinition of real changes of the depletable resources from capital gains/losses to current flows in the production and income accounts of the system, some of the proposals put forward during recent years will be briefly discussed.

OECD (1985) outlines a system, where all entries connecting the value of the deposit at the beginning and the end of the period, cf. figure 3, apart from the revaluation because of price changes, are recorded in the production in the national accounts. New discoveries as well as already known reserves, which become economical due to technical or economic changes, become part of gross output and of gross fixed capital formation (own-account capital formation). Here, it is argued that it is nature which has created the deposit, but it is the exploration activity, which has given it economic existence, and can therefore be considered as producer in an economic sense. The counterpart is that the value of the extraction during the year becomes depreciation in the industry engaged in mining activities. The valuation is based on the above-mentioned national accounts principle, as a determination of the actual market prices for each deposit is considered to be out of the question.

There has been general rejection of such a procedure by national accounts statisticians owing to the facts, among others, that it *violates the transaction principle*, that the *extremely unreliable valuation would enter directly into the GDP*, that previously discovered reserves, which again became economical, could hardly be included in a production concept, that there would be great fluctuations in the GDP and thus problems in connection with analytical uses, and that it was not clear how the calculation at constant prices could be made. One of the positive aspects as regards methodology, which was stressed, was the proposal's consistent treatment of increase and decrease of reserves.

A proposal by El Serafy (1989) is, like many other papers on the environmental question from economists in the World Bank, primarily directed at those developing countries which are highly dependent on some few depletable natural resources, and the main point of view is neither resources nor the environment as such, but the possibilities of maintaining income and economic growth in the longer term. This requires that the country during the period in which the depletable natural resource is used, restricts its consumption, so that a basis for future income

either in the form of foreign claims or as investments in alternative domestic productions is laid down.

The proposal first deals with the possibility of depreciating depletable natural resources, for example, according to the same principle as mentioned in the OECD proposal (but excluding the corresponding extension of the production concept). This is not considered expedient because:

(a) If one is of the opinion that the output of mining activities stems from nature, it is not part of the economy's gross production. Consequently, the reduction must be effected in the GDP and not only in the NDP.

(b) Owing to the uncertainty of the estimates of depreciation on produced capital, the NDP in the national accounts is a concept of comparatively little interest, nor is it used internationally. And nobody would pay any attention if a further reduction of this concept was made.

(c) The countries which have marketable natural resources, are actually better off than those which have no such resources. Deducting the whole value of resources (over the years) would place the two categories of countries on an equal footing, and this would not be reasonable.

The conclusion is that as depletable resources are capital assets and as the sales of assets do not generate any value added, such sales should not be included in the GDP (the value is defined as the net yield). But a permanent income flow corresponding to the capitalized present value of (the net yield from) the depletable resource can be estimated. The relationship between the permanent income flow and the net yield depends on the life expectancy of the resource and on the chosen discount rate. The difference between the two is the user costs for the depletable resource.

Other authors (Milot, Teillet and Vanoli (1989)) take a somewhat broader starting point, as they are generally concerned about how

the relationship between the accounts for current transactions and the revaluation account should be designed in the revised SNA. In this connection the treatment of the depletable resources will, however, also play an important part, as it is a basic question where the dividing line between capital gains and losses and income should be drawn. A thorough discussion of Hick's income concept shows (cf. above) that in itself it does not provide much guidance as to the definition of the concepts in the national accounts.

Their starting point concerning the treatment of the depletable resources is that all entries linking the value at the beginning and the end of the period (cf. figure 3) are to be entered as "Other changes in wealth" only, in the national accounts. However, they also realize that the dividing line between this account and the income accounts can hardly be said to be definitely fixed, based on neither theoretical nor practical considerations. Consequently, some of the items from "Other changes in wealth" could be transferred to a kind of *extraordinary income account*. In order to make this meaningful, the item covering revaluation due to price changes must be divided into an effect of change in the general price level and an effect of change in relative prices, as only the latter has given rise to real capital gains or losses. In the treatment outlined above, only the item for the general price increases in the account for "other changes in wealth" remains unchanged, whereas all other items linking values at the beginning or at the end of the period are transferred to a newly established account for extraordinary incomes, whose balance becomes an extraordinary saving. Subsequently, the accounts system is again balanced, but a new concept has been created which makes it possible to get closer to a kind of operationalized Hicksian income definition. On the other hand, no suggestions are made for transferring the entries concerning the depletable resources to the production account.

Summing up the three examples, they show that the notion that one can just "depreciate" the depletable natural resources in the production account, concurrently with their extraction, without

considering how these resources have been included in the economy (have been given economic existence), is untenable when seen from a theoretical as well as a systematic point of view. It also appears that the problems concerning valuation cannot easily be solved.

## 6. TREATMENT OF "FREE" ENVIRONMENTAL CAPITAL

In this section environmental capital will be restricted to include that part of tangible capital which is not immediately controlled or used by people in an economic function. This means that it does not include the reproducible fixed capital, nor the already mentioned non-renewable resources which are commercially exploited. Both types of capital will normally have a positive market price, and will therefore have "economic existence" in the sense of the national accounts. Contrary to this, the environmental capital will be characterized as a free asset in the sense that it can be used, and it might be deteriorated without paying for this. Although environmental capital may have economic functions, such as receiving waste from the economic activity, it does not, for that reason, become an economic asset in itself.

An economic characteristic of environmental capital is that it has no market price, and to the extent that economic activity in the form of production or consumption deteriorates it, this will not directly affect the costs involved in the activity concerned. These so-called "external effects" are thoroughly described in economic theory, and to the extent that such effects are socially undesirable, the solution is that a social price in the form of an indirect tax is charged on them. However, in this section the question is whether a *hypothetical price* can be introduced for the function of the environmental capital, and the corresponding hypothetical expenditure thereafter entered in the national accounts together with data based on actual market prices and market-related values.

If we consider depreciation in this context, the value which is

estimated for the "consumption" of the environmental capital during a period has, in principle, to be equal to the (*hypothetical market-determined*) cost, which would be necessary in order to *maintain* the environmental capital on the same level at the end of the period, as it had at the beginning of the period. As regards the sustainable income argument, an amount has to be set aside for any *future re-establishing* of the environment - an amount, which is therefore not available for consumption in the period in question. But again it is important to note that only hypothetical costs are considered. If (all) costs were actually paid for, there would be no environmental deterioration to depreciate, and we would be back in the earlier discussion of treatment of the actual environment related expenditure.

The economic basis for aggregating the value of the individual commodities and services in the national accounts is that prices are *generally determined by the market*. This means that the prices are rooted in marginal scarcities and utilities, and that substitution can be made on the margin. When a set of hypothetical values which have not played any part in the decision-making process, are entered in this system, the *additivity condition no longer applies as a matter of principle*. However, the above suggestion implicitly postulates that this aggregation as well as the *substitution condition* are still valid. The latter in particular may seem paradoxical, as the concern for the environment, which is the suggestion behind the proposals of the suggestion, is based on the assumption that there are no longer such possibilities of substitution between produced assets and environmental capital, and perhaps not even between individual types of environmental capital.

A direct consequence of the introduction of a set of hypothetical costs in the form of "consumption" of environmental capital in the national accounts is that the surplus of each industry (net operating surplus) will be reduced and could for some industries even be negative. According to the usual interpretation of these figures, it is implied that there are now considerable differences in the profitability between the industries, and some of them

ought to discontinue production. The reason why, in practice, they survive is that they profit by a "capital gain" from the environment. However, such an interpretation is untenable. The real situation is that by introducing the hypothetical costs, we have moved from the accounting sphere of the national accounts to *model calculations*, of which only the first step has been effected. The usual procedure in connection with model calculations is to introduce an exogenous (hypothetical) change, and thereafter trace the consequences that are caused by it. In the present case this would require a new set of output prices, which contained the hypothetical costs, to be calculated, and thus a *new (hypothetical) system of national accounts*, which could describe a potentially viable economic situation. The result would, of course, depend on the type of model used, but an input-output model would be an obvious possibility. It is clear that by such a procedure we have moved far away from summary corrections to existing national accounts figures.

After these more formal considerations the question is whether it is, in practice, possible to establish a statistical basis for environment related depreciations. First, it is necessary to know the *exact relationship between economic activity and the surrounding environment*, as otherwise it is not possible to estimate the physical consumption of environmental capital. Secondly, cost calculations must be possible for the initiatives which are necessary in order to restore the environment to the initial position (at the beginning of the year).

The standard approaches which are usually quoted on the valuation of items which are not marketed are (a) *avoidance costs*, (b) *opportunity costs* and (c) *willingness to pay*. These principles, which are already well known from the field of cost benefit analysis, will not be discussed here. Readers are referred to OECD (1989), which covers both theoretical aspect and examples of practical applications. For the latter the extreme uncertainty is illustrated. (In the Report Danmarks Statistik (1990) there is a separate chapter on this subject).



It appears that there is still a long way before it is possible to describe such relations and economic consequences for the society as a whole even tentatively. Here, the problem is not only the shortage of statistics, but also the difficulties in *determining what the environment can "absorb"* in the short and long term. To this is added areas such as the green house effect and the destruction of the ozone layer, where there is not only great uncertainty as to the effects and their time perspective, but where the repair (and thus the hypothetical environmental cost) will consist of avoiding some of the activities causing the damage in question. Generally, the calculations of the above-mentioned types will contain considerable elements of arbitrariness due to the incomplete scientific knowledge in the ecological field.

#### CONCLUDING REMARKS

This paper has shown that there are considerable difficulties of a statistical character and as regards the concepts involved in "correcting" the present national accounts system with a number of environment related (and primarily non-market) factors. It is argued that it is by no means a simple matter, and hardly desirable, to establish a "greener" national accounts system, which, among other things, could form the basis of the calculation of "sustainable income" or "sustainable growth".

The conceptual problems arise because many of the modifications and extensions that are proposed by the critics of the present system of national accounts break with some of the fundamental prerequisites for the national accounts as a closed system describing a market economy's actual mode of function. To this is added that by introducing the proposed deductions the national accounts would be arbitrarily and partially converted in a normative direction, partly as a measurement of welfare, partly as a system where long-term objectives for the society are

incorporated in central variables characterized by "sustainability". The difficulties involved in valuing environmental resources which have no market price are obvious, but there are also considerable problems as regards e.g. non-renewable resources exploited commercially.

Although the revised SNA which will be ready by 1993, will be more stock-oriented than the present system of national accounts, and thus provide a greater scope for interaction with the environmental statistics which are particularly concerned with stocks, this would not in itself solve the above-mentioned problems. Acknowledging this the United Nations Statistical Office, in connection with the preparation of the revised SNA is also developing a special satellite system for environmental accounts in conjunction with the national accounts. [Cf. UN (1990b), which was, however, only partly available, when this paper was originally drafted].

**REFERENCES**

Danmarks Statistik (1990)

Økonomi og miljø i statistisk belysning ("Statistical analysis of economic activity and the environment". Summary in English available).

El Serafy, S. (1989)

"The proper calculation of income from depletable natural resources". In: Ahmad, Y.J. et al. (ed.), Environmental accounting for sustainable development. World Bank, Washington D.C.  
Betænkning nr. 1210, Copenhagen

Milot, Jean-Paul, Pierre Teillet and André Vanoli (1989)

How to treat non-produced assets and exceptional events in the national accounts? Consideration of variations in the wealth accounts. Rev. of Income and Wealth, No 2.

OECD (1985)

"Treatment of mining activities in the system of national accounts". Note by the secretariat to the meeting of national accounts experts 29-31 May. (Doc. DES/NI/85.4), and "Report on the meeting of national accounts experts 29-31 May" (DOC. DES/NI/85.8).

OECD (1989)

Environmental policy benefits: Monetary valuation. Paris.

United Nations (1968)

A System of National Accounts. New York.

United Nations (1977a)

The feasibility of welfare oriented measures to supplement the national accounts and balances: A technical report. New York.

United Nations (1977b)

Provisional international guidelines on the national and sectoral balance-sheet and reconciliation accounts of the system of national accounts. New York.

United Nations Development Programmes (1990a)

Human development report 1990. Oxford University Press.

United Nations (1990b)

SNA handbook on integrated environmental and economic accounting. Preliminary draft of the part I: General concept. New York.

United Nations (1990c)

Revised System of national accounts: Draft chapters and annexes. New York.

# **"ECO DOMESTIC PRODUCT": THE ANSWER TO WHICH QUESTION?**

**Karine Nyborg**

**Central Bureau of Statistics, Norway**

## **1. INTRODUCTION**

The Statistical Office of the United Nations (UNSO) has recently published a draft of a System of Integrated Environmental and Economic Accounting (SEEA) (UNSO, (1990)). The proposed system is based on a framework for resource accounts in physical units. However, UNSO also suggests imputing monetary values on the depletion and degradation of natural resources and environmental goods, and introduces the concept of "Eco Domestic Product" (EDP); an environmentally adjusted measure of net domestic product. The valuation procedure suggested by UNSO is to estimate "the costs which would have been necessary to keep the natural capital intact" (UNSO (1990), page 123).

In this paper I will address some of the difficulties connected to the valuation of environmental goods. My main objective is to show that the concept of EDP is rather ambiguous, and that clarification of this is needed to avoid confusion in the further debate<sup>1</sup>.

The following remarks concern particularly the valuation of those goods which are not bought and sold in markets. The treatment in national accounts of natural resources which can be

---

<sup>1</sup> My acknowledgements to Asbjørn Aaheim, whose cooperation has been very helpful.

valued at market prices, such as fish, oil and timber, will not be discussed in this paper.

## 2. THE PURPOSE OF AN "ECO DOMESTIC PRODUCT"

The aim of the proposed concept of "Eco Domestic Product" does not seem entirely clear. One can imagine at least three different questions, to which the answers are probably not at all identical:

- 1) One wishes to correct NDP (Net Domestic Product) for environmental degradation to *improve NDP as a welfare measure*.
- 2) One wishes to establish *to what degree current economic activity could have prevailed if the environmental standard were not allowed to deteriorate* during the accounting period.
- 3) One wishes to correct NDP for *the costs of restoring observed deterioration of the environment* during the accounting period.

All three issues above are referred to by various participants in the debate on "green GDP", but it is rarely specified which of them one has in mind. This seems to create quite a lot of confusion. In general, none of the three can be regarded as approximations to one another. I do not intend to suggest that one of them is more relevant or more interesting than the others; I merely wish to point out that they are essentially different.

The first issue deals with welfare measurements<sup>2</sup>, and the appropriate approach to evaluate environmental goods would then be to estimate marginal benefits of these goods, for instance by willingness to pay-surveys. The second requires an estimate of hypothetical costs of maintaining environmental standards, or to be more specific: The cheapest way of avoiding *or* restoring damages, including the possible closing down of harmful economic activities. When actions to prevent damages are cheaper than actions to repair damages, however, the answers to questions 2) and 3) will differ. Since environmental goods in many cases cannot

---

<sup>2</sup> The term "welfare" is here used according to the principle of consumer sovereignty; that is, one is trying to improve NDP as a measure of the inhabitants' judgement of their own well-being. It is disputed whether NDP should be used as a basis for welfare indicators at all, but I will not go into that issue. See, for instance, Brekke (1991) for details.

be produced by humans, marginal restoration costs can in fact be infinite. Marginal avoidance costs, on the other hand, will in no production sector be greater than the value added of a marginal unit, as damages could have been avoided by closing down production. Hence, 2) and 3) cannot in general be regarded as approximations to each other.

In UNSO (1990) little weight is put upon how to solve the valuation problem in practice. The valuation procedure which is suggested as a main principle leads to an interpretation of EDP close to 2). However, to this author, it is not entirely clear whether UNSO aims at 2) or 3). 1) is not addressed by the EDP proposed by UNSO, though this seems to be the question some of the participants in the debate have in mind.<sup>3</sup>

### 3. THE CONCEPT OF VALUE

Until about 1870, the concept of an object's value was a highly debated issue in economics. Concentrating on the supply side, David Ricardo and several others tried to reveal the factors determining the value of a good. When Menger, Walras and others focused on the interrelationship between demand and supply, the debate condensed to the now well-known view of modern economics: The marginal value of a good is determined by equality between demand and supply. One cannot understand the concept of value solely by looking at the demand or the supply side; it is determined by the interrelationship of the two.

The problem of valuing goods which are not bought and sold in markets, however, brings us right back to the fundamental problem of last century's economists. The classical paradox is still there: Clean air has no price, but still one does not accept that it is without value. But if so, what determines its value?

The concept of shadow prices, determined for example by marginal willingness to pay or by

---

<sup>3</sup> UNSO's definition of "strong sustainability" implies that no substitution is allowed between natural capital and man-made capital. If one accepts this, it seems illogical to try to establish EDP as a welfare measure: As no substitution is allowed, it is of no use to try to balance the welfare effects of the environment and man-made production against each other in one single measure.

costs to supply more of a certain environmental good, may seem to be a reasonable alternative. However, since most environmental goods are not bought and sold in markets, there is no reason to assume that the resource allocation is efficient. With markets lacking, there is no mechanism to ensure the equality between marginal costs and marginal benefits, nor the equality between marginal costs of different ways to supply more of the good. *The valuation of environmental goods thus requires a definition of which shadow price one tries to determine.* Nevertheless, this sometimes seems to be overlooked.

Trying to estimate one single number, which can serve as an approximation of the marginal value in all alternative uses of the good, is in fact only meaningful if one has reason to believe *that the allocation of the good is already close to optimal.* And if so, one of the main reasons for dealing with environmental economics - the belief that the situation is in fact far from optimal - is no longer there.

Imagine, for example, a production plant which emits hazardous gases into the air. People living in the area might be willing to pay a lot to stop the emissions, whereas the hypothetical costs of removing the hazardous components from the emissions may be small. Further, the costs of restoring the previous environmental standard, once the emissions have taken place, might be infinite.

The environmental correction judged from approach 2) above will in this case be small, since the hypothetical cleaning cost was low, even though the damages done to nature by the emissions might have been enormous. From the perspective of 1), the environmental correction ought to be substantial, and in the case of 3), even infinite.

One implication of this is the following: If one employs an accounting scheme to establish a "green GDP", one should start by deciding what kind of question one wants to answer with this measure. The valuation procedure should then be chosen according to this. If, for instance, one chooses question 2) above, and later on wants an answer to question 1) as well, this will require a whole new set of environmental values, because the latter question corresponds to another set of shadow prices. A "green GDP" established to answer one of the questions above *cannot*, in general, be used to answer another.

The views expressed above also imply that different types of valuation methods, at least to the extent that they reflect different types of marginal values, should not be mixed when figures are aggregated. Consequently, *a pragmatic or flexible approach to the valuation problem is not uncontroversial*, as it easily leads to a mix-up of different concepts. Aggregated to the macro level, the interpretation becomes obscure, and the politician will just as easily be misguided as guided.

#### 4. VALUATION OF ENVIRONMENTAL GOODS WITHIN AN ACCOUNTING SYSTEM

##### *A Cost Approach*

Having decided how a "green GDP" should be interpreted, the next problem is how to measure it. UNSO suggests to do this within a national accounting framework. Let us have a look at some possible implications of such approach.

Suppose, now, question 2) is the one we would like to address. Suppose also that our economy can be divided into two sectors, namely A and B. We will define EDP (Eco Domestic Product) in a manner similar to that of UNSO, as net domestic product minus hypothetical costs to keep environmental standards intact within the accounting period. EDP is then defined as

$$EDP = E_A + E_B - N_A - N_B$$

where  $E_i$  is the net product of sector  $i$ , and  $N_i$  is the least cost (hypothetical) of avoiding or restoring environmental degradation caused by sector  $i$ .

Let us now assume that both sectors emit  $CO_2$ , a gas which in practice cannot be cleaned.  $CO_2$  also accumulates in nature, which means that a constant level of emissions is not sufficient to maintain the previous environmental standard - the emissions must stop. Both sectors are able to reduce the emissions at a certain cost, but only sector A is capable of eliminating the



emissions entirely. For sector B, the least cost of maintaining the environmental standard will then be equal to its net product. Hence

$$EDP = E_A + E_B - N_A - E_B = E_A - N_A$$

Sector B has been netted out of EDP, and consequently no contribution from this sector will be contained in EDP. Thus, if emissions from sector B of other hazardous components increased or decreased, or if actual economic activity in this sector changed, this would not have any impact on the level of EDP.

If neither sector A or B were able to stop their CO<sub>2</sub> emissions, EDP would be equal to zero, regardless of all other aspects of environmental standards and the level of economic activity.

This result was obtained because the gas emitted was accumulated in nature, so that a constant level of emissions was not sufficient to maintain current standards. Several substances other than CO<sub>2</sub> have this characteristic too. Regarding substances which do not accumulate, a similar problem arises when it comes to *changes* in EDP during the year: If a firm increased its production during the accounting period, and this could not have been possible without environmental degradation, the environmental correction must be set equal to the increase in net product of that firm.

A lot of firms would not exist if they were not allowed to damage their surroundings to some extent. This does not mean that it is not of interest to monitor their environmental and economic performance. The exclusion of such firms in the EDP measure is, however, the logical consequence of following a valuation procedure like the one UNSO suggests. (This is, at least, the way I interpret UNSO's main valuation principle.)

The result above may seem absurd, but it demonstrates clearly the importance of knowing exactly what one is trying to measure. By choosing question 2), we get an EDP designed to measure *the part of current economic activity which can take place without degrading the environment*. If no economic activity is possible without CO<sub>2</sub> emissions, then the correct answer to our question is, in fact, zero. If, on the other hand, one expects an answer to

question 1) (welfare measurement), the exercise above undoubtedly must appear rather odd.<sup>4</sup>

### ***A Benefit Approach***

To underline further the need for clarification of the concept of "environmental values", I will only very briefly go into the possibility of correcting NDP for the marginal benefits of environmental change, corresponding to question 1) above. One possible valuation procedure would then be willingness to pay-surveys.

There are then two main possibilities:

- \* People are asked what they would be willing to pay to get back to the environmental standard of last year.
- \* People are asked what money compensation they would need to be just as well off as if the environmental degradation had not taken place.

For a poor but nature loving person, the answer of the first of these two questions may be "close to nothing", whereas her response to the second question could at the same time be "boundless, impossible to compensate". We are now supposing that she answers truthfully and that she understands the questions. The answer to the first question is bounded by her budget constraint. The second is not. It is not, however, obvious that one reply is more relevant than the other. If one wants to measure welfare changes, it seems natural to take as a starting point the individual's total welfare in the beginning of the accounting period, not her budget constraint at the end of the period.

Obviously, this goes far beyond the scope of both SNA and SEEA. There are numerous other well-known problems with willingness-to-pay surveys as well, which I will not go into. The

---

<sup>4</sup> Some economists have suggested that politically defined environmental goals can serve as rough indicators of a socially optimal supply level of environmental goods and services. (See Måler, 1991.) The (hypothetical) costs to reach these goals are then suggested as a proxy for the welfare loss of not being at an optimum.

The approach adopted in UNSO (1990) differs from this, because NDP is corrected for costs to keep environmental standards unchanged during the accounting period, and not (in general) costs required to reach an optimum. If the initial situation is not optimal, there is no reason to believe that the costs of maintaining the environmental standards of the previous period will resemble the welfare loss of not doing so.

example above underlines, though, the notion that valuation of non-marketed goods is not only a question of solving a difficult measurement task, but also a case of defining properly *what one is trying to measure*. Choosing a "cost-side" or "demand-side" approach is, actually, not enough; as we have seen from the example above, one has to be more specific than that.

## 5. AN ALTERNATIVE: THE MODELLING APPROACH

As we have seen, it is not difficult to find cases where the environmental correction of NDP, depending on how it is measured, will be far from marginal. This brings us to the question of what happens when hypothetical transactions are accounted for in a system of otherwise real market transactions.<sup>5</sup>

If the economy was really changed in such a manner that the concept of "strong sustainability"<sup>6</sup> was obeyed, a vast reallocation of resources would have to take place. This would produce a society which would differ from the one we know now in many aspects: Polluting activities would cease to be profitable, and labour and capital would move to new expanding sectors, such as production of cleaning equipment. This would lead to changed relative prices.

If the changes required to create a sustainable development are not marginal, the answer to question 2) above clearly cannot be answered by an accounting procedure. The resources needed for cleaning and restoring activities would have to be taken from other activities, thus influencing the whole economy. Increased demand for cleaning equipment, increased cleaning costs for firms and households, and presumably also better health for the workers and less corrosion, could lead to a smaller or larger national product, depending on the economy's ability to cope with the new requirements.

---

<sup>5</sup> The concept of "environmental corrections" is basically different from the treatment of the public sector in the SNA, since the public sector's purchase of input factors are real transactions, whereas e.g. the hypothetical cleaning costs of industrial plants are not.

<sup>6</sup> UNSO (1990) refers to a "strong sustainability" concept which implies "that future generations should receive a natural environment with a quantitative and qualitative level being at least comparable with the present situation" (pp.130-131).

Simply subtracting hypothetical cleaning costs from current NDP ex post is based on a quite illogical assumption; it is like trying to explain how a totally different society will look like, assuming that no substantial reallocation of resources - and thus change of relative prices - will be needed.

The tool most used in economics to answer hypothetical questions like this one is economic modelling. Of course, not all environmental problems can be handled within a macroeconomic modelling framework. The number of issues that can be analysed within a model will also be limited by the data available, and the construction of suitable models, which can handle both environmental and economic matters in a satisfactory manner, is a demanding task. Further, numerous assumptions, on which the results obtained will rely heavily, have to be made. Nevertheless, all these reservations are also true for national accounting procedures.

I will not try to suggest the "best" way of estimating a "green GDP" within a modelling framework. My view is rather that one of the main advantages of using models in addition to accounting schemes, is the model's flexibility in analysing many different questions and providing estimates of several indicators. For instance, one could ask the question of how the economy would look if certain environmental regulations were invoked. Depending on the features of the model, it could provide estimates of various indicators of welfare and/or economic activity; for instance GDP, private consumption, emission levels, employment. In an extended model it should also be possible to obtain indicators of health (at least some aspects of health), income distribution, and various specifications of social welfare . These numbers could be compared to current data, or to model results obtained by assuming another policy.

## 6. CONCLUSIONS

Most environmental goods are not bought and sold in markets. Consequently, there is no mechanism to bring forward the equality between marginal benefit and marginal cost of supplying more of a such good, nor the equality between different ways of supplying the good. Hence, the trouble is not only that the market is not giving any *information* on value,

but also that it does not *function* to create one common marginal value. When evaluating environmental goods by assigning shadow prices to them, it is therefore necessary to specify what aspect of the good one is trying to evaluate. This corresponds to the second-best approach in calculating discount rates, where the alternative use of the resource is essential to the choice of discount rate.

To this author, it is not entirely clear what kind of "value", and for whom, UNSO wants to apply when correcting NDP. The interpretation of an environmentally corrected NDP is completely determined by the choice of valuation procedure, since different procedures will reflect different kinds of marginal values. A too flexible approach to the valuation procedure therefore leads to a "corrected national product" measure which will be very difficult to interpret.

A consistent valuation practice will in some cases lead to seemingly unreasonable results. On closer scrutiny, the results may not be so unreasonable after all: For instance, if one wants to determine how much of current economic activity could have prevailed if environmental standards were not allowed to deteriorate during the accounting period, and the answer to this turns out to be zero, this may well be the correct answer. And if so, we should really be concerned about how to improve modern economy's ability to cooperate with nature, rather than hiding this result behind flexible evaluation procedures that allows us to make more "reasonable" corrections.

An economic development that does not lead to degradation of environmental standards would probably require a vast reallocation of resources. This would influence the whole economy, and could imply a higher or lower net national product.

To determine the degree to which a nation's development is sustainable is an important task, but it is *not an accounting task*. This question can, however, to some extent be analysed within a macroeconomic modelling framework.

The establishment of data bases or accounting systems for environmental data and data on natural resources, measured in physical units, are essential in this context. If they are to be

linked to economic models, such data must be organised with a sectoral structure compatible with the SNA. The part of SEEA which deals with resource accounts in physical units may therefore prove a valuable device in making such data available on an international level.

## REFERENCES

*Aaheim, Asbjørn, and Karine Nyborg (1991):* Grønt BNP: Dårlig svar på godt spørsmål. Sosialøkonomen nr. 5. Oslo.

*Brekke, Kjell Arne (1991):* Net National Product as a Welfare Indicator. Discussion Paper No.65, Central Bureau of Statistics, Oslo.

*Mäler, Karl-Göran (1991):* National Accounts and Environmental Resources. Environmental and Resource Economics 1.

*Statistical Office of the United Nations (1990):* SNA Handbook on Integrated Environmental and Economic Accounting. New York.

# APPLYING THE NOTIONS OF CAPITAL AND INCOME TO NATURAL DEPLETABLE RESOURCES IN ECONOMIC ACCOUNTS

Utz-Peter REICH

Fachhochschule Rheinland-Pfalz

## 1. Note on methodology

Capital and income are concepts of economic theory. That natural resources are depletable is a fact of physical life. In order to manage the latter by means of the first we build national accounts. The problem is that to be viable national accounts have developed their own facts and their own theory, the links of which to the other areas are not well understood. We hear national accounts are based on the transaction principle (Ruggles, N., and Ruggles, R. 1970), but where in economics have definitions of capital and income taken this into account? National accounts operate by means of market values, but how can depletion of a resource ever be reflected adequately by such a mechanism?

In the following, therefore, we will be modest. We will neither claim that the national accounts truly define what an economist would like to have embraced in the concept of capital, nor raise any hope that resources might be saved by means of changing the national accounts. We will simply investigate where and in what way national accounts, which in themselves embody certain concepts of capital and income, deal with the depletion of natural resources.

In doing so we need to employ an idealised vision of the national accounts. As an empirical system the accounts are a complex set of rules, loaded with exceptions, adaptations, re-routings and other tricks. The fact sometimes obscures the structure which supports the whole system so that to an outsider it appears as if rooms, walls, doors might be remodeled at will or political convenience. Here we take a rather rigid stand. In spite of the apparent complexity of the system, one must not allow arguments based on exceptions to be used for advocating a new practice. More precisely, if a fictitious value to natural resources is being mooted by referring to the many fictions used already in the national accounts, - saying that the national accounts are simply a book of subjective conventions - this paper disputes such a move by claiming that any logically interconnected system of rules breaks down if managed by exceptions.

Let the point be clarified by means of an example. New imputations of value to non-market objects (resources, environment, housework, students work, etc.) are usually justified by pointing to the one big imputation within the aggregate of domestic product at market prices, namely the output of the government sector. True, this is a contradiction. From a theoretical point of view it would have been preferable to enter that output at its market value, which is zero, in the product at market prices, and to enter it at its factor cost only in the domestic product at factor cost, where market valuation is abandoned even for market activities. But such sophistication makes sense only within a full framework of accounts. It would have been meaningless and hardly understood at the time when these aggregates were created and presented to the public without the background of a full-fledged national accounts system. Nevertheless in airing changes of the national accounts today, the theoretical ideal should serve as a guide, and not the historical solution.

## 2. The treatment of depletable resources in the SNA

### 2.1 The flow accounts

"Charges for the depletion of exhaustible natural resources are not included in the consumption of fixed capital." So reads the one and only reference to the problem of depletion in the manual of the United Nations System of National Accounts (SNA, UNSO 1968, p.122). It could be neither shorter nor more precise. Perhaps it is a rule of dialectics that such clarity generates an aura of reasonableness for its converse: "Integrated environmental-economic accounting in the present framework focuses on the inclusion of costs, resulting from the quantitative depletion of natural resources...by economic activities" (UNSO, October 1990, p.129).

Before proceeding a question of method must be settled. The two statements are in logical contradiction with one another. Several ways of coping with the situation are possible. One can take the contradiction at face value, which implies that only one of them is true. The other is then necessarily false. Or one can uphold both statements as being true and search for the specific conditions under which each of them applies. Finally it is possible not to bother about consistency at all and use either statement at will or political necessity. In the following only the first two possibilities will be considered.

The exclusion of a charge for depletion of natural resources is not given an explicit reason in the SNA. It follows implicitly from other specifications, namely the definition of capital.

"Fixed capital formation consists of the acquisition of fixed assets by resident industries and the producers of government services and of private non-profit services to households, and occurs on the domestic territory of the given country only." "Non-reproducible tangible assets, such as land, mineral deposits, and the natural growth of standing timber are not included in gross capital formation, just as these assets are excluded from the supply of commodities" (UNSO 1968, pp.90,110). Again a specific reason for adopting this definition is not given. It is interesting to note that in the definition the explanatory term is "assets" which is a term of business accounting. The coincidence is perhaps not accidental.



The lack of explanations supporting the chosen definitions was natural at a time when few resources were available for theory while the working out of practical recommendations demanded all attention. It also can be surmised that agreement on this particular definition was sufficiently unanimous that the simple statement was thought adequate. In assessing these formulae today, it is necessary to unravel the underlying theory even if it is not explicitly referred to in the SNA.

In the SNA capital is defined by reference to the concept of assets. Two criteria determine the scope and structuring of assets recorded in the national accounts, ownership and production. Ideal assets contain both elements, they are produced, and owned (commodities). This applies to inventories, too. Problems arise when only one of the criteria production and ownership applies. The concept of capital can then have two different meanings either as a set of property values or as a set of durable goods resulting from and used in production. Actually, in the latter case, the definition is not clear. Economists do not agree whether what is then called "real" capital, is the set of all durable goods produced in an economy, which includes durable consumption goods, or the set of all durable goods used in production, which includes non-reproducible goods, or an accumulation of output used in later periods, which includes human capital, or still other. The definition implied in the SNA rule about fixed capital is the set of durable goods resulting from, and used in, production. Depletable resources are owned, are used in production but are not produced. Consequently they are not part of fixed capital.

But they are part of tangible assets. "Land is defined to include subsoil deposits..." (UNSO 1968, p.131). The balance sheet of the SNA includes depletable resources as part of the value of land. In this treatment it runs parallel to business accounts.

So far the treatment of depletable resources in the SNA is clear. The question which arises is of a theoretical economic nature. It looks as if subsoil resources are treated mainly as property or wealth, and that their contribution to production is ignored in the SNA. This seems to be particularly misleading in respect of such resources which are needed, and yet depleted, in production. Should not the depletion be accounted for as part of capital consumption? This is the question we want to study looking at business accounts (see part 4), because to business the same argument applies. If a firm in its operation depletes a resource can its income be stated without taking account of this process?

A problem related to the question is the treatment of exploration and development activities. These expenses are neither intermediate consumption, because they are not related to current production, nor are they capital formation, because they do not necessarily result in new usable goods. It may be that the two concepts of intermediate consumption, and of capital formation, alone, do not exhaust the full range of purposes for which an expense can be made in a modern enterprise, so that the solutions eventually adopted all carry an element of misrepresentation in them. The SNA enters exploration costs in intermediate consumption and development costs in fixed capital formation (UNSO 1968, p.101, 110). The European System of Accounts, ESA, distinguishes between the period before and the period after beginning of operations, and enters the early expenses in intermediate, the later expenses in capital formation (Statistical Office of the European Communities 1980, pp.48f). The problem is being discussed heavily in the revision of the SNA (Harrison, 1990, p.340), but is of second order here.

The main purpose of the SNA is to measure the circuit of flows between production and consumption in an economy. The meaning of the accounts is determined, therefore, very much by the definition of the production boundary. This determines the definition of capital formation as a category within the use of products. In this view, capital is defined as an accumulation of flows of things resulting from, and intended for, production. Depending on the period of use this capital is subdivided in fixed capital and inventories.

## 2.2 The stock accounts

However as mentioned above private property and the economic value expressed by it can be incorporated in other commodities which are not produced. In a modern economy the main example are financial assets, but other non-reproducible assets are also important. Therefore if in addition to recording the flows of production and consumption, a complete picture of the exchange of values within an economy is desired, balance sheets must be drawn up which incorporate all the wealth of an economic unit. The United Nations have issued a separate volume for the purpose (UNSO 1977) although some of the issues are mentioned in the SNA, and the linkages between the two accounting systems are there, of course.

In the balance sheets depletable resources are included. They form part of non-reproducible tangible assets, and their value forms part of the wealth of an economic unit. It must be noted though that the inclusion relies on the fact of property. The resource must be identifiable and distinct in the sense of belonging to one specific institutional unit. Otherwise the resource is ignored.

Wealth changes through time, and this gives rise to flow accounts connected to the balance-sheets. Again the concepts are clear theoretically. Apart from the changes of wealth due to production and consumption, which are registered on the core accounts of the SNA, reconciliation accounts are needed to record all the changes which are not due to such processes. Whatever valuation procedure is used for depletable resources, it is clear that the yearly change of the values is registered in the reconciliation account, and in as much as the chosen valuation represents the use of the resource for production, the depletion is accounted for fully. But this is not a true value flow, of course, because it does not reflect a transaction.

Ten years ago there were only two countries which produced official estimates of the value of their subsoil assets, Hungary and Japan (Blades 1980, p.337). The value was determined in the following way: For each mine the remaining life was estimated, and the operating surplus expected over the period converted to present values by discounting them with the rates of return currently earned by investors. As the operating surplus of a mine is not only due to the subsoil resource, but also to the appliance of fixed capital, this value had to be deducted in order to separate a value for the depletable resource alone.

Summing up the SNA rules, the treatment of depletable resources is as follows: Depletable resources do not form part of (reproducible) capital in the production accounts, but of (property) capital in the balance sheet accounts, which is a consequence of their being property, but not reproducible. Consequently the depletion charge is included neither in capital consumption, nor in the intermediate consumption of inventories, but as a revaluation on the reconciliation account. Resources outside any property claim are not recorded. National prac-

tice apparently proceeds along the same lines. The French national wealth accounts, for example, exclude "natural wealth" as a matter of fact (Benedetti, A., Consolo, G., and Fouquet, A. 1981, p.266).

The rules can be challenged on three grounds. In the broadest sense one can say that property must not determine what is valuable to man, and that accordingly all natural resources, even those which are not subject to property should be managed in the accounts. This is the problem of coverage. A less extensive approach may accept the property restriction but may want to change the valuation in the reconciliation account, because of inadequacy of market mechanisms to reflect true scarcity of goods aboard the spaceship earth. Let us call this the problem of quantification. Finally one may accept market valuation, as problematic as its final putting into effect may be, but require the removing of the depletion charge from the reconciliation to the core accounts of the system, either the capital account if it is considered consumption of fixed capital, or the production account if considered a use of inventory. The first approach is favored by the United Nations (United Nations 1990), the second by the World Bank (El Serafy 1992). This raises a problem of structure. An adequate answer requires a short reflection on the concept of value in the national accounts.

### **3. The difference between economic and natural resources**

#### **3.1 The problem of coverage**

Environmentalists share a holistic point of view. Man is seen as part of nature and so is his activity, especially in respect of its transformative impact implied by production and consumption. In this view it is obviously wrong to restrict the concept of production to monetary phenomena alone, while it is obviously right that an accounting system must incorporate all processes involved if it is to mirror the underlying phenomena correctly. Given the premise, an extension of the traditional national accounting realm is unavoidable.

It is easy to enter into technical details about the how and the where of registering environmental information. But it is impossible to assess the significance of changes on such a basis alone. Before the economic and ecology accounts are integrated between economics and ecology, the basic distinction that characterizes the two fields must be clarified. The distinction bears, of course, on the theory of value, and it is useful to recall some of the axioms of this theory, before toying with new valuation techniques.

Value is not a category found in nature. Neither God creating sky and earth, plants and animals, and all of nature is reported to have thought in these terms nor do any of the sciences dealing with nature make use of such a category today. The sun produces thermal energy, as does the nuclear power reactor, but physicists do not attach a notion of value to the process. All species reproduce themselves in complicated processes of consumption and production, and again no value is attached to them. The forces that shaped the earth are still in operation, shifting continents, producing weather, and again all this happens beyond any valuation principle. The first rule to remember is that transformation of nature has no value, in itself. The value arises from the use of such processes by man. It is here where economics begins.

Unfortunately, modern textbooks are not very concerned with the problem. The basic axioms of value theory are contained in the theory of the household, of the enterprise, or in the general equilibrium model, none of which have a direct statistical application. They explain human behavior in a world where there is value, but they forget to recall the basic features of reality which constitute the notion of value. The old classical economists are of greater help in this respect.

From their reading economic value has to do with nature, no doubt. In as much as man is a material being, none of his activities can take place outside nature. But this is only a necessary condition, not a sufficient one. The sufficient criterion of value, the mechanism that creates it is a social one, exchange. The concept of economic value is inherently built on the social mechanism of a market. Put to the point, where there is no market there is no economic value. Of course, there are other values besides the economic ones, political values (votes), social values (friends), personal values, all of which are scarce and relevant in determining human behavior and decisions. But a concept of economic value which is to encompass full and general observability in terms of cardinal numbers cannot but be based on the value created in exchanging commodities. This is not shocking news, and it is not new. We all know it, in principle. We know that economics is based on the concept of exchange value. Modern value theory then asks about what is behind exchange value, what is the substance expressed by it, and answers by the concept of marginal utility. This is the point where textbooks begin, but the phenomenon under consideration is exchange value, normally.

Now we must cope with the objection that this normal state of affairs of economics is wrong, that the notion of value extends farther than the realm of exchange, and that nature in particular must be considered valuable (Immler 1989). To be clear, the argument is not one of right or wrong, but of adequacy. One cannot be proven wrong in demanding to put a value on nature, nor in objecting to it. What we can argue about is consistency in accounting practice.

One approach to the environmental challenge is to extend the notion of exchange. If the concept of value is based on exchange is there not an exchange not only between members of a society but also between man and nature? It has become quite common to depict the relationship in these terms. Man uses resources of nature, and in return puts in resources in order to reconstitute the transformation (pollution abatement). In this view, to simply take away resources from nature, and not give anything in exchange, is exploitation of nature. The political inference is quickly drawn.

But one should not be blinded by political concerns. The notion of exchange is based on the social reality of a contract. Two agents agree on a transaction, and if the transaction is determined in terms of its size and date, it constitutes value. The transaction is the means by which all subjective considerations of two partners are bundled and become objective. Economic value is "realized" in a transaction, and this old terminology of commerce is no accident. Without a transaction there is no real value in economics, no value that is directly observable. The theory of revealed preference has solved the problem of cardinal utility at the expense of creating a notion of value which is not directly observable. It has removed value theory from value measurement. As the latter is the purpose of the national accounts, the two fields of economic concern have parted ever since. But as value is realized by mutual agreement, and nature is not a partner to any contract, the exchange between man and nature cannot be based on the same terms as the exchange within society. This precludes nature from being assigned an economic value. Value expresses a relationship between people (contracts).

### 3.2 The problem of quantification

There is another way of denying that value relies on exchange. Pointing to the fact that values are continuously assigned to economic goods, whether by accountants, national or business, or by economic agents in their decisions about goods, we claim that in a similar way value be assigned to nature. In this view value is a physical quality of a good like size or weight, a price tag so to speak that can be put on a good like a judgement.

This argument is more difficult to cope with, because there is no apparent boundary that would be transgressed in following it. We need to consider in some detail the concept of imputation in economic accounts. In general usage imputations are fictitious transactions. But this is loose language. Precisely speaking, imputations begin earlier than that. The simple concept of cost of production already requires the accountant to make an imputation, in this case, between the amount of goods bought now and those used now. Generally speaking all accounting concepts which describe transformation processes within firms are not transactions in the strict sense but imputations. They are necessary because accounts would be inarticulate and meaningless if they did not appeal to such techniques. We are used to saying that the output of non-market sectors is an imputation. The imputation of the output of the government sector in particular, taught and known to economists and non-economists as a so-called fictitious transaction, par excellence, has turned out as a Trojan horse for all kinds of challenges to amend the national accounts: if government output is imputed, why not the output of nature?

A line of defense can be drawn here only if a retreat is first accepted. It must be admitted that the inclusion of government output in national product at market prices is indeed a contradiction. The market price of government output is zero, and that ought not to have been denied by accountants. In a consistent scheme the inclusion of government output would find its place in national product at factor cost, in other words, in a part of the accounts where one takes one back from the market valuation of products. This step back, however, is not a withdrawal from market valuation as such. Factor values are determined by factor markets, and if government output is non-market, government inputs certainly carry market values. It so happens that in a modern economy, factor markets and product markets do not form a closed circuit, so that the sum of factor values is not equal to the sum of product values. Nevertheless, the principle of market value is not violated by turning from product to factor values. It is violated, however, by including non-property items, by transgressing the sphere of exchange, by ignoring that value is created in a social, and not in a physical process. It is not by chance that the ordinary production function cites only the factors land, capital, and labour. They are included not because they are the only ones which affect production in a physical sense, but because they are the only ones which attract revenue from production in our society. A production function which included all factors required for production in a physical sense would yield nice marginal productivities, but be meaningless in terms of value.

The third line of attack against conservative accounting practice is a subtle one, because it seems to come straight from the heart of economic thinking. One says that economic accounting is done under the pretext of keeping capital intact. Nature is part of capital, hence, nature must be accounted for. This argument is directly linked to business practice, and we will tackle it in that context.

Summing up this part we state that ever since economic accounts came into being they were always restricted to that part of resources which were handled in society by means of property rights; that the influence of supernatural powers was excluded from the accounts of the merchants of the middle ages as much as the exigences of nature today; that the inability of the exchange process to control human behavior on the spaceship earth may be a terrible truth. This, however, cannot be remedied by changing the picture of the process, the accounts, but by changing the process itself.

Extending the coverage of the concept of capital by attaching a value to a thing outside the exchange process is like calling someone king without naming the kingdom, it is confounding the symbol (price tag) with the fact (exchange process). The same holds for the challenge of quantification by means of market values, changing them into other values, expressing the actual scarcities better (willingness to pay, avoidance costs etc.). Such techniques may be used for estimates of future market values but can never replace the category of market value as such, because they lack the equality for producer and user which is inherent in the transaction as a contract based on mutual consent.

The most modest approach of simply shifting depletion of resources from property accounts to capital consumption, the problem of structure, is an issue better resolved within the horizon of business concerns, to which we now turn.

#### **4. The treatment of depletable resources in business accounts**

Before entering the subject a note of warning is appropriate. Business accounting is not an easy art. The purposes of business accounts are perhaps more wide-ranging than those of the national accounts, and country practices differ more widely, while the problems are no less complex than in the national accounts. And there is, of course, the usual divergence between theory and practice. A considered judgement on the treatment of depletable resources in business accounts would require an extensive study with significant effort, which has not yet been done. Consequently, the present opinions must be regarded as provisional, until better information is to hand. From a quick glance over the literature, the impression is that the fundamental principles of the treatment of depletable resources are similar in the different countries of the world, although the details differ. Actually the importance of the issue of depletion is felt much less at the level of the business accounts than under a macroeconomic perspective, because most businesses are not dealing with such resources, so that other problems of asset control are more pertinent.

Mineral resources lie below the ground, normally, under a piece of land which can be subdivided and owned. In the United States the property in respect of the resource goes with the property in respect of the land. In France the opposite position has been institutionalized; land and mineral deposit are separated, and the owner of the latter is the government, at least for all valuable resources. German law operates somewhere in the middle. In principle there is "Bergfreiheit", the finder has a claim to the resource, but there are important exceptions in favour of government intervention (Hartung, H.1986, p.2). Generally one can say that in business accounts, the depletable resource is treated in the same way as a reproducible asset. Its value is determined by the expense incurred in purchasing the resource, and contained in

the opening assets of a firm. Its depletion is netted out from the firm's income (Kosiol 1955, p.18).

A problem arises if the resource is not known at the time the purchase was effected. The treatment of the discovery of a subsoil resource is in part controversial in the German literature. There is agreement that a newly discovered subsoil asset is registered as an asset in the balance sheet at the time it is used in the business owning it and at the value a similar firm would pay for taking over the resource as part of the business ("Teilwert"). Since the corresponding increase in assets does not result from production, it is not counted as profit but is neutralised by a corresponding increase in equity capital (Körner and Weiken 1988).

If the treatment of the discovery of the subsoil asset is clear, differences of opinion exist as to the proper rule of depreciation. The German Federal Financial Court has ruled against any such allowance, arguing that depreciation makes sense only for assets which have been acquired by means of expenses which does not apply to discovery. This principle, which has similarities to the transaction principle in the national accounts, is challenged by critics who say that the discovery of the resource has raised the capital embodied in the firm, that this capital enters the accounts as a capital contribution on the part of the owner, and that it should be kept intact by appropriate depletion. Superficially this is just a conflict of interest, because taxes are lower if a depletion charge is allowed than if not. But more profoundly it is an argument about whether income tax should focus on production or on property, an issue we leave aside.

We mention in passing that a charge for depletion applies to the owner only, not for the user of a depletable resource. The user may have purchased a right to exploit the resource, but this is not subject to material depletion.

The traditional treatment of the depletion of resources was challenged by the crisis into which the world's oil markets were plunged in the seventies. It was felt that command over oil and gas fields may be more important for assessing the future development of an oil extracting company than any of the ordinary indicators of business performance. Rules were invented in order to answer the challenge and a heated discussion followed (Adkerson 1979, p.72).

In the United States, the Security and Exchange Commission (SEC) released a Statement of Financial Accounting on Reserve Recognition Accounting (RRA), which dramatically altered oil, and gas company balance sheets and income statements (Fraser 1979). Up to that time the oil and gas industry had traditionally used one of two methods of accounting for depletable resources, successful efforts or full costs. In the successful efforts approach, costs of exploration are capitalized if they are incurred in acquiring leases or drilling wells that are ultimately determined to be productive. Consequently, a substantial portion of exploratory costs is directly charged to expense. Under the full cost approach all exploration and development costs are treated as capital costs. Small firms, about 60% of the oil and gas producers, tend to prefer the latter method, in order to have easier access to capital, because in a growing economy income turns out to be higher. They also claim that the full cost method shows a more even time distribution of income, although the Financial Accounting and Standards Board (FASB) has ruled that the successful efforts method be used (FASB rules 1978).

It is clear that neither method embodies any concern for the depletion which the mineral deposit is undergoing as a result of extraction. Traditional accounting is based on something like

the transaction principle. Capital is only an accumulation of earlier expenditures which have not yet become costs. The input of nature, the mineral deposit itself does not figure as capital, and depletion accounts for the use of the accumulated expenditures only. The oil crisis brought this point into the open, and it seemed that a more sophisticated method of accounting was required, in order to achieve a more timely measurement of costs and results in income statements (Adkerson 1979).

It is clear that the new method relies on several new data. There needs to be an estimation of proven reserves. Proven reserves are volumes of crude oil which geological and engineering information indicate, as being recoverable in the future from an oil reservoir under existing economic and operating conditions (Ferran 1981, p.100). To calculate an income the reserves must be priced. Their worth must be discounted at a specified rate, and a timing stream of production and sales must be determined. Any change in the expectation of one of these future data affects the value of the oil property in the balance sheet and the income of the company. Also a change in the existing economic and operating conditions would have to be entered into the valuation procedure.

Table 1 shows the so-called Standardized Measure of Discounted Future Net Cash Flows from proven oil and gas reserves as disclosed by an actual company. In this statement the company comments that "since prices and costs do not remain static, and no price or cost changes have been considered, the results are not necessarily indicative of the fair market value of estimated proven reserves, but they do provide a common benchmark which enhance the user's ability to project future cash flows." (Shell 1989, p.49) The company considers these disclosures as useful. However, the information is given in addition to the conventional accounts. Neither the balance sheet nor the income statement proper are affected. It is worth noting that in the report of Shell's Holding, the Royal Dutch, such figures are not disclosed, because "To establish this information a number of assumptions about the future are to be made disregarding political, technical and economic uncertainties. Hence the information compiled on this basis does not supply a satisfactory and reliable measure of future cashflows from proven reserves to justify their inclusion." (Royal Dutch 1989, p.48). This does not preclude, of course, disclosure of detailed information about proven reserves in physical terms, which is the traditional way of conveying such information. The question is about valuation of these quantities and inclusion in income statements.

The issue is not decided in the business world. US regulations have spearheaded a new treatment of depletable resources which has not yet gained general recognition. Econometric studies have been undertaken investigating in what way the new accounting measures can be shown to influence the stock values of the oil and gas industry (T.S. Harris and J.A. Ohlson, 1987; B.M. Doran, D.W. Collins and D.S. Dhaliwal 1988). It seems that in spite of their shortcomings, historical cost assessments still have considerable explanatory power for the movement of the corresponding stock values. The expected future gains and losses are a volatile variable influenced by many facts and fears. Not by accident are they called windfalls in business practice because they change as swiftly as the winds of hope, risk and fear, an excitement so much more welcome to the boursier as it arises daily without need to actually perform an asset transaction. We turn to the insight to be gained for the national accounts.



**Table 1**  
**Shell Oil Company 1989**  
**a) Standardized Measure of Discounted Future Net Cash Flows**  
(millions of dollars)

	<u>1988</u>	<u>1989</u>
Future cash inflows	\$48,810	\$63,512
Future production and development costs	28,240	34,098
Future income tax expenses	5,477	9,102
	-----	-----
Future net cash flows	15,093	20,312
10% annual discount for estimated timing of cash flows	7,768	10,995
	-----	-----
Standardized measure of discounted future net cash flows	\$7,325	\$9,317
	=====	=====

**b) Sources of Change in Standardized Measure of Discounted Future Net Cash Flows**  
(millions of dollars)

	<u>1987/8</u>	<u>1988/9</u>
Sales and transfers of oil and gas produced net of production costs	\$(2,233)	\$(2,498)
Net changes in prices and costs	(1,979)	3,679
Extensions, discoveries, additions and improved recovery less related costs	367	1,233
Net purchases and sales of reserves	199	(63)
Development costs incurred during the period	929	861
Revisions of previous reserve estimates	(116)	106
Accretion of discount	1,195	1,015
Net change in income taxes	779	(1,567)
	-----	-----
Total change	\$1,103	\$1,992
	=====	=====

## 5. Implications for the national accounts

### 5.1 The definition of capital

The first question raised in this context relates to terminology. It is clear that business accounts attempt to provide information about the depletion of resources. However, even the most progressive proposal leaves the traditional balance sheet intact. There is no tendency to develop the notion of an eco-profit as opposed to the notion of the conventional profit. When new proposals are being made they are given new names, which express their operationalization. There is no reason for the national accounts to follow a different procedure. If a new measure is being introduced, it should not be named after domestic product, because that term is defined in the traditional accounts, but it should be called what it is (e.g. "standardized measure of future income losses due to environmental damage"). The term used at present hides the fact that a clear operationalisation of the valuation procedures is still missing, and it should be abandoned when that procedure is agreed upon.

The next, and more pertinent question is whether a new measure is warranted. The answer depends very much on the purpose to which the accounts are put. There seem to be essentially two purposes, measurement of welfare, and keeping capital intact. We ignore the first, because welfare is a concept which has no one-to-one mapping to a statistical indicator. Surely domestic product is part of the welfare description of a nation, but many other indicators are, too. Additional indicators, stressing environmental concerns are needed in view of the new concern about the subject (Drechsler 1976). But an overall welfare measure, if it exists, need not be directly related to the national accounts.

The claim of integrated environmental and economic accounting implies a different view. It alleges that production is not measured correctly, or more broadly speaking, that capital is not kept intact, if environment is not accounted for. It's this view which must be scrutinized here.

Economists work with different concepts of capital. Contrary to what they often maintain the notion of capital is not unambiguous in theory (Ward 1976, p.208), at least ever since the capital controversy, while it is defined unambiguously in the national accounts. The revision has clarified but not changed or even challenged the standard definition:

"Balance sheets are statements of the values of stocks of tangible and intangible capital assets owned by institutional units and of the outstanding financial claims between institutional units. In addition to stocks of durable and non-durable producer goods, tangible assets include certain assets, such as land and subsoil assets which may be used in production and over which property rights can be exercised and which may therefore be bought and sold, even though they may not themselves have been produced as outputs from processes of production. Environmental assets such as seas or air over which property rights have not, or cannot, be established are excluded. Assets in the form of human capital - that is, the skills, knowledge and abilities possessed by human beings - are also excluded." (UNSO SNA Draft 1990, chap. XI).

The essence of the quotation is the principle that the concept of capital is based on ownership. In this principle national accounts are identical in coverage to the business accounts, and there is no suggestion from this area to go further. Inclusion of a natural resource as capital thus

depends on its being treated as property. If an accounting scheme is meant as an integration of the physical environment into economics it must show by what means the social mechanism of ownership and market valuation can be circumvented, and in what way a value can be assigned to goods which cannot be exchanged. In theory it may not even be difficult to cope with the first part of the question, and to invent a mechanism. But at least one would have to be consistent and argue why if natural goods are valued at new values, the traditional goods presently included in national accounts would not have to be valued in the same way if market valuation is deemed inappropriate. It is not consistent to work with two different types of valuation side by side.

In the discussion of the national accounts, one has a tendency to abstract from value as a property and to look at capital solely as a physical means of production (Ward 1976, p.208). This change from the owners point of view to that of the user is legitimate for analytic purposes. It corresponds to a shift from the broad view of all things which are property to the narrower view of those things which are property and products as well, which is a shift from the balance sheet to the capital account of the core, technically speaking. But in disregarding the property characteristic altogether one loses the basis for valuation and thus for aggregation of the variables under investigation. This is the reason why valuation becomes so overwhelmingly a practical problem as soon as the boundary of property rights is violated.

If in terms of coverage, business accounts suggest no alternative to present practice in the national accounts the next problem is that of quantification. What precisely do we mean by the formula of keeping capital intact? Which capital is to be kept intact? The practice of business accounts is complex. A simple model may suffice to compare them with the national accounts. Capital is seen here as a stock of money which is put to use in a business. Maintaining capital intact then implies that the same sum of money should be recoverable when the business is sold. If the value of money changes over time all transactions must be corrected in value by means of the corresponding purchasing power indicator. In short we adopt the "equity" approach to the concept of capital maintenance which aims at preserving the general purchasing power of the owners' stake (Walton 1981, p.123).

The notion of sustainable consumption has created confusion in this respect. The idea is intriguing. You think of a resource which reproduces itself naturally, a forest, a population of fish, and the concept of sustainability is easily defined. But in doing so one has implicitly distorted the notion of capital, in attaching to it a physical quality and depriving it of its quality of value. If capital were a collection of things, the notion of keeping it intact would necessarily fail, because most things exist only once. They are used and used up. New things take their place. A depletable resource, in particular, can not be considered capital to be kept intact in the physical sense. The implied meaning can only be that the capital which was expended in buying and exploiting the resource is redeemed in money form at the end of the exploitation period. There is no sustainability in physical terms. The resource is exhausted at an earlier or later date, and there is no way of keeping it intact to re-use it. Consequently it is contradictory, to nurture the concept of sustainability when it is nothing but the old concept of keeping capital intact, based on the existence of value and property, and at the same time demand the inclusion of non-property items.

We have shown that in the business world new concepts have been developed which drastically alter the traditional formula of keeping capital intact. The new SEC guidelines require the replacement of the cost value of oil properties with the present value of proven reserves.

The example shows one thing. Only that capital can be depleted, which has previously been entered in the accounts. No depletion without prior appreciation. And if one obeys this simple rule of accounting, it is not clear whether the balance of appreciation due to new findings and of capital consumption due to depletion will result in a negative or a positive contribution to income. This may defeat the intended environmental indication.

It is improbable that the present value of net reserves will replace the traditional concept of revenue. Not only does the compilation require an enormous set of assumptions to which the result is sensitive, but it incorporates a theoretical flaw. If revenue is not defined as an aggregate of transactions in the time under observation, but as a summation over future revenues, those future revenues can also not be based on transactions. What is not acceptable as revenue today, can evidently not represent the revenue of the future. It does not make sense to discard a transaction definition of revenue for the present but to use it as the correct indicator of future revenue. This logical implication of the concept of present value is seldom recognized, but its internal contradiction nevertheless forms a major obstacle to its implementation.

## 5.2 The definition of income

Finally there is the question of structure. Even if no deviation is necessary from present practice in terms of coverage and quantification of the value of depletable resources, and if new findings are juxtaposed properly to depletion, should the whole accounting process be moved from the reconciliation to the income accounts of the system? Should depletion be accounted for not as a matter of revaluation but as one of capital consumption or of the use of inventory? Business practice seems to answer positively in this respect. Its income statement includes these operations. Doing so for the national accounts could be seen as a closer linkage between the two levels of accounting.

The first consequence of the shift advocated by the United Nations would be the necessity to enlarge the concept of production. There must have been capital formation before there can be capital consumption on the capital account. In order to do so one can argue that under present conventions no output is assigned to the activities of exploration, that it would be more appropriate to impute the cost of exploration as the value of newly found reserves, to register the new output as capital formation, and then to deplete it. The idea has been proposed by Ferran (1981) for the national accounts, because it is practiced in the business accounts (full cost approach).

In responding to this proposal we do not enter into discussion of the technical problems involved. The question of principle is easier to handle. The proposal touches on the definition of output. It has become clear in the process of revision of the SNA that the concept and value of output is closely linked to the delimitation of the statistical units of representation. The smaller these units are the higher is gross output, until at the limit the latter becomes infinite as the first approaches zero. If the result of each worker's activity is compiled separately this is the case. It is for this reason that the definition of the statistical unit is so important for the overall system, and unless the results of other internal activities such as administration, marketing, design etc, are accounted for separately, there is no reason to make an exception for the internal activity of exploration. On the other hand, any exploration undertaken by independent companies and sold to others is registered, of course, in the SNA as gross output, one

more indication of the institutional structure which necessarily supports this definition of output.

Depletion of resources should be registered in the balance sheet accounts as it is at present. Moving it to the capital account would destroy the fundamental distinction in the SNA between capital which is owned and produced and capital which is only owned. The distinction is vital, because the purpose of the SNA is to trace those sources of income which stem from production, not from revaluation. If the depletion of resources were moved to the capital account all the revaluations of the balance sheet accounts might be moved there for the same argument which is used for the depletable resources: measure true income. It is true that capital is kept intact only after these revaluations have been expressed, but this insight should be used to enhance the development and interpretation of balance sheet accounts rather than to change the structure of the accounting system.

In short if the economic and institutional constraints which define the national accounts are respected the present treatment of depletion is the only one feasible. The general public seems to have an inclination to accept the fact. Statistical users are sceptical about the integration approach, preferring two separate systems for economy and for ecology (Ebert, W., Klaus, J., and Reichert, F. 1991, p.167). Perhaps they are intuitively right, and the two systems are really different.

### References

Adkerson, R.C., Can reserve recognition accounting work?, *Journal of Accountancy*, September 1979, p.72-81.

Beck'scher Bilanzkommentar 2nd edition 1990.

Benedetti, A., Consolo, G., and Fouquet, A., L'Expérience Française de Comptabilité Patrimoniale: Sources, méthodes, résultats, *The Review of Income and Wealth*, series 27(1981), pp. 265-297.

Blades, D.W., Survey of Country Practices in Compiling Balance Sheet Statistics, *The Review of Income and Wealth*, series 26(1980), pp.325-340.

Brock, H.R., Palmer, C.E., and Cunningham, B.M., *Financial Accounting: Principles and Applications*, 5th edition, New York 1986.

Doran, B.M., Collins, D.W., Dhaliwal, D.S., The Information of Historical Cost Earnings Relative to Supplemental Reserve-Based Accounting Data in the Extractive Petroleum Industry, *The Accounting Review*, Vol.LXIII Nr.3 July 1988, p.389-413.

Drechsler, L., Problems of Recording Environmental Phenomena in National Accounting Aggregates, *The Review of Income and Wealth*, series 22(1976), September 1976, pp.239-252.

- Ebert, W., Klaus, J., and Reichert, F., Ansätze zur ökonomisch - ökologischen Berichterstattung, Universität Erlangen - Nürnberg, Nürnberg 1991.
- El Serafy, S., Depletable Resources: Fixed Capital or Inventories?, in this volume.
- FASB rules, *Accountancy*, January 1978, Vol.89, p.11.
- Ferran, B., Corporate and Social Accounting for Petroleum, *The Review of Income and Wealth*, series 27(1981), pp.97-105.
- Fraser, L.M., RRA: a look behind the theory to the numbers, *Journal of Accountancy*, September 1979, p.106-111.
- Harris, T.S. and Ohlson, J.A., Accounting Disclosures and the Market's Valuation of Oil and Gas Properties, *The Accounting Review*, Vol.LXII, No.4, October 1987, pp.651-670.
- Harrison, A., Major Changes Proposed for the next SNA: An Overview, *The Review of Income and Wealth*, series 36(1990), pp. 335-352.
- Hartung, H., Verfahren zur Nutzung erschöpfbarer Ressourcen: Das Beispiel der Versteigerung von Offshore-Förderrechten in den USA, Tübingen 1986.
- Immler, H., Vom Wert der Natur. Zur ökologischen Reform von Wirtschaft und Gesellschaft, Opladen 1989.
- Körner, W., and Weiken, H., Aktivierung und Absetzung für Substanz-verringerung bei Entdeckung von Bodenschätzen, *Betriebsberater*, Heft 15, 30.5.1988, pp.1006-1012.
- Kosiol, E. Anlagenrechnung. Theorie und Praxis der Abschreibungen, Wiesbaden 1955.
- Malmquist, D.H., Efficient Contracting and the Choice of Accounting Method in the Oil and Gas Industry, *Journal of Accounting and Economics* 12(1990), pp.173-205.
- Royal Dutch Geschäftsbericht 1989, issued March 15, 1990.
- Ruggles, N., and Ruggles, R., The Design of Economic Accounts, New York 1970,
- Shell Oil Company 1989 Annual Report issued February 22, 1990.
- Statistical Office of the European Communities, European System of Integrated Economic Accounts, 2nd edition, Luxembourg 1979.
- Statistical Office of the United Nations (UNSO), A System of National Accounts, New York 1968.
- Statistical Office of the United Nations (UNSO), Provisional International Guidelines on the National and Sectoral Balance-Sheet and Reconciliation Accounts of the System of National Accounts, Series M, No.60, New York, 1977.

Statistical Office of the United Nations (UNSO), SNA handbook on integrated environmental and economic accounting, preliminary draft of the part I: general concepts, New York, October 1990, mimeo.

Statistical Office of the United Nations, Draft of the revised SNA reviewed by the Expert Group on SNA Co-ordination but not yet revised by the author. Chapter XI: Balance sheets and net worth, 1990, mimeo.

Walton, J., Capital Maintenance and the Measurement of Corporate Income, *The Review of Income and Wealth*, series 27(1981), p.109-136.

Ward, M., Problems of Measuring Capital in Less Developed Countries, *The Review of Income and Wealth*, series 22(1976), pp.207-222.

Wöhe, G., Bilanzierung und Bilanzierungspolitik, München 1973.

# A STYLIZED MODEL FOR CALCULATING AVOIDANCE COSTS

Jürgen Blazejczak and Dietmar Edler

German Institute for Economic Research (DIW)

## 1 INTRODUCTION

It seems sensible to request that the collection of data should be guided by an underlying analytical framework. This has been the case for the System of National Accounts(SNA), the development of which was strongly influenced by conceptions of economic theory. The purpose of this paper is to present some reflections on an analytical framework, that may serve as a guideline for collecting environmental information.

One aim of scientific analysis is to make visible the implications of different options open to society, e.g. with respect to dealing with its natural environment. This can be achieved in such a way that the consequences of alternative courses of action are demonstrated. To pursue this purpose, welfare measurement like deducting actual defensive expenditure or bads contained in final demand from GNP - although valuable - is not sufficient, because this only aims at giving a more precise measure of the actual course.

If science should evaluate the consequences of taking different options the way to do so is to ask the question what it **would** cost to avoid environmental degradation. This is what we (not completely in accordance with the conventional use of this term) will call avoidance costs. In order to calculate avoidance costs **hypothetical** situations should be compared to the actual state of things.



This means, that we aim not primarily at calculating the actual costs for restoring factual deterioration of the environment in a past period, but try to evaluate the hypothetical ex ante costs of different feasible actions.<sup>1)</sup> One problem with investigating options of environmental policy in the way just described is that we do not exactly know which hypothetical situations are to be regarded. We would of course like to regard the "optimal" situation. But as long as we do not know so much about the supply of environmental functions<sup>2)</sup> and even less about society's demand for it, it will not be possible to identify an optimum. The way out of this problem usually chosen is defining standards that allow for a sustainable development. Even this is not an easy task. The approach suggested here circumvents this problem by describing a menu of possible alternative standards.

Moreover, one cannot collect observational data on hypothetical situations. That is why any proposal concerning such a situation may (correctly) be called arbitrary. The only way to deal with hypothetical situations is to identify causal relations. If we succeed in doing so it should be possible to obtain by simulation the information that cannot be directly observed.

Still there remain a number of reasons because of which a simple recipe: "define standards - formulate measures to meet these standards - estimate the necessary amounts of money" as proposed by Hueting<sup>3)</sup> is unlikely to work that smoothly: Usually there are various measures that could be taken, in order to meet a defined standard and in many cases it is not clear at the outset whether or not these standards will be met. One important reason why targets may not be achieved are repercussions originating from the economic system. Such interdependencies may also make it difficult to define the amount of money necessary to meet the defined standards. In addition, total individual costs and costs for the economy as a whole may turn out to be largely different.

1) See Nyborg (1992) for a discussion of the question, which costs are to be considered.

2) See Hueting (1980) for the concept of environmental functions.

3) See Hueting (1992).

For the present purpose a division of labour is suggested between statistical accounting and empirical economics along traditional lines: empirical economics works out the consequences of various courses of action by applying analytical methods whereas the provision of the quantitative information necessary to achieve this task remains in the domain of statistical accounting.

In section two at a theoretical level economic-environmental interactions are recalled in order to develop an extended notion of avoidance costs. In section three a proposal for an empirical model system is presented in stylized form that is designed to approach these interactions. The final subject matter of this exercise, however, is not modelling of economic-environmental interactions but pointing out some specific data requirements which have to be met to realize such a model system (section four).

## 2 AN EXTENDED NOTION OF AVOIDANCE COSTS

The problem of environmental protection may be visualized within the framework of a multiple input - multiple output production function. Inputs as well as outputs include environmental functions:

$$(x_1, \dots, x_n, e_1, \dots, e_m) = f(x_1, \dots, x_n, e_1, \dots, e_m, l)$$

where

$x_1, \dots, x_n$  denote material goods and services, including capital services,

$e_1, \dots, e_m$  denote environmental functions, and

$l$  denotes labour inputs

There exist substitution possibilities as well as complementary relations between different inputs and between different outputs. In this framework the depletion of natural resources expresses itself as a use of environmental functions on the input side. Environmental damage is seen as a diminution of functions on the output side. Likewise the environmental effects of environmental protection are accounted for on the output side.

On the input side avoidance occurs whenever the use of environmental functions is reduced. On the output side avoidance expresses itself by reduced environmental damage (i.e. reduced diminution of environmental functions) or newly created environmental functions.

Avoidance costs can be measured either on the input or on the output side. On the input side avoidance costs consist of the additional value of factors of production - other than environmental functions - which are necessary to produce the same amount of material goods and services at a better balance of environmental functions. On the output side avoidance costs is the foregone output value of material goods and services that occurs when factors of production are either shifted towards generating environmental functions or - if they are corresponding to the diminution of environmental functions on the input side - remain unutilized.

The production function framework allows for a systematic discussion of how avoidance can be achieved:

There usually exist many alternative production technologies in an economy. Their choice is governed by profit maximizing or cost minimizing behavior to which environmental standards set legal and regulatory constraints. Thus avoidance may be achieved by the choice of technology.

The production possibilities of an economy change over time. This technological change can be an important source of avoidance. Technological change normally does not just occur but has to be "produced" e.g. by research and development activities. The costs associated with these activities may enter avoidance cost calculations.

If demand is the short side of the market, the output of goods and services may be regarded as determined by final demand. This depends on influences like the level and distribution of incomes, prices, etc., which in turn are related to the production of goods and services. Output of environmental functions is only partly economically determined but partly it is fixed by standard setting.

Planned output besides other factors of influence like relative prices (which are, by the way, an important lever for economic instruments of environmental protection, too) determines the input of factors of production including environmental functions. This shows that the input and the output side are closely interconnected and embedded within the flow of incomes.

This brief description of economic-environmental interdependences shows that avoidance can take as its starting point either setting of standards, production technology, which determines the input of material goods and services as well as the input of environmental functions necessary to produce the output demanded, or final demand, which determines output of material goods and services.

Each of the different economic variables that influence final demand and production technology offer themselves as instruments for environmental policy. Thus such scheme also allows for the identification of various distinctive options with respect to the instruments of environmental policy.

Economic interdependences as sketched above make environmental protection measures to be felt in all parts of the economic system even if the immediate impulses are limited to particular parts. Economic agents react to those signals. This may lead to an enforcement or compensation of the initial effects via indirect repercussions which have to be taken into account when calculating avoidance costs.

The reaction of economic agents do not occur instantaneously because of high costs of rapid adjustment. Therefore avoidance costs as they are defined here partly are due to or are compensated for in later periods. A complete account of avoidance costs has to consider this intertemporal interdependence.

In summary, an extended notion of avoidance costs as proposed here shows that it would be necessary to

- take into account the fact that avoidance costs depend on the particular environmental standards formulated;
- allow for different technologies of environmental protection;
- regard as an option the development of innovative environmentally compatible technologies (integrated environmental protection technologies);
- acknowledge that environmental protection may apply to final demand as well as to production technology;
- accept that usually there are different policy instruments in the pursuit of environmental goals;
- comprise not only first round costs but to account for follow up economic costs (and benefits);
- pay attention to the inclusion of intertemporal interdependences.

### **3 A STYLIZED ECONOMIC-ENVIRONMENTAL MODEL FOR CALCULATING AVOIDANCE COSTS**

The main focus in this presentation of a stylized economic-environmental model will be on clarifying the major steps involved in calculating avoidance costs according to the extended notion outlined above.

It is not intended to actually realize a model as described here. Rather we believe that the concept may serve as an analytical programme to guide the integration of results based on different formal techniques, where each of these analytical techniques covers only one part of the important causal relations.

The calculation of extended avoidance costs requires a conceptual framework which describes relevant parts of the economic as well as the environmental system. In particular, the linkages and interfaces between both subsystems have to be designed carefully in order to take into account the relations between economic and environmental categories. Figure 1 illustrates graphically the envisaged economic-environmental model.

Thus the model system consists of two basic blocks:<sup>4)</sup>

- A model of economic variables within the framework of national accounts at an aggregate and a sectoral level as well;
- A model of the environmental system that concentrates on the description of technological processes, thus establishing the interaction between economic categories and environmental categories.

In the following we will discuss the features of both submodels, which are necessary in order to obtain a theoretically sound and complete estimate of extended avoidance costs. The discussion will remain at a fairly abstract level, describing the principles and general features of the envisaged model system. Nevertheless, it will be possible to draw some conclusions on information requirements which have to be met in order to implement the model and to apply it for calculating extended avoidance costs.

### **3.1 PRINCIPLES AND FEATURES OF A MODEL OF THE ECONOMIC SYSTEM**

Because of the inter-temporal character of the problem of computing avoidance costs, the economic model cannot be static or comparative-static, but has to be of a dynamic nature. It therefore has to specify the time-structure of economic functions. The dynamics mainly express themselves as stock-flow relations, adjustment cost, and expectations.

The different building blocks of the model of the economic system are:

#### *(a) Macro-economic relations*

The starting point for the envisaged economic model could be a conventional econometric model, which describes the development of macro-economic aggregates within the consistent framework of the traditional national accounting system. It has to include the

4) For a discussion of practical and theoretical issues of economic-ecological modeling; see Braat, van Lierop (1987).

major economic interdependences at work in an economic market system, and especially has to account for income distribution and redistribution. Although these traditional macro-economic relations should constitute the core of the economic system, they are by no means sufficient. They have to be supplemented by special features in order to adequately calculate avoidance costs.

Figure 1

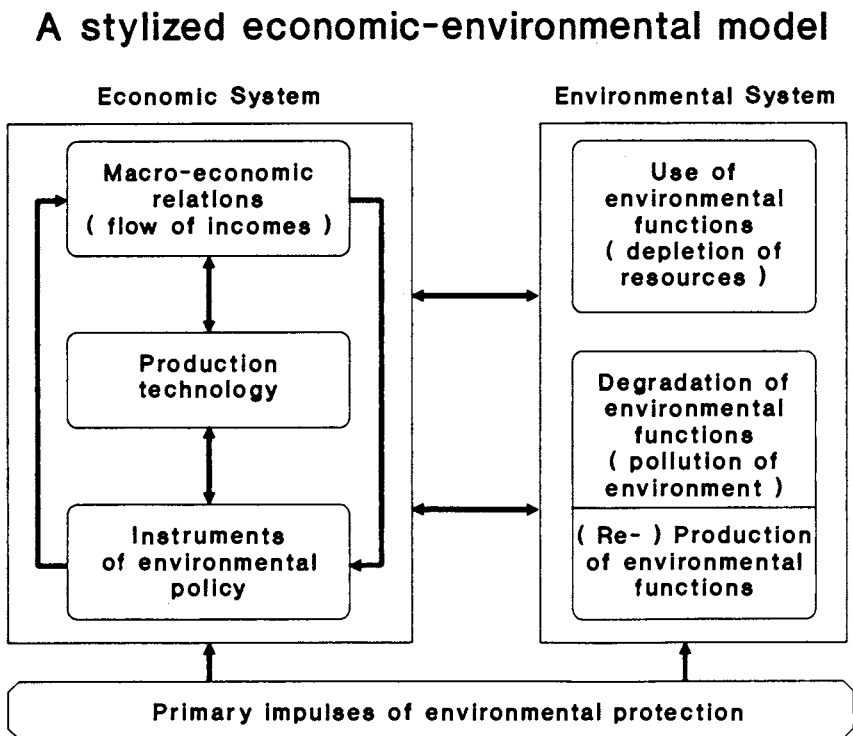

*(b) Production technology*

As has been argued in the previous section, each type of environmental protection activity is related to

- a change in the final demand for goods and services (private or public), and/or to
- a change in the technology of production in the economy.

Special emphasis on detailed modelling of existing production technologies and of feasible alternative technologies seems appropriate, because avoiding environmental damage can usually be achieved by a set of alternative technological options. These technologies have to be defined in economic terms, i.e. referring to the associated cost structure and investment requirements. Given the detailed description of a set of feasible technologies, the consequences of the choice of different technologies could be evaluated taking into account repercussions from the environmental model. Only the evaluation of technology within a framework describing economic-environmental interactions is able to show secondary environmental effects which may be counterproductive with respect to the original intentions.

Such a detailed formulation could preferably be accomplished within the input-output framework. The representation of production technology within this scheme will also permit to describe linkages to the environmental system, e.g. by incorporating process specific resource depletion and emission functions.

*(c) Instruments of environmental policy*

The economic effects of environmental protection activities and therefore avoidance costs will depend to a large extent on the choice of the economic instruments of environmental policy. The effectiveness of the intended measure will vary, depending on whether legal, regulative, fiscal or other instruments are employed. To describe these interactions the economic mechanisms involved have to be represented in the model.



*(d) Primary impulses of environmental protection*

Theoretically one could imagine a system which endogenously explains final demand decisions as well as the choice of technology departing from environmental policy measures, thus yielding e.g. required investment, changes in consumption patterns etc. As such a system can hardly be achieved in practice, emphasis has to be put on the attempt to record outside the model framework the immediate, primary economic impulses of environmental protection measures not represented endogenously. They are the starting point for calculating inside the model framework avoidance costs which - as has been argued above - have to include all secondary effects resulting from the interactions within the economic system, and between the economic and the environmental system.

The primary impulses are defined as the first round impacts of environmental protection activities. They include changes in the level and structure of investment (private and public), changes in the level and structure of the demand for intermediate goods and expenditures for employment related to environmental protection. Another primary impulse is the direct change in the final consumptive demand for goods and services related to certain environmental measures, while the secondary, indirect effects on final demand, e.g. through a change of relative prices, are described endogenously by the economic model.

In addition the primary effects of environmental protection activities on the non-price competitiveness of the economy should be accounted for. This effect - admittedly difficult to quantify - is due to the fact that modern, innovative environmental protection technologies will foster the international competitiveness of the environmental protection industries. Only the non-price competitiveness has to be taken into consideration in this way, because price competitiveness will be treated endogenously in the model of the economic system.

The task of quantifying the primary impulses has to be solved in a flexible manner depending on the type of measure under investigation. The primary impulses will be different, depending on whether e.g. an additive end of pipe-technology or an integrated

environmental protection technology is to be analyzed. To model the linkages with the environmental system in detail it may also be necessary to record which type of environmental function is affected.

### **3.2 PRINCIPLES AND FEATURES OF A MODEL OF THE ENVIRONMENTAL SYSTEM**

The model of the environmental system we envisage for analyzing avoidance costs is only of limited scope. We do not aim for a model which is capable of representing the complex mechanisms at work in ecological systems. The model we need for our purpose has to concentrate on the description of processes involved in the interaction between economic categories and environmental categories.

The major influences from the economic to the environmental system are the process of depletion of natural resources (use of environmental functions), and the process of environmental pollution (degradation of environmental functions). Both processes are linked to the economic system mainly via the set of technologies employed in the production process. For each technology - actually in use or feasible - specific explanatory relations for the depletion of natural resources and for the environmental pollution have to be implemented. These relations have to describe the consumption and production of environmental functions in relation to the activity level of the economy. The measurement of environmental functions could be in physical units following a comprehensive classification, the ensemble of indicators determining the "quality" of the description of the state of environment.

If the analysis were to be restricted to fixed technologies, an appropriate set of fixed pollution and depletion coefficients would be sufficient. Analogously to input or output coefficients used in input-output analysis, these coefficients would measure the physical amount of different types of resources and pollutants per unit of output. This set of coefficients would be required for each technology out of the set of feasible technologies in the economy.

A more realistic approach, however, would allow for variations of these coefficients being induced by the change of economic parameters. For example a change of relative prices of inputs will lead to substitution processes in the production system, which may alter the process specific use of resources or production of pollutants per unit of output. Therefore instead of fixed coefficients, functions explaining resource depletion and pollution should be implemented for each technology. In such a system the effect of the economic system on the environment, measured in physical units, will not only depend on the level of economic activity, as in the case of fixed coefficients, but also on other economic parameters, e.g. relative prices.

While the production of economic goods and services is usually connected to the use and degradation of environmental functions, there are specific production activities, e.g. restoration of contaminated soil or reforestation, which aim at the reproduction of environmental functions. In the framework proposed here these activities may be modeled in an analogous fashion, the improvement of environmental functions being measured in physical terms.

#### **4 SUMMARY OF ADDITIONAL INFORMATION REQUIREMENTS FOR CALCULATING EXTENDED AVOIDANCE COSTS**

The basic data requirements which would have to be fulfilled if one would decide to follow the modeling approach to calculate avoidance costs are:

- traditional national accounting (SNA),
- detailed physical data on resources and pollutants,
- a comprehensive description of the set of feasible technologies.

As can be seen immediately the difficulties to fulfill these requirements vary considerably. No specific problems with respect to data requirements will occur in implementing the macro-economic core of the economic model. This part of the model can be based on the readily available national accounts as defined by SNA.

Concerning the collection of physical data on natural resources and pollutants there have been many efforts to improve the scope and quality of data on this subject. Nevertheless, many problems remain unsolved so far, but are in the process of being discussed and clarified.

It should be noted that in this approach a monetary valuation of natural resources and pollutants is not invariably necessary. For each proposed state of the environment, defined in physical units, the economic-environmental model system will allow to calculate avoidance costs which the economy has to bear with a guideline for the definition of physical parameters describing a desired environmental state being drawn from the concept of sustainability, e.g.

This approach circumvents the need for data describing environmental functions directly, because such data is unlikely to become available very soon. It is realized, however, that the notion of sustainability in principle calls for such data. In case they could be provided the effects of environmental functions on the economy could be incorporated in this model system, thus completing the description of dynamic economic-environmental interaction. This would e.g. allow for the identification of resource effects, i.e. answer the question to what extent environmental functions contribute to the productivity of labour and capital. In addition, such data would permit to establish the relation between environmental functions and physical parameters which in our approach describe the state of the environment.

The information which is most urgently felt to be missing and to which not much attention has been paid yet are systematic data on technological options. What one could think of is a data bank of descriptions of feasible technological processes detailing their costs not only in terms of material goods and services, but also in terms of pollution and use of natural resources. The economic information needed could be organized in the form of columns and rows of a detailed input-output table with appropriate extensions for technological and environmental data. It is certainly not an easy task to establish such a data bank. It has been estimated by Forschungszentrum Jülich (KfA), Jülich, that for analyzing strategies to reduce CO<sub>2</sub> emissions in Germany about 600 techniques have to

be evaluated and documented. This could only be accomplished by the joint effort of engineering science, economics and statistical accounting. One central task of statistical accounting would be to develop guidelines, so that the effort to build this data base is managed in a manner which guarantees the compatibility with other elements of the environmental accounting system.

#### **REFERENCES:**

- (1) Braat, L.C., van Lierop, W.F.J. (Ed.), *Economic-Ecological Modeling*, Studies in Regional Science and Urban Economics, Vol. 16, Amsterdam 1987.
- (2) Huetting, R., *New Scarcity and Economic Growth*, Amsterdam 1980.
- (3) Huetting, R., *Correcting National Income for Environmental Losses: A Practical Solution For a Theoretical Dilemma*, in this volume.
- (4) Nyborg, K., "Eco Domestic Product": The Answer to Which Question?, in this volume.

# CLASSIFICATION IN ENVIRONMENTAL ACCOUNTING: SOME OBSERVATIONS ON THE PRESENT STATE

Alfred Franz

and

Norbert Rainer

Austrian Central Statistical Office

## I. INTRODUCTION

1. Environmental accounting is understood as a system that deals with environmental phenomena in a broad sense, focussing on the **interface** between economic activities (production, consumption and capital formation) and environmental media, in a cross-referenced way. More specifically, it seems to emerge as a system of "integrated environmental and economic accounting" (UN, 1990 b), representing a coherent system comprehensively describing the environment related stocks and flows as well as the use of environmental media by the economic activities. The latter appear as either being used in the process of economic activities ("inputs") or as a depository of (deliberate and inadvertant "outputs" of) the production and consumption processes.
2. The design of classifications cannot really be separated from the design of an overall accounting system. Indeed, classification systems often become a crucial issue, the usefulness of the resulting data system depending on their appropriateness as much as on other important conceptual features. In developing statistical data systems new or additional specialized classification standards have usually to be tailored according to the specific topic dealt with. Therefore, for a system which intends to integrate environmental and economic accounting, the specific classifications and nomenclatures to be applied and combined are **twofold**: i.e. environmental and economic classifications, with a certain degree of overlapping ("common denominator"). The minimum requirement of a meaningful combination is consistent concepts of sector and of classification breakdown. To achieve full **integration**, two kinds of classifications or nomenclatures must be interrelated in a more specific way. This may range from the use of the same statistical units on both parts up to coherence of all the parts (subsystems) of the overall framework. A range of possible variations emerges between the two extremes.

3. **Environmental classifications** comprise classifications and nomenclatures on the environmental media and their properties, on emissions and immissions, on scrap and waste, on natural resources and the like. In recent years considerable work has been undertaken in designing and harmonizing such classifications (CES, 1988). **Economic classifications** have already undergone a long process of international standardization and extensive experience of application has been accumulated by statistical offices. However, are these international standards, in particular the economic classifications, suitable for showing the interaction addressed in a combined, even integrated, presentation? Can economic classification systems be used to serve as a reference of the environmental impact of economic phenomena?
4. It is this kind of question that is dealt with in this paper. Of course, no comprehensive review can be given of all the concepts and standards in question. However, even on the basis of this brief discussion it may be concluded that in the ongoing development of environment accounting systems, greater attention should be given to such classification aspects, and particularly to the part overlapping with economic statistics.
5. The structure of the paper is as follows: in Chapter II the classification requirements of a coherent system of integrated environmental and economic accounting are discussed on the basis of a framework developed for Austria. The classification necessities are considered by criteria of **consistency, symmetry, relevance** and **characteristicity**. Chapter III gives some examples of designing environment related economic classifications against the background of the existing international standards. In the last Chapter some tentative conclusions are drawn.

## II. CLASSIFICATION REQUIREMENTS IN AN OVERALL SYSTEM

### A. *The Austrian framework as a reference basis*

6. The following discussion is based on a framework developed in the Austrian Central Statistical Office (ACSO; Franz, 1988), which serves as a reference for the implementation of an environment accounting system in Austria. However, this may be understood as a conceptual framework which may be implemented only in the long run. So far, only some parts of the system have been implemented (Fickl, 1992).
7. The Austrian system is largely SNA-based, although the SNA-framework had to be slightly adapted, reorganized and extended. Nevertheless, the basic system of production, consumption and capital formation accounts as outlined in the SNA seemed to be a suitable starting

**Table 1**

**A list of classifications  
needed for an integrated system of economic environmental accounts <sup>1</sup>**

- environment protection commodities<sup>2</sup>
- (other) market commodities<sup>2</sup>
- (other) non-market commodities<sup>2</sup>
- environment protection industries<sup>3</sup>
- (other) market industries<sup>3</sup>
- (other) non-market industries<sup>3</sup>
- private consumption (as emitting "activity")
- private consumption (as final demand)
- capital formation (deliveries to stock)
- capital formation (as absorption of commodities)
- revaluations
- emissions
- immissions
- environmental media
- damage/restoration
- value added
- rest of the world (imports/exports)

---

<sup>1</sup> drawn from the ACSO's system matrix (Annex 1; listed according to the sequence of sub-matrices)

<sup>2</sup> in terms of the forthcoming revised SNA: "products" (instead of: commodities)

<sup>3</sup> in terms of the forthcoming revised SNA: "producers" (instead of: industries)



Figure 1:

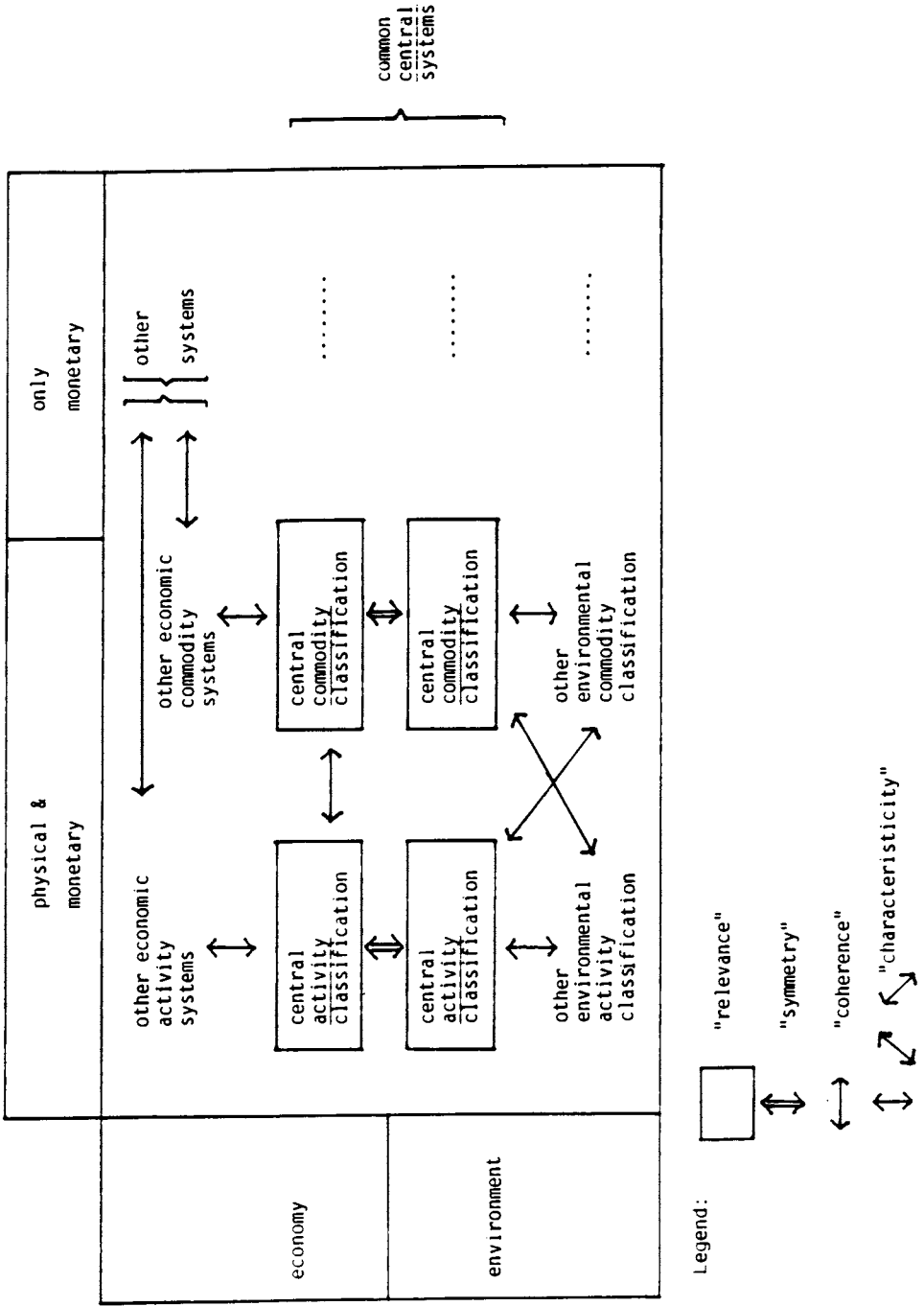

point for incorporating environmental aspects via an "input-output approach". In spite of a few particular accounts for revaluations or imputations regarding environmental damage, it is the main intention of the Austrian system to depict economic and ecological stocks and flows in a "descriptive" way, i.e. in a system that can be based on **observable** data. In addition, the system is to provide links between economic statistics/national accounts on the one hand and environmental statistics on the other hand.

8. The **matrix** framework of the Austrian system is shown in **Annex 1** to this paper (for further details see Fickl, 1992). From this it can be seen that - most importantly - there is a **separate environmental sector**, which - in relation to the SNA - is an enlargement of that system. A further specific feature is the treatment of final consumption as an "endogeneous" subsystem with respect to the impacts on the environment (which can be viewed as a reorganisation of the SNA). In principle, data of the ecological part of the system are to be based on physical units whereas data on the economic part are usually in monetary terms. However, wherever goods and services are concerned, data in physical units parallel those in monetary units as far as possible. It should be mentioned that the Austrian matrix framework has several features in common with the draft system proposed by the United Nations (UN, 1990 b).

## **B. Classification necessities**

9. Looking at the classifications required it is evident that each element of the row or column, respectively, represents at least one type of classification. Thus, leaving aside the assets' part of the system **17 different classifications** are needed. In detail, these classifications are shown in **Table 1**. In addition, classifications for the capital stock of the environment protection industries and the other activities are needed, both distinguishing environment related, and "other" stocks, but not included in the present list for the sake of simplicity.
10. For the most part, international standards are already available and in use. This holds true above all, for economic classifications whether used in basic statistics or within the national accounts. For some of the issues no specific extra-classifications will be needed at all, e.g. for imports and exports. However, for the classifications of environmental media, emissions and immissions etc. any reference is only rudimentary, and in particular for their combination with economic systems a special input of ecological and technical expertise will be required.
11. In designing classifications, one may start from the classifications readily available on the economic part of the system, and for the environmental part (although often not yet standardized there). The next steps would provide for **consistency** on each part: each classification is applied in combination with another one, thus resulting in submatrices; and for **symmetry** between the two parts of the system: one similar dimension of classification is used in both

parts, with the data based on the same statistical units. Common **activity** and **commodity**<sup>4</sup> classifications to be used in the economic as well as the environment sphere are at the heart of symmetry. Indeed, this is still a sort of "minimal approach", resulting in a data system of two mutually corresponding "mirror" blocks of information, their degree of correspondence depending on how far the symmetry requirements mentioned are met. Sometimes this kind of correspondence is called **linking** also.

12. However, this minimum may not be sufficient from the point of analysis and policy needs: the environmental issue has to be directly integrated in the economic part of the system also. This may lead to new/extended classification structures within the economic classifications and, in addition, may lead to new conceptual approaches in the design of economic accounts, too. Hence, two further criteria have to be considered, viz. **relevance** and **characteristicity** (see **Figure 1**).
13. The **relevance** criteria is the simpler one, applicable to each system. It says that each classification element has to be useful (meaningful/significant) in an analytical context. For environmental analysis the relevant question is whether within the given classification the environmental aspect is sufficiently represented. This may necessitate further disaggregation or reclassification, with additional identification needs in practical work. Relevance of a classification arises from its typological appropriateness, which does not necessarily depend on relations to any other (reference) classification system. The opposite is the case with **characteristicity**, which always addresses the relation between two separate classification systems, the degree of characteristicity depending upon its affinity/tightness of the relations between the individual classification categories across both systems. Characteristicity can be established either within the economic context alone (e.g. activity x commodity), or between economic and environmental concerns (e.g. activity x emission). The latter "border crossing" situation is of particular interest in the present context where "environment characteristicity" demands that topics like emissions, immissions, environmental protection be incorporated in the economic classification.
14. Characteristicity may influence the design of the classifications themselves, that way co-determining relevance also. However, ultimately a certain starting point must be adopted under relevance criteria alone so that relevance appears as the primary concept. On the other hand, relevance is often subject to general limitations prevailing in a given system, in particular if this is to be multipurpose (e.g. the use of a given type of statistical unit, which involves the impossibility of decomposition beyond a certain limit). Characteristicity is usually invoked in such circumstances. While both relevance and characteristicity may be based on empirical evidence and expertise, characteristicity tends to assume a sort of "normative" (a priori) role:

---

<sup>4</sup> according to the forthcoming revised SNA: "industry" and "product" classifications.

Once incorporated in a given system it may be referred to as a means of indirect (i.e. not directly observed) evaluation, "forecast" and the like, because it implicitly involves cross reference.

15. Integrating environmental related classifications on the basis of the relevance and/or the characteristicity criteria opens **additional analytical possibilities** beyond mere correspondence. Additional relevant categories increase the significance of the whole system and enable more specific analysis to be made, which would not be possible otherwise. These possibilities increase if internationally comparable standards are used. Great amounts of **additional** knowledge and information may be "activated" by characteristicity, by linking the characteristic environmental category with "corresponding" one(s) of the other system in the "normative" way. The formal tool is attaching an additional code, or the use of conversion/reference keys. Logically, bridge matrices would result but it may not always be suitable to show these intermediate steps as explicit elements of the framework. Thus, a useful tool can be provided to substitute environmental data which are not directly available (e.g. emission data for an economic process or good). Usually there is a well elaborated economic survey system to which additional data structures and classifications of this kind can easily be linked.
16. As already mentioned neither the elaboration nor the application of the relevance and the characteristicity criteria with respect to the environment issue can be performed by the economic statistician alone. He has to look for the symmetry criterion and for the compatibility with the principles of economic statistics (observation possibilities, standards for statistical units etc.). A particular task falling upon him is the development of a set of environment-related economic classifications most useful in a framework combining environment and economic criteria. - A summary discussion of the interrelations and requirements of classification in a system matrix context is presented in **Annex 2**.

### **III. ENVIRONMENT-RELATED ECONOMIC CLASSIFICATIONS: SOME PRELIMINARIES AND A FEW EXAMPLES**

17. Economic classifications on the one hand and environmental classifications on the other hand each follow their own necessities and peculiarities. Obviously, elements of both will have to be incorporated to achieve a combined or integrated system with a broad common denominator. In the economic accounts of the system, the processes of economic activities are described in terms of **input** and **output** and the respective commodities in terms of **supply** and **use**. Hence, the primary philosophy of classification by the similarity of the production processes (homogeneity) in terms of inputs and outputs according to their origin (given the activity classification). In addition to the ones mentioned above also some other criteria are referred to, like destination of the commodities produced. Therefore, in the standard classifica-

tions a mixture of criteria is found which are used to define "homogeneous" subsets. In any case the guiding intention is to substructure populations of agents in terms of economic behaviour and to define related flows enabling presentations to be made in terms of economic circulation. However, from the point of the **environment** the criteria underlying economic classification may not necessarily, or not immediately, coincide with criteria used to group phenomena in an interesting environmental way. In terms of classification, the environment (however defined) is a subject in its own right, and is not immediately represented in economic classification categories, because it is **functional** by comparison.

18. Some environmental criteria may be linked with an economic classification structure by loosely attaching the former to the given economic categories. This technique may lead to a meaningful "indicator" system (e.g. sulphur dioxide emission per monetary unit of total output of activities). Other aspects may be capable of being more directly applied to the elements of a given classification, or even incorporated. For example, the commodity classification may show the distinction between batteries containing or not containing heavy metals or recycling may be identified for further disentangling environmental effects.
19. On the basis of the above considerations a few typical situations and examples are now discussed, based on the search for environment-related economic classifications. The examples were taken from the ongoing discussions on environmental accounting, but not selected in a perfectly systematic way. The issues discussed are recycling, environment protection and environmental characteristics of activities/commodities in general.
20. The first example considered is **recycling**, a topic, which seems to be easily integrated into an economic classification system. Recycling covers scrap, waste and second-hand goods being channeled back into the economic circulation. ISIC Rev.3 already provided two separate 4-digits comprising activities of recycling:

- 3710 Recycling of metal waste and scrap
- 3720 Recycling of non-metal waste and scrap.

Both classes are defined as comprising activities of conditioning sorted or unsorted scrap and waste for industrial processing ("secondary raw materials"). However, production of new products directly on the basis of such secondary raw material is not included here, but in those classes where similar output is produced. Thus, considering only the activities of the mentioned classes of "recycling" proper gives an incomplete picture. It would seem desirable to separately identify and show any activity categories where output is (at least partly) based on processed scrap and waste. If, however, no separate statistical units of this kind can be found (because both processes usually occur together) reference to activity classification alone will not solve the problem. Hence, in the commodity classifications products from secondary raw material have to be separated, so that the process of recycling can be at least portrayed in

separate commodity accounts. In an input-output approach all the other goods and services directly connected with recycling (e.g. trade and transport services) can thus also be shown.

21. Since recycling minimises the magnitude of scrap and waste that would otherwise have to be discharged into the environment, it can be viewed as a particular type of the environmental protection services. In ISIC Rev.3 one other separate division is found, which more or less completely belongs to such economic activities: 90 Sewage and refuse disposal; sanitation and similar activities. This division mainly comprises activities of collection and treatment of all kinds of garbage, rubbish and waste, both from households and from producing units. For an overall concept of **environmental protection**, however, the activities of division 90 are insufficient. The first reason for this is that such activities take also place **within** the production units (showing such activities separately would require splitting of statistical units); the other reason is that protecting the environment is a much broader concept per se. It includes any economic measures to avoid the disposal of emissions (in a broad sense) into the environmental media, and any measures to restore damaged environmental media. So far there is still no standard definition of environment protection, except perhaps some primary concepts of this kind used in OECD/ECE questionnaires. How would such forthcoming standards fit into the given economic classification system? Will it be possible to define protection activities and their matching characteristic commodities other than ISIC division 90 in order to specify the full scope of environment protection industries/commodities on the basis of the given standards? Obviously, this is not the case at the present state of the art. Perhaps criteria analogous to those applied in defining tourism industries, or energy related industries might be useful here, too. Yet this task would be much more complicated since many more activities and commodities are involved in environmental protection, especially when the installation of internal (process integrated) protection is concerned. Such a "purpose-related" system may be implemented starting from criteria found on the expenditure side (environmental protection expenditures).
22. The above examples aimed at classifying economic activities (in principle including households also) with respect to their contribution to environment **protection**. On the other hand it would be equally interesting to address the economic activities/commodities according to their environmental **impact**, or more generally to characterize them according to their actual, or potential, environmental effects. Again, such characterization can hardly be achieved on the basis of one single criteria. From an economic point of view these may be input-, output- or process-related. From the environment viewpoint, their relation to the various media may be taken into account. Altogether, such specification may lead to profiles of greater relevance, and advantages of increasing characteristicity also.
23. The classification criteria to be applied for the impact side are not necessarily directly related to emissions or to the use of natural resources (both subjects being treated in special sub-matrices of the system) but may refer to **proxies** ("**indicators**") for such data. The best known

example here is data on **energy** used which per se does not immediately show the environmental repercussion. But it can still help to carry out emission-oriented analysis if the kind of energy and the process with which energy is transformed is known. For such an analysis, information on the technological relations between elements reflected in the economic classification on the one hand and on the related kind of emissions on the other is needed. In this way one may obtain information on actual emissions without having directly observed data on emissions as such.

24. In principle, analogous approaches could be performed in fields other than energy, too. In general terms, the procedure may start from the ecological issue and then trace it back to the economic system, or vice versa. The classification issue is to identify characteristicity relations between an activity/process/commodity and the respective environmental categories, or points of reference. As regards the former they are to be related to the existing economic classification structures. It is usually easier to attribute environmental characteristics to commodity categories than to activity classifications, where the limitations of the statistical units must be considered. Therefore, one might wonder why in the standard commodity classifications environmental aspects have not been considered to any great extent (if at all). Characterizing economic commodities with respect to their environment characteristics may not only refer to specifics leading to environmental burden but also more enjoyable ones, like those addressed by "green labelling" (Salzman, 1991).

#### IV. TENTATIVE CONCLUSIONS

25. The present review seems to suggest the following conclusions:

- an overall coherent system context indicates the need for a full classification rather than the identification of some incidental ad hoc needs;
- different degrees of overall correspondence may be taken into account, from simple sectoral and breakdown equivalence (symmetry) to fully ("intrinsically") integrated systems;
- for coherence of the individual subsystems at least one "index" of the individual elements must be linked to another subsystem;
- in addition to the relevance criteria, characteristicity concepts may significantly increase the implicit information content and, conceptually, the analytical uses;
- for international comparability, the compatibility of the classifications seems more important than the design of the overall systems as such;
- environment is a dimension so far not sufficiently represented in the existing international classification standards;
- standards of environment phenomena per se are not yet sufficiently linked;

- economic statisticians' contribution to the development of more ambitious versions (relevance; characteristicity) is limited;
- activity and commodity classifications are suitable central reference for environmental presentations also.



## References

- CONFERENCE OF EUROPEAN STATISTICIANS (1988): Environment statistics in the work programme of the Conference of European Statisticians, in: *Statistical Journal*, Vol.5. No.2.
- FICKL, Stephan (1992): Environment in a National Accounts Framework: Austrian Approach to Environmental Accounting, in this volume
- FRANZ, Alfred (1988): Grundzüge einer ökologischen Gesamtrechnung für Österreich, in: Österreichs Volkseinkommen 1987, Beiträge zur österreichischen Statistik, Heft 918
- FRANZ, Alfred (1991): Entwicklung einer Öko-VGR in Österreich: Input-Output als Alpha und Omega, in: *Österreichische Zeitschrift für Statistik und Informatik*, Vol. 21, No. 1-2
- KAHNERT, Andreas (1990): Basic methodological problems in the use of monitoring and sampling for purposes of environment statistics, in: *Statistical Journal*, Vol. 7, No. 2
- OECD (1991): Environmental Indicators - A preliminary set, Paris
- SALZMAN, Jim (1991): Green Labels for Consumers, in: *The OECD Observer*, April/May 1991
- UNITED NATIONS (1968): A System of National Accounts (SNA 1968), New York
- UNITED NATIONS (1984): A Framework for the Development of Environment Statistics, New York
- UNITED NATIONS (1990 a): International Standard Industrial Classification of all Economic Activities, Third Revision (ISIC, Rev. 3), New York
- UNITED NATIONS (1990 b): SNA Handbook on Integrated Environmental and Economic Accounting, Preliminary draft of part I: General Concepts, New York

**ANNEX 1: System Matrix for Environmental Accounting**

PROCESSES	P. R. O. C. E. S. S.														E. X. T. R. A. C. T. I. O. N. S.				C. A. P. S. T. O. C. K. S.					
	E. C. O. N. O. M. I. C. S. Y. S. T. E. M.							D. O. M. E. S. T. I. C. E. N. V. I. R. O. N. M. E. N. T.							E. X. T. R. A. C. T. I. O. N. S.				C. A. P. S. T. O. C. K. S.					
	C. O. M. M. O. D. I. T. I. E. S.			A. C. T. I. V. I. T. I. E. S.				R. E. V. A. L. U. A. T. I. O. N. S.			E. M. I. S. S. I. O. N. S.				D. O. M. E. S. T. I. C. F. I. N. A. N. C. I. A. L. D. E. M. A. N. D.		E. N. V. I. R. O. N. M. E. N. T. R. E. L. A. T. E. D.		E. X. T. R. A. C. T. I. O. N. S.					
	1	2	3	4	5	6	7	8	9	10	11	12	13	14	15	16	17	18	19	20	21	22	23	24
OPENING ASSETS: ENV. PROT.																								
" " " " : OTHER																								
ENVIRONMENT PROTECTION																								
MARKET																								
NON-MARKET																								
ENVIRONMENT PROTECTION																								
MARKET																								
NON-MARKET																								
PRODUCTION																								
PRIVATE CONSUMPTION																								
CAPITAL FORMATION																								
REVALUATIONS																								
EMISSIONS																								
IMMISSIONS																								
ENV. MEDIA																								
DAMAGE/RESTORATION																								
VALUE ADDED																								
R.O.M.																								
CLOSING ASSETS: ENV. PROT.																								
" " " " : OTHER																								

Finance of Investment

Distribution of income

**ANNEX 2: Interrelations and Requirements of Classifications in a System Matrix**

**Context (Overview):**

(A) **List of Classifications** (see text, para. 9)

(B) **International standards**

- goods & services: CPC, CPA, PRODCOM
- activities: ISIC Rev.3; NACE Rev.1
- environment: ECE (various)

(C) **Applications in a System-Matrix**

(see Annex 1; each submatrix may be broken down into major groups and classes, according to the appropriate classification system (A))

(D) **Symmetry requirements**

(a) Make-use:

- goods & services < = > activities

(b) Economy/Environment:

- monetary < = > physical
- activities(including consumption) < = > emissions; media
- goods & services < = > emissions
- stocks < = > immissions; media

(E) **Relevant environmental classification features**

- goods & services:
  - environment protection
  - " " related
  - " " detrimental
  - unspecific
- activities: environment protection; other
- emissions
- immissions
- media

(F) **Normative matches ("characteristic")**

(a) Make-use: commodity x activity  
(origin x destination)

(b) Environment:

"active"	- activities	x	emissions: media
	- emissions	x	recycling: media
	- immissions	x	media
	- media	x	media
"passive"	- commodities	x	emissions (& recycling)
	- consumption	x	environment-relevant goods & services
	- emissions	x	activities: consumption
	- media	x	immissions

## ENVIRONMENTAL VARIABLES IN NATIONAL ACCOUNTS: A CASE STUDY FOR ITALY

by A. Giannone and M. Carlucci<sup>1</sup>

University of Rome, "La Sapienza"

To define, establish and verify environmental policies, a great deal of information is needed, in the form of a self-consistent and exhaustive system. Thus, as national accounts were implemented to support the re-building of the international economy after World War II, a system of integrated economic and environmental accounting seems a necessary condition for evaluating and planning a proper management of environment and natural resources.

In this regard, a crucial bench-mark for planners and policy-maker should be the notion of *sustainable income*, defined as

non-declining per capita income generated by conserving or replacing the sources of that income, i.e. the stocks of produced and natural capital, and by accounting for the maintenance of environmental quality as part of an extended economic system (Bartelmus, 1989).

Here, we present a first attempt to estimate quantitative and qualitative losses of natural capital in order to define sustainable levels of domestic product. Thus, we move in the context of the first part of the newly proposed *System for Integrated Environmental and Economic Accounting* (SEEA) by the United Nations Statistical Office (UNSO, 1990), relating to features

of the established economic accounting system which are of special relevance to environmental aspects and which will have to be partly disaggregated to identify monetary flows and assets which are related to the use of natural environment.

The definition of the concepts of environment and natural capital here adopted is presented in section 1, while the integration of environmental aspects in economic accounts is discussed in section 2. Problems in assessing the stock of natural capital and the flows of goods and services provided by environmental assets form the object of sections 3 and 4, respectively. In section 5, we try to evaluate a "*Sustainable*" *Net Domestic Product* for Italy, using market and indirect non-market valuations. A few conclusive remarks are sketched in section 6.

---

1 This paper is the outcome of joint work of the Authors; however, A. Giannone wrote sections 0, 1 and 2, M. Carlucci wrote sections 3, 4, 5 and 6.

## 1. The concept of environment

Due to the variety of meanings that could be attached to the terms, a clear-cut definition of the concepts of *environment* and *natural capital* relevant for our analysis is mandatory.

As regards the former, a feasible, even if not comprehensive, description is provided by the following:

Environment acts as a habitat for living organisms, provides raw materials and energy for economic processes, permits recreational activities in a broad sense, receives and transforms the residuals of production and consumption activities (Giannone, 1983).

It is clearly an economic-oriented view of the environment, as a producer of goods and services, pointing to the linkages between environmental variables and economic activities.

The flows of environmental goods and services<sup>2</sup> stream from the stocks of natural assets, or natural capital. Here we follow the French concept of "patrimoine naturel" (INSEE, 1986; Weber, 1987) and accordingly distinguish between economic capital - durable *produced* assets, that can be owned and have a market value - and *natural* capital, consisting of the assets whose existence, production and reproduction derive from natural factors, but that could be affected by human activities<sup>3</sup>. This definition of natural capital is also consistent with the distinction between natural and man-made assets.

According to their characteristics, natural assets could be classified in three groups:

- a) subsoil resources, characterized by their being non-living and non-renewable<sup>4</sup>, including fossil petroleum, natural gas and coal, metals and other minerals;
- b) natural physical environment, embracing land (both cultivated and uncultivated) and terrestrial ecosystems, water and aquatic ecosystems, air;
- c) living organisms, such as animals<sup>5</sup> and plants, both economically-produced and wild).

---

2 It is important to stress that the production of natural goods and services is involuntary and, as in the case of disposal services, often with detrimental consequences for the environment itself. See UNSO (1990) p. 18. Moreover, the same natural asset could have different functions that are in concurrence with each other, as waste disposal and life quality supporting functions.

3 The two categories of capital are not mutually excluding: natural assets like economically-produced biological assets are also part of economic capital.

4 The "non-renewability" of subsoil assets refers to their rate of natural production being very much slower than their rate of extraction, even though extraction does not strictly mean destruction of these resources but only a physical transformation (Alfsen, Bye and Lorentsen, 1987). Moreover, substitution processes in the required inputs of raw materials and energy sources induced by new technologies (see Lo Cascio, 1990) add a further shadow on the relevance of the "non-renewability" concept.

5 We deliberately omit human beings from the count of natural capital.

All three categories of natural assets could be affected in quantity and quality by human activities. Mineral exploitation, soil erosion, air and water pollution can be cited as immediate examples of this influence. The economic use of natural assets could be viewed as resource depletion in cases a) and c), as media degradation in case b).

Some of the natural assets described above, such as subsoil assets, land and forests, are already considered in the System of National Accounts (SNA) as economic capital, and part of their variation is accounted for.

As regards *subsoil resources*, the value of extracted minerals is included in the output of mining and quarrying industries; exploration expenditures are included among industries' current expenditures, while development expenditures are considered as capital formation<sup>6</sup>.

Expenditures for *land* improvement and *soil* recovery are also accounted as capital formation.

*Living organisms* such as animals and plants are generally considered as products of agriculture, forestry, hunting and fishery, while animals for breeding, plantations and timber tracts are accounted in capital formation.

## 2. Integrating Environmental and National Accounts

A simplified accounting scheme for integrating environmental and economic aggregates is presented in graph 1 (Carlucci-Giannone, 1990). For the sake of simplicity, neither imports nor exports are considered.

As already noted, our approach is mainly economic-oriented and we shall discuss the linkages between environmental and economic variables only as far as economic transactions are concerned. Thus, the scheme here adopted could be viewed as an *extension of the conventional SNA*, in terms of a disaggregation of the traditional national accounts with regard to environmental aspects<sup>7</sup>. Moreover, only monetary valuation is involved.

In our opinion, since they cannot be viewed like free gifts of nature, the best way to consider natural assets consists in treating them as man-made capital, thus allowing for depreciation and current expenditure to repair and maintain the stocks<sup>8</sup>. The former ensures the replacement of the consumption of fixed assets, the latter keeps them in working order: related to natural capital, the two categories of expenditures aim to maintain the integrity of natural stocks both in quantity and in quality.

Thus, the integration of environmental variables in the SNA affects the following accounting identities:

- between the totals of value added plus imports and final demand:

---

6 In the revised SNA, even exploration expenditures will be included in capital formation.

7 In other words, we refer to part A of the SEEA described in table 1.5, UNSO 1990.

8 For a detailed discussion of the consequences of assimilating natural and economic capital see Harrison, 1989a and 1989b.

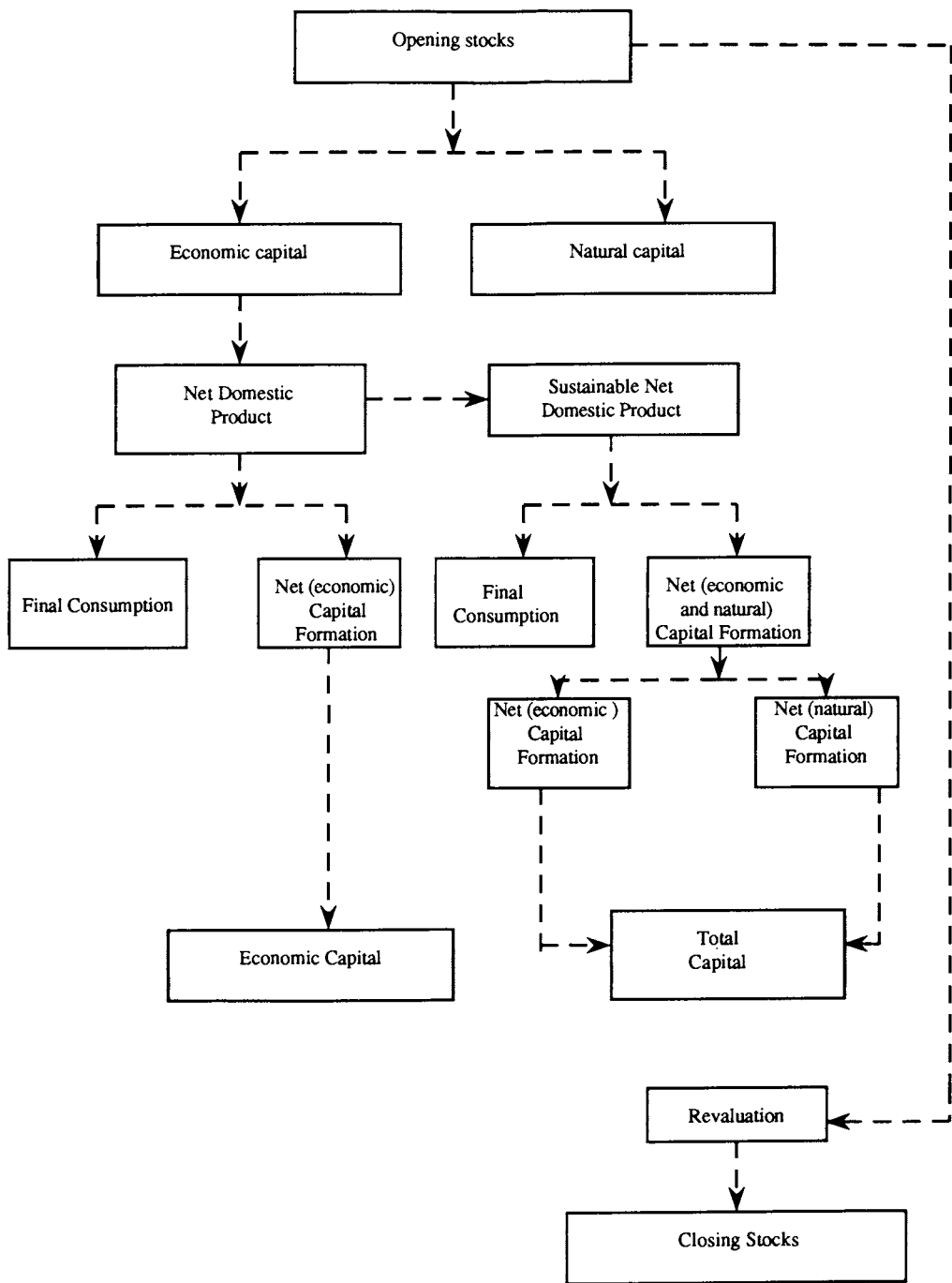

Graph 1: Simplified accounting scheme



$$\text{Net Domestic Product} + \text{Imports} = \text{Final Consumption} + \text{Net Capital Formation} + \text{Exports} \quad [1]$$

- between the closing stocks and the sum of opening stocks, net capital accumulation and revaluation:

$$\text{Opening stocks} + \text{Net Capital Formation} + \text{Revaluation} = \text{Closing stocks} \quad [2]$$

Leaving to the next sections the detailed description of the changes introduced in the relationships [1] and [2] by the inclusion of natural assets, we would like to stress here again that its principal aim consists in evaluating a level of income that *maintains capital intact*, both economic and natural (El Serafy, 1989), i.e. a sustainable net domestic product.

### 3. The measurement of natural capital

In the second row of graph 1, the opening stocks of total capital are split into economic and natural capital; so, the first step in our accounting scheme consists in the measurement of natural capital.

Stocks of natural capital could be expressed in physical or in monetary units. Usually, the SNA refers to monetary accounting, but physical valuation could be relevant when aggregates at constant prices are concerned.

Moreover, in the case of the environment, physical data are more suitable than monetary ones for describing the material flows between the environment and the economy, as in the material-energy balance (Ayres-Kneese, 1969; Cumberland, 1966; Isard, 1969; Leontief, 1960; Leontief-Ford, 1972).

Physical data are also relevant for policy-makers, in establishing controlled price levels or tax exemptions for energy sources and raw materials.

In the following, physical and monetary data on natural assets are discussed.

#### 3.1 Physical stocks

Physical data are usually available both on natural assets that are also included in economic capital (subsoil, soil and forests) and on other assets.

As for subsoil assets, many countries currently publish data on quantity stocks. The Italian National Statistical Office (ISTAT) publishes data on metal ore stocks and standards<sup>9</sup>. An overall description of world reserves of natural resources has been published by Howe (1985).

Current data on agricultural, forest and other wooded land, built-up and related land, water areas and open land are published by ISTAT. It must be observed that while agricultural and wooded land is totally encompassed in economic capital, this includes only a part of built-up and open land. In the case of natural capital, however, we must also consider waste land, wet open land and water areas.

---

9 These data, and other environmental data, are published in the series "Statistiche Ambientali" (Environmental Statistics). Some unpublished information has been used in this paper, by courtesy of dr. Lucio Sabatini, ISTAT, whose assistance is acknowledged.

As for the other categories of natural capital (ground, coastal and ocean water, aquatic animals and wild-fowl; air), a reliable assessment of their stocks cannot be performed either in value or in quantity terms. In Italy, some information is available on ground and rivers water (water flows, underground basins) and air (temperature, rainfall, wind, etc.).

### 3.2 Monetary stocks

Monetary valuation is current practice for natural assets that also enter economic capital. Among them, monetary accounting of subsoil reserves seems more controversial and deserves a more detailed description.

For the sake of simplicity, we shall only quote the most common methods for evaluating mineral reserves (see also, for a different point of view, El Serafy, 1989). As a matter of fact, the evaluation of mineral resource depletion is more relevant for less developed countries, while in fully industrialized ones the main environmental issues are related to media degradation by pollution and waste residuals<sup>10</sup>.

The value of a deposit depends on the actual reserve of the resource, its market price, and the state of technology in extraction methods. Three criteria could be applied (Landefeld-Hines, 1985), based respectively on:

- a) the discounted flow of future net returns (market price reduced by the exploitation costs);
- b) the price of the soil, or the royalties paid for deposits in concession;
- c) the average unit price (minus the exploitation costs).

## 4. Environmental flows in economic accounting

Having defined natural assets, we can now easily trace environmental flows in the accounting scheme described in graph 1 and in the identities [1] and [2].

We are interested in the consequences of the economic use of natural assets, i.e. in the changes induced in natural capital by human production and consumption activities. Such changes could be *quantitative*, as in the case of resource depletion, and could be treated as *flows of goods*, like changes in inventories, or *qualitative*, as in the case of pollution or waste disposal, and could be treated as *flows of services* from fixed assets.

*Quantitative changes* in natural capital included in economic capital are already considered in economic accounting, so they do not need any further integration.

An exception must be made for mineral resources, whose depletion is not accounted for in the output of mining and quarrying industries. Extraction of minerals causes a decrease in net accumulation of natural capital; thus, the corresponding values are to be deducted from the value added of the sector on the left side of identity [1], and from net capital formation on the right side.

As regards wild animals and plants, differentials in reproduction and depletion rates result in positive or negative volume changes of natural capital and domestic product; due to the

---

10 Moreover, mineral reserves have never played a relevant role in the Italian economy.

insignificance of those items in the case of Italy we assumed mutually compensating rates leading to stability of stocks.

Changes in the borders of uncultivated land, like the draining of a marsh, modify by the same amount, but with opposite sign, natural and economic capital<sup>11</sup>; the corresponding variations balance in the relationship [2] without altering the identity [1].

*Qualitative changes* involve media degradation caused by pollution, waste residuals and so on. We adopted a conservative approach, estimating those alterations with indirect valuations, based on *defensive activities* undertaken by the state, industries and households for environmental protection. The base assumption here is that these categories of natural assets, namely air, water, land and connected ecosystems, perform environmental functions - habitat, recreational, life quality supporting - that are impaired by degradation; thus, avoidance and restoration costs can be considered as depreciation costs to maintain the currently accepted standards of quality of the natural assets. The reference to currently accepted standards as opposite to optimum ones is mandatory since we use actual protection costs, and not the hypothetical costs that would ensure leaving natural assets unaffected. That's why we regard our approach as "conservative".

The expenditures on environmental protection activities must be subtracted from value added, thus leading to definitions of Gross Domestic Product (GDP) and Net Domestic Product (NDP) that perform better as indicators of well-being, avoiding the two-fold bias in the measurement of macroeconomic activity of neglecting environmental externalities in the real costs of production and consumption and of recording the cost of negative environmental effects of production as positive yields (Leipert, 1989). To maintain identity [1], households and current public expenditures have to be deducted from final consumption (since they have the nature of intermediate consumption, as expenditures on current repair and maintenance), industry and capital public expenditures from capital accumulation.

## 5. A case study for Italy: some empirical results

The inclusion of the consumption of natural capital in economic accounting should lead to a measure of sound and sustainable product. The results of a valuation of sustainable product for Italy are here reported<sup>12</sup>. The reference year is 1986, since in that year the Italian Statistical Office conducted a special survey on environmental expenditures of industrial firms.

---

11 A similar mechanism acts in a natural disaster, for instance a flood, where natural capital is increased by the amount of the once economically used land that turns into wet open land, while economic capital decreases accordingly.

12 The main part of the estimates presented here refer to a previous study, published in Carlucci, 1990. However, they differ in some aspects, mostly related to later data availability, that has permitted more thorough estimates of defensive expenditures. While revising the latter, we also took the opportunity to update National Accounting data with the last published figures (source: Ministero del Bilancio e della Programmazione Economica (Ministry for Budget and Economic Planning), *Relazione Generale sulla Situazione Economica del Paese* (General Report on the Domestic Economic Situation), Roma, 1991). Part of the data base for the calculations are courtesy of the ISTAT researchers R. Bruno, C. Costantino, P. Dolfi, G. Gabriele.

The aim of this work is to integrate and modify conventional economic aggregates of product and demand to take into account quantitative and qualitative changes of natural assets.

As quantitative variations in natural capital, we considered only the *value of minerals extracted*, measured at market prices. Since data on capital stocks of mining and quarrying industries are not available, we cannot evaluate the net gains for the sector which are needed to apply the methods quoted above. Therefore we had to update previous estimates, that showed a value of minerals extracted in 1973 equal to 36 billion lire at constant 1963 prices (Giannone, 1975). This figure has been revised by means of quantity and price indexes: first, the 1973 value at 1963 constant prices has been expressed in 1980 constant prices, obtaining a figure of 264 billions. Then, applying the quantity index of volume changes in mining output from 1973 to 1986 we found a 1986 value of 286 billion at 1980 constant price; eventually, applying the price index from 1980 to 1986, we found the 1986 value at current prices, namely 485 billion lire.

As shown in Table 1, this amount has been subtracted from domestic product, on the one side, and from the formation of natural capital on the other.

The *costs of environmental protection* used to quantify the economic use of natural assets could be cross-classified as regards the subjects involved and the accounting character of the expenditure. In the first case, we distinguish between households, the public sector and industries; in the second, between current expenditures for repair and maintenance, (negative) formation of economic capital and (negative) formation of natural capital.

*Household expenditures* for environmental protection concern purchases of insecticides, disinfectants and so on, that are conventionally recorded as final consumption in the category "housekeeping non-durables and services", but should more properly be viewed as current intermediate expenditures. Their amount, 1.292 billion lire in 1986, must therefore be subtracted both from domestic product and final consumption.

*Public expenditures* refer to the costs sustained by Government and Local Administrations<sup>13</sup>: we considered only actual cash expenditures (not budget allowances<sup>14</sup>).

For central administrations we recorded as environmental expenditures the cost items referring to: water of lakes, rivers etc.; coastal water; collection, transport, treatment and disposal of solid waste; collection and treatment of waste-water; obtaining final amounts of 568 billion lire for current expenditures and 2.040 billion lire for capital expenditures.

13 In Italy we have three levels of local administration with different jurisdictions: the 20 regions, the 95 provinces and the more than 8.000 communes.

14 Our sources were: *Rendiconto Generale delle Amministrazioni dello Stato* (General Report of State Administration) and ISPE (Institute of Studies for Economic Planning), *La spesa pubblica per l'ambiente (1981-1988)* (Public Expenditure for Environment), Roma, 1989, for Government expenditures; ISTAT, *Bilanci consuntivi delle Regioni e delle Province autonome* (Final Budgets of Regions and Autonomous Provinces) and *Bilanci consuntivi delle Amministrazioni Provinciali e Comunali* (Final Budgets of Provinces and Communes) for regional and communal administrations; the level of aggregation for provincial data did not permit disaggregation of environmental costs.

Regional environmental costs concern environment protection, soil defense and sewage; in 1986 they amounted to 349 billion lire in current expenditures and 854 billion lire in capital expenditures.

Current and capital expenditures sustained by Communes for sewage treatment, municipal street cleaning and refuse collection services amounted respectively to 4.020 and 1.473 billion lire.

Thus, on the whole we recorded public current expenditures at a total of 4.937 billion lire; those expenditures, that are conventionally accounted as value added and final consumption of the public sector, are in fact current intermediate expenditures, as well as household expenditures for environmental protection, and must be treated as such, i.e. domestic product and final consumption need to be decreased by the corresponding amounts (equal to  $4.937 + 1.292 = 6.229$  billion lire).

Table 1. Evaluation of Sustainable Net Domestic Product for Italy, 1986  
(values in thousand million of Italian lire)

Description of Aggregates	Domestic Production	Final Demand					
		Final Consumption	Exports net of Imports	Formation of economic capital		Formation of natural capital	
				Increases (+)	Decreases (-)	Increases (+)	Decreases (-)
1. Gross Domestic Product and Final Demand	899.903	707.905	3.622	188.376			
2. Depreciation of economic capital	- 107.660				107.660		
3. Net Domestic Product	792.243						
4. Value of extracted minerals	- 485						485
5. Costs of environ- mental protection	- 11.917	- 6.229			4.765		923
6. Sustainable Net Domestic Product and Final Demand	779.841	701.676	3.622	75.951		- 1.408	

Public capital expenditures, at a total of 4.367 billion lire, are currently recorded in the SNA as net formation of economic capital and included in the domestic product: their amount must then be deducted from both aggregates since they stand for a proxy of depreciation of natural capital.

*Environmental costs sustained by industries* were the object of a special survey in the reference year, regarding the costs of new plants and machinery, as well as running costs of existing plants, for waste-water treatment, disposal of solid waste and pollutant emissions' abatement. The survey presented two major drawbacks: it was limited to firms with more than 20 employees and, even in this limited universe, there was a huge rate of response refusal. Therefore the results have been grossed up to take into account all the firms with at least 10 employees, using average costs for employee by sector.

We used purchases of plants and machinery, estimated in 398 billion lire, as a proxy for the consumption of fixed capital in environmental protection activities, and we subtracted

this amount from the formation of economic capital (where it is recorded according to the conventional SNA) and the domestic product. Thus, the total deduction from the formation of natural capital is equal to  $398 + 4.937 = 4.765$  billion lire.

The running costs of environmental protection activities, estimated in 861 billion lire, are the indirect measure of the degradation of natural capital and are then deducted from domestic product, on one side, and formation of natural capital on the other. We also considered under this heading 62 billion lire corresponding to the services for waste disposal performed by municipal companies for private clients<sup>15</sup>, reaching a total amount of 923 billion lire.

## 6. Some conclusions

Our attempt to verify on empirical grounds the integrated environmental-economic accounting presented in section 2 has led to a definition of Sustainable Net Domestic Product (SNDP) as conventional NDP modified to take into account the consumption of natural capital, also.

From the theoretical point of view, SNDP is economic-oriented, more simplified and less comprehensive of the ecologically-oriented Environmental Adjusted Net Value Added, or Eco Domestic Product (EDP) defined in the System proposed by the Statistical Office of the United Nations (UNSO, 1990). Some relevant differences could be synthesized as follows:

- 1) we do not break down the different categories of natural assets and we consider generally a more limited set of degradation factors. For instance, we omit degradation in recreational functions;
- 2) we do not consider imports and exports of degradation (unwanted residuals, pollutants, etc.) from and towards the rest of the world;
- 3) the (negative) impact of household activities on the environment has not been taken into account by itself, but it could be viewed as one of the factors of degradation indirectly measured by the cost of public services of environmental protection.

Moreover, we do not measure opening and closing stocks for either natural and economic capital, but only their *variations*, since balance sheets are not currently part of the National Accounting System of the European Community and official valuation of economic capital are not available.

On empirical grounds, our SNDP amounts to 779.841 billion lire as opposed to a NDP of 792.243 billion lire. The small difference between the two aggregates, 1.57%, can be attributed to two main causes.

First, our data are to a certain extent underestimated, and they call for a sustained effort by the Italian Statistical Office in recording environmental items in monetary terms, especially in planning the questionnaire for current industrial surveys on value added.

Second, we focused only on certain aspects of environmental degradation, most directly linked to economic activities. Our SNDP is not an indicator of well-being but an accounting measure of the flow of output that is added during the year to the previous

level of resources, keeping the initial stocks intact. Moreover, the figures are not based on the measures needed to maintain certain standards of environmental functions, but on the defensive expenditures actually sustained.

It could be noted that if we compare, for instance, our results to Leipert's (1989) data on defensive expenditures, we find a striking difference in totals, as measured in percentage of NDP: Leipert's measure is more welfare-oriented, since it also embraces defensive activities in the domain of health, transport, housing, domestic security, work. If we look only at environmental defensive expenditure we find instead a striking similarity (in 1985 investments and current costs for environmental defensive expenditures absorbed 1.48% of German GNP).

## 7. References

- AYRES R.V. e KNEESE A.V. (1969), "Production, Consumption and Externalities", *American Economic Review*, n. 3.
- ALFSEN K.H., BYE T. e LORENTSEN L. (1987), *Natural Resource Accounting and Analysis: The Norwegian Experience 1978-1986*, Central Bureau of Statistics, Oslo, 1987.
- BARTELMUS P. (1989), "Sustainable Development: A Conceptual Framework", *Working Paper, UN Department of International Economic and Social Affairs*, New York, n. 13.
- BARTELMUS P., STAHLER C., TONGEREN J. (1991), "Integrated Environmental and Economic Accounting: Framework for a SNA Satellite System", *The Review of Income and Wealth, Series 37*, n. 2.
- CARLUCCI M. (1990), "Una valutazione del prodotto interno lordo sostenibile dell'Italia, 1985-87", (An Evaluation of Sustainable GDP for Italy, 1985-87), *Studi e Informazioni*, n. 4.
- CARLUCCI M., GIANNONE A. (1990), "L'ambiente e il sistema dei conti nazionali", (Environment and the System of National Accounts), *Studi e Informazioni*, n. 4.
- CUMBERLAND J. H. (1966), "A Regional Inter-industry Model for Analysis of Development Objectives", *Papers of the Regional Science Association*, n. 17.
- EL SERAFY S. (1989), "The Proper Calculation of Income from Depletable Natural Resources", in: Y.J. Ahmad, S. El Serafy, E. Lutz (eds), *Environmental Accounting for Sustainable Development*, World Bank, Washington D.C.
- GIANNONE A. (1975), "Verso una misura del benessere economico" (Towards a Measure of Economic Welfare), *Rivista di politica economica*, n. 12.
- GIANNONE A. (1983), "La misura del benessere e l'ambiente" (Welfare Measurement and Environment), *Rassegna Economica*, n. 5.
- HARRISON A. (1989a), "Environmental Issues and the SNA", *Review of Income and Wealth, Series 35*, n. 4.
- HARRISON A. (1989b), "Introducing Natural Capital in the SNA", in: Y.J. Ahmad, S. El Serafy, E. Lutz (eds), *Environmental Accounting for Sustainable Development*, World Bank, Washington D.C.

- HOWE C.W. (1985), "Natural Resources: Perspectives, Problems and Policy Guidelines", *Ricerche Economiche*, n. 4.
- INSEE-Institut national des statistiques et des études économiques et Ministère de l'Environnement (1986), *Les comptes du Patrimoine Naturel*, Collections de l'INSEE, Séries D, n. 137-138.
- ISARD W. (1969), "Some Notes on the Linkage of the Ecologic and Economic Systems", *Papers of the Regional Science Association*, n. 21.
- LANDEFELD T.S., HINES J.R. (1985), "Accounting for Non-Renewable Natural Resources in the Mining Industries", *Review of Income and Wealth*, Series 35, n. 1.
- LEIPERT C. (1989), "National Income and Economic Growth: The Conceptual Side of Defensive Expenditures", *Journal of Economic Issues*, n. 3.
- LEONTIEF W. (1970) "Environmental Repercussions and the Economic Structure: an Input-Output Approach", *Review of Economics and Statistics*, n. 3.
- LEONTIEF W., FORD D. (1972), "Air Pollution and Economic Structure: Empirical Results of Input-Output Computations", in A. Brody - A.P. Carter (eds) *Input-Output. Techniques*, North Holland, Amsterdam.
- LO CASCIO M. (1990), "Modelli statistici per l'analisi economica ambientale", (Statistical Models for Environmental Economic Analysis) *Proceedings of the 35th Meeting of the Italian Statistical Society*, Padova.
- UNITED NATIONS STATISTICAL OFFICE (1990), *Handbook on Integrated Environmental and Economic Accounting*, (preliminary draft), New York, October.
- WEBER J.-L. (1987), "Écologie et Statistique: les comptes du Patrimoine Naturel", *Journal de la Société de statistique de Paris*, n. 3.



# **Environment in a National Accounts Framework: The Austrian Approach to Environmental Accounting**

**Stephan Fickl**

Austrian Central Statistical Office  
Austrian Energy Agency

## **1. Preliminaries**

In Austria environmental accounting is a relatively new issue. Within official statistics it started after a Resolution of the Parliament (1988) to develop National Accounts to allow a presentation of environment related economic statistics. The main objective of this initiative was to gain better information about the environmental impact of the economic system and to develop new indicators of well-being.

The task assigned to the Austrian Central Statistical Office (ACSO) is twofold:

- \* The definition of an adequate conceptual structure of such a data system.
- \* The implementation of several parts of the system paying attention to pronounced public requests for special types of information such as "green GDP", damage costs, defensive expenditures.

It was clear from the beginning that it is most important for the organisation of data to use a comprehensive system with clear articulation (coherence) between the various aggregates. The Austrian system, as outlined so far, is essentially SNA-based (United Nations 1968). To meet the present needs the SNA concepts are focussed and extended with respect to environmental aspects. At the same time restrictions of the actual empirical situation must be taken into account.

In this paper these aspects are briefly considered. **Chapter 2** deals with the basic characteristics and the structure of the Austrian system set up as a framework and long term objective. **Chapter 3** shows how from this comprehensive system certain aspects of the framework and criteria are selected to allow the first steps of realization. **Chapter 4** gives a survey of the achievements realized so far and the problems emerging from practical implementation.

## 2. The System of environmental accounting

The "System" guiding the long range aims of environmental accounting serves as a reference framework for the systematical development of statistical implementation. It represents a particularly useful tool for the organisation and control of data collection. At the same time it helps to set priorities, to discover information gaps and to position new data.

### 2.1. Basic intentions

- \* The System is to serve as a universal **link** between National Accounts (or more generally speaking: economic statistics as a whole) and environmental statistics in particular. One main requirement for the realization of this aim is to develop interrelated **classifications** to accommodate comparable information in the different subsystems. Classifications are fundamental for the System, largely determining the quality of the outcome. So far there is only limited assistance of this kind available from the part of national as well as international systems (*see also Franz/Rainer* in this volume).
- \* The System is set up as a comprehensive framework for the analysis of the various interactions between the **ecological** and the **production/consumption** system. Therefore it has to be compatible with theoretical models (e.g. input/output).
- \* The System should essentially be based upon **observable** data, thus providing "descriptive" statistics. Subjective valuations and analytically processed data should as far as possible be left out at the beginning. However, such valuations cannot always be avoided (e.g. damage cost, hypothetical avoidance cost).
- \* The System should allow **indicators** of the performance and the ecological impact of the economic system not so far available to be extracted or accomodated.

### 2.2. Main characteristics

To meet these objectives the SNA framework, although basically suitable, has to be slightly adapted, reorganized and extended. The main additional features of this kind are:

- \* Creation of a separate **environmental sector** with stocks and flows, comparable to the economic sector.

- \* **Compatibility** with National Accounts by using similar transactors, transactions and classifications.
- \* Parallel use of data in **monetary** as well as in **physical** terms as far as possible. Most of the information for the ecological part is available in physical terms only, which must be taken into account to maintain the consistency of the system. To achieve this, symmetry of classifications on both sides is the primary tool.
- \* Treating **final consumption** as endogenous, with respect to the impacts on the environment. This is perhaps the major adaptation of the SNA system.
- \* A specially developed **stock** concept for the environmental sector. Most of the damaging processes show up as a degradation of environmental assets, to be considered in revaluation accounts.

### 2.3. Overview of the System as a whole

**Scheme 1** portrays a simplified version of the main parts of the proposed System (for a full-fledged matrix see Annex). Some parts have been left out to present it in a less complicated way (revaluations, connection to stocks, final demand, rest of the world), but the main characteristics are still visible: the economic system is distinctly separated from the environmental system. Consumption and capital formation are treated like "activities". The environmental system itself consists of emissions, immissions and environmental media (which are the only kind of stocks in this scheme):

**MATRIX A** represents the use of goods and services for production, consumption and capital formation. The commodities may be broken down into environment related ones and 'others' (all in monetary terms).

**MATRIX B** shows production of commodities by "production activities", as usual, and by private consumption as well. For example, private households may return commodities directly into the production process (e.g. recycling activities performed by the consumers). Production activities may be broken down into environment related ones and 'others' (monetary terms).

**MATRIX C** describes the emissions of production and consumption activities (physical terms).

**MATRIX D** shows the "production" of environmental media usually connected with some kind of restoration activity (physical terms).

**MATRIX E** shows the recycling of substances previously emitted (monetary terms).

**Scheme 1 : MAIN PARTS OF THE PROPOSED SYSTEM OF ENVIRONMENTAL ACCOUNTING (simplified version)**

	ECONOMIC SYSTEM			DOMESTIC ENVIRONMENT		
	Commodities	Production Consumption	Activities Capital Formation	Emissions	Immissions	Env. Media
<b>ECONOMIC SYSTEM:</b>						
Commodities			A			
Activities						
Production		B		C		
Private Consumption						D
Capital Formation						
<b>DOMESTIC ENVIRONMENT</b>						
Emissions	E					H
Immissions					G	
Env. Media			F			
Value Added		I				

**MATRIX F** comprises the benefits from the use of environmental media for production, consumption and capital formation activities (physical terms, monetary if possible).

**MATRIX G** describes the process of the transformation of emissions into immissions through environmental media (e.g. acid rain as "output" of the "air") (physical terms).

**MATRIX H** shows the change of environmental media due to the processes of emission, immission or direct interaction between environmental media (physical terms).

**MATRIX I** represents value added.

### 3. From the System to a working program

The present System of environmental accounting cannot immediately meet the public wish of "quick results" on damage valuation by simply representing a framework for a systematic approach. Therefore, it was necessary to set up a path of priorities of (stepwise) realization (*Franz 1989*). In comparison with the overall system, the implementation process pays relatively greater attention to the **damage valuation and classification**. Accordingly, it is attempted to show the relation between various SNA categories (activities and commodities)<sup>1</sup> and the damage of the environment.

Activities and commodities have different relations to the appearance of damage. In principle, they may either

- \* be designed to avoid or restore damage, or
- \* may cause damage to the environment, or
- \* may be affected by the level of environmental damage.

These damage-related points of reference are examined and classified in order to determine their importance for different questions, by the following criteria:

(1) **Potential or actual damage:**

First of all, damage itself has to be defined. Adhering to an "anthropocentric" view, damage always means an actual disadvantage in the use of the environment in comparison with a situation with a sound environment. Damages may either be **avoided** (potential damages), or they have to be **accepted** (actual damages).

---

<sup>1</sup>) Production, consumption and capital formation accounts.

Scheme 2: Criteria to be Applied to Different Damage Related Processes

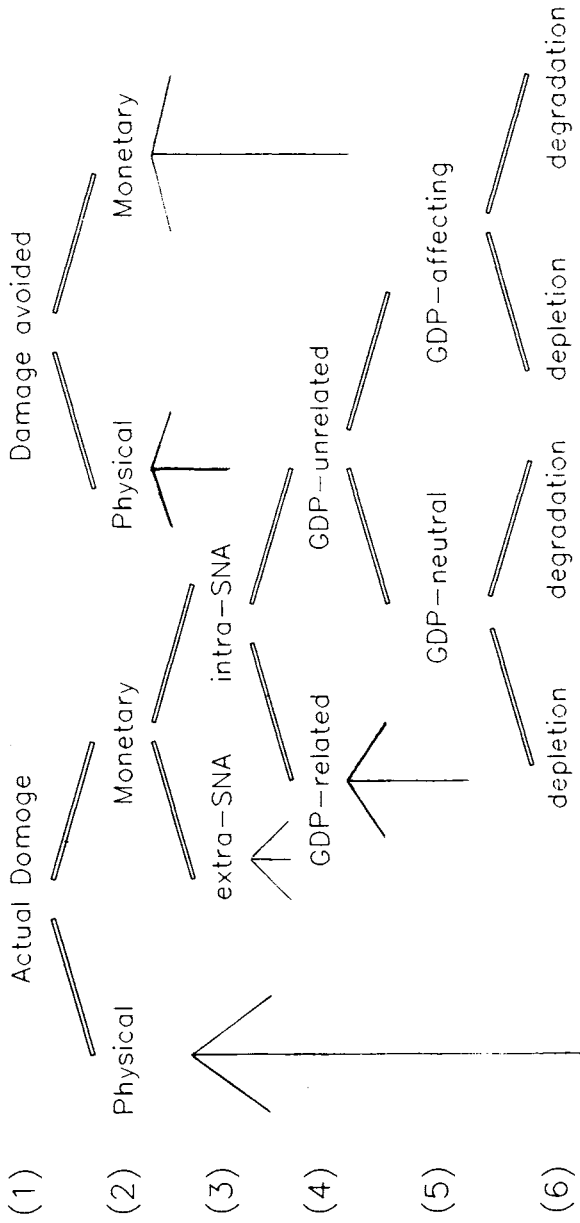

\_\_\_\_\_ breakdown analogous to other branches

(2) **Physical and / or monetary terms:**

Data should be gathered in both physical and monetary terms as far as possible, because a close connection enables additional analyses to be made (e.g. cost-effectiveness of environment protection expenditures), and provides consistency in the system. However, in the case of damages avoided monetary data would be sufficient whereas in the case of damages suffered, physical data generally are a prerequisite for the evaluation of the damages.

(3) **SNA relationship:**

Damages are classified with respect to their relation to the National Accounts (**intra-SNA, extra-SNA**). Intra-SNA damages are those already included in the National Accounts (e.g. losses of income because of forests damaged). Nevertheless, they do not explicitly appear there as environmental damages. Special identification is thus needed for damage accounting.

(4) **Causality of the damages:**

Damages are classified with respect to the causing activities. Not all of the damages are caused by the producing activities (i.e. **GDP-related**), but they may derive from consumption activities or some natural causes also (i.e. **not GDP-related**). However, it is often difficult to determine the causality and this task has mostly to be met by the appropriate scientists rather than by statisticians.

(5) **Effects on GDP:**

Damages may either affect or not affect National Accounts aggregates. Therefore, they must be classified into damages that do not change GDP (**GDP-neutral**: e.g. intermediate consumption of environment protection commodities), and damages that change GDP (**GDP-affecting**: e.g. final demand of environment protection commodities), respectively. This distinction lays the foundation for a systematical **adjustment** of GDP. Nevertheless, the adjustment itself cannot be done without further consideration.

(6) **Type of the damage:**

Damages may appear as either **depletion** or as **degradation** of environmental resources.

## 4. First steps of realization

### 4.1. Identification of relevant flows

In this early phase of environmental accounting we are concentrating on **monetary flows**<sup>2</sup>. In a first step environmentally interesting flows included in the actual NA-system of Austria are identified. There are primarily three categories of the kind, which can serve as **starting points** of the practical implementation of environmental accounting. These transactions may be related to the process of degradation and/or depletion of the environment, as follows:

- \* **environment protection** activities (4.1.1.),
- \* **environment using** activities (4.1.2.),
- \* **environmentally affected** activities (4.1.3.).

As pointed out in Chapter 3, environment protection activities are to avoid or restore damage whereas using activities cause damage to the environment. The third category refers to a range of possibilities of being affected by degradation and / or depletion of the environment.

Obviously, not all of these flows are additive in terms of damage accounting. Particularly the use of the environment (4.1.2.) and the damages received (4.1.3.) are two different views, and therefore alternative approaches to measuring the same thing, viz. environment degradation. Nevertheless, all these starting points are examined from the point of view of statistical implementation to provide comprehensive representation.

#### 4.1.1. Environment protection

These activities tell us something about the damages avoided, or restored. Economic activities produce emissions (in a very broad sense). They incur costs to avoid or to handle these emissions. They may do so for activities **within** the establishment (**internal avoidance**) or they may pay for a service used (**external disposal**). A third kind of environmental protection expenditures are outlays to **restore** the quality of the environment. These transactions can in principle be extracted from the NA system, with the exception of the **internal** (intra-unit) expenditures: by convention, the latter expenditures are explicitly excluded from National Accounts. However, they are very interesting from an environmental point of view because an increasing part of environmental protection takes place within the establishments/enterprises. Therefore, in the

---

<sup>2</sup>) For the time being, the stock aspect is not being worked out in connection with the SNA.



present system the establishments will be broken down into one part engaged in environmental protection activity, and another part producing the main commodities (as usual).

#### 4.1.2. Use of the environment

Production and consumption activities may result in degradation or depletion of (environmental) resources, making them less useful to economic transactors. These losses of a given quality or appropriateness of the environment may be evaluated in terms of avoidance costs or damage costs (see 4.1.3.).

From the point of view of the polluter one may try to identify **avoidance** or **restoration** costs necessary to keep the environment **intact**. These are **hypothetical** costs, possibly derived from actual transactions (avoidance costs) occurring in **comparable** circumstances, and used to measure the degradation of environmental resources.

#### 4.1.3. Damage costs

More and more the consequences of environmental degradation appear in the economic system itself, offering the opportunity of identifying the damages directly in the sphere of the transactor affected, or involved.

In the first place environment dependent activities like agriculture, forestry or water supply services are affected. They suffer from disadvantages due to worsening environmental quality. Industries as well as public and private households (individuals) may undergo outlays for the **prevention** of disadvantages in their area<sup>3</sup> (e.g. higher costs for corrosion protection). However, damage may also result in **lower output/income** or diminished value of produced assets (e.g. decreasing growth of crops). The damage costs are to be derived from **actual** transactions as far as possible to keep consistency with NA concepts.

#### 4.1.4. Classification

Data are to be classified according to the **criteria** of the framework (see Chapter 3, and Annex 3) to be able to answer different questions (adjustment, damage account).

3) This avoids damage of economic assets or production processes. When these economic assets are also environmental resources (e.g. forests), prevention expenditure may overlap with expenditures for restoration. Consequently, only expenditures for avoidance of the **damage to own** economic assets should be classified as damage costs.

## 4.2. Implementation

The above mentioned categories are dealt with in turn, providing some information on data sources as well as on empirical and theoretical problems encountered, in order to give an idea of the actual situation of implementation in Austria.

### 4.2.1. Environment protection

The first problem to overcome is to define "environment protection". *Any measure to avoid or dispose of emissions or wastes or to restore damaged environmental media* may be considered as environment protection. This holds for a general definition. Actually to carry out surveys, it is necessary to find statistically feasible solutions, which are sensible from an ecological point of view. Experience from surveys conducted so far shows it is much easier statistically to address end-of-pipe technologies than technologies embodied in production processes or alterations of products.

Presently, data on environmental protection expenditures in Austria stem mainly from three sources:

- \* Public budgets
- \* Survey of the Chamber of Commerce (for large scale manufacturing)
- \* Survey of the Association of Electricity Generating Plants.

#### (1) Public Sector Outlays

The public sector is the main producer of **sewerage** and **waste** disposal services. Figures on this kind of expenditures can be derived from public budgets. However, the main part of these services are provided by the communities and there are so far no detailed surveys on this part. Therefore, only estimates based on the expenditures of cities with more than 20.000 inhabitants have been possible so far<sup>4</sup>. Because of a lack of detailed information on life lengths we have not yet been able to estimate the actual stock of capital and related figures for capital consumption.

The second task of the public sector is **control** and **administration** of environment protection. These "overhead" type expenditures are widespread among the public sector, and often multi-purpose. Therefore, the main problem here is to be really comprehensive.

---

<sup>4</sup>) There is only one exception to this: The figures for gross capital formation in the sewerage system stem from the subsidizing institution ("Wasserwirtschaftsfonds").

Thirdly, the public sector is to a large extent involved in the **restoration** of damaged environment. In this case again identification is often difficult. While all these measures represent a certain intervention into the environment, it is often ambiguous to classify them as environment protection. A great many of these measures are either protecting human beings from effects originating in nature (e.g. river regulation, protection against avalanches ) or they are only indirect means of nature protection (e.g. subsidies to Alpine farmers).

This can be illustrated by an example: the public sector spends money on measures to protect or restore woods intended to protect against avalanches, landslips, etc.. But a great deal of the expenses is spent on road construction in that area which itself causes environmental damage.

So the main problems to overcome especially in "nature and landscape protection" are the following:

- \* Precise selection and identification of appropriate expenditures (ambiguity of the measures),
- \* Separation of the expenditures with respect to economic criteria (capital formation, intermediate consumption, value added, transfers).

## (2) Expenditure of Industries

In Austria the Chamber of Commerce has so far carried out four surveys about environment protection expenditures of large scale manufacturing establishments,<sup>5</sup> each of them providing data for five years. Thus, we have time series about gross capital formation and current expenditures for the years 1970 to 1988<sup>6</sup>. This data is broken down into:

- \* 4 categories of environment protection: cleaning of exhaust gases, waste water treatment, waste disposal and treatment, noise abatement.
- \* kind of activity (22 branches; will be classified also by Austrian Activity Classification-3 digit)
- \* 9 Länder.

These surveys provide a rich data base on environment protection expenditures and allow us to make estimates for other parts of the manufacturing sector, too. However, some problems for the integration into National Accounts remain:

5) These firms (about 7.000) are organized in a special section of the Chamber of Commerce ("Sektion Industrie").

6) Additionally, there is information on expenditures planned for 1989, 1990 and 1991-1995.

- \* Lack of information on environment protection expenditures of several activities: agriculture, forestry, construction, services.
- \* Current expenditures are not subdivided into compensation of employees, taxes and intermediate consumption. Consumption of capital is not included at all. This makes comparison with the figures of National Accounts difficult.
- \* There is no information on the kind of goods and services used for environment protection. This is why it has not yet been possible to fully connect this expenditure data with input-output statistics.

### (3) Expenditure of Electricity Generation Plants

Data on environment protection expenditures are available for the years 1981 to 1988, subdivided into current expenditures and gross capital formation. This information is provided for three groups of electricity generation installations: thermal, hydro-electricity generation, transmission and distribution.

This survey suffers from similar deficiencies as the survey of the Chamber of Commerce, viz.:

- \* no distinction between value added and intermediate consumption,
- \* no information on capital consumption,
- \* no detailed information on goods and services used.

Additionally, this survey does not distinguish between the various types of environment protection (cleaning of exhaust gases, etc...)<sup>7</sup>

A lot of supplementary, special data was also used to estimate environment protection expenditures (e.g. expenditures for catalytic converter).

#### 4.2.2. Use of the environment

The use of environmental functions is "free" as long as alternative uses (of present or future demanders) are not affected. In recent decades environmental functions have been used more and more intensively. The buffering capacity and the regenerating power of the natural environment have not been sufficient to maintain environmental quality. Therefore, environmental losses have occurred which are not adequately considered in the National Accounts.

---

<sup>7)</sup> That is why it does not fit very well into international questionnaires either (e.g. ECE, OECD).

One way of calculating these losses is to calculate the avoidance costs necessary to bring the impact (emission) on the environment to a level which guarantees the maintenance of environmental functions (**sustainability**).

Four steps have been proposed recently to fulfill this task (*Huetting 1990*):

1. Determination of a level of burden tolerable for a sustainable development (**standard**). This should be done at least for the most harmful emissions.
2. Comparison with this standard of the actual level of emission to estimate the need for environment protection. This requires detailed information on (polluter related) emissions.
3. Systematic search for information on alternative measures for the reduction of the emissions. These measures may be avoidance technologies, alternative production processes or closing down of whole firms.
4. Systematic search of information on the costs of these measures to calculate the hypothetical costs of avoiding environmental losses.

However, this task is very ambitious and laborious. Therefore, only parts of this program, addressing easily accessible data can be implemented in the ACSO for the time being.

So far the ACSO can barely cover such work as the definition of standards, the estimation of the effects of alternative measures on the environment, etc.. Therefore, an **alternative** approach has been envisaged, namely to gather data on cost-effectiveness of avoidance measures. The aim is to concentrate on key relations between identifiable avoidance costs, emission reduction and related figures from National Accounts, such as output, employees, etc.. This might serve as a basis for the estimation of hypothetical avoidance costs on a more comprehensive level.

However, apart from data problems this concept raises considerable theoretical problems:

- \* These costs do not measure the change in environmental quality, because they depend on the actual prices of avoidance technologies. If these technologies become cheaper the same environmental losses would count for less. A cautious interpretation of such figures is required, therefore.
- \* This concept considers only the first-round effects of avoidance measures. Being substantial, these measures would change the network of price relations, production and consumption patterns, and finally, the consequences for the environment, too. This raises the problem of compatibility with other data from National Accounts, based on actual transactions (*see also RICHTER*, in this volume).

- \* The concept works very well for renewable resources but it can hardly be applied to non-renewable resources, and is not at all feasible in the case of irreversible processes.
- \* It is quite difficult to allocate such figures to specific time periods in order to put them alongside corresponding National Accounts figures, due to problems on the ecological part (synergetic processes, accumulation over time, threshold values,...) as well as the economic part (especially costs for capital equipment).

### 4.2.3. Damage costs

According to the intended and basically accepted "anthropocentric" view of damage assessment, it is not our aim to estimate an 'intrinsic' (or existence) value of the degraded or damaged nature. Therefore, the repercussions of the degradation of environmental media on the economic system are in centre of interest. These consequences emerge in three different ways:

- \* Industries and households may incur expenses to avoid direct damage to their health, to their assets or to their production processes (e.g. necessity of more frequent corrosion protection).
- \* Industries and households have to finally bear the damage. For example, forestry is confronted with slower growing wood, or agriculture suffering from slower growing crops. At the same time, quality of life or the health of individuals may be reduced.
- \* The damage may appear as a depreciation of assets (e.g. real estate).

To assess damage a certain **comparison** with an alternative "reference" situation is always required: The amount of the "difference" is taken to measure the damage.<sup>8</sup> At the same time, this definition of damage brings about the two basic difficulties for an integration of the concept into an SNA framework. Often there are no actual transactions to measure damage directly, but some "traces" of the damage may be discovered in the recorded transactions. Another difficulty is fixing the reference situation which is never unambiguous. Different approaches have been used in various international studies which have been taken into consideration for the Austrian situation<sup>9</sup>.

#### (1) Estimating approaches

The estimates may be based upon various valuation methods (*Freeman 1982; OECD 1989, Pearce 1989, Rothengatter 1989*). **Indirect** valuation methods are founded on dose-response analyses (e.g. health, vegetations, materials).

<sup>8</sup>) This difference can be measured as higher expenditures, lower output/revenues, reduced quality of life estimates or reduced value of assets.

<sup>9</sup>) e.g. Teufel 1989, Hohmeyer 1989, Wicke 1986, Teufel 1991, Jöbstl 1989, Dixon 1986.

They estimate the damage in physical terms first. Thereafter they try to attach monetary values derived from market prices (e.g. timber prices) or willingness-to-pay (WTP) analyses. **Direct** valuation methods adhere to monetary valuation in the first place. They look for **surrogate** markets (e.g. housing prices), try to reveal the preferences through **interviews**, experimental methods (WTP) or expenditures (e.g. Travel Cost Method).

## (2) Integration into National Accounts

**Basis of valuation:** Some of the valuation methods are founded upon a basis very distinct from National Accounts (transaction/market price) valuation. For example, the WTP-method adds up all individual preferences, whether they are higher than a fictitious market price (e.g. involving a consumer surplus), or lower. In the latter case demand would fall short in the market place. So these figures are considerably higher and are not fully comparable to National Accounts figures.

**Reference situation:** The assessment of damage requires the definition of a reference situation for comparison. If the amount of damage is substantial, the hypothetical price relations and subsequently the hypothetical structure of transactions will turn out to be quite different. Such complex interrelations cannot be handled adequately without analytical models, which would result into a substantial deviation from the original target of producing descriptive statistics.

**Demarcation of periods:** National Accounts mainly produce yearly data. Damage estimates, on the contrary, sum up present and future damage costs to estimate average discounted damage figures for several years. It is difficult to attribute these figures to a particular period. This problem is most severe for the adjustment of GDP, because some of the damages already are included in GDP (e.g. losses of income, output). From a welfare point of view, these losses should be considered in a different period (e.g. losses because of slower growing wood in the period of growth). In this case it might be necessary to show gains in future periods also.

## (3) Consequences for the work in the ACSO

Ultimately, damage cost evaluation is rather subjective. Therefore, the implementation for Austria is going to be attempted in three steps:

- \* taking into account different empirical approaches on and results of damage evaluation from all over the world;
- \* trying to estimate such figures for Austria. To accomplish this task, figures from abroad and/or estimates from a special region will be suitably adapted to Austrian circumstances;

- \* checking the different figures with regard to their compatibility with National Accounts. Therefore, the estimates are classified according to the criteria described in Chapter 3.

This work has been accomplished so far only for forest damages, where there are already several estimates available for Austria (*Bundesministerium 1985, Jöbstl 1989*). However, this first experience clearly reveals the difficulties mentioned above.

## 5. Further development

Further work continues to meet the two main objectives of environmental accounting in Austria:

**Firstly**, a continuous improvement of the information system on economic-environmental interactions is intended. For this, above all, a close connection with the actual National Accounts system is indispensable, with reference to market transactions wherever possible.

**Secondly**, the public expectations on damage evaluation are to be met. In this respect, a complete review and classification of damage evaluation analyses is essential to avoid misinterpretations.

For these reasons the following items were chosen as the main priorities in further work:

- \* Data on **environment protection** expenditures are to be improved. On the one hand such data are to be adapted in order to fit better into the National Accounts in general, and input-output statistics in particular (capital consumption, separation of intermediate consumption from value added, information on the kind of goods and services used for environment protection). One main tool to accomplish this work is a set of environment related classifications of activities as well as commodities (*Franz/Rainer, in this volume*). At the same time, supplementary data is to be provided (e.g. household expenditures, construction industry, services, etc...).
- \* Work on the estimation of **hypothetical avoidance** cost figures is to be systematically implemented. Data on cost-effectiveness of avoidance measures are to be gathered. Information might stem from special technical analyses in Austria as well as from international sources. Cooperation with other countries might be valuable.
- \* As far as **damage evaluation** is concerned a lot of recent analyses have been completed (e.g. *Teufel 1991*). These estimates will be reviewed to



investigate their adaptability for Austria and their compatibility with our National Accounts.

## References

- AHMAD / SERAFY / LUTZ (ed.) (1989): *Environmental Accounting for Sustainable Development*, World Bank, New York.
- BUNDESMINISTERIUM für Gesundheit und Umwelt (1985): *Volkswirtschaftliche Auswirkungen von Waldschädigungen durch luftverunreinigende Schadstoffe*, Beiträge 3/85, Wien.
- DIXON / HUFSCHMIDT (1986): *Economic Valuation Techniques for the Environment. A Case Study Workbook*, London.
- FICKL, Stephan (1991): *Ökologische VGR in Österreich: Erste Ergebnisse*, in: *Statistische Nachrichten* 3/1991, p. 317-329.
- FRANZ, Alfred (1989): *Ein Bearbeitungsraster für die Ökologische Gesamtrechnung in der VGR*, in: *Österreichs Volkseinkommen 1988*, Beiträge zur Österreichischen Statistik, Heft 958, p. 31-44.
- FRANZ, Alfred; RAINER, Norbert (1991): *Classifications in environmental accounting: A Review of Concepts and Standards*, in this volume.
- FREEMAN, Myrick A. (1982): *Air and Water Pollution Control. A Benefit-Cost Assessment*, New York 1982.
- FREEMAN, Myrick A. (1985): *Methods for Assessing the Benefits of Environmental Programs*, in: KNEESE/SWEENEY, (1985): *Handbook of Natural Resource and Energy Economics*, Volume I, North-Holland, p. 223-270.
- HOHMEYER, Olav (1989): *Soziale Kosten des Energieverbrauches*, Berlin-Heidelberg.
- HOHMEYER, Olav (1989): *Die sozialen Kosten des Energieverbrauches*, Bericht über eine EG-Studie, in *Kommunalkredit*, p. 47-62.
- HUETING, Rofie; BOSCH, Peter (1990): *On the correction of national income for environmental losses*, in: *Statistical Journal of the United Nations*, 7/90, p. 75-83.
- JÖBSTL, Hans A. (1989): *Ökonomische Bewertung von Waldschäden (Economic Assessment of Forest Damages)*, Schriften aus dem Institut für Forstliche Betriebswirtschaft und Forstwirtschaftspolitik, Heft 8, Wien.

- OECD (1989): Environmental Policy Benefits. Monetary Valuation, Paris.
- PEARCE / MARKANDYA / BARBIER (1990): Blueprint for a Green Economy, London.
- RICHTER, Josef (1992): Environmental Accounting: Some Non-Technical Remarks, in this volume.
- ROTHENGATTER, Werner (1989): Soziale Zusatzkosten des Verkehrs, in: DIW-Vierteljahresheft 1/89, p. 62-84.
- TEUFEL, Dieter (1989): Gesellschaftliche Kosten des Straßen-Güterverkehrs. Kostendeckungsgrad im Jahr 1987 und Vorschläge zur Realisierung des Verursacherprinzips, in: UPI-Bericht Nr.14, März 1989.
- TEUFEL, Dieter u.a.(1991): Ökologische und soziale Kosten der Umweltbelastung in der Bundesrepublik Deutschland im Jahr 1989, in: UPI-Bericht Nr. 20, 1991.
- UNITED NATIONS STATISTICAL OFFICE (1990): SNA Handbook on Integrated Environmental and Economic Accounting, Preliminary Draft of the Part I: General Concepts, New York.
- WICKE, Lutz (1988): Die ökologischen Milliarden. Das kostet die zerstörte Umwelt - So können wir sie retten, München.

# ANNEX

## System Matrix for Environmental Accounting

PROCESSES	P. R. O. C. E. S. S. E. S.										C. A. P. S. T. O. C. K. S.						
	ECONOMIC SYSTEM					DOMESTIC ENVIRONMENT					EXOGENOUS						
	COMMODITIES		ACTIVITIES			Re-valuation		Emissions		Damage		FINAL DEMAND		other			
	Env. Market	Non-market	Production	Prof. Market	Non-market	Capit. formation	Priv. Cons.	Non-market	Envs. Sions	Medial Resto- cation	Priv. Consumption	Publ. Consumption	env. related	other			
1	2	3	4	5	6	7	8	9	10	11	12	13	14	15	16	17	
OPENING ASSETS: ENV-PROT																	
" " : OTHER																	
ENVIRONMENT PROTECTION MARKET																	
NON-MARKET																	
ENVIRONMENT PROTECTION MARKET																	
NON-MARKET																	
PRIVATE CONSUMPTION																	
CAPITAL FORMATION																	
REVALUATIONS																	
EMISSIONS																	
IMMISSIONS																	
ENV. MEDIA																	
DAMAGE/RESTORATION																	
VALUE ADDED																	
R.O.W.																	
CLOSING ASSETS: ENV-PROT																	
" " : OTHER																	

Finance of Investment

Assets

Distribution of income

ABSORPTION

GDP

IMPORTS

EX-PORTS

### Brief description of the submatrices

<b>a x e</b>	Environment related stocks with protecting functions (e.g. forests protecting against avalanches, landslips)
<b>a x f</b>	Other capital stocks of environment protection activities
<b>b x 12</b>	Stocks of environmental media in physical units
<b>b x e</b>	Environment related stocks of <b>non</b> environment protection activities (e.g. forests)
<b>b x f</b>	Other capital stocks of <b>non</b> environment protection activities
<b>1-3 x 4-6</b>	Matrix of absorption (IO-statistics)
<b>1-3 x 7</b>	Vector (matrix) of private consumption (IO-statistics)
<b>1-3 x 8</b>	Vector (matrix) of capital formation (IO-statistics)
<b>1-3 x 17</b>	Vector (matrix) of exports (IO-statistics)
<b>3 x 16</b>	Vector (matrix) of public consumption (IO-statistics)
<b>4-6 x 1-3</b>	Make matrix (IO-statistics)
<b>4-6 x 10</b>	Matrix of emissions of production activities
<b>4-6 x 12</b>	Matrix of output of environmental media by production activities, including restoration (4 x 12)
<b>7 x 1-3</b>	Commodities "recycled" immediately after consumption activities
<b>7 x 10</b>	Matrix of emissions of the consumption activities
<b>7 x 12</b>	Matrix of output of environmental media by consumption activities
<b>7 x 15</b>	Private consumption as final demand
<b>8 x 12</b>	Output of environmental media by capital formation including restoration
<b>8 x e</b>	Matrix of formation of environment related capital stocks
<b>8 x f</b>	Matrix of formation of other capital stocks
<b>9 x e</b>	Matrix of revaluations (including a decrease of stocks) because of environment related damages of environment related stocks (e.g. forest damages) <sup>1</sup>
<b>9 x e</b>	Matrix of revaluations (including a decrease of stocks) because of environment related damages of other stocks (e.g. damage of buildings) <sup>1</sup>
<b>10 x 1-3</b>	Recycling of material previously emitted
<b>10 x 12</b>	Formation of emissions in environmental media
<b>11 x 12</b>	Pollutants changing from one environmental media to another by immissions

<sup>1</sup>) Revaluations can be subdivided into environment related and other, they may be positive also.

<b>11 x 13</b>	Functional relation between immissions and damages in physical units (corresponding to 11 x e, 11 x f)
<b>11 x e</b>	Entrance of immissions into environment related stocks (monetary units for stocks, physical units for immissions)
<b>11 x f</b>	Entrance of immissions into other stocks (monetary units for stocks, physical units for immissions)
<b>12 x 4-6</b>	Use of environmental media in production activities
<b>12 x 7</b>	Use of environmental media in consumption activities
<b>12 x 8</b>	Use of environmental media in capital formation activities (e.g. use of protected areas for power plants)
<b>12 x 11</b>	"Output" of immissions by environmental media
<b>12 x 12</b>	Equalization (-) for the use of the environmental media (12 x 4-8)
<b>12 x 13</b>	Functional relation between environmental media and damages (for estimating damages directly)
<b>12 x 17</b>	Export of environmental media
<b>13 x 9</b>	Functional relation between damage in physical units and revaluations in monetary units
<b>14 x 4-6</b>	Matrix of value added (IO-statistics)
<b>14 x 9</b>	Revaluations because of environmental damages which are related to GDP (causality)
<b>17 x 1-3</b>	Vector (matrix) of imports (IO-statistics)
<b>17 x 12</b>	Import of environmental media from abroad
<b>c x e</b>	see a x e
<b>c x f</b>	see a x f
<b>d x 12</b>	see b x 12
<b>d x e</b>	see b x e
<b>d x f</b>	see b x f

**CHINA'S RESEARCH ON RESOURCE ACCOUNTING AND ITS  
APPLICATION TO THE NATIONAL ECONOMIC ACCOUNTING SYSTEM**

**Jinchang Li**

Environmental Strategy Research Center of China

**1. Overview of the research on the environmental situation in general**

In cooperation with Dr. Robert Repetto and other experts of the World Resource Institute and with the support of the Ford Foundation of the United States, we have developed the research on natural resource accounting and its application to the national economic accounting system since August 1988. There are about one hundred experts which have taken part in the research work. They are selected and organized from scores of units that include the Development Research Center of the State, the State Planning Commission, the State Statistics Office, the Environment Protection Bureau of the State, the Ministry of Geology and Minerals, the Ministry of Forestry, the Ministry of Agriculture, the State Land Bureau and more than ten other Ministries and Commissions concerned, and five Provinces (Guizhou, Jilin, Heilongjiang, Inner Mongolia and Shandong). Hence, there are more than ten government officials of higher rank (at least, they are the vice minister), which have held the post of council for the research project.

At first we have considered physical accounts, value accounts, stock accounts, flow accounts, individual resource accounts and synthetical resources accounts for minerals (including energy), forest, grassland, water, land and the other major natural resources (called "the re-

sources" for short in the following), and the issues of resource accounting's application to the national economic accounting system, according to the principle that one starts with the immediate<sup>1</sup> and easy and some specific areas first, and then continues with the more complex,<sup>2</sup> difficult phenomena in its entirety. Up to now we have only worked on the theory, principles and methods on resource accounting, that is to say, we have not gone into the stages of advanced research and implementation. In the near future, we shall go on with researching, enforcing the projects of developing resource accounting and its application to the national economic accounting system, choosing on the one hand the Ministry of Geology and Minerals and the Ministry of Forestry, on the other hand Inner Mongolia, Guizhou, Linyi area of Shandong and other Provinces where the basic conditions are relatively good to launch the pilot accounting project. According to the experiences derived from conducting tests at the areas selected, we shall be able to implement the enforcement project and put forward the rational policies, measures and proposals that can form a complete set together with the **enforcement project**, finally suggesting the government to adopt that and make an overall enforcement for that. It is obvious that there are lots of difficulties to be overcome and a long-run process is ahead of us.

At present there are two main lines of thinking and practice all over the world. The one is the **resource-accounting-oriented**, and it includes the environmental accounting; the other is the **environmental-accounting-oriented**, but it includes the resource accounting. Since resource is a component of the environment, environment is one kind of resources. Therefore, all of the environmental issues, for example ecological disruption, environmental pollution and so on, are caused by the unreasonable development and utilization of the resources, and the resource issue is closely related with environment. Thus both the resource accounting and the environmental accounting seem to have the same goals. Hence, in the view of the research subjects and the developmental trend, resource accounting and environmental accounting will be inevitably **combined** in the future, and a comprehensive system of the resource-oriented

---

<sup>1</sup> - such as the value of natural resources

<sup>2</sup> - such as the value of ecology and air

accounting as well as environment-oriented accounting will be established. It is the common goal of our scientific research on the resource accounting and the support of the Ford Foundation to make our research achievement not only applicable to China, but also to avail of international reference data. Precisely because of this we badly need to learn from the experts of other countries and the international organisations.

## 2. The main research contents and achievements

We have achieved several preliminary research results since August 1988. Up to now, several books and technical papers have been published<sup>3</sup>. According to the needs and through expanding the research contents step by step, we have formulated a comprehensive scope of the projects, that is the research now comprises resource accounting, resource valuation, resource assets, resource industries and various other resource issues. In our understanding, if the problems on the resources' value, the resource assets, and the resource industries are not yet fully understood, the research on resource accounting could not very well progress because all these problems are closely interrelated. For example, the resources have value and a reasonable pricing method must be determined first for making the resources accountable in value terms. Therefore, according to the conventional ways of thinking, the resources provided by nature completely (that is without the participation of human labor) or the resources that can not be traded on the market otherwise have no value. As a matter of fact, the so-called resource price determined by the conventional pricing method is the price of the resource as a product that is the price of raw material. Its price formation only includes the "costs" and profit, whereas the price of the resources itself is not included so that a serious price misrepresentation has been existing in China: "high price of product, low price of raw material, and no price of the resources", and "one ton of raw coal can not exchange one ton of sand", "one barrel of raw oil can not exchange one bottle of wine" etc. Under such circumstances, it is obvious that the research on resource value accounting is very difficult. However, we assume that the prospects of development of resource value, the theory of value, and the

---

<sup>3</sup> For Example: "Preliminary Study on Natural Resource Accounting" and its English version; "Natural Resource Accounting for Sustainable Development"; "On Resource Accounting"; "On Resource Industry"...



pricing method of the resources can be established on the basis of the theory of efficiency, the theory of wealth, and the theory of land rent. Adopting the conception of value the "value philosophy" is the so called theory of efficiency: such kind of value is a certain function or effectiveness of how an object meets the needs of a subject. The resources are the objects, and the human beings are the subjects. Because the resources have the function to meet human needs, they have value to the human beings. The so-called theory of wealth says that the resources are the material base of social and economic development. Therefore, it is a valuable thing, and one kind of natural assets. The so-called theory of land rent says that a piece of land (land being an other word for resource) is equivalent to a capital, and the land rent is equal to the annual fixed interest earned by depositing this capital with a bank. The various kinds of the resources' value (or price) are not the same at all, because of great differences, like variety in content, quality, and the regional differences. Based on the former considerations, we recognize that the resources have value, first of all. The value depends on its availability to human beings and its amount rests on its scarcity and the conditions of development and utilization. On the other hand, according to our viewpoint that resource extraction industries should make the resources and the resources' products become a joint outcome, the value of the resources can be divided into two parts: the first is the value of the resources itself; the second is the value produced by the social investment to the resources reproduction. So the basic pricing method of the resources can be determined and it has been discussed in the writings on the value of the resources. In order to take proper account of the resources value on the basis of the economic rights and interests of the owner of the resources, we may start with using these methods on collecting resource rents, resource taxes and the compensation for the use of resources and environment before the pricing method for the resources itself is formally determined.

Conducting the physical accounting first and doing the value accounting later on; doing the individual resource accounting first and conducting the comprehensive resource accounting later on; and then incorporating the resource accounting into the national economic accounting system; and making the enforcement project for the resource accounting, putting forward the corresponding policies and measures and standardizing the enforcement project by legislation at last: This would be the basic idea of the organization of the framework and the

Figure 1: The System of Resource Accounting

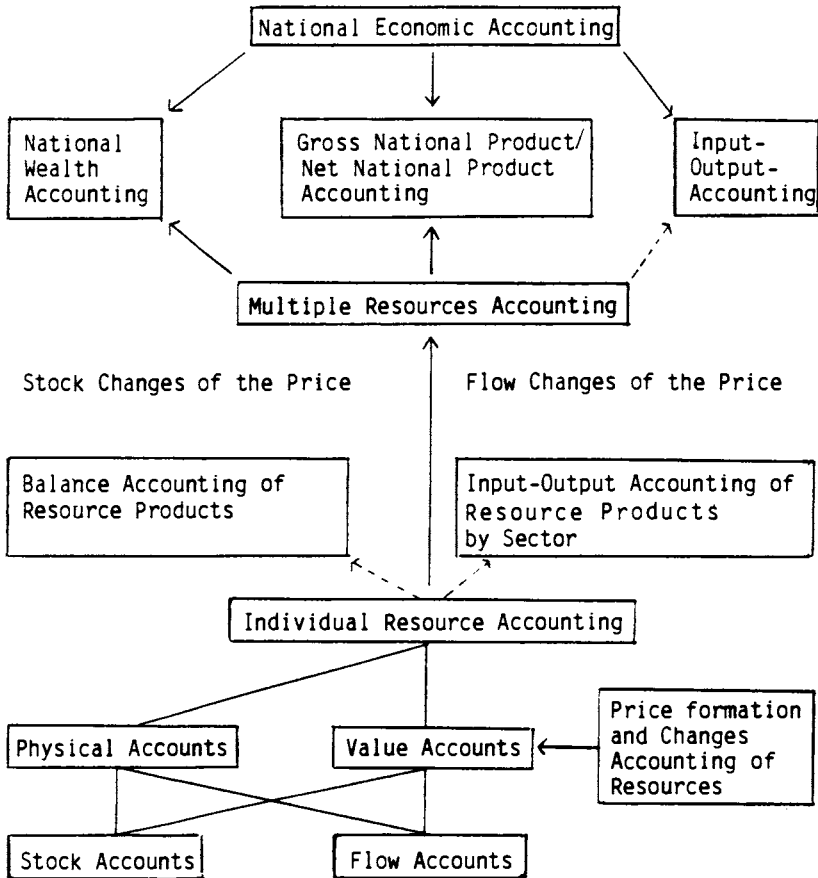

Note: The straight line shows that the work should be finished in the near future.  
The dotted line shows that the work should be finished in the future.

**Table 1: Individual Resource Accounts**

- 1. natural resources:
- 2. type:
- 3. reporting period (19..):
- 4. prepared by:

	measurement unit A	physical amount B	unit price C	magnitude of value D=B*C
5. opening stock				
6. increase during the year (6 = 7 + 8 + 9)				
7. new discovery				
8. revaluated increase				
9. ....				
10. decrease during the year (10 = 11 + 12 + 13)				
11. exploitation				
12. readjusted decrease				
13. losses				
14. net changes (14 = 6-10)				
15. closing stock (15 = 5 + 6-10) = 5 + 14				

**Table 2: Net changes of the Multiple Resource Value**

Unit: 0.1 billion Yuan

	net change of the multiple resource value						
	$\Delta R = \sum_{i=1}^n \Delta R_i, i=1,2,\dots,n$						
	mineral $\Delta R_1$	land $\Delta R_2$	forest $\Delta R_3$	grassland $\Delta R_4$	water $\Delta R_5$	.....	total $\Delta R$
1981							
1982							
1983							
.....							
1989							
1990							

method of our research work on resource accounting. The following Chart will show the system of resource accounting (Figure 1).

The table pattern for the international resource accounting is shown in the following (Table 1 and Table 2).

Although resource accounting is a major part of the national economic accounting system, the key problem is how to incorporate resource accounting into this greater system. Based on preliminary research achievements we think that they can be combined in terms of the following three aspects.

**First**, incorporating the resource accounting into national assets accounting. Resources are an original part of the national assets, so that the total of the resources assets, the fixed assets, and the circulating assets comprise the entire national wealth. The basic accounting formulae are:

$$\text{National Assets} = \text{Fixed Assets} + \text{Circulating Assets} + \text{Resource Assets};$$

$$\begin{aligned} &\text{Opening stock} + \text{Increase within the period} - \text{Decrease within the period} \\ &= \text{Closing Stock.} \end{aligned}$$

While the increase within the period includes discovery, growth, reestimated increase and others, the decrease within the period includes exploitation, various losses and the revaluated decrease and others. Table 3 shows the pattern for the national wealth accounting.

**Second**, combining the resource accounting with gross national product (GNP), net national product (NNP) and the capital formation. Because the conventional GNP and NNP have not incorporated the resource accounting they have produced a wrong leading function for the social and economic development, that is the social and economic development to go merely according the output value and its growth speed. For remedying this defect and pledging the sustainable, stable and coordinated development of society and economy, the increase of the

resources within a certain period must be treated as one part of the capital formation, and the decrease (depletion) of the resources within a certain period must be treated as the losses of the fixed capital on the basis of the conventional GNP and NNP. That is the so-called resources depreciation. However, in order to distinguish between resource depreciation and the depreciation of the fixed assets, we prefer to use the term **resource depletion**. That way, the conventional GNP and NNP can continue to be used and both of them can be supplemented and perfected by introducing a new concept of GNP (viz. GNP') and a new concept of NNP (viz. NNP'), by the adjustment due to resource accounting. Therefore, comparison and analysis between GNP and GNP', or NNP and NNP', respectively, can be done.

**Third**, compiling the input-output accounts for the activities of the resource industries. The research work on this project has not been carried out for the time being, however.

Up to now, the research work that has been mainly made by us is the **second** item mentioned above. According to the principles of the national economic accounting system, we have realized that the total of the goods produced is equal to the total of the goods used for consumers and investment, under the condition that there is no balance of trade in a certain period. That is to say, the production and the use of GNP is equal in amount. To our knowledge, the total output (TO) is the monetary manifestation of the whole achievements by economic, scientific and technical, and social activities (ESTSA) in a certain period. The intermediate consumption (IC) is the monetary manifestation of the goods and services consumed in the ESTSA in a certain period. The depreciation or the capital losses (CL) is the monetary manifestation of the fixed assets consumed in the ESTSA. The relation between GNP, NNP and TO, IC, CL can be shown by the following formula (C representing the private consumption, G representing the government consumption, and CF representing the capital formation, where CF1 is fixed capital formation, and CF2 representing increase in stocks so that  $CF = CF1 + CF2$ . M represents the import volume, X represents the export volume):

$$TO - IC = GNP$$

$$TO - IC - CL = GNP - CL = NNP$$

From the use point of view, the formula is:

**Table 3: National Wealth Accounts**

1. reporting period (19.):
2. measurement unit: 0.1 billion Yuan
3. prepared by:

	total A = B + C + D	fixed assets B	circulating assets C	resource assets D
4. opening stocks				
5. increase during the year (5 = 6 + 7 + 8)				
6. new discovery				
7. growth				
8. revaluated increment				
9. decrease during the year (9 = 10 + 11 + 12)				
10. exploitation				
11. various losses				
12. revaluated decrease				
13. net changes during the year (13 = 5 - 9)				
14. closing stock (14 = 4 + 5 - 9 = 4 + 13)				

$$C + G + CF + (X - M) = \text{GNP}$$

$$C + G + (CF - CL) + (X - M) = \text{NNP}$$

Both views combined, the formula is:

$$\text{TO} - \text{IC} = C + G + CF + (X - M) = \text{GNP}$$

$$\text{TO} - \text{IC} - \text{CL} = C + G + (CF - \text{CL}) + (X - M) = \text{NNP}$$

Because the increase of the resources is one component part of the capital formation, total output value is increased by this increment, and it is represented by CF3. On the other hand, the decrease of resources is a kind of losses, going in for depreciation and being represented by RD. RD subtracted from CF3 is the net changes of the resources, denoted with  $\Delta R$ . On that basis the former formula can be changed as follows, by way of incorporating the resource accounting.

In the view of production, the formula is:

$$\text{TO} - \text{IC} + \text{CF}_3 = \text{GNP} + \text{CF}_3 = \text{GNP}'$$

$$\text{TO} - \text{IC} - \text{CL} + (\text{CF}_3 - \text{RD}) = \text{NNP} + \Delta R = \text{NNP}'$$

In the view of production combined with use, the formula is:

$$C + G + (CF + \text{CF}_3) + (X - M) = \text{GNP}',$$

$$C + G + (CF - \text{CL}) + (\text{CF}_3 - \text{RD}) + (X - M) = \text{NNP}',$$

where

$$CF + \text{CF}_3 = \text{CF}_1 + \text{CF}_2 + \text{CF}_3 = \text{CF}'$$

In the view of production and use combined, the formula is:

$$TO - IC + CF3 = C + G + (CF + CF3) + (X - M) = GNP'$$

$$TO - IC - CL + (CF3 - RD) = C + G + (CF - CL) + (CF3 - RD) + (X - M) = NNP',$$

or:

$$TO - IC - (CL + RD) + CF3 = C + G + (CF + CF3) - (FD + RD) + (X - M) = NNP'$$

$$TO - IC - CL + CF3 = C + G + CF' - CL + (X - M) = NNP',$$

where

$$CL' = CL + RD.$$

Consequently, the relation among GNP, NNP, CL and the adjusted indicators GNP', NNP', CL' on the basis of resource accounting can be shown in the following formulae:

$$GNP' = GNP + CF3$$

$$\text{minus } CL' = CL + RD$$

---

$$GNP' - CL = (GNP - CL) + (CF3 - RD)$$

$$NNP' = NNP + \text{deck. R}$$

Thus it can be seen, there are three kinds of specific cases:

- (1)  $\text{deck. R} > 0$ , so that  $CF3 > RD$ ,  $NNP' > NNP$ , which shows that if the resource volume is increased the reserve strength of economic development would be enlarged;
- (2)  $\text{deck. R} = 0$ , so that  $CF3 = RD$ ,  $NNP' = NNP$ , which shows that the growth and the decline of the resources is balanced (the development of resources is synchronous with the economy);



**Table 4: The Relation between the multiple conventional indicators  
GNP, NNP and the new (adjusted) indicators GNP', NNP'**

Unit: 0.1 billion Yuan

	conventional indicators		changes of the magnitude of value of multiple resources			new (adjusted) indicators	
	GNP	NNP	increase CF3	decrease DR	net change $\Delta R$	GNP'	NNP'
	1	2	3	4	5 $5=3-4$	6 $6=1+3$	7 $7=2+3-4$ $=2+5$
1981							
1982							
1989							
1990							

- (3)  $\Delta R < 0$ , so that  $CF_3 < RD$ ,  $NNP' < NNP$ , which shows that the resource base has been weakened, the ecological environment has been deteriorated, and the economic development has been restricted. If this has happened for a longer period the resource basis will turn out to have decreased during the economic development.

The pattern for incorporating the resource accounting into the national economic accounting system will be as follows (Table 4).

Abundance and scarcity of the resources, growth and decline of the resources and their influence can be seen from the data compiled according to Table 4. Of course, the problems that exist in the field of the resources can not be solved by the resource accounting alone, and this is not the last aim of our research work. Nevertheless, putting resource accounting forward is a breakthrough in the theory of knowledge, and its significance may compare favourably with the epoch-making event of finding the earth is round. There are lots of scientists who think that in the field of science putting forward the problems is often more important than solving them. The reason is that, in a certain sense, raising the problems is equal to solve half of them. On the other hand, the investigation and study for solving the problems is just like "the ten-months-period of pregnancy", and the process of solving the problem like "giving birth to a child in one morning". At present, the fact that the current national economic accounting system has had the wrong leading function to the economic and social development has been discovered and illustrated by the preliminary achievements of resource and environmental accounting. Counter-measures for remedying the deviation of social and economic development caused by such kind of wrong leading function may be sought by the present kind of scientific research. Hence, the establishment of the enforcement project for the resource and environmental accounting in application to the national economic accounting system, putting forward the general and specific policies, measures and proposals, and standardizing them through legislation are the primary measures for implementing the strategies for sustainable development. The reason is that that way the state and the reserve strength of the social and economic development can be more completely and more objectively estimated, and the management of property rights of the resource assets can be strengthened. It will also be helpful to determine the role of property rights to serve as a system for the use and acquisition of the

resources. Although the research work itself obviously can not solve all the problems which have appeared in the field of resources and environment, the data base can be put forward as a judgement criterion of the operation measures for solving these problems and making sensible and effective utilization of the resources and the environment at large. Only thanks to such kind of basic function the importance of the research work has become more obvious. It is closely related with urgent issues encountered by the human society at present. The issue of the system's innovation for the long-run strategies of sustainable development is another main reason. In brief, studying and solving the resource issues and the problems that are closely related therewith (such as resource value, resource assets and resource industry, environmental accounting and its application to the national economic accounting system) is one of the most topical, the most effective, and the most fundamental measures for promoting the perpetual utilization of the resources, the ecological and environmental protection and the sustainable development for human society and economy at large. Therefore, it is of immediate, present significance and far-reaching historical importance as well.

### 3. Case study on forest resources

In order to explain the practical method of the resource accounting, we take the forest resource accounting as the example. China is poor in forest resources. On the basis of the Third Forest Inventory carried out during 1984-1988, the analysis of the results show that the forest area has been slightly increased; however, the growing stock and quality of forest has decreased to some extent. Especially the standing volume of over-mature timber forest was greatly decreased and the loggable resources have been approaching the verge of exhaustion. Practically, the increase of forest area is mainly due to planting. During these years thus the "Three North Windbreak Forest" (Northeast; Northern China; and Northwest), the coastal windbreak forests and the plain forest area have slightly increased. Another reason is that the percentage of the area of forest plantation has expanded from 20 to 26 p.c. of the total area. The decrease of the forest growing stock is mainly due to over-cutting of the biggest public forest area of the nation. The decrease of growing stock of over-mature forest has been about 50 percent in the past 7 years. That is an annual decrease of about 110 million cubic meters. If things continue like this, then the standing volume of nature forest will be exhausted in 5 or

**Table 5: Consumption of the forest  
resources in China, 1988**

Unit: 10,000 cubic meters

Production/Consumption of Timber							
sub- total	timber to central govern- ment	self sale to other province	local use	collec- tive use under country level	farmer's consump- tion	loss during trans- porta- tion	others
23314.8	4716.2	2624.3	4031.6	2510.2	8177.3	570.6	684.6
61.3	12.4	6.9	10.6	6.6	21.5	1.5	1.8

Table 5 (continued):

Production/Consumption of Non-timber					calamity	total
subtotal in forest areas	fuelwood opera- tion	construction	culture	others		
13806.4	12361.1	152.2	912.8	380.4	912.8	38034.0
36.3	32.5	0.4	2.4	1.0	2.4	100.0

6 years. The sharp increase of the forest consumption is mainly caused by excessive social consumption. For example, the annual consumption from 1973 to 1976 was 196 million cubic meters, the annual consumption from the years 1977 to 1981 was 294 million cubic meters, and the annual consumption from the year 1984 to 1988 is 328 million cubic meters. **Table 5** shows China's situation of the forest resources.

A special pricing method for forest resources is the base of forest resource value accounting. According to the resources value outlook and the basic pricing method put forward the pricing formula for determining the price of forest resources is as follows (where the value of the resources itself is manifested by the resource tax):

$$P_T = \frac{\sum_{t=1}^T F_t (1+i)^{T-t} \cdot (1+\rho)^t (1+C) \cdot Q_d \cdot E_d}{V \cdot (1-S)^T \cdot Q_s \cdot E_s}$$

where  $P_t$ -- value (or price) of the T-year-old stand forest resources (Yuan/Cubic meter)

$\sum_{t=1}^T F_t (1+i)$ -- the accumulated costs of investment by human, financial and material resources in the year of T (Yuan/ha),

- t-- the number of years, t = 1, 2, 3,.....,T
- i-- the average interest rate (%)
- $\rho$ --the average profit rate (%)
- c-- the tax rate of the resources (%)
- V-- the stock volume of the stand forest in a unit forest area of the year T
- S-- the annual withdrawal rate (%) of the stand forest resources (cubic meter/ha)
- $Q_d$ -- quantity of demand
- $Q_s$ -- quantity of supply
- $E_d$ -- elasticity coefficient of demand
- $E_s$ -- elasticity coefficient of supply

All of the above parameters can be determined according to available statistical data, by practical experience or through the pilot study. In order to make the problem clear we have made an account of the value (or price) of the 20-year-old China fir in the artificial forest of a certain forestry center located in the south of China. The results show that the value per cubic meter is 180 Yuan.

Table 6. China Forest Resource Account, 1988

	physical amount		value 0.1 billion Yuan
	structure (%)	10,000 cubic meter	
1. stock	..	809149.0	14402.8
2. growth during the year (flow amount)	..	32946.0	586.4
3. losses during the year (flow)	100.0	38034.0	677.0
(1) timber production	58.0	22059.7	392.7
(2) construction in forest area	0.4	152.1	2.7
(3) consumption in culture operation	2.4	912.8	16.2
(4) consumption of energy	32.5	12361.1	220.0
(5) drain by calamities and other losses	3.9	1483.4	26.5
(6) other consumption	2.8	1064.9	18.9
4. net changes during the year	..	- 5088.0	90.6
5. closing stock	..	804061.0	14312.2

It is well known that it needs to undergo a long process from putting the pricing method and the theory of value of the resources into the actual life, until the method and the theory are extensively accepted by the public and adopted by the government. The method adopted in a way combines the theoretical price with the market price. Proceeding like this, the average price of forest is 178.7 Yuan/cubic meter. **Table 6** shows our preliminary results on the forest resource accounting.

According to this, in 1988 consumption of the forest resources is 380 million cubic meters, the value of this being 67.6 billion Yuan. Compared with the same amount of growth, which are 330 million cubic meters or 58.64 billion Yuan, the forestry deficits are 50 million cubic meters or 9.06 billion Yuan, respectively. This results from the over-consumption of forest resources by the human society and the insufficient investment to reproduce the forest resources. On the other hand, according to the national statistical figures, the output value of the standing forest is 14.0 billion Yuan (1988), but the actual output value provided by forest resources is 58.44 billion, as shown above. In other words, the national statistical number only meets 23.8 percent of the total amount, and the rest, that is 76.2 percent of the value, has not been taken into account: due to this it has been ignored by the whole human society, an obvious slip.

**Table 7** shows the adjusted situation on the basis of adjusting the current gross national product and net national product, by reference to the growth and decline of the forest resources, as developed in Chapter 2.

In **Table 7** we can see that the GNP of the year 1988 is 1,3984.2 billion Yuan, and GNP' is 1,4570.6 billion Yuan (that is  $1,3984.2 + 586.4$ ); NNP is 1,3572.3 billion Yuan, and NNP' is 1,3481.7 billion Yuan. That means, the net national product has decreased by 0.67 percent, just because of the deficits of the forest resources.

**Table 7. The relation between the conventional GNP, NNP and the new (adjusted) GNP', NNP', according to the growth and decline of the forest resources**

	1980	1981	1982	1983	1984	1985	1986
GNP (0.1BY)	4470.0	4473.0	5193.0	5809.0	6962.0	8557.6	9696.3
Net Product of Fixed Assets (0.1BY)	3707.7	3984.3	4299.9	4694.5	5069.8	5457.9	6224.5
Depreciation Rate (%)	4.1	4.1	4.1	4.2	4.4	4.7	4.9
Depreciation value (0.1BY)	151.8	163.4	176.3	197.2	223.1	256.5	475.1
NNP (0.1BY)	4318.2	4609.6	5016.7	5611.8	6738.9	8301.1	9221.2
CF3 (0.1BY)	73.9	73.6	117.5	117.1	116.7	305.3	494.6
GNP' = GNP + CF3 (0.1BY)	4543.9	4846.6	5310.5	5926.1	7028.7	8862.9	10190.9
RD (0.1BY)	81.9	81.6	130.1	129.7	129.3	332.4	538.4
CF3-RD = $\Delta R$ (0.1BY)	-7.9	-8.0	-12.6	-12.6	-12.6	-29.1	-43.8
NNP' = NNP + $\Delta R$ (0.1BY)	4310.3	4601.6	5004.1	5599.2	6726.3	8274.0	9177.4

Table 7 (continued):

	1987	1988
GNP (0.1BY)	11301.0	13984.2
Net Product of Fixed Assets (0.1BY)	7067.3	8237.7
Depreciation Rate (%)	4.9	5.0
Depreciation value (0.1BY)	346.3	411.9
NNP (0.1BY)	10954.7	13572.3
CF3 (0.1BY)	644.7	586.4
GNP' = GNP + CF3 (0.1BY)	11945.7	14570.6
RD (0.1BY)	701.7	677.0
CF3-RD = $\Delta R$ (0.1BY)	-57.1	-90.6
NNP' = NNP + $\Delta R$ (0.1BY)	10897.6	13481.7

Note: BY ---- One Billion Yuan



# **NATURAL RESOURCE ACCOUNTING: The Norwegian Experience**

**Øyvind Lone**  
**Ministry of Environment**

**Karine Nyborg**  
**Asbjørn Aaheim**  
**Central Bureau of Statistics,**

## **1. BACKGROUND**

The Norwegian work on Natural Resource Accounting (NRA) was initiated in 1974 by The Ministry of Environment. An initial research report on concepts and systems was prepared by the Ministry in 1974, followed by pilot accounts for energy, land use and fish resources. An official report and a White Paper was presented in 1977. Since 1978, the Central Bureau of Statistics (CBS) has been responsible for NRA work. Accounts for energy, fish and forest resources, selected minerals, land use and air pollution have been published.

The aim of preparing such accounts was brought forward by a growing concern about the scarcity of natural resources in the late 1960s. At this early stage, the ambition was to establish not only a natural resource accounting system, but also a natural resource budgeting system. These concepts could be compared to the concepts of National Accounts and National Budgets, and serve as tools to enable central authorities to monitor and manage the national stock of natural resources.

However, the resource budgets were never elaborated. One reason for this was that their political role, compared to national budgets and long-term government economic planning, was not clear. Hence, when this was recognized around 1984, one of the original reasons for

developing resource accounts no longer existed. At this time, the accounts for energy, fish, forests, minerals and land use had already been developed.

This situation required a rethinking of the purposes and usefulness of the resource accounts, a process which illuminated the fact that the design of the accounts is crucial to determine the possible applications of the data. Also, the success of the resource accounts depends on the extent to which they can be integrated into existing planning tools.

Today, only the energy and air pollution accounts are updated regularly, and serve as tools for an integrated environmental and economic policy planning. Accounts for fish, forests, mineral resources and land use are now updated only on a very restricted level.

Below, we will turn to the various resource accounts which have been developed in Norway, giving a brief description of their structure, contents and applications. We will then give a review of their success or failure to become part of an integrated economic and environmental policy planning, and the lessons which can be drawn from this. Finally, our experience so far has lead to specific plans of future work, which we will briefly dedscribe.

## **2. THE NORWEGIAN RESOURCE ACCOUNTS**

The main ideas of the Norwegian NRA work were:

- To provide an information system for natural resources, starting with the resource stocks, through extraction and processing to end-use and disposal, including recycling, waste and pollution, and other environmental effects.
  
- To measure resources in physical units throughout, and thus be able to provide material and/or energy flows and balances data.
  
- To connect these physical accounts and measurements (wherever possible) to national accounts, economic statistics, and econometric forecasting and analysis models.

A major characteristic of the Norwegian resource and environmental accounts is that the classification of sectors and commodities are compatible with the UN Standard of National Accounts (SNA), thus making links to the variables of the SNA possible.

**Energy Accounting**

The energy accounts give annual information on reserves, extraction, conversion and end use of energy. All data are measured in physical units. The resource accounts consist of data on both stocks and flows. The flow accounts comprise an extraction part, a conversion part (refineries etc.), and an end-use part (c.f. figure 1). In the energy accounts, much emphasis is put on the end-use part, as energy is an important input for nearly all economic activities. End-use of about 120 sectors is specified, the sectoral level corresponding to the disaggregated economic model MODIS IV. The accounts specify extraction, conversion and end use of eleven energy commodities (coal, coke, fuel wood, 6 petroleum products, electricity and district heating). The figures on fuel wood are, however, only roughly estimated.

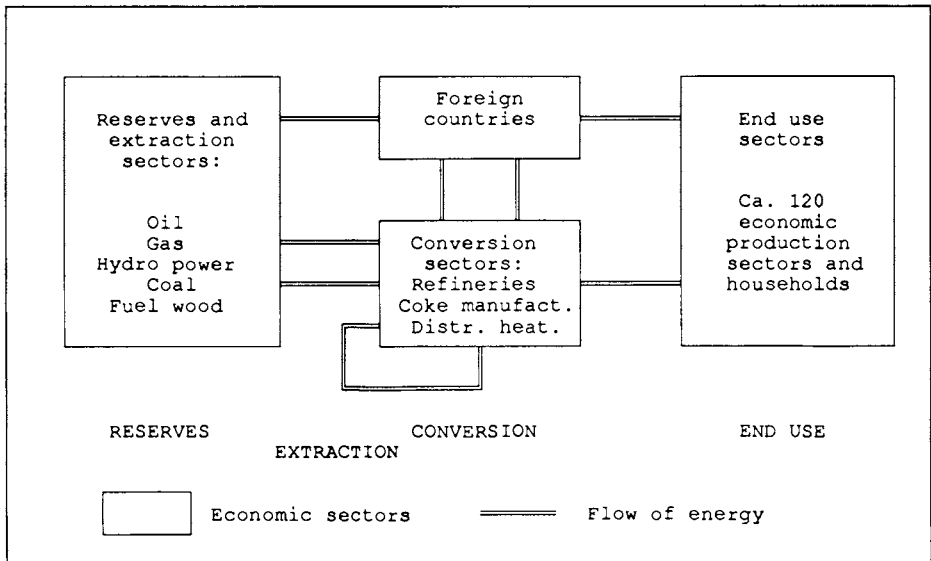

**Figure 1. Structure of the Energy Accounts**

Energy accounting was given top priority early on, and has kept that priority throughout. The data of the energy accounts are easily used in connection with various macroeconomic models, due to the SNA compatible classifications. This has proved a highly valuable characteristic. In the early years, the emphasis was on projecting electricity demand, as a basis for decisions on development of hydro-electric power projects. This was both a major economic issue, because of the costs involved, and an important environment issue, because of the strong environmentalist opinion in favour of preserving free-flowing rivers from further development. Later on, the energy account has proved a valuable source of data for estimating emissions to air.

The reserves part of the energy account has also been used in attempts to estimate the value of the Norwegian petroleum stock (Aslaksen et al. (1990)). However, the conclusion of this work was that the uncertainties of future prices and costs, together with the uncertainty of the actual size of the stocks, in practice make such estimates useless as tools for optimal policy planning.

### **Air Pollution Accounting**

The accounts for air pollution consist of emission data, disaggregated at the same sectoral level as the end-use part of the energy accounts. Strictly speaking, they are not accounting systems, but mere data inventories.

The emission data are based on the end-use part of the energy accounts and some other information, including data on process emissions from a number of large industrial plants. Up to now accounts have been made for 9 different emission components.

Like data from the energy accounts, the emission data can easily be utilized in macroeconomic modelling. At an early stage, this was used to project the effects on emissions to air of current government policy. Later on, the combination of emission data and economic models has also been used to analyse the macroeconomic and environmental effects of alternative economic and environmental policies. The latest example of such analyses is the work done on request

by the interministerial committee on Norwegian climate policy, where the macroeconomic consequences of introducing a CO<sub>2</sub> emission tax were studied. Thus, the integration of air pollution data and economic models provides the opportunity not only to analyse the effect on the environment of economic policies, but also the effect on the economy of changes in the environmental policy.

### **Accounting for Other Resources**

The stocks of fish are classified by type and age. The accounts also contain some geographical information, as fish is a mobile resource. Relatively few sectors use fish as an input factor in their production. Hence, little weight is put on the consumption part of the fish accounts. In contrast, the trade of fish is described in some detail, since fish is an important export commodity for Norway. However, little came out of the analytic work linking fish accounts to economic models, mainly because estimation of foreign demand for Norwegian fish turned out to be a very difficult task.

The forest accounts are mainly elaborated on the reserves and extraction parts. The consumption parts are closely connected to the energy accounts, since wood is either transformed to other products or used as energy. Some work has been done using the data of the forest accounts in projecting demand for forest products. However, the aggregation level of the macroeconomic models was far too high to serve as a basis for forest management planning.

Much work was done on land use accounting, and a large amount of new information on land use and land use changes was produced. A consistent land use classification was developed, and statistical and cartographical data was collected for a national land use survey based on about 6000 sample points. A system was established for land use planning, accounting for present, planned and changed-according-to-plan land use at the county and municipal level. This system has been tried in most counties and adopted by several of them. At the national level, a model to explore economic and land use effects of various agricultural policies was developed. Some of this work is being further developed, but mainly for the use in local and

regional planning.

Mineral accounts was also developed. At an early stage, some attention was paid to national reserve estimates of heavy minerals, as these had been subject to national management for hundreds of years. Later on, prices became too low to allow for extraction, and most Norwegian heavy mineral mines were closed down.

The accounts for sand and gravel was established as a part of the mineral accounts, and may be further elaborated as a basis for long-term planning of the development of these resources at a municipal level.

### **3. LESSONS: SUCCESS OR FAILURE?**

Both the air emission and energy accounts have proved valuable in analysing and formulating integrated economic, energy and environmental policies. The data are frequently used, and the analyses based on them have gained widespread acceptance as guidelines of possible policy implications.

The accounts of fish, forests, minerals and land use have not been similarly successful. The data seem to be infrequently used, and they are not part of operating, integrated economic and environmental analytical frameworks, at least not at a national level. In some cases, vast amounts of work have been undertaken on issues which seem to have been of little use to either the public and scientists.

The reasons for this can be explained as follows. Several conditions have to be fulfilled to make data useful for research or practical planning purposes. One of them is that the data must be classified in a manner which allows the connection to other relevant data. This is a condition which we have been concerned about, and which is also carefully observed in the present draft on integrated environmental and economic accounting by the UN Statistical Office. However, there are some additional conditions, of which we will mention some:

-The data must be relevant to current political tasks. Of course, new information can create new political or research initiatives, but the mere existence of data will not change the policy. The basic point is, that if the data give information on fields where the authorities cannot interfere, or issues which are presently not judged to cause problems, the data will not be much utilized. This has probably been part of the problem of the Norwegian forest and land use accounts, as there has not been much political concern of the national management of these resources.

-Modelling tools to analyse the data are required. The link to macroeconomic models has been crucial to the success of the Norwegian energy and air pollution accounts. However, several environmental problems are closely related to local damages; results on a national or sectoral level might thus be of lesser interest. In other cases as well, the macroeconomic models do not include those variables which could be linked to environmental data in a relevant manner. Other analytical devices are then needed to utilize the data. Data on some issues may be used directly without further elaboration, but in most cases one needs a framework to properly understand the implications of the available information. For example, the fish accounts provide data which could be of importance in managing fish resources, but so far there is no analytical tool available which can utilize the data to answer relevant questions.

-Existence of political bodies capable of implementing results. If there is no organization or political body which may use the data and analyses for practical purposes, the information will be of limited interest.

Of course, data on most issues might be useful to particular scientists, even if there seems to be no apparent, immediate use of the research. This is, however, a question of priorities.

The three conditions mentioned above can to a large extent explain why the experience with the Norwegian resource accounts have been so mixed. However, lack of research resources, and perhaps wrong priorities as well, can also explain why some of the attempts failed. For instance, the rapid depletion of fish stocks has turned out to be an important environmental issue, and this is obviously linked to the way fishery policies are implemented, including economic factors. Hence, using data on fish resources in connection with economic modelling

could be of great value. This would, however, require the creation of new econometric models, since the existing ones are not suited for such tasks.

The lessons from the Norwegian work so far can thus be outlined as follows: When the structure and subjects of environmental accounts are chosen, priority should be given to those projects which aim to analyse or to solve specific problems. Problems one wishes to resolve should be formulated in the first place, and one should then design the tools to solve the problem; one should not go the other way round. In our opinion, the consciousness of the aim of each environmental account is more important than designing an overall system which can deal with all kinds of environmental issues in the same framework.

#### **4. MANAGEMENT TOOLS: FURTHER DEVELOPMENTS**

In environment and resource modelling in Norway, priority will now be given to the development of tools for evaluating economic growth and environmental development within a common framework. The aim of this work is to help politicians make decisions on economic and environmental issues, and to analyse the effects of policy instruments. The efforts will, however, be concentrated on economic models as a starting point, not on valuation of environmental goods within a national accounting framework such as UNSO is proposing. The work will partly aim at integrating environmental and natural resource data, measured in physical units, into the macroeconomic models. Another part of the work is to make the models more suitable for analyses on environment and natural resource management, for instance by elaborating on dynamic aspects.

In the macroeconomic models which are currently used in Norway, indicators of the state of the environment are calculated as consequences of economic growth. Consequences for economic growth of a changing environment are, however, not taken into account. The inclusion of this mutual relationship in macroeconomic models may be of interest for several reasons.

One important reason is that a higher environmental quality may cause lower expenditures



connected to environmental damage. For example, the health standard may increase, and this may cause less expenditures within health care and fewer people unable to work due to poor health. Thus, more resources can be allocated to the production of other goods and services.

Preliminary analyses indicate that gains from such effects may be substantial. Figure 2 displays some results from a recent study on effects of a possible international agreement on reduced CO<sub>2</sub> emissions (see CBS (1991)). In this study, emissions are reduced compared to the reference scenario by introducing a CO<sub>2</sub> emission tax<sup>1</sup>. As reduced CO<sub>2</sub> emissions are achieved to a large extent by reductions in the use of fossil fuels, emissions of pollutants other than CO<sub>2</sub> are reduced as well. Economic effects of such environmental improvements are not calculated within the model, but are estimated on an ex post basis. The gains caused by reduction of local pollution damages (mostly health damages caused by NO<sub>x</sub> pollution), together with reduced social costs related to traffic (accidents, congestion, road damage and noise) seem to be of the same magnitude as the reduction of GDP induced by the CO<sub>2</sub> tax. The calculations are based on the energy accounts and emission inventories, present macroeconomic models in CBS, and information from other sources. Of course, the figures are highly uncertain, and are based on very rough assumptions.

In this study, however, the resources released by better health and other gains were not reallocated to the economy. Hence, the estimated gains only include the first step in a simultaneous process. Reallocation of released resources would require the integration of physical damage functions into the economic models. This is a difficult task that would call for cooperation with scientists of disciplines other than economics.

Nevertheless, the development of such integrated models has recently been initiated, not only for environmental variables, but also for exploitation of natural resources. If this work turns out to be successful, it will bring us several steps closer to the goal of a common framework for economic and environmental analyses.

Regarded as tools for management of the environment and natural resources, the

---

<sup>1</sup> The CO<sub>2</sub> tax in this study increases from N.kr. 68 per tonne CO<sub>2</sub> in 1995 to N.kr 1278 in 2025, measured in 1987 prices.

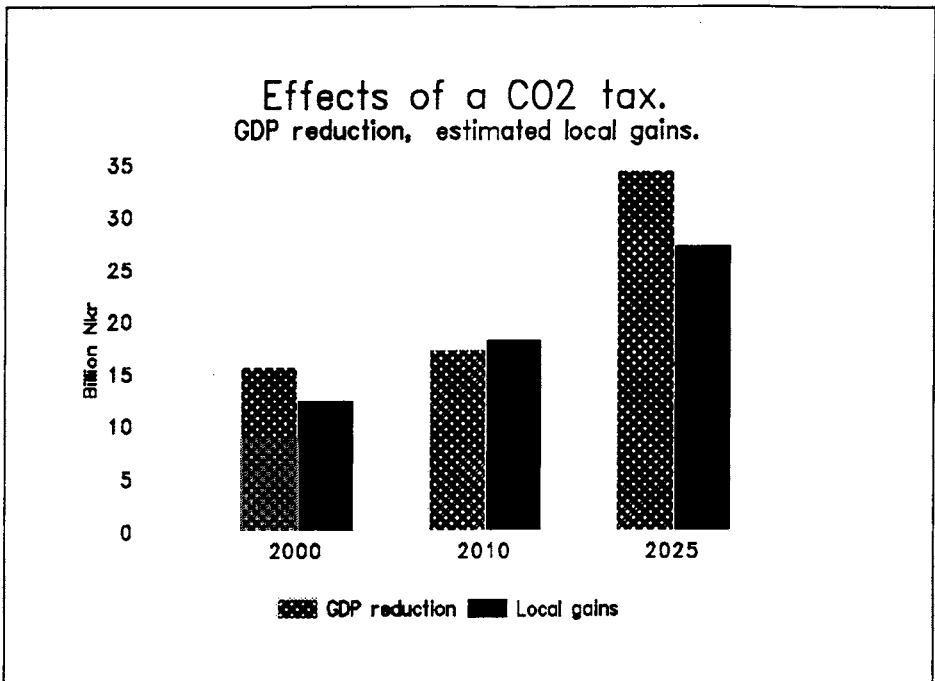

**Figure 2**

macroeconomic models also lack several other properties of importance. This is due in particular to the dynamic nature of management policy, while the macroeconomic models are basically static. Consequently, the uncertainty of future gains from natural resources and the environment cannot be treated within the framework of these models. This is of particular importance when analysing the interrelationships between natural resources and economic management. As an example, the estimated reduction in the wealth of petroleum in Norway, due to the unexpected decline in oil prices, was 2400 billion N.kr. during the period 1981 to 1987, which per capita amounted to nearly three times the average annual wage of a worker. (Aslaksen et al. (1990)). Work to incorporate the aspect of uncertainty in the models will be given priority in future work in Norway.

The combination of economic models and physical resource accounts will enable us to analyse many important issues. For instance, attempts to measure the degree of "sustainability" of current economic growth could probably be handled within this kind of framework. Hence,

this approach might also be an alternative to environmental corrections within a national accounting system.

## **5. CONCLUDING REMARKS**

The aim of the Norwegian resource accounts has shifted from the previous intention to establish a system for resource budgeting, to their current role as part of the tool for integrated economic and environmental policy management and analyses. Our approach has become very much problem- and issue-oriented, in the sense that data supporting work on selected issues is given high priority, instead of attempts to include data for all kinds of environmental problems.

Our approach is based on accounting in physical units and macro-economic modelling in addition to the national accounts. We have stressed such modelling, mainly because it enables us to analyse the economic effects of changes in environmental policy and also the effects on the environment of changes in economic policy.

During the more than 15 years we have been working with resource accounting in the Ministry of environment and the Central Bureau of Statistics in Norway, we have not tried to adjust the GDP as a measure of economic performance or welfare.

There are two main reasons for this: Firstly, we do not think that large-scale, extensive incorporation of environmental values into the national accounts can be justified either from the theoretical or practical point of view. The incorporation of such values would not be compatible with the purpose and character of the SNA as based on value added in market transactions. Thus, the interpretation of the monetary values in an integrated economic and environmental accounting system would not be at all clear.

Secondly, we believe that changing GDP figures is a very indirect, nebulous way of getting to grips with environmental problems.

The accounting and modelling framework developed is now being used regularly. Among other issues, it has been used as a basis for formulating Norwegian policy on climate change and air pollution, and to study the effects of changes in the Norwegian tax system towards a stronger reliance on indirect environmental taxes and charges.

**Literature:**

*Alfsen, Bye and Lorentsen* (1987): *Natural Resource Accounting and Analysis. The Norwegian Experience 1978-1986*. SØS 65, Central Bureau of Statistics, Oslo.

*Aslaksen, Brekke, Johnsen and Aaheim* (1990): *Petroleum Resources and the Management of National Wealth*. In Bjerkholt, Olsen and Strøm: "Recent Modelling Approaches in Applied Energy Economics", *International Studies in Economic Modelling*. Chapman and Hall, London.

*Central Bureau of Statistics* (1991): *Natural Resources and the Environment 1990*. Rapport 91/1 A. Central Bureau of Statistics, Oslo.

*OECD* (1988): *Natural Resource Accounting: The Norwegian Experience*. Prepared by Ø. Lone, Environment Committee, Group on the State of the Environment, OECD. Paris.

# **NATURAL RESOURCE ACCOUNTING IN FINLAND**

**Leo Kolttola**

**Statistics Finland**

## **1. Introduction**

### **1.1. Definition**

The term 'natural resource accounting' is here referred to as a statistical system which describes the whole lifecycle of materials and energy in terms of accounts and balances. Only physical units of measurement are used. The system takes recycling into account and pays special attention to pollution and other environmental effects. In addition, it measures the influence of human activities on the quality of the environment and describes the interdependence of the latter and reserves of material resources.

It is possible to combine - by means of physical input-output relations and waste output relations - the physical accounts generated by natural resource accounting with systems of national accounts and other economic statistics, and with economic models and forecasts.

It is difficult to find suitable commensurable physical units for all sectors of the economy. Implementation of a comprehen-

sive system of materials and energy accounting would be too laborious and probably unuseful. Therefore natural resource accounting concentrates on some of the most important resource sectors.

Natural resource accounting is not:

- a comprehensive system of materials and energy balances or statistics of the kind which was planned in the 1970s (See Ayres 1978: 171-204).
- a natural resources inventory system. The purpose is not to draw up a comprehensive list of the natural resources of Finland or to assess their quantities, and certainly not their values.
- a development or coordination framework for environmental statistics, although significant advantages can be obtained by using it to standardize natural resources statistics and to rationalize data collection. Natural resource accounting does not attempt to cover all kinds of environmental statistics, the principal aim being the establishment of a connection between systems of national accounts and environmental statistics.

## 1.2. History

The initiative for the development of natural resource accounting came from the Natural Resources Council operating under the Ministry of Agriculture and Forestry of Finland. The Council began to assess Finnish natural resource policy and its foundations in the early 1980s, arranging a seminar on "Economic effects of the use of natural resources and nature, and of environmental protection", in 1981. A proposal for a preliminary investigation into natural resource accounting eventually emerged on the basis of the ideas generated in this seminar in 1984 (Natural Resources Council 1984), the aims being:

- to examine the social need for natural resource accounting and its use in various organizations,
- to develop the methods applied to it, and
- to plan a project for developing such a system.

The preliminary study was carried out by Statistics Finland in 1985-1987, and a report on it was published in 1988 (Kolttola et al.).

## **2. Uses and needs for natural resource accounting**

When planning an entirely new information system, its aims can either be formulated along the lines of existing, publicly expressed aims of socio-economic policy, or defined by analysing the problems to be solved by the information system and the research and planning activities utilizing it (Natural Resources Council 1984). When the preliminary study was started, the need for a coherent natural resources and environment policy was only just taking shape, and therefore the latter was the only possible alternative.

It became manifest that the needs and uses for natural resource accounting were related to the need for connecting environmental issues with other sectors of socio-economic policy. This idea became widespread after the publication of the Brundtland Commission report in 1987, the Finnish translation of which was published in 1988. The phrase "sustainable development" introduced in the report launched itself upon almost all forms of socio-economic policy and planning.

## 2.1. Objectives

The preliminary study defined the objectives and functions of natural resource accounting, emphasizing that it can widen the scope of political decisions by linking them to goals regarding the continuity of societies, in particular the sustainable use of natural resources, environmental protection, self-sufficiency, material security and regional equilibrium. In this sense natural resource accounting also responds to the challenges of sustainable development as defined by the World Commission on Environment and Development.

The purpose of the accounting system is to improve the processes for reaching economic decisions connected with the environment and its resources. The principal aims of natural resource accounting as a means of combining economic data with physical data on natural resources are (Gilbert, A. - James, D. 1987:5):

- to describe the natural resource base and the state of the environment in a consistent and standardized format,
- to identify the key variables and relationships in resource and environmental management,
- to monitor and summarize their trends and the presentation of this information via indicators,
- to evaluate problems, preferably at a variety of spatial and management levels, and
- to serve as a set of data for higher-level activities such as simulation or optimization models.



## 2.2. Sustainable development

In his analysis of the relations between natural resource accounting and sustainable development, Jukka Muukkonen considers that the starting points, objectives and methods of accounting correspond in most essential respects to the data requirements imposed by the description of the economic and ecological dimensions of sustainable development. Information generated by natural resource accounting can be used

- to demonstrate interactions between economic and ecological sustainability factors,
- to promote the understanding of sustainable development as a multidimensional process of change involving numerous factors and the relations between them,
- to evaluate trends in economic and ecological development on the basis of flows and stocks of natural resources, and
- to evaluate the benefits and drawbacks attached to the use of natural resources and their effects on human welfare in the future. (1990: 79)

The possibilities of employing natural resource accounting as a means of monitoring sustainability depend on whether it is considered with a view to economic or ecological considerations. An economic weighting may reduce the time-scale. Economic data in monetary terms is hardly ever relevant more than the age of one generation, which is a short time in ecological considerations.

### 3. Scope of the accounts

The proposal of the Natural Resources Council included the requirement that the preliminary study should determine "the extent of Finnish natural resource accounting". The following questions were mentioned as examples of the problems of delimitation:

- How far should natural resource accounting follow the flow of materials and energy?
- In what sectors should one aim at detailed accounting in the long run?
- How many qualitative aspects related to the environment should be included in natural resource accounting?

The question of the extent of accounting still lacks the final answer. In the following the possible answers to these questions, posed seven years ago, are discussed in the light of the present situation.

#### 3.1. Resource sectors

Two points of view were presented at the seminar for specialists in natural resource accounting (Natural Resources Council 1983). Some specialists held that accounting should terminate at the extraction stage, i.e. it should apply to primary production, while others regarded it equally important to examine the whole cycle and wanted rather to restrict accounting to the most significant sectors. The viewpoint emphasizing the significance of the whole cycle or "the whole life-span of the products" was soon adopted in the preliminary study, which seems inevitable in the light of present knowledge.

The Natural Resources Council proposed the forest sector, agriculture and foodstuffs sector, energy sector and land use sector for pilot accounts. They all have remained in the research programme except for the agriculture and foodstuff sector, which was abandoned mainly on account of the large amounts of work involved in it. Water and soil accounting were also discussed earlier. Finland has participated in the pilot study for water accounting, led by France, within the OECD 'State of the Environment' group. The responsibility for this project lies entirely with the National Board of Waters and the Environment.

According to the present objectives, only wood material accounting and energy accounting, which also includes systematic data on air emissions aim at a comprehensive assessment on a long-term basis.

### 3.2. Quality of the environment

The most difficult dimension related to the extent of accounting is the inclusion of qualitative environmental factors.

Methods used in land use accounting occupy a central position in the attempt to connect the quality of the environment with economic activities through natural resource accounting. So far, attempts are being made to draw up traditional statistical descriptions of some major elements contributing to the quality of the environment, for instance land use in built-up areas. These statistics are primary data for environmental accounting.

The idea of environmental accounting is to create databases which make it possible for the user to combine variables depicting society and the economy with those depicting the environment and natural resources in an interactive manner. Interaction between the quality of the environment, material resources and the economy can be analysed by means of these databases by using Geographical Information Systems (GIS).

Geographical location is highly significant in such an analysis, and thematic maps are often used instead of the tabulation of numerical data.

The Norwegians, who started the development of land use accounting, have reduced the proportion of qualitative factors (Alfsen et al. 1987: 54-63), whereas in France qualitative factors and the description of entire ecosystems occupy a central position. Although the development of natural resource accounting in Finland has followed the Norwegian model, we still aim at describing factors related to the quality of the environment in a consistent manner which resembles accounting.

Where the Norwegians considered the high costs of land use accounting relative to the usability of the data a problematical matter, we in Finland try to keep costs down by using only data which already exist in a digital form. Up to now we have used data derived from satellite images obtained by other institutes (the National Board of Survey and the Technical Research Centre of Finland), and from the national housing register. The inclusion of population register data will be tested at the next stage.

As the first application, the development of land use accounting has led to a system for land use censuses in built-up areas, which can be employed to produce databases for areal units of 1 hectare (100 m x 100 m). For the present, these databases are compiled from the following primary data:

- Landsat satellite image data interpreted by the National Board of Survey, providing information on "natural elements",
- the national housing register, providing data on buildings, and

- population register data, applying to the statistically defined built-up areas.

The intention is to market the databases mainly for local administration to meet the needs of physical planning, and to use them to compile both thematic maps and traditional statistical tables.

#### **4. Wood material accounting**

##### **4.1. Scope and methods**

The techniques of material and energy accounting have been applied to the production of wood material accounts, depicting the total biomass possessed by the country in the form of standing forest stock and material flows within the economic processes that use the wood, namely

- extraction, i.e. harvesting of the timber,
- mechanical and chemical processing in the sawn timber and wood pulp industries,
- use in other industrial sectors and as final products, and
- deposition, i.e. the passage of various residues into the environment, either directly or after treatment, or their recycling.

The main units of measurement for the wood material accounts are the solid cubic metre and the dry weight metric ton. The data are gathered principally from the results of the national forest inventories, investigations into wood utilization and total drain (gross removals + natural losses), industrial

statistics, foreign trade statistics, waste disposal statistics and the national accounts.

Statistics Finland will compile time series of wood material accounts during 1991.

#### 4.2. Use of the accounts

As renewable domestic natural resources, forests have always been the backbone of the Finnish economic development. The present rate of forest growth would allow further expansion within the forest industries, but this would involve numerous problems and uncertain factors.

Even though forest growth may be sufficient when measured in terms of total volumes, raw material availability cannot be ensured, as regional and species-related forest growth patterns do not correspond to the structure of forest use, which is largely determined by international demand. In addition, not all the timber available for harvesting in the country has been put on the market in the last few years. Mechanical pulp production, the proportion of which has increased recently, does not require as much timber as chemical pulp, but calls for a high power input, and thus the availability of energy supplies at economic prices is becoming an increasingly important issue for the forest industries.

Since growth prospects for the forest industries are based on the assumption that it will be possible to prevent the damage suffered by the Central European forests from occurring in Finland, the long-term prospects for the forest sector are dependent on environmental protection. Although, expansion of the sector would itself pose environmental problems, for instance the continued pollution of both watercourses and the air by the forest industries in spite of technical progress, and the use of silvicultural measures to alter the forest structure to correspond better to the industrial demand.

## 5. Linkage with economic statistics and models

### 5.1. Monetary valuation

Following the example of the Norwegians, we do not at present regard the valuation of natural resources and the quality of the environment in monetary terms very useful or necessary. In our opinion, this would be essentially dependent on subjective valuations, and the statistical authorities should aim at unambiguous figures. It is the task of those who make the decisions to add their own, preferably explicitly expressed, social values to these figures. On the other hand, the valuation of non-market goods in monetary terms leads to imputed concepts which may be difficult to interpret in practice.

"Unpaid household work and pollution cannot be priced unambiguously, and their inclusion in a system of national accounts would imply only the values assigned to them by the person responsible for this. The leaving of an obvious gap in the statistics is a less serious defect than the filling of this gap with information which is not based on objective investigation but on subjective opinions of what could be a suitable price for the missing elements",

as Georg Luther put it in his lecture to commemorate the 125th anniversary of Statistics Finland.

We have, however, decided to examine the value of the country's forest reserves and changes in it, and adapt the results to be consistent with the System of National Accounts. The intention is to take into consideration the state of health of the forests when assigning a value to the forest reserves. Other natural resources and the influence of environmental changes on the well-being of the forests will be considered at the second stage in the project.

The wood material accounting data serve as a starting point for defining the value of the forest reserve. Forest increment and drain by tree species will be priced and analysed by owner categories, since any change in the value of the forests will ultimately either increase or reduce the incomes and property of these owner groups and likewise affect the national economy.

Our next task will be to examine what changes in concepts and classification are needed in the system of national accounts in order to cope with the description of changes in forests and other renewable natural resources. The inclusion of the health of the forests and other qualitative environmental factors in the accounts will also be examined.

## 5.2. Modelling

We hope that natural resource accounting will also prove useful as input data for more practical models in environmental economics. In these models environmental variables are expressed in physical measures, e.g. the utilization of natural resources, emissions, or the state of the environment, and they are compatible with models used in the "monetary world" of the national economy.

The first of such modelling projects will start 1991 and will be carried out in collaboration with the Finnish Forest Research Institute. The aim will be to develop wood material accounting as a part of natural resource accounting, and to use it for the analysis and forecasting of development in the forest sector.

Natural resource accounting and wood material accounting will be developed in a manner that will allow estimates to be made of the ways in which various developmental scenarios for the forest sector would affect the state of the environment. On the



other hand, the research can be used to assess the restrictions placed by the environment and sources of energy on the various alternative courses of development. Timber consumption estimates and the costs involved in achieving a level of development which is satisfactory from the point of view of the forest industries, the whole forest sector and the environment can be analysed, too.

Economic planning and the possibilities for integrating issues concerned with the environment and natural resources into planning and decision processes can be improved by connecting the future modelling project in the forest sector with the medium-term planning model maintained by the Ministry of Finance (KESSU).

Climatic changes are emerging as the environmental question of the 1990s. The afforestation of treeless areas and the practise of forestry on a sustainable yield basis will bind carbon dioxide from the atmosphere and help to prevent the warming of the climate. On the other hand, the felling of forests is playing a significant role in the increase of carbon dioxide. For this reason research into the role of forest ecosystems as binders and producers of carbon compounds has been intensified.

The production technology of the forest industries and patterns of use of its end products (lifespans, recycling, etc.) also have an influence on the carbon dioxide balance. Developmental alternatives for the forest sector can be analysed from the point of view of the carbon dioxide balance by developing both wood material and energy accounting as parts of natural resource accounting.

## 6. Summary: Plans for further work

- Time series for wood material accounts, 1991
- The use of geo-coded data for describing the quality of the environment will be further examined within land use accounting, and the related GIS technology will be developed
- Modelling of the forest sector as part of wood material accounting, in cooperation with the Finnish Forest Research Institute and the Ministry of Finance, 1991 - 1993
- Indicators of sustainable development and the environment in SNA, first step: Natural forest increment in the SNA, 1991 - 1993
- Implementation of energy accounting, air emission data and coefficients, 1992

**REFERENCES**

- Ayres, R. 1978: Resources, Environment and Economics. Applications of the Materials/Energy Balance Principle. John Wiley & Sons. New York.
- Alfsen, K., Bye, T., Lorentsen, L: 1987: Natural Resource Accounting and Analyses - the Norwegian Experience 1978-1986. Central Bureau of Statistics of Norway. Oslo.
- Gilbert, A. - James, D 1987: Natural Resource Accounting: A Review of Current Activity and its Application to Australia. Draft.
- Natural Resource Council 1983: Natural Resources Accounting. Seminar 23.11.1983. Helsinki. The Ministry of Agriculture and Forestry. (in Finnish)
- Natural Resources Council 1984: A Proposal for a Preliminary Study of Natural Resource Accounting. Ministry of Agriculture and Forestry 1.3.1984. (in Finnish)
- Kolttola, L. - Tammilehto-Luode, M. - Niemi, E. 1988: Natural Resource Accounting - a Preliminary Study. Central Statistical Office of Finland. Studies 141. Helsinki. (in Finnish)
- Luther, G. 1990: On History of the Finnish Statistics. The 125th Anniversary of the Central Statistical Office of Finland. A Lecture in the Finlandia Hall 4.10.1990. (in Finnish)
- Muukkonen, J. 1990: Sustainable Development and Natural Resource Accounting. Central Statistical Office of Finland. Helsinki 1990. Studies 173.
- World Commission on Environment and Development 1987: Our Common Future. Oxford University Press.

**Appendices**

- Wood material accounts of Finland  
Table 1. Forest balance 1990  
Table 2. Use balance 1990

TABLE 1. FOREST BALANCE 1990

<i>1 000 solid cubic meters</i>	Pine	Spruce	Broadleaves	In all
<i>Stock 1.1.1990</i>	864784	684138	347410	1896332
+ Annual increment	36000	26000	15000	77000
- = Total drain	21060	22140	11760	54960
+ Natural losses	630	370	270	1270
+ = Total removals	20430	21770	11490	53690
+ Silvicultural waste	1350	1230	2230	4810
+ = Net removals	19080	20540	9260	48880
+ Saw logs	9130	10470	1560	21160
+ Pulp wood	9410	9540	5410	24360
+ Fuel wood	540	530	2290	3360
= <i>Stock 31.12.1990</i>	879724	687998	350650	1918372



**CAUSER-RELATED INDICATORS FOR STRESSES UPON THE  
ENVIRONMENT  
A CONTRIBUTION TO THE ENVIRONMENTAL SATELLITE-SYSTEM OF THE  
AUSTRIAN SNA**

Marina FISCHER-KOWALSKI, Helmut HABERL, Harald PAYER,  
Anton STEURER, Helga ZANGERL-WEISZ<sup>1</sup>

Institute for Interdisciplinary Research and Continuing Education  
of the Universities of Innsbruck, Klagenfurt, Vienna and  
Austrian Ecology-Institute

**1. INTRODUCTION**

The Ministry for the Environment has asked our joint institutes, among others, to produce a system of environmental indicators for the physical part of the planned Austrian satellite-system.<sup>2</sup> The primary aim is to devise a consistent set for stresses upon the environment exerted by economic activities. In this sense they should be causer-related indicators to be connected to economic data within an input-output framework.

The current international efforts in developing a "green" GNP in whatever form possible are done to raise the awareness of the effects of the economic system on the environment. Awareness of the stresses upon the natural environment is only a first step to comprehensive information. It does not necessarily contain information on lost values or possible backlashes to the social system. The resultant indicators rather represent an instrument for **self-observation of the socio-economic system** than an instrument for the observation of nature. It seeks to describe the activities of this system that can be interpreted as stresses upon the environment in physical terms.

---

<sup>1</sup>) This paper is based upon the results of a two-years team-work study, partly financed within a programme for "new paths towards measuring the National Product" ran by the Austrian Ministry for the Environment. The whole team contains, besides the authors: Geli Brechelmacher, René Dell'Mour, Peter Fleissner, Wolfgang Hofkirchner, Karl Turetschek and Peter Wenzl.

<sup>2</sup>) See Franz A. (1988); Franz A. (1989)

The set of indicators to be proposed should meet the following requirements: **Firstly**, for the sake of practicability, it should be based on available data, or at least on data that **could** be made available within the next years. The availability of causer-related environmental data in Austria is very limited due to a data-protection legislation which is very restrictive compared to international standards and also due to the typical Austrian tradition of secrecy of private companies and official authorities. In this respect, we regard this part of a "green GNP" as an important contribution to providing the public with better information on the economy's impact upon its natural environment.

**Secondly**, it should find acceptance both with economists and with environmental experts from a variety of natural science disciplines. For the sake of its medium-term applicability, it should not just represent the "minimal consensus" between the parties concerned though, but be open for future developments.

**Thirdly**, these environmental indicators should be technically compatible with the design of the Austrian SNA. It therefore should relate to the same classes of activities (as possible "causers") and express stresses upon the environment in terms of **flows** per time unit (usually per year).

The following tasks were the key preliminary steps for setting up the physical part of a satellite-system:

- **Screening and description** of available causer-related data in Austria, classified consistently by appropriate causer-categories (branches of production etc.) and by type of possible environmental effect;
- **Evaluation** of the quality of the available data (methodological, conceptual and ecological relevance) and proposals for their improvement with reference to international experience;
- **Discussion** of the classification schemes developed and the methodological diagnosis of data quality and availability in an appropriate interdisciplinary procedure;
- Devising a draft dynamic economic-ecological **input-output model** for analytical use.

So far, the first three tasks have been achieved within the limits of our project, on a however preliminary basis. An attempt at the fourth task is given by Dell'Mour R., Fleissner P., Hofkirchner W., Steurer A.: "Substitution of transport activities: An input-output approach to determine economic and environmental effects" (see separate paper in this volume).

The evaluation of environmental damage and depleted natural resources is not only a matter of ideology or casually chosen theories, but depends to a great extent on the quality of information available on environmental effects caused by human beings. In accordance with "the polluter pays-principle" high expectations are placed in the possibility of relating certain changes in environmental quality to the responsible causers in a direct and coherent mode. An **institutional** distinction is to be preferred to a **functional** distinction (agriculture, industry, traffic, services, residents) for the classification of economic actors causing environmental stresses. Thus a link between environmental indicators and economic input-output-matrices can be established. Ultimately, the environmental indicators in combination with input-output models can be used for simulating future courses of economic development and their possible influence on the state of the environment. Such models should be able to estimate, for example, the extent of future emissions of heavy metals into waters in relation to annual growth or decline of the Austrian metallurgical industry, and what changes will occur resulting from technological progress. A database like this is to be regarded as an important means of influencing both economic and environmental policy in the sense of "structural ecologization".<sup>3</sup>

## 2. THE PROPOSED CAUSER-RELATED INDICATORS

Which kind of processes and effects should be regarded as stresses upon the environment is a point of great dispute. But since the discussion is not concerned with simple arguments of cause and effect, it is worth taking a look at the most important approaches relating to this question, before the most relevant indicators are selected.<sup>4</sup>

Since the start of the general environmental debate during the 1970s, the definition of environmental damage was dominated by toxicological aspects. Following the traditional

---

<sup>3</sup> See e.g. Jänicke M. et al (1991)

<sup>4</sup> For details see Fischer-Kowalski M. et al (1991b), p. 3-12



"chemical approach", scientists and policymakers tended to focus on emissions that directly harm the human health. That approach, of course, resulted in an ever-growing list of toxic agents.

A second approach is favoured by biologists and by the recent political concerns about the possible changes of the global climate and soil erosion. That approach concentrates on activities that destabilize the balance of natural systems. Within this approach all human activities are considered environmentally harmful that push natural systems beyond their point of self-regulation. Such harmful activities may be the emission of toxic substances, but also quite different activities such as the use of heavy machinery on agricultural soil or interventions into water systems. The harmful quality does not lie within the activities themselves, but in their time- and space-specific interaction with the sensitivities of natural systems.

Another approach with an old scientific tradition is derived from the entropy law. Its proponents suggest restructuring economic production according to the physical laws of thermodynamics. The entropy law asserts that energy and other materials are not used up in the physical sense, but that a devaluation of energy and materials takes place, that is to say a consumption of exergy or deterioration of quality or utility respectively. The focus of attention is on the aspect of efficiency of the economic system in providing human necessities with a minimal production of entropy. Sometimes the approach tends to go together with neo-classical reflections on the efficiency of perfect competition and general equilibrium in economic markets. To sum up, the entropy approach helps to define some stressors-upon-environment, particularly the use of non renewable resources, but a lot of other aspects (e.g. toxicology) are not taken into account.

The last group of approaches to be considered is strongly influenced by sociological, ethical and biological thinking. Not as well known among economists they have tended to gain more attention during the last few years. The common ground of these approaches is their engagement in rejecting the narrow framework of utility-guided calculation of human activities towards nature. The theoretical model of "homo oeconomicus" is dropped completely. The various arguments include criticism of human arrogance towards the rest of the world, call upon more solidarity and respect in the way of dealing with living things, and an analogy of violence towards nature with violence towards man. Between the antitheses of crude anthropocentrism and naturalistic submission to nature another conceptual framework has to be

applied. This framework is modeled on, among others, Ivan Illich's works on "conviviality"<sup>5</sup> and conceptions of "empathy for the suffering nature".<sup>6</sup> From these approaches some interesting conclusions can be drawn for environmental indicators, especially for indicators on the broad field of "purposive interventions into life processes", which will be explained in more detail below.

In view of the diversity and inconsistency of the various approaches, we have chosen a more eclectic method by trying to supply environmental indicators which form an important part of **at least one** of the mentioned approaches. Thus no essential aspect of the complex meaning of "environmental damage" should be neglected. Otherwise, if one only concentrates on highly consensual indicators, a very short list common to all approaches could be quickly established. That list however would not pass a test of ecological reliability and would probably have to be altered after a very short time.

On that basis, the complete set of causer-related indicators to be connected to the economic data can be classified in three modules:

- a module of **economic-ecological system indicators (ESIs)** of the intensity type, such as materials-intensity, energy-intensity and transport-intensity,
- a module for **emissions (EMIs)** (gaseous, liquid and solid emissions) and
- a module for what we call "**purposive interventions into life processes (PILs)**" including purposive interventions into biotopes, violence towards animals and purposive interventions into evolutionary processes.

## 2.1 ECONOMIC-ECOLOGICAL SYSTEM INDICATORS (ESIs)

The idea behind the concept of "economic-ecological system indicators (ESIs)" comes fairly close to the idea of economic efficiency. Economic-ecological system indicators inform about the physical dimensions of the economy in terms of matter, energy and time/space.

---

<sup>5</sup>) See Illich I. (1973)

<sup>6</sup>) See Miller A. (1980); Böhme G. (1991)

This rests upon the assumption that *ceteris paribus* the economy will have the less impact upon its environment the smaller the physical quantities handled by the system are. Several aspects can be expressed by those indicators. One aspect is the "**physical size**" of the economy relative to its natural environment. Another aspect is the "**wastefulness**" of the economy. The more matter, energy and movement is processed for a given degree of need-satisfaction, the more ecologically wasteful the system is. Another aspect is the "**physical efficiency**" of the system: How much input from the environment does it need for how much output in terms of goods and in relation to the output in terms of "bads"?

Such data is mainly mass-data about input or production. The indicators are expressed in physical amounts (tons of materials per year, energy in Joule per year etc.). The indicators can also be related to the monetary side (turnover or value added) of the economy and expressed as "intensities", e.g. net energy used divided by gross domestic product. This draws attention to the relative independence of the physical and the monetary "size" of the economy: An economy may very well shrink in physical terms (which should be environmentally beneficial) and at the same time grow in monetary terms (which would be environmentally irrelevant). The indicators can also be separated into branches to give specific intensities of every branch measuring their relative **environmental performance**. Altogether a set of 23 economic-ecological system indicators and some subindicators has been identified.

In short, the intensities are (always per unit of turnover and value added, or per employee):

- Materials-intensity:** Net tons of materials used (inputs minus products), disaggregated into primary services from nature (directly extracted water, oxygen and nitrogen, other resources) and intermediary services of economy (energy carrier, other secondary input, reused waste materials, direct packaging input).
- Energy-intensity:** Net energy used, disaggregated by sources of energy (fossile, renewable, electricity).
- Transport-intensity:** Ton-kilometres and person-kilometres consumed, aggregated or disaggregated by type of vehicle used.

*Figure 1* shows the suggested indicators for materials–intensity derived from empirical material balance–sheets for four selected branches of the Austrian Economy, namely extraction of crude petroleum and natural gas, manufacture of refined petroleum products, manufacture of pulp and paper, and electrical industry. The suggested indicators trace the **material flows** from the environment through the economy and back into the environment. The underlying concept of flows follows the laws of thermodynamics which state that materials cannot be used up in a physical sense. Nothing gets lost. Macroeconomic material balances always end up with identic sums of material inputs and outputs in terms of mass. The concept of material flows is thus perfectly compatible to the monetary input–output cycles basic to the System of National Accounting. Material stocks stay out of consideration.

As can be seen from *Figure 1*, the variability of materials–intensity between the different branches is very high. Whereas in the electrical industry only 10 kg of material input (excl. water) are needed to achieve a production value of 1000.– AS, in the petroleum extraction industry 760 kg correspond to this production value. The indicator for material efficiency shows quite a different pattern. Here the manufacture of pulp and paper appears to be the most wasteful of the branches analyzed, and the petroleum extraction industry as least wasteful.<sup>7</sup>

## 2.2 EMISSIONS (EMIs)

Reporting on emissions in the narrow sense is the most established field of causer–related environmental data. Historically seen, emission–reporting is closely connected to the toxicological model mentioned above. During the last years it has gained a new dimension from the discussion about future climate changes.

Emissions are defined as the transmission of toxic and hazardous materials or energy across the systemic lines between society and nature. Emissions are always **unintentional side effects** of economic activities. A power plant is not built to emit sulphur dioxide, nitrogen oxides or other air pollutants, but to supply electricity. The simultaneous output of any emissions is figuratively speaking like an unpleasant accident.

---

<sup>7</sup>) For details see Payer H. (1991)

		Extraction of crude petroleum and natural gas	Manufacture of refined petroleum products	Manufacture of pulp and paper	Electrical industry
total input per employee (tons/em.) <sup>1</sup>	incl. water	1.416	6.343	18.159	201
	excl. water	790	2.628	466	10
total input related to production value (tons/1.000 AS) <sup>1</sup>	incl. water	1,37	1,30	6,22	0,24
	excl. water	0,76	0,54	0,16	0,01
material wastage per employee (tons/em.)	incl. water	650	3.946	17.830	192
	excl. water	24	231	137	2
material wastage related to production value (tons/1000 AS)	incl. water	0,63	0,81	6,10	0,23
	excl. water	0,02	0,05	0,05	0,00
material efficiency <sup>2</sup>	incl. water	0,54	0,38	0,02	0,04
	excl. water	0,97	0,91	0,71	0,83
packaging intensity <sup>3</sup>		0,00	0,00	0,01	0,06

<sup>1</sup> excl. oxygen and nitrogen  
<sup>2</sup> percentage of material output in the form of goods to total material input  
<sup>3</sup> percentage of direct packaging input to material output in the form of goods

Source: Own calculations

*Fig.1: Indicators for materials-intensity for four selected branches of the Austrian Economy (1988)*

Emissions are classified by their aggregate state (gaseous, liquid, solid or energetic) at the moment of leaving the economic system. Toxic and hazardous concentrations in goods (e.g. cadmium in toys or residues of pesticides in foods) or in recycled substances (e.g. filter sludges or sulphate alkali) are not handled as emissions. The chosen classification seems to be a reasonable solution to the enormous statistical problem of double-counting. Within the complete information system of causer-related indicators the emissions are always regarded as net emissions, in order to relate them as far as possible to the branches which **actually** emit them, regardless of whether the released pollutants are disposed of directly into "nature" or into waste-processing industries. Otherwise the accounting system would be distorted by recording those branches which dispose of the emissions of others as the largest emitters themselves.

For gaseous emissions we suggest an effect parameter for "climate affecting emissions" (where several different substances are recalculated on a CO<sub>2</sub>-basis according to international

standards) and for "ozone-layer affecting emissions" (various gases recalculated in  $F_{21}$ -equivalents). For liquid emissions we suggest an effect parameter for "eutrophication" (measured in total phosphor) and for "deoxidation" (measured in  $BSB_5$ ), and another for toxicity.<sup>8</sup>

### 2.3 PURPOSIVE INTERVENTIONS INTO LIFE PROCESSES (PILs)

In contrast to emissions as unintentional side-effects of economic production, the so-called purposive interventions into life processes are those made in favor of a particular social use. Roads for example, are primarily built to overcome natural barriers to mobility. The loss of land, soil, vegetation and wild life is the unavoidable prerequisite of going by car from one point to another. Most of the environmental effects of agriculture are the result of "regulating" nature purposely.

We developed the following module of indicators in order to mirror relevant processes with which the socio-economic system intervenes into life processes in favor of particular social uses:<sup>9</sup>

**purposive interventions into biotopes:** Indicators for socio-economic efforts to change the structure of ecosystems. The most important efforts are interventions into water systems, the appropriation of photosynthetically fixed energy, and the input of technically produced substances (fertilizers, pesticides).

**violence towards animals:** Indicators for social activities that cause suffering and pain of animals. This subset contains two indicators, one for the circumstances of keeping animals (long-term aspect), and one for short-term aspects like killing animals or animal experiments.

**purposive interventions into evolutionary processes:** Indicators for direct (genetic engineering) and indirect (breeding techniques) interventions in the gene pool.

---

<sup>8</sup>) For details see Payer H., Zangerl-Weisz H. (1991)

<sup>9</sup>) For details see Fischer-Kowalski M. et al. (1991a); Haberl H. (1991); Wenzl P., Zangerl-Weisz H. (1991).

Figure 2 shows the suggested indicator for socio-economic appropriation of photosynthetically fixed energy. Energy is not only the "motor" for the economy, but also for all natural systems.<sup>10</sup> The energy that green plants accumulate by photosynthesis is the so-called primary production (PP in Joule per space unit and year). The net primary production (NPP) that is the fraction not consumed by the plants themselves, is the energetic basis of all heterotrophic life (e.g. animals, bacteria, fungi). First, this energy flow can be related to the diversity of species with species-energy curves.<sup>11</sup> This means that if the amount of energy remaining in the ecosystem is reduced, the number of species living in this ecosystem will diminish. Secondly, there are limits to the fraction of NPP which can be used by man in a sustainable manner. The human appropriation of the NPP per year currently is estimated to lie between 20% and 40% of the global terrestrial NPP.<sup>12</sup> Even if it is not clear at which percentage of human appropriation the limits of sustainability are reached, the current amount already is considerable, and obviously cannot be increased without further speeding up the dieout of many other species.

socio-economic uses	area concerned km <sup>2</sup>	photosynth. fixed energy <sup>1</sup>		distribution of approp. NPP (%)
		hypothetical NPP <sub>s</sub> (PJ/a)	appropriated by man NPP <sub>a</sub> (PJ/a)	
agriculture <sup>2</sup>	15.900	370	250	40,4
grassland, alpine pastures	21.000	280	180	29,0
forests (logging)	34.300	580	110	17,7
gardens	1.700	40	20	3,2
traffic zones	1.600	40	40	6,5
buildings	700	20	20	3,2
other <sup>3</sup>	8.000	40	0	0,0
total	83.200	1.370	620	100,0

<sup>1</sup> first estimates based on international literature  
<sup>2</sup> including wine  
<sup>3</sup> including waters and wasteland

Sources: Bundesamt für Eich- und Vermessungswesen 1989; BMLF 1989a; BMLF 1989b; ÖSTAT 1990; own calculations

Fig.2: Appropriation of net primary production in Austria (1988, first estimation)

<sup>10</sup> See Odum E.P. (1983); Odum E.P. (1991)

<sup>11</sup> See Wright (1990), p.189

<sup>12</sup> See Wright (1990); Max-Neef (1991)

The suggested indicator for the human appropriation of NPP is formulated as the difference between the hypothetical NPP of the undisturbed ecosystem and the actual NPP. *Figure 2* shows the NPP<sub>a</sub> appropriated by the socio-economic system as the sum of "prevented" NPP and "consumed" NPP. The hypothetical NPP on Austrian territory is estimated to be around 1.370 PJ/a. Thus the socio-economic appropriation of the products of photosynthesis in Austria (620 PJ/a) amounts to about 45% of the total production. That amount of appropriated NPP corresponds quantitatively to the end use of (technical) energy, which for Austria is around 750 PJ/a.<sup>13</sup>

The module of indicators for purposive interventions into life processes gives rise to a lot of interesting discussion. Economists tend not to understand what this has to do with their notion of sustainability and nature protectionists tend to view the problem solely from the perspective of nature being destroyed, but have no tradition of relating this to specific economic activities. So there are difficulties both in the public acceptance of the usefulness of such indicators and in their methodical and empirical construction. But we feel it is very important to handle these issues not just as "ethical problems", but to connect them to defined economic activities and to link them into such an influential system of social reporting as the SNA.

---

<sup>13</sup>) For details see Haberl H. (1991)



### 3. CONCLUSIONS

The suggested set of causer-related indicators mirrors the physical exchange processes between the socio-economic system and its natural environment. Our proposal contains three different modules of indicators. The modules differ both in their theoretical reference and in their data bases. Methodologically though the indicators have common features. They base on available data, or at least on data that could be made available within the next years; They are all expressed as physical flows per time period (a year) and they are attributable to specific groups of economic causers (branches of activities, including private households) on an institutional, not a functional level. So, the indicators are technically compatible with the design of the monetary SNA.

The economic-ecological system indicators (ESIs) inform about the physical dimensions of the economy in terms of matter, energy and spatial movement. These indicators express aspects like the "physical size", the "wastefulness" or the "closedness" of the economy relative to its natural environment. The module of emissions (EMIs) represent selected noxious outputs of the economy into its environment. Finally, the third module contains indicators for purposive interventions into life processes (PILs) in favor of a particular social use.

## REFERENCES

- Böhme G. (1991): *Das Tier in der Moral*, in: *Merkur* 505
- Bundesamt für Eich- und Vermessungswesen (1989): *Administrative und statistische Angaben für das Bundesgebiet Österreich: Ausweis der Benützungarten, Stand 31.12.1988*
- BMLF (1989a): *Bericht über die Lage der österreichischen Landwirtschaft gemäß §9 des Landwirtschaftsgesetzes 1976 BGBl.299. Wien.*
- BMLF (1989b): *Jahresbericht über die Forstwirtschaft 1988. Wien.*
- Fischer-Kowalski M., Haberl H., Payer H., Steurer A., Vymazal R. (1991a): *Verursacherorientierte Umweltinformationen. Research Report Institute for Interdisciplinary Research and Continuing Education & Austrian Ecology Institute. Wien.*
- Fischer-Kowalski M., Haberl H., Payer H., Steurer A., Zangerl-Weisz H. (1991b): *Verursacherbezogene Umweltindikatoren – Kurzfassung. Research Report Institute for Interdisciplinary Research and Continuing Education & Austrian Ecology Institute. Wien.*
- Franz A. (1988): *Grundzüge einer ökologischen Gesamtrechnung für Österreich*, in: *Österreichs Volkseinkommen 1987. Wien.*
- Franz A. (1989): *Ein Bearbeitungsraster für die Ökologische Gesamtrechnung in der VGR*, in: *Österreichs Volkseinkommen 1988. Wien.*
- Haberl H. (1991): *Gezielte Eingriffe in Lebensprozesse. Research Report Institute for Interdisciplinary Research and Continuing Education & Austrian Ecology Institute. Wien.*
- Illich I. (1973): *Tools for Conviviality. Harper & Row: New York.*
- Jänicke M., Mönch H., Binder M. (1991): *Ökologische Dimensionen industriellen Wandels. Research Report Freie Universität Berlin – Forschungsstelle für Umweltpolitik. Berlin.*
- Max-Neef M.A. (1991): *Speculations and Reflections on the Future. Official Document No.1 prepared for the Preparatory Committee of the Santiago Encounter, March, 13–15th, Santiago de Chile.*
- Miller A. (1980): *Am Anfang war Erziehung. Frankfurt.*
- Odum E.P. (1983): *Grundlagen der Ökologie. Band 1: Grundlagen. Thieme: Stuttgart; 2.Aufl.*
- Odum E.P. (1991): *Prinzipien der Ökologie: Lebensräume, Stoffkreisläufe, Wachstumsgrenzen. Verlag Spektrum der Wissenschaften: Heidelberg.*
- ÖSTAT (1990): *Ergebnisse der landwirtschaftlichen Statistik im Jahre 1989. Beiträge zur Österreichischen Statistik, Heft 976. Wien.*
- Payer H. (1991): *Indikatoren für die Materialintensität der österreichischen Wirtschaft. Research Report Institute for Interdisciplinary Research and Continuing Education & Austrian Ecology Institute. Wien.*
- Payer H., Zangerl-Weisz H. (1991): *Die Emissionen der österreichischen Wirtschaft. Systematik und Ermittelbarkeit. Research Report Institute for Interdisciplinary Research and Continuing Education & Austrian Ecology Institute. Wien.*
- Wenzl P., Zangerl-Weisz H. (1991): *Gentechnik als gezielter Eingriff in Lebensprozesse. Vorüberlegungen für verursacherbezogene Umweltindikatoren. Research Report Institute for Interdisciplinary Research and Continuing Education & Austrian Ecology Institute. Wien.*

# SELECTED ISSUES IN INTEGRATED ENVIRONMENTAL-ECONOMIC ACCOUNTING

Peter Bartelmus and Jan van Tongeren<sup>1</sup>

## I. Introduction

Calls for environmentally sound and sustainable growth and development reflect a general agreement on the need to integrate environmental objectives into socio-economic planning and policies.<sup>2</sup> National accounts have provided the most widely used indicators for the assessment of economic performance, trends of economic growth and of the economic counterpart of social welfare. However, major drawbacks of national accounts have raised doubts about their usefulness for the measurement of long-term environmentally sound and sustainable economic growth and development. These drawbacks include:

- (a) the neglect of scarcities of natural resources which threaten the sustainability of output and value added generated in economic production activities;
- (b) the failure to account for the degradation of environmental quality and its effects on human health and welfare; and
- (c) accounting for certain environmental protection expenditures as increase in national product but which may instead be considered as social costs of the maintenance of environmental quality.

---

<sup>1</sup> The authors are staff members of the United Nations Statistical Division. The views expressed here are their own and do not necessarily reflect an expression of opinion on the part of the United Nations.

<sup>2</sup> Sustainable development has been the all-pervading theme of the United Nations Conference on Environment and Development in Rio de Janeiro (1-12 June 1992).

The feasibility of physical and monetary accounting in the areas of natural resources and the environment was first explored in workshops jointly organized by UNEP and the World Bank. The workshops led to a consensus that enough progress had been made to link environmental accounting to the United Nations System of National Accounts, the SNA, and to include certain aspects of environmental accounting in the ongoing revision of the SNA. In response to this conclusion, an SNA Framework for Integrated Environmental and Economic Accounting was presented at the twenty-first session of the International Association for Research in Income and Wealth (IARIW) (Lahnstein, 20-25 August 1989) (Bartelmus, Stahmer and van Tongeren 1991). At that session, it was decided to convene the present Special IARIW Conference on Environmental Accounting, in order to further explore possibilities of modifying conventional economic (national) accounts for environmental assessment and policy support.

The current revision of the SNA (United Nations 1992) presents a unique opportunity to examine how the various concepts, definitions, classifications and tabulations of environmental and natural resource accounting<sup>3</sup> can be linked to or incorporated in the SNA. The Statistical Commission of the United Nations, at its twenty-fifth session in 1989, endorsed the development of an SNA Handbook on Integrated Environmental and Economic Accounting; it also requested the Statistical Division of the United Nations (UNSTAT), at its twenty-sixth session, to focus on integrated environmental-economic (satellite) accounting and on carrying out national case studies. The United Nations Conference on Environment and Development (UNCED) confirmed this approach and requested UNSTAT to make the methodologies of the Handbook available to all member States. (Agenda 21, Chapter 8 D).

The above-mentioned Framework has served as the basis for the Handbook which has been prepared in collaboration with the World Bank and other organizations and is expected to be published in early 1993. The present draft of the SNA (United Nations 1992) includes a separate section on integrated environmental accounting, based on the Handbook. In general, the revised SNA has benefitted much from the discussion of environmental accounting, especially where dealing with natural assets.

The present paper is based on the concepts and methods developed in the Framework and the draft Handbook which together propose a consistent System for integrated Environmental and Economic Accounting (SEEA). The paper has also benefitted from the experiences gained through pilot projects in Mexico (van Tongeren, Schweinfest and Lutz 1991) and Papua New Guinea (Bartelmus, Lutz and Schweinfest 1992). The following raises issues that have not, or not sufficiently, been elaborated in the SEEA. They include policy applications of environmental accounting, in particular those related to sustainable development

---

<sup>3</sup> See Ahmad, El Serafy and Lutz (1989) for an overview of different concepts and approaches, and Peskin with Lutz (1990) for a survey of environmental accounting practices in industrialized countries.

(Section II) and unresolved issues of definition, valuation and measurement of modified environmental aggregates (Section III).

## **II. Policy Issues: Accounting for Sustainable Growth and Development (by Peter Bartelmus)<sup>4</sup>**

As indicated in the Introduction, the objective of sustainable development is to reflect environmental considerations in mainstream development policies. The idea is to make these policies accountable for their environmental effects. Such integrative policies are expected to achieve what eluded conventional (and separate) environmental and developmental policies, namely to halt or reverse environmental depletion and degradation while accelerating socio-economic growth and development.

### ***A. Sustainable development - concepts and definitions***

Without a clear definition or further elaboration, the concept of sustainable development remains open to differing interpretations and misunderstanding. At the international level, there is already some apprehension that the new attribute "sustainable", attached to development, might reflect a new "conditionality" to development assistance, which would divert international resource flows from developing countries to global environmental programmes. Widely applicable definitions of the concepts used in measuring sustainable growth and development are urgently needed.

National accounts have generally provided the quantitative aggregates corresponding to the main variables used in macro-economic analysis. Definitions of accounting aggregates that reflect both economic and environmental concerns are therefore considered in deriving an operational definition of sustainable economic growth. Broader concepts of "development" will have to reflect additional indicators and variables of non-economic goals.

A sustainability concept in terms of maintaining a particular level or growth rate of outputs of human activities, contributing to the achievement of development objectives, does not provide further insight into the development process. Development means per definition the increase or improvement of some desirable outcomes. The sustainability of development is therefore more usefully addressed by examining possible violations of critical limits of productive assets used in the production of "outputs" for development.

As far as economic objectives of producing and consuming goods and services are concerned, basic asset limitations can be expressed in reference to the

---

<sup>4</sup> Much of the following has been based on Bartelmus (in prep.) which should be consulted for further details.

availability of "production factors", consisting of (a) produced, (b) natural (environmental) and (c) human (labour, including knowledge, skill and motivation) capital. A further less tangible prerequisite for economic activities are institutional conditions of law and order, international relations etc., which regulate or otherwise affect these activities.

The objective of maintaining produced capital is already inherent in the concepts of Net Domestic Product (NDP) and National Income (NI), calculated both net of the cost of capital depreciation. NDP and NI could, therefore, also be considered as sustainable net product and income concepts with reference to the more limited objective of maintaining produced capital intact. Depreciation allowance permits in principle to replace the produced fixed capital used up in the production process, due to foreseeable obsolescence or normal wear and tear. The concept of depreciation can be readily extended to the use of natural resources which, unless replaced or otherwise regenerated, could affect negatively future productive capacity and output levels.

Broader concepts of "more sustainable" net product and income could thus be derived which reflect the maintenance of a wider asset base. The argument of diminishing returns, due to limits in the supply of natural resources, takes up classical economic thought which predicted the end of economic growth. The question is how close are we to these limits. Then as now, much of the argument against the prediction of rapid economic and demographic decline because of natural boundaries rests on possibilities of resource discovery, substitution (induced by relative price changes), technological progress, changes in consumption patterns and efficient management of natural resources.

The notion of sustainability of human capital or labour is controversial, since it is hardly possible to distinguish sustainability of human activities, pursuing economic goals, from the general sustenance of human life. As discussed below, the sustainability of human life is probably better assessed by pertinent indicators of "standards of living" or the "quality of life". Similarly, the maintenance of the many intangibles contained in institutional capital is difficult to conceptualize and even more difficult to measure in money terms. Therefore, the SEEA does not include human or institutional "capital" as assets within its asset boundary.

Focusing, thus on the maintenance of produced and natural (resource) capital for ensuring continuing generation of output and value added and bearing in mind possibilities of extending the use of natural resource capital through technological progress, resource discovery or substitution of primary (produced, natural, or human) inputs, *sustainable economic growth* can be defined in operational terms as

increase in (real) domestic product that allows for the consumption of produced and depletion of natural capital, taking into account that past trends of depletion can be offset or mitigated by technological progress, substitution, discoveries of natural resources or change in consumption patterns.

Sustainable growth in the above sense refers to growth of environmentally modified product and value added generated in production. It is a production-oriented concept. However, sustainable growth of production does not necessarily mean that there is sustainability of consumption, capital accumulation (see Section III B) or the foreign trade balance.

Sustainability as described above refers to the maintenance of produced and natural capital which, if allowed to decrease or degenerate, would impair the productive capacity of the economic system. However, natural assets provide additional services to society in the form of sinks for (waste) residuals of production and consumption. If the absorptive capacities of environmental sinks are exceeded or otherwise impaired "disamenities" of pollution and related health and welfare effects are generated. The joint production of "bads" of waste and pollutants, together with the "goods" of commodities and services, can thus be considered as abusing a non-economic environmental amenity offered directly to society by the natural environment. Alternatively, environmental services of waste absorption could also be considered as an intangible input (of waste disposal) from a "fixed" environmental asset into production and consumption (Bartelmus, in prep.).

Disamenities of losses in human well-being cannot be readily valued as depreciation of a marketed asset. Concepts of capital maintenance and sustainability do not apply, unless the production boundary of conventional economics is extended. This would of course imply near-insurmountable problems of simulating an economic production process for nature and of valuing environmental effects on human health and other aspects of "enjoying" the natural environment. What appears possible, however, is to set "exogenously" standards of environmental quality and to cost non-compliance with these standards. Those costs can be defined in terms of potential restoration of environmental quality or of hypothetical avoidance of environmental impacts.

The attribute of "environmentally sound" is therefore added explicitly to "sustainable" in defining a growth concept which aims at increasing production and value added while allowing for non-compliance with environmental standards. Considering these costing possibilities and taking both environmental productivity and quality effects into account, the above definition of sustainable economic growth can be expanded, defining *environmentally sound and sustainable economic growth* as

increase in (real) domestic product that allows for the consumption of produced capital and the depletion *and degradation of environmental assets*, taking into account that past trends of depletion *and degradation* can be offset or mitigated by technological progress, substitution, discoveries of natural resources or change in consumption patterns.

For development objectives, whose attainment cannot be depicted in a clearly defined production process (as in the case of environmental amenities), the concept of sustainability as capital maintenance at the front (input) end of a production process does not apply. In these cases, one would have to look at the rear (output) end of production and other human activities, supplying desirable economic and non-economic "goods" and undesirable effects or "bads". If these goods and bads cannot be valued or costed in markets or through market simulation, social *evaluation* has to complement or replace monetary (market) *valuation*. Such evaluation would have to set explicit targets, thresholds or standards for assessing the achievement of non-economic objectives (see below, Section D).

#### *B. Accounting for environmentally sound and sustainable economic growth*

The above definitions of sustainable, and environmentally sound and sustainable, economic growth refer to variables that are compiled in national accounts, notably domestic product and capital consumption, modified to allow for environmental costs of natural resource depletion and environmental quality degradation. Such accounting draws attention, not only to additional cost elements of production, but also (via accounting identities) to income changes, altering the availability of monetary claims on the final results of economic production. The latter is more closely related to welfare aspects of economic activity - the ultimate goal of economic development.

As pointed out in the Introduction, UNSTAT has developed a System of integrated Environmental-Economic Accounting (SEEA) as a satellite system of the SNA.<sup>5</sup> The main difference between the SEEA and conventional accounting lies in the introduction of environmental costs of "quantitative" depletion of natural resources and "qualitative" environmental degradation (largely from pollution). Those costs are mirrored in the expansion of capital asset boundaries to include natural assets. The distinction between depletion and degradation reflects the conceptual differentiation between accounting for resource exploitation for purposes of sustainable economic growth and, additionally, for the degradation of environmental quality for purposes of environmentally sound and sustainable economic growth.

The use of environmentally adjusted macro-economic variables proposed in integrated environmental-economic accounting permits the direct integration of environmental criteria into macro-economic analysis. Such analysis should provide more accurate advice about how, and to what extent, policies of economic growth, employment, taxation, investment, inflation and trade should be reshaped to achieve environmentally sound and sustainable economic growth and development.

---

<sup>5</sup> The system is elaborated in the SNA Handbook on Integrated Environmental and Economic Accounting which is described in the contribution by C. Stahmer to the present compendium.



Overall economic growth is typically measured by time series of (real) Net Domestic Product (NDP). Deducting from Gross Domestic Product (GDP) an allowance for capital consumption and degradation of produced and natural assets thus results in a "more sustainable" indicator of economic growth, termed Environmentally adjusted net Domestic Product (EDP) in the SEEA. In this sense, the above definitions of environmentally sound and sustainable growth can now be more concisely formulated as increase in EDP. Further adjustments for the effects of environmental degradation on the quality of life or human welfare and accounting for cross-boundary "transfers" may obtain a more welfare-relevant concept of Environmentally adjusted National Income (ENI) (see Section III A below).

### *C. Accounting for structural change and cost internalization*

It can be argued that an increasing portion of economic activity is devoted to dealing with environmental and other undesirable side effects of economic growth and urbanization rather than to the generation of "true" (welfare-creating) income. A direct consequence of such policies would be a considerable distortion of the economic structure (Leipert 1989). In addition, the neglect of environmental costs of natural resource depletion and environmental quality degradation can also be considered as generating a structural distortion in the economy by subsidizing (under-pricing) those economic activities that use the environment as a supplier of natural resource inputs and waste absorption services. SEEA has been designed to reveal such distortion in production and consumption by accounting for the costs, created to society from lack of maintenance of natural capital and its environmental functions, and by identifying actual expenditures for "defending" society against a decline in environment-related quality of life.

It should be noted, however, that the deduction of imputed costs for uses of environmental assets from conventional macro-indicators does not mean that these costs are actually internalized at the micro-economic level by individual economic agents. These costs are imputations of natural resource depletion and potential abatement costs. The deduction of such imputed values generates aggregates whose valuation has not gone through the mill of price formation in the market and which are therefore not strictly comparable to the value of market transactions presented in national accounts. The function of indicators, modified by such imputations, is thus more to alert to structural distortions of the economy and unsustainable trends in its growth than to provide an accurate picture of past economic activity.

The deduction of defensive expenditures from national income and sectoral value added would permit in principle a more welfare-oriented assessment of overall and sectoral economic performance. This seems to be the idea behind proposals of calculating "sustainable income" that accounts for the costs of pollution, natural capital depreciation and defensive expenditures (Daly 1989; Pearce, Markandya and Barbier 1989, p.108).

More research is needed, however, to clearly specify the scope and contents of the different components of defensive expenditures in order to avoid double-counting of outlays already accounted for, for example in capital expenditures. Moreover, the simple removal of environmental expenditure from final demand does not take into account the generation of value added in "antecedent" industries which should be deducted as indirect costs of defensive expenditures (Schäfer and Stahmer 1989). A more philosophical argument is that in the final analysis much, if not most, of the "final bill of demand" could be considered defensive - against the deterioration of the current state of health and wealth of human beings. Consequently, SEEA contents itself to identify environmental protection expenditures in both intermediate consumption and final demand categories. Environmental protection activities are defined on the basis of categories of appropriate classifications, but are not subtracted from output or value added as an additional "social" cost.

In market economies, the appropriate tools of implementing structural changes are economic (dis)incentives, such as effluent charges, marketable emission permits, user taxes on natural resources or the removal of environmentally adverse subsidies. (Dis)incentives aim at the internalization of environmental costs and benefits into the accounts and budgets of micro-economic agents of enterprises and households. The objective is to encourage alternative resource saving and environmentally sound production and consumption patterns. The basic rationale behind these measures is expressed by the polluter-pays-principle (including liability for environmental accidents and other damages) and the user-pays-principle for the depletion of scarce natural resources. The aim is in both cases to make those who cause environmental problems accountable for their environmental impacts.

Environmental cost internalization might prompt economic agents to turn environmental costs into regular costs of tax expenditure, or capital consumption and intermediate consumption for the adoption of environmentally sound production processes. Imputed environmental costs might then decrease to the extent they are successfully diminished by actually implemented environmental protection measures. As a result, the values of the economic aggregates in SNA and environmentally adjusted aggregates in SEEA would tend to converge. Comparing SNA and SEEA aggregates can thus provide an indication of the success of market incentives in integrated environmental-economic policies.

#### *D. Beyond accounting: modelling integrated development*

Economic planning and policies are typically integrative, traditionally focusing on aggregative variables that use the *numéraire* of the monetary unit for aggregation in accounting, modelling, and policy/programme evaluation. As indicated above, certain aspects of sustainability and environmental soundness lend themselves to such monetary aggregation but find their limits with increasing distance from the economic process, or where social concern overrides individual valuation implicit in market price formation. Developmental goals of a social,

especially distributionary, cultural or political nature are hardly possible to value in money terms. In fact, the policy focus on monetary measures of economic growth has been criticized by advocates of multi-dimensional development, addressing a variety of social concerns as part of the overall goal of improving the quality of life.<sup>6</sup>

As indicated in Section A, social evaluation has to replace in these cases monetary valuation. Exogenously set standards or targets could then be used to assess the "feasibility" of development programmes operating within a normative framework of such standards. Concentrating on environmental, social and economic development objectives, physical (non-monetary) standards can be categorized as:

- (a) environmental thresholds or standards of natural resource capacities, emissions, loadings of environmental media, ambient concentrations, exposure or contamination;
- (b) ecological standards of the carrying capacity of vulnerable lands for human populations;
- (c) standards of equity in the distribution of income and wealth, access to natural resources and the distribution of environmental costs and benefits, between and within countries and present and future generations; and
- (d) economic standards of living or human needs satisfaction.

Trade-offs and synergisms among economic (growth) and other, environmental and social, objectives require the modelling of compatible development strategies operating within this framework of standards.

Much of the physical data base for such analysis can be developed in "natural resource accounts" (Alfsen, Bye and Lorentsen 1987). To the extent that these accounts overlap in scope and coverage with (monetary) environmental accounts, they can be considered as their physical counterpart. The physical aspects of environmental accounting have therefore been given equal weight in the SEEA and the Handbook on Integrated Environmental and Economic Accounting.

However, the description of the transformation of materials and energy sources in the economic sphere does not give a complete picture of the consequences of economic activities for the environment. There are no generally accepted models of the dynamics of economic impacts on and repercussions from the natural

---

<sup>6</sup> Much of the discussion around the notions of quality of life and social indicators has been on the inadequacy of a development process that concentrates on economic growth, neglecting social values of security, health, distribution of income and wealth, and environmental quality (OECD 1973, p. 3).

environment, in particular of the full sequence of residual emission, distribution, transformation and ambient concentration, and human and non-human exposure to and final contamination by the pollutants. These difficulties of identifying unequivocally functional relationships between economic and environmental variables are the main reasons why the United Nations *Framework for the Development of Environment Statistics* (FDES) and related methodologies opted to simply list environmental and related economic variables under major information categories, without attempting to specify further connections among them (United Nations 1984, 1988 and 1991).

However, more limited analytical data bases such as input-output tables could be adapted to joint environmental/economic analysis without the use of a monetary *numéraire* for the evaluation of selected environmental impacts. Environmental cost due to natural resource depletion and degradation can be presented in physical terms in an extended supply and use table such as the one developed for the Handbook on Integrated Environmental and Economic Accounting. For each element of environmental use, there is a *row* which includes positive elements as cost of different economic activities and final demand categories, and negative elements reflecting the degradation or depletion of the different economic and environmental assets. Each of the rows represents thus a material/energy balance, expressed in a common physical unit. Similarly, resource balances corresponding to asset *columns* are expressed in common units. Analysis of such tabulations would not necessarily require monetary valuation. If input-output relations were assumed between the traditional input/output elements and the corresponding environmental impacts, recorded in physical terms, selected environmental uses could be "predicted" without attaching monetary values.

On the other hand, aggregate analysis as applied in macro-economic growth models cannot be carried out without monetary valuation, since different environmental uses, recorded in separate rows, would have to be added together. Without monetary valuation it would therefore be impossible to determine the extent to which overall growth of the economy (e.g. NDP growth) is affected by environmental impacts.

### III. Measurement and Valuation Issues (by Jan van Tongeren)

Sustainable economic growth, based on SEEA concepts, and traditional economic growth, based on SNA concepts, are described and determined by two types of measures. These are, on the one hand, net product generated in production and net income initially received by production factors and subsequently redistributed to individuals and households through the mechanism of transfers and, on the other hand, changes in capital defined as capital formation in SNA and alternatively as capital accumulation in SEEA. The two groups of concepts are differently defined in the two systems which has important implications for measurement and analysis of growth.

The present section deals with a number of conceptual issues of the product, income, capital formation and accumulation measures. Some of these issues are dealt with in the Handbook but require further discussion, while others are not yet addressed and need to be further elaborated in the future.

#### *E. Net product and income*

The main concept in the Handbook is Environmentally adjusted net Domestic Product (EDP). This concept is the environmental equivalent of NDP in the SNA. In addition to the cost taken into account in NDP, EDP also reflects the imputed cost of using natural assets. The Handbook includes various versions of EDP. In one concept of EDP --which could be called the production- or value added-oriented concept of EDP-- only the immediate cost of the use of natural or environmental assets is taken into account. This version of EDP does not reflect any consequential or secondary welfare effects such as the effects of lesser quality of air and water on health and in general on the quality of life. These effects are taken into account to some extent in an alternative version of EDP which reflects the repercussion cost actually incurred by producers (e.g. soil erosion effects in agriculture caused by mining or forestry) or consumers (e.g. health expenditures) as well as imputed environmental cost valued on the basis of a contingent valuation.

The main question is whether the welfare effects of environmental impacts could be dealt with by defining an Environmentally adjusted Net Income (ENI) concept which could be considered as the environmental equivalent of net income in the SNA. If such a concept were introduced, the relation between ENI and EDP in SEEA would be similar to the relation in the SNA between NDP and National Income (NI) <sup>7</sup>.

---

<sup>7</sup> The distinction between net product and net income is not the same as made in section II A between sustainable economic growth and environmentally sound and sustainable economic growth. This distinction is made within EDP: i.e. sustainable economic growth refers to growth of NDP, adjusted only for the use of scarce resources (depletion allowance), and environmentally sound and sustainable economic growth refers to growth of NDP, further adjusted for environmental quality degradation, i.e. growth of EDP.

The definition of an ENI concept would permit a more adequate conceptual integration of the welfare effects with the main framework of SEEA than treating these aspects in an alternative version of the product-oriented concept of EDP, as is presently done in the Handbook. Such integration is important, as environmental impacts affecting welfare may sometimes be much larger and involve a much wider group of the population affected by these impacts than the immediate cost of environmental impacts. In EDP, those costs involve only producers and in some instances consumers as the causing agents. For these reasons, the welfare effects have been much more stressed in past literature (Peskin 1989; Hueting 1989; Pezzey 1989) than the immediate cost effects. Immediate environmental costs were first dealt with in studies carried out by the World Resources Institute in Indonesia (Repetto *et al.* 1989) and Costa Rica (Solórzano *et al.* 1991) and thereafter further elaborated as part of the development of the SEEA (Bartelmus, Stahmer and van Tongeren 1991).<sup>8</sup> Development of conceptual links between the cost- and welfare-oriented approaches would have the potential of clarifying the present discussion on environmentally adjusted measures and should therefore be attempted even though it may be much more difficult to implement the welfare approach than the cost oriented approach.

In the SNA, *net product*, or what is called net value added, is the net value of output of production after deduction of intermediate cost charges for replacing produced assets used up in production. In line with business accounting practices, such replacement is needed in order to secure continuation of income generation in the future. The assets that are to be replaced are fixed assets for which depreciation charges are deducted, as well as goods that are channeled through stocks before being used up in production and for which charges are included in intermediate consumption. Services are deducted as part of intermediate consumption because they could be considered as intangible components of the goods that are used up in the production process.

*Net income* in the SNA is what is net received by income recipients after the value of net product generated has been distributed. Without entering into the refinements of concepts in the SNA, one could roughly distinguish between two net income concepts: net primary income, or National Income (NI) at the national level, which includes what is received directly by production factors participating operationally or financially in the production process, and net disposable income or National Disposable Income at the national level, which covers net receipts left over after unrequited current transfers received and paid have been added and deducted. Contrary to what is included as intermediate cost or depreciation to arrive at net product, none of the net receipts by production factors, including receipts of interest on financial capital or receipts of rent on land, are charges to replace capital; they reflect the distribution of net product in the form of income. If the economy of the country is closed and no production taxes and subsidies are levied,

---

<sup>8</sup> See however, Bartelmus (in prep.) who favours the use of EDP and related indicators to define sustainable growth, while advocating standard setting (in physical terms) for modelling broad (multi-dimensional) development beyond economic growth (see also Section II D, above).

the national totals of net product and net income are the same, i.e. NDP is equal to NI and (net) National Disposable Income.

The SNA distinction between net product and net income may be applied in a similar manner to SEEA. Environmentally adjusted Net Product (EDP) in SEEA reflects a wider range of charges than NDP in SNA. It includes not only charges to replace produced assets but also imputed charges for the use of natural assets in production, needed to maintain those non-produced natural assets intact. The additional charges are the depletion and degradation costs referred to in the Handbook.

Not all charges for the degradation of non-produced assets, *caused* by production and consumption, however, are finally *borne* by the causing agent. For instance, a producer or consumer may cause pollution of air and water or contaminate land through deposit of solid wastes, but does not bear the consequences of this pollution. The consequences may be borne by individuals in households whose health deteriorates and thus have to spend on medical services, or by the government which provides free sanitation services to clean up industrial and household wastes. It may also be borne by other enterprises which have to pay for cleaning the water needed for their production process and which was polluted by other producers. Producers may also sometimes bear some of the consequences of their pollution, for instance when they are forced by law or social pressure to install pollution equipment or to pay environmental taxes. The cost could also be borne by neighbouring countries which absorb some of the toxic residuals through the water it receives from common rivers or lakes or through acid rain, or even nature may bear the consequences because it ultimately absorbs all residuals unless recycled back into production or consumption.

In all these instances one may consider that the sectors bearing the consequences of environmental effects are providing free services to the sectors causing the environmental degradation. These services, which are called by Peskin (1989) services of the production factor nature, could be compared with services of labor and capital considered in the SNA. Deduction of these services from NI would result in the derivation of Environmentally adjusted Net Income (ENI). ENI would include the remaining receipts of income by production factors other than nature.

The suggested inclusion in SEEA of an ENI concept in addition to an EDP concept is very much dependent on the distinction made between *cost caused* and *cost borne*. Cost caused is deducted from NDP in the SNA to arrive at EDP, and ENI is proposed to be derived by deducting from NI cost borne.<sup>9</sup>

Cost caused and cost borne may be very different for a number of reasons. Firstly, cost caused could be eliminated before it becomes cost borne and would

---

<sup>9</sup> The differences between cost caused and cost borne refer to degradation only. In the case of depletion of natural assets, which has no further effects on the quality of life, cost caused and cost borne are the same.

have no welfare effects. In many instances, the natural environment may absorb pollution and break down the pollutants generated. Also, the pollutants could be transferred to neighbouring countries and thus not result in any cost borne in the countries where the cost is caused. Environmental protection activities carried out by producers, households or government with the intention of avoiding pollution or at least eliminating it before it can have a welfare effect may be another reason why cost caused and cost borne are not the same. The absorption capacity of the natural environment is limited of course. If, therefore, pollution is considerable, the difference between cost caused and cost borne would be reduced in the long run. The same presumably would hold for the absorption capacity of neighbouring countries. There is a limit to what the countries could absorb; furthermore, they may not only absorb pollution but also may also cause pollution that will need to be borne by the country in question.

The second reason for the discrepancy between cost caused and borne has to do with valuation and secondary effects of environmental impacts. *Cost caused* by environmental effects should be valued on the basis of the same principles as intermediate cost and depreciation as valued in the SNA. It would be the cost that would be incurred in order to eliminate the damage to the asset actually used in production. This would be the immediate damage to air, water or land resulting from production and not the secondary damage to health, quality of life or even the reduction in productivity (in agriculture for instance). The cost caused would have to be valued either at the cost of avoiding or the cost of eliminating the damage by restoring the asset to its quality before it was affected by production. The cost caused would include the cost of environmental protection activities of producers, where these are aimed at eliminating or avoiding the environmental effects caused by their own production.

*Cost borne* on the other hand may be very different, because it would include all the effects that are not taken into account in the cost caused. These costs could be secondary effects on health or the quality of life in general, but also such effects caused in other periods. On the other hand, they could be effects caused during the period of time which are only reflected in cost borne in later periods. Furthermore, there may be differences in valuation. In valuing the cost borne one should use valuations such as willingness-to-pay to value health effects, cost to clean up when environmental impacts are felt from pollution in neighboring countries, and also valuations may be based on reductions in productivity which are a consequence of environmental impacts such as land erosion, water pollution, and so on. The environmental effects borne are net, that is, after such effects have been avoided or eliminated by environmental protection expenditures such as expenses on medical care and expenses by the government on recycling, sanitation and other clean-up activities which eliminate the environmental damage caused by others. Assuming that these expenditures are representative of the impacts eliminated or avoided, they should be included in the cost borne. As the secondary environmental effects, taken into account in ENI, might be much larger than the immediate environmental effects reflected in EDP, one may assume that ENI would often be lower than EDP.



The relation between cost caused and cost borne could be formalized by the following identity:

$$\text{(PRODDGR)} = \text{(CONSDGR)} + \text{(DGREXT + DGRNATU)} + \text{(PROTDGR)} - \text{(VALUEDIFF)} \quad (\text{A.1})$$

In the identity, environmental degradation caused by production or consumption activities (PRODDGR) is borne by households and other producers (CONSDGR), neighbouring countries (DGREXT) and the natural environment (DGRNATU), and a part is eliminated or avoided with help of environmental protection activities (PROTDGR). As environmental impacts borne may be larger than those caused, as a result of secondary effects and differences in valuation, an additional term (VALUEDIFF) is introduced to reflect these differences. Both (PRODDGR) and (CONSDGR) include the net environmental effects after environmental protection activities by producers or households and government took place. The identity helps in defining the relation between EDP and ENI.

The importance of each of the elements of the identity may change depending on circumstances. For instance, if environmental impacts are minor and most can be absorbed by nature, (CONSDGR) would be close to zero. On the other hand, if environmental effects are very substantial, the absorption capacity of nature and neighbouring countries may be negligible and all environmental degradation would have to be borne by households, and in that case (DGREXT + DGRNATU) would be close to zero.

EDP in terms of the elements presented in the identity would be derived by deducting from NDP, the environmental degradation caused by producers and consumers (PRODDGR), i.e.

$$\text{EDP} = \text{NDP} - \text{(PRODDGR)} \quad (\text{A.2})$$

ENI, on the other hand, would be obtained by deducting from National Income (NI) in the SNA, the sum of environmental degradation cost borne by households, enterprises other than those causing the environmental impacts, and government, either in the form of environmental degradation or as expenditures on environmental protection activities, i.e.

$$\text{ENI} = \text{NI} - [(\text{CONSDGR}) + \text{(PROTDGR)}] \quad (\text{A.3})$$

The difference between ENI and EDP would be

$$\text{(ENI-EDP)} = \text{(NI-NDP)} - [(\text{CONSDGR}) + \text{(PROTDGR)} - \text{(PRODDGR)}] \quad (\text{A.4})$$

or, what is the same, after substitution of elements of (A.1)

$$\text{(ENI-EDP)} = \text{(NI-NDP)} - [(\text{VALUEDIFF}) - (\text{DGREXT} + \text{DGRNATU})] \quad (\text{A.5})$$

The incorporation of (VALUEDIFF) implies that the difference between EDP and ENI would be larger, the larger the difference between environmental effects caused

and borne in terms of valuation and secondary effects. On the other hand, if (VALUEDIFF) would be zero, ENI would be larger than EDP because of the absorption of residuals by nature or the external environment (DGREXT+-DGRNATU), which would eliminate some of the welfare effects of environmental impacts caused that are reflected in EDP.

ENI as defined above is close to the concept of GNP developed by Peskin (1989). Peskin does not take NI as the point of departure. He rather starts from GNP as compiled in the US accounts, when deriving GNP. He does mention, however, that the same approach could be followed when replacing GNP by NNP or (what is called here) NI.

#### *F. Capital*

The Handbook introduces a new concept, called capital accumulation, which replaces the traditional capital formation concept of the SNA. Net capital accumulation as defined in the Handbook would reflect, in addition to the deductions for depreciation of produced capital assets from capital formation, also deductions for depletion and degradation of non-produced assets. This would include the depletion of mineral reserves and forests, the degradation of all mineral assets that are affected by residuals, emitted by production processes and finally it would include the deterioration of natural assets such as forests when they are converted to economic uses such as agricultural land or holdings of livestock. Capital accumulation does not include the additions to the stock of proven mineral reserves or additions to natural assets that are used in economic activities.

There are two questions related to the new capital accumulation concept that are dealt with here. The first one is whether the wider capital accumulation concept is a useful one, particularly in view of its use in a modified growth theory in which not only produced capital is taken into account but also the use of non-produced natural assets. The other question is whether capital accumulation in its coverage should be entirely reflected in EDP in the same manner as capital formation is reflected through output and depreciation in NDP.

In order to answer these questions, one should consider the objectives of the concept of net capital formation in the SNA and use the essence of these objectives for evaluating the concept of capital accumulation in the SEEA. It was explained above that the SNA only maintains intact produced assets and thus includes as cost the use of those assets as intermediate consumption and depreciation to arrive at net value added or net product. Implicit in this treatment is that only the use of produced assets is productive in the sense that they contribute to generation of output and value added. All other assets in the SNA are treated as assets that affect distribution of net product in the form of income and not generation of net product.

Net capital formation then reflects all the changes in these produced assets that are the result of production activities, and this includes production of capital

goods, changes in stocks of other goods and also depreciation of produced assets. Capital formation does not reflect losses of produced capital stocks that are the result of events not directly related to economic activities, such as non-regular obsolescence, earthquakes and other natural disasters. These changes in the capital stock are dealt with in a separate account called other volume changes account and do not affect NDP in the SNA. The capital formation concept thus defined plays the role of an endogenous variable in the analysis of economic growth in terms of changes in NDP. Changes in capital unrelated to production are introduced exogenously into such analysis.

When considering the criteria for capital formation outlined above, a number of comments could be made on the concept of capital accumulation as presently included in the Handbook. In the first place one might wonder whether it is useful to reflect in capital accumulation, the deterioration of natural assets, such as air, water and natural forests and similarly undeveloped assets or even human capital as reflected in damages to health. Such assets do not contribute to growth of EDP in a manner similar to contributions made by non-produced developed assets<sup>10</sup> such as cultivated agricultural land, pastures for livestock and land for urbanization, or exploited timber tracts and mineral reserves. It is clear that mineral deposits play a role in the generation of net product in the mining industry and that agricultural land contributes to generation of income in agriculture. However, the contribution of air, water and natural forests to the generation of NDP is much less clear; these assets are much less contributors to the generation of EDP than being affected by environmental impacts through the generation of EDP. This also applies to human capital whose health is affected, while at the same time the health effects on production are more difficult to identify.

One may also question whether it is useful to exclude from capital accumulation all additions to the stock of mineral and other natural developed assets when these assets are transferred from the environment to economic activities. Even more so, because these assets were transferred to economic activities with the explicit intention of increasing production. To increase production in agriculture often can only be done by expanding the amount of land used in agriculture or land used for holdings of livestock. Land transferred for the purpose of urbanization would respond to the needs of increasing industrial production or the production of services. Similarly, to increase production in the mining industry, exploration activities are expanded with the intention of increasing the number of proven reserves, and so on. There is therefore a very strong argument for including in capital accumulation not only depletion of such assets, but also additions to the stock of assets used in economic activities.

---

<sup>10</sup> The term developed assets have been used here as a generic term that would identify the assets that are directly used in economic activities. In terms of the Handbook, this coverage could be defined as including those assets for which there is a direct market value or indirect market value based on capitalization of future income streams. In terms of the SNA it would include all economic assets, i.e. assets that are providing benefits to their owners.

Furthermore, not including these additions to the stock of natural assets in capital accumulation would create a special problem with regard to the treatment of stock of minerals. If the treatment in the Handbook is followed, changes in stocks would reflect the depletion of minerals as a result of exploitation. Changes in stocks related to minerals would always be negative, because additions to stocks are not recorded. This anomaly could be avoided by including in capital accumulation the additions to the stock of minerals.

Incorporation of the changes in the capital accumulation concept suggested above does not necessarily mean that those changes should also affect EDP, however, as is implied by the treatment of the Handbook. At present the Handbook reflects all capital accumulation in EDP, and *vice versa* all changes in capital that affect EDP are reflected in capital accumulation. Such relation between capital accumulation and EDP is directly based on the relation between capital formation and NDP in the SNA. In the SNA the following identity holds:

$$\text{OUTPUT} + \text{IMPORTS} = \text{INTERMED. CONS.} + \text{FINAL CONS.} \\ + \text{NET CAPITAL FORMATION} + \text{EXPORTS} \quad (\text{B.1})$$

By re-arranging the terms, NDP could be introduced and two dependent identities could be established:

$$\text{NDP} = \text{OUTPUT} - \text{INTERMED. CONS.} \quad (\text{B.2})$$

$$= \text{FINAL CONS.} + \text{NET CAPITAL FORMATION} \\ + (\text{EXPORTS} - \text{IMPORTS}) \quad (\text{B.3})$$

The Handbook, while using the same identities, changes the definitions of all concepts by including additional imputed cost for depletion and degradation, and accordingly changes the term capital formation to capital accumulation. One might argue, however, that such treatment would not be appropriate in a system such as SEEA, which emphasizes that economic activities, in addition to making use of their own output in production, consumption and capital formation, also utilize free resources provided by nature. This idea is not at all made explicit if the SNA identity is taken over by SEEA without any major change. It would be more appropriate to recognize that uses on the right hand side of identity (B.1) would not only be supplied by domestic production activities as reflected in output and imports, but that an important source of supply would be the environment. If that is accepted, the identities would change as follows:

$$\text{OUTPUT} + \text{IMPORTS} + \text{ENVIRONMENT} = \text{INTERMED. CONS.} + \text{FINAL CONS.} \\ + \text{NET CAPITAL ACCUMULATION} \\ + \text{EXPORTS} \quad (\text{B.4})$$

and, after re-arrangement of the terms and introducing EDP in the identity, it could also be written as:

$$\text{EDP} = \text{OUTPUT} - \text{INTERMED. CONS.} \quad (\text{B.5})$$

$$= \text{FINAL CONS.} + (\text{NET CAPITAL ACCUMULATION} - \text{ENVIRONMENT}) \\ + (\text{EXPORTS} - \text{IMPORTS}) \quad (\text{B.6})$$

What is implied by the modified identities presented above, is that the amended definition of capital accumulation is accepted, however without affecting EDP. New findings of mineral resources and other additions to the stock of non-produced assets would be included in net capital accumulation, at the same time recorded as a reduction in environmental capital (- ENVIRONMENT) and thus would not affect EDP. On the other hand, degradation of non-developed assets such as air and water would not be included in capital accumulation, but would be recorded as a reduction in environmental capital (-ENVIRONMENT) and thus would affect EDP. On the other hand, by introducing the environment --which really means environmental capital-- as a source of assets, it is possible to reflect these changes in the element called environment rather than in EDP. The element (-ENVIRONMENT) would thus reflect new findings and transfer of natural assets from the environment to economic activities, and also the deterioration of natural assets that are affected by human economic activities. By including the environmental capital as a part of the capital of SEEA, it would then be possible to maintain the amended definition of capital accumulation without affecting EDP.

One would have to recognize of course that this new identity would eliminate the closed circuit of production and use of the present SNA which is essential for the traditional growth theory. Instead, in developing growth models one would have to recognize that one of the contributing factors to growth would be the environment which supplements capital resulting from output of economic activities. This would be a change that is in line with the spirit of SEEA.

The alternative to reflect some of the additions to capital that are included in the proposed coverage of capital accumulation in EDP seems less attractive. This is done in studies by the World Resources Institute that were conducted in Indonesia and Costa Rica. In particular in the case of Indonesia for oil (Repetto *et al.* 1989), EDP (in the sense discussed above) would be higher than NDP for some years, because of large new findings of proven petroleum reserves. Also, in the case of Costa Rica, for some years EDP would be higher than NDP because natural forests are taken into exploitation. There are two important disadvantages to such a procedure. The first one is that capital-output ratios or similar analytical measures would be seriously distorted in years in which large additions are made to the proven reserves, and EDP and capital accumulation are increased with the same amount. Another disadvantage would be that the environmental alert function of SEEA would not work properly. In times that resources become more scarce, there may be pressures of bringing into the reserves of natural assets used for economic activities, natural resources that were previously part of the natural environment. This could apply to natural forests as well as to oil deposits. If these additions would be always reflected in EDP, EDP in such periods would continue growing and it would be only at the time that no additional reserves could be found that EDP would start decreasing because of depletion. That, however, may be too late.

There is also an implication of the ENI discussion above for the valuation of capital accumulation. In section A above, it was argued that there would be a difference between cost caused and cost borne. This obviously would affect the identity assumed in the Handbook between the cost of use of natural assets and the deterioration of the assets that would be recorded in the asset balances. The

difference was reflected above in the term (VALUEDIFF). These included differences caused by secondary effects on assets immediately used in production, such as effects on the productive capacity of land as a consequence of land erosion or contamination of water, which may be much larger than the initial environmental impacts recorded as cost in the derivation of EDP. Other differences are those in valuation between, for instance, the use of avoidance cost to value environmental uses in the calculation of EDP and willingness-to-pay as a basis for valuing the damage done to natural assets. As the deterioration of the asset should be the basis for determining capital accumulation, one would have to accept that capital accumulation would be depreciated in a manner that is different - and generally higher - than the cost accounted for in the calculation of EDP.

There is a special problem concerning valuation in accounting for depletion of mineral assets. For these assets, the difference between valuation of cost and depreciation of assets is represented by the different approaches to calculate the implicit cost of depletion suggested by El Serafy (1989) on the one hand and used in studies conducted by the World Resources Institute in Indonesia (Repetto *et al.* 1989) and in Costa Rica (Solórzano *et al.* 1991) on the other. The World Resources Institute approach is generally based on the calculation of net rent for the resources that are depleted. However, the method developed by El Serafy calculates an implicit cost to depletion which reflects the amount that needs to be re-invested in other (financial) assets in order to secure a continuation of the same net income flow after deduction of the mineral reserves.

The two methods would result in very different valuations of EDP. Without entering into technical details of the calculations used in both methods (see e.g. Bartelmus, Lutz and Schweinfest 1992, Annex 4), one could characterize the net rent method as the one that correctly reflects the reduction in the asset value as a result of depleting the resource and therefore should be taken into account in the calculation of EDP. The method developed by El Serafy could be considered as one to determine the amount needed for re-investment in another (financial) asset in order to secure the continuation of the income flows after the mineral asset has been depleted. This implies that, while the mineral asset is being depleted following the amount of net rent, at the same time it is being replaced by another asset that provides a supplementary income stream. Capital accumulation may reflect this re-investment and thus record not a deduction for the total net rent of minerals depleted, but rather reflect the difference between the net rent and the depletion allowance. Capital accumulation thus would take into account the fact that a part of the mineral assets that are depleted are replaced by other (financial) assets also generating income.<sup>11</sup>

Following the comments made above, it is suggested that capital accumulation would include a selection of the items, defining the changes between

---

<sup>11</sup> The assumption in the method developed by El Serafy is that alternative investments, particularly in financial assets, are feasible. However, one may wonder whether this is a realistic assumption in many developing countries with natural resource exploitation, where the possibilities of alternative investment are very limited indeed.

the opening and closing balance sheets, and that this selection would not necessarily coincide with the capital-related cost that affect EDP. In particular, it has been suggested above that capital accumulation would include, in addition to the capital cost reflected in EDP, new findings and transfer of natural reserves from the natural environment to economic activities. It would not reflect the capital cost related to assets such as air and water which are not immediately used as assets in production. It would not take into account the entire net rent of depleted resources as reflected in EDP, but only that part of net rent which is not converted to another (financial) asset through the calculation of a depletion allowance. On the other hand, capital accumulation would reflect the difference between the avoidance or restoration cost reflected in EDP and the damage done to assets that are directly used in production.

## References

- Ahmad, Y.J., S. El Serafy and E. Lutz (eds.) (1989). *Environmental accounting for sustainable development*. Washington, D.C.: The World Bank.
- Alfsen, K.H., T. Bye, and L. Lorentsen (1987). *Natural resource accounting and analysis, The Norwegian experience, 1978-1986*. Oslo: Central Bureau of Statistics of Norway.
- Bartelmus, P. (in prep). "Accounting for sustainable growth and development" (to be published in *Structural Change and Economic Dynamics*).
- \_\_\_\_\_, C. Stahmer and J. van Tongeren (1991). "Integrated environmental and economic accounting - framework for a SNA satellite system". *The Review of Income and Wealth*., series 37, no. 2, 111-148.
- \_\_\_\_\_, E. Lutz and S. Schweinfest (1992). *Integrated environmental and economic accounting - a case study for Papua New Guinea*. The World Bank, Environment Working Paper No. 54, Washington, D.C.
- Daly, H.E. (1989). "Toward a measure of sustainable social net national product". In Ahmad, El Serafy and Lutz (1989), 8-9.
- El Serafy, S. 1989. "The proper calculation of income from depletable natural resources". In Ahmad, El Serafy and Lutz (1989), 10-18.
- Huetting, R. (1989). "Correcting national income for environmental losses: toward a practical solution". In Ahmad, El Serafy and Lutz (1989), 32-39.
- Leipert, C. (1989). "National income and economic growth, the conceptual side of defensive expenditures". *Journal of Economic Issues*, Vol. 23 (3), 843-856.
- Organization for Economic Co-operation and Development (OECD) (1973). *List of social concerns common to most OECD countries*. Paris: OECD.
- Pearce, D., A. Markandya and E.B. Barbier (1989). *Blueprint for a green economy*. London: Earthscan Publications Ltd.
- Peskin, H. (1989). *Accounting for natural resource depletion and degradation in developing countries*. The World Bank, Environment, Working Paper No. 13, Washington, D.C.
- Peskin, H.M. with E. Lutz (1990). *A survey of resource and environmental accounting in industrialized countries*. The World Bank, Environment Working Paper No. 37, Washington, D.C.
- Pezzey J. (1989). *Economic analysis of sustainable growth and sustainable development*. The World Bank, Environment Working Paper No. 15, Washington, D.C.



Repetto, R. *et al.* (1989). *Wasting assets, natural resources in the national income accounts*. World Resources Institute, Washington, D.C.

Schäfer, D. and C. Stahmer (1989). "Input-output model for the analysis of environmental protection activities". *Economic Systems Research*, Vol. 1, 2, 203 - 228.

Solórzano, R. *et al.* (1991). *Accounts overdue, natural resource depletion in Costa Rica*. Tropical Science Centre, San José, Costa Rica and World Resources Institute, Washington, D.C.

United Nations (1984). *A Framework for the Development of Environment Statistics*, Ser. M. No. 78. United Nations: New York.

\_\_\_\_\_ (1988). *Concepts and methods of environment statistics: human settlement statistics - a technical report*, Series F, No. 51. United Nations: New York.

\_\_\_\_\_ (1991). *Concepts and methods of environment statistics: statistics of the natural environment*, Series F, No. 57. United Nations: New York.

\_\_\_\_\_ (1992). Revised system of national accounts (provisional, ST/ESA/STAT/SER.F/2/Rev.4).

van Tongeren, J., S. Schweinfest and E. Lutz (1991). *Integrated environmental and economic accounting - a case study for Mexico*. The World Bank, Environment Working Paper No. 50, Washington, D.C.

SYSTEM FOR INTEGRATED  
ENVIRONMENTAL AND ECONOMIC  
ACCOUNTING (SEEA)  
OF THE UNITED NATIONS

Carsten STAHER

Federal Statistical Office, Germany

INTRODUCTION

The discussion of environmentally sound and sustainable socio-economic development has received increased attention by the international community, stimulated in particular by the report of the World Commission on Environment and Development (1987). Environmentally sound and sustainable development was also the basic theme for the United Nations Conference on Environment and Development in Rio de Janeiro in June 1992.

The need for clarifying this new development concept and for developing methodologies for its assessment and implementation has been recurrently stressed in international conferences. Joint workshops, organized by UNEP and the World Bank, set out to examine the feasibility of physical and monetary accounting in the areas of natural resources and the environment and to develop alternative macro-indicators of ecologically adjusted and sustainable income and product (Ahmad, El Serafy, Lutz, 1989). A consensus emerged in the workshops that enough progress had been achieved to link environmental accounting to the System of National Accounts, the SNA (United Nations, 1968), and to include certain aspects of environmental accounting in the ongoing revision of the SNA.

The current revision of the SNA (United Nations, 1992a) presents a unique opportunity to examine how the various

concepts, definitions, classifications and tabulations of environmental and natural resource accounting can be linked to the SNA and incorporated in a framework for integrated environmental and economic accounting. It was not felt suitable, however, to radically change a well-established system of economic accounts that serves many different short, medium and long-term socio-economic analyses.

The Statistical Commission of the United Nations, at its twenty-sixth session, therefore requested that the concepts and methods of environmental and natural resource accounting should be further elaborated in a SNA Satellite System for Integrated Environmental and Economic Accounting (SEEA). Satellite systems of national accounts generally stress the need to expand the analytical capacity of national accounting for selected areas of social concern in a flexible manner, without overburdening or disrupting the "core" system.

The immediate objective of the SEEA is thus to provide a conceptual basis for implementing a SNA satellite system which describes the interrelationships between the natural environment and the economy. This is achieved by linking the conventional economic accounts with environmental and natural resource accounts. Ultimately, integrated environmental and economic accounting is to support integrated social, economic and environmental policy by means of an integrated information system.

The present version of the SEEA was prepared by the Statistical Division of the United Nations Department of Economic and Social Development (UNSTAT) with the assistance of the author of this paper, acting as a consultant to the United Nations. His work has been supported in particular by Peter Bartelmus (UNSTAT), Guenter Hamer (Federal Statistical Office, Germany) and Jan van Tongeren (UNSTAT). Valuable advice and suggestions were received from many national accountants and environmental statisticians, notably Hans Adler, Alfred Franz, Allison

Gilbert, Anne Harrison, Roefie Hueting, Henry Peskin, Robert Repetto, Andre Vanoli, Klaus Wolff and Michael Young.

The concepts of the SEEA in the present Handbook reflect "work in progress". The complexity and diversity of the topics call for strict consistency of both monetary and physical flows and assets covered in an integrated approach of environmental and economic accounting. This is not an easy task, and the expertise of other international organizations and experts in the field is deemed essential for the further development of the SEEA. The conceptual discussion needs to be continued during the next years to develop widely acceptable concepts and methods. The present "interim" version of the SEEA is thus to make existing methodologies widely available in order to facilitate a broad consensus on a commonly acceptable integrated framework. At the same time, the feasibility of the proposed concepts and methods has to be tested by implementing the SEEA in countries at different stages of development. The results of the theoretical discussion and the empirical work will be used to prepare the "final" version of the SEEA which would also take into account the internationally approved concepts and methods of the forthcoming revised SNA. To the extent possible, these results have been anticipated in the present SEEA.

#### 1. APPROACHES OF ENVIRONMENTAL AND ECONOMIC ACCOUNTING SYSTEMS

As actual experience and the conceptual discussion have shown, there is a large variety of approaches in the design of statistical systems describing the interrelationship between the natural environment and the economy (see United Nations, Economic Commission for Europe, 1991). Two extreme positions are the following:

- The description is solely focussed on the natural environment. The environmental-economic linkages are described with special regard to economic impacts on the

environment. An important part of such a statistical framework is dedicated to a **spatial description** of the natural environment, using for instance maps of the respective region. The information is normally presented in physical units.

- A second extreme type of statistical frameworks for environmental-economic accounting focuses only on the economy and takes into account the environmental-economic linkages only as far as they are connected with **actual economic transactions** (e.g. environmental protection expenditures, actual damage costs). These data systems are normally extensions of the traditional national accounts. They disaggregate the flows and assets of the accounting system with regard to environmental aspects. The results are mainly restricted to monetary data which reflect actually observable market data.

In Table 1 these two concepts are indicated under the number (1) and (6), respectively.

Approaches which are located between these two extremes could be classified with regard to the use of statistical units: Some statistical data systems take into account either physical or monetary data, some present a combination of them. Systems which mainly use a uniform type of statistical units are the following:

- The physical description of the natural environment could be extended to include information on the physical flows between the environment and the economy (use of natural resources, flow of residual products). The present systems of **natural resource accounting** and environment statistics comprise mainly these data (in Table 1: (1) and (2) (cf. e.g. United Nations, 1984, 1988, 1991). This description in physical terms could be extended to information on transformation processes within the economy. The approach of **material/energy balances** comprises a physical description of the use of

**Table 1: Approaches of environmental accounting systems**

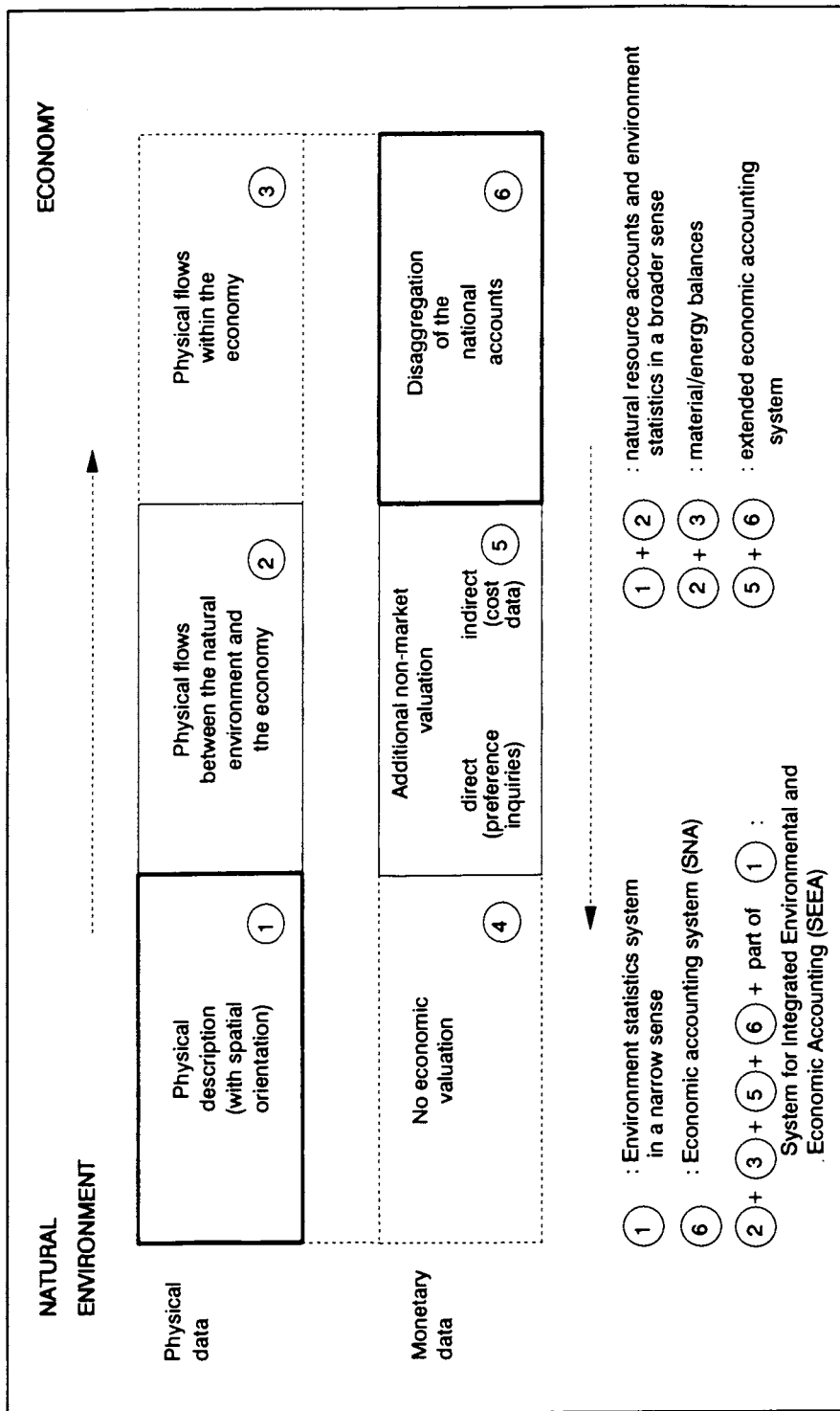

natural resources, their transformation by production and consumption activities and the flow of residuals back to the natural environment (in Table 1: (2) and (3) (cf. United Nations, 1976). Natural resource accounting and material/energy balances have statistical areas of overlapping, especially the flows between the economy and the environment (in Table 1: (2)).

- The description of economic activities in **monetary** terms could be **extended** to a valuation of the economic use of the natural environment. Comprehensive measurement of costs and benefits of economic activities and their environmental impacts could be the result of such calculations (in Table 1: (5) + (6), cf. e.g. Bartelmus, Stahmer, van Tongeren, 1991).

These statistical systems do not seem to be sufficient for a complete monitoring framework of the environmental-economic linkages. On the one hand, the suitable statistical unit for giving a detailed picture of the natural environment is the physical unit and, from an ecological point of view, the restriction to monetary valuation indicates a complete dominance of the natural environment by the economy. On the other hand, the interrelationship between the environment and the economy could not be sufficiently described for economists if it could not be translated into money values, the common economic language. This approach not only facilitates the access of economists to environmental problems but also creates a common scale which allows the compilation of results on a highly condensed level. Therefore, the System for Integrated Environmental and Economic Accounting comprises **both monetary and physical data**.

A complete system of Integrated Environmental and Economic Accounts would have to contain the traditional System of National Accounts (see United Nations, 1992a) as a data system for describing economic activities, a System of Environmental Accounts and all monetary and physical flows which could describe the interrelationship between the environment and the

economy (in Table 1: (1), (2), (3), (5) and (6)). This **ideal concept** cannot be implemented at the present time. The main reason is a missing comprehensive data system for describing the natural environment. Ambitious approaches have been employed in several countries, but no overall description of the natural environment has been implemented up to now. This lack of success cannot only be explained by inadequate financial support. It is true that more financial resources would probably have brought about more success in developing environmental statistics and comprehensive statistical systems in this field. However, the main reason for the absence of comprehensive environmental accounting seems to be the extraordinary difficulty encountered in describing the natural environment with its climatic, biological, physical and chemical changes during a reporting period in a model which describes this complex interrelationship adequately. At present it seems possible to describe sufficiently the state of the natural environment at a certain moment. This could be done by mapping or by tables monitoring the situation at a given time. But it has been - at least up to now - nearly impossible to portray the natural dynamics between two points of time. An example of such complex interrelations is the difficulty in developing weather models. It is relatively easy to draw weathermaps, but it is much more difficult to explain the reasons for the observed weather situation and to describe the changes. A complete integration of existing environmental and economic data systems therefore seems to be impossible at this moment.

It seems necessary to concentrate efforts in this field first of all on improving environmental statistics and to develop consistent systems for describing the natural environment as a second step. The **Framework for the Development of Environment Statistics (FDES)** of the United Nations and the work of the different regional organizations of the United Nations (e.g. the Economic Commission for Europe) in the field of environmental statistics seem to be a promising starting point (United Nations, 1984, 1988, 1991, and United Nations, Economic



Commission for Europe, 1988). The French work in the field of Natural Patrimony Accounting (see INSEE, 1986) could play a prominent role in further conceptual improvements in this field.

Difficulties in describing the natural environment in a comprehensive and sufficiently detailed manner should not prevent the attempts to describe the interrelationship between the natural environment and the economy as completely as possible. Concepts of **natural resource accounting** which focus on describing the natural environment from the point of view of economic use and the experience which has been gained in this field in several developing and developed countries could be used to establish a consistent data system. In this context, the conceptual considerations in the context of **material/energy balances** may also prove to be helpful.

The relatively comprehensive **System for Integrated Environmental and Economic Accounting (SEEA)** comprises four parts:

1. Parts of the established economic accounting system (System of National Accounts (SNA) of the United Nations, see United Nations, 1992a) which are of special relevance to environmental aspects and which will have to be partly disaggregated to identify monetary flows and assets which are related to the use of the natural environment (Table 1: parts of (6)).
2. Additional non-market valuation of the economic use of the environment in monetary terms (in Table 1: (5)).
3. Physical data on the flows from the natural environment to the economy, on their transformation within the economy and on the flows of the residuals of the economic activities back to the natural environment (in Table 1: (2) and (3)).

4. Description of the natural environment as far as it is necessary to analyze the impacts of economic use. This part would not lay claim to comprehensiveness. It would rather have a supplementary character (in Table 1: parts of (1)).

This concept does not pretend to provide an overall accounting system which comprises a complete description of the natural environment, the economy and its interrelations. It only focuses on describing the **interrelationship** between the **environment** and the **economy**. Economic activities as well as events within the natural environment are only taken into account as far as they are necessary to understand the relations between the economy and the environment. Furthermore, the relationships with socio-demographic data systems have not been elaborated.

The fact that an established system for environmental accounting is not available at the present time seems to justify that the planned SEEA takes as **starting point** only the well-established system for economic accounting, the SNA. The non-market valuation of the economic use of the natural environment is introduced in addition to the monetary data of the national accounts. The physical data of environment statistics, the natural resource accounts and of the material/energy balances are connected with the respective data in monetary terms in the national accounting system.

Employing the established economic accounting system does not necessarily lead to a dominance of economic aspects. On the contrary, it can reveal possibilities of stressing ecological aspects. Ecological aspects can be introduced in economic thinking and in economic decisions only if ecologists and economists are using the same language. If ecological aspects could be translated into money terms the possibilities of economic decisions taking environmental problems into account would be much greater. The aim of the SEEA should be to establish a suitable data basis for a policy of sustainable

development. This development can only be influenced by economic decisions. There is, therefore, higher priority to introduce ecological aspects into the sphere of economic activities than to monitor only economic impacts on the natural environment without economic valuation.

## 2. SEEA AS SATELLITE SYSTEM TO THE NATIONAL ACCOUNTS

During the last twenty years, proposals have been made to modify the national accounting system with regard to environmental aspects (cf. Baltensperger, 1972; Bartelmus, 1974, 1987 and 1989; de Boo, Bosch, Gorter, Keuning, 1991; Eisner, 1988; Fickl, 1991; Franz, 1988, 1989; Hamer, 1974; Harrison, 1989a, 1989b, 1992; Hueting, 1980; Levin, 1990; Marin, 1978; NNW Measurement Committee, 1973; Nordhaus, Tobin, 1973; OECD, 1971; Olson, 1977; Peskin, 1980, 1989; Richter, 1989; Uno, 1989, 1990; Reich, 1991; Reich, Stahmer, 1983; Thage, 1990, 1991). It has been argued that it is not sufficient to focus the accounting system on market transactions and to describe non-market activities only if they are connected with observable costs (e.g. in the case of government and non-profit institutions' activities). The results of this debate have shown that the majority of experts rejects substantial changes to the traditional national accounts but would prefer to establish a special system outside the traditional framework to describe environmental-economic relations (cf. the comprehensive analysis of Chr. Saunders in United Nations, 1977, and Adler, 1982; Carson, 1989; Denison, 1971; Drechsler, 1976; Herfindahl, Kneese, 1973; Stone, 1972; United Nations, 1974, prepared by R. Stone; United Nations, 1979, 1980; United Nations, ECE, 1973).

The traditional national accounts seem to be a sine qua non for analyzing problems of a market economy. There are many applications for which the restriction to market transactions is not a disadvantage but rather an advantage (see Reich, 1989, 1991). Short-term economic policy needs data on labor, commodity and financial markets. National accounting systems

are effective because the data fulfill two preconditions: They are suitable and they are observable. The degree of necessary estimations is low because most data of the national accounts can be directly observed from household and enterprise surveys.

The urgent need to describe the interrelationship between the environment and the economy should therefore not invalidate national accounting systems, but should lead to a special data system which, though being separate, should be closely linked to the traditional national accounts. This approach necessitates two systems, the traditional national accounts used as a core system and a special data framework which has the character of a satellite system (or satellite accounts) (Hamer, 1986; Lemaire, 1987; Reich, Stahmer, et al., 1988; Schäfer, Stahmer, 1990; Teillet, 1988; Vanoli, 1989; Weber, 1983, 1989). The preconditions for the success of such a construction are twofold:

- The concepts of a satellite system should have higher degrees of freedom than those of national accounts. They should be chosen in such a way that they can both give a comprehensive picture of the environmental-economic interrelationship and take into account the ecological point of view. It should also be possible to use valuation methods which might have a weaker data basis than the traditional national accounts. Furthermore, the possibility should be offered to test different methods and to describe different options. The complex problems of the use of the environment for economic activities can not be reduced to one specific approach. The most comprehensive measures of economic-environmental relations represent at the same time concepts which have the weakest data basis. The experimental character of possible environmental accounting systems should, therefore, be stressed. A satellite system should certainly present a consistent framework. But such framework should as far as possible take into account different schools of thinking.

- The aim of the accounting system can not be restricted to describing environmental deterioration caused by economic activities. The system should become a data basis for integrated environmental and economic policies. This aim can only be achieved if both the direct and indirect impacts of the economic use of the environment on economic activities can be analyzed. This implies close connections between the traditional economic accounting system and the new satellite system. The links between the two data systems could be used to establish comprehensive economic models which comprise not only economic but also environmental data.

At first sight the two preconditions for developing a suitable concept for the SEEA seem to be mutually exclusive. Close linkages to the national accounts seem to prevent an ecological orientation and an experimental design of the satellite system. It is obvious that this possible conflict can only be solved by developing a system with a high degree of flexibility (cf. the considerations of the "Dutch school": Bochove, Tuinen, 1986). The system should comprise modules or building blocks which are linked to the traditional accounting system in differing degrees (see e.g. Friend, 1991). As far as possible, the same concepts should be used for both the core system and the satellite system. In cases where different concepts are required, bridge tables are necessary which explicitly show the conceptual differences and which could be used as links between the new data sets and the traditional national accounts.

The SEEA (see United Nations, 1992b) comprises four types of building blocks which follow the concepts of the SNA (see United Nations, 1992a) to a differing extent (see Table 2):

- The first type of building blocks for constructing the SEEA is the production part of the SNA which contains a description of production and consumption activities (supply and disposition tables), and the accounts of non-financial assets (building blocks A of the SEEA). The production part of the SNA is sometimes called the input-output part because

**Table 2: SNA Satellite System for Integrated Environmental and Economic Accounting (SEEA)**

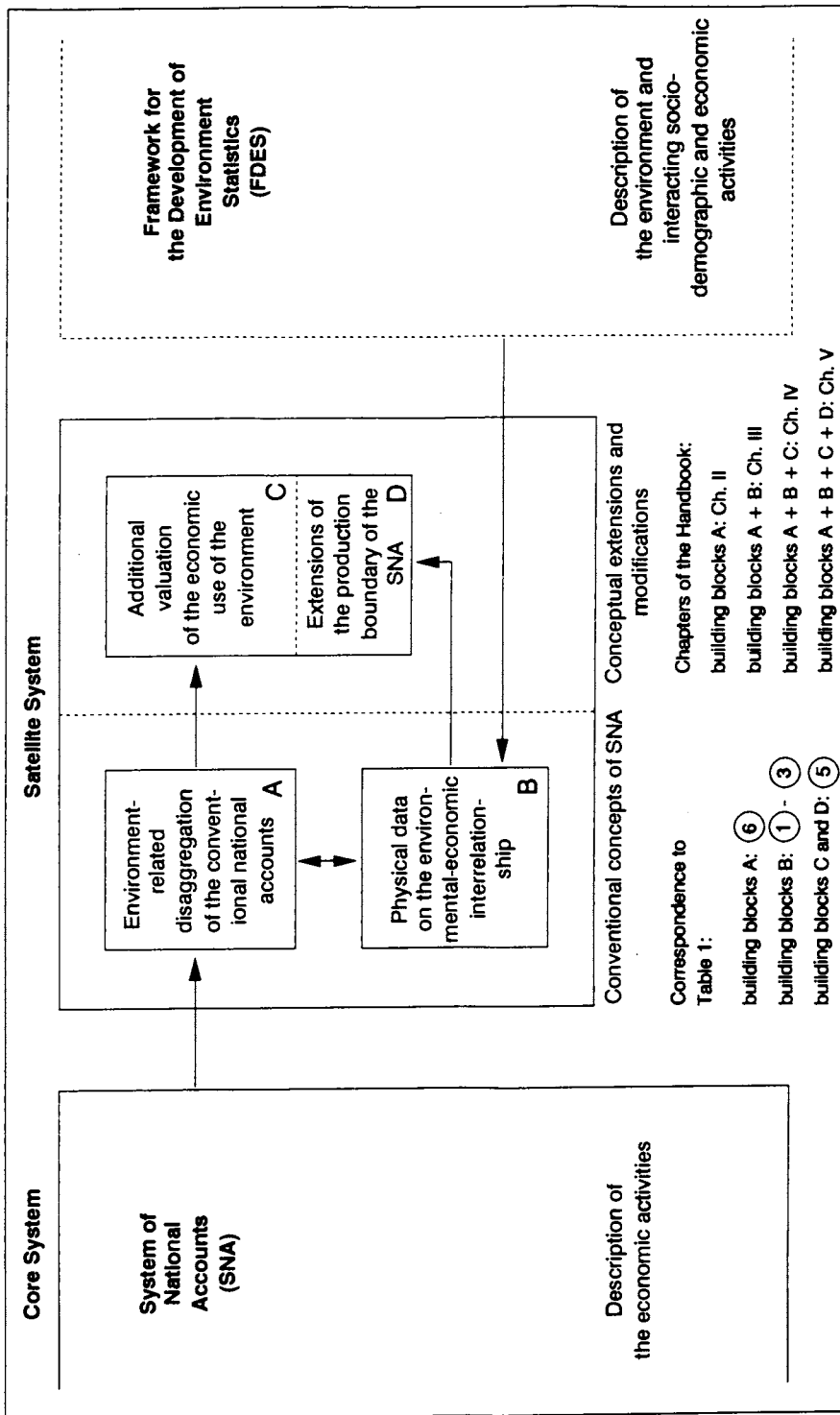

it comprises the data basis for input-output tables with uniform row and column classifications. The input-output framework seems to be the most suitable economic framework for analyzing environmental-economic relations because it could easily be extended by including flows of natural resources from the natural environment as inputs of economic activities and the flows of residuals of production and consumption activities as unwanted outputs delivered back into the natural environment. The starting point for the natural asset accounts of the SEEA are the non-financial asset accounts of the SNA which also comprise non-produced natural assets in the revised version (see United Nations, 1992a).

The SEEA contains the above mentioned parts of the SNA partly in an aggregated version, and partly in a more disaggregated form. Disaggregation seems to be particularly necessary to identify the environmental protection activities which should prevent an environmental deterioration or should restore an already deteriorated natural environment, and the repercussion (damage) costs (health expenditures, material corrosion costs) caused by a deteriorated environment. In the case of non-financial assets, further disaggregation of stocks and volume changes of natural assets is required.

- A second type of building blocks of the SEEA (in Table 2: building blocks B) comprises a description of the interrelationship between the natural environment and the economy in physical terms. This part of the SEEA which applies the conceptual considerations and empirical experiences of natural resource accounting, material/energy balances, and input-output compilation is closely linked to the monetary flows and assets of the SEEA derived from the production part of the SNA. These extensions could be made without modifying the concepts of the SNA.
- In a third part of the SEEA (in Table 2: building blocks C), different approaches are discussed for estimating the imputed

costs of the economic use of natural assets. In this context, three different valuation methods are used:

- ∅ market valuation according to the concepts of the non-financial asset accounts in the SNA,
  - ∅ maintenance valuation which tries to estimate the costs necessary to sustain at least the present quantitative and qualitative level of natural assets,
  - ∅ contingent valuation which could be applied especially for estimating the value of the "consumptive services" of the natural environment.
- A fourth type of building blocks of the SEEA (in Table 2: building blocks D) contains additional information which could be obtained by **extending the production boundary** of the SNA. These extensions have been applied especially in the case of household activities whose detailed analysis is necessary for understanding the impacts of household activities on the natural environment and the welfare aspects of the deteriorated nature. Furthermore, the consequences of treating economic functions of the natural environment as production of "environmental services" are discussed. A third method for extending the production boundary of the SNA refers to treating both internal and external environmental protection activities as production activities.

### 3. VERSIONS OF THE SEEA IN THE HANDBOOK

The different types of building blocks of the SEEA are not described as separate entities but as extensions of a **common accounting framework**. Each stage of extension comprises the data of the preceding stages as long as the valuation methods are not mutually exclusive. In Table 3, the dependencies between the different versions of the SEEA are shown.



**Table 3: Versions of the SEEA in the Handbook**

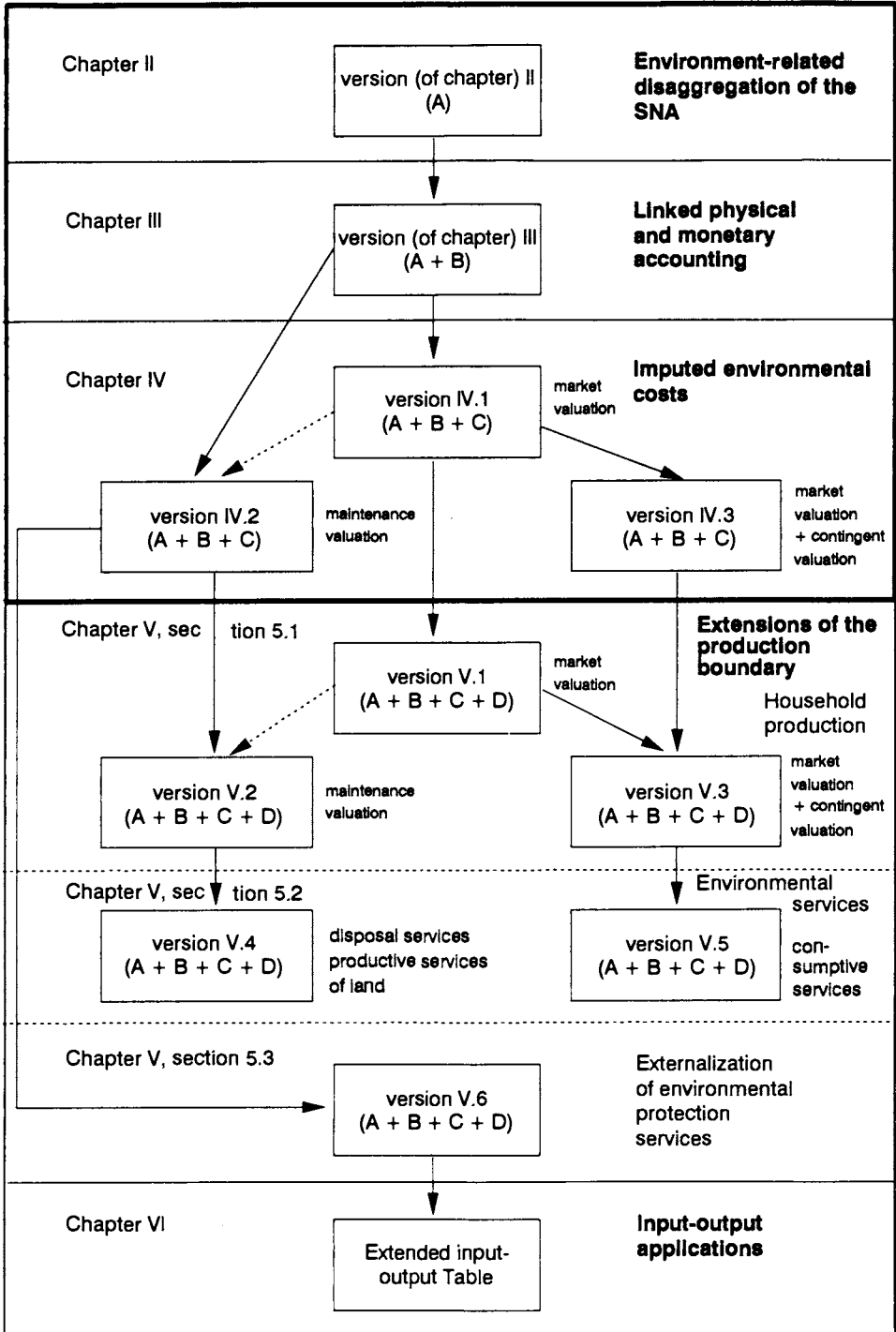

Furthermore, the chapters of the Handbook dealing with the specific SEEA versions are also indicated.

- In Chapter II, possible environment-related disaggregations of the SNA are described: version (of Chapter) II of the SEEA with building blocks A.
- In Chapter III, the monetary data of part A of the SEEA are linked with environment-related information in physical terms: version (of Chapter) III of the SEEA with building blocks A + B.
- In Chapter IV, imputed environmental costs (part C) are added: versions (of Chapter) IV of the SEEA with building blocks A + B + C. Three different types of valuation of imputed costs are discussed: market valuation (version IV.1), maintenance valuation (version IV.2) and contingent valuation in addition to market valuation (version IV.3).
- In Chapter V, extensions of the production boundary of the SNA are described in combination with differing types of valuation of imputed environmental costs: versions (of Chapter) V of the SEEA with building blocks A + B + C + D. The extended record of household production activities has been applied in combination with the three valuation methods of imputed environmental costs already applied in Chapter IV (versions V.1, V.2 and V.3). Environmental services have been treated as production in the case of disposal services (part of version V.4) which describe the use of the natural environment as sink of economic residuals, in the case of productive services of land, landscape and ecosystems (part of version V.4), and in the case of consumptive services for households (version V.5). Versions V.4 and V.5 take into account not only environmental production but also an extended concept of household production. Thus, they are derived from versions V.1, V.2 and V.3, and represent a further stage of extension. The "externalization" of internal environmental protection activities (version V.6) is

described on the basis of the concepts of version IV.2 (maintenance valuation).

- A product-based symmetric input-output table with environment-related extensions is derived from version V.6 and described in **Chapter VI**. This table is used as a conceptual basis for applications of the SEEA in input-output analysis.

#### 4. SEEA MATRIX

The SEEA is presented mainly in matrix form comprising a description of both flow and asset accounts. Table 4 shows the **SEEA matrix** in different stages of extension. For facilitating the description, the record of monetary data is described only. Flow data are recorded in rows 2 to 12; the asset accounts, in columns 5 to 7. Flow and asset accounts are linked to each other by the volume changes of assets described in rows 2 to 10 and columns 5 to 7. The classification items refer to the basic row and column classifications used throughout in the Handbook.

The structure of the columns has some similarities with the columns in input-output tables. The first three columns comprise different production activities; columns 4 to 8, final uses. Differing from input-output concepts, the record of gross capital formation (columns 5 to 7) has been supplemented by complete asset accounts including stock data.

The structure of the rows reflect a combination of items necessary for establishing asset accounts, and items used for recording flows. Rows 1 and 13 to 15 are relevant only in the context of asset accounts. The structure of rows 2 to 12 is again similar to that of input-output tables. It comprises the use of products and assets, net value added (net domestic product) and gross output.



The SEEA matrix is used for describing all versions of the SEEA in different **stages** of **extension**. Three stages are differently hatched in Table 4:

- Version II (see Chapter II of the Handbook) of the SEEA refers to data according to the **conventional concepts** of the SNA. These data are further disaggregated to reveal environment-related activities and the monetary flows and stocks connected. In version II, domestic production activities comprise only the production activities of industries (column 1), and, therefore, produced assets contain only assets of these industries (column 5). The use of products is limited to products of industries (row 2); and the use of assets to the use of produced fixed assets of industries (row 3). The asset accounts comprise opening stocks (row 1), net capital formation (rows 2 and 3), other volume changes (row 13), revaluation due to market price changes (row 14) and closing stocks (row 15) which are the column totals of the recorded asset accounts.
- The versions of Chapter IV of the Handbook which describe different approaches of valuing imputed environmental costs imply a recording of additional costs associated with different economic activities (production, final consumption, use of produced assets), and with reverse sign, costs associated with volume changes of natural assets deteriorated by economic activities (see row 7). Adjustment items are introduced (rows 9 and 10) which balance imputed environmental costs against the conventional figures of Net Domestic Product (column 1) and the corresponding volume changes of natural assets against other volume changes and the closing stocks of natural assets still valued according to the SNA concepts.
- A third stage of development of the SEEA implies extensions of the **production boundary** of the SNA (see Chapter V of the Handbook). The extended concept of household production activities is reflected in the SEEA matrix as an additional

record of production activities (see "other household activities" in column 2) and products (row 4). The corresponding extension of the concept of produced assets entails the introduction of asset accounts of consumer durables and the record of corresponding user costs (row 5). If environmental services are treated as production activities, a further extension of the concept of domestic production is necessary (see column 3 and row 6). The conceptual implications of externalizing internal environmental protection services are not explicitly shown in Table 4 for sake of simplicity. If externalized such approach would imply modifications of the concepts of industries.

Hatched elements of the SEEA indicate that they could, at least theoretically, contain figures in monetary terms. In Chapters II, IV and V of the Handbook, the different versions of the SEEA matrix are shown in detail.

#### 5. IMPLEMENTATION OF THE SEEA

In order to adapt the SEEA to different environmental and socio-economic conditions in countries, the SEEA has been designed to be as comprehensive, flexible and consistent as possible.

The aim of **comprehensiveness** refers not only to a variety of different patterns of economic development or categories of environmental deterioration, but also to alternative theoretical approaches which can be applied for analysing the economic and environmental situation. Physical accounting is used as well as differing types of monetary valuation.

Comprehensiveness in the SEEA does not imply the use of the whole range of possibilities to describe environmental-economic interrelations. The specific environmental and economic problems of a particular country have to determine the choice of the main fields which should be taken into account.

Furthermore, data availability and possibilities of further improvement of the data base restrict the application of SEEA concepts. These constraints necessitate a **flexible** system which should comprise a variety of building blocks which could be used independent of each other (see the proposals of van Bochove, van Tuinen, 1986).

This necessary flexibility of the SEEA should not affect the **consistency** of the system. A consistent data system is guaranteed if the versions of the SEEA remain an extension of the national (economic) accounts and apply the accounting rules of extended accounts. These rules imply for instance that supply and destination of products, natural resources and residuals should be balanced in the flow accounts and that complete asset balances should be established. Therefore, the concept of flexibility permits the selection of high priority flow and asset accounts but should not encourage the development of incomplete accounts.

The implementation of the SEEA should focus on high-priority concerns and related economic activities. Implementation will, however, be limited by **data availability**. Therefore, it seems useful to start with implementing that part of the SEEA which has both high priority and a sufficient data basis. The data basis should be improved in parallel to the implementation of initial building blocks of the SEEA with a view to achieving a more complete version of the SEEA in the future.

In Table 5 an overview is given of possible statistical building blocks of the SEEA. Of course, each building block comprises a variety of specific items that could be compiled separately (e.g. accounts for different types of products, raw materials or residuals).

The building blocks are grouped according to the three mentioned types of data in the SEEA:

**Table 5: Building blocks for implementing the SEEA**

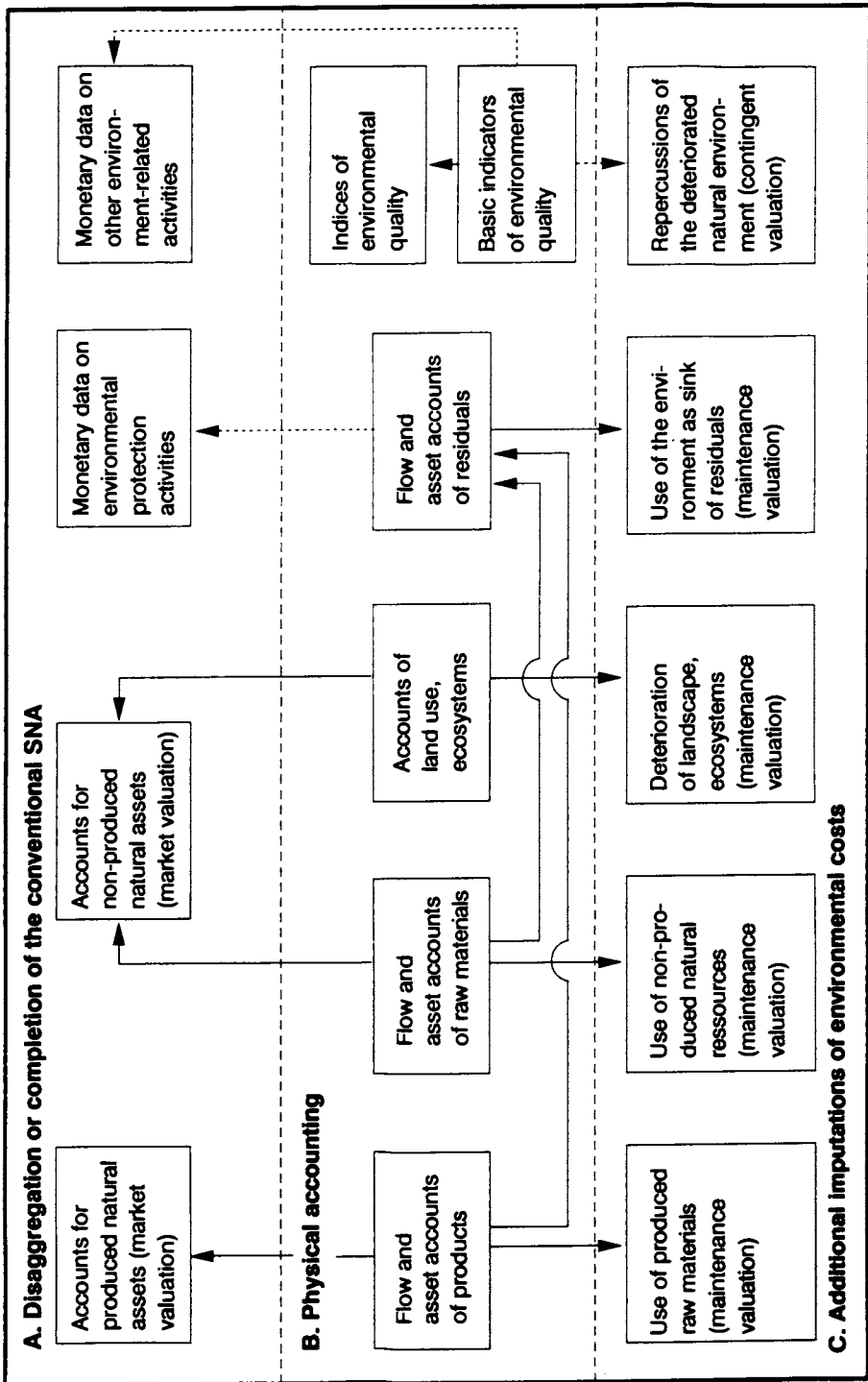



- (a) Disaggregation or completion of the conventional **SNA** with regard to environmental issues (building blocks A of version II of the SEEA): This part of the SEEA comprises, in particular, building blocks describing the accounts of natural assets (market valuation), and actual (observable) monetary data connected with environment-related defensive activities (e.g. environmental protection activities or defensive activities against the repercussions of a deteriorated natural environment);
- (b) **Physical accounting** (building blocks B of version III of the SEEA): This part of the SEEA comprises accounts for products, raw materials and residuals, as well as land use accounts, environmental quality indicators and other (more aggregated) indices.
- (c) **Imputed environmental costs** with regard to the impacts of economic activities on the natural environment (building blocks C of versions IV of the SEEA): This part of the SEEA comprises estimates of the prevention costs necessary to maintain the qualitative and quantitative level of the natural assets (Bartelmus, Stahmer and van Tongeren, 1991) and the imputed costs of the repercussions of the deteriorated natural environment (using contingent valuation methods, see OECD, 1989; Pearce, Markandya and Barbier, 1989; and Stahmer, 1991).

The arrows in Table 5 show **dependencies** in compiling different building blocks: The empirical implementation of some building blocks require the implementation of other parts of the system. This is especially true of the monetary data (building blocks A and C in Table 5) which - in many cases - can be compiled only on the basis of sufficient physical data (building blocks B). The compilation dependencies between the different building blocks in monetary terms are not so strong. These data can mainly be compiled independently. Nevertheless, imputed environmental costs (building blocks C) can be usefully analyzed only in comparison with actual (observable) data

(building blocks A). These compilation dependencies among the different parts of the SEEA support the view that first priority should be given to physical accounting. Monetary data could then be estimated in a second step. This procedure does not exclude the immediate implementation of monetary building blocks which are more or less independent of physical data. This is especially true of the estimation of expenditures connected with environmental protection activities and the, more controversial, application of contingent valuation.

Flexibility of the SEEA would permit an implementation of the SEEA limited to building blocks A and B (version III of the SEEA). This limitation implies that the concepts of the traditional national accounts would remain completely unchanged because building blocks A and B only record a disaggregation and completion of conventional data or, in the case of physical accounting, additional environment statistics which provide further information without affecting traditional concepts. On the other hand, a limited presentation of details of the environmental-economic interrelationships in physical terms is questionable. If the results of the SEEA are to support an integrated environmental and economic policy, a sort of **weighting procedure** for condensing the details is needed because political decisions are often based on a few highly aggregated figures. The estimation of imputed environmental costs allows such aggregation. Of course, aggregated physical indicators, for instance on changes in quality of specific environmental media, have to supplement this monetary information.

REFERENCES

- Adler, H. (1982): Selected problems of Welfare and Production in the National Accounts. Review of Income and Wealth, Vol. 28, pp. 121 - 132.
- Ahmad, Y.J., El Serafy, S., Lutz, E. (1989): Environmental Accounting for Sustainable Development. A UNEP - World Bank Symposium. Washington, D.C..
- Baltensperger, M. (1972): Die Volkswirtschaftliche Quantifizierung des Umweltverzehrs (Macroeconomic Measurement of Environmental Deterioration). In: Schweizerische Zeitschrift für Volkswirtschaft und Statistik, pp. 405 - 423.
- Bartelmus, P. (1974): Probleme der Entwicklung eines Umweltstatistischen Systems (Problems of Developing a System of Environmental Statistics). Statistische Hefte, Vol. 14 (2), pp. 123 - 147.
- Bartelmus, P. (1987): Beyond GDP - New Approaches to Applied Statistics. Review of Income and Wealth, Vol. 33 (4), December, pp. 347 - 358.
- Bartelmus, P. (1989): Environmental Accounting and the System of National Accounts. In: Ahmad, El Serafy, Lutz (1989), pp. 79 - 86.
- Bartelmus, P., Stahmer, C., van Tongeren, J. (1991): Integrated Environmental and Economic Accounting: Framework for a SNA Satellite System. In: Review of Income and Wealth, Ser. 37, No. 2. June, pp. 111 - 148.
- van Bochove, C.A., van Tuinen, H.K. (1986): Revision of the System of National Accounts: The Case of Flexibility. Review of Income and Wealth, Series 32, No. 2.
- de Boo, A.J., Bosch, P., Gorter, C.N., Keuning, S.J. (1991): An Environmental Module and the Complete System of National Accounts. In this volume.
- Carson, C.S. (1989): The United Nations System of National Accounts: A Revision for the 21st Century. Paper presented to the American Economic Association, Atlanta, Georgia. December 29.
- Denison, E.F. (1971): Welfare Measurement and the GNP. Survey of Current Business. January.
- Drechsler, L. (1976): Problems of Recording Environmental Phenomena in National Accounting Aggregates. In: Review of Income and Wealth, September, pp. 239 - 252.

- Eisner, R. (1988): Extended Accounts for National Income and Product. *Journal of Economic Literature*, Vol. 26 (December), pp. 1611 - 1684.
- Fickl, S. (1991): Environment in a National Accounts Framework: The Austrian Approach to Environmental Accounting. In this volume.
- Franz, A. (1988): Grundzüge einer ökologischen Gesamtrechnung für Österreich (Basic Principles of an Ecological Accounting System for Austria). Österreichisches Statistisches Zentralamt (editor), Österreichs Volkseinkommen 1987, Wien.
- Franz, A. (1989): Ein Bearbeitungsraster für die ökologische Gesamtrechnung in der VGR (Work Program for an Ecological Accounting System within the National Accounts). Österreichisches Statistisches Zentralamt (editor), Österreichs Volkseinkommen 1988, Wien.
- Friend, A.M. (1991): Towards a Pluralistic Approach in National Accounting Systems. In this volume.
- Hamer, G. (1974): Volkswirtschaftliche Gesamtrechnungen und Messung der Lebensqualität (National Accounts and Quality of Life Measurement). In: *Wirtschaft und Statistik*, August.
- Hamer, G. (1986): Satellitensysteme im Rahmen der Weiterentwicklung der Volkswirtschaftlichen Gesamtrechnungen (Satellite Systems for Further Development of National Accounts). In: Hanau, K., Heyer, R., Neubauer, W. (eds)., *Wirtschafts- und Sozialstatistik*. Göttingen.
- Hamer, G./Stahmer, C. (1992): Integrierte Volkswirtschaftliche und Umweltgesamtrechnung (Integrated Environmental and Economic Accounting). In: *Zeitschrift für Umweltpolitik und Umweltrecht*, No. 1, pp. 85 - 117, and No. 2, pp. 237 - 256.
- Harrison, A. (1989a): Introducing Natural Capital into the SNA. In: Ahmad, El Serafy, Lutz (1989), pp. 19 - 25.
- Harrison, A. (1989b): Environmental Issues and the SNA. Review of Income and Wealth, Series 35, Number 4, December, pp. 377 - 388.
- Harrison, A. (1992): Natural Assets and National Income. World Bank, Environment Department, Divisional Working Paper. Washington.
- Herfindahl, O.C., Kneese, A.V. (1973): Measuring Social and Economic Change: Benefits and Costs of Environmental Pollution. In: Moss (1973), pp. 441 - 502.
- Hueting, R. (1980): *New Scarcity and Economic Growth. More Welfare Through Less Production?* Amsterdam, New York, Oxford.

- Institut National de la Statistique et des Etudes Economiques (INSEE) et Ministere de l'Environnement (1986): Les Comptes du Patrimoine Naturel - La Documentation Francaise. Paris.
- Lemaire, M. (1987): Satellite Accounts: A Solution for Analysis in Social Fields. In: Review of Income and Wealth, Series 33 (3), pp. 305 - 325.
- Levin, J. (1990): The Economy and the Environment: Revising the National Accounts. IMF Survey, June 4.
- Marin, A. (1978): National Income, Welfare and the Environment. In: Review of Income and Wealth, April, pp. 415 - 428.
- NNW Measurement Committee (1973): Measuring Net National Welfare of Japan. Tokyo.
- Nordhaus, W.D., Tobin, J. (1973): Is Growth Obsolete? In: Moss (1973), pp. 509 - 531.
- OECD (1971): Environment and Growth in National Accounts. Working Document. DES/NI (70). 3 (Rev.). Paris. 22 April.
- OECD (1989): Environmental Policy Benefits: Monetary Valuation. Study prepared by D.W. Pearce and A. Markandya. Paris.
- Olson, M. (1977): The Treatment of Externalities in National Income Statistics. In: Wingo, L., Evans, A. (eds.), Public Economics and the Quality of Life. Baltimore, Md.
- Pearce, D., Markandya, A., Barbier, E. (1989): Blueprint for a Green Economy. London.
- Peskin, H. (1980): Two Papers on National Accounting and the Environment (GNP and the Environment, National Accounts and the Environment). Resources for the Future. October.
- Peskin, H. (1989): National Accounts and the Environment. Draft. Edgevale Associates, Silver Spring (USA).
- Reich, U.P. (1989): Essence and Appearance: Reflections on InputOutput Methodology in Terms of Classical Paradigm. In: Economic Systems Research, Vol. 1, No. 2.
- Reich, U.P. (1991): Applying the Notions of Capital and Income to Natural Depletable Resources in Economic Accounts. In this volume.
- Reich, U.P., Stahmer, C. (eds.) (1983): Gesamtwirtschaftliche Wohlfahrtsmessung und Umweltqualität (Macroeconomic Welfare Measurement and Environmental Quality). Campus Forschung, Vol. 333. Frankfurt, New York.
- Reich, U.P., Stahmer, C. et al. (1988): Satellitensysteme zu den Volkswirtschaftlichen Gesamtrechnungen (Satellite Systems to National Accounts). Stuttgart, Mainz.

- Richter, J. (1989): Umwelt in den Volkswirtschaftlichen Gesamtrechnungen (Natural Environment in the National Accounts). In: Wirtschaftspolitische Blätter, No. 4.
- Schäfer, D., Stahmer, C. (1990): Conceptual Considerations on Satellite Systems. In: Review of Income and Wealth, Ser. 36, No. 2, June, pp. 167 - 176.
- Stahmer, C. (1991): Cost- and Welfare-oriented Measurement in Environmental Accounting. In: P.O. Aven, Chr. M. Schneider (eds.), Economies in Transition: Statistical Measures Now and in the Future. IIASA, Luxemburg (Austria), August, pp. 51 - 67.
- Stone, R. (1972): The Evaluation of Pollution: Balancing Gains and Losses. In: Minerva, Vol. 10 (3), pp. 412 - 425.
- Teillet, P. (1988): A Concept of Satellite Accounts in the Revised System of National Accounts. In: Reich, Stahmer (1988), pp. 29 - 59.
- Thage, B. (1990): Statistical Analysis of Economic Activity and the Environment. Report to the Government Committee on the Environment and Development. Danmarks Statistik. Copenhagen, October.
- Thage, B. (1991): The National Accounts and the Environment. In this volume.
- United Nations (1968): A System of National Accounts. Studies in Methods, Series F, No. 2. Rev. 3. New York.
- United Nations (1974): System of National Accounts (SNA). Supplementing the National Accounts for Purposes of Welfare Measurement. Paper prepared by R. Stone, E/CN.3/459/Add. 1. 9 August.
- United Nations (1976): Draft Guidelines for Statistics on Materials/Energy Balances. E/CN.3/492. 29 March.
- United Nations (1977): The Feasibility of Welfare-Oriented Measures to Supplement the National Accounts and Balances: A Technical Report (prepared by Christopher T. Saunders). Studies in Methods, Series F, No. 22. New York.
- United Nations (1979): Future Directions for Work on the United Nations Systems of National Accounts. Working Party on National Accounts and Balances (25 - 28 February, Geneva. CES/WP.22/58.6 December.
- United Nations (1980): Future Directions for Work on the United Nations System of National Accounts. Annex A: GDP as a Measure of Output: Problems and Possible Solutions (Annex prepared by D. Blades). Expert Group Meeting on the System of National Accounts. E/CN. 3/AC. 9/1/Rev. 1. 27 March.

- United Nations (1984): A Framework for the Development of Environment Statistics. Statistical Papers, Series M, No. 78. New York.
- United Nations (1988): Concepts and Methods of Environment Statistics: Human Settlement Statistics - a Technical Report. E. 88.XVII.14. New York.
- United Nations (1991): Concepts and Methods of Environmental Statistics: Statistics of the Natural Environment - A Technical Report, Draft ST/ESA/STAT/SER.F, New York.
- United Nations (1992a): Revised System of National Accounts. Provisional. Future ST/ESA/STAT/SER.F/2/Rev.4.
- United Nations (1992b): Integrated Environmental and Economic Accounting, Handbook of National Accounting, Interim version (Draft), New York, May.
- United Nations, Economic Commission for Europe (1973): The Treatment of Environmental Problems in the National Accounts and Balances. CES/AC. 40/4. Geneva.
- United Nations, Economic Commission for Europe (1988): Environment Statistics in the Work Programme of the Conference of European Statisticians. In: Statistical Journal of the United Nations ECE, Vol. 5 (1988), pp. 113 - 121.
- United Nations, Economic Commission for Europe (1991): Approaches to Environmental Accounting. Conference of European Statisticians, Geneva, June. CES/700.
- Uno, K. (1989): Economic Growth and Environmental Change in Japan - Net National Welfare and Beyond. In: F. Archibugi, P. Nijkamp (eds.): Economy and Ecology. Towards Sustainable Development, Dordrecht 1989, pp. 307 - 332.
- Uno, K. (1990): National Accounting and the Environment. Paper prepared for the UNU/WIDER Project on the Environment and the Emerging Development Issues, Helsinki, September 3-7.
- Vanoli, A. (1989): Satellite Accounts. SNA Expert Group. Coordinating Meeting. New York. September.
- Weber, J.-L. (1983): The French Natural Patrimony Accounts. Statistical Journal of the United Nations ECE, Vol. 1, pp. 419 - 444.
- Weber, J.-L. (1989): Comptabilité Nationale: Prendre la Nature en Compte(s). Paris. November.
- World Commission on Environment and Development (1987): Our Common Future. Oxford, N.Y.

## Mailing Addresses of Authors<sup>1</sup>

**A. Aaheim**

Central Bureau of Statistics  
P.O. Box 8131 Dep.  
N-0033 Oslo 1  
Norway

**R.U. Ayres**

INSEAD  
Boulevard de Constance  
F-77305 Fontainebleau/Cedex  
France

**P. Bartelmus**

United Nations Statistical Office  
Room DC2-1652  
New York, NY 10017  
USA

**J. Blazejczak**

German Institute for Economic Research  
DIW  
Königin-Luise-Str. 5  
1000 Berlin 33  
Germany

**B.J. de Boo**

Central Bureau of Statistics  
P.O. Box 959  
2270 AZ Voorburg  
The Netherlands

**M. Carlucci**

Dipartimento di Contabilita Nazionale  
Facolta di Scienze Statistiche D.A.  
Universita di Roma "La Sapienza"  
P. le A. Moro 5  
00185 Roma  
Italy

**R. Dell'mour**

Oesterreichische Nationalbank  
Otto Wagner-Platz 3-5  
A-1090 Vienna  
Austria

**D. Edler**

German Institute for Economic Research  
DIW  
Königin-Luise-Str. 5  
1000 Berlin 33  
Germany

**S. Fickl**

Energieverwertungsagentur (E.V.A.)  
Linke Wienzeile 18  
A-1060 Vienna  
Austria

**M. Fischer-Kowalski**

Institut für Interdisziplinäre Forschung  
und Fortbildung  
Seidengasse 13  
A-1070 Vienna  
Austria

**P. Fleissner**

Institut für Gestaltungs- und Wirkungsforschung  
Abteilung für Sozialkybernetik  
Technical University Vienna  
Möllwaldplatz 5  
A-1040 Vienna  
Austria

**A. Franz**

Austrian Central Statistical Office  
Hintere Zollamtsstrasse 2b  
A-1030 Vienna  
Austria

**A.M. Friend**

Institute for Research on  
Environment and Economy (IREE)  
University of Ottawa  
5 Calixa Lavalee  
Ottawa, Ontario K1N 6N5  
Canada

**A. Giannone**

Istituto di Statistica Economica  
Facolta di Scienze Statistiche D.A.  
Universita di Roma "La Sapienza"  
Piazzale A. Moro 5  
00185 Roma  
Italy

**J.M. Hartwick**

Economics  
Queen's University  
Kingston Ontario K1L 3N6  
Canada

**R. Hueting**

Central Bureau of Statistics  
P.O. Box 959  
2270 AZ Voorburg  
Netherlands

---

<sup>1</sup> In the case of more than two authors, usually only the first one is quoted.



**S. Keuning**

N.A. Department  
Central Bureau of Statistics  
P.O. Box 959  
2370 AZ Voorburg  
Netherlands

**L. Koltola**

Central Statistical Office of Finland  
P.O. Box 504  
00101 Helsinki  
Finland

**J. Levin**

Fiscal Affairs Department  
International Monetary Fund  
Washington, D.C. 20431  
USA

**Jinchang Li**

Environmental Strategy Research Centre  
of China  
NEPA  
115 Xizhimennei Nanxiaojie  
Beijing, 10035  
China

**G. Michaels**

Abt Associates Inc.  
4800 Montgomery Lane,  
Hampden Square, Suite 500  
Bethesda, MD 20814  
USA

**K. Nyborg**

Central Bureau of Statistics  
P.O. Box 8131 Dep.  
N-0033 Oslo 1  
Norway

**H.M. Peskin**

Edgevale Associates Inc.  
1210 Edgevale Road  
Silver Spring, MD 20910  
USA

**G. Pillet**

ECOSYS Ltd.  
27, rue de la Filature  
CH 1227 Carouge/Geneve  
Switzerland

**N. Rainer**

Austrian Central Statistical Office  
Hintere Zollamtsstrasse 2b  
A-1030 Vienna  
Austria

**U.P. Reich**

Am Müllerwäldchen 9  
D-65 Mainz-Gosenheim  
Germany

**J. Richter**

Federal Economic Chamber  
P.O. Box 180  
A-1045 Vienna  
Austria

**T. Rymes**

Dep. of Economics  
Carleton University  
Ottawa, Ontario  
Canada K 15 5B6

**S. El Serafy**

The World Bank  
1818 H Street N.W.  
Room E 3073  
Washington D.C. 20433  
USA

**C. Stahmer**

Statistisches Bundesamt  
Gustav Stresemann-Ring 11  
Postfach 5528  
D-6200 Wiesbaden  
Germany

**A. Steurer**

Austrian Central Statistical Office  
Hintere Zollamtsstrasse 2b  
A-1030 Vienna  
Austria

**B. Thage**

Danmarks Statistik  
Sejrogade 11  
2100 Copenhagen  
Denmark

**J. van Tongeren**

United Nations Statistical Office  
Room DC2-1720  
New York, N.Y. 10017  
USA

**M.D. Young**

CSIRO Division of Wildlife and Ecology  
P.O. Box 84  
Lyneham ACT  
Canberra 2602  
Australia