

**TRAVEL-TRAILER
HOMESTEADING**

UNDER \$5,000

BY

BRIAN D. KELLING

EDEN PRESS

Table of Contents

Preface.....	6
How This Came to Be.....	9
The Land.....	11
Shelter.....	17
The Septic System.....	22
Water.....	31
Power.....	37
Heat.....	44
Refrigeration.....	51
Mobile Homesteading.....	54
The Hot Tub.....	64
Friends and Neighbors.....	65
What It's Like to Live This Way.....	66
Closing Statement.....	69
Illustrations.....	70
Excerpts from other books	
By Brian D. Kelling.....	78

PREFACE

The object of this book is to show you how to purchase and set up a complete travel-trailer homestead for a total cost of under \$5,000, land and trailer included.

You'll have all the comforts of home: electrical power, heat, pressurized water, refrigeration, and a septic system.

Sound too good to be true? It's not—I did it, and I'll show you how.

I started with a 21 foot travel-trailer on 5 acres in southern Colorado. Everything was paid for, and I had all I needed in creature comforts.

Since this book was first published, I purchased and set up a mobile home, adapting all the same ideas, techniques, and technology from setting up the travel-trailer. Subsequent editions contain a chapter devoted specifically to this.

There are a few prerequisites to getting started on a life like this: the money, a pickup truck, some tools, and the willingness.

But before you sell everything and start off, I'd suggest you read this entire book thoroughly. Then take some time to think, for there are some things you ought to consider.

Would this life really be suitable for you? Is living like this something you can realistically do?

Letters

I have gotten quite a bit of mail since the first edition of this book came out.

I'm glad to be able to report that of the mail I've received from the first two editions of this book, all of it was positive. In fact, most of it contained a hearty "Thank you!" I can tell you that as a writer, which is a pretty thankless job most of the time, that sort of thing is always nice to receive. Yet there's more, because such letters make me glad that my work was able to help someone. And maybe that's why the book has enjoyed the success that it has.

One gal said I had "...put into words what she'd been dreaming about doing for years." I think that's a very important point. Because it proves what so many of us really want inside: peace, serenity, and not to have to rely so much on others.

Quite a few of the letters were along the lines of, "Do you know how I could buy property in Vancouver? (Arizona, Idaho, Missouri, etc.)" My answer is usually the same: you should go there first, look around, and buy what you feel comfortable with. And I'll go into that more in the section on land.

A couple of the people who'd written had already gotten travel-trailers and were packing up to leave. They just wrote to say how happy they were, and I'm glad for them.

Something that was sort of surprising to me was when one woman wrote to say that she wanted to meet me, though I believe her letter had more to do with getting someone to do the actual homesteading work than with myself.

And, as I suspected would happen, a number of people wrote to let me know that they are already living as I do, which of course was no great surprise to me. One of these is now a very good

friend of mine. Right here I might say that I did not invent this lifestyle. I merely found what worked for me, and some others, and wrote a book about it.

But by and large, I'm sad to say, the majority of letters have come from wanna-be's, people who only dream about getting out of the rat race. I feel for them, having been in the same boat myself at one time.

Well, it's good for people to dream, but a close friend of mine once told me, "Dreams without planning and action to make them come true are nothing short of fantasy."

He was so right.

At any rate, thank you all. Good luck to you, and Mucho Gusto!

Cost Breakdown

The following figures are based on my situation:

Land	\$2,195
Trailer	1,200
Skirting	75
Generator	200
Heat	105
Wood stove	80
Flue/misc..	25
Propane tank	241
Solar power	692
Panels	215
Batteries	260
Platform	70
Inverter	80
Regulator	67
Septic	70
Cistern	49
Pump	19
Barrels	15
Pipe	15
Air pump	5
TV antenna	23
Mailbox	7
 TOTAL :	 \$4,862

Tools You'll Need

Tools are an important part of setting up the homestead, and take my word for it—you can do practically nothing without them.

You should gather as many appropriate tools as you can; sooner or later, you will use them all. Most of this stuff you can get really cheap at garage sales. So go yard sailing, garage sailing, any kind of sailing, because such sales can be veritable gold mines of things you need. If you can, I would buy the chain saw brand new. But that's not to say that you couldn't get a used one, either. Just make sure it is reliable and works well.

The following is a basic, must-have tool list:

- Chain saw
- Circular saw
- Jigsaw
- Hand saws
- Hacksaw
- Drill and bits
- Phillips bits for drill
- Screwdrivers
- Tape measure
- Level
- Power cords
- Caulking gun
- Wood rasp
- Tin snips
- Shovels
- An axe and hatchet
- Small bottle jack
- The usual assortment of automotive tools.

And any other basic tools you can lay your hands on. I mean it! Carpentry, plumbing, mechanical or electrical.

You will also have use for a garden hose and a few 5 gallon plastic buckets.

Chapter One

How This Came To Be

In 1993, I was a construction superintendent, working out of a construction office-trailer, pulling my hair out and popping Tagamet. It was an insanely hectic \$70 million project, and I pushed the work of one of 35 contractors (and that's just the ones who had office trailers on the job. There were a total of 80 contractors altogether.)

When the phone, fax, pager, or one or both of the two radios on my belt weren't going off—and if no one came by for answers—I'd just sit there and stare at a particular photograph I had hanging on my wall. Indeed, I could have looked at that picture for hours: wishing, hoping, and dreaming for a way of life I wanted, but did not have. Yet because of the nature of the job, these brief respites were never more than moments long.

Oh yeah, the money was good, you know it. And there were times when I really enjoyed making the big machine run. I owned a nice home in the suburbs (me and the bank, that is,) drove new vehicles, bought what I felt like, and paid a lot of bills. But there was no time.

Evenings—when I went home late for dinner—were good because they gave me a chance to catch up on the never-ending supply of paperwork such a job produces, and which it also demands. You see, I had an office at home, too, where in my spare time I detailed a hardware schedule for 900 doors on the very word processor that I wrote the first edition of this book on. What I *really* wanted was to be writing books instead, but somehow that just never got done—there being no time.

"Free time" was a thing of the past, or so it seemed. And I resented not having enough time to pursue my dreams.

Through quick glances on weekdays and Saturday mornings, there was that picture again, always the same and never changing. Sometimes, I even thought about it in church. The scene was literally a thousand miles away, yet it was always with me, occupying a special place in my free moments of thinking. Now here, I can imagine my Father saying, "Can you believe that? Didn't even have time to think!"

But when I did have time to think, I'd dream about that place in the picture. It really was "gentle on my mind," to quote Glen Campbell's famous song.

But it was just a picture, you say.

Yes, it was just a picture. A picture of horses grazing on open country. There were no houses visible in the picture, nor any fences, stoplights, or shopping malls. No "expressways", police stations, hospitals, or convenience stores. Just the horses in wide-open country. But behind those horses stood the fourth tallest mountain in the entire state of Colorado.

Four basic colors made up that picture. In the foreground, the brown of the mid-winter valley floor, dotted with horses. Beyond that, where the land goes up, the thick green of probably a million tall trees. Above timberline, the pure white of deep, cold snow. The bluest of big Western skies capped-off the whole thing.

To me, it was a picture of incredible grandeur. And right there, where those horses grazed, that was *my property*, although I never got to think about it much. No, there were always meetings to attend, contracts to write, submittals to review, problems to solve, and people to pressure. In short, there was work to be done, but somehow I swore I'd get out of this rat-race.

One day, when things finally got to be too much, I asked for my vacation. They said, "Vacation! You can't take a vacation, there's too much going on!" I told them the truth, I was so wound up that I couldn't even take a dump, and I was going whether they liked it or not. Cripe, the electrician's manager had a heart attack, at age fifty-three! They raised Hell with me, but I again told them the truth—I'd quit if I didn't get it, and I meant it.

After a day's rest I was on a plane to Denver, where I rented a car and drove the four hours to my property. Indeed, there was something I had to do.

By evening I stood on my land and watched the setting sun light a hundred miles of the Rocky Mountains. So magnificent was the scene that I was stunned. So quiet that I nearly cried. Not a single sound intruded on that almost spiritual experience.

For nearly a week I stayed at a motel, reading the paper, driving around and checking out the town. I'd talk with people, get the feel of the place, and find out the costs of things. But every day I'd return to my land and walk the property lines, thinking. There was a question that needed answering, and I wouldn't leave until I got it. Squatting down, I'd crumble the dirt between my fingers, as if I'd find the answer there.

But it wasn't there, and it wasn't in the town. The answer was in me. And the question was, could I really do it? Could I really leave a solid career, sell my home, and just take off for the country? Could I start all over again?

Inside, it felt irresponsible somehow—even crazy—and I was sure people would say that about me. (More than a few of them did, too.) After all, I was finally getting somewhere, making more money than I'd ever made before. My pension was vested and grew by the day. How could I throw away what I'd worked so hard to get? And that, for a *dream*.

Just a few more years, I'd tell myself, and then I'd be set. Uh-huh. Just a few more years....

Then one day at the land, I saw the horses again. They trotted up to see who the newcomer was. While they sniffed and milled around, I patted the Paint's neck like an old friend.

When they left, I just stood and watched them go, wandering at will for miles, no halters on, and freer than I'd ever been in my life. No bars held them in; there was no place they had to be. It surely was a sight... and I had my answer.

Back home, everything was easier now—even in that pressure cooker of a job. I kept it to myself, but my days were numbered. The end of the job was near, and the other managers were all scrambling for a place at another large job somewhere. When they asked where I was going next, I'd grin and point to the picture. "Right there."

They were incredulous. "What do you mean?"

"Right there. That's where I'm going."

"What are you going to do out there?"

"As little as possible."

"Brian," they'd tell me, "you're throwing your career out the window!"

Quietly, I'd smile and reply, "That's exactly what I'm doing."

I tell you now that I have never regretted that decision.

Chapter Two

The Land

Choosing your land is probably your most important consideration, and there are many things to take into account.

For starters, where would you like to live? To me, this is the most important question.

Then, where can you afford to live? Where can you find a piece of suitable land for \$2,500? You'll need to be realistic about this.

Is the county unzoned? I highly recommend a county with no zoning, because then you can pretty much do what you want, and erect whatever you want. Taxes are usually cheaper, and there's generally no one to enforce county regulations. So while you're at it, check into whether or not there are any county regulations that would affect you (such as having to have a well or cistern, and a septic system in before you could occupy the land).

If the county is zoned, how strict are they? Do they have a building inspector? Are mobile homes allowed?

How much are the taxes?

Are there any covenants on the property? Covenants to me are completely undesirable, although it is possible to live with some if they're not too restrictive.

How far is it to town? With today's gasoline prices, this can be a real factor in the total equation. However, part of that depends on how often you'll be going to town.

Does the county maintain the road? (Assuming there is a road, that is.)

Can you get into that property in the winter? Do you have a four-wheel-drive? (And this is strongly recommended.)

What's the climate like? Is there a lot of sun?

How far is it to water? How far to firewood?

Is the ground suitable for a septic system?

And here's a big one: what will you do to support yourself after the homestead is in? Will you work? If so, where? Is the reception any good for cell phones? (If you're planning on having a phone, that is).

Myself, I would start with the question of where you want to live. I'm talking about what region you'd like to live in. Say, the West, or the South, for instance. From there, narrow it down to a particular state. Then check around in the different areas of that state.

In my case, I knew exactly where I wanted to live. It was in the San Luis Valley of southern Colorado. I had already purchased a 5 acre tract in Alamosa County a few years back for a total of \$2195. I paid \$295 down and made monthly payments of \$50 until it was paid off. I preferred to have the land—and everything else, for that matter—paid for, but you can sure make payments if you want to. It would substantially drop the initial amount you would need to get started from the \$5,000 we are talking about in this book. But you have to be able to make the payments, and money is hard to make in small towns.

My taxes are \$52 a year, and there is a building inspector to deal with, but I found him most reasonable.

For instance, mobile homes are allowed in Alamosa County, but travel trailers are not. However, my trailer is one of many. There are even a few buses. One guy I know built his entire house—complete with artesian well—without getting a single official permit. There's even a straw bale house down the road a few miles.

Remember that building inspectors are powerful people in big cities, but that's not usually the case in small towns (there are exceptions, however). I did eventually buy a building permit, to build a rock house, and this got him off my back. Also, by that time, I had my septic system installed, and that pacified him further.

Anyhow, I love the West, and particularly this part of Colorado. It's sunny almost every day, the views are fantastic, the people are friendly, and land is pretty darned cheap.

Here's a little bit about the place:

They say the San Luis Valley is the largest mountain valley in the whole world, roughly the size of Massachusetts. The Rocky Mountains run all the way around this valley, and the elevation here at the floor is quite high, 7,550'.

There are still some places available for \$2,500, especially in Costilla County, where land is cheaper. It's a favorite for homesteading, as are most of the farther-out places. Several years ago, I bought a 5 acre piece in Costilla County for \$1,200, then turned around and sold it for \$1,500. Recently, a realtor I met in town sold a 5 acre lot in Alamosa County for \$500, and it's in the artesian zone. Some area realtors, like at Fort Garland, for instance, deal in property that has pinon trees on it for somewhere around \$35 down and \$35 a month, but it's real tough getting to it in the winter on rocky roads.

Kenneth Casey (he's listed in the Albuquerque phone book) deals in Costilla County land. He sells it for \$45 down and \$45 a month. My brother bought one of his lots, and set up an \$800 mobile home on it.

But wherever you buy, check with the county it's located in to make sure the land taxes are paid. Don't take it for granted that the last owner paid them. It is possible for people to obtain land for back taxes, and you could be out your money and a place to live. (See section on tax lien properties later in this chapter.)

Naturally, with growth and the passage of time, some things have changed in the San Luis Valley. Costilla County—take note—is now recently zoned, as are most of the surrounding counties. Costilla County is in the process of trying to hire an enforcement officer—for at least permits, anyhow—but will never be able to enforce it everywhere. There are way too many homesteaders over there, in too large an area, for enforcement to be one hundred percent effective. Mainly, it depends on how visible your place is. But existing places were grandfathered in, anyhow.

Taxes in Costilla County are around \$30 a year on a 5 acre tract. Many people live in trailers, shacks, or buses, and even have outhouses (why, I can't understand, when for the same cost of materials you can have a fully functional septic system—covered later in this book.)

There are several artesian wells in this area that are accessible to the public. One is on Highway 160, halfway to Alamosa, and another in Blanca, in Costilla County (it used to be the town well.) In addition, there are various others scattered here and there throughout the valley. These flow year-round, with good clean water, due to a large aquifer under a layer of clay beneath the valley floor. Actually, there are two aquifers—one under the clay, and one overtop of it. And the clay can be shallow or deep, from 10 feet to over 400 feet deep, depending on the location.

Under pressure from water flowing underground from the mountains, a puncture of the clay layer (by a well) relieves pressure and yields a constant flow of water to the surface. It's sort of like pricking a giant water balloon with a pin, only the stuff doesn't squirt out.

But remember that you can't get artesian water everywhere in the valley. For instance, at my place I can't, because the clay layer is absent this close to the mountains, but I simply wanted to explain how the water flows constantly.

And you need a constant availability of water. The San Luis Valley only gets just over 7" of precipitation a year, so water collection is not really feasible as a main supply. Trying to drain a roof or other area for an exclusive water supply might be fine in places that get a lot of rain, but here, that would bring on thirst in a hurry. If you employ gutters for water collection in a place like this, it will only be an augmentation at best—and with few exceptions, not much of an augmentation at that.

As far as heating, it is quite cold here in the winter, so everybody heats with wood. Me? I just stoke the wood stove and forget about the temperature outside.

Here is the climatic data, courtesy of the National Weather Service:

The San Luis Valley is called the Land of Cool Sunshine, with the sun shining on average for over 320 days a year. So besides being excellent for solar power, I love it for the fact that to me, sunshine contributes to a spirit of optimism.

The temperature rarely gets into the 90's, with 96 being the highest temperature ever recorded in the valley. If it gets to 90, you should hear the people complain. (I have fun telling them that they don't know what hot really is.)

We average 50 nights a year where the temperature gets below zero. Minus 10 is nothing. In the last four winters, I have seen it get to -30, once. The coldest temperature ever recorded was an even -50, but that was in the 1940's. However, don't let the cold scare you. When the sun comes up in the morning, it quickly warms things. That doesn't necessarily mean it will be 60 outside, but it warms up and is quite tolerable.

With the dry climate we have here—and the abundant sunshine—it also seems to be substantially warmer than it is. There's none of that mushy wet cold like they have in Buffalo, N.Y.

Now remember, there are always two prices for land out West, and in many other areas, too. One is the tourist price, which is high. The other is the local price, which is lower, and the one you want.

There is also a similar situation with realtors. Most of them sell the high-dollar stuff, and won't even mess with lower priced properties. But in nearly every area, there is always one realtor who more or less specializes in cheaper land, or at least sells it, and that's the person you want to talk to.

In all land dealings, remember that money talks. I mean cash money. Many times, you can get land substantially cheaper if you've got cash to put on the barrelhead. I once bought a 5 acre piece in Costilla County for \$1,200 cash, which at that time was about half of the going rate.

At any rate, no matter where you locate, choose your land with care. You'll spend half your money on this purchase, and it can affect your happiness and economic situation for the future. Don't rush into anything, because there really is plenty of land out there to choose from. Take your time. Look around. On the other hand, don't pass up a perfect deal, either. Trust yourself; you'll know it when you see it.

Notes on tax lien properties:

Before you get excited about trying to get tax lien properties dirt cheap—and for the most part, they are—keep in mind that you usually don't get the property. In most cases, the people eventually pay up, so usually all you get is your money back with interest.

Notice that I said "usually" in both of those sentences. There are some instances where you might actually get the property, and indeed, I myself have obtained a few lots this way. One of those lots adjoined my land and expanded my contiguous holdings by one-third, which was really nice. But getting that particular piece was really just a stroke of luck, and in my experience such things are the exception, not the rule.

In my view, a tax lien property is generally not desirable for homesteading. There are too many variables, and too many chances for it not to work out. It also takes too long to actually get title to the land. However, a tax lien property could be an alternative if you know that you won't be homesteading for several years yet, and have the time to wait until you actually own it.

Each state has its own rules or laws about tax lien properties, and if you're determined to pick up a piece of land this way, you'll have to investigate them. It's pretty easy to do this. If you have access to the Internet, look it up. Search under "tax liens, ___ county, ___ (state)". Then, call the county clerk or county treasurer to confirm that the information you have is correct. If you can visit with them in person, even better. This follow-up contact is important, because rules and laws do change. New Mexico, for instance, changed the way they conduct tax sales, and you'll find both versions on the Internet. One way is correct and current; the other is outdated. What's the difference? A couple of years on getting title (it's actually much quicker now). So call them.

Note that some of your Internet search results will be non-government sites where, for a fee, they can "show you how" or "provide current tax lien listings." Ignore these. They're just trying to make money from something you can do yourself with a little investment of time.

Incidentally, I wouldn't bother with an initial written inquiry about tax liens, because like everyone else these days, those county people are busy and may not get around to writing back. (I say this from personal experience.) It's also possible that they know or are related to some of those people whose land is up for liens, and might not be overly happy about helping them to lose it.

Here's how the tax lien process works in Colorado: At a set time of year, counties annually publish a list of properties in the local newspaper that back-taxes are owed on. The size of the parcel, location, owner's name and address, and amount owed are all shown. Notice is given that if the taxes aren't paid by a certain date, the county will hold a tax lien sale.

At that sale, people show up to "buy" tax liens. Basically, if you purchase a lien, and then pay the next two or three years of back taxes as they come due (there's a mysterious way they come up with that figure, too), you can then apply for title to the property. Then, you pay some more, wait some more, and eventually, there's a small chance that you just might get lucky.

But normally, you don't get lucky. Most people redeem their property by paying the taxes plus certain fees. When that happens, the county sends you written notification canceling your lien, and also your money back, with interest. (The interest, by the way, is pretty decent. It's something like 9 percent above the prime rate, or thereabouts.)

If you do get lucky, here's how it goes. It takes at least three years of paying the back taxes before you can apply for title. At that time, you have to cough up an additional \$400 to \$800 or more to get the process moving (this is for the county's attempts at owner notification, advertising in the paper, etc.). During this time, the person can redeem at any opportunity, right up until the very day before the county issues you a deed.

If you get the land, the deed the county issues will be a Treasurer's Deed, not the more common Warranty Deed. This means, of course, that the county will not warrant the property to be free of all liens or "encumbrances." No realtor would buy the land from you, if you ever wanted to sell (except maybe for pennies on the dollar), unless you had first done a Quiet Title Action in court. Cost: \$2,000 or more.

Even if you are successful, you still won't have *completely* clear title for 9 years, because of the antiquated Sailors and Miners Act. The reasoning goes that a person might have been away at sea or working in the mines for a number of years—they picked the number 9, for some reason—and not been notified that they were losing their property. This Act is outdated, of course—just like the open range law in Colorado where you have to fence your property if you want to keep somebody else's cows out—but that's the way it is.

Assuming that you get title but don't do a Quiet Title Action, know that at any time during the 9 year period, the person the land was taken from *could* come back on you and take you to court if they have some kind of valid claim. They probably won't, but they could. Likely, this would depend on having a substantial claim, and also how much the land is worth. Once in court, the burden is on *you* to prove that the county did everything right, legally, in taking away that person's property (let's hope that they did.)

Should you get a parcel this way, and you sell it to somebody before 9 years has passed, and if the original owner comes back on you with a legitimate claim, you can then expect to be sued by the person you sold it to.

Some fun, huh? I recommend staying away from tax lien properties as a place to live. I think it's actually easier to buy land the regular way. Then it's yours, free and clear, with no worries.

Now, back to those tax lien sales. If you do go to a tax lien sale, there will be several kinds of people there. Some will be just like you, others are doing it on a lark, and then there will be those who fancy themselves as investors.

The investor types typically choose city properties with houses, because they know that sooner or later, somebody is going to pay those taxes rather than lose their home. Investor types figure that's where the money is, so that's what they buy. It's sort of funny to watch these people, because they actually bid against each other for those particular liens. And any bid above the amount of taxes due is money that does not come back to you if the owner redeems. It's simply gone.

Don't bid, because bidding, at least in Colorado, is not necessary at all. Neither is waiting for a tax sale. In casual conversation with the county treasurer one day, I found out that you don't have to wait for the tax lien sale to purchase a lien on any outstanding tax-due property. She said that all I had to do was come down during any normal working hours and go through the book of tax-due properties, pick one or more that I liked, and pay the money. So from then on, that's exactly what I did, and never attended any more sales.

My aim was not to invest, anyway. It was to pick the outlying pieces, and cheap ones at that, that I was most likely to get because it wasn't worth much to begin with and the owner lived out of state. I really believe it increased my chances.

Now, having tried to discourage you from getting a tax lien property, I would say that there *may* be instances where you could use a piece for homesteading that you obtained this way. Note that simply holding a tax lien does not mean it's your property. Nor does it give you any property rights whatsoever. Until you have a Treasurer's Deed in hand, all you have is a lien, and that property still belongs to someone else. If you set foot onto it, you're actually trespassing.

As for me, there is only one instance in which I would ever live on a tax lien property. That would be if I had a Treasurer's Deed in hand and nowhere else to go. In other words, if I had title, and *had* to live on it. But that's something you would have to decide for yourself.

Another note: By now, you have all seen some supposedly rich person on a television infomercial explaining how you, too, can become rich by buying tax lien properties and reselling them. This process is portrayed as being quick and easy—almost nothing to it, or so it would seem—and very little money is needed to get started. So if you'll just send them \$250 or so, they'll be happy to let you in on the Big Secret and mail you the coveted information that can transform your life.

Now I'm not saying it can't be done. But ask yourself why a millionaire would need \$250 from you. Then ask yourself why a millionaire would want to let you in on his secret to wealth. However, having said that, I think it *might* be possible to supplement your income by investing in tax lien certificates. Of course, this is assuming you have some extra money you can part with, which most homesteaders don't. But I did it myself for a few years, and it brought in a few bucks here and there. Surprisingly, I actually ended up with some of the property. But it almost broke me, because I didn't expect to get the property—only my money back with interest. When the people didn't pay up to redeem it, I was stuck with having to pay for title to those pieces. I got it done, but it was sure hard on my budget at that time.

Remember, there is no guarantee when you'll get your money back from tax liens. It could come at any time, from a matter of two weeks to three years or more. I say more because you might end up getting the property, in which case your money will come back to you years later when you sell it.

So here again, I would urge you to buy a piece of property the regular way. That way it's yours, and no worries.

Chapter Three

Shelter

A travel-trailer is the best for a quick, easy dwelling because they're cheap, give all the comforts of home, and are easily transportable by ordinary vehicle. Mobile homes do give much more room, but also generally cost more, although that is not always the case. For instance, my brother paid \$800 for his 10 foot x 40 foot mobile home, and I moved it with my 3/4 ton pickup. So you might say he "Mobile-Homesteaded Under \$5,000." But for larger mobiles, you need a semi tractor to move them. They also require more work to set up and maintain, and when I started this, I didn't want to work on a house anymore.

For this reason, I bought a 21 foot travel-trailer in good condition for \$1,200. It was a 1972 Concord Traveler, with 15 inch tires, dual axles and electric brakes, which I used. An older trailer of this size weighs approximately 4,200 pounds, and has a tongue (hitch) weight of about 425 pounds.

Naturally, since you will be living in it, the bigger the trailer, the better, but don't out-do your towing vehicle. I pulled mine with a 1984 Grand Wagoneer that had a 360 V8 in it, and it was inadequate, except for engine size. I subsequently had to replace the transfer case in a small town along the way. Cha-ching! I recommend a pickup truck, preferably a 3/4 ton 4WD. You'll need one anyway.

Besides the obvious things like a bunk, you'll need the following items in your trailer:

Kitchen -- Sink, stove, propane refrigerator.

Bathroom -- Shower, vanity, toilet with holding tank.

Water system -- with storage tank and hot water heater.

Propane heater or furnace -- for when you're away. Note that this should be the older non-fan variety. Many modern trailers have a furnace that uses a fan to push the heated air through heat ducts, just like in a house. This is undesirable, since the fan requires electricity, and I'd hate to see my solar power being used to push air around a small trailer when it really isn't necessary.

A 12 volt lighting system (many trailers also have 110 volt lights.)

Most trailers of this size already have this stuff. If the one you're looking at doesn't, I wouldn't buy it, unless it's only lacking the lights. You can easily install a 12 volt lighting system, and in fact, 12 volt fluorescent lights are about 4 times as efficient as 12 volt incandescent bulbs. Or, you may choose to use only a kerosene lamp in the evenings, but you'll have to be careful. Knock it over, and you're burned out. (By the way, don't use lamp oil in these things. Lamp oil costs a whole lot more, and I don't think it puts out as much light as kerosene. Lamp oil does give off fewer fumes, however. It also smells better.)

When you look at the trailer, make sure it's big enough and comfortable -- you'll be spending a lot of time in it.

Think about the floor plan. Where will you put the wood stove? In my case, I ended up taking out half of one couch, and installed the wood stove next to the hot water heater.

My trailer also had an apartment-sized electric refrigerator in it when I bought it. The owner, who 'camped' in places like suburban KOA campgrounds, actually thought that such a frig was a great asset.

Wrong. You really need a propane unit, and that's what I ended up putting in.

Initially, since I took the third couch out and built a desk for writing, I built-in an icebox on one end of the desk, near the door. That's OK, but an icebox needs ice to operate—and the ice has to be brought from town, nearly every day (except in winter, when you can make your own.) But still, you have no freezer, and a small RV propane refrigerator actually costs less to operate than the cost of ice. (This is covered more fully in the refrigeration chapter.)

Everything in the trailer must work, or at least be fixable. If the propane frig doesn't, the chances are that you can fix it. (See the refrigeration chapter.) Dump some water into the holding tank to make sure it doesn't leak. Light all gas appliances. Check the furnace for fumes.

Setting Up The Trailer

You'll want to situate your trailer in the best possible location on your land, taking the best advantage of access, sunlight, prevailing wind direction, and, last but not least, the view.

When you have the spot figured out, lay a couple of planks down in front of the tires (make sure the planks are level) and pull the trailer up onto them. This keeps the tires out of direct contact with the ground -- which causes dry-rot --and also gives you a stable starting point to work from. If you can't find any planks, try to put a few pieces of plywood or something under the tires. If you don't, the tires will sink into the ground. You really can't set up the trailer without these. So pick something up from somewhere, whether that's in town, an old abandoned ranch or farm, the dump, or even a dumpster.

The next step is to set the rest of your trailer frame solidly on cement blocks, stands, or sections of logs. Whatever you use, be sure to put a flat piece of wood or block under the bases of these things, with the exception of thick log sections. For my set up, I used the adjustable stands that came with the trailer, and put slightly larger squares of plywood under the stands.

Use a level on various parts of the trailer while you're tightening up the jacks or stands. Be sure and check the inside floor of the trailer, especially. You can just about get it all from that. Just go for it; this is really not that hard to do.

You may want to consider tie-downs for the trailer, if you live in a windy area. Although it's windy where I set up, I didn't bother with tie-downs. Only once, when the trailer was really rocking during a hellacious windstorm, was I wondering if I should have. But I was alright, and the wind eventually passed.

Skirting

Skirting a travel-trailer helps a lot. It keeps varmints and bugs out, allows you weather-proof storage under the trailer, keeps the trailer much warmer (especially the floor,) and helps to keep the plumbing and holding tank from freezing. Skirting also looks good, and adds a sense of permanence to it all.

You can probably use a variety of things for skirting, but I recommend good old corrugated barn metal. I have seen fiberglass panels, wood, plywood, and even straw bales used. However, these all have drawbacks. Just look at any old carport or porch with fiberglass panels -- they're all broken or cracked.

Wood is not necessarily bad, but it's a lot of work to install, and requires painting. Plywood sponges water and moisture up from the ground, delaminating in a short time. Straw bales? The words there are mice, bugs, and maybe fire.

Galvanized barn metal is the best bet. It's tough, light, easy to install, never needs paint, and won't soak up moisture. It comes in convenient sizes, like 2 feet or over in width, and 8, 9, or 10-foot lengths. Some is even longer.

Figure up the linear footage (total length) that you'll need with a measuring tape, allowing for several inches of overlap at each joint, including the corners. My trailer needed 9 pieces: 1 for each end and 3 for each side. The extra piece came in handy for the wheel wells, where they arched up, and other things.

You'll also need several pounds of self-tapping sheet metal screws, a pound or so of drywall screws, several tubes of caulking, and a few 1x4's, which, hopefully, you'll have laying around, or else you can pick them up from somewhere. You could even take apart an old pallet for pieces of wood, although older pallets are generally made from oak and are as hard as rock.

Now is the time to decide whether you want to insulate the skirting or not. I chose not to, because of the cost of rigid styrofoam insulation – which was about \$27 a sheet. Regular fiberglass batt insulation is much cheaper, but I thought it might be a haven for bugs, so I passed on it. However, if you think you need it, buy it. If I had it to do over again, I'd probably insulate. You'll need to figure out how to secure the insulation: hang it, nail it, wire it, or brace it into place, and probably any of these methods would do.

Now before you start the skirting, figure out the best location for access panels. You'll need at least one of these, and preferably two. This access panel will lap over and screw onto a regular skirting panel on each end.

Figure how deep your skirting will be into the ground, and dig that narrow trench all the way around the trailer.

Now start installing the barn metal, working from a corner.

You will need to run both ends of both sides of the skirting slightly past the ends of the trailer, to make the corners.

You want to lap the skirting up over the outside of the trailer, at least up to the trim at the bottom of the trailer. Make sure the edge of the sheet lies against the trailer, making a nice seal. That is, the wave of the corrugation at the top edge of the sheet should curve into the trailer, not away from it. I lapped up the distance of two corrugations on the trailer and then screwed through the sheets, directly into the plastic trim. This is enough to hold the top firmly in place, but you'll have to be careful that you don't strip the holes in the plastic.

At the ends of the panels, cut a piece of 1x and attach it behind where the joint will be. Obviously, you can't lap the trailer with this wood, so cut it short enough to fit under the trailer—the wood does not have to attach to the RV.

Starting at the end of one side of the trailer, screw the first panel onto the trim, making sure the metal runs past where the corner will be. Then, using drywall screws, attach the 1x to the sheet. You may want to "back up" the piece of wood to make it easier to screw. If you use your hand, make sure it's out of the way of where the screw will come through. Running a screw into your hand is quite painful, I can assure you. It's just as well to hold another board, a hammer, or even a rock behind it while you're screwing.

Now, if you are going to insulate the skirting, install whatever kind of insulation you are using behind the first piece of skirting. But irregardless of whether you insulate or not, when the first piece of barn metal is in place, backfill this section of trench with dirt on the inside.

Wood is not necessarily bad, but it's a lot of work to install, and requires painting. Plywood sponges water and moisture up from the ground, delaminating in a short time. Straw bales? The words there are mice, bugs, and maybe fire.

Galvanized barn metal is the best bet. It's tough, light, easy to install, never needs paint, and won't soak up moisture. It comes in convenient sizes, like 2 feet or over in width, and 8, 9, or 10-foot lengths. Some is even longer.

Figure up the linear footage (total length) that you'll need with a measuring tape, allowing for several inches of overlap at each joint, including the corners. My trailer needed 9 pieces: 1 for each end and 3 for each side. The extra piece came in handy for the wheel wells, where they arched up, and other things.

You'll also need several pounds of self-tapping sheet metal screws, a pound or so of drywall screws, several tubes of caulking, and a few 1x4's, which, hopefully, you'll have laying around, or else you can pick them up from somewhere. You could even take apart an old pallet for pieces of wood, although older pallets are generally made from oak and are as hard as rock.

Now is the time to decide whether you want to insulate the skirting or not. I chose not to, because of the cost of rigid styrofoam insulation – which was about \$27 a sheet. Regular fiberglass batt insulation is much cheaper, but I thought it might be a haven for bugs, so I passed on it. However, if you think you need it, buy it. If I had it to do over again, I'd probably insulate. You'll need to figure out how to secure the insulation: hang it, nail it, wire it, or brace it into place, and probably any of these methods would do.

Now before you start the skirting, figure out the best location for access panels. You'll need at least one of these, and preferably two. This access panel will lap over and screw onto a regular skirting panel on each end.

Figure how deep your skirting will be into the ground, and dig that narrow trench all the way around the trailer.

Now start installing the barn metal, working from a corner.

You will need to run both ends of both sides of the skirting slightly past the ends of the trailer, to make the corners.

You want to lap the skirting up over the outside of the trailer, at least up to the trim at the bottom of the trailer. Make sure the edge of the sheet lies against the trailer, making a nice seal. That is, the wave of the corrugation at the top edge of the sheet should curve into the trailer, not away from it. I lapped up the distance of two corrugations on the trailer and then screwed through the sheets, directly into the plastic trim. This is enough to hold the top firmly in place, but you'll have to be careful that you don't strip the holes in the plastic.

At the ends of the panels, cut a piece of 1x and attach it behind where the joint will be. Obviously, you can't lap the trailer with this wood, so cut it short enough to fit under the trailer—the wood does not have to attach to the RV.

Starting at the end of one side of the trailer, screw the first panel onto the trim, making sure the metal runs past where the corner will be. Then, using drywall screws, attach the 1x to the sheet. You may want to "back up" the piece of wood to make it easier to screw. If you use your hand, make sure it's out of the way of where the screw will come through. Running a screw into your hand is quite painful, I can assure you. It's just as well to hold another board, a hammer, or even a rock behind it while you're screwing.

Now, if you are going to insulate the skirting, install whatever kind of insulation you are using behind the first piece of skirting. But irregardless of whether you insulate or not, when the first piece of barn metal is in place, backfill this section of trench with dirt on the inside.

Secure the next panel in place, overlapping it an inch or two, by using one self-tapper at the end lap. Line up the other end of the second sheet for height, and screw the panel to the trim. Put the remaining screws into the joint (they'll run through the first sheet and into the 1x4.) Insulate and/or backfill with dirt.

At this point, you're probably up to where your access panel will be. Skipping that space, cut a sheet to complete the run, bearing in mind the distance to go past the corner, and also to lap under the access panel. Install this sheet. Again, insulate and/or backfill behind it.

Cut your access panel to size and install it with the self-tappers. Note: if you are insulating, somehow you must attach the insulation to the back of this sheet, so that it will stay with the sheet when you pull it off for access. Or, you could also make it free standing so you just pull the sheet and move the insulation aside when you need to get under there.

Also shear and install a piece of metal to cover the wheel wells, lapping over both the wheel trim and the metal panel below it. There's not much you can do about the exposed spaces behind the corrugations on the ends of this little panel except caulk them.

One side is now complete. Install the other side in the same manner.

For the ends, you'll cut one sheet to fit between both sides. To do this neatly, this means you'll cut the waves of the corrugations on both ends of this panel. After measuring for the sheet, you'll do this, with the panel laying down, by standing a cut-off piece on edge, directly onto the sheet where the corner will be. Trace the general outline of the corrugations with a magic marker, and cut them with tin snips. You don't have to be perfect, because you'll caulk this joint, anyhow. If you don't want to follow the curves exactly—and you don't need to—you can simply cut the corrugations out in small triangles, which is what I did.

On the front of the trailer, you'll probably have to cut around the frame, gas line, and maybe some wiring. Draw your cutouts or holes exactly where they need to be, by using a magic marker (or scratching the outline with a nail or screw). What you'll want to do is simply cut down to the center of each cut-out from the top of the sheet, and then when you're there, make the cutouts. This leaves as much of the sheet in place as possible, yet still allows for fairly easy installation—you pull out one side of the metal at the cut and slide the sheet up around the obstruction. You can do it; just try. But you should wear gloves when cutting, and when pulling the sheet around the obstructions. Otherwise, you'll probably cut your hands.

Install a 1x at the corners, onto the end panel of the skirting along the sides of the trailer. Maneuver the end sheet into place—the one at the front is perhaps the most difficult—and screw through the panel into the edge of the 1x.

Do the same thing with the rear panel on the trailer. There probably won't be any cutouts of any kind at the rear, unless your plumbing comes out there. However, the other consideration at the rear is the bumper. Depending on your trailer, you may want to cut around the bumper projections, and then install the sheet under the bumper, directly to the trailer. I didn't do this, because on mine, the bumper was a square tube projecting out from the trailer, and I used it as a surface to screw to, bending the sheet overtop the bumper and securing it with self-tappers. Depending on the thickness of the metal, you may have to drill a hole in the bumper first, just slightly smaller than the self-tapper. Otherwise, you'll snap off a bunch of screws.

Using the 1x or 2x in the corners, under the bumper, screw the end panel into place.

Now, caulk the corner joints, all gaps that need it, and any projections coming through the skirting, such as the frame on the front. Do NOT caulk the access panels.

The metal fit so well against my trailer that I didn't need to caulk it where the horizontal top line of the skirting curves into the trailer siding. But if for some reason you need to, do it.

Also cut a small access panel—just big enough to get your hand through to reach the holding tank valve—exactly where you'll need it. Cut a piece of metal to go over this and screw it on.

The last thing is to backfill a little dirt against the outside bottom of the skirting. Don't put too much there, or it will bend the panels inward and look unsightly. Just fill the little trench and a few inches more.

Okay, you are now in business.

Skirting a travel-trailer of this size, in this manner, can all be performed in one day. It's not that much work, and is worth every bit of the small effort it will take.

Isn't it nice to have a warm floor?

Chapter Four

The Septic System

You can build an inexpensive, fully functional septic system for under \$100, if you can get the rock free, or at least cheap. My system cost me a total of \$70, with the PVC piping being the majority of the cost.

This is a very simple system, but requires the most output of physical labor to install, if you dig it by hand. I dug mine with a shovel, and it took me over a week alone on the excavation. If you should happen to have a neighbor who has a backhoe, lucky you.

Since your trailer's plumbing is set up pretty much the same as in a regular house—for the most part—you do not need to install any vents in the septic system itself. If you look on the top of the trailer, you will see at least one plumbing vent sticking up, and more likely two. Your septic tank will vent directly through one of those vents, and the holding tank through the other.

When you install your septic, you should sink your system deep enough to prevent it from freezing. This can be determined by the "frost line," which means how far down the ground in your location freezes during a typical winter. Here, where the frost line is about 3 feet, I set up my system so that I have 32 inches of dirt over the tops of my barrels. Since the lines in and out are just slightly below the tops of the barrels, and since those lines are 4 inches in diameter, that put the height of waste in my septic system at about 3 feet.

This kind of septic system works on two barrels, one for solids, and one for liquids. The solids drop into the first barrel, where they are decomposed. The liquids flow into the second barrel, and then out the leach line.

For the tanks themselves, you will need two plastic barrels, 55 gallon size. You can get these barrels from a variety of places, such as stores, factories, or crop-dusters, but I purchased mine from a local honey farm, who imports raisin juice concentrate in them. They're pretty sturdy, the walls of the barrels being about ¼ inch thick.

My barrels are blue in color, but I have also seen them in black, and white. These are standard sized drums, with the usual two openings in the top. Lids are needed for the openings, as these will be sealed.

These barrels were \$5 each, and simply needed to be washed out. Although the barrels are going to contain sewage, I washed mine out anyway, because I want those bacteria down there eating waste, not making fruit salad.

Big note here:

DO NOT use metal barrels, as these will quickly rust out and leak. Your system will be destroyed, and you'll be digging all over again to install a system with plastic barrels. So use plastic in the first place and save yourself the headache.

For the sewer line itself, from the trailer to the tanks, standard 4 inch PVC plastic plumbing sewer line is used. PVC comes in several grades, but ask for the thin-walled stuff, as the thick-walled is more expensive, and not needed in most soils. This comes in 10 foot sections, and one end is flared to accept the regular end of the next section of pipe. Be sure to buy PVC cement to glue the joints together. Chances are, the store owner will also try to sell you PVC primer, which is applied before the glue. Although primer is usually desired (readers of the first two editions will

note that I've kind of changed my mind on this point), I think it is not absolutely necessary as long as the joints are clean.

From the tanks outward, you need a leach-line, also of 4 inch PVC pipe, but perforated just for this purpose. You can get pipe for this purpose that has the holes already drilled, but if they happen to be out of stock, simply buy the solid pipe and drill the holes yourself. However, it costs about the same for both pipes, so try to buy the pre-drilled kind.

The holes are generally about ½ inch in diameter, spaced every 12 inches or so, and are drilled so as to be on both sides of the lower 1/3 of the pipe when installed.

You will need two 90 degree elbows. You also need a 3 inch-to-4 inch adapter fitting, and 2 caps.

The drums are joined together about 4-5 inches up from the bottom with a section of solid 4 inch pipe, about a foot long. These illustrations show details:

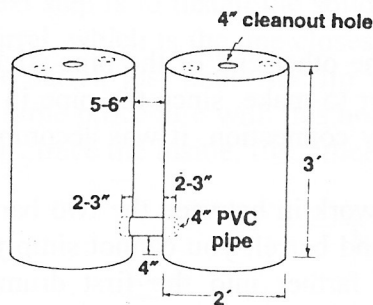

Joining septic barrels.

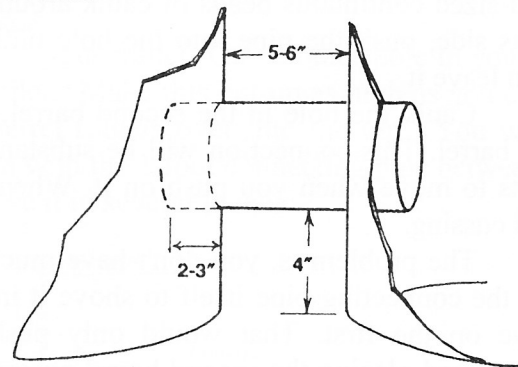

Joining septic barrels.

Note: Some people who read my first edition of this book were concerned that this joining pipe may be too low, and thereby get plugged with sludge. But I have been on my original septic for four years now, and haven't had a single problem with it. Not one. Indeed, a year after I did mine, I installed another system for my brother—in exactly the same fashion—and it also functions perfectly, despite the fact that the only bacteria he puts in it is an occasional dead mouse. (One person with a new full-sized tank threw in a road-killed rabbit to start the bacteria process.)

I did know one person who put a second joining-pipe in his barrels, up near the top, but I don't think that's a good idea. I believe it would allow some of the solids or paper to float into the second barrel—possibly even the leach line—and may cause a backup or slowdown of the system. And there's also the consideration of more penetrations in the barrels. More holes could mean more chance of leakage, something you want to stay away from.

Of course, the other option would be to simply raise the single joining pipe up higher, say, closer to halfway up the barrels. So if you think it's a good idea, do that. If you want a second pipe, that's up to you. But I wouldn't put it more than halfway up, if at all.

At any rate, here's how to install the joining pipe: Using the inside diameter of a small section of pipe (cut a 2 inch piece off one of the longer sections if you don't have a short piece laying around,) trace the circle onto the barrel with a pencil or pen. Be sure it's a round circle—don't crush the pipe with your hands as you trace it, or you'll have an ellipse instead of a circle, and it may leak.

Drill a hole with a large standard drill bit or paddle bit, near the edge of the inside of your circle. The hole needs to be large enough to accommodate the blade of your jig saw. Cut your holes out, being careful to stay either inside of or right on your traced lines. A jigsaw cuts in a circle best

by pivoting the saw on the blade, that is, by turning the rear of the saw as you cut, not by trying to move the blade over with the pressure of your hand.

After the cut is finished, remove the cut-outs from the barrels, if they fell inside, as they could cover or plug one of the lines. Now trim up the cuts with your wood rasp, being careful not to take too much out.

Take your 1 foot section of 4 inch joining pipe and try to shove it forcefully into the hole of one of the barrels. It probably won't go at first try, so you'll need to continue filing and trying until you can force the pipe in. You want a tight fit, so as not to leak. The pipe will slide in easier when you caulk the holes, which will provide lubrication.

When you can get this pipe into both barrels, silicone the edges of one of the holes. Also apply silicone to one end of your 1 foot section of pipe, about 3 inches from the end. Run two good-sized continuous beads of caulk around the pipe, about $\frac{1}{4}$ inch apart. Now, laying the barrel on its side, push the pipe into the hole until you make contact with the second bead of silicone. Then leave it.

Caulk the hole in the second barrel, and also the other end of the pipe sticking out of the first barrel. This connection will be substantially harder to make, since the pipe in the first barrel wants to move when you push on it. When I made my connection, it was accompanied by some mild cussing.

The problem is, you don't have much room to work in between the two barrels. You must grip the connecting pipe itself to shove it into the second barrel; you cannot simply line it up and shove on the first. That would only push the pipe farther into the first drum. So, I would recommend placing the second barrel against something solid, in an upright position, and working the pipe into it with your hands. Again, push it in until you make contact with the second bead of silicone.

The pipe should stick into each barrel by several inches. Look down through the openings in the tops to make sure this is so. It doesn't have to be perfect, and if it sticks into one barrel farther than the other, don't worry about it. You should end up with about 5 inches or so between the barrels now.

At this point, find the center of the tops of the barrels, and trace the outside of the 2 inch section of pipe you used to trace the 1 foot connection with, onto the tops of the barrels. These will be the clean-outs.

Cut these out, being careful again to retrieve the cutouts. I find it easier to drill a second hole directly in the center of the circle, and stick a finger in this hole when you are finishing your cut. This keeps it from dropping into the barrel. Should it fall in anyhow, simply pound a nail into the end of a stick and bend it over like a hook. Use this to fish it out. Now tape over these holes with duct tape.

Next, silicone the existing threaded holes in the tops of the barrels, and install these caps, tight. Go over the edges with silicone, if it hasn't squeezed out, so that you get a good water-tight seal.

Now put a lot of silicone around the connecting pipe at the bottom of the barrels, for an extra-good seal. This is perhaps the most important connection in the system.

You are now ready to place the barrels in the hole. Since they are so light, just grab them by the edges of the tops and lower them into the hole. While moving them, try to be careful not to twist or move the barrels around in reference to each other—you want that good seal.

Position the barrels in the center of your hole, as level as the eye allows, and fill in around them with a little dirt, maybe up a foot or so, so the barrels will not move. Don't compact the fill at this point, this will allow for the barrels to expand to their normal size when they fill with waste.

Now, recheck the depth of your trenches for the sewer line to the trailer, and also the leach line. EVERYTHING now should work from the height of your barrels. Should you find that your trenches are not deep enough, DO NOT attempt to raise the barrels and allow dirt to fill in underneath. If you do this, they will settle later, probably crushing the lines in and out, giving you a big headache, and probably another backache when you have to dig up and fix everything. Do everything right the first time.

Work from the setting of the barrels, by either filling in or digging more out of your trenches. If you should need to fill your sewer line trench from the trailer, this can be done, but be sure to compact it by walking over the fill until it's hard-packed. The slope of the sewer line absolutely must be maintained.

The next step is to install the solid sewer line to your trailer. Cut another hole in your first (the solids) barrel, which is the one closest to your trailer. Make this cut up as high as you can on the side of the barrel, just under the lip where the barrel rounds over into the top. You will be following the same procedure with this hole as you did with the 1 foot connecting pipe between the barrels. That is, trace the inside, file, silicone, and shove it in several inches.

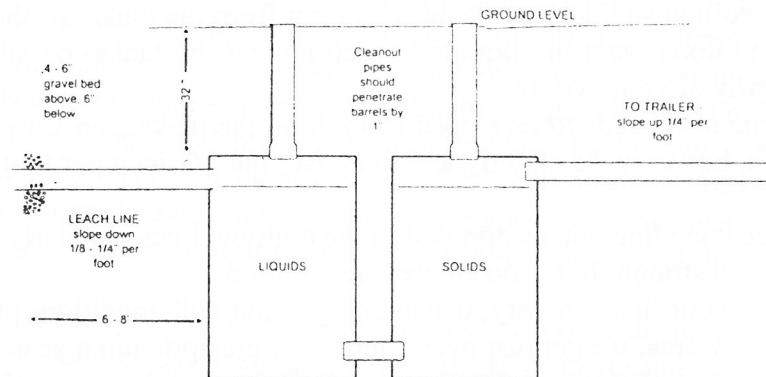

Septic system.

MAKE SURE this line slopes $\frac{1}{4}$ inch to the foot, UPHILL to the trailer. This is very important. Less than $\frac{1}{4}$ inch doesn't allow the solids to slide downhill. More than $\frac{1}{4}$ inch generally allows the liquids to out-pace the solids, and then the solids get stuck on the bottom of the pipe, clogging the sewer line.

Use a level on this. An easy trick to make sure you're getting the right slope is to tape a block of wood of the appropriate thickness on one end of your level. If you're using a 4 foot level, a 1 inch block would be correct ($\frac{1}{4}$ inch to the foot.) A 2 foot level would require a $\frac{1}{2}$ inch block.

You can now lay the level directly on top of the sewer pipe, block towards the barrels, and when it reads level, you're right on target.

You want as straight a line from the tank to the trailer as possible, with as few elbows as needed. Ideally, there will be only two elbows: one at the trailer connection to send the waste downward, and the other directly beneath it, underground, to direct the waste towards the tank.

You may want to install a clean-out in your sewer line, where the line plunges directly downward after turning down from the trailer, just in case you ever need to snake it. I didn't do this

when I set up my trailer, but if I had it to do over again, I would, just in case. A clean-out is nothing more than a PVC fitting with a screw-on plug on the side, for access.

Most older trailers use a 3 inch PVC waste pipe, and since we are working with 4 inch piping, this is where the 3 to 4 inch adapter fitting comes in. The trailer's waste pipe usually has two prongs on it to facilitate the connection of the flexible RV sewer pipe. Make sure your adapter will fit the trailer plumbing, and then simply saw the prongs off with a hacksaw. File smooth, and make your connection.

The Leach Line

From your liquids barrel, you need a leach line leading outward, to carry the liquids away to where they'll be absorbed into the ground.

The leach line should be a little bit lower than the inlet line (the sewer line from the trailer). Consequently, you should make your hole in this drum a couple of inches lower than you made the inlet hole in the solids barrel. This will allow the sewage to fall into the septic tank, keeping the level of the tanks lower than the inlet line, so that nothing lays in the sewer line, creating a clog or blockage. I made mine 2½ inches lower. You should make this connection in the same way as the others—trace, cut, file, caulk, and shove it in.

The perforated line should start about 8 feet out from the tanks, so the first section of pipe should be solid. You don't want the liquids to seep around the tanks, possibly settling them and destroying the integrity of your system.

The leach line also needs to be sloped away from the tanks, and I used the same ¼ inch to the foot here. It can, however, be slightly less than that, but 1/8 inch per foot is the minimum. To be safe, go ¼ inch.

You only need one line out, as opposed to the multiple lines popularly in use in larger home systems. It should be a straight line—no elbows are required.

The length of your line can vary, depending on your soil conditions and the wetness of the area you live in. In my area, we get just over 7 inches of precipitation a year, so the soil is dry and sandy. My line is 35 feet of perforated pipe, after the 8 foot solid section. If you get a lot of rain, I'd suggest making your line a little longer.

Your excavation (or leach line ditch) should be about 2 feet wide, and approximately 6 inches deeper than where the pipe will actually be laid, to allow for rock underneath it. You will need to slope the ditch, along with the pipe. At the end of your trench, dig it wider and deeper, making a pit you can fill with gravel.

The rock should be gravel-sized or larger, and you will need about 3 pickup loads of it. I used red volcanic rock—which is real light stuff—and got it free from a local aggregate company, who didn't even sell it anymore. There were some piles laying around, and upon asking—and spending a few extra minutes talking with the man in charge—they gave it to me for free. They even put one load in my truck with a front-end loader. See? It pays to be friendly. Also to live near a small town.

Fill the ditch by eye to the approximate level of the bottom of the pipe. Then start your installation, using the level on the pipe. The gravel is easy to work with, and can be scraped or kicked around as needed for the proper slope.

The perforations, of course, are to be installed towards the bottom of the ditch. I also drilled some ¼ inch holes along the bottom of my pipes, spaced 2 feet apart on the first section, 16 inches

on the next, and 1 foot on the third piece. On my last 5 foot section, at the pit, I drilled holes every few inches.

There are to be no holes in the top of the pipes, as this will allow sand and dirt into the pipes, plugging them.

At the end of your leach line, insert a coffee can directly into the end of the pipe and run a few screws through it to seal the line. You're only keeping gravel out, so it isn't necessary to make a watertight seal. One person I knew just put an elbow at the end, turned down into the pit, but I like the coffee can.

When the entire line is in place, go ahead and fill the ditch with gravel, covering the pipe with 6 inches of gravel, if you can.

Then, cover the gravel with plastic or building paper. Some people have used a thick layer of straw, but I'm against this. Straw is organic, and thereby may decompose. Plastic, as the saying goes, is forever, and never goes away.

But whatever you use, this is important to do, because if you don't cover the gravel, dirt and sand will settle down through it, and—you guessed it—clog the line. That would be a catastrophe, and you'd be digging again. I used two layers of clear plastic, the kind you put over windows in the winter. It costs a few bucks. When this is done, backfill the trench completely with dirt.

Next, you want to install clean-outs in the tops of the barrels, where you already have the holes cut and duct-taped. These will be solid 4 inch PVC pipes, running straight up to ground level.

These will need to be self-supporting, and so you must use a straight connection or the flared end of a pipe. In either case, you'll need to cut two pieces several inches long, and insert them in the flared ends or connections. This extra width, or "collar," is what holds the pipes up.

Silicone the connections, and brace the pipes in place by loosely wiring them to sticks jammed sideways against the sides of the excavation. This will allow the pipes to float, since the tops of the barrels are bound to sag a little under the weight of the soil over them, and you don't want dirt leaking into your tanks. Seal around the connections again, and don't spare the caulking here.

At ground level, or maybe just above, slip the PVC caps over the pipes. These are to be dry connections: no glue, sealant, or caulk around those caps. If you ever need to clean out the tanks, this is where you'll access them.

Now, finish your backfill of the entire excavation. Note that it matters not how you fill-in the sewer line and leach line. However, I recommend backfilling around the septic tanks as the barrels fill with waste—in other words, over a matter of days, so that they are completely expanded when you fill in the dirt. I didn't compact any of the fill around my tanks, to allow for this.

Congratulations! You are now in business.

Use of the System

Now for a few words on the toilet and holding tank.

RV and travel-trailer toilets don't use much water, and that's helpful as far as total water consumption on the homestead. (In an average suburban house, toilets, by far, consume the largest amount of water used in the home.)

Normally, what happens is that these smaller RV and trailer toilets just drop the contents of the bowl, along with very little water from the toilet itself, straight down into the holding tank. Also, one flush is usually not sufficient to send the solids to the other end of the holding tank, where the outlet is. That's okay, because the human body produces more waste in the form of water

than actual solid waste, so a day or two's use of the toilet—with the holding tank valve closed—amounts to enough liquids to do the job.

Also, usually, the holding tank holds only toilet waste. When you made your last sewer line connection, you probably noticed that the lines from the sinks and shower connect to the main waste pipe *after* the holding tank valve, allowing these smaller lines to flow freely at all times.

What all this means, is that the holding tank doesn't normally get any more water in it than what comes from you and the toilet itself (although I'm told that the tanks in some newer trailers evidently collect liquids from the sinks, also). Instead, older trailers rely on the accumulation of liquids in the holding tank to flush the solids when the holding tank valve is pulled. And it's a system that works very well indeed.

So, for this reason, I recommend leaving the trailer's whole plumbing and holding tank system intact. Use the holding tank with the valve closed, so that liquids build up with the solids. Every other day or so, simply pull the valve and send the sewage on its way. To pull that valve, of course, necessitates reaching through that small access panel in the trailer skirting you've already cut.

As an added help to the system, once a week, after emptying the tank, I pour 3 or 4 gallons of water, from a jug, down the toilet all at once and in a hurry. This helps to make sure that everything reaches the septic and the lines stay clear.

However, in extremely cold weather, you may want to leave the valve open, so that your pipes or holding tank don't freeze solid and burst. In such a case, you may want to send a gallon or two of water down the toilet at the end of the day. But the trailer skirting does wonders in keeping the plumbing warm. I only leave my valve open when the nighttime temperature will be around zero or below.

A few tips:

I recommend inserting bacteria into the tanks to get the system functioning. To start with, I put some down the clean-out of the solids tank. However, you can also simply flush this product down the toilet, or put it in your sink drain. Generally, a septic system promotes its own bacteria, but since this is a small system, I recommend adding it at regular intervals of time.

A product such as RID-X will do the job, and costs about \$8 a box at a department store. A small box should last you for many months. I add it about every ten days, about two tablespoons at a time.

In a pinch, my brother, who uses an exact same system as mine (I ought to know, because I installed it), will drop a dead mouse down into the system, outside, directly into the tanks. And yes, mice are around when you live in the country. Just get some mouse traps, or poison if you prefer, and this will keep them under control.

On a similar note: my neighbor, who used a barrel system like this for many years, later installed a full-sized regular septic system and tank. He threw in a dead rabbit that his cat had brought home to get the bacterial process started.

A septic system like this takes about two weeks to install, but beats an outhouse any day, especially the cold ones. And since going to the bathroom at night doesn't involve shoes and a flashlight, well, you know the rest....

Happy flushing.

A few important No-no's for this system:

#1: *Do not* pour *any* kitchen grease down the sink, or anywhere else, for that matter. Be very careful about this. Grease does not decompose, despite the claims on bacteria boxes. It's carried on the water and builds up in your system the same as it does when you pour it in an old jar. And that's exactly the way it will look when you have to cut your pipes apart, looking for the blockage when your pipes back up. My neighbor—the one who showed me how to make this system (and warned me about the grease)—had to do this in the dead of winter. He was so mad at his wife that he actually shot the pipe apart under his trailer. Ever see those programs on PBS about core-drilling the ice in the Antarctic? That's how the grease looked coming out of there, in cores. Knowing his septic was completely wasted, he was forced to install a new one.

After cooking, if there's not a lot of grease in the pan, I pour it right on the junk mail in the garbage can. (Yes, even out here you still get junk mail.) When you burn your trash, it goes up in smoke. If there's a lot of grease, I pour it into an old grease jar or can, which still gets burned. Then I wipe the pans out with paper towels.

#2: No antibacterial soaps for your dishes or your hands, please. You need those bacteria down there doing their job, so let's not kill them off. Besides, have you read the latest studies? They say antibacterial soaps don't do any better job than regular soaps. Use the old tried and true methods, people. They work.

#3: Reference Chapter 6, the Cistern. Don't go overboard with the occasional adding of chlorine bleach to the cistern. The idea is to kill any bacteria in the water storage tank, not the septic. In fact, after I add bleach to the cistern, two days later I add an extra helping of RID-X to the septic, just to be sure.

#4: Do not flush any feminine hygiene products, male contraceptive devices, chewing gum, dental floss, or other paper down the system (toilet paper excepted, and don't go overboard with that, either.) This is a septic system for human waste. Some kitchen waste is acceptable: a few food particles or sour milk, for instance. But NO GREASE!

There are other alternatives to this septic system, like tires stacked in a hole and so forth, but to tell you the truth, I don't think much of them. I'll put my money on a real, contained septic system any day. It's a well-proven design.

Camping Hint: For temporary stays, if you can get away with it, you can install a much smaller system made out of two 5-gallon buckets, which you can get just about anywhere. Or even one bucket, if your stay will be really short.

You would install the smaller 5-gallon system much the same as you would my larger barrel system, only everything would be on a much smaller scale. Assuming it's warm where you would be, you could place this small system much shallower.

It may even be possible to forego using a leach line, as long as you're not going to be there very long, and won't be using very much water. You could even consider using a single bucket (with no leach line), if you poked or drilled holes in it and the soil absorbs liquids quickly.

Doing it this way, that is, installing a temporary small system, you could simply pull your flexible line out when you left, throw something over the inlet hole and add some dirt on top, and then just drive away with nobody the wiser.

Probably, you could install a system like this in a few hours.

I know a man who uses this small system for short stays, and it works very well indeed. Although I've never personally tried it, he swears by it, and I believe it works. But the amount of

water you'd be using, and the soil absorption rate would be the determining factors in whether you would need a leach line or not.

Naturally, this is not something you should use in a campground or any other place where possible authorities are apt to observe it. You could be fined or given a ticket in such instances, so use discretion. If you're up in the woods, say, and can get away with using a system like this, but still don't want it to be seen, one thing you could do would be to install the system, making sure the dirt, sand or soil is leveled over the excavation. Use your holding tank valve to keep the waste in the holding tank until you are sure you're not observed. Then hook your waste line up, pull the valve, and let the waste flow into the little system. When done, unhook everything and make it appear that it's not there.

Chapter Five

Water

You will need a year-round, non-freezing, clean and free supply of water, and it must be close, or at least on your way to town.

In my case, for years I got water from the artesian wells I mentioned in the chapter on land. Occasionally, I'd get it from a neighbor who had a well, in exchange for favors done now and then. Later, when I got a job, I brought water home from work. Explaining my needs to the boss, I asked permission, and got it, to fill my barrels at work. That way everything was on the level. And, when other people asked where I got my water from, I'd laughingly tell them I had "city water."

An alternative might be actual city water, because in some towns there is a place where you can go to buy water. People put tanks in their trucks, or on a trailer, and pull under a structure that looks like an old railroad water station, including the hose hanging overhead, only without the water tank above. You simply stick the hose in your tank, drop coins into the machine, and out comes your water. But myself, I don't like paying for anything I don't have to. Besides, there wasn't such a place where I homesteaded.

Of course, if you can afford your own well, that is definitely the most desirable way to go. However, assuming you can't afford a well (and I among you,) you'll need to haul water to your homestead, unless you happen to have a stream running through your property. I say that with tongue-in-cheek, because land with streams is non-existent in the price range we are targeting. However, miracles do sometimes happen, so should you be able to get such a piece, count your blessings, for you are one of the chosen few.

Barring this, prepare to haul water.

It's not that much of a bother, and since you will have a small storage system, you will probably only have to do this once every week or so, depending on how much you can haul at one time, and how much you can store. This will also depend on how much water you use. Or in other words, how well you conserve water.

Yes, water conservation is necessary, but I really don't find it restrictive or bothersome. True, I don't wash my truck here at home, and I do laundry in town (I'm there anyway for groceries and other things), but I still take a shower, flush my toilet at every use, and do dishes every day. RV toilets, by the way, use very little water.

Pressurizing the Trailer's System

As stated in the chapter on Shelter, a travel-trailer for our purposes must already have a built-in water system in place—this is essential.

It must have a bathroom with a toilet, sink, and shower, and also a kitchen sink. It also must have an existing water storage tank inside the structure, along with a hot water heater. Now we just have to pressurize the system.

You have two choices for pressurization: a water pump or an air pump.

A 12 volt RV on-demand water pump is very good thing, but costs two or three times what an air pump does. These water pumps are available from RV dealers for about \$100, but you can get one from a mail order catalog like J.C. Whitney for considerably cheaper. Keep in mind that different pumps generate and maintain different amounts of pressure. Some come on at 20 pounds per square inch (psi) and off at 35; others come on about 13 psi and off at 18. Pumps like this usually draw somewhere between 3 to 4½ amps of electrical current. These pumps are sure nice, and water pressure is available on demand, but I initially had reservations about them, besides their cost and the amount of power they use.

Now remember that travel-trailers aren't really designed for winter living conditions. They're mostly summer vacation shelters, although we can get around that. Consequently, water pipes in travel-trailers tend to run in odd-ball, out of the way places, and during extremely cold weather (like when it's below zero outside) I have had them freeze sometimes in certain locations. Although I took care of that by exposing lines and leaving cabinet doors open at night, I wouldn't want to take a chance on a pipe bursting—especially with pressurized water behind it. Pipes that are filled with water but not pressurized don't burst when they freeze, at least that's been my experience, and I had them freeze a lot before I figured out what to do about it.

If you use a water pump, put a switch on it, and turn it off every night and every time you leave. You probably won't have to worry, except for the times you forget to switch it off.

What I used was an old style 12 volt air pump I obtained inexpensively. It has a rubber hose on it with an end piece that is threaded to screw onto an automotive tire valve stem, for inflating tires. My trailer was set up for such a pump in the outside storage compartment at the rear, and so I tried it. It worked fine.

I hooked it up to the batteries, with a switch in the line (on the bathroom wall) and it worked fine until the cold weather really set in. The pressure line ran under the trailer, and condensation in the line would freeze up—the result: no water.

So I removed it from there, and with the help of a few pipe fittings, installed it where a plug had been in the filler line above the water tank. The air valve itself is a one-way valve, otherwise water might back up into the pump. The pump itself is screwed to a board that sits on the floor right next to the water tank. No freeze-ups, and all this is hidden under one of the couches.

You can buy these emergency air pumps from Kmart or just about any big department store for about \$30 or so, sometimes half that much. They have 12 volt cigarette lighter plug-ins on them, but you simply cut that off and wire it to your switch. Be careful with these pumps; don't let them run too long. Some have up to 200 psi capacity, and you don't need anywhere near that much. Mine only puts out about 25 psi, and works just fine.

I used a regular house light switch for the pump, mounted on the bathroom wall outside of the shower curtain, yet within easy reach. You always know when the pump is running, because you can hear it operating. It's impossible to walk away and forget about it. And, I find that my water system loses pressure by itself after about 30 minutes, so I don't worry about bursting the pipes.

The Cistern

When I first got to my land, for water I used a couple of 6 gallon plastic jugs I bought from a local department store. I would fill these two at a time, and pour the water directly into my trailer's water tank, through the outside filler tube. But it got to be a pain in the neck going for

water every day. When I bought a third jug, that helped, and I could cut my trips to every other day.

Yet it became a chore to go all the time, besides the gasoline used. What I needed was to store more water on site; and also, when I went for water, to bring home more of it, less often.

So I came up with an idea for a small cistern and installed it. Here's how it works:

Get three more plastic 55 gallon barrels, a 10 foot section of 3 inch inside diameter PVC pipe (check your barrel caps first to see if this is the right size for your needs,) two 45 degree elbows, a cap, and a tube of silicone. Also buy 10 feet of 3/8 inch plastic water line, and a 12 volt submersible RV water pump (note that this is a completely different water pump than what was described in Pressurizing the System). I got mine from J.C. Whitney. This kind of pump costs about \$25, though some places charge more, and is only about 4 inches long by 1½ inches in diameter, and so it will fit easily through the existing hole in the barrel-top.

Dig a 6 foot hole under your trailer, directly under the water tank, and put a barrel in this hole. Place it so that one of the holes in the top of the drum is directly underneath where you want your water line to go up into the trailer.

Drill a 5/8 inch or bigger hole in the trailer floor for the water line and wiring.

Pipe straight up to the hole in the floor of the trailer with the PVC. This pipe should fit directly over the flange for one of the two threaded holes in the top of the barrel. You may need to file some of the flange off with a wood rasp. Make a tight fit. Now remove the pipe. Heavily silicone the flange.

Connect the wiring and water line to the pump, and lower it into the barrel. Make sure it's near the bottom. I held mine up about an inch, in case any sediment collects on the bottom of the barrel.

Now run the water line and pump wiring through the PVC and up through the hole in the trailer floor. Silicone and install the PVC pipe into place. This is somewhat difficult, and you may find that you need a small gap between the trailer and the pipe. Silicone or otherwise seal off where the pipe meets the bottom of the trailer.

Next, install the filler pipe, again using a lot of silicone. Come up with about a 1 foot piece and glue an elbow on it. Place the next straight section into the elbow, coming out far enough that your filler tube will be outside the trailer. Now is a good time to temporarily prop this pipe into place; you can use wire, tape, or whatever to hold it in place so it does not break the silicone seal where it meets the barrel. Put on the next elbow, and pipe up to however high you want it above ground level. My cap is 8 inches above ground.

You can now fill the cistern and backfill the barrel. It's important that the cistern be filled before you fill in the dirt around it, so it will expand to its full size.

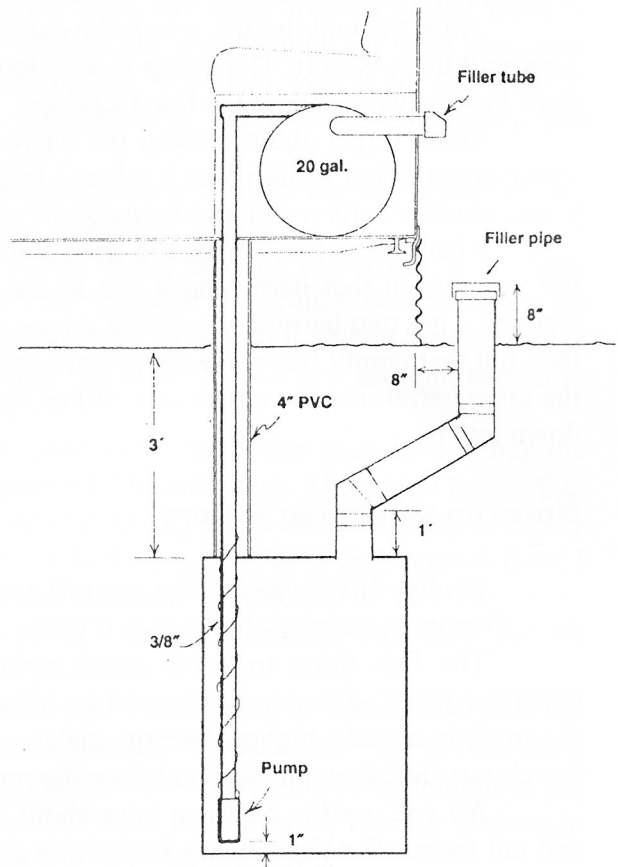

A one-barrel cistern under travel-trailer.

The next step is to make the connection of the water line to the trailer's water tank. You'll need a valve of some kind; I used a regular household type water valve, the kind with the round wheel on top that you turn.

You'll need various fittings to accomplish this, and a small hose clamp. Use whatever works easiest and best for you. My water tank already had two plugs on it, attached to piping on the top of the tank, at the opposite end from the external filler tube. I pulled one of those plugs out, installed a fitting, screwed on the valve, then used another fitting and hose clamp to attach the flexible water line to the valve. You might do it this way or some other, depending on how your water tank and piping is set up. But however you do it, you need the water to fill from the top of the tank, so you can hear how full it's getting, and also so you don't strain that little pump too hard.

Wire the pump to the switch, silicone around the lines coming through the floor, and *Presto!*

To fill the trailer's water tank, open the valve you installed, and remove the cap on the outside of the trailer—the cap on the water tank's filler tube. This cap *must* be removed during filling. Not only does it allow you to hear how full the tank is getting, but most importantly, removing the cap vents that tank and allows it to fill. This little pump doesn't have the power to fill the tank without venting—it would ineffectively be trying to pressurize the tank. And while it's a good pump, it's not strong enough for that.

You'll soon know when the tank is full, which is generally when it stops making noise—when you no longer hear the sound of falling water. But pay close attention when filling. Run the cistern pump too long and you'll hear water pouring outside the trailer from where you took the cap off. Also don't run the little pump dry, because that's very bad for it.

After the tank is full, screw the cap back on outside, and then close the valve you installed. That's all there is to it. The pump is self-draining—you'll hear it when you shut it off—and so you don't have to worry about the line freezing.

Don't forget about closing the valve. If you do forget, you'll notice when you throw your water pressurizing switch that it takes a long time to get water—if it comes at all. That's because you're inadvertently trying to pressurize the cistern along with the water tank.

I haul water one barrel at a time in the winter, and simply use a short garden hose to siphon the water from that barrel, as it sits in the back of my truck, down into the cistern. When it's warmer, I get two barrels of water at a time. In such a case, you siphon one barrel into the cistern, then put that empty barrel on the ground somewhere within hose reach of the cistern. Then siphon the other barrel into the empty one. When the cistern goes dry, you simply siphon your extra barrel down into it.

Notes on siphoning water:

Really, this is easy, folks, even if you haven't done it before. I'm serious, even a kid could do it. Gravity is mainly what makes it work.

The first thing to know about siphoning is that it *only works downhill*. Therefore, the container you're siphoning *into* must be lower than the container you're siphoning *from*. And since the truck is already higher than the cistern—or even a barrel on the ground, for the most part—there's our elevation, already built into the process.

All you need is a garden hose about 20 feet in length. If the ends are still on it, take a knife and cut them off a few inches back from the fittings. This will make it easier to work the hose. (Save these ends, because they may come in handy for something else later on.)

To begin, stick one end of the hose all the way down into the barrel on your truck. Make sure it reaches the bottom or rests on it, but does not stick square against the bottom. Otherwise, you'll only suck the hose against the bottom of the barrel and you won't get any water.

Then, take the other end of the hose and walk over to your cistern. Bend over or lean down somewhat close to the pipe and suck on the hose, then quickly shove it down into the pipe. One good suck ought to do it, and the water will then flow quickly of its own accord. The hose doesn't have to go down very far into the filler pipe, either. But the farther down you stick it, the faster the water will flow, because of the added 'drop,' or 'pull.'

All you have to do then is monitor the barrel in the truck, making sure the hose stays under the surface of the water. If air gets into the line, siphoning stops automatically and you'll have to stick the hose back under the waterline and start again. And the lower the water gets in the barrel, the harder you'll have to suck. So just watch it and make sure you get every last drop. In fact, you can even tip the barrel, towards the last, keeping the hose in the water all the while. Then, when it's done, place that empty barrel on the ground.

Now when siphoning the last barrel on the truck into the empty barrel on the ground, the 'drop' of the water is not as much as when you siphoned into the cistern. So the water will flow slower, especially towards the end. And if your truck bed doesn't sit higher than the top of the barrel on the ground (which is almost always the case), the siphoning action will cease once the water levels are the same. In such a case, you have several choices: either pour the water out of the truck barrel into something you can then dump into the ground barrel, or else raise the truck barrel by putting blocks under it, which can be pretty hard because water is heavy. You could also dig a shallow hole that your ground barrel will sit into, and that might do the trick.

Keep in mind that when siphoning, the longer the hose, the more friction on the water—meaning more suction is needed. It's best to have a hose that's just long enough for what you need. It's also best to keep very little of the hose lying on the ground. What you want is for the water to go up from the source barrel, then down into whatever it's going into. The more ups and downs you have, the less the water will flow.

Anyway, do this a few times and you'll quickly get the hang of it. Really, it's pretty simple: water flows downhill by itself. All you have to do is get it started.

Getting water from an artesian well into the barrels in the back of your truck is a simple matter. Just back up close to the well, which is a pipe sticking out of the ground with an elbow on it. Then place one jug at a time under the elbow and let the water flow into it. When the first one is full, place the next jug under the pipe and let it fill while you pour the full one into the barrels in your truck.

Some folks have tried to adopt a hose to the well pipe so that the water goes directly into the barrels, eliminating the jug-pouring process, but this generally doesn't work. The added height that the artesian well must push the water (up into the back of your truck) slows the flow down to barely a trickle. And locals don't like seeing those wells restricted, believing it reduces their natural flow. I don't know whether that's true or not, but what I do know, from experience, is that the whole process of filling those barrels is about ten times faster doing it the old fashioned way, with jugs, so that's the way I did it.

As far as water conservation on the homestead, yes, I do conserve water, but with the exception of a Navy shower, I'm not totally miserly. A cistern-full of water (one barrel) lasts me a whole week. A Navy shower, by the way, is when you turn on the water only long enough to get wet, then shut it off and soap-up. Then turn it back on and rinse yourself off. Though this might sound somewhat Spartan, it's really not and you get used to it in just a few days.

A note on water and cistern barrels:

Use only clean, chemical-free drums. DO NOT use any barrels you get from a crop-duster, factory, or any other suspicious source. While those might be fine for a septic system, you don't want to poison yourself once you've finally gotten your freedom. Search out a good source, and clean those barrels out well. Again, I used barrels that had recently contained raisin juice, and I cleaned them thoroughly.

If your water needs are greater, as in the case of more people, it might be possible to join two barrels together, although I'm not keen on the idea. In any event, I don't recommend joining them the way we joined the septic barrels. They do make smaller PVC fittings for this purpose, but they have a seal and a plastic nut that needs to be tightened from the inside. There's no way you can get into the barrel to do this, unless you cut a hole in the top and then seal it up, so you'd have to leave them off, and make your hole real tight so you could thread the fitting in, and silicone it well. In my way of thinking, the fewer holes in the cistern, the better.

If you need more storage, an easier way would be to get your hands on a bigger barrel. I later upgraded my cistern by trading an old junk car somebody gave me for a 165 gallon plastic container that had the shape of a giant, old-fashioned milk can. I simply plumbed it the same way, using the same pump, and it worked great. Another guy gave me a 200 gallon steel tank, but I haven't used it (more on a larger cistern in the mobile-home section.)

But no matter what you use for a cistern, every once in a while you should add a few drops of chlorine to the tank, to combat and kill any bacteria that might build up. The easiest way is to use plain old chlorine bleach, like Clorox, or a generic. This is quite safe, and will not affect the drinkability of your water, provided you don't put too much in. It doesn't take much: a quarter-teaspoon of bleach purifies about 500 gallons of water, so just add a few drops now and then. You'll know when it's time to do this: the water will have just the slightest odor to it. But don't add too much; you don't want to kill the bacteria in your septic system, which is where most of the water ends up.

An interesting side note on water:

A homesteading friend I met through the first edition of this book wrote to tell me about his water supply. He was fortunate enough to buy land 6 miles from a spring that sits higher than the road. After asking, he got the spring owner's consent to bury a 200 gallon tank in the little hillside above the road. The tank is now plumbed and working. To fill his truck tank, my friend just backs his truck underneath the pipe and turns on the valve. Since he plumbed the whole works with 2 inch lines, his truck tank fills in about one minute.

Chapter Six

Power

Some power is needed, and depending on your needs, there are several alternatives. Power will be used for lights, the water pressure pump, communications reception (radio and TV,) battery charging, and any other electrical needs you may have, such as a laptop computer or the like.

I'm not talking about curling irons, blow-dryers, can openers, electric motors, or electric heaters. A hand can-opener works just fine, and the others take so much energy as not to be practical. Anything that produces heat by electricity is out of the question; so are large electric motors. If you absolutely must have a toaster, get a campfire version and put it on your stove or woodstove.

There are several sources of cheaply obtained power, and a generator stands out foremost, at least at first. It's the cheapest and easiest to use, but won't last forever. Next is solar power, followed by wind generation. There still remain several others, such as water produced electricity, but that entails that ever-elusive and highly expensive stream.

Generators

Small generators are portable, easy to come by, very quiet, and only sip gasoline. I use a Honda EX650, which produces 650 watts of power. It also includes a built-in 12 volt battery charger that produces an output of 8.7 amps. Before I had solar power, I'd charge my batteries while watching the evening news on television using the 110 volt side of the generator at the same time as the batteries were charging.

I highly recommend purchasing a generator with this charging feature, since storage batteries will be used for your electricity. You'll need it for cloudy days when your solar panels aren't charging very much. Also, it can start your truck should the automotive battery fail.

My little generator runs approximately 6 hours on a half-gallon of gasoline. That's not much. But unless you watch TV all day, the generator will get most of its use when you are first setting up your homestead, running drills and other tools. Once you have solar power, the generator is only occasionally used.

Since a generator will initially be your only power source, take good care of it. Change the oil religiously, ground the unit when you're using it, and keep it stored indoors. Grounding is easily accomplished, by the way. Just stick a stiff wire into the earth where the generator will be, bend a hook or loop in the end at the right height, and attach it to the generator's grounding connection. This is usually a post on the outside of the generator that has a screw-on nut.

Solar Power

This is an excellent way to go, especially in areas that receive a lot of sunshine, such as where I live. Solar power has come a long way in the fifty years or so since this form of electricity was first introduced. Solar for other uses has been around much longer, of course, but electricity producing panels have only been in existence since 1954, or so I've read. Of course, it took much longer before they could be produced in inexpensive quantities.

Solar panels have also undergone considerable improvements over the years, and have become much more efficient as time went by. This is true even over panels produced ten or twenty years ago.

One of the great advantages of using solar panels is that there are no moving parts to wear out, and once the system is in place, you are set. Of course, you need batteries to store the electricity produced, a regulator to make charging automatic, and an inverter to convert the power into 110 volts. This system requires no weekly expenditure for fuel, no oil changes, and has the wonderful quality of starting itself at sunrise, not by you yanking on a cord. It's also very quiet and reliable, and those are things I've come to appreciate.

Solar panels (sometimes referred to as PV panels, or photovoltaic,) produce power in 12 volts DC (direct current.) And since electricity cannot be stored in 110 volts AC (alternating current,) it needs to be stored in batteries, which are also DC.

Special batteries are made just for solar systems, but they are expensive. Some people use big old telephone company batteries, some use golf cart batteries, and some use regular car batteries. However, deep cycle RV batteries work just fine, and for the amount of electricity I use, they were the best purchase. After all, this trailer is an RV; the batteries are made for exactly this purpose.

You need deep cycle batteries because you can draw them down a long way, therefore, they last longer than car batteries. They also take longer to charge, but with all-day solar charging, this is not a problem.

My solar power setup cost a total of \$692, and consists of a set of four 1'x4' panels, a regulator, four batteries, and a power inverter.

The panels were \$215 delivered, and I purchased them from Abraham Solar, 124 Creekside Place, Pagosa Springs, Colorado 81147. 1-800-222-7242 or (970) 731-4675. The man who runs that place is Mick Abraham, and I highly recommend him as a reputable dealer, no matter where you homestead. He has been in business for over twenty years, and has an incredible 100 page catalog of reasonably priced solar products that ship directly to your door. This Alternative Energy Catalog and Guide is well worth the money, as it also contains products such as refrigerators, appliances, pumps, and lights. In addition, it has useful charts and schematics, and browsing through it you'll find many ideas for setting up your homestead.

Call on the 800 number to order the catalog or merchandise. Call Mick on your own dime for questions or advice; he'll be happy to chat with you. He also has a website, which is www.abrahamsolar.com.

The panels I bought were used, but worked very well, and carried a one-year guarantee. I am still using them four years later without a single problem. As a group, these panels are rated at 17.5 volts, 87 watts, and charge at 5 amps. Mine perform better than this, due to the high altitude and direct sunshine where I live.

These panels were a bargain, and come on the market intermittently. The dealers purchased them from large solar projects throughout the nation that were either shutting down or replacing their panels. Although Abraham Solar tells me that these particular panels have since disappeared from the market, there are still plenty of other kinds to choose from. Keep up with listings in some of the rural/country/self-sufficiency publications.

I also purchased the regulator from Abraham. Those of you who read the first edition of this book will note that I first used a switch to control the charging. But human beings can be quite forgetful about switches, and leave them on or off when they shouldn't be. Either one causes a problem. Forget to turn it on, and your batteries stay low. Forget to turn it off, and your batteries

boil, ruining them and possibly causing a fire. Besides, you have to be there to throw the switch, and if you're off cutting wood, you can't leave it on.

After frying a couple of batteries, I quickly bought a regulator. It's a Trace model C30A+, costs \$67, and can handle 15 amps, which would be three sets of my panels. A regulator makes the charging completely automatic, by clicking on or off by itself when the voltage gets too high or too low. Buy one of these little units and you'll never have to worry about switches again.

For batteries, it's best to purchase them locally, as they weigh so much that it's not cost effective to ship them. I have four of the largest Marine/RV batteries that Western Auto carried. They cost \$260. These can also be purchased at K Mart or Walmart, and many auto parts stores.

Installation

Since direct sunlight produces the most power, some people mount their solar panels on a movable platform and simply push it to face the sun several times during the course of a day. That is, to the east in the morning, south at noon, and towards the west in the evening. Myself, I don't need that much power, and so elected to mount mine stationary, facing south.

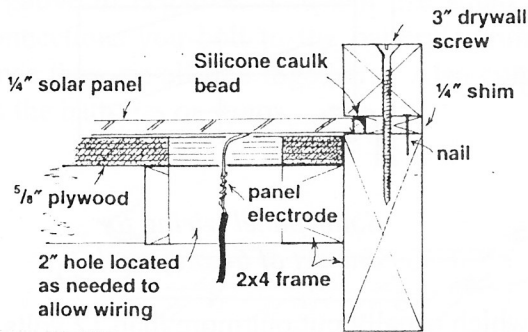

Solar panel installation at end of platform.

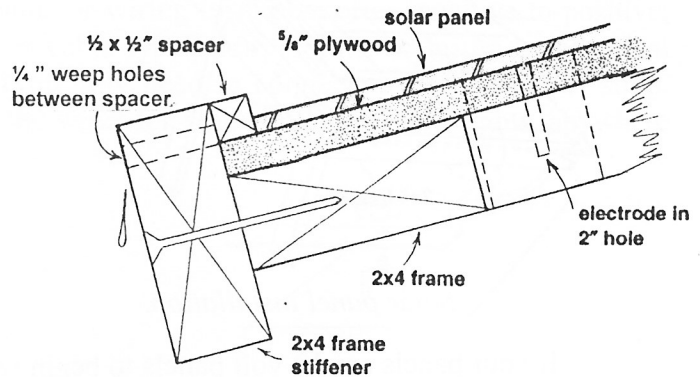

Solar panel installation and platform.

For the platform, I bought a 4'x8' sheet of exterior grade (CDX) 5/8" plywood, six 2x4x8's, a large handful of 3" drywall screws, another of 1" screws, two tubes of silicone, and a gallon of white paint, to make the platform match the color of my trailer. This material cost \$70.

I screwed 2x4's flat to the back of the platform, with the exception of the top one, which I glued and screwed to the trailer. With the help of my neighbor, I then hoisted the platform into position, screwed down through the plywood into that top 2x4, and then screwed the supporting legs to the trailer.

After adding blocks to the ends, and another 2x4 for a lip at the bottom (which also helps keep the platform from sagging,) I laid out the platform for panels.

This platform is big enough to allow for a second set of panels, if your needs increase later. The four solar panels are 11+3/4" by 47+3/4" each, and so fit handily on one side of the platform.

After measuring and marking the plywood, I used a 2" hole saw in my electric drill to cut holes for wiring. After this, I painted the entire platform with two coats of exterior house paint. Be sure to really cover the edges of the plywood, and the holes, and don't forget the underside. Unpainted plywood is extremely vulnerable to delamination by water, so paint it good.

Install your panels by laying them flat on the plywood, starting at the bottom. Bend the electrodes so they project through the holes you've drilled. I blocked up the panels $\frac{1}{2}$ " from the bottom 2x4 lip. Silicone all the way around the panel, and set the next panel into position. Do this with all four panels.

I put a $\frac{1}{4}$ " ripping on each end, the thickness of a panel, and then installed a 2"x2" on each end to hold the panels down. Don't tighten the screws down too hard, you don't want to break the glass. Silicone around the 2x2, and touch up paint.

For wiring, cut up an old extension cord, the thicker the better. If your panels are 6 volt panels like mine (yes, each panel was 6 volts, for a total of 24 volts, in theory), you want to connect these panels in series, not parallel (see diagram.) You'll hook up the positive of one panel to the negative of another, tying all four panels together, and ending up with one positive and one negative coming out of each end. These are your main power wires.

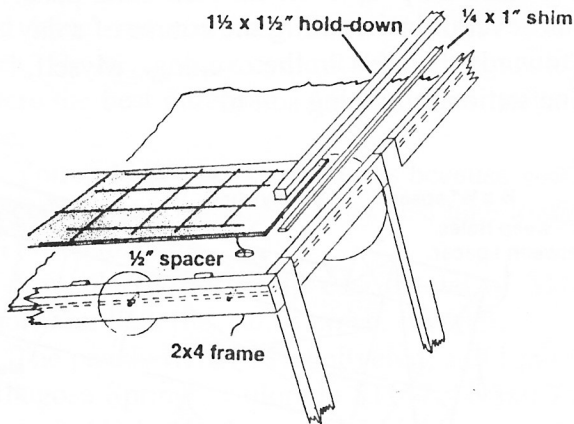

Solar panel installation.

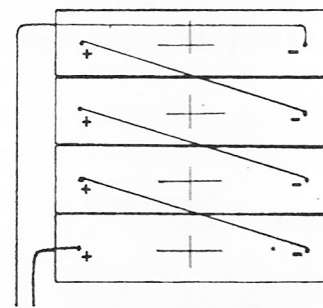

Solar panel wiring for one set of 6-volt panels.

If your panels are 12 volt panels to begin with (which usually put out more than 12 volts, by the way), you'll want to hook them up in parallel, which is positive to positive; negative to negative.

So be clear before you do any wiring which kind of panel you have and exactly how it should be wired. The last thing you want to do is fry something expensive by a simple mistake that could have been avoided.

Note: If you install more than one complete set (4) of 6 volt panels, or more than one set of 12 volt panels, you will need to wire the sets in parallel. Be clear on this. Each set of 4 panels is wired in series -- negative to positive -- with a final negative and positive wire coming out of each set. Then, to connect the sets together, wire the final negatives together, and the final positives together, in parallel. This keeps the voltage the same (not to exceed 24 volts,) but doubles the amperage output for two sets, and triples it for three sets.

There are single panels on the market that put out the same voltage as a complete set (about 24 volts.) If you use a single one of these, there's only 2 wires coming out, and they are your main power wires. Remember, these act as a complete set, and if you hook several of these together, you will need to wire them in parallel.

Regardless of the kind or number of panels you use, there is one thing you must do for all. You must ground the panels to earth. This is very important, since static electricity -- such as occurs with the approach of thunderstorms -- can completely destroy your panels if they are not grounded.

Ground and earth mean the same thing -- the ground underneath you. Don't ground to your trailer, this is not sufficient. Pound a \$5 ground rod or a 5 or 6 foot piece of concrete reinforcing bar (rebar) into the ground next to your trailer, and attach a fairly heavy wire from the main negative wire of your panels to it. This is in addition to, and separate from, your main negative power wire running into your trailer. Hook your ground wire right there at the main negative coming out of your panels. Tie it right into the negative going into the trailer.

Now then, for the wiring from your panels to the regulator, use a positive from one end of the set of panels, and the negative from the other end (the one that is tied into the ground wire.) Mount the regulator in a convenient location according to its instructions (I mounted mine inside the trailer where I could see it,) and run the wiring to it wherever it is convenient, keeping in mind that the shorter and thicker the wire is, the more voltage you get.

From the regulator, run the wiring direct to the battery compartment. I put my batteries in the storage area off the back of my trailer. It's best to keep them fairly warm, and this does it for me. Besides, that's where the wiring for the trailer's 12 volt lighting connects.

Next, hook up your batteries to each other in parallel. That is, positive to positive; negative to negative. This provides 12 volts with more amperage. You can use automotive battery cables from a department store, which I used initially, or simply make metal straps, as I did later.

Then, make the connection from the regulator wiring to the batteries, positive to positive; negative to negative. You can use small jumper cable type ends for this, or crimp-on electrical connections you bolt to the battery terminals (you only need to connect to one battery or strap, since they are all tied together.) Also connect the wires for your trailer's 12 volt lights, anywhere on the batteries or straps.

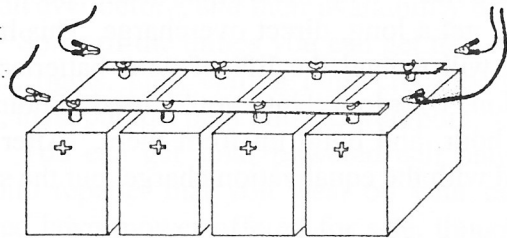

RV / Marine Deep Cycle Batteries in parallel.

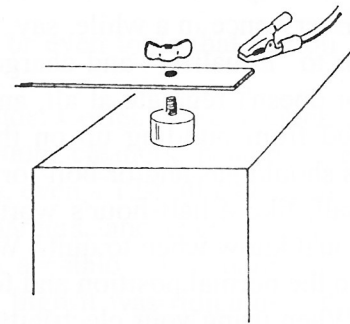

*Battery connections close up
(at first battery).*

From the batteries, run a line back into the trailer, wherever you want your main power to be. Again, the shorter and thicker the wire, the more voltage you get. At this location, install several cigarette lighter sockets from an automobile or similar. (I use the second outlet for my cellular phone.) On the back of the plugs, you'll see that the positive goes to the center of the inner socket, the negative to the outside screw-on casing. You now have a 12 volt power source in your trailer.

Get a voltmeter and install it somewhere easily seen from inside the trailer. The back wall is a good place. This meter allows you to monitor the charging and condition of your batteries. Install it "off-line." That is, don't run the plug or panel wiring through it, you'll smoke it instantly. Instead, just run a couple of little wires direct to the batteries. I bought my voltmeter at Radio Shack for \$5, but you can also take one out of an automobile dash if it's a dial and is marked with numbers. No idiot lights here.

For 110 volts AC, you need a power inverter. These are available from many sources, including truck stops, and they are getting cheaper and more powerful all the time. I bought mine from the J.C. Whitney catalog. Figure up the biggest electrical load you need to run, and buy one of the appropriate size. I got the smallest "modified sine wave" inverter they had, a Statpower PROwatt 125. It cost \$79.95, and puts out 125 watts continuous, 200 watts for 5 minutes, and a 400 watt surge. It runs my 13" color TV or word processor, no problem.

Nowadays, you can get a 300 watt continuous unit for around \$40. But regardless of what kind you get, simply plug it into one of the cigarette lighter outlets you installed.

Presto—you now have electricity!

A few notes:

Keep the solar panels clean for optimum performance. If you don't think this matters, go inside and watch the voltmeter while you have someone wave their hands over the panels.

Monitor your batteries via the voltmeter, even though they'll never overcharge if you use a regulator. By doing this, you'll understand and get used to your electrical usage, the charging trends, and the panel output in various weather conditions.

If your batteries are serviceable, check the water level every few months, and keep it up where it's supposed to be. Small bits of junk float up to the top of the water level, and if that level is down on the plates somewhere, the crud builds up between the plates and shorts them out. This is the reason many batteries fail in the first place.

Every once in a while, say, at three to four month intervals, you should set the switch on the regulator to "Equalize," and charge hell out of the batteries. With the switch in this position, the regulator doesn't regulate at all, and with full sun you get a long, direct overcharge. This helps to keep crud from building up on the lead plates, and will extend the life of your batteries. The batteries should gas and/or boil for a short time, but don't overdo it. Until you're used to doing this, start small, like a half-hour's worth. Next time, an hour, and build up from there. After a few times, you'll know when to quit. When you're finished with the equalization charge, put the switch back into the normal position and forget about it.

When using your electricity, don't drain the batteries down too far. (Your inverter will cut out when the voltage drops to 10.7 volts anyway, but I've never had this happen.) In a charged battery, the water/electrolyte solution remains like sulphuric acid, and will not freeze. In a very weak battery, the solution becomes more like water. And a drained battery in cold weather will freeze at about the same temperature as water.

This doesn't mean you can't use your power at night -- quite to the contrary. That's what it's there for. Just don't drain your batteries down to nothing. Say, if you use so much that the inverter shuts itself off, don't use the 12 volt lights much beyond that.

If, for example, you use an excessive amount of power on a cloudy day, it's best to take a break the next day, and let the batteries get topped-off. It won't take long. How will you know when they are fully charged? The regulator shuts off the charging from the solar panels.

On cloudy days, your solar panels won't put out their maximum power. At times like this, if you need to, run the generator to charge the batteries. You simply run a cord from the 12 volt outlet on the generator to the battery straps, positive to positive, negative to negative.

An interesting alternative to solar panels (but one that didn't appeal to me,) is what a man near the town of Blanca did. He bought a wrecked compact car—one that had been hit in the side and still had a good engine—and parked it behind his trailer. He hung three more alternators on it

and wired the output to his impressive collection of batteries. When the voltage got low enough, he went out and ran the car for an hour, which charged his batteries up nicely.

One time, I also saw an automotive alternator mounted on a pole, with some kind of fan blade on the front—a homemade wind generator. I don't know how well it worked, but I have my suspicions. Most wind generators I've seen are sitting idle, and not because of lack of wind—we get plenty of that. It's because they wear out quickly. Wind generators were a good idea when that's all they had, but with the advent of cheap, economical generators, and especially solar power, I think they were rendered almost obsolete. Notice I said 'almost.' Newer wind generators have come down in price and are reported to be very reliable by the few I know who have them. I may get one someday, who knows...

An alternator turned by some kind of engine might be OK, but you'd still need some kind of voltage regulator, especially with 40 or 50 amps coming out of it. I personally don't care for the idea, because what it would be is a generator. But if that's all you could do, well....

P.S.: I have heard that batteries can supposedly be reconditioned for a short time (if they're not too bad) by dumping the contents out, refilling the cells with distilled water, shaking the battery to dislodge the crud, dumping again, putting new electrolyte in, and then recharging. Whether that's true or not, I can't tell you. Maybe it works; maybe it's a vicious rumor.

At any rate, if you care for your batteries, you can expect 4 or 5 years of good service out of them. And should one ever fail, you can simply replace the bad one. More power to ya....

A few notes on 12-volt accessories:

Today, there are many more devices, small appliances, or even tools that run on 12 volts DC than ever before, and their availability has also increased.

Some of the things you can get that run on 12 volts include: Coffee makers, clocks, motion sensors, lights, fans, ceiling fans, crock pots, frying pans, vacuum cleaners, heaters, televisions, radios, toys, pumps, pool pumps, well pumps, fountains, aerators, even a 12-volt gate opener.

You can get solar powered cell phone or computer chargers, and even a solar powered mosquito repeller that you wear on your belt (\$10). Once, in a catalog, I actually saw a solar powered lawn mower offered for sale, though the price was so high it was ridiculous. Well, who wants to mow grass anyway?

Self contained solar powered outdoor lights are available. Though they don't in any way act like floodlights, they do provide light to see when you're outside at night, and mark the way. They're even pretty cheap. They act a lot like the popular low-voltage lighting people in the suburbs put out to mark their sidewalks or steps. Some of these things, especially the appliances and inverters, you can get at truck stops, stores, or out of a number of catalogues.

Chapter Seven

Heat

You'd better figure on heating with wood. Wood is the cheapest, most readily available way to heat a travel trailer or small mobile home.

Installing a wood stove in a travel trailer is not that hard to do -- it takes about two days -- and is the only way to heat and live cheaply at the same time. You'll back up your heat with propane, using the trailer's heater, but propane is expensive, and although you'll use some anyhow, you want to keep that to a minimum, especially at today's prices.

Woodstoves

My travel trailer is 8 feet by 21 feet, and my woodstove, which is the shape of a small barrel laid on end, is substantially larger than I need. It is 16 inches in diameter, and 22 inches in depth, excluding the handle. Somebody made the thing, but you would never know it because they ground the welds off and painted it nicely. I paid \$80 for the stove at a used furniture store.

Try to get a woodstove that is as air-tight as possible. They're more efficient, meaning they leak less, and use less wood. However, don't worry too much if it's not -- it doesn't take much of a fire to heat the small space we have.

You don't need to spend a lot of money on the woodstove. Don't buy a fancy, brand name, super-expensive model. And it doesn't need to be lined with firebrick—in other words, a coal burner—unless it's a thin-walled model that was made that way. You won't burn coal, anyhow, unless you live next to a coal mine. Get a woodstove used, and don't be too concerned about looks. If you want to cook on it, get one that's set up for it.

Consider the best place to put it. In my case, I removed half of a built-in couch to put it in. It's between the couch and the kitchen sink, right next to the hot water heater.

Consider how you're going to pipe it. What's the best way? Do you want to go through the roof? Or through a window? The wall?

In my case, I took out a window and replaced it with two sheets of sheet metal, one inside and one out. I had a sheet metal shop cut this for me, but you can certainly do it yourself. I simply measured the opening and had the metal cut to fit inside the aluminum jamb, against the stops. I also had the shop cut the holes for the stove pipe in it, making them just larger than the 6 inch flue.

On the floor I laid 2 inch solid cinder block, available at the lumberyard. At the back wall and the sides, I used 4 inch solid block, simply stacked up on top of each other, four courses high. If you want to get fancy, you can mortar the block, but I didn't.

Since my window is to the right of where the stove sits, I put a 45 degree elbow out the top of the stove, to direct the smoke towards the window. Next, I put a straight section with a damper in it, followed by a 90 degree elbow pointing at the window.

A straight section goes through the sheet metal, with small escutcheon (trim) plates on either side. Make it long enough to keep your flue 8 inches or so from the side of the trailer. Once outside, another 90 degree elbow turns upward, and three straight sections go up to a cap on top.

Considerations:

Put the hole for the flue in the middle of the window space. This area will get hot, and you don't want the flue too close to anything combustible. I recommend drilling some holes in the top and bottom of the inside metal window sheet so that any heat built up between the two sheets will be able to escape from that enclosed space.

Consider whether you want your pipes to slip over or into each other. Slipping over each other is the way it is usually done, and I did this when I first installed my stove. In other words, the upper pipe slips down over the lower pipe. However, this allows condensation and creosote to flow freely from the joints, making a mess all over the outside of your trailer, and sometimes inside.

Some people reverse the pipes, as I have done. This makes any liquids flow all the way back down into the stove, not staining the side of your trailer. I have read that this is the way it is done in Europe. If you do this, make sure your 45 degree elbow out of your stove is a solid piece, not adjustable. Adjustable elbows leak stinky liquids all over your stove, and generally make a mess. If you can't find a solid one, seal the joints somehow. Another possibility is to install a piece of aluminum inside the joint where the 45 meets the straight piece. Make it long enough so the liquids drip into the stove (see accompanying drawing.) Don't use a regular piece of metal, such as from skirting. I tried this, and it rusted out.

The flue must extend up beyond the top of your trailer. Tall flues work better, and you don't want any sparks falling onto your roof.

An installation like this is generally self supporting, but you will need to strap the flue to the trailer, because of wind. Use wire, metal strapping, or whatever's handy, but tie it down.

Clean the flue frequently. I do mine every couple of months, whether it needs it or not. Take it off in sections and run something through it to remove the soot. They make large wire brushes for this, with screw-on handles, but you can use a stick all by itself. Just make sure you scrape all of the inside surfaces.

The Propane Heater

All travel trailers of this size have propane heaters or furnaces. The older ones, like mine, amount to a space heater enclosed in the wall behind a grille, and this is the best kind. Mine has a Coleman wall heater built-in near the door, with a thermostat near the center of the trailer. Newer ones are required by law to be forced-air, meaning it has a blower attached. If yours does, you'll have to power the blower with your batteries, or figure out another way. As for me, I prefer the old kind. But whichever kind you have, the unit must be functional.

Frequently, older heaters like the kind I have sometimes leak fumes, and mine did, too. But you can fix this with a product called "Furnace Cement," available in most hardware stores or

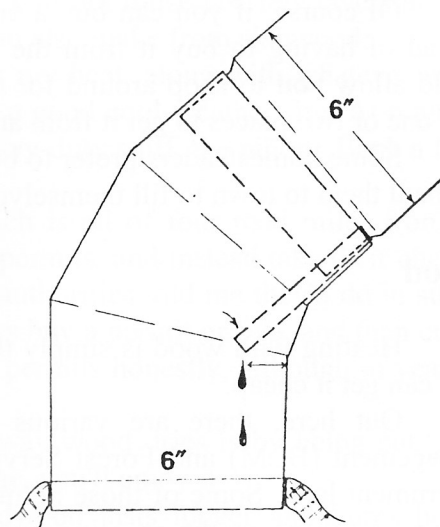

Drip trough at adjustable elbow for stove pipe.

lumberyards. It comes in small tubs about the size of a coffee cup or larger, and costs a few dollars. Furnace cement generally comes in two colors: gray or black. The gray is more like mortar, and the black is more gooey. I prefer the black, because it's easier to use and seems to hold better.

Simply open up the unit by removing the cover or covers so you can get to the actual heat box itself, and then apply the cement generously over any exposed seams. Also apply furnace cement where the exhaust vent comes out. Then let this cement dry for a full day before using the furnace, and you should be in good shape.

As far as propane itself, you might consider getting a propane tank from your local gas company. Changing little bottles all the time gets to be a chore. In winter, I found I had to fill one of the bottles every four days, so I rented a 250 gallon tank from our local farmer's cooperative. It only cost me \$4 a month for the rental. The total cost for delivery, gas line to the trailer, hookup, and 100 gallons of fuel was \$241.

Of course, if you can buy a tank real cheap, you can then get your propane from anyone, instead of having to buy it from the same company you rent from, at their price. In effect, this would allow you to shop around for the best propane price. But in small towns, there's normally only one or two places to get it from anyway, and the cost is usually comparable: high.

Some homesteaders prefer to buy one or two larger propane bottles, like the 100 pound size, and haul them to town to fill themselves.

Wood

Heating with wood is simply the best way to go, especially if you can cut it yourself, or at least can get it cheap.

Out here, there are various ways to get your wood supply. Most Bureau of Land Management (BLM) and Forest Service areas will issue you permits to cut your own wood on government land. Some of those permits are free, but that's because you generally have to drive a ways to get there, so the gasoline you'd burn is a factor. The rest of the permits are usually about \$10 a cord. (A cord, incidentally, is defined as a loosely stacked pile of wood that is 4 feet tall, 4 feet deep, and 8 feet long.)

In this area, a few large mountain ranches offer a "woodfest" every year, sometimes even twice, where you can go and cut aspen for \$5 or \$10 a truckload. Occasionally, someone will let you cut for free on their land, to clear out the dead stuff. Just ask people; this is how you find out about such things. In other words, if you find out someone has some wooded acreage, ask them if they'd like the dead stuff cut out and hauled away. Be sure and take everything you cut, too, unless the owner has agreed to let you leave the brush and smaller limbs piled up on their property somewhere. Nothing will ruin a landowner's opinion of you quicker than leaving a mess on their property. You'd never be able to go back for more, and don't forget that word travels fast in areas like this.

You can also burn slabwood, which you can get from the sawmill for \$20 or \$25 per bundle. Slabwood is the outside cuttings of logs that the mill has sawn into lumber, and a bundle normally amounts to about 3/4 of a cord. Sure, there's a few toothpicks in it, and a little bark here and there, but most of it is good stuff, with a few good, thick chunks thrown in. Sometimes, you'll even find pieces of dimensional lumber in it, which you can use around the homestead. As far as the slabs themselves, there are other uses for them, too. Some people use slabs for siding on porches or sheds, or even as fences. And the way some of these curious-looking pieces come, you could even make your own pioneer style furniture, if you'd a mind to.

The mill crew will load the slab bundle into your truck with a forklift, and the price is right, considering that on the regular firewood market, aspen goes for around \$85 a cord, and piñon about \$100 or more, depending on the time of year. Naturally, most wood costs more to buy in the fall and winter, when demand is high. Slabwood costs the same all year round.

Slabwood is usually pretty dry when you get it, and only a handful of pieces need to be split. And you can do that with an ax.

But even if it's green, the stuff ages fast in dry climates. If you've got pine or aspen, it should dry enough to where you can start burning the green stuff in about a week.

Of course, you'll need to cut the slabs for length, and this is best done while it's still in your truck, bundled and banded. Just start at one end, and cut as deep as your saw will go—it's pretty easy cutting, too. Move down the line making your incisions, then shut the saw off and clear off the cut pieces, throwing them into your woodpile. Then repeat the process until you're down to within a few inches of the truck bed with your chain. You'll want to pull out those last few layers and cut them on the tailgate—or a sawbuck, which by the way you can also make from slabwood, .

I now use a combination of slabwood and piñon for my heat, along with whatever is left over in the woodpile. The pine slabs start easily, and make a good cool-weather fire. At night, or when it's really cold, I start with slabs, and then put in the heavy-duty stuff, the piñon. Bank a fire with piñon and it lasts a long, long time.

I cut my permit-piñon over on "the mountain," which is all of four road miles from my homestead. I do know that some people don't bother buying permits, and instead take their chances on getting issued a ticket for trespassing, which is what the authorities told me they'd do in such a case, although I never heard of anyone getting caught. Others buy a permit or two, and then cut all they want by reusing the permits. Myself, I buy and use the permits honestly, although in years of cutting, I never saw a ranger up there.

Naturally, dry wood burns better than wet, and the way wood dries is by being cut, split, stacked, and aged. You just have to do it. And if you're like me, you'll enjoy it.

Hardwood burns better than softwood; that is, hardwood lasts longer and burns hotter. However, soft woods are easier to cut and split, and generally season faster.

Now here's how to tell soft woods from hard: needles or leaves. Soft woods have needles—like pine, spruce, and fir. Hard woods have leaves—such as oak, maple, and such.

There are exceptions. Piñon, which has needles, is very hard—that is, it's hard to cut and split, and takes a long time to dry. But piñon burns long and hot. Aspen, which has leaves, is soft. It's easy to split and dries quickly. But it also burns up quickly.

Chainsaws

Here's the word on chain saws: you get what you pay for. Naturally, what you pay depends on your financial condition. You can spend hundreds on a good one (like a Stihl, for example) which might last a decade, or two, or more; or you can buy a cheaper one (like a McCulloch Eager Beaver) on sale for a hundred and some, which might last a few years.

Originally, I went with the 14 inch Beaver. It's a very reliable saw, but wears out with really tough work. I saw it as a kind of disposable tool, but if you treat it well, keep it sharp, and don't cut firewood for a living, it should last you at least several years. I used to buy a new one every two or three years, when they went on sale at department stores in the fall.

Yet later on, when I could afford it, I bought a 16 inch Stihl. Yeah, it cost two and one-half times what the other one did, but it's already lasted four times as long, and I don't have to replace bars or chains near as often.

Chainsaws have 2-stroke engines, which means there's no crankcase you have to keep oil in. Instead, the saw's engine is lubricated by the oil you must put into the gasoline.

Carefully observe the amount of oil you add to the mix. You always must put in at least as much as is recommended, and shake or swirl the can to mix it well. (I also shake it before every fill-up of the saw's tank, too.) I use a 2-gallon gas can, marked 'chainsaw', and only put one gallon of gas in it. That way, it leaves room in the can for me to shake and swirl, of course, because it's kind of hard to mix it if the gas can't move around.

Normal mixture ratios are about 40:1, and you can buy little plastic oil bottles that contain the exact amount needed to mix with one gallon of gas. They're usually marked 'chain saw mixture oil' or '2 stroke oil'. They're handy, but I'd like to draw your attention to what's in them. Look on the back of the bottles. Most of them say they're made from recycled oil.

Hmmm... a thought here: where can you get recycled oil for free? How about oil changes from your car, pickup, or generator. I don't recommend using your used oil, but there are some homesteaders who do exactly that. If you are going to do it, I would remember what metal particles do to engines. At the very least, you should filter the oil through a clean rag or coffee filter. In a pinch, I have used brand new automotive oil in the mix, but make sure you get enough in, and that it's mixed well.

Incidentally, my personal preference on mixing is to use store-bought oil, and to add a little more than required. To my way of thinking, it's better to have more than not enough. So what if my saw smokes a little more?

Chains

By the way, you don't have to pay to have your chains sharpened, unless they're really damaged. It's much cheaper and quicker to do it yourself, unless, as I said, you've hit rock or metal with it and it's really trashed (in which case it definitely pays to have it done by the shop). I learned how to sharpen chains from an old logger who was kind enough to show me, and have since sharpened all my own chains. In fact, I even 'touch-up' chains between each tankfull of gas, or as needed. Sharp chains cut better, faster, and are easier on the saw.

To sharpen a chain yourself, get a round metal file of the appropriate size, wherever chain saws are sold. The smaller chains, like my Beaver or Stihl, use a 5/32 inch file, and the file doesn't need to have a handle on it. You'll also occasionally need a flat file. Sometimes these are sold in pairs as a saw sharpening kit.

Get your saw out and look at the top of the chain. There's almost always a little mark cut into the top of each tooth; this shows the correct horizontal angle your file should be held at. This is the trick.

For best results, leave the chain on the saw, wear gloves, and pull the file through each tooth; don't push it. And, as you may have learned back in the Boy Scouts, you file only "one-way." File "out," and don't drag the file back over the tooth; it wears out the file, not to mention dulling the tooth you just sharpened. It's best to sharpen all the teeth that face one way, and then sharpen the others on the other side. Pull the file through the same number of strokes on every tooth; that way, they're all the same.

You really don't have to worry too much about "letting down" the guide links in front of the teeth. (These are the vertical pieces between every tooth.) By the time you need to do this, the chances are that the chain will be shot anyhow. But if your teeth are sharp and you find that the saw is not 'biting' as it once did, take a flat file and give it a few strokes across the top of all the guide links on the chain—the same number of strokes for each link. Again, that way everything is the same. It usually doesn't take much filing there.

You can buy replacement chains at chainsaw dealers, or even some stores. Every once in a while, you can also have them made pretty cheap, if the place does that. Occasionally, some chain-makers or dealers will run chain specials at certain times of the year. Two-for-one and all that. Take advantage of it, and stock up. There's nothing worse than getting all set and driving up onto the mountain, only to shuck a broken chain and have nothing to replace it with.

Chain Bars

As far as the chain bar, keep that thing clean. Bars receive oil from a separate tank in the saw, but the oil generally flows through a small hole on the side of the bar, and if that hole is plugged up, the chain is running dry. The result is that both bar and chain will quickly wear out. I use new automotive engine oil for the bar.

Bars take a while to wear out if they're kept clean. You'll generally know when the bar is shot because the saw will start making curving cuts through a log, which naturally binds the saw. But I've also had the underside of sharp chains wear out (if they last long enough), and the result is much the same. So if your chain is old and you're getting curving cuts, try replacing the chain first. Bars cost more.

A chain saw is a marvelous tool, and I certainly hope that the man who invented it became a millionaire. But do be careful using one; read the instructions in the box. And you needn't worry about what a chain will do if it breaks—the chain will simply sling out ahead of you into a neat little pile on the ground. However, you wouldn't want it hitting anyone, so don't let anyone stand in front of your saw while you're cutting.

Wood Splitting

Splitting wood is great exercise, and it's fun, too. To split harder or thicker woods, use a sledge hammer and wedge, or else a maul, which also can be driven in with a sledge. The old double-headed axes work wonders on the soft stuff, and actually perform better than single-edged axes. Better balance, I suppose. Also, for some unknown reason, they make you feel more like a woodsman.

Anyway, there's really not much to splitting wood by hand. Do it when the wood has aged a little, and start at the center, or a crack that goes to the center. For those of you who've never done it, you'll be surprised at how easy you pick it up, and how much satisfaction it gives you. I really enjoy it, and still split all of the softer woods by hand, in spite of the fact that a friend gave me his old hydraulic splitter.

I don't know exactly why, but for me, splitting wood is kind of like hunting. Maybe it brings out some sort of long-buried instinctive response in me. Maybe it's a tie to the past, or something from previous generations. All I know is there's something about 'chopping wood' that I love. Plus, at the end of the day, it feels like I've really *done* something.

Fires

I used to use kerosene to start cold fires, because it was easy. I'd just throw a few pieces of wood into the stove and squirt a little kerosene on it. Incidentally, a plastic bottle from dish soap or pancake syrup works pretty well for this. On a cold fire, kerosene won't explode when you light it; it just flares up slowly. It doesn't take much kerosene, either. If you're going to do this, you'll soon find out how much to use.

But here's a word of caution: light only cold fires with this. If there's any red coals at all, it's best to just stir up the fire and leave the stove door open till the fire catches. Kerosene squirted on red coals will start vaporizing, and then when you light it, it will foomp! That could be a real problem. And since I got married, I decided newspaper is a safer way for her.

Some people use diesel fuel to light fires, and it acts about the same way. I used kerosene because I had it on hand anyway for my kerosene lamp. Yeah, there's just something about using a kerosene lamp. Makes you feel like it really is a hundred years ago, instead of the 21st century.

Incidentally, I don't use a grate in my wood stove. When you burn wood constantly, you have to empty the ashes weekly. The grate is just a pain in the neck at such times, and keeping logs on the coals is one way to keep them burning, especially if they're not completely dried yet. Just stir the fire up occasionally, and everything will burn completely.

Now here's something interesting. You'll soon find that a fire uses up all the fresh air, or oxygen, in a trailer. Just crack a window open to fix this. Sometimes, if it's real windy, you'll find that you may get smoke coming back out of the woodstove when the air blows from a certain direction, usually when your flue-pipe is upwind from your stove. All you have to do is open a window upstream, close the others, and that usually takes care of the problem. For this reason, I don't recommend putting plastic over the windows of the trailer. Wind can be very fickle indeed, and on different days—or even different hours of the same day—you'll need to have different windows open.

I also don't recommend covering that crank-open vent in the roof of the trailer. In such a small space, it's easy to build a fire that is too hot. Since hot air rises, opening the vent is often the quickest way to dump the hot air.

At night, or anytime you are leaving the trailer for hours at a time, turn down the stove by closing the air vents nearly all the way, and also closing the flue damper most of the way. You'll notice that this immediately makes the woodstove hotter, but this is because most of the smoke and heat is no longer going out the flue, and is effectively bottled up in the stove. However, this added heat situation is generally short-lived, and the fire goes down because of lack of air to burn, since you have closed the air vents. Because of closing the damper, most of the smoke remains within the stove, and smoke doesn't contain much oxygen.

I think you'll find that heating with wood is a fine thing to do. Besides the fact that it's easy on your pocketbook, there again is that long lost connection to times past that it seems to give you. Heck, this is the way it was done for thousands of years. Also, the physical effort required to 'bring in the wood,' so to speak, not only keeps you in shape, it keeps your waist size down.

Chapter Eight

Refrigeration

Propane is simply the best way to go on a homestead like this.

A trailer of this size generally has a small propane refrigerator installed in it as factory equipment. Many, however, no longer seem to work. That is usually not a problem, and I'll go into that below.

The propane frig in my travel-trailer had been removed by the previous owner and replaced with an apartment-sized unit, run by regular house current. That's because the man did his camping in RV parks. Though such a frig was convenient for him, it was exactly the opposite of what I needed. Naturally, my small generator wouldn't power such a frig. But even if it would, the whole scenario is impractical because I'd have had to run the generator around the clock. Remember, a generator that never stops, will, sooner or later. I'm talking about wearing it out.

So when I first came out here, I installed an icebox. It was fall, and as the cold weather progressed, I was soon able to make my own ice by setting a tray of water outside through the overnight hours. This worked fairly well for a while, but it still left me with no freezer capacity, with the exception of a camping cooler placed in the shade on the north side of my trailer. That outside cooler worked plenty good in freezing temperatures at night, but of course as soon as it started to warm up during the day, my frozen food would thaw. No good.

Next, I tried using a good-sized 12 volt cooler. Something like that is pretty good for a day's road trip in your vehicle, but sucks the living daylights out of your batteries when it's plugged into your solar power system at home. A small travel-trailer solar system like mine simply couldn't keep up with it. Besides, there was no freezer.

I had to go back to propane.

After talking with my neighbor, who uses two full-sized propane refrigerators in his mobile home, I obtained a small propane unit from another trailer. The man had tried it, and said it didn't work. But through an easy trick I learned, I was able to get it going (more on that in a minute).

For some unknown reason, people have a common misconception that propane refrigerators use a lot of propane, but I'm here to tell you that it just isn't so. Really, a propane refrigerator of this size actually uses less money to operate in warm weather than the cost of buying block ice every-other-day (to say nothing of the cost of gasoline burned to go get that ice). It also gives you a small freezer in the bargain. In my experience, propane refrigerators use even less fuel in cold weather.

Aside from the coolant itself, there are no moving parts to a propane refrigerator; it uses only a small pilot light sort of flame for operation. The unit must be vented outside, of course, but trailers of this size are generally already set up for this.

How they work:

Propane refrigerators operate on a liquid-to-gas and gas-back-to-liquid basis, the propane flame providing the heat which is the initial means of conversion.

It goes like this: the liquid refrigerant is heated by the flame. As the liquid is heated, it turns into a gas. The gas then rises by itself in the piping. As it rises, the gas cools. As it cools, it turns back into a liquid, and it is this re-conversion into liquid form that naturally produces a cold temperature. Since the pipes run through the food compartment at exactly the point where the reconversion occurs, the whole interior of the refrigerator is then cooled.

Pretty simple, huh?

A refrigerator of this type *must* be level, as the piping is designed to work by the natural rise of the gas and gravity to return. So use your level on the outside of the refrigerator, both ways (side-to-side and front-to-back).

As long as your unit is level, has refrigerant in it, and a flame, it should work. If it doesn't, what is generally wrong with it is one of two things: either the refrigerant has leaked out, which is rare, or, more likely, the refrigerant has settled from lack of use and won't perform adequately.

If the refrigerant has leaked out, you're probably out of luck, although you might be able to have the unit 'recharged' by an appliance repairman, if you're lucky enough to be able to find one who still works on propane refrigerators. However, leakage is usually not the case, so the following method of making it operable should be tried first.

Burping a Propane Refrigerator

This is the trick I mentioned, and yes, it really is called "burping." To burp a propane refrigerator, remove the unit from the trailer completely. Blow all of the gas line out, including the filter, if it has one (it looks like a small automotive gas line filter.) Then, make sure there's no soot in the flue by taking the cover off the back and pulling out the squiggly little heat baffle. You'll see what I mean when you do it.

Next, clean out the orifices in the gas burner with a small needle, pin, or something of that sort. Be careful not to 'hog-out' or enlarge the holes when you're doing this. In other words, don't make the holes in the burner any larger than they already are. If you do, the flame will be bigger and could provide too much heat. In that case, your refrigerator may over-perform, meaning that it will get so cold inside that you might not be able to keep the entire food compartment from freezing, no matter where you put the temperature setting. Propane consumption would also increase.

After you have cleaned the unit, tape-over or otherwise cover the gas line and any orifices, such as the burner. Then put the frig upside-down in the back of your truck, securely, and leave it there for several days as you go about your business. (By the way, if the unit gurgles when you turn it over, it has refrigerant in it. But you may not always hear it, so burp it anyway because you've got nothing to lose.)

Just being turned on its head for several days is usually enough to stir up the refrigerant. But in my case, I drove around with it in the back of my truck for three days, as I conducted my day-to-day affairs, believing that this would really help stir it up, which it did.

After several days, re-install the unit, checking the gas line connections for leaks. You can do this by placing or squirting a little soapy water on the connections. Then light the flame. Once the refrigerator is going, they say to give it twenty-four hours to cool enough for use. Sometimes, though, depending on the unit, it will be working just fine in six or eight hours. Incidentally, how soon the refrigerator gets cold is usually an indicator of how good it is. If it gets cold quickly, the chances are that it's an excellent unit.

This burping of the unit usually does the trick.

By stirring up the contents thus, you should have a fully functional refrigerator with a small freezer. These units actually work very well, indeed, and there isn't anything special you need to do to use them. Just make sure that the flame is lit, the unit is level, and that you keep the frig door closed as much as possible. That latter part is because propane units don't recover their cold temperatures as quickly as electric units.

Note: If the first burping doesn't make it work, try burping the unit again, especially if it has been sitting for a long period of time and hasn't been used.

If the frig still doesn't work, check the burner. Possibly, the two-stage pilot light (which is the burner) could be malfunctioning for some reason. When the burner is lit, check to be sure that it works in two stages. You do this by turning the temperature control from defrost to operation while watching the flame. The flame should rise a little when the knob is turned from the low position toward the higher or cooler setting. But the rise is very small indeed, and you sometimes have to pay very close attention to notice the difference, because it's a pretty small flame to begin with.

If a second burping didn't help and the burner is working like it's supposed to, the refrigerant has probably leaked out at some point in time. This is a real problem, because if there's a leak, the leak itself must be repaired before the unit could be recharged. Don't try fixing the leak yourself by brazing it or welding it closed—not that you have this kind of equipment on your homestead, anyway. But if you take the unit to Joe Fix-it and try to weld the leak while the rest of the system is still sealed, I was told that the piping will explode from the heat and pressure. Of course, there is always a point somewhere in the piping on the back of the unit where it was charged to begin with, and this is usually located near what appears to be a small tank or expansion chamber. But if you open up that point and then put a torch or welder to the leak, you still could be covered with whatever liquid is still in the unit. And some of it might be hot from the torch.

Instead, if you can find somebody that knows what he's doing, like a refrigerator man who still works on these things, have him fix the leak and recharge it, if the cost is reasonable. If you can't find someone or it costs too much, the unit is pretty well good only for parts, and you may as well start looking for another one. Keep the old one, though, because sooner or later either you or somebody else might need parts, and you'll have them.

An interesting note: the area I live in is windy at times, and I found that a strong, sustained wind affected the operation of my frig—it started defrosting because the wind was blowing the heat of the flame away. I closed up one side of the vent on top of the trailer—the side facing the prevailing wind—and partially covered the air intake on the side of the trailer. That took care of the problem.

Here's an ironclad piece of knowledge: if you suddenly smell ammonia one day, you've got a leak in your frig. That's exactly what the refrigerant smells like, because that's part of what's in it. This happened to me, and when I took the unit out, I found a pinhole in a straight section of pipe on the back. At the time, I just bought another unit and that was that. But thinking about it now, if I had it to do over again I think I'd first try putting something over the hole and securing it with a small hose clamp. Maybe it would work; maybe it wouldn't. Possibly, it could depend on how much coolant had leaked out. I have no way of knowing, but it might be worth a try.

Chapter Nine

Mobile Homesteading

All of the technology that was used with the travel-trailer in the preceding chapters can also be applied to a mobile home, and I have done this, as have a number of other people. Really, there's not a whole lot of difference between the two, except for the size of the home and its consumption of materials. In fact, you could even set up a cabin or small house this way, and some have done so.

Just like a travel-trailer, a mobile home also comes on wheels, only usually there's considerably more of them. But you still set it up on blocks in the same way, and the skirting for the unit is the same. It uses the same exact septic system, and water still comes from a cistern. The home is still powered by solar, and again mainly heated by wood. Propane still heats the water, cooks and cools the food, and provides backup heat for the really cold times.

Yes, you have a lot more room with a mobile home, but it does come with a price. That price is the higher cost of the unit itself, and also the cost for additional materials needed like skirting, wiring, piping, and heat.

The reasons I decided to upgrade to a mobile home are these: My income rose, and so I wanted to upgrade my lifestyle. My writing also expanded, and so I wanted a separate study in which to work. I also figured to make this my last home for a while, and so while I continued to work, I wanted to put in everything I wanted before I retired to writing.

Mobile Home Set-up

Since the requirements for land are the same, I'll go right into the shelter itself.

If you can get a mobile home cheap, the costs of setting up a homestead are relatively the same. And while it sometimes can be done for the same cost, you don't usually find these bargains just anywhere.

For example, my brother, who mobile homesteaded for about \$2,500, bought his older 10 foot by 40 foot mobile home for \$800. I moved it onto his land with my $\frac{3}{4}$ ton pickup truck.

Another guy I know paid \$1200 for an older mobile home, then sold the furnace out of it for about \$400 to recoup a third of his cost.

I paid a lot more for my mobile home (too much, really, but I liked it), and kept the furnace in place (which I recommend).

You'll have to carefully consider the moving and setup of a mobile home. Does it have axles under it, and do those axles stay with it? Or does the person or company want the axles back? (It's common for them to remove the axles after the trailer is set.) Are the tires in good enough shape for the move?

Is the mobile home small enough that you'll be able to pull it with a pickup, or is a special truck needed?

Is a permit required to move the mobile home, and do you really need to get one?

If you can get the owner to throw in the moving and setup (on blocks) of the home with the purchase, like I did, that's even better. Remember, everything is negotiable.

Assuming you have it delivered, you'll definitely want to be there when they bring in your new home. Don't ever take it for granted that if you're gone when they bring it, they'll put it exactly where you told them to. If you do, you might come home and find it sitting backwards, sideways, or not at all where you wanted it. And once they're gone, you'd play hell getting them back to move it again—at your cost. So be there, and don't be shy about giving specific orders. "Straighten it out; okay, move it a little more to the left," and so forth are perfectly acceptable directions to give a driver in such a case. It's your home, after all. You paid for it, and you have to live in it.

But however you do it, before you bring the trailer onto the property, be sure and clean off the spot where it will sit. Use a shovel, rake, hoe, or whatever you need. Take my word on this: I guarantee you that you'll be crawling around under that trailer for setup and skirting, not to mention any improvements or repairs. The last thing you want is cactus stickers in your backside.

It's not necessary to pull the mobile home's tires up onto boards. In fact, you may even want to dig some small holes for the tires, depending on how high the trailer sits. Give consideration to this, according to how you will skirt it.

Think about whether you want to tie your mobile home down or not. Just how windy is your new place, and is it subject to tornadoes or strong storms?

If you do want to tie yours down, the first thing you have to find out is where the straps are on the trailer. Some trailers have the straps connected to the framing near the outside edges of the frame; others have the straps on the main beam frame itself. Look at the trailer and find out where yours are, and then, once the trailer is in place, dig and pour concrete pits with a bent rebar or something in the top of them so you can fasten those straps. If your trailer doesn't have any straps, you could always get some and attach them wherever you wanted to.

An alternative is to buy tie-downs that screw into the ground. They're pretty hard to get in by hand (with a special tool that acts as a big lever), although the gasoline-powered device for screwing them in isn't any picnic, either (although it's faster, but you have to consider the drive to get and return the device).

In my case, I elected not to tie it down, since it wasn't facing the prevailing winds. Later, when I had it insured, they asked me if it was tied down, and I told them the truth: that it was not. It didn't matter, they said, they just needed to note it on their paperwork, which they did.

If you set up the mobile home yourself, I'd recommend using concrete blocks, as piers, to support it. These blocks are available at any lumberyard, or around many old farms and such (ask first). The spacing depends on the size of the trailer. 10 feet is good, but I'd go no more than about 12 feet or so apart on each pier.

You'll need a good-sized hydraulic bottle jack and a good level to do this yourself. And I do mean a good level. Don't use some old beat-up thing, or a cheap aluminum handyman special, unless that's all you can lay your hands on. If you can, buy a good wooden level, if you don't already have one. One that does *not* have adjustable vials. Adjustable levels are generally cheap and crappy (I'm a professional carpenter, so I can say that), and sooner or later the vials will move on you, meaning that all of your readings, and your house, will be off. Get a good level with the vials fixed in position. The caveat here is that you can't bang any level around. Try not to drop it, and take good care of it. They're not pry bars or hammers.

Wood wedges will come in handy on top of the concrete blocks for smaller adjustments. Start with a couple of flat blocks on the ground, 2 or 3 inches thick, and put your concrete blocks on top of them, on edge, not on end. This means the two hollows in the blocks will go straight up, just like they're used in buildings. Don't put the blocks any other way; this is the only way they have any strength. Sideways, they'll crumble, and you'll be doing this all over again.

Use your level on the trailer frame, starting at one place that's already close to where it should be. This could be near the tires or near the tongue. Generally, any other place is sagging at this point, and is lower than the others. I crank the tongue lift up to where I want it and use that end as a starting point.

There will be two main beams under the trailer, running the length of the unit. Start at whatever starting point you've chosen (reference the above) and level across side-to-side from one beam to the other. Whichever side is higher, use that for your beginning and stack a block "pier" under that beam. Then level across to the other beam, jack it up, and stack another pier under that. Mortar is not generally used in these stacks; the weight would only mash it out anyway.

Note: Since your level won't usually reach all the way across from one main beam to the other, use a straight piece of lumber like a 2x4 for a straight edge, and put your level against this, in the *middle* of the board, not to one side of the board. This is because all solid dimensional lumber has a 'crown' in it, and if you stick the level to one side and read it from there, your reading will actually be off, due to this crown. Just pick up the end of any old 2x4 and look down it to see what I mean. (Some wood is also twisted or warped, in addition to having a crown.) Anyway, mark the crown with a pencil or scratch or something, so you'll put your level in the same spot, and use it the same way, every time.

Once you've got the end of the mobile home level, start moving down the run by placing the level on the underside of the beams, first one, then the other. Determine what needs to be jacked up to where, and stack those block piers under them again. Move on, from time to time checking across to the other beam with the level and straight edge. Make adjustments as necessary. (Boy, that sounds like a recipe, doesn't it? "Season to taste.")

One place you will most likely want an additional pier is near your front door, and possibly any other outside door. This pier will be out near the outside edge of the trailer, not under the main beams. You could put it under the hinge side of the door frame, or one on each side. These piers will help keep your outside doors swinging freely. But also don't be surprised later to find that after the home has settled for a while, you'll have to make an adjustment at your door piers. You'll know when you need to make an adjustment because the door will start sticking. In my climate, this was a once-a-year thing on the front door. The other outside doors did fine year-round.

Some alternatives to concrete or cinder blocks include larger sections of tree trunks. You know the kind: the kind you use to set wood on when you chop fire-sized pieces by hand; or the kind you keep around to sit on outside by a campfire. They actually work pretty well for this, as long as they're pretty close to the right length. I set up my brother's trailer using these, and some pieces of 2x4 blocks and wedges, and they're still holding just fine. Longer pieces can either be cut down with a chainsaw, or else 'lowered' by digging out the ground a little where they'll be placed.

Skirting

The mobile home is skirted in the same fashion as a travel-trailer, although it naturally takes more material. If your home sits up higher than the width of one piece of skirting laid on its side, you may want to turn the skirting on end. There is usually a metal lip at the bottom of the trailer's siding that the skirting slides under, and you can screw through this lip, through the skirting, and into the wood side joist of the floor (which is usually a 2x6 or 2x8).

You'll still need the 1x4's or 2x4's at the seams, and don't forget access panels wherever you'll need or want them. In my case, I made a couple of large access panels so I could slide seasonal or unused items underneath the trailer for storage. Like a log splitter, for instance.

Now here is something I did on the mobile home that I didn't do on the travel-trailer. If you can swing the cost (it's expensive if you have to buy it), I recommend insulating right up against the inside of the skirting with those blue styrofoam sheets of insulation you see on construction sites (they use them to insulate foundations). Doing so will definitely help to keep your floor, and hence your feet, warmer. I was able to get all of my insulation for free, so I naturally used it. And a word to the wise: while you're under the trailer doing that, put some mouse poison like Bar Bait in a few locations, just for good measure. You can get that solid poison at any farm supply store, and it works great. It is better, and generally cheaper, than those granules people sometimes use in their houses. It lasts longer, too.

The Septic System

I used the existing barrel septic system that I already had in place for the travel-trailer, and simply tied into it.

I did this by capping off the travel-trailer line and trenching a new line (with a shovel) to my mobile home, observing the same 1/4" slope per foot. Since my new line came in at an angle to the septic (because the mobile home was in a different location than the travel-trailer), I ended up cutting a new hole into the first barrel (the solids barrel) and silconing it in place, just like I had with the original line. Yeah, cutting into the septic barrel was a smelly job, but it wasn't as bad as you might think, and only assured me that the system was working properly.

The mobile home uses standard 4 inch sewer line, so no adapter was needed to make the connection from the mobile home's plumbing to the new line to the septic. I still pour bacteria down the toilet regularly, just like before, and I've had absolutely no problems with the system whatsoever.

Water

For the mobile home, I first installed a barrel cistern. Yet since the mobile home had a regular household toilet installed, it quickly became apparent that more water storage would be needed.

So next I put in a cistern that was three times larger, almost right next to the first barrel (and I capped the smaller barrel off). I had bartered for a 165 gallon container, which looked almost exactly like an old time milk jug, only it was made of plastic or something. I dug a new hole for it and buried it outside the 'footprint' of the mobile home, near the drive, there being no reason to sink it under the home.

I basically piped this larger barrel the same as the smaller one, except that, as I have said, the new jug-barrel was located outside of the trailer's skirting. As a result, I sloped the line uphill to the home, not straight up inside such as I did with the travel-trailer. The same little cistern pump was used, and I of course put a switch on it inside the home.

Then, inside the house, I furthered my water storage by placing two plastic 55 gallon barrels side-by-side where the washer and dryer would normally sit. This is because the cold water hookup for the washer is what I used to pressurize the trailer's water system. The barrels sit on a piece of 1 inch plywood which was laid over the floor. In turn, those particular floor joists rest on one of the main frame beams, which in turn sits over a block pier at that location. (As you can see, taking a little time to plan piers will be well worth it.)

Between the barrels, I ran a siphon hose, so that the water level in both barrels remained the same as long as the siphoning action didn't break from running the barrels dry and thereby getting air in the siphon line. In effect, I increased my water storage by another 110 gallons, and had a ready supply to use.

From near the bottom of one of the barrels, I ran 1/2" PVC pipe up to an RV water pump, mounted on a shelf that I built specifically for that purpose. From this pump, which is wired to the batteries above it, I got a connector hose from the hardware store and hooked it up to the cold water line at the washing machine hook-up. At the time, I wasn't sure it would pressurize the whole house correctly, but in fact it did exactly that.

A few years later, I purchased a 1,650 gallon poly water tank at a local farm supply store. The thing was huge, and they had to use a forklift to place it onto the bed of my truck (no way would it fit inside the bed). After roping the thing securely in place, I carefully hauled it home on the back roads. Next day, I paid an excavating company to bring a trackhoe out and dig a big hole in front of the trailer where I wanted the new cistern to be. The machine operator then held that big bucket over my truck and I roped the tank to it. He lifted the tank up, drove it over to the hole, and set the tank down inside for me. (Then, before he left, I also had him drive around to the back of the home and dig me a big hole that I used for dumping my burn barrels and other junk into.)

Since this new tank had an undesired opening near the bottom on one side (the opening was threaded, and had a threaded plug in it), I pulled the plug out, siliconed the heck out of the threads, and screwed it back in, which sealed off the bottom of the tank. Then, in simple terms, I piped the new tank in similar fashion to the previous two cisterns I'd used, incorporating the same little water pump inside a PVC sleeve line.

In detailed terms, it went like this:

First, I took the tank's large main cap off and cut a hole in it with a jig saw. I made the hole the right size for a 4 inch PVC pipe to go through. Then I siliconed the main cap and put it back in place. (Note that I cut the hole while the cap was off the tank. You don't want to have a bunch of plastic pipe shavings down there plugging up the pump and ruining it.)

Then, with the cap back in place, I measured down through the hole to the bottom of the tank, and cut the pipe about one foot longer, because it would have to stick up through the cap. This main pipe would serve as a filler pipe for the cistern, and also to house the pump, water line, and electrical wires to the pump. I made it so the pipe rested on the bottom of the tank. Since the pump would be inside this pipe, I drilled lots of holes through the sides of the pipe where it would be underwater, so that the water will always flow to the pump (see diagram).

Next, I cleaned the shavings from those drilled holes, pushed the pipe down into place, and siliconed around the penetration where it went through the big cap. Then I glued a "Y" fitting on top of the 4 inch line. Note that this "Y" had a 4 inch main part, but elbowed in a 2 inch line. The elbow had a gentle curve to it.

It was at this point that I fed the pump and its lines through the 2 inch elbow and down the 4 inch filler line. Though the pump has some small tabs on the bottom of it to keep it from resting directly on the bottom of the tank, I elected to hold the pump up a couple of inches from the bottom, so the pump would avoid any eventual build-up of sediment. I did this by wrapping tape around the pump line and wires, and taping it out the top of the 4 inch line. (Note that I had already measured the distance I would need to run the new pump line and wires, and already had these lengths attached to the pump.)

The new 2 inch line to the trailer now must run uphill towards the trailer, to wherever you have determined it should enter the trailer. Use straight sections and elbows to accomplish this, but

make sure the whole thing drains back to the tank, allowing some wiggle room for the pump line, in case any of it doesn't lie flat on the bottom of the sleeve pipe. In other words, slope it well. Though this particular pump is self-draining, you need the whole line to drain. *An important note here is to remember to feed the pump line and electrical wires through each section of pipe as you go, before you connect them. You can't get them through later.*

Under the mobile home, I used an elbow to turn the whole line upwards to the floor, and then make the penetration through the trailer's underfloor covering, and the floor above it. I did this by using an extension on a paddle bit and drilling through the bottom material first, and then through the floor from the underside. When it poked through, I left the drill and bit in place, went above, and made sure the hole was in a good spot. Using a jigsaw, I then cut the hole, went underneath and shoved the pump line and electrical wires through the hole. Then I put a piece of the PVC sleeve pipe through the hole (and of course around the line and wires, and it also stuck up as high as the existing barrels sat). Then I went underneath, glued the connection and stuck it together. Where the pipe went through the floor, I put silicone around it.

All I had to do then was cut the pump line for length, send it over into one of the barrels, and hook up the electrical wires to a switch and the batteries.

Then I started hauling water home in the tank I had for my truck, 250 gallons at a time. (I put a ball valve on the outlet, and fittings on, so a regular old garden hose would screw onto it. To fill the cistern, I stuck the hose down the filler tube, pulled the valve, and forgot about it.)

Gradually, as the water level rose in the cistern, I'd backfill dirt around the cistern by hand with a shovel. It took me a number of trips to fill the cistern (one 250 gallon tank every workday, so it took an substantial amount of days to fill the cistern.)

Then, stupidly, when the cistern was full and the sides were backfilled, I spread straw over the top of the cistern tank, and placed a shallow amount of loose fill dirt on top. It lasted only a little while before the top caved-in under a heavy snow, but cave-in it eventually did—so learn from me and *don't do that*. Instead, build some kind of cover overtop the cistern that will keep all weight off the top of the tank. It's what I desired to do in the first place, but didn't have the money or materials for. I should have just left the top open until I earned enough to do it right.

But guess what? Surprisingly, by keeping the cistern at a decent level for some time after the cave-in, the tank-top only settled into a reverse (or concave) position and stopped, allowing the unfettered use of the cistern from then on. I did mark the outline of the tank on the ground with rocks so that nobody would walk or drive on it.

You might say I was thrilled to have such increased water storage, and I definitely was. Water then was usually brought home every workday for a week, after which I could ignore that detail for the rest of the month.

The cost for my big cistern setup was about \$750. The majority of the cost was the cistern tank itself, which was \$450 on sale at the farm supply store. That same store is also where I bought the truck tank for about \$150. The excavator was a real bargain at \$125, because it was during their slow time of the year and he needed something to do. I might mention that they also charge you for the time of their trip out and back to the shop.

Hot Water

The hot water heater in the mobile home was actually a natural gas model, but I had gotten my hands on a used propane model through bartering, and so swapped-out the two. Then I had lots of hot water at the turn of a faucet.

I might add that Navy showers quickly became a thing of the past, as I considered a long hot shower to be one of my few luxuries on the homestead. By this time, I had just turned 40, and having a bad back anyway from my many years in construction, a good hot shower helped to unlock my stiff back in the morning. However, I did install a water-saving shower head.

I did allow my water usage to rise, and it rose anyway since the trailer had a regular toilet in it, so I bought that water hauling tank for my truck as a convenience. I had thoughts about draining the roof of the home into the cistern during the so-called rainy season, but later met a man with a drilling rig. The well was to have been installed the following spring, but other things happened and I just never got around it. Of course, it would have taken a bigger generator to power the well pump.

Nowadays, though, if you have the money, you can get a solar-powered well pump that works slowly, but fills a hundred or so gallons per day into something else—like a cistern, for instance. That would be great for a homesteader with cash, wouldn't it?

Power

Electrical power for a mobile home is the same as for a travel-trailer: solar panels backed up by a generator.

What I did was to build a new platform for my existing solar panels, and then attach the new platform to the south side of the mobile home at a location near where the batteries would be. Although I thought about building a turnable platform for the panels, I decided instead to just go ahead and fix the stationary one in place. Then, on the roof, I added another smaller platform of panels that faced east to catch the rising sun.

Inside, I installed a heavy-duty battery platform above the water barrels in the kitchen, and this is where my batteries sit. This is my power center, where the regulator and inverter are mounted. I also mounted the switches for the pressure pump, cistern pump, and solar panels at that location. Around the corner, the platform's supporting sidewall holds my voltmeter and telephone.

And speaking of telephones, for a while I had a new wireless phone service that utilized my existing cell phone. There were no air time charges, and it cost and worked the same as a regular phone. The service required an \$85 antenna and a \$5 reprogramming of the phone itself, but was really worth it and I was well-pleased. They told me I could even get the Internet on it by a modem, although it would be somewhat slow. Being an off-the-grid kind of guy, however, I had no desire to cruise the Web back then. (I have since changed my mind on that.)

However, that service was later terminated because there weren't enough subscribers—or so the phone company said. What with everybody getting cheap little cell phones, I guess there simply wasn't a need for that kind of service any longer. Too bad. I thought it was great.

But back to electricity. From the inverter, I ran regular house electrical wire (Romex) under or inside the house to the various rooms for lights, outlets, and other things. I simply put a plug end on the beginning of the main line, so that it plugs into the inverter. In the various rooms I have outlets, switches, and 120 volt fluorescent lights.

Yes, I use more power in the mobile home, but with the addition of a another set of solar panels and a bulldozer battery, electricity is no problem. Later, a man gave me some slightly-used and quite large set of batteries that had previously provided backup power for a huge fixed radio flight navigation transmitter (a VOR, for you aviation buffs). With a little modification, they really upped my battery storage capacity.

I still use the same little generator for battery charging on cloudy days. It sits out back, and fixed wires run through the wall to the batteries. All I do is hook it up and start it up. Really, though, with more solar panels, I hardly use the little generator anymore.

Heat

Heat is the same, a woodstove backed up by propane.

There are some special considerations to think of, however. For instance, if your mobile home will be insured, you'll need to check with the insurance company *before* you install it. Some companies flat-out prohibit woodstoves. Others have special distance-from-combustibles requirements (normally this is three feet from any combustible surface, but a non-combustible shield, like brick or mineral board made for the purpose, will allow for less clearance. Again, check with them beforehand.) Incidentally, most insurance companies will either insist on photographs of the installation from you, or they'll come out and take pictures themselves.

In a mobile home, you have much more room for the woodstove, so install it right. Don't just carve a hole in the wall or go through the window. Buy a regular chimney kit (available at hardware, farm stores, or lumberyards) and make the pipe go straight up through the roof. Directions are included with the materials, and make sure you do it correctly—improper woodstove installations are the leading cause of fires in mobile homes.

For a mobile home, get the best woodstove you can afford. The better the stove, the less wood you'll use, and the more heat you'll get. In my case, somebody gave me an old Ashley brand, and it works great. However, I use nearly three times more wood than I did in the travel-trailer. Do I mind? No.

Incidentally, if you have a woodstove with broken or missing firebricks in it, not to worry. You can get new firebrick at the lumberyard for about \$1.25 each. Installation is quite easy. Unbolt the retaining iron straps, clean out all remaining pieces, put the new brick into place, and re-bolt the retainers. You must use real firebrick, since any other kind of brick will disintegrate from the heat.

You'll need to trench in a new gas line from your propane tank and connect the trailer, but this is easily done, and seldom requires more than one adapter fitting. Be sure to check out your new connections for leaks—and all lines in the mobile home besides—by using a spray bottle mixture of soapy water on all tee's, unions, and connections. Be safe, not sorry.

For cooking, I had to replace the existing orifices on the natural gas stove, which changed it back over to propane. These were cheap at a supply store, and took about a half-hour to replace.

For backup heat, I installed a propane space heater in the hallway by the bathroom. This is good for when you are away, and also so you don't have to get up in the middle of the night to stoke the woodstove. Again, check with your insurance company and install it right.

Before I insulated my skirting, I found the need to run the furnace to unfreeze water pipes on minus 10 degree mornings. This was easily accomplished by running regular housing electrical wire (Romex) from the furnace to the outside. From there, I ran it along the trailer to the front steps. There, I put a plug end on the line so I could simply plug it into the generator. The little Honda *will* run the furnace's blower motor, but it's a chore for it. So I sometimes had to remove the front cover of the furnace and give the 'squirrel cage' a spin by hand to get it moving. Additionally, I yanked out the short floor ducts that connected the heating vents from the main heat run, and covered over the vents, so the heat would flow between the floor and the trailer's bottom insulation (not the skirting) where the water pipes run. This unthaws those pipes in a hurry.

Refrigeration

There's still only one way to go: propane. But since you have more room, you can choose between a camper type or a full-sized unit. I have used both in my mobile home, and prefer the larger kind. These are even harder to come by, however, and sometimes cost considerably more.

You can buy a new full-sized unit from a propane dealer or catalog for about \$1,300, or use a small one, like I did, until a larger used one came along. I got an old Servel for \$200, and had to spend a whole day cleaning the soot out of the burner and getting it into shape, but am very pleased with the results.

One homesteader I know placed a "wanted" ad in his local paper for a propane refrigerator. A man replied after several days, saying the homesteader could come and get *two* of them, free for the hauling. And they both worked.

Chances are, you'll have to tee into your propane stove line and run $\frac{1}{4}$ inch copper gas line to the refrigerator. This copper line is easily bendable, so as to keep the line hidden away in cabinets. But like any other soft copper line, make your bends gradual, or else you'll kink it. Once you kink it, that length is done for, so be careful. Anyway, measure up the distance you'll need, and have the lumberyard or store cut the line for length, flare the ends, and give you the appropriate fittings. Put a valve somewhere in this line so you can leave the other appliances in your home lit if you need to 'burp' the frig at some later date.

Burping a full-sized unit is accomplished by disconnecting and simply turning the unit upside-down for a week. Due to the size of a full-sized unit, you don't want to haul it around in your truck unless it's absolutely necessary. When you see how heavy these things are, you'll know why. Too, most of the older units also have round tops, making this impractical. If yours has a round top and you can't prop it up into place, try laying it on one side for a week, then turning it over to the other.

Before you use a propane frig that you are bringing into your home, I recommend burping the unit, and a thorough cleaning of the vent, flue, and burner box, including the squiggly little heat baffle (mine was completely sooted up.) That way, you won't have to do this for a few years.

To light the burner on a full-sized unit, it helps to warm up the inside of the burner box with a hand-held propane torch. Direct the flame into the heat-pipe for several minutes, and then light the burner. The flame should be sucked into the burner box fairly quickly. If it's not, you probably have a blockage (like soot) somewhere that must be removed. (That's why you should clean it all out first.) You will be surprised at how well these old units work. I even have ice cream in my freezer.

As I said, mobile homesteading comes with a price, and I was willing to pay it. But naturally, like any person, I sometimes doubted my decision. I really enjoyed the extra room—especially having a full-sized study to write in—and also having a regular "home." But as a result, my taxes went up some, I put more time and money into maintenance, and cleaning the house took much longer. It also takes three times the wood to heat, and uses more propane and water.

Like I said, it was worth it to me, but I sometimes reminisce about living in the travel-trailer, and the good times I had in it. Here are some of the projects I have planned for the future:

An outside air supply for the woodstove. What I'll do is run about a 4 inch duct from outside of the trailer to the air intake on my woodstove. This way, I won't have to leave a window open for an air supply, which will be appreciated when it's really cold and windy outside.

A well, which shouldn't cost me more than about \$500, since someone offered to let me use their small drilling rig.

A washing machine, which of course will have to be powered by a larger generator. I'll pipe a separate drain for this, which will lead to a water dispersion pit outside, so all of that used water doesn't have to run through the septic system. The dispersion pit can be made out of a plastic barrel with holes in it, surrounded by gravel and covered up.

A solar hot tub. Can you imagine that? A homesteading friend of mine made one of these, and has given me a solar hot water panel just for this. (Hot tub information follows in this edition.)

A solar hot water system. This is so I don't have to burn up expensive propane to heat water. But some kinds will only work when the temperature is above freezing. Yet I'll find a way.

A solar oven for cooking. The one that interests me the most is the Kerr-Cole Solar Wall Oven, which is a patented unit that can be built from purchased plans. Search at www.dirtcheapbuilder.com or www.solarcooking.org. These units look extremely desirable to me, and should work wonders in areas that receive a lot of sunshine, like where I live. Considering the cost of propane, why not get as much as we can out of the sun? Dirt Cheap Builder, by the way, is a good source for books, videos, and the like about subjects that its name implies.

A wood-fired hot water heater for when it's freezing outside.

A garage and a pole barn.

And finally, an early but working retirement. I have several other books started that I want to finish. I also want to publish them myself, and start my own homesteading press. That shouldn't be any great shakes, and I'm already working on several other book ideas.

Chapter Ten

The Hot Tub According To Bob

(As featured in "Backwoods Home Magazine," January/February 1998 issue)

Oftentimes I've visited friends in the city who had a hot tub, and considered it to be the only drawback to homesteading—not having one, that is. I'd wracked my brains trying to figure out how to build one, but still kept coming up against the inevitable: how to heat and move the water without having a big, noisy generator running all the time. There didn't seem to be a solution, but guess what? A fellow homesteader and friend by the name of Bob Herman came up with a great idea for a hot tub, and here's what makes it work: a tub, solar water-heating panel, some pipe, and water. Sounds pretty simple, huh? It is, and I can't believe I didn't think of it myself.

Since Bob also hauls his water, he wanted something that didn't use too much of that precious liquid. The system he built fits the bill perfectly.

He bought a 100 gallon poly stock tank for \$70, picked up an old solar collector, and used wood and pipe from his junk pile. (See? I told you it pays to save most everything.)

Starting with a platform, he enclosed the tub with old 2 x 4's. Then he set his water heating panel in place, lower than the tub and facing south.

From the collector (or heater) he ran the hot line to the tub, placing it near the top, but still under the water level. The cold water line comes out of the tub near the bottom, and returns to the heating panel.

This system works by itself, on the principle of thermosyphoning. Water heated by the sun rises out of the heating panel and flows into the tub. And since hot water rises, it naturally follows that cooler water sinks. So when the cool water settles to the bottom, it is syphoned off into the return line. From there it is pulled back to the collector, to be reheated and start the process all over again.

Since Bob won't use chemicals, he changes his water about once a week, via a drain valve. This is not a problem, however, since he lives so close to his water source, and the used water goes directly onto his garden.

Build you a hot tub, fill it with water, put a lid on it to retain the heat, and let the sun do its work.

What could be any simpler than this? I don't know why I didn't come up with it first, but I'll tell you this: I'll be building mine first chance I get. And that doesn't leave any drawbacks to homesteading, does it?

See photos at the back of the book.

Chapter Eleven

Friends and Neighbors

Although one of the attractions of homesteading for me has always been to 'get away' from other people, I believe you'll eventually come to desire friends and neighbors.

As for friends, who doesn't want at least some? They help in many ways.

As for neighbors, let's first clarify the definition. The way I see it, a person doesn't have to live right next door to you—like they did in the city—to be a neighbor. Out West, I've had neighbors miles away. In one instance, six miles, there being nothing but empty land between my place and his in that particular direction. He soon became a good friend. In many cases, this is what you'll find 'out there.'

Neighbors are handy in emergencies, and also to watch your place when you're gone, whether that's only to the store or out of state. And face it, sooner or later you'll be gone from your homestead for days or more at a time. Hunting, vacations, funerals, business trips, whatever. And although most country people are scrupulously honest, there's generally a bad apple or two in every bushel. Neighbors, with binoculars, come in awful handy at times like that. Or for advice. Or a shovel, or a cup of sugar, or a smile, or a favor.

Friends and neighbors also know people. People you might need sometime. Like exactly who is the best or most reasonable at this or that. Or who has an old tractor just rotting away on his property and might like to get rid of it in exchange for fence work or something you have, but don't need.

In one case, I tore down a long slabwood fence for a neighbor too old to do it himself. My reward was all of the wood, which I then cut up and burned in my woodstove; and also a good deed done for the man who had showed me how to install the barrel septic system.

In another case, I exchanged ten hours worth of general labor for an ancient Allis-Chalmers WD45 full-sized tractor—with attachments like a two-bottom plow, double-rowed disc, sickle bar, and farm trailer. I should also mention that the tractor had a hydraulic bucket on the front. Though I never succeeded in getting the old tractor running, I later sold it as-is for a 350 percent profit to someone who did.

Another time, a man who was nothing more than an acquaintance agreed to let me use his little well-drilling rig for a tiny amount of cash. Why? Simply because he knew I *needed* a well.

Such instances might sound incredible to some of you, but I want you to know that these are the kinds of things that are possible for an honest homesteader who stands by his word and helps out his neighbors in times of need. Believe me, they value honesty. And they don't ever forget.

Chapter Ten

The Hot Tub According To Bob

(As featured in "Backwoods Home Magazine," January/February 1998 issue)

Oftentimes I've visited friends in the city who had a hot tub, and considered it to be the only drawback to homesteading—not having one, that is. I'd wracked my brains trying to figure out how to build one, but still kept coming up against the inevitable: how to heat and move the water without having a big, noisy generator running all the time. There didn't seem to be a solution, but guess what? A fellow homesteader and friend by the name of Bob Herman came up with a great idea for a hot tub, and here's what makes it work: a tub, solar water-heating panel, some pipe, and water. Sounds pretty simple, huh? It is, and I can't believe I didn't think of it myself.

Since Bob also hauls his water, he wanted something that didn't use too much of that precious liquid. The system he built fits the bill perfectly.

He bought a 100 gallon poly stock tank for \$70, picked up an old solar collector, and used wood and pipe from his junk pile. (See? I told you it pays to save most everything.)

Starting with a platform, he enclosed the tub with old 2 x 4's. Then he set his water heating panel in place, lower than the tub and facing south.

From the collector (or heater) he ran the hot line to the tub, placing it near the top, but still under the water level. The cold water line comes out of the tub near the bottom, and returns to the heating panel.

This system works by itself, on the principle of thermosyphoning. Water heated by the sun rises out of the heating panel and flows into the tub. And since hot water rises, it naturally follows that cooler water sinks. So when the cool water settles to the bottom, it is syphoned off into the return line. From there it is pulled back to the collector, to be reheated and start the process all over again.

Since Bob won't use chemicals, he changes his water about once a week, via a drain valve. This is not a problem, however, since he lives so close to his water source, and the used water goes directly onto his garden.

Build you a hot tub, fill it with water, put a lid on it to retain the heat, and let the sun do its work.

What could be any simpler than this? I don't know why I didn't come up with it first, but I'll tell you this: I'll be building mine first chance I get. And that doesn't leave any drawbacks to homesteading, does it?

See photos at the back of the book.

Chapter Eleven

Friends and Neighbors

Although one of the attractions of homesteading for me has always been to 'get away' from other people, I believe you'll eventually come to desire friends and neighbors.

As for friends, who doesn't want at least some? They help in many ways.

As for neighbors, let's first clarify the definition. The way I see it, a person doesn't have to live right next door to you—like they did in the city—to be a neighbor. Out West, I've had neighbors miles away. In one instance, six miles, there being nothing but empty land between my place and his in that particular direction. He soon became a good friend. In many cases, this is what you'll find 'out there.'

Neighbors are handy in emergencies, and also to watch your place when you're gone, whether that's only to the store or out of state. And face it, sooner or later you'll be gone from your homestead for days or more at a time. Hunting, vacations, funerals, business trips, whatever. And although most country people are scrupulously honest, there's generally a bad apple or two in every bushel. Neighbors, with binoculars, come in awful handy at times like that. Or for advice. Or a shovel, or a cup of sugar, or a smile, or a favor.

Friends and neighbors also know people. People you might need sometime. Like exactly who is the best or most reasonable at this or that. Or who has an old tractor just rotting away on his property and might like to get rid of it in exchange for fence work or something you have, but don't need.

In one case, I tore down a long slabwood fence for a neighbor too old to do it himself. My reward was all of the wood, which I then cut up and burned in my woodstove; and also a good deed done for the man who had showed me how to install the barrel septic system.

In another case, I exchanged ten hours worth of general labor for an ancient Allis-Chalmers WD45 full-sized tractor—with attachments like a two-bottom plow, double-rowed disc, sickle bar, and farm trailer. I should also mention that the tractor had a hydraulic bucket on the front. Though I never succeeded in getting the old tractor running, I later sold it as-is for a 350 percent profit to someone who did.

Another time, a man who was nothing more than an acquaintance agreed to let me use his little well-drilling rig for a tiny amount of cash. Why? Simply because he knew I *needed* a well.

Such instances might sound incredible to some of you, but I want you to know that these are the kinds of things that are possible for an honest homesteader who stands by his word and helps out his neighbors in times of need. Believe me, they value honesty. And they don't ever forget.

Chapter Eleven

Friends and Neighbors

Although one of the attractions of homesteading for me has always been to 'get away' from other people, I believe you'll eventually come to desire friends and neighbors.

As for friends, who doesn't want at least some? They help in many ways.

As for neighbors, let's first clarify the definition. The way I see it, a person doesn't have to live right next door to you—like they did in the city—to be a neighbor. Out West, I've had neighbors miles away. In one instance, six miles, there being nothing but empty land between my place and his in that particular direction. He soon became a good friend. In many cases, this is what you'll find 'out there.'

Neighbors are handy in emergencies, and also to watch your place when you're gone, whether that's only to the store or out of state. And face it, sooner or later you'll be gone from your homestead for days or more at a time. Hunting, vacations, funerals, business trips, whatever. And although most country people are scrupulously honest, there's generally a bad apple or two in every bushel. Neighbors, with binoculars, come in awful handy at times like that. Or for advice. Or a shovel, or a cup of sugar, or a smile, or a favor.

Friends and neighbors also know people. People you might need sometime. Like exactly who is the best or most reasonable at this or that. Or who has an old tractor just rotting away on his property and might like to get rid of it in exchange for fence work or something you have, but don't need.

In one case, I tore down a long slabwood fence for a neighbor too old to do it himself. My reward was all of the wood, which I then cut up and burned in my woodstove; and also a good deed done for the man who had showed me how to install the barrel septic system.

In another case, I exchanged ten hours worth of general labor for an ancient Allis-Chalmers WD45 full-sized tractor—with attachments like a two-bottom plow, double-rowed disc, sickle bar, and farm trailer. I should also mention that the tractor had a hydraulic bucket on the front. Though I never succeeded in getting the old tractor running, I later sold it as-is for a 350 percent profit to someone who did.

Another time, a man who was nothing more than an acquaintance agreed to let me use his little well-drilling rig for a tiny amount of cash. Why? Simply because he knew I *needed* a well.

Such instances might sound incredible to some of you, but I want you to know that these are the kinds of things that are possible for an honest homesteader who stands by his word and helps out his neighbors in times of need. Believe me, they value honesty. And they don't ever forget.

Chapter Twelve

What It's Like To Live This Way

I have been homesteading for years now, and believe me when I tell you, that without a doubt, these have been the absolute best years of my life. Do I have any regrets? Yes, that I didn't do this sooner!

This is clean living at its finest. It's quiet, and there is time to think. There is real peace, and serenity.

If you decide to homestead, you'll lead a fit and active lifestyle. (We call it hard work.) You'll grow stronger, thinner, and wiser. Your trousers will mysteriously get bigger in the waist, and you'll hook into those never-used buckle holes waaaaay up there on your belt.

You'll breathe the cleanest air, and your endurance will improve. You'll be tanned, confident, and self-reliant.

One day, you'll be out working on the spread, and you'll know why you're smiling. You'll stop, look around, and wonder -- as I did -- why you didn't do this sooner.

What you are going to do is completely surprise yourself!

Indeed, living like this will be a great learning experience. And no matter how or where you end up (though my belief is you'll stay countryfied), you'll treasure such memories *forever*. Period.

Really, you'll learn a million things. Things like:

How many stars there really are, and the names of some of the constellations.

That there really can be shadows from starlight. And no kidding: daylight shadows even after the sun goes down.

That "shooting stars" doesn't mean murdering Hollywood celebrities. Instead, they're meteorites, and you'll see lots of them. Every once in a while, you'll see one split in two on its way down. Occasionally, you'll even see a fireball, which is nothing more than a low-flying meteor, but singularly spectacular. Yes, they actually flame.

Just how many satellites there are, and their main orbits.

That there are still millions of animals living in the wilds, and you don't have to go to the zoo to see them.

Why a pair of binoculars is a necessity.

How it is that the people around you will know who you are before you ever meet them.

That a gun (besides being a weapon) is also a tool.

A bullet will not go as far as you think.

A round shot straight up will not kill you when it comes down (it won't drop any faster than a rock.)

That four-wheel-drives are addictive (once you own one, you'll never be without one again.)

That 4WD is often more important than gas mileage.

That local dialects have a way of creeping into your speech.

There is no "Z" in the word diesel.

Country people are not dumb.

That antlers will dress up nearly any wall. (They're not called "horns." That's the thing that doesn't work on your truck.)

Why late season hunting is the best. (Hey, I'm not gonna tell you everything.)

That UPS actually does deliver worldwide. Pizza Hut does not.

Silence is not deafening at all.

Traffic jams are not compulsory, but door jams are.

That East is least, and West is best. (Sorry, I just couldn't help myself on that one.)

A western sunset is worth a thousand pictures.

That some mothers still do name their boys Royce, Cleatus, or Wes.

"Ma'am" is still a respectable way to address women.

Women like to hear the word "Ma'am." Girls do not.

That cameras don't work well in sub-zero temperatures.

That pac boots do.

When your nostrils freeze together, your camera doesn't work, and the snow squeaks under your pac boots, it's below zero.

That humidity and lack of sunshine had a lot to do with how cold you were before.

That deals can still be done on a handshake.

A man's word is more important than money.

Being free is more important than money.

There are lots of things more important than money.

Spring cleaning is really not necessary (unless it's just to put it all in one pile out back).

It pays to save most everything.

Rifle racks compliment any pickup truck.

That automobiles last twice as long when the salt goes on your meat instead of your street.

The correct name for the man who shoes your horses is blacksmith, not "fairy-er."

Why a tractor will head up your wish list.

That need outweighs want.

Why people keep that black teapot on the woodstove.

A day spent working on your homestead is much longer and ten times more enjoyable than a day spent working in a factory.

That the exact same beverage tastes at least three times better when you drink it on your new homestead.

You sunburn faster in thinner air.

Your truck needs an electric fuel pump in thinner air.

That "fired" has nothing to do with your job, but everything to do with your rifle.

What the difference is between a buck and a bull.

Antelope are fast, curious animals that taste bad.

That "ky-yotes" (not ky-yo-tees) are ugly critters that make a beautiful sound.

Your dog does not care for ky-yotes in the least.

The rattles from a dead rattlesnake make for exciting entertainment when shaken near unsuspecting city folk around the campfire at night.

Cowboy hats serve many useful purposes.

"That's a lie!" does not refer to where your golf ball sits on the green.

A "bastard" is a file that you will occasionally need.

The Frenchy words "Cul-de-sac" do not translate into Western English, except in big cities.

Neither does "animal rights."

That trees grow back.

Tree-hugging is acceptable behavior only during hurricanes and tornadoes.

Hurricanes and tornadoes are extremely rare in the mountains.

It's difficult to heat your house with Spotted Owls.

Exactly when your stovepipe needs cleaning, simply by the smell.

"Busted" means broke, not arrested.

"Mouse" is a scurvy, undesirable rodent, not something you put on your hair.

People will take you at your word, unless you show them otherwise.

If you do show them otherwise, they will absolutely never forget it. They will also tell everyone else.

The Western word for hair stylist is "barber." Barbers are cheaper than hair stylists.

The grocery store gives you free dry ice in the summer.

That dry ice is what keeps your groceries cold, it is not a rap musician.

"Rap" is what people do when they come to your door. It is not music, or talking. That's music and talking.

On the lighter side, you may also learn these few goodies:

"Pot" is a roast, not something you smoke.

"Grass" is a weed that grows in your yard.

"Weeds" are to be burned in place, not harvested, dried, and smoked in a pipe.

"Reefer" is a refrigeration unit for your semi.

"Reefer madness" is what you get when that unit breaks down.

"Red-eyed" is what you are after you illegally drove your semi all night long to get home.

A "number" is what you use to get your neighbor on the line, which is a phone line, and not some powdered substance you snort up your nose.

A "bong" is when those servants in an Egyptian movie hit that giant gong with a big hammer, not a device that you smoke something with.

A "Doobie" is one of those funny-looking German dogs.

"Wow!" is the second half of your funny-looking dog's two-word vocabulary, not something you say after you smoke something.

"Right on" is part of the directions to Billy-Bob's farm, not an exclamation.

"Far out" is where you live, not what you say after you smoke something.

"Out of sight" is how far down in the hole you used to be.

"Munchies" are those funny little guys on the Wizard of Oz, aren't they?

Out here, a "flower child" carries the flowers down the aisle at somebody's wedding.

A "buzz" is something the barber gives you.

"Cool!" is what it's going to be like when you get up at three in the morning to stoke the woodstove.

And "crash" is what happens when the brakes fail on your pickup, not what you do after you smoke something.

But seriously, you'll also learn that this is God's Country, and that the mountains sometimes really do touch the sky.

And, last but not least, you'll learn that you can be much freer than you ever thought possible. Really!

Closing Statement

I sincerely hope you enjoyed this book, and are full of ideas about how to prepare for a new life as a homesteader. Naturally, I haven't thought of everything, but these are the basics. So if you have any other ideas, drop me a line. I'd be glad to hear from you.

If you don't already have a truck, you should get one, preferably a four-wheel drive. Gather all your tools beforehand -- look for bargains and visit garage sales for things you'll need.

Try to get all your bills paid off, and stash something away you can live on while you're setting up your homestead. If you have money to live off of, you can concentrate on getting your home set up, without the additional pressure of looking for a job -- or giving all your time to it -- and then trying to work around your home in your spare time. In my case, it took me a little while, but I saved until I had a year's worth of expenses in the bank. Let me tell you, it's a wonderful feeling to be all set up on your own property, and not owe anybody anything. Nothing like it in the world.

You'll know it's worth it when there's an eagle on your fence-post, antelope in your yard, or a bear at your mailbox. When your dog runs free (and so do you,) the bills are gone, and the pressure's off. Take a moment to imagine that.

Hey, life is short, and roses don't last forever.

A friend of mine once said this to me: "Dreams without action to make them come true, are nothing more than fantasy...."

He was so right.

The best of luck to you, my friend.

Also:

The author would be interested in hearing from any travel-trailer or mobile homesteaders who have used any of the ideas contained in previous editions of this book and who would not mind the author portraying such uses in any future editions.

No compensation could be given, and the homesteader must provide the author with written authorization to use any material, comments, or photographs. However, at least one, and possibly more, of the best submissions could be briefly included in a Fourth Edition of this book, of which no publication date has yet been considered.

If you are interested in such a proposal, please write to the author as follows:

Brian D. Kelling
c/o Eden Press
P.O. Box 8410
Fountain Valley, California 92728

Travel-Trailer Homesteading: What It Looks Like

The following pictures illustrate my own applications of ideas and practices presented in the book. They are intended as **EXAMPLES ONLY**, merely to show what **CAN** be done. I hope they serve as both a guide and inspiration for others to experience the joys of modern day homesteading. Brian Kelling

Travel-Trailer Homestead

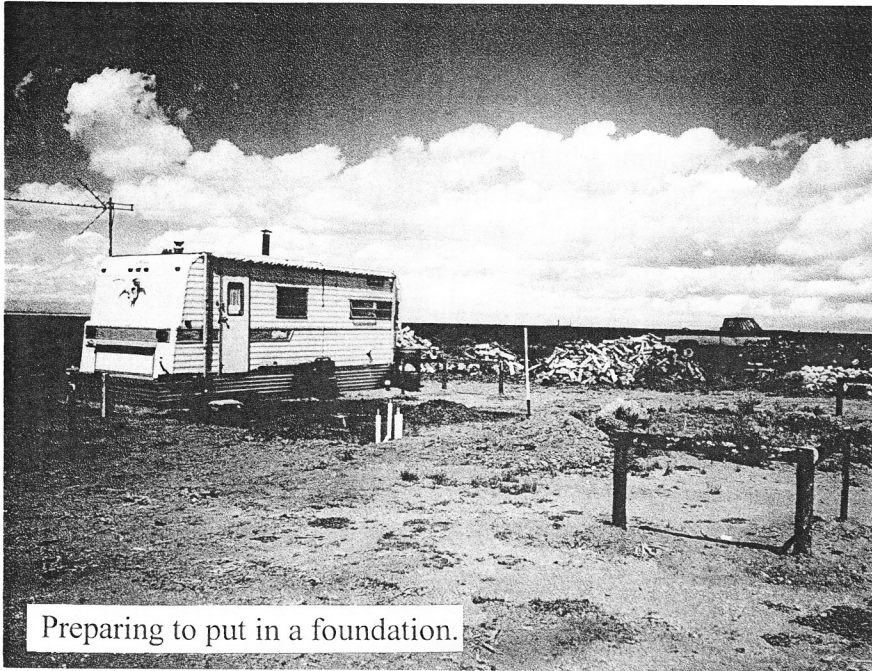

Preparing to put in a foundation.

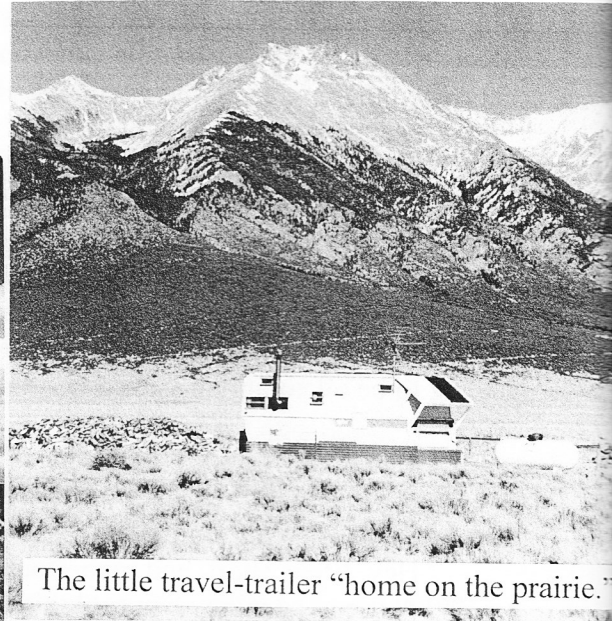

The little travel-trailer "home on the prairie."

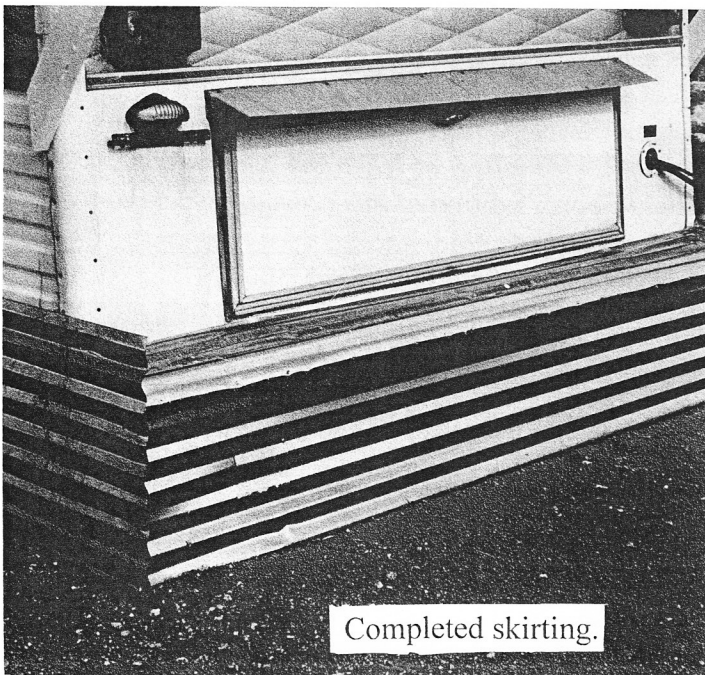

Completed skirting.



A \$500 utility pickup—very handy.

The Mobile Homestead

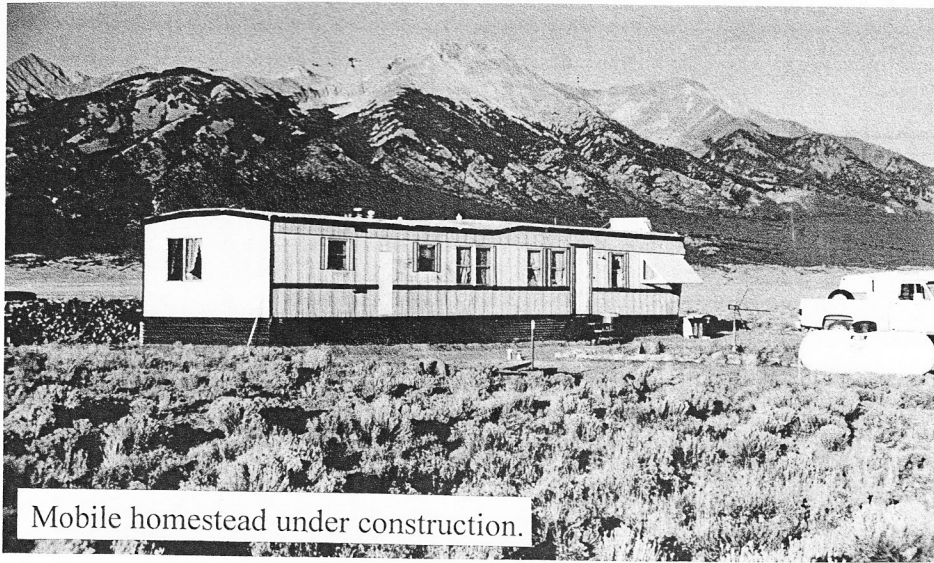

Mobile homestead under construction.

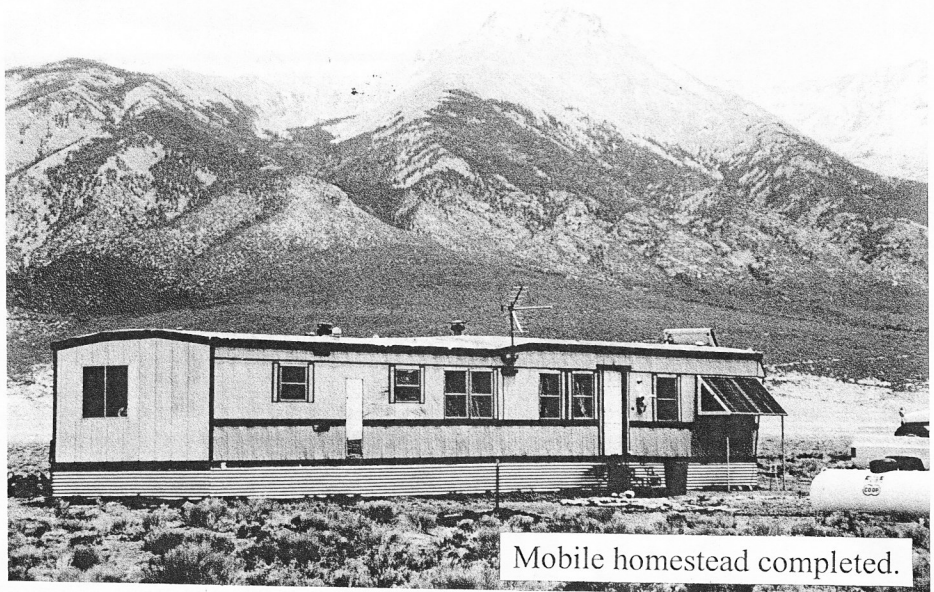

Mobile homestead completed.

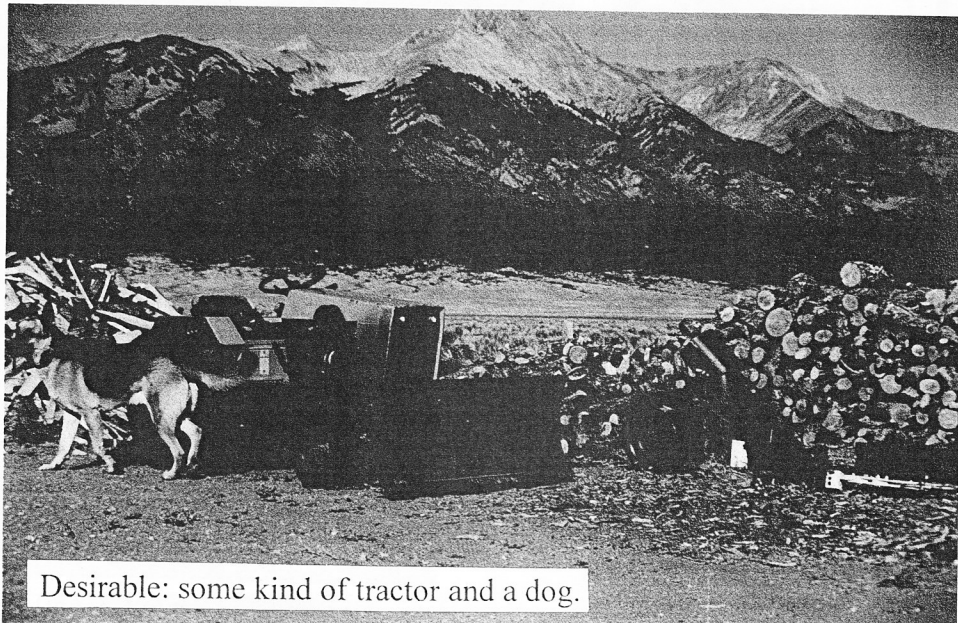

Desirable: some kind of tractor and a dog.

Inside Features

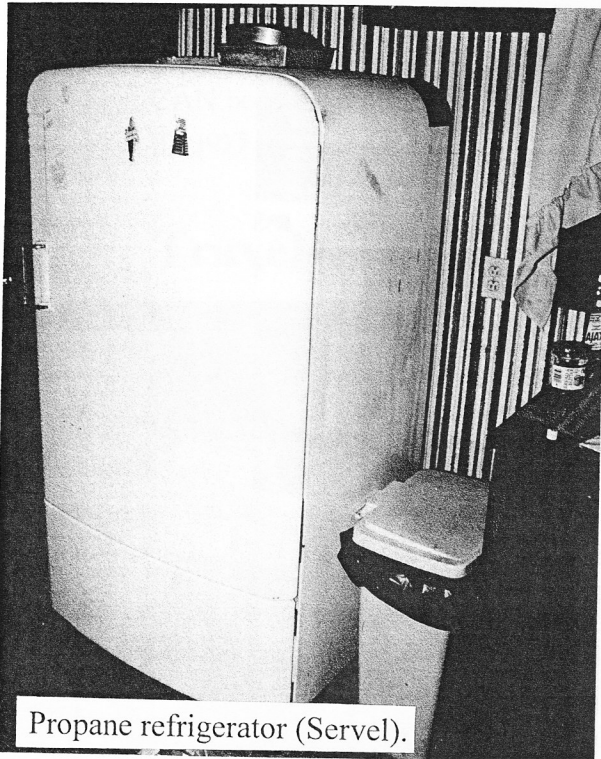

Propane refrigerator (Servel).

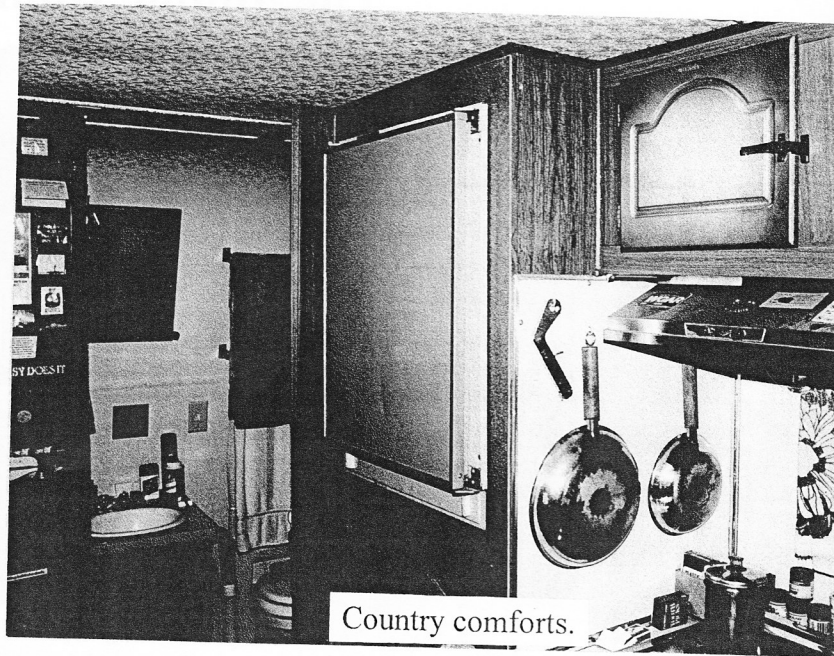

Country comforts.

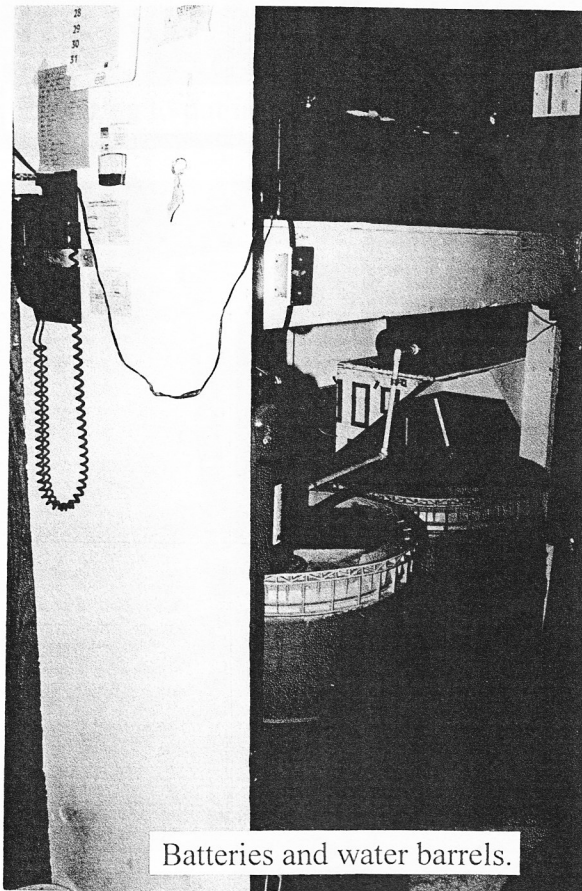

Batteries and water barrels.

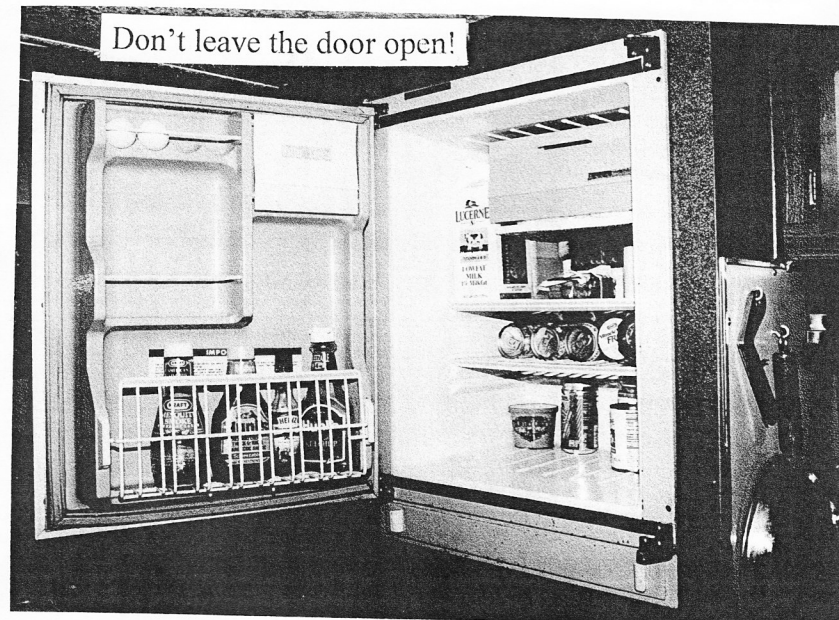

Don't leave the door open!

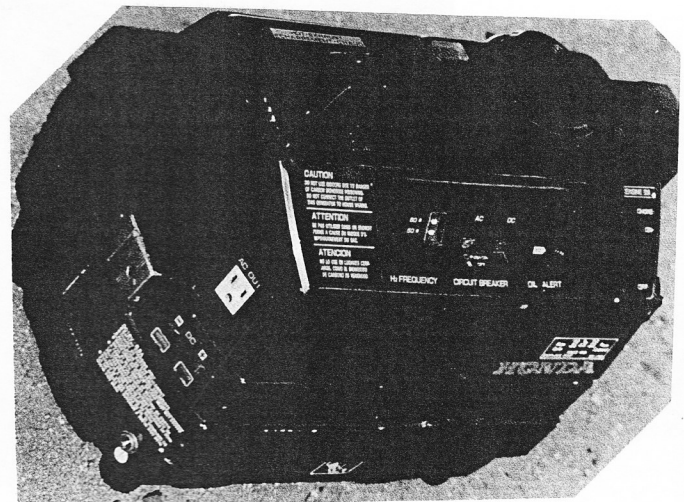

Honda EX 650 generator.

Solar Power & Heating

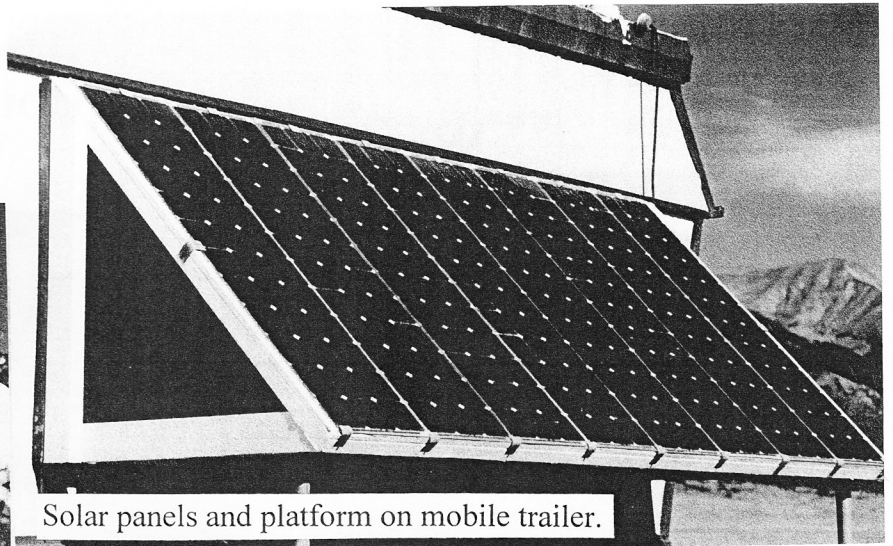

Solar panels and platform on mobile trailer.

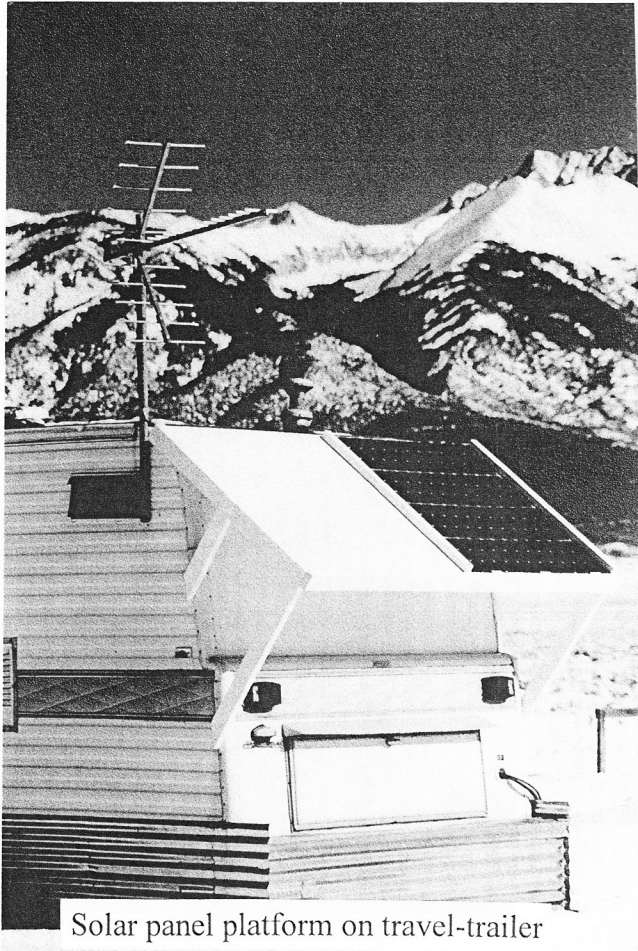

Solar panel platform on travel-trailer

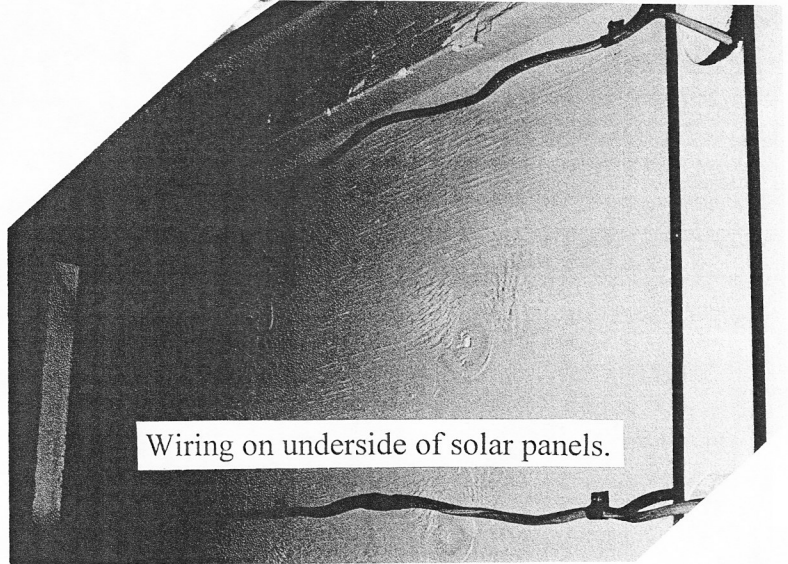

Wiring on underside of solar panels.

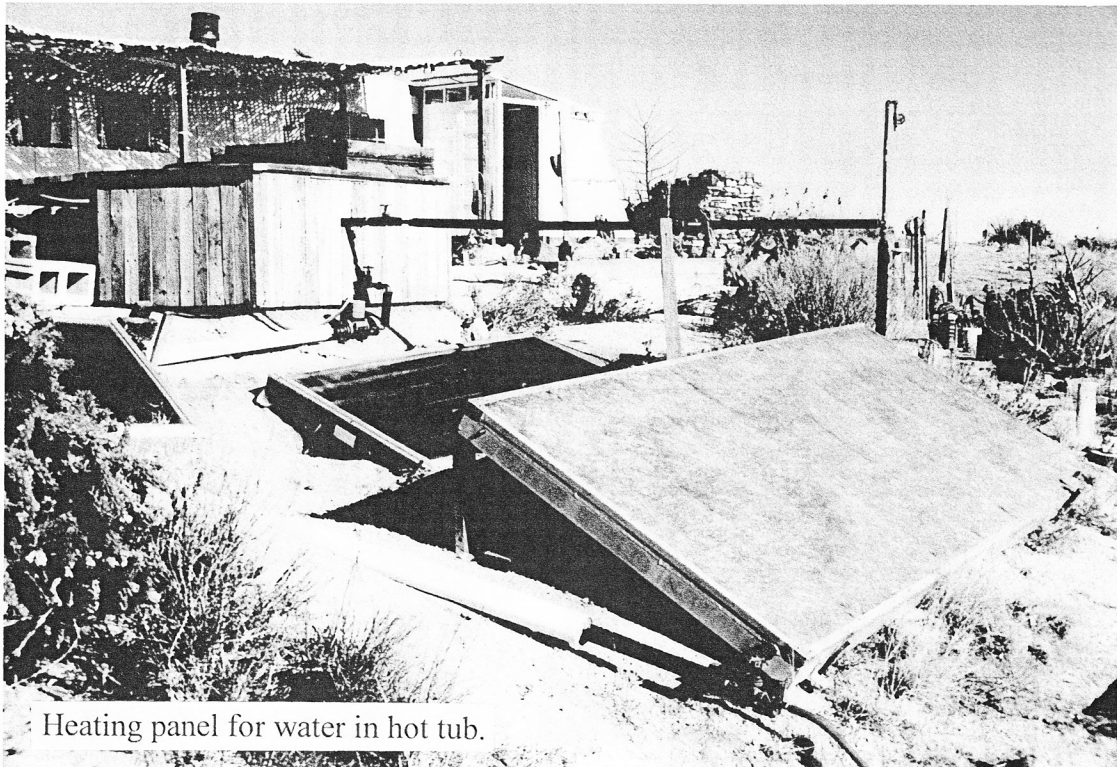

Heating panel for water in hot tub.

Water

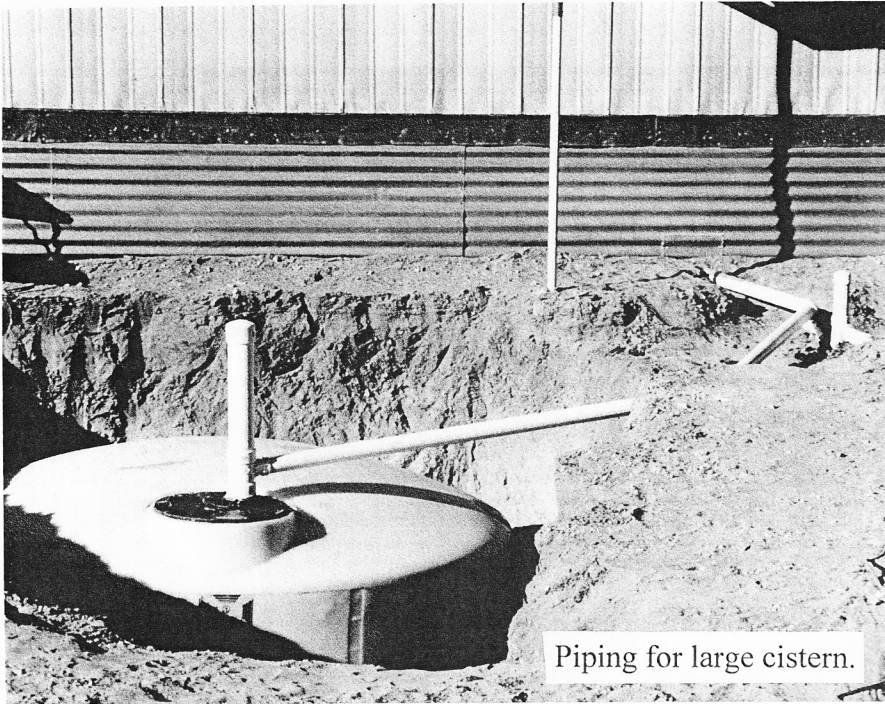

Piping for large cistern.



Large cistern in excavation before hookup

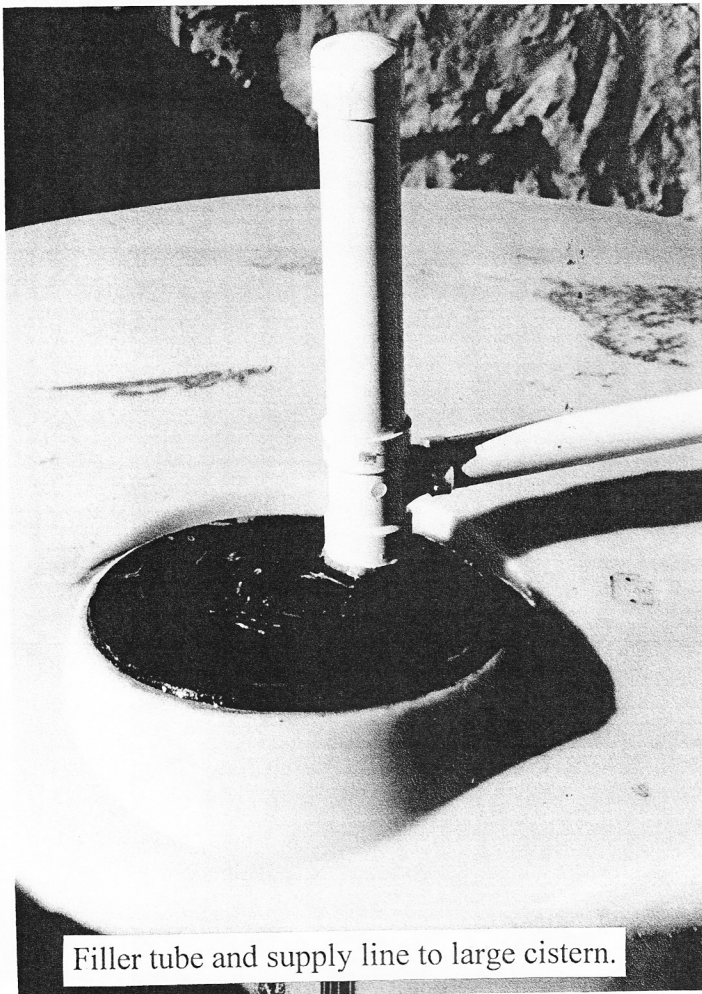

Filler tube and supply line to large cistern.

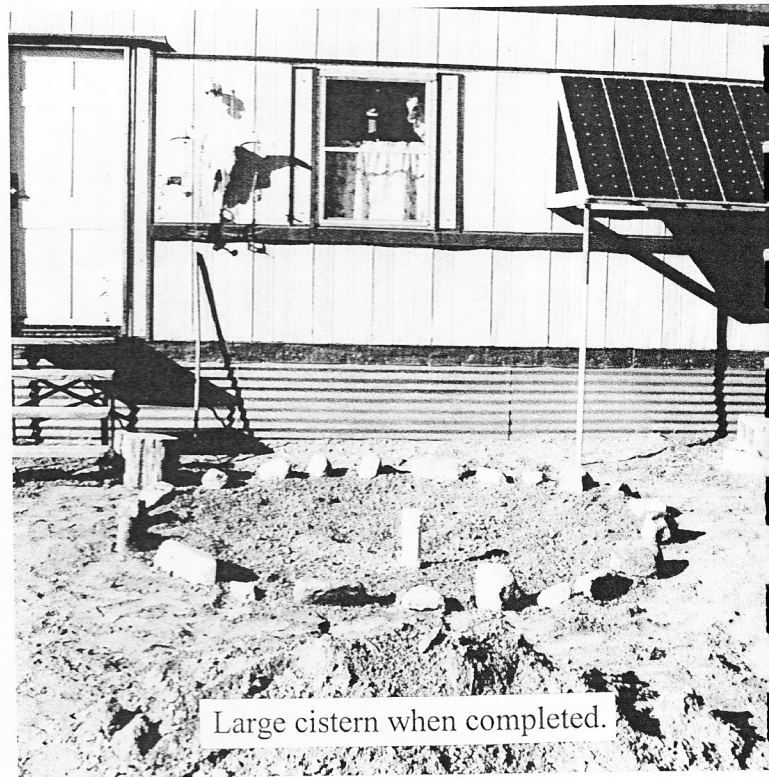

Large cistern when completed.

Septic System

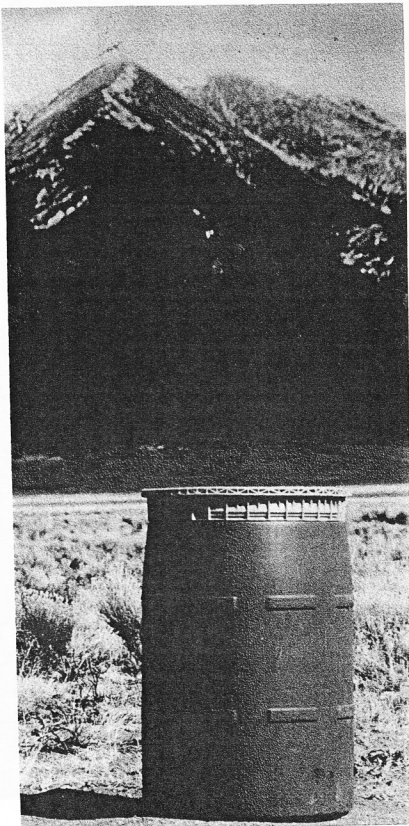

Plastic barrel for septic system.



Septic barrels when first placed in holes.

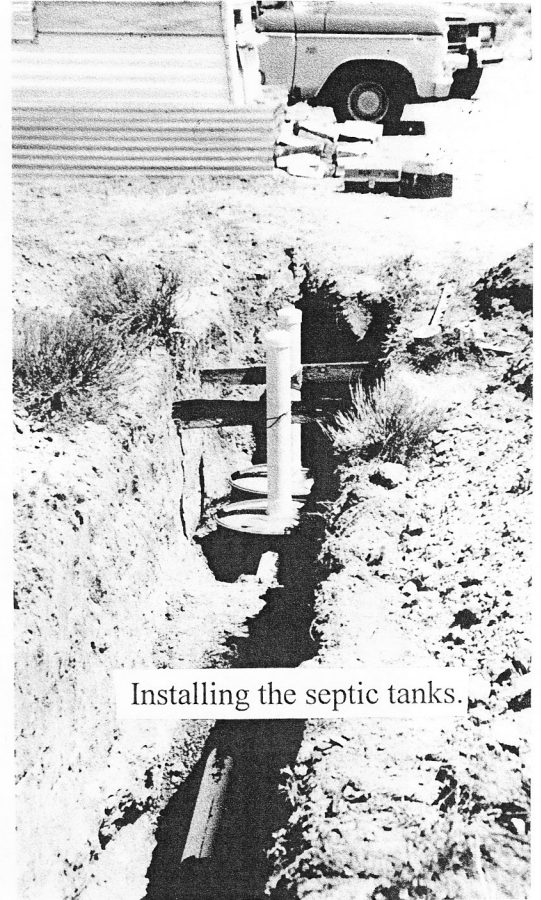

Installing the septic tanks.

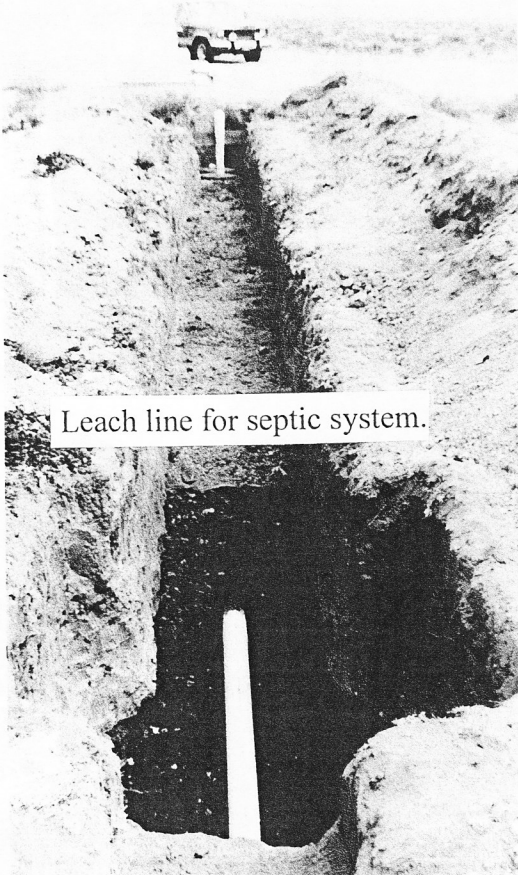

Leach line for septic system.



Installing the leach line.

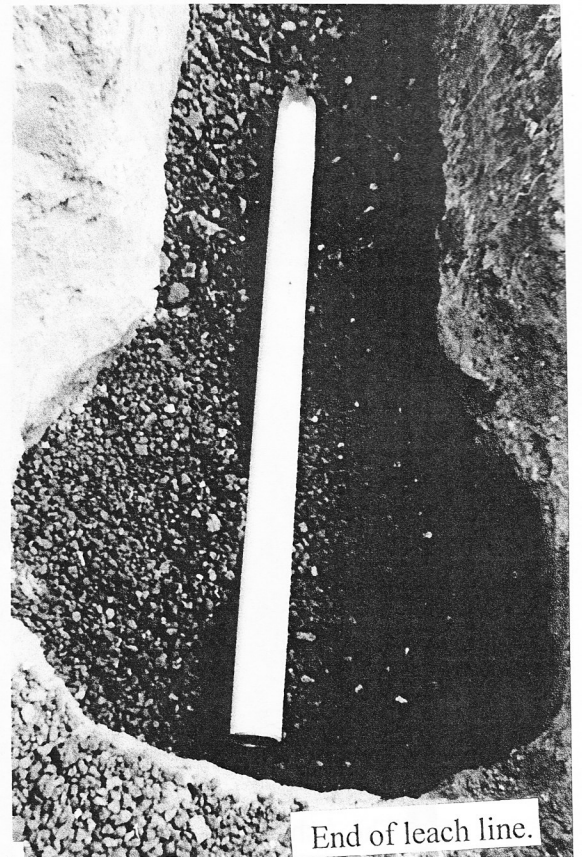

End of leach line.

Heating

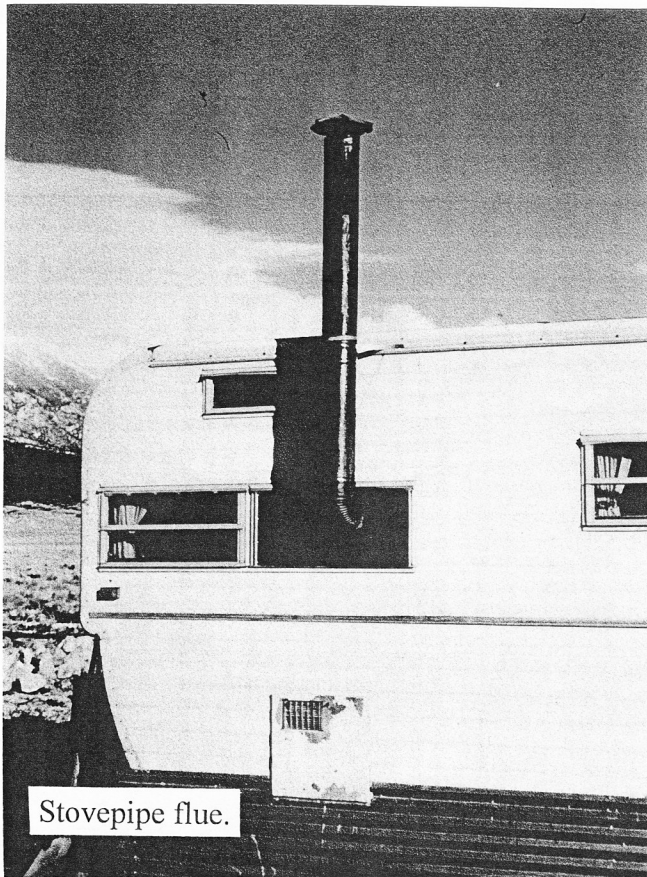

Stovepipe flue.

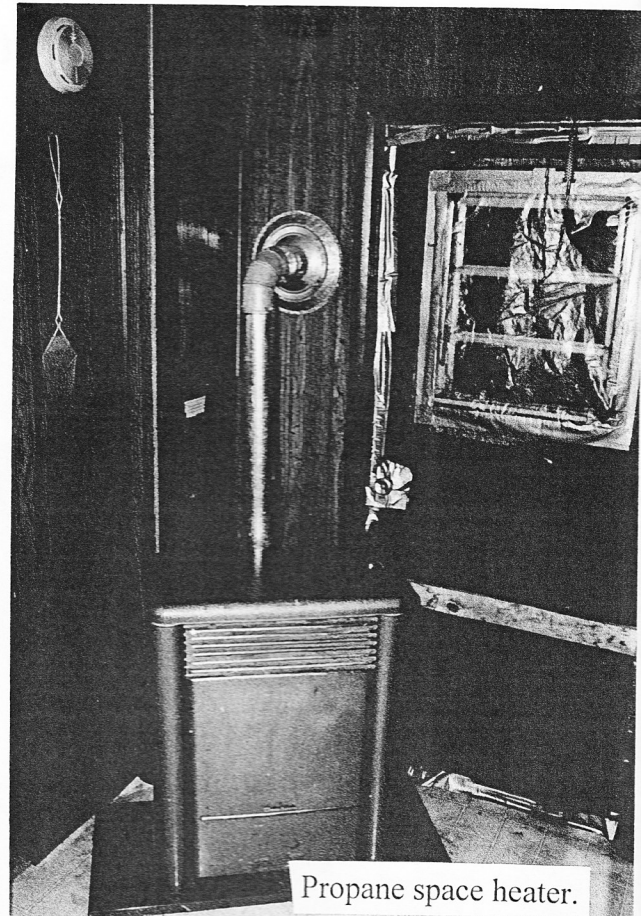

Propane space heater.



The Ashley woodstove.

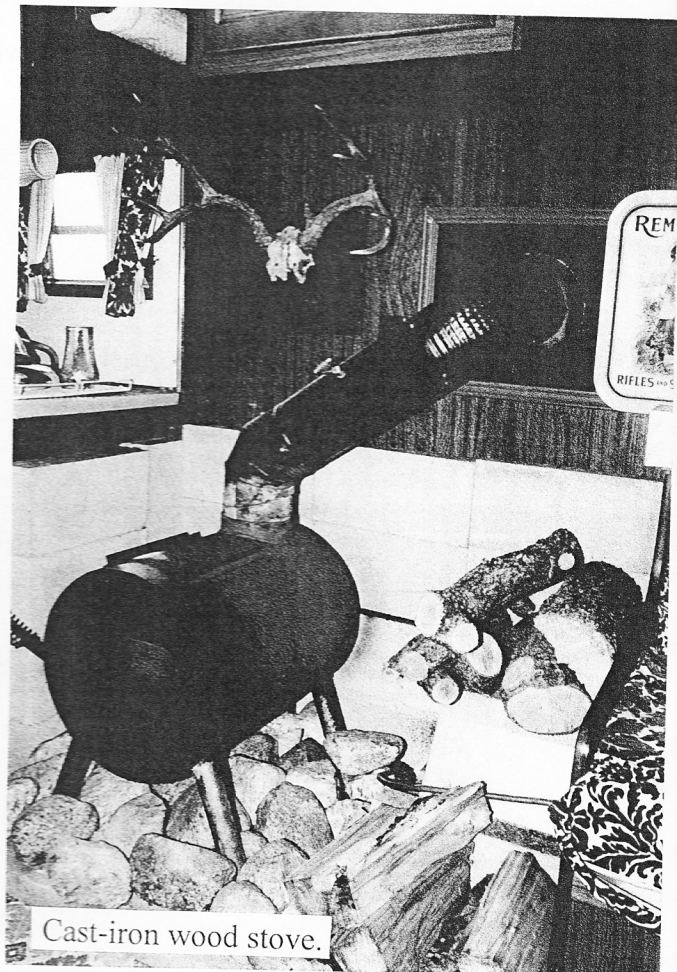

Cast-iron wood stove.

The Hot Tub

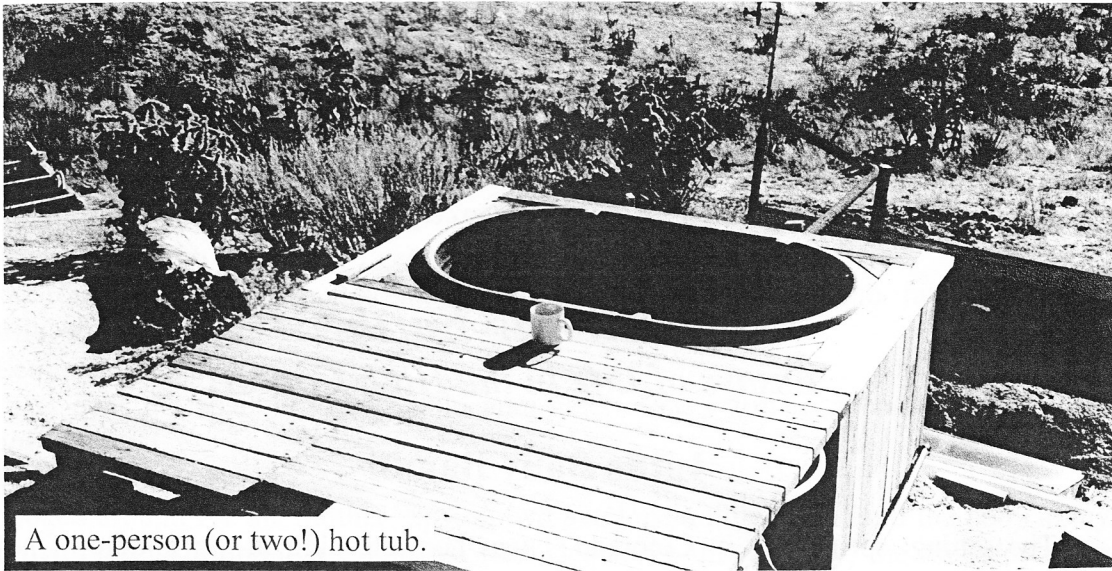

A one-person (or two!) hot tub.

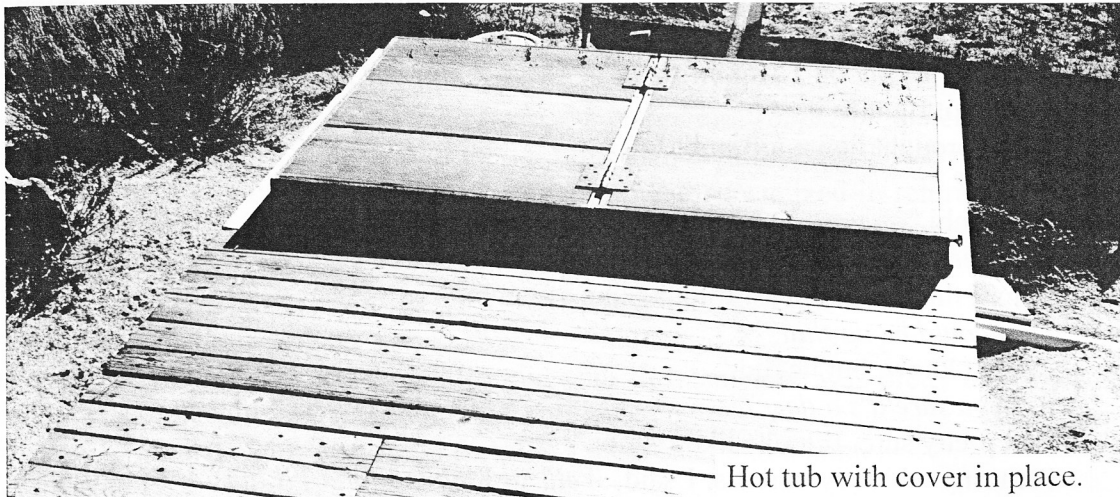

Hot tub with cover in place.

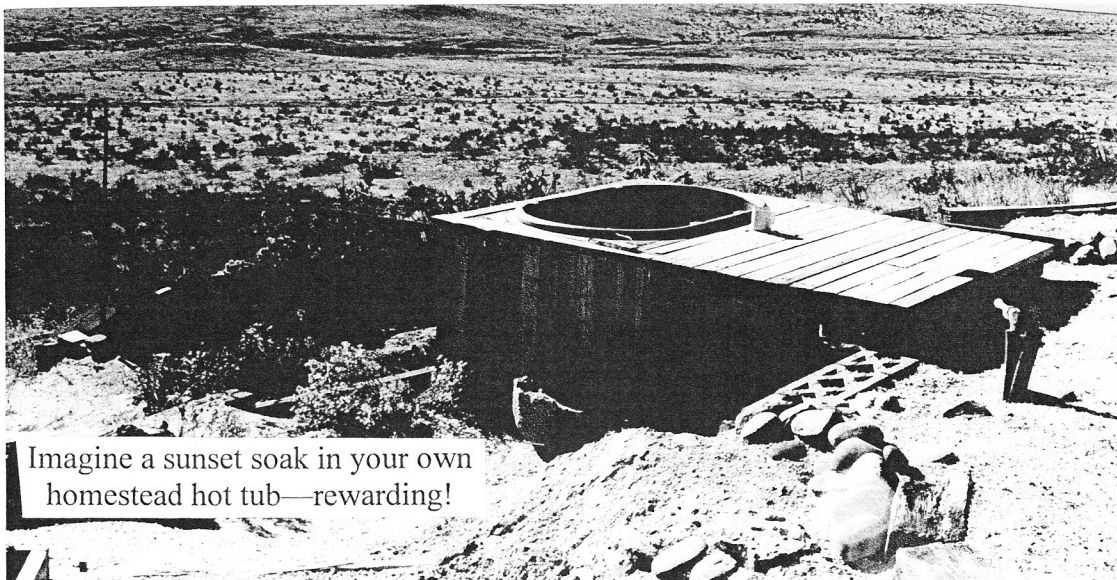

Imagine a sunset soak in your own homestead hot tub—rewarding!

