

# CPM in Construction Management

SIXTH EDITION

CD-ROM INCLUDED



- ✓ Hands-on understanding of proper construction scheduling processes
- ✓ Perform calculations of CPM to understand what the software is doing
- ✓ Updates the examples of CPM used in litigation

---

James J. O'Brien, PE, PMP  
Fredric L. Plotnick, Esq., PE

---

# CPM in Construction Management

James J. O'Brien, P.E., PMP  
Fredric L. Plotnick, Esq., P.E.

Sixth Edition

**McGraw-Hill**

New York Chicago San Francisco Lisbon London Madrid  
Mexico City Milan New Delhi San Juan Seoul  
Singapore Sydney Toronto

Copyright © 2006, 1999, 1993, 1984, 1971, 1965 by The McGraw-Hill Companies, Inc. All rights reserved. Manufactured in the United States of America. Except as permitted under the United States Copyright Act of 1976, no part of this publication may be reproduced or distributed in any form or by any means, or stored in a database or retrieval system, without the prior written permission of the publisher.

0-07-158911-2

The material in this eBook also appears in the print version of this title: 0-07-145769-0.

All trademarks are trademarks of their respective owners. Rather than put a trademark symbol after every occurrence of a trademarked name, we use names in an editorial fashion only, and to the benefit of the trademark owner, with no intention of infringement of the trademark. Where such designations appear in this book, they have been printed with initial caps.

McGraw-Hill eBooks are available at special quantity discounts to use as premiums and sales promotions, or for use in corporate training programs. For more information, please contact George Hoare, Special Sales, at [george\\_hoare@mcgraw-hill.com](mailto:george_hoare@mcgraw-hill.com) or (212) 904-4069.

## TERMS OF USE

This is a copyrighted work and The McGraw-Hill Companies, Inc. (“McGraw-Hill”) and its licensors reserve all rights in and to the work. Use of this work is subject to these terms. Except as permitted under the Copyright Act of 1976 and the right to store and retrieve one copy of the work, you may not decompile, disassemble, reverse engineer, reproduce, modify, create derivative works based upon, transmit, distribute, disseminate, sell, publish or sublicense the work or any part of it without McGraw-Hill’s prior consent. You may use the work for your own noncommercial and personal use; any other use of the work is strictly prohibited. Your right to use the work may be terminated if you fail to comply with these terms.

THE WORK IS PROVIDED “AS IS.” MCGRAW-HILL AND ITS LICENSORS MAKE NO GUARANTEES OR WARRANTIES AS TO THE ACCURACY, ADEQUACY OR COMPLETENESS OF OR RESULTS TO BE OBTAINED FROM USING THE WORK, INCLUDING ANY INFORMATION THAT CAN BE ACCESSED THROUGH THE WORK VIA HYPERLINK OR OTHERWISE, AND EXPRESSLY DISCLAIM ANY WARRANTY, EXPRESS OR IMPLIED, INCLUDING BUT NOT LIMITED TO IMPLIED WARRANTIES OF MERCHANTABILITY OR FITNESS FOR A PARTICULAR PURPOSE. McGraw-Hill and its licensors do not warrant or guarantee that the functions contained in the work will meet your requirements or that its operation will be uninterrupted or error free. Neither McGraw-Hill nor its licensors shall be liable to you or anyone else for any inaccuracy, error or omission, regardless of cause, in the work or for any damages resulting therefrom. McGraw-Hill has no responsibility for the content of any information accessed through the work. Under no circumstances shall McGraw-Hill and/or its licensors be liable for any indirect, incidental, special, punitive, consequential or similar damages that result from the use of or inability to use the work, even if any of them has been advised of the possibility of such damages. This limitation of liability shall apply to any claim or cause whatsoever whether such claim or cause arises in contract, tort or otherwise.

DOI: 10.1036/0071457690



# Professional



## Want to learn more?

We hope you enjoy this McGraw-Hill eBook! If you'd like more information about this book, its author, or related books and websites, please [click here](#).

---

# Contents

Preface	xv
Acknowledgments	xix

## Part 1. Introduction to CPM Planning and Scheduling

<b>Chapter 1. Introduction to CPM Planning and Scheduling</b>	<b>3</b>
1.1. Scheduling is for Everyone	3
1.2. We Teach Carpentry—Not “How to Use Your New Power Saw”	4
1.3. History of Scheduling Systems	5
1.4. The Ordered “ToDo” List	6
1.5. Gantt Charts and Bar Charts	6
1.6. Development of the Critical Path Method of Scheduling	9
1.7. Development of the PERT Method of Scheduling	11
1.8. Comparison of CPM and PERT	12
<b>Chapter 2. Project Control Systems Evolve in Academia</b>	<b>15</b>
2.1. 1960–1965: Logic Systems Gain Acceptance	15
2.2. 1966–1970: The Fight between CPM and PERT	17
2.3. PDM	18
2.4. SPERT and GERT	19
2.5. RDCPM™	20
<b>Chapter 3. Project Control Systems Evolve in the Marketplace</b>	<b>25</b>
3.1. Commercialization 1965–1970	25
3.2. Commercialization 1970–1980	26
3.3. Early Legal Recognition	26
3.4. PCs 1980–1990	27
3.5. PCs 1990–2000	27
3.6. PCs 2000–2005	28
3.7. PCs 2005–2010	29
3.8. The Sixth Edition	30

## Part 2. The Theory of CPM Planning and Scheduling

<b>Chapter 4. Your New Tool—Read Before Using</b>	<b>35</b>
4.1. Primavera and Your Power Saw—Useful but Dangerous Tools	35
4.2. How Does Primavera (or Other Scheduling Software) Work?	37
4.3. What Goes In . . .	37
4.4. The Initial Logic Network—Input	37
4.5. The Logic of the Logic Network	38
4.6. Arrow Diagram	38
4.7. Logic Diagrams	41
4.8. Logical Loop	45
4.9. Non-construction Examples	46
4.10. Summary	48
<b>Chapter 5. Network Construction</b>	<b>49</b>
5.1. Form and Format	49
5.2. Events	51
5.3. Problems with Multisheet Networks	61
5.4. Summary	63
<b>Chapter 6. The Durations of the Logic Network</b>	<b>65</b>
6.1. Definition of an Activity	66
6.2. Setting a Minimum and Maximum Duration	67
6.3. Estimating versus Scheduling Durations	69
6.4. CPM versus PERT Durations	70
6.5. Summary	72
<b>Chapter 7. What Comes Out . . .</b>	<b>73</b>
7.1. Attributes of an Event	74
7.2. Attributes of an Activity	74
7.3. The Forward Pass— $T_E$ , $ES$ , and $EF$	75
7.4. The Backward Pass— $T_L$ , $LF$ , and $LS$	75
7.5. The Backward Pass— $TF$ , $FF$ , and $IF$	75
7.6. Calculating the Attributes of an Event or Activity	77
7.7. The Forward Pass— $T_E$ , $ES$ , and $EF$	77
7.8. The Backward Pass— $T_L$ , $LF$ , and $LS$	78
7.9. The Backward Pass— $TF$ , $FF$ , and $IF$	79
7.10. Summary	80
<b>Chapter 8. Cranking the Engine</b>	<b>81</b>
8.1. Manual and Computer Solutions for PERT and ADM— The Matrix Method	81
8.2. Manual and Computer Solution for PERT and ADM— The Intuitive Method	88

8.3. Activity Start and Finish Times	93
8.4. Critical Activities	95
8.5. Total Float	97
8.6. Free Float	100
8.7. Independent Float	102
8.8. Time Scale Network	104
8.9. Computation Time	105
8.10. Writing Your Own CPM Software	105
8.11. Manual and Computer Solution for PDM with Durations Between Activities	108
8.12. Summary	110
<b>Chapter 9. Adding Complexity</b>	<b>111</b>
9.1. Enhancements to the Basic System	111
9.2. Original versus Remaining Durations	112
9.3. Percent Complete	112
9.4. Defined Subtasks and Check-off Updating	113
9.5. Calendar versus Work Period Conventions	115
9.6. Multiple Calendars	116
9.7. Multiple Starting and Ending Activities	118
9.8. Artificial Constraints to Dates	120
9.9. Artificial Constraints to Algorithms	123
9.10. Negative Float	123
9.11. Definition of Criticality	124
9.12. Continuous versus Interruptible Performance	129
9.13. Actual Start and Finish Dates	129
9.14. Retained Logic versus Progress Overrides	130
9.15. Events and Milestones	131
9.16. Hammocks and Summary Network Logic	132
9.17. Summary Activity Bars	133
9.18. User-defined Code Fields	136
9.19. Adding Resources to Activities	136
9.20. Adding Costs and Cost Codes to Activities	137
9.21. Resource Driven Scheduling	139
9.22. Master Schedules Local versus System-wide Updating	140
9.23. Activity Types	142
9.24. Hierarchical Codes	144
9.25. Summary	146
<b>Chapter 10. PDM and Precedence Networks</b>	<b>147</b>
10.1. Precedence Logic	148
10.2. Work Package Calculations	152
10.3. Computer Calculation	153
10.4. Project Example	156
10.5. Summary	159

<b>Chapter 11. Respecting the Power of PDM</b>	<b>161</b>
11.1. Durations between Activities: Percent Lead/Lag Relationships	161
11.2. Defining Overlapping Activities: Durations between Activities	163
11.3. Negative Durations between Activities	170
11.4. Remaining Durations between Activities	170
11.5. Impact of Percent Complete Upon Durations between Activities	171
11.6. PDM and Hammocks	172
11.7. Continuous versus Interruptible Progress	175
11.8. Undefined Subtasks and Relationships to Other Activities	177
11.9. Multiple Calendars	178
11.10. Retained Logic versus Progress Override	179
11.11. Total Float Calculation	180
11.12. Erroneous Loop Errors	181
11.13. Summary	182
<b>Chapter 12. Enhancements and Extensions by Software Vendors</b>	<b>183</b>
12.1. Overview of Primavera Project Planner P3	183
12.2. Overview of Suretrak Project Planner	184
12.3. Overview of P3e/c Primavera Program Manager	186
12.4. Overview of Primavera Contractor	188
12.5. Overview of Microsoft Project Professional 2003	188
12.6. Overview of Welcom Open Plan	189
<b>Part 3. The Tools of CPM Planning and Scheduling</b>	
<b>Chapter 13. Measure Twice—Cut Once</b>	<b>197</b>
13.1. Preparing to Collect the Input	197
13.2. The Pure Logic Diagram	198
13.3. A Team Effort . . . on the Blackboard or Sketch Pad	198
13.4. Format for Ease of Data Collection versus for Ease of Data Entry to Chosen Software	198
13.5. Bar Chart: May Be Based upon Logic, but Is not a Logic Network	199
13.6. Logic Restrained Bar Chart	200
13.7. Freehand	200
13.8. PERT	200
13.9. Summary	205
<b>Chapter 14. Choosing Codes</b>	<b>207</b>
14.1. Calendar	207
14.2. Deliverable and Responsible Entity: SHT1, SHT2, RESP, and SUBC	210
14.3. Key Resources: CRTY, CRSZ, MHRS, SUPV and EQUIP	211
14.4. O.T., Night Work, and Special Supervision or Inspection	211
14.5. Quantities and Rates of Productivity	211
14.6. Location, Location, Location	212
14.7. Budget Codes for Cost of Labor, Equipment, and Materials	213



14.8.	A Word About Codes Tied to the Activity ID	215
14.9.	A Word About Aliases	216
14.10.	Summary	216
<b>Chapter 15.</b>	<b>Acquiring Information to Initial Schedule</b>	<b>219</b>
15.1.	The Activity Description—a Gross Abbreviation	220
15.2.	Activity ID, Activity Codes and Logs	221
15.3.	The Activity Further Defined by Resources Assigned	221
15.4.	The Activity Further Defined by Predecessors and Successors	221
15.5.	The Checklist of Sub-tasks	222
15.6.	The Checklist of Sub-deliverables (Events)	222
15.7.	Summary	222
<b>Chapter 16.</b>	<b>Acquiring the Durations</b>	<b>223</b>
16.1.	Best Estimate with Utilization of Resources Envisioned	223
16.2.	Compare with PERT Durations: Optimistic, Most Likely, Pessimistic	224
16.3.	Schedule Durations versus Estimating Durations	224
16.4.	Estimated Durations versus Calculated Durations	225
16.5.	Do We Add Contingency Here?	225
16.6.	Estimated Durations versus Expected Completion Dates: “as Good as the Promise”	226
16.7.	Productivity	226
16.8.	Durations and the Project Calendar or Calendars	226
16.9.	Summary	230
<b>Chapter 17.</b>	<b>Specifying the Relationships Between Activities</b>	<b>231</b>
17.1.	Mandatory and Discretionary Physical Restraints	231
17.2.	Mandatory and Discretionary Resource Restraints	232
17.3.	Mandatory and Discretionary Timing Constraints	233
17.4.	The Misuse of Restraints and Constraints: “Nailing the Bar Down Where It Belongs”	234
17.5.	The Need to Document the Basis of Each Restraint and Constraint	234
17.6.	Choosing the Type of Relationship between Activities	234
17.7.	The Case for Restricting Relationships to Traditional “FS” Without Lag	235
17.8.	The Need for Non-Traditional Relationships	235
17.9.	The Desire for Non-Traditional Relationship and Resulting Misuse	237
17.10.	Non-Traditional Relationships Supported by Popular Software	238
17.11.	Minimum Restrictions for Proper Usage of PDM	239
17.12.	Review the Strengths of ADM: Expand the Definitions	239
17.13.	Start of Each Activity Must Have Predecessor	239
17.14.	Finish of Each Activity Must Have Successor	239
17.15.	Real World Relationships between Activities	240
17.16.	The Final Forward Pass	240
17.17.	The Final Backward Pass	241
17.18.	Choosing the Algorithm for the Initial Schedule	241
17.19.	Summary	243

<b>Chapter 18. Example Project: The John Doe Project</b>	<b>245</b>
18.1. Acquiring Information to Initial Schedule	245
18.2. Choosing Appropriate Codes	246
18.3. Activity List	246
18.4. Could We Prepare a Bar Chart?	253
18.5. Network Logic in ADM	254
18.6. Logic Changes Examples	262
18.7. Network Logic in PDM	263
18.8. Populating the Codes	265
18.9. Checking the Output	265
18.10. Calendar Dates	274
18.11. Summary	276

## **Part 4. The Practice of CPM Planning**

<b>Chapter 19. Equipment and Workforce Planning</b>	<b>277</b>
19.1. Workforce Leveling	279
19.2. Computerized Resources Planning	287
19.3. Multiproject Scheduling	292
19.4. Turnaround Application	296
19.5. Examples of Resource Loading on John Doe Project	300
19.6. Resource Leveling Significance	302
19.7. Summary	305

<b>Chapter 20. Procurement</b>	<b>307</b>
20.1. Scheduling Materials Procurement	307
20.2. John Doe Example	317
20.3. Summary	320

<b>Chapter 21. Preconstruction</b>	<b>321</b>
21.1. Predesign Phase	323
21.2. Design	325
21.3. Summary	333

<b>Chapter 22. Evolution of the Project Schedule</b>	<b>335</b>
22.1. Preliminary Schedule	335
22.2. Preconstruction Analysis	336
22.3. Contractor Preconstruction Analysis	336
22.4. Milestones	337
22.5. The John Doe Schedule	338
22.6. Resources	339
22.7. Fast Track	341
22.8. Responsibility	342

22.9. Schedule versus Calendar	342
22.10. Contingency	344
22.11. Schedule Manipulation	349
22.12. Working Schedule	350
22.13. Summary	353
<b>Chapter 23. CPM and Cost Control</b>	<b>355</b>
23.1. CPM Cost Estimate	355
23.2. Progress Payments	358
23.3. Cost Forecasting	362
23.4. Network Time Expediting	369
23.5. Minimum Cost Expediting	375
23.6. Summary	379
<b>Part 5. The Practice of CPM Scheduling</b>	
<b>Chapter 24. Let's Look Under the Hood at the Engine</b>	<b>383</b>
24.1. Primavera Project Planner P3	383
24.2. Project and Activity Codes for Organizing Project Data	392
24.3. Entering Data	393
24.4. Debugging and Diagnostic Tools: Improving the Logic Network	395
24.5. Viewing Output	397
24.6. On-screen Formats	397
24.7. Viewing Output: Tabular Formats	400
24.8. Viewing Output: Graphical Formats	401
24.9. Entering Update Data	404
24.10. Primavera Project Manager: P3e/c	405
24.11. Summary	411
<b>Chapter 25. Converting the Team Plan to the Calculated Schedule</b>	<b>413</b>
25.1. Data Entry Made Easy	413
25.2. Check and Set Schedule Algorithm Options	414
25.3. First Run and De-bugging the Logic	417
25.4. Loop Detection and Correction	418
25.5. Technical Review: The Primavera Diagnostic Report	419
25.6. Beyond the Primavera Diagnostic	422
25.7. First Review of Calculated Output: Reality Check #1	427
25.8. Detail Views of Output of Schedule Calculations	427
25.9. Time Scaled Logic Diagram	434
25.10. Tailoring Initial Output to the Chosen Audiences	435
25.11. Whatever Owner Wants, Owner Gets	435
25.12. "You Can't Always Get What You Want, But . . . You Get What You Need"	436
25.13. Reports and Views for the Foreman Performing the Work	437
25.14. Reports and Views for the Contractor's Superintendent	440

25.15. Reports and Views for the Contractor's Upper Management	442
25.16. The Narrative Report for Each Audience	443
25.17. Summary	444
<b>Chapter 26. Engineer's Review of the Submitted Initial CPM</b>	<b>445</b>
26.1. Legal Aspects of a Review	447
26.2. Reviewing the Plan	448
26.3. Technical Review	449
26.4. Reschedule and Review the Diagnostic Report	449
26.5. But Is the Logic Realistic? The Smell Test	452
26.6. Project Calendar or Calendars	453
26.7. Summary	453
<b>Chapter 27. Updating the Schedule</b>	<b>455</b>
27.1. Why Update the Schedule?	456
27.2. Acquiring the Data for an Update	457
27.3. Distinguishing Updates from Revisions	459
27.4. Purpose of an Update	459
27.5. The Purpose of a Revision	460
27.6. Who Should Collect Data for an Update	460
27.7. Who Should Prepare Data for a Revision	460
27.8. Information Required for Schedule Control: AS, RD, AF	461
27.9. Determination of Actual Start and Actual Finish Dates	461
27.10. Determination of Remaining Duration of Activities: Repeat the Steps of the Master	461
27.11. Expected Completion and Renewing Promises	462
27.12. Automatic Updates	463
27.13. The Forgotten Step: Determination of Remaining Duration Between Activities	463
27.14. Save and Rename: Naming Strategies	465
27.15. Reports and Views to Assist Acquiring Data for an Update	468
27.16. Electronic Tools to Assist Acquiring Data for an Update	469
27.17. Choosing the Correct Algorithm for Updates	469
27.18. Scheduling the Update: Interpreting the Results	469
27.19. Technical Review: the Primavera Diagnostic Report	470
27.20. What to Look for when Reviewing the Update	471
27.21. Tailoring Update Output to the Chosen Audiences	472
27.22. The Narrative Report for Each Audience	473
27.23. Summary	474
<b>Chapter 28. Engineer's Review of the Submitted Update</b>	<b>475</b>
28.1. Is This an Update or a Revision?	475
28.2. The Technical Review	476
28.3. The Critical Path	477
28.4. What to Accept and What to Reject	477
28.5. Summary	478

<b>Chapter 29. Revising the Logic Network</b>	<b>479</b>
29.1. “What If” versus Committed Changes	479
29.2. Changes: Approved, Constructive and at Contractor’s Cost	481
29.3. Revised Baseline	482
29.4. Update then Revise	483
29.5. Summary	483
<b>Chapter 30. Engineer’s Review of the Submitted Revision</b>	<b>485</b>
30.1. Minor Revision	485
30.2. Major Revision	487
30.3. Recovery Schedule	487
30.4. Summary	487
<b>Chapter 31. Case Histories</b>	<b>489</b>
31.1. Chicago Courthouse	489
31.2. Times Tower	490
31.3. Airport Construction	490
31.4. High-Rise Construction	491
31.5. NASA	493
31.6. Housing	493
31.7. Manufacturing Facilities	494
31.8. SEPTA RailWorks	495
31.9. New Jersey Turnpike Authority 1990–1995 Widening Program	496
31.10. JFK Redevelopment	497
31.11. Toronto Transit’s “Let’s Move” Program	500
31.12. Phoenixville-Mont Claire Bridge	503
31.13. Graduate Hospital Diagnostic Building	506
31.14. Interstate 76, 202 & 422 Interchange	508
31.15. CPM Preparation Time	510
31.16. Summary	513
<b>Chapter 32. Additional Exercises for Students of Project Controls</b>	<b>515</b>
32.1. Sample Problems	515
32.2. Navigating the Enclosed CD-ROM	517
32.3. Answers to Sample Problems	520
<b>Part 6. Advanced Topics</b>	
<b>Chapter 33. Specifying CPM</b>	<b>525</b>
33.1. Attorney’s Viewpoint to Writing a CPM Specification	525
33.2. Pure Logic Drawing	526
33.3. Content of the Logic Network	527
33.4. Updates and Revisions	529

33.5. Standard References	530
33.6. Sanctions	532
33.7. Sample CPM Specification	533
33.8. Summary	534
<b>Chapter 34. CPM in Claims and Litigation</b>	<b>535</b>
34.1. Introduction	535
34.2. Evidentiary Use of CPM	537
<b>Chapter 35. Delay Analysis</b>	<b>545</b>
35.1. Delay versus Disruption	545
35.2. Responsibility/Types/Force Majeure	546
35.3. As-Planned Logic Network	548
35.4. As-Should-Have-Been CPM Network	550
35.5. As-Planned Schedule	551
35.6. As-Built Schedule	552
35.7. As-Built Logic Network	553
35.8. Causative Factors	554
35.9. As-Impacted Logic Network	556
35.10. As-Impacted Schedule	557
35.11. Time Impact Evaluations	557
35.12. Zeroing Out	558
35.13. Zeroing to a Collapsed As-Impacted Logic Network	559
35.14. Limitations of the TIE Methodology	560
35.15. TIE Example of John Doe Project	561
35.16. Windows Analysis	567
35.17. Zeroing Out within the Windows Analysis	569
35.18. Windows Example of John Doe Project	569
35.19. Summary	570
<b>Chapter 36. Disruption Analyses</b>	<b>571</b>
36.1. Traditional Methodologies	571
36.2. CPM Out-of-Sequence Methodology	572
36.3. Summary	574
<b>Chapter 37. Advanced Topics: Resource Leveling and Smoothing</b>	<b>575</b>
37.1. Resource Leveling and Smoothing	575
37.2. Limitations of Algorithms	576
37.3. Driving Resources	576
37.4. Resource Calendars	577
37.5. Practical Solutions	578
37.6. Summary of Resource Leveling	579
<b>Chapter 38. Advanced Topics: PERT, SPERT, and GERT</b>	<b>581</b>
38.1. PERT	582
38.2. SPERT	582

38.3. GERT	586
38.4. Computers Add Power	587
38.5. Summary	588
<b>Chapter 39. Conclusion</b>	<b>589</b>
<b>Appendix A. Sample CPM Specification as a Guideline for Preparing Your Own Specification</b>	<b>591</b>
<b>Appendix B. Unified Facilities Guide Specification</b>	<b>607</b>
<b>Appendix C. Notation for RDCPM</b>	<b>631</b>
Glossary	635
Acronyms and Symbols	641
Index	643

## ABOUT THE AUTHORS

JAMES J. O'BRIEN, P.E., PMP, CVS, was vice chair of the board of O'Brien-Kreitzberg & Associates, Inc., the construction management firm that handled the renovation of San Francisco's cable car system. He was also the program manager for the redevelopment of JFK International Airport. Mr. O'Brien is the author or editor of many other books, including *Contractor's Management Handbook*, Second Edition; *Construction Management: A Professional Approach*; *Value Analysis in Design and Construction*; and *Scheduling Handbook*, all published by McGraw-Hill. He is a registered Professional Engineer in New York, New Jersey, Pennsylvania, and many other states. Mr. O'Brien is a Fellow of the American Society of Civil Engineers, the Project Management Institute, the Construction Management Association of America, and the Society of American Value Engineers International. He is also an active member of the Association for the Advancement of Cost Engineering International. Mr. O'Brien is a charter member and a vice president of the PMI College of Scheduling.

FREDRIC L. PLOTNICK, ESQ., P.E., is CEO and principal consultant of Engineering & Property Management Consultants, Inc. He has bachelor's and master's degrees in civil engineering and is a registered Professional Engineer in Pennsylvania, New Jersey, and Florida. He is also an attorney and a member of the bars of Pennsylvania, New Jersey, and Florida. Mr. Plotnick is an adjunct professor of the departments of Civil Engineering, Engineering Management, and Construction Management at Drexel University, Philadelphia, Pennsylvania. He is a past president of the Philadelphia chapter of the Pennsylvania Society of Professional Engineers, past Construction Group chair of the Philadelphia section of the American Society of Civil Engineers, and member of the Association for the Advancement of Cost Engineering International. He is a charter member and director of Academic Liaison and the Technical Track of the annual conference of the PMI College of Scheduling.



---

# Preface

The original purpose of this book, in 1965, was to present and discuss the critical path method (CPM) and its use in the construction industry. At that time, CPM was a young but proven technique—usually considered to be optional. When the second edition was published in 1971, the network approach to scheduling was becoming a regular requirement in construction contracts. The third edition, published after 25 years of experience in the application of CPM, described highlights of that experience and its significance to the practical use of CPM.

The basic strength of CPM continues to be its ability to represent logical planning factors in network form. One reviewer noted: “Perhaps the most ironic aspect of the critical path method is that after you understand it, it is self-evident. Just as an algebra student can apply the rules without full appreciation of the power of the mathematical concepts, so can the individual apply CPM or its equivalent without fully appreciating the applicability of the method.”

The book first describes the development of CPM and its practical use in the construction industry. The basic technique is described in sufficient depth for the reader to apply it to practical construction situations. The John Doe case study is used throughout the book to describe basic CPM network techniques and then to illustrate such special functions as updating, cost control, resource planning, and delay evaluation. Optimum methods of specifying the use of CPM are described in sufficient detail to be incorporated directly into construction specifications.

Since the second edition, CPM has become widely utilized as an analytical tool in the evaluation, negotiation, resolution, and/or litigation of construction claims. This aspect is thoroughly explored in the current edition. Legal precedents for the use of CPM during litigation are provided.

In the 1980s, computer calculation shifted from mainframe programs to personal computers (PCs). PCs were the wave of the past two decades. The ubiquity in the 2000s of the internet and the wave of additional interconnectivity linking individual PCs now has the appearance of coming full circle and bringing back to CPM many of the strengths and

weaknesses of the era of the mainframe. However, the approaches and procedures suggested in the first five editions are, almost without exception, still valid.

Network techniques are basic and logical, but assimilation of the network concept does take time. Further, an effort is required to build an experience level, which in turn builds confidence. This book aims to be a useful element in the development of that conceptual experience and confidence on the part of new users of CPM techniques.

*James J. O'Brien, P.E., PMP*

I was introduced to the concepts of CPM as a student in college for 2 weeks in a course covering many aspects of construction management. It was a revelation and led to additional independent study, including a grant of computer time (on the giant mainframe) from Drexel University's Computer Center (Philadelphia, PA), on which my first CPM software program was written. It was at this time that I realized the potential value of CPM to resolve disputes involving delay that planted the seed for my future legal education.

Several years past, during which I worked for several construction and consulting firms, and a stint as assistant corporate counsel for a large firm involved in international construction. In 1983, I formed EnProMaC (Engineering & Property Management Consultants, Inc.) Interestingly, in 1983 Joel Koppelman and Dick Faris formed Primavera Systems. One of my first efforts was to rewrite my CPM software program to run on my Osborne I (a pre-IBM PC with 64 KB of RAM and 90 KB of floppy disk storage) running as a routine under dBASE II (a database program by Ashton Tate). At that time, I never dreamed that a market might exist for such software—assuming such could be rewritten for user friendliness.

The success that Messrs. Koppelman and Faris achieved in launching Primavera is largely based upon their attention to making their software user friendly—and in giving their customers that which is asked for. CPM theory has a number of limitations, as does any system that attempts to model reality. Bending the rules of CPM analysis can, in some instances, circumvent these limitations. In many cases special features have been added to Primavera, which have legitimate uses in very limited situations, but which should be used with extreme care. The many competitors of Primavera also have added features that extend and modify the basic concepts of CPM—each in their own fashion—and each that differ subtly from each other. One of my contributions to the 5th edition was to address these special features, and the proper use of them.

One of the factors in forming EnProMaC was that, in 1982, Drexel University asked me to create a course on CPM. I have been teaching that

course, as well as courses on contracts and specifications, engineering law, and project administration, ever since. The give and take of classroom discussion with students ranging from candidates for a 30-hour certificate (through the local GBCA) to candidates for the Ph.D. degree over these many years has further pushed me to more fully examine the mathematics behind CPM and other scheduling systems. It is my hope that my contributions to this edition will bring the confluence of the basic theory of mathematics, the applied discipline of engineering, and the framework for collaboration by adversarial parties provided by the study of law, all to assist the practitioner of planning and scheduling.

*Fredric L. Plotnick, Esq., P.E.*

*This page intentionally left blank*

---

# Acknowledgments

The writing of this sixth edition has involved the assistance of numerous individuals who have provided technical advice on the computer software products discussed, feedback from the field for the case studies discussed, editorial review to combine the writing styles of the two authors into one more readable style and moral support throughout the process of writing and rewriting and editing and proofreading and publishing. Special recognition is accorded to the following individuals.

Rita O'Brien and Kim Plotnick for strong silent (and not too silent) support

Larry Hager of McGraw-Hill for coordination of efforts and setting deadlines for the authors

Pamela Pelton of McGraw-Hill for coordination of publishing

Neha Rathor of International Typesetting and Composition for editorial review

Ben Kolstad of International Typesetting and Composition for layout of text and graphics

Kristy Tan and Jennifer Coyle of Primavera Systems for technical questions regarding P3 and P3e/c

Nicole Styer of Primavera Systems for coordination of the CD-ROM

John Owen, Robert Blakeney and Andrew Ely of Welcom for technical questions regarding Open Plan

Dan Patterson of Pertmaster for technical questions regarding Pertmaster and MCA

Jon Wickwire, Esq. of Wickwire Gavin, P.C. for reference to current legal cases involving CPM

Dan Lynch, P.E. of SEPTA for the SEPTA Railworks case study

Tom Driscoll of URS for the NJ Turnpike case study

**xx Acknowledgments**

Richard Smyth of Jet Blue for the JFK Airport Redevelopment case study

Louis Tucciarone of URS for the Toronto Transit case study

Gordon Bryan and Jon Mountenay of American Infrastructure for the Route 76/202/422 case study

Pradip Mehta of PA of NY&NJ for the Port Authority of NY and NJ case study

Joseph Fisher of Hunt Construction Group for the Maricopa County case study

and many others who have assisted in the Sixth and previous editions.

# Introduction to CPM Planning and Scheduling

*This page intentionally left blank*



# Introduction to CPM Planning and Scheduling

This introduction discusses some factors that make the case for why planning and scheduling is best performed by the Critical Path Method (CPM). It covers some of the history behind its development and relays some thoughts on where the process may be going in the future. The interplay between the theory of mathematics that underlies the methodology and the modifications needed to make the methodology more practical are themes that continue throughout the text. It is hoped that the conclusion drawn by the reader will be that it is the Scheduler who must balance these two ideals, mathematics and engineering, to provide a useful and user friendly tool to the users of CPM in construction management, manufacturing, software design and other users in the world of projects that must be finished on time and within budget.

## 1.1. Scheduling is for Everyone

Scheduling is a discipline that is performed by every person, every day. Should you first shave or brush your teeth in the morning? If you are scheduling for one person only, the process is rather simple. You can prepare a “ToDo” list and then choose in what order the items on it are to be performed. However, the choice of what to do first is not completely random. Perhaps there are physical restrictions, such as “shower before dressing” or “cook breakfast before eating.” Perhaps there are logistical restrictions, such as combining one trip to buy milk, pick up the dry cleaning, and refuel your car, rather than making three trips to accomplish these three items on your “ToDo” list. Perhaps the order of performance is pure personal choice, such as put on right shoe before left shoe.

Even at this simple level, not all is what it seems to be. If you are in a hurry, you might begin eating a portion of your breakfast while still cooking the rest. If your dry cleaner is open only from 10:00 AM to 6:00 PM and if your car is very low on gas, you may have to refuel on your way to work, pick up your dry cleaning at lunch, and buy milk on the way home from work. If you have a foot or leg injury, you may need to put on your left shoe first.

If you want to schedule the tasks of two or more persons or the work flow of two or more machines (even if both are under the supervision of one person), the process becomes much more complex.

### 1.2. We Teach Carpentry—Not “How to Use Your New Power Saw”

If the process of scheduling were a simple matter, requiring merely rote actions without the need for thought, perhaps good schedules could be created by a software Wizard. After clicking your way through a preset series of screens, you would have your schedule. Perhaps, then, the request of an old client for a device where building blueprints are fed in one end and a schedule is printed out the other end would be feasible. Alas, it is not so—scheduling is a complex process and the mathematical underpinning *is* at the level of rocket science.

Scheduling is an application of special knowledge or judgment of the mathematical, physical, or engineering sciences to the conception or implementation of creative work. Scheduling, formally or informally, good or bad, is practiced in the planning, progress, and completion of designs, analyses, or implementation performed in connection with utilities, structures, buildings, machines, equipment, processes, systems, works, projects, and industrial or consumer products or equipment of a mechanical, electrical, electronic, chemical, hydraulic, pneumatic, geotechnical, or thermal nature. The wording of the preceding sentence is taken from the statute defining Engineering for a reason, that being, that scheduling is a branch of engineering.

Implicit in the teaching of engineering, or of the supporting fields of science and mathematics, is the need to understand the process and not merely to blindly trust the black box desired by that old client. It is important to understand the mathematical underpinning of modern CPM software rather than to merely begin clicking away. Children are still taught how to add and how to spell even though they have access to calculators and computer aided spell-checks. One reason is that even the best spell-check software can leave errors uncaught. Another reason is to understand what the numbers on calculators mean. Many of us may remember a freshman physics class where we were taught that  $2.5 \times 3.01$  is not equal to 7.525, but rather to 7.5, since

the result will never be more accurate than the least accurate input. (For those who have not taken Freshman Physics,  $2.50 \times 3.01 = 7.53$  and  $2.500 \times 3.010 = 7.525$ .)

Even the terminology can be misleading. CPM was once noted as a tool in the process of *Planning and Scheduling*. First we must plan, then we can use the computer to perform the rote calculations (that we understand and could perform given time) to generate the schedule, and then we must read the output with a knowledge of the assumptions and tolerances involved. Today, however, we can purchase software that includes a Wizard to simplify or ignore the need for planning, perform the calculations while allowing user overrides to generate the “correct” or “desired” result, and provide killer report and graphics applications to display the schedule results.

It is the purpose of this text to teach carpentry and not merely the features and benefits and how to use your new power saw. It is the purpose of this text to teach the process of planning and scheduling by means of the Critical Path Method of Analysis. We can best start by reviewing how this field of mathematics and engineering was developed.

### 1.3. History of Scheduling Systems

The Critical Path Method (CPM) was developed specifically for the planning of construction. The choice was fortuitous, since construction accounts for more than 10 percent of the annual gross national product. Almost every activity and every person is affected to some degree by new construction or the need for it. Most projects are started well after the need has been established, seeming to follow the whimsy, “If I’d wanted it tomorrow, I’d have asked for it tomorrow.”

The construction industry is a heterogeneous mix of companies ranging in size from the large operations to one-person operations. No matter the size, construction companies face similar situations and, to some degree, similar pressures. Many factors, such as weather, unions, accidents, capital demands, and work loads, are either beyond individual control or difficult to control. New problems in project approvals due to increased public awareness include pollution and ecological controls. CPM does not offer clairvoyance, but it does assemble all the information to the project managing team.

Initially, CPM spotlighted construction and the contractor. The owner, architect, engineer, and public agencies involved in a project are like the backer, producer, and director of a Broadway show: Without them, the show cannot go on, and any lack of competence, motivation, or interest on the part of any one of the team members can delay a project. However, the contractor is the performer who ultimately makes or breaks the construction show.

The typical contractor is a planner who generally uses instinctive methods rather than formal scheduling. Prior to 1957, contractors had little choice than to operate this way because no comprehensive, disciplined procedures for planning and scheduling construction projects existed. And prior to the mid 1980s, contractors desiring to utilize the benefits of the newer methods had to rely upon outside consultants, who in turn had to rely upon computer service bureaus and their large mainframe computers.

One of the keys to the success of CPM is that it utilizes the planner's knowledge, experience, and instincts in a logical way first to plan and then to schedule. CPM can save time through better planning, and in construction, time is money.

The Egyptians and Romans worked construction miracles in their day, and surviving ruins attest to the brilliance of their architecture, but little is known of their construction planning and scheduling. Other historical project managers included Noah, Solomon, and the unknown architect who designed the tower of Babel. Again, history records much about the construction details but little about the methods of control.

#### **1.4. The Ordered "ToDo" List**

Many of us make lists of things to do (i.e., a ToDo list.) Those who are well organized may make the list in a logical order—for example, a shopping list based upon the layout of a store or supermarket. Perhaps a fanatic to organization may first make a list of activities (or, from our example, items to be purchased) and then copy it a second time to the preferred order that it is to be performed. The use of word processing or organizing software adds a modern wrinkle to this age-old method of planning and scheduling. However, there are no rules widely published to guide the development of "ToDo" lists.

#### **1.5. Gantt Charts and Bar Charts**

In the mid-nineteenth century, at least one writer discussed a work versus time graphical representation very similar to today's bar charts, but it remained for Henry L. Gantt and Frederick W. Taylor to popularize their graphical representations of work versus time in the early 1910s. Their Gantt charts were the basis for today's bar graphs, or bar charts.

Taylor and Gantt's work was the first scientific consideration of work scheduling. Although their work was originally aimed at production scheduling, it was readily accepted for planning and recording the progress of construction. Today, the bar graph remains an excellent graphical representation of activity because it is easy to read and understood by all levels of management and supervision.

If the bar graph is so well suited to construction activity, why look for another planning aid? Because the bar graph is limited in what information it can retain. In preparing a bar chart, the Scheduler is influenced almost necessarily by the desired completion dates, often working backward from the completion dates. The resultant mixture of planning and scheduling is, unfortunately, no better than wishful thinking.

When a bar graph is carefully prepared, the Scheduler goes through the same thinking process as the CPM planner. However, the bar graph cannot show (or record) the interrelations and interdependencies that control the progress of the project. And, at a later date, even the originator is often hard pressed to explain the plan by using the bar graph.

Figure 1.5.1 is a simplified bar chart of the construction of a one-story office building. Suppose that, after this 10-month schedule has been prepared, the owner asks for a 6-month schedule. By using the same time for each activity, the bar chart can be changed as shown in Figure 1.5.2. Although the chart looks fine, it is not based on logical planning; it is merely a juggling of the original bar graph.

The general contractor usually prepares the overall construction plan, which is sensible because the schedules of the other major contractors depend on the general contractor's schedule.

Note that in Figures 1.5.1 and 1.5.2, the general contractor's work is broken down in some detail, with both the mechanical and electrical work shown as continuous lines that start early and end late. In conformance with the bar graph "schedule," the general contractor will then often push the subcontractors to staff the project as early as possible with as

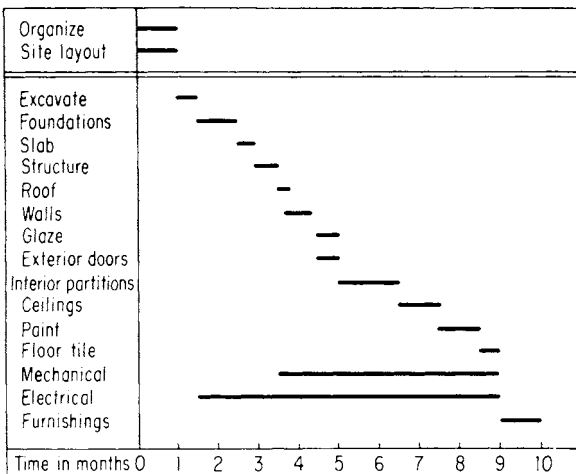

Figure 1.5.1 Bar chart for a one-story building.

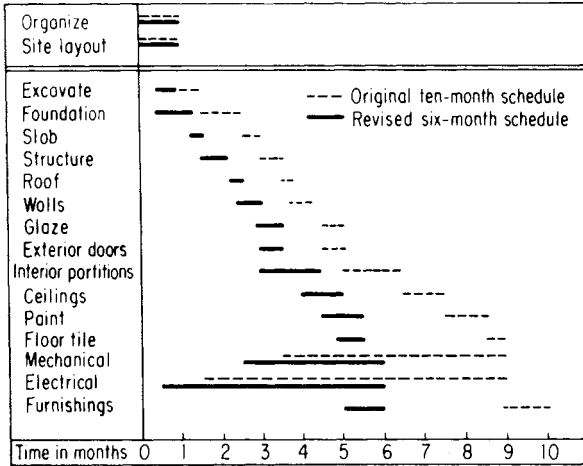

Figure 1.5.2 Revised bar chart for a one-story building.

many mechanics as possible. Conversely, the subcontractors want to come on the project as late as possible with as few mechanics as possible. The result is that the general contractor will often complain that the subcontractors are delaying the project through lack of interest. At the same time, the subcontractors will often complain that the general contractor is not turning work areas over to them, forcing them to pull out all of the stops to save the schedule.

As in most things, the truth lies somewhere between the extremes. CPM offers the means to resolve these differences with specific information rather than generalities.

The bar chart often suffers from a morning glory complex: It blooms early in the project but is nowhere to be found later on. We can suppose some general reasons for this disappearing act. Prior to the construction phase, the architect, the engineer, the owner, or all three are trying to visualize the project schedule in order to set realistic completion dates. Most contracts will require the submission of a schedule in bar graph form soon after a contract is awarded. Once the project begins to take shape, however, this early bar chart becomes as useful as last year's calendar because it does not lend itself to planning revisions.

Although progress can be plotted directly on the schedule bar chart, the S curve has become popular for measuring progress. The usual S curve consists of two plots (Figure 1.5.3): the scheduled dollar expenditures versus time and actual expenditures versus time. Similar S curves can be prepared for labor hours, equipment and material acquisitions, concrete yardage, and so on. Though this presentation can be interesting, it does not provide a true indication of project completion.

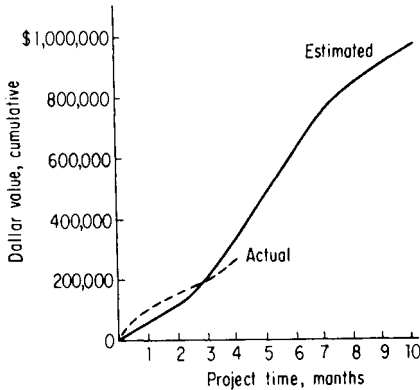

Figure 1.5.3 Typical S curve.

For instance, a low-value critical activity could delay the project completion far out of proportion to its value.

Misuse of bar charts does not prove that they should be discarded. To throw out bar charts is like throwing out the baby with the bath water.

## 1.6. Development of the Critical Path Method of Scheduling

In 1956, the E. I. DuPont de Nemours Company set up a group at its Newark, Delaware, facility to study the possible application of new management techniques to the company's engineering functions.<sup>1</sup> The planning and scheduling of construction projects was one of the first areas studied. The group had a UNIVAC I computer (the third unit built) at its disposal, and they decided to evaluate the potential of computers in scheduling construction work. Mathematicians worked out a general approach; they theorized that if the computer was fed information on the sequence of work and the length of each activity, it could generate a schedule of work.<sup>2</sup>

In early 1957, the Univac Applications Research Center, under the direction of Dr. John W. Mauchly, joined the effort with James E.

<sup>1</sup>Hayward and Robinson, *Preliminary Analysis of the Construction Scheduling Problem*, internal paper, Engineering Department, DuPont Company, December 1956.

<sup>2</sup>James E. Kelley and Morgan R. Walker, "Critical Path Planning and Scheduling," *Proceedings of the Eastern Joint Computer Conference*, pp. 160–173, Dec. 1–3, 1959; see also James E. Kelley, "Critical-Path Planning and Scheduling: Mathematical Basis," *Operations Research*, vol. 9, no. 3, pp. 296–320. 1961.

Kelley, Jr., of Remington Rand (UNIVAC) and Morgan Walker of DuPont in direct charge at Newark, Delaware. The original conceptual work was revised, and the resulting routines became the basic CPM. It is interesting that no fundamental changes in this first work have been made.<sup>3</sup>

In December 1957, a test group was set up to apply the new technique (then called the Kelley-Walker methods). The test team (made up of six engineers, two area engineers, a process engineer, and an estimator) and a normal scheduling group was assigned to plan the construction of a \$10 million chemical plant in Louisville, Kentucky.

As a control, the new scheduling team worked independently of the normal scheduling group. This is the only documented case of a comprehensive comparative CPM application. The test group had not been part of the development of the CPM method, but members were given a 40-hour course on the technique before starting the test.

The network diagram for the project was restricted to include only the construction steps. The project was analyzed beginning with the completion of its preliminary design. The entire project was subdivided into major areas of scope, and each of the areas was analyzed and broken down into the individual work activities. These activities were diagrammed into a network of more than 800 activities, 400 of which represented construction activities and 150 design or material deliveries.

The ability of the first team was such that a larger-capacity computer program had to be developed for support. By March 1958, the first part of the network scheduling was complete. At that time, a change in corporate outlook, plus certain design changes, caused a 40 percent change in the plan of the project. Both planning groups were authorized to modify the plan and recompute schedules. The revisions, which took place during April 1958, required only about 10 percent of the original effort by the CPM test team, substantially better than the normal scheduling group.

One significant factor involved the determination of critical delivery items. The normal scheduling group arbitrarily assigned critical categories, which the CPM group determined from its network analysis. From the analysis, it was determined that only seven items were critical, and three of these were not included in the normal scheduling group's list.

The initial test scheduling was considered successful in all respects. In July 1958, a second project, valued at \$20 million, was selected for test scheduling. It also was successfully scheduled. Since the first two projects were of such duration that the complete validity of the system

---

<sup>3</sup>James E. Kelley, "Computers and Operations Research in Road Building," *Operations Research, Computers and Management Decisions*, Symposium Proceedings, Case Institute of Technology, January 31–February 1 and 2, 1957.



could not be established, a shorter project, also at DuPont in Louisville, was selected for scheduling.

The third project was a shutdown and overhaul operation involving neoprene, and one of the materials in the process was self-detonating, so little or no maintenance was possible during downtime. Although the particular maintenance effort had been done many times, it was considered to be a difficult test of the CPM approach.

In the first CPM plan, the average shutdown time for the turnaround was cut from 125 to 93 hours, and in later CPM applications, it was further cut to 78 hours. The resultant time reduction of almost 40 percent far exceeded any expectations.<sup>4</sup>

### 1.7. Development of the PERT Method of Scheduling

The development of CPM was enhanced when the U.S. Navy Polaris program became interested in it. The Polaris program staff had developed its own network system known as performance evaluation and review technique (PERT). The DuPont work is considered antecedent material for the development of PERT.

The Polaris fleet ballistic missile (FBM) system was initiated in early 1957. To manage the program, a Special Projects Office (SPO) was established under the direction of Admiral Raborn. The Office is generally credited with having developed the PERT system.

One of the key people involved in the development of PERT was Willard Fazar, who noted that the various management tools available for managing the Polaris program did not provide certain information essential to effective program evaluation. In particular, they did not furnish the following:

1. Appraisal of the validity of existing plans in terms of meeting program objectives
2. Measurement of progress achieved against program objectives
3. Measurement of potential for meeting program objectives

The search for a better management system continued throughout the fall of 1957. At that time, the Navy was cognizant of the development of CPM at DuPont. In January 1958, the SPO initiated a special study to determine whether computers could be used in planning and

---

<sup>4</sup>Hayward and Robinson, *Preliminary Analysis of the Construction Scheduling Problem*, Engineering Department, DuPont Company, December 1956.

controlling the Polaris program, and on January 27, 1958, the SPO directed a group to undertake the task of formulating the PERT technique.<sup>5</sup>

The goal of the group was to determine whether improved planning and evaluating research and development work methods could be devised to apply to the Polaris program, which involved 250 prime contractors and more than 9,000 subcontractors.

The PERT program evolved, and included the development of detailed procedures and mechanics phases, which were reported in formal documents. The PERT method, as described in the phase II report, was designed to provide the following:

1. Increased orderliness and consistency in planning and evaluating
2. An automatic mechanism for identifying potential trouble spots
3. Operational flexibility for a program by allowing for a simulation of schedules
4. Rapid handling and analysis of integrated data to permit expeditious corrections

The PERT system, programmed at the Naval Ordinance Research Calculator, was implemented in the propulsion component, which was followed by an extension to the flight control and ballistic shell components, and finally, to the re-entry body and guidance component.

About a year after the start of the PERT research, the system was operational. This was outstanding considering the typical 36 percent time overrun for developing other weapons systems.

Following its success in the Polaris program, PERT was incorporated voluntarily in many aerospace proposals in 1960 and 1961. In some proposals, PERT was added principally as window dressing to make the proposal more attractive to the government. But thanks to its basic soundness and the acumen of the engineering staff members involved, PERT often stayed on as a useful planning tool even though it had entered some companies through the backdoor.

### 1.8. Comparison of CPM and PERT

The key difference between CPM and PERT is that one identifies activities of finite and reasonably estimated duration while the other identifies

---

<sup>5</sup>D. G. Malcolm et al., *A Network Flow Computation for Project Cost Curves*, Rand Paper P-1947, Rand

Corporation, March 1960; D. G. Malcolm, J. H. Roseboom, C. E. Clark, and W. Fazar, "Applications of a Technique for Research and Development Program Evaluation," *Operations Research*, vol. 7, no. 5, pp. 646–699, 1959; and W. Fazar, "The Origin of PERT," *The Controller*, vol. 30, pp. 598 ff., December 1962.

events of zero duration separated by “some form of activity” only loosely understood to be performed within a range of possible durations. This range of durations varies from an optimistic estimate (or shortest time until the next event will occur) to a “most likely” estimate to a pessimistic estimate. This dichotomy was understandable since the duration of an activity, relating to a known quantity of work, was fairly capable of estimation; the duration between events, based upon a scope only vaguely understood, was much more a “guestimate.”

The theory behind the PERT method was based upon the interplay between these estimates of duration and the statistical likelihood of a project outcome as the actual duration experienced may fluctuate among the three. However, the early computers of the 1950s and even the 1960s did not have the necessary speed or memory to fully utilize the theory and the three estimates were usually combined into one (often by separate calculation by hand alongside the computer) using the formula

$$\text{DUR} = \frac{(O + 4M + P)}{6}$$

where  $O$  = Optimistic,  
 $M$  = Most Likely and  
 $P$  = Pessimistic.

The important distinction to remember, before considering the newer offshoots of CPM, is that CPM measures performance of defined activities and the durations of defined activities, while PERT measures the reaching of defined events and the passage of time between these events. Another important difference is that CPM durations are of defined events, while PERT durations are of undefined activity between events.

*This page intentionally left blank*

# Project Control Systems Evolve in Academia

By 1960, John Mauchly had left Sperry Rand and formed Mauchly Associates in Fort Washington, PA. Jim Kelley rejoined Mauchly Associates as a principal. Mauchly Associates had a consulting group who both taught CPM principles to in-house industry groups, such as petrochemical and pharmaceutical, and applied CPM to projects, in particular, in the construction industry.

## 2.1. 1960–1965: Logic Systems Gain Acceptance

True conceptual design and testing of CPM was accomplished from 1955 to 1960. In the 5 years that followed, an almost evangelical enthusiasm spurred the conversion of the conceptual into the practical utilization. Many public seminars were given and great project engineer exposure to the techniques was achieved.

Development was spurred especially by three factors: First, the originating DuPont group disseminated information on the planning technique to DuPont customers as part of an overall service policy. Second, the Remington Rand Company, in further computer applications, assisted many of its computer clients in the application of CPM to planning problems. Third, the originating team went into private practice and actively developed the concept and the techniques of applying CPM to a broad range of projects and problems.

The construction industry in general (and the petrochemical industry in particular) became the greatest single area of CPM application. This was fortunate, because CPM had no sponsorship by a particular agency or group; it had to develop and grow on its own merits.

A 1965 survey revealed that only 3 percent of the nation's contractors actively used CPM, but since most of the users were larger contractors, about 20 percent of the nation's major construction companies were actively scheduling with CPM. Of the contractors using CPM, 90 percent were satisfied with the investment in time and effort it required. Actual dollars-and-cents savings in scheduling time and costs were hard to identify, but CPM users believed that savings often exceeded 10 percent.

PERT owed much to the earlier work by Kelley and Walker. Ironically, after a courtesy review of their own work as converted into PERT, Kelley and Walker were astute enough to use the term "critical path" as the new caption of their Kelley-Walker ("main chain") technique.

CPM enthusiasts saw PERT as a competitor and as a factor fragmenting the enthusiastic, but limited, market for network techniques. This feeling was intensified in 1962 when Secretary of Defense MacNamara drafted an executive regulation stating, in effect, that the existence of two different network-based scheduling systems was confusing and that, henceforth, all Department of Defense organizations would use PERT. At the time, this appeared to enhance the development of PERT as a system at the expense of CPM.

PERT was applied to part of the Atlas E and to all the Atlas F site activation programs. It was also used in the Titan I, Titan II, and Minuteman site activation programs. Although the application varied from site to site and program to program, the approach used in Titan I is representative.

A site activation PERT network was developed for each site that was limited to the events that would occur at that site. Within that site network, individual networks were developed. The networks were so arranged that they were compatible with networks prepared by Corps of Engineers contractors as well as planned delivery schedules.

The Corps of Engineers Ballistic Missile Coordinating Office (CEBMCO) used a network monitoring system to monitor the current status of the Titan complexes. The cost of the monitoring system was about 0.5 percent of the site construction cost.

Although large weapons systems and space systems accounted for the largest number of PERT networks and the greatest expenditures on PERT, a number of other agencies picked up the new technique. The Atomic Energy Commission (AEC) used PERT to plan and control the development of new components for atomic weapons. The National Aeronautics and Space Administration (NASA) made broad use of PERT and a form of PERT termed "NASA-PERT" (actually an activity-on-arrow CPM-type network) in its space program planning. Also, such firms as RCA and General Electric, which had recognized the potential of networking in the late 1950s, applied network techniques to their space projects.

## 2.2. 1966–1970: The Fight between CPM and PERT

The concept period of the 1950s and the training and development of the 1960 to 1965 period, continued in the latter part of the 1960s. Although not apparent at the time, acceptance of network techniques broadened as the result of a number of independent factors:

1. The size of programs, such as Apollo, demanded an integrated project control system, and NASA-PERT (or CPM) offered the best vehicle for this type of system.
2. The evolution of network scheduling as a device for controlling a single project was extrapolated into a program control system in which a number of projects could be simultaneously integrated and controlled.
3. The logical basis of the network approach, irrespective of its computer-oriented identity, resulted in an increasing acceptance of its usefulness.
4. Academicians, particularly in civil engineering curricula, recognized the validity of network scheduling as a project control approach, and they were incorporating it into the undergraduate curriculum. Graduating engineers were predisposed to use networks.

The Corps of Engineers, the Navy, and NASA were already utilizing network systems. Other agencies, such as the AEC, the Veterans Administration, and the General Services Administration, followed in their footsteps.

The initial development of CPM included a sophisticated cost optimization approach developed by Kelley and Walker that was included as part of the basic CPM algorithm. This algorithm combined information on crash and normal costs for each activity and estimated an optimal completion time for the overall project. From a theoretical viewpoint, the system is most interesting, but difficulties in collecting the supporting cost and time information have precluded its wide use.

The Kelley-Walker group (Mauchly Associates) also developed a computerized approach to using CPM networks for scheduling labor, which was called the resource planning and scheduling method (RPSM). Concurrently, the CEIR computer consulting organization worked in collaboration with DuPont to develop the resource allocation and labor planning system (RAMPS). Although used on a very limited basis, the extensions were well tested in field applications.

Current computer capabilities have resulted in a number of approaches and proprietary systems. Although today's computer technology greatly facilitated the efficiencies of the computer program systems, the basic principles have not changed.

By 1962, the PERT team had released PERT/Cost, which combined cost reporting with the PERT network and came to be required in many aerospace and defense contracts. The system is technically correct, although it is based on a rather simple premise that the combined cost of the various components completed in a project, when extended, will provide a meaningful prediction of the completion date of the overall project.

Most of the difficulties encountered in using the system have occurred in collecting costs that can be meaningfully combined with the network. The difficulties in reconciling an internal accounting system with the special PERT/Cost breakdown lead the government to the approach designated cost/schedule control systems criteria (CSCS).

International Business Machines Corporation (IBM), NASA, the Navy, and others prepared their own versions of PERT and PERT/ Cost. IBM and McDonnell Automation combined forces to prepare a coordinated version of PERT and PERT/Cost, designated project management systems, or PMS. Although substantial technology was applied in the programming and testing of computer systems for PERT and PERT/Cost, applications tended to simplify theoretical approaches.

Variations of both CPM and PERT were developed by many organizations, usually to get special systems to respond to special requirements. Variations of PERT included SPERT, GERT, MERT, and other systems with acronyms that designated the changes entailed. CPM was recast into precedence networks (PDM), which were substantially different in approach but provided essentially the same calculated result.

### 2.3. PDM

Professor John W. Fondahl, of Stanford University, the early 1960 expert on noncomputerized solutions to CPM and PERT networks, was one of the early supporters of the precedence method, or PDM. He called it the circle and connecting arrow technique. His study for the Navy's Bureau of Yards and Docks included descriptive material and gave the technique early impetus, particularly on Navy projects.

An IBM brochure credited the H. B. Zachry Company of San Antonio with the development of the precedence form of CPM. In cooperation with IBM, Zachry developed computer programs that could handle precedence network computations on the IBM 1130 and IBM 360. This was particularly significant because in 1964, C. R. Phillips and J. J. Moder indicated the availability of only 1 computerized approach to precedence networks versus 60 for CPM and PERT.

Creation of an alternate format for preparing CPM networks required new naming conventions to distinguish between the two. The form for



traditional CPM networks was originally termed the AOA or “activity on arrow” variant of CPM. The form for new style precedence networks was originally termed the AON or “activity on node” variant of CPM. In the AON variant, the activity description is shown in a box (or node) with the sequence, or flow, shown by interconnecting lines. In most cases, arrowheads are not used, although this leaves more opportunity for ambiguous network situations.

Because the terms AOA and AON are similar, and possibly because a box only represents a node to a mathematician, AOA became known as ADM or “arrow diagramming method” and AON became known as PDM or “precedence diagramming method.” Often, specifications copied from older specifications may refer to the CPM being prepared in the AOA or AON method. A sad reflection upon the care in which such engineering documents are written is that it is not unusual for a specification to require the CPM to be prepared using the AOA methodology and to run the schedule upon the latest version of Primavera software (which only supports PDM.)

Computer users have always preferred the PDM format because it readily lends itself to graphical output. Another advantage claimed for PDM is that the diagram is “cleaner” and, therefore, easier to follow. The simplifying factor results from the fact that “redundant” restraints are not required in PDM (as they are in CPM) to create unique activity numbers (i.e., when activities span between the same two events).

Until recently, schedulers could request that their network computer calculations be performed in either ADM (activity-on-arrow) or PDM (precedence diagramming method). Primavera’s scheduling software had been typical of this two-way option (i.e., ADM or PDM). However, when Primavera software writers created a Windows version, they opted to use PDM as the platform for the flagship program. The impact on scheduling in the construction industry is substantial and is addressed in this book.

## 2.4. SPERT and GERT

CPM and PERT are based upon mathematics and professors of mathematics were quick to note many of the new insights opened by this new branch of mathematics. If an estimate of duration is merely an estimate and subject to a level of uncertainty, what might happen if randomly some of the durations were raised and others lowered? If two or more paths of the logic network were fairly close, this modification may well shift the critical path and overall duration of the project. CPM provides a set date upon which a project is expected to be complete. What is the probability of the project finishing on that date, on an earlier date or on a later date? If each of the durations of activities (in CPM) or between

events (in PERT) were randomly chosen between the Optimistic, Most Likely, and Pessimistic Durations, we would get one value for an end date. Repeat this process 100 or 1000 times and we get probabilities of completion over a range of dates.

Unfortunately, computers in the 1950s were not powerful enough to perform such analyses for more than demonstration logic networks of few activities. Today, there are software programs (and supporting hardware) that can perform 1000 iterations for logic networks of several thousand activities in under a minute. Thus, not only can the Scheduler determine the date on which the project can be expected to be complete but also the probability of that expectation.

The mathematics behind neither CPM nor PERT permits Boolean ·OR· logic. If an activity in the logic network “A” is followed by two other activities “B” and “C,” it is assumed that both can start upon the completion of “A.” It is also assumed that “B” can start independently of “C” and vice versa, either starting before the other or both at once. In the real world this is not always true; sometimes you can start “B” or “C” but only one at a time (the Boolean ·OR·). Sometimes you can only perform “B” and “C” if both are performed concurrently. Sometimes the choice of which can be performed first is subject to the status (started or completed) of a fourth activity “D.” And sometimes the choice of successor is based upon a test—pass and go down one path—fail and go down the other path. In the case of a failed test, the logic network can even loop around to retake the test after corrective measures have been taken. None of these possibilities are supported by the mathematics of CPM or PERT. However, many of these possibilities are supported by mathematical models envisioned in the 1950s through today and more recently supported (at least in part) by modern software programs generically noted as GERT programs. As PERT was the acronym for Performance Evaluation and Review Technique, GERT became the acronym for Generalized Evaluation and Review Technique.

## 2.5. RDCPM™

“The more things is different, the more they’s the same.” At of the turn of the millennium, PDM supplanted ADM in the majority of the scheduling world. And yet, numerous serious practitioners noted flaws in the implementation of PDM and many bemoan the loss of rigor of the ADM system. Recent developments highlighted in the professional and technical societies and in academia have drawn attention to the focus upon information relating to individual and groups of activities and the lack of focus upon the relationships between these activities that was the hallmark of the original ADM and PERT methodologies.

Key among these concerns was a lack of a specific definition of relationships between activities other than the traditional “Finish 100% to Start Next” relationship, the description of the reason for a specific relationship between activities and whether the relationship is mandatory or optional, the ability to footnote the duration between activities (lag) to the same degree as that afforded durations of activities, and the failure to calculate or provide access to the calculation of the attributes of these relationships. Research publications submitted in various technical venues, including the Project Management Institute’s College of Scheduling, the Association for Advancement of Cost Engineering International, and the American Society of Civil Engineers, all raise these issues and suggest various means to work around the problems. Invariably, the proposed solutions suggest something akin to the need for “dummy activities” that carry logic between “real activities” (this being the hallmark of the original ADM system).

Posited by the authors of this text is a system that adds the following functionality to a scheduling system. Since the focus of the majority of these embellishments relates to the relationships between activities, a suggested label for this system is RDM or Relationship Diagramming Method. A fully integrated system is also under development by the authors for general dissemination but subject to certification under the trademark of RDCPM™.

The key aspects of a RDCPM™ or RDM system include the ability to:

- Identify nodes representing events or points of time at each point where restraints converge. Such nodes will be similar to the *i*-node of ADM but are established not for the purpose of data entry (as in ADM), but rather for identifying points of merge bias (where several restraints or logic lines come together) and the “mini-milestones” that these points represent.
- Identify the rationale or reason for each restraint, both by a code and description thereof. A physical restraint (erect the walls before the roof) is the most obvious example. Other types of restraint are resources including crew, equipment, reusable forms and others all already part of the thinking of the team preparing the CPM. However, by expanding the recording of assumptions behind the plan used to prepare the schedule, additional power may be gained such as (1) automated guarantees that each activity in the network is preceded by a physical restraint, (2) permitting “what-if” analyses of the impact of limiting or not limiting crews by various craft, reusable forms, or other specific resources, (3) sorting and selecting by reason for relationship, and (4) providing an automated guide to areas of possible corrective action when various events threaten to delay or disrupt timely completion of a project.

- Expand sort and select capabilities to the text of the activity description and various activity codes of the predecessors and successors of an activity. For example, a selection may highlight each instance where work by the mechanical subcontractor is immediately followed by work by the electrical subcontractor.
- Expand the types of relationships between activities to account for how people actually plan their actions, rather than to match the options set by software designers. For example, few people would say “Bob is starting a 30-day activity next week and Mary will start her activity 15 days after Bob has started without regard to how much progress Bob has made.” Rather, more people will say, “Bob is starting a 30-day activity next week and Mary will start her activity when Bob is 50 percent complete.” Thus, if the scope of Bob’s activity changes or if his productivity is other than expected, there will be an automatic change to the lag between the start of work for Bob and Mary.
- Provide the same level of control over lag durations (between activities) as is (1) provided for activities, such as choice of calendar and (2) range of duration for those systems that support PERT and SPERT style calculations.
- Expand the types of duration to include a Trend Duration (“TD”) based upon an adjustably damped comparison between original and actual durations classified by similar work scopes. A separate SPERT style calculation could then be run based upon both the original and trend durations.
- Wrap in the power of GERT types of relationships including (1) B or C to follow A but not both at once, (2) logical loops to cover test failure, corrective action, and retesting, and (3) choice of action based upon progress or status of other activities within the logic network.
- Expand the algorithms used to handle situations where actual performance bypasses the planned logic and where work is performed out-of-sequence. In addition to the choices of “retained logic” that assumes an activity started out-of-sequence to be suspended until its predecessors are 100 percent complete, or “progress override” that assumes that once an activity is started out-of-sequence that the violated predecessor logic is no longer important, there may be a “modified progress override” that assumes that the activity started out-of-sequence may continue to zero remaining duration, but that successors thereof may not start until its predecessors are complete. The choice of algorithm should further be expanded from a project-wide decision to one which may be set by type of restraint (“retained logic” for “physical” restraints, “modified progress override” for “resource” restraints) or even on a restraint by restraint setting by the Scheduler.

- Expand the types of float to include (1) a multi-calendar float (“MF”) attribute to uniformly report float on a chain of activities having dissimilar calendars and (2) a secondary or junior float (“JF”) attribute to indicate the float of support activities leading to an *i*-node or merge point that is selected to be driven by another chain of activities. (This is similar to free float but is attributed to all preceding activities rather than only the immediate preceding activity.)

Many other academic users and practitioners of CPM have suggested similar and other extensions to CPM. Many variants of CPM and extensions thereto exist in university computers. Eventually one of the established software vendors or a new entrant will make such extensions commercially available, and if they are successful, all other vendors will rush to copy the new algorithms. Thus, just as PDM replaced ADM and has become the primary method used in the construction industry today, so too will RDCPM<sup>TM</sup> or some other diagramming method become the standard of tomorrow. Notwithstanding, the basic rules of planning and scheduling are immutable and it is the hope of the authors that all users of CPM will understand and appreciate the basics, whichever conventions and software is used.

*This page intentionally left blank*

# Project Control Systems Evolve in the Marketplace

By the period of 1965 to 1970, CPM theory had been disseminated through academia and the value of computerization had been proven. It was now up to the commercial venture groups to write and market software services to bring this new technique to the marketplace. Again, that this initial development was specifically for construction was fortuitous, since it was in this field that there was a general understanding that the manager of a construction project was to be given unrestricted control over that project. The evolution of CPM was to support this person and not to report the performance of this individual to an “upper management.”

## 3.1. Commercialization 1965–1970

From 1965 to 1970, networking tools evolved into project control systems (PCS), usually for the purpose of managing large programs or multi-project programs. PCS approaches were developed for many projects, including the World’s Fair in New York City, Expo ’67 in Montreal, construction for the State University of New York, the Apollo launch complex at Cape Canaveral, and the Bay Area rapid transit system (BART), but the availability of tremendous amounts of project information, however important and meaningful, presented a new problem. Previously, although decisions had been based on sparse and limited information, the executive mind was essentially uncluttered by facts. Now, with project and resource information flowing in, managers had to determine which data were important and which could be disregarded to reach or establish alternatives for decisions.

### 3.2. Commercialization 1970–1980

The 1970s were highlighted by several diverse new influences that encouraged the acceptance and utilization of the PCS approach. First, engineering school curricula added both network techniques and computer applications to their undergraduate curricula, which resulted in a more natural utilization by recent engineering graduates. Second, the evolution of construction management and better management control became an important corollary by the utilization of construction management. Also during this time, a dramatic increase in construction litigation citing delay as a reason for damages made schedules and their utilization more important to both plaintiff and defendant. The existence and proper utilization of a CPM plan was a significant factor in either supporting a contractor's claim or defending the role of the owner-construction manager in coordinating a project. Finally, the dramatic evolution in computer compatibility not only made basic network systems more available, but also provided an economical support for the implementation of network systems that both tracked a schedule and correlated it with costs and resources.

### 3.3. Early Legal Recognition

The courts gave early recognition to the validity of CPM. In 1972 (Appeal of *Minmar Builders, Inc.* GSBCA No. 3430, 72-2 BOA), the court rejected a claim based on bar graph schedules, stating: "The schedules were not prepared by the Critical Path Method (CPM) and, hence, are not probative as to whether any particular activity or group of activities was on the critical path or constituted the pacing element for the project." Also in 1972, a Missouri Court (*Natkin & Co. v. Fuller*. 347 F Supp 17) stated that bar charts did not "afford an overall coordinated schedule of the total work covered by the contract." An Illinois court (*Pathan Construction Co. v. Hi-Way Electric Co.* 65 Ill. App. ad 480, 382 N.E. 2d 453,460) in 1978 noted that "technological advances and the use of computers to devise work schedules and chart progress on a particular project have facilitated the court's ability to allocate damages."

Early courts stressed the transparency of the original CPM presentations. This may be compared to the court's reaction to the modern variant of PDM as cited in *Donahoe Constr Co.* ASBCA #47,310 et al. 98-2 BCA ¶30.076 (1998.) This case, as discussed in *Construction Scheduling, Preparation, Liability and Claims*, 2nd edition, by Jon Wickwire, Thomas Driscoll, Stephen Hurlbert, and Scott Hillman (Aspen,) notes that the court found "the utility of the baseline CPM schedule as a benchmark for measuring delays in a window analysis was rendered largely ineffective due to improper use of leads and lags." Perhaps the most succinct comment by the court in this 1992 case was that the court found incredible the contractor's expert analysis that "only the first five



days of each activity [footings and slab on grade] were on the critical path.” Perhaps only a portion of the footing and slab were critical, but since there was only one activity each without detail, the court was not going to take the “say so,” by even a well-respected expert.

Thus the shift from more difficult to code to a computer but transparent ADM to the more easy to enter to a computer but opaque PDM could not come at a more problematic time than as the courts transformed from the *Frye*, or “follow the expert you feel more credible,” approach to the *Daubert*, or “show me, Mr. Expert, what you did,” standard now used in federal and many state courts. The key to the early legal recognition of CPM was its total simplicity once it was explained. But as computers got more powerful, software incorporated new features and extensions that might not be deemed so simple.

### 3.4. PCs 1980–1990

The 1980s saw a shift from mainframe software (MSCS/Project2/Artemis) to personal computer-oriented programs (Primavera, Aldergraf, MicroPert). This shift brought Schedulers face-to-face with the computer screen. Because many engineering undergraduates became personal computer (PC) users in college and scheduling software became so affordable, many smaller organizations began applying scheduling in-house.

In 1982, a review of 40 CPM/PDM programs showed:

	Number of programs	Percentage of total
Arrow diagram	35	87.5
Precedence	32	80.0
Both	26	65.0

Of the 40 programs, 30 required expensive mainframe hardware. Of the 10 mini-computer programs, the purchase price for 9 averaged \$35,500. The tenth sold for \$1.1 million. Most of the programs could be leased for \$1200 to \$3500 per month (with lease payments credited to purchase). Thus, the high cost of software made service bureaus a practical way to process networks. At least 5 of the 40 programs were offered only through service bureaus. In the early 1980s, 8 of the 40 programs in the 1982 survey had been converted into a PC version. The conversions included PROJECT/2, by Project Software Development, Inc. and MSCS, by McAuto. The third edition of this text (1984) listed 68 sources for CPM/PDM software.

### 3.5. PCs 1990–2000

By 1992, 32 of the 40 programs available in 1982 had disappeared, and so had most, if not all, of the service bureaus. The 68 sources for CPM/PDM software listed in 1984 showed only 10 “survivors” by 1992.

Primavera Systems was on both the 1984 and 1992 lists of CPM/PDM software firms. Having crossed the millennium, Primavera Systems has become THE software for the construction industry, with more than 35,000 members of the construction industry holding over 350,000 licensed copies of P3 Primavera Project Planner and Suretrak. This well exceeds 95 percent of the market.

The widespread use of PCs by the 1990s transformed the use of CPM. Previously, each “run” of the software had a significant expense and often was available only once per day (running overnight from a service bureau) unless the user was willing to pay an even higher fee for “premium time” use. Project personnel often spent many hours carefully reviewing the input to assure that a “run” would not be wasted by either an error message or a bad result. All at once users could make multiple runs, allowing the computer to be used to “locate” errors of the input. Additional runs could be made for various “what if” scenarios and further refinement of claims analysis allowed the use of the Windows (or multiple time period) methodology first discussed in the 4th edition (previously known but deemed too expensive to pursue other than as an academic exercise).

Coincident with the more popular use of the Windows methodology for analysis of delay, was the introduction of the similarly named Windows operating system by Microsoft. And with the more powerful computer architectures now possible with this more powerful operating system, many software companies, including those providing CPM software, were required to rewrite their software from scratch. In addition, a new and potentially “larger than the construction world” customer base for CPM software, that of the IT or information technology world, began to develop a desire for CPM. This customer base, having a less detail-oriented need for the rigor of classical CPM, usually desired the PDM variant that allowed a good deal of “fudge” in defining the relationship of one “activity” to another. This general shift from ADM to PDM through the 1990s led to further discussion of this variant in the 5th edition.

### 3.6. PCs 2000–2005

The use of Primavera’s newer flagship software, P3e Primavera Program Manager, by the intellectual technology, aerospace, manufacturing, and other industries now exceeds 1,000,000 licensed copies, although this represents only a fraction of the larger market, which is dominated by MicroSoft Project. (The IT and other industries account for some portion of the P3 and Suretrak licenses, and a growing number of the construction industry companies are converting to Primavera’s P3e/c for construction as well as Primavera’s latest offering Primavera Construction.)

The large number of non-construction users and their differing needs now drives the development of software upgrades. This group typically sees a smaller distinction between tasks, activities, and projects—one

individual's "project" may be to personally prepare the code for one module of a larger piece of software, all of which are part of a "program." Keeping track of the progress of these highly trained individuals (or resources) who may be working at various locales around the world, is more of a matter of coordination than the choreography necessary for running a once-off construction project.

The newest features of the software, therefore, are focused upon collaboration and reporting of various levels of detail (from "task" to "activity" to "summary activity" to "project") to upper levels of management, preferably on a real-time basis. It is expected that any individual or "resource" performing "work" will do so on a computer. The concept that productivity can be measured by each swing of a hammer recorded on a real-time basis much like a click on the keyboard is obviously not correspondent with the real world of construction. However, the software continues to provide the basic calculations necessary to schedule a logic network if a proper logic network is prepared by the project team.

The latest "improvements" to the software provided by various vendors also assist project managers (and the Scheduler serving the project manager) to provide better communication to upper management and other interested parties. The tools are still good and new features add value; however, the default is that the features are tweaked to the larger marketplace of IT and not construction. It is a paradox that this new power made available to the casual user makes it ever more important that the user be knowledgeable in the underlying theory of CPM. Proper understanding and use of these new tools that are not necessarily tweaked to construction and related fields is required and is addressed in this edition.

### 3.7. PCs 2005–2010

The mighty ship *USS Scheduling* is coming full circle. While once-upon-a-time, project managers could not understand "these new-fangled" logic networks that were run by "computer specialists" from headquarters and preferred the use of "old fashioned" bar charts, the advent of untethered PCs in the 1980s led to the general acceptance of CPM by project managers and their staff members. The consolidation of PCs to a worldwide network (and the attendant need for network administrators setting standards above the level of a project, even to the suggestion that there should be a standard method or "module" to install pipeline or erect a wall) has led many project managers to leave the preparation of professional schedules to the professionals and to plan their jobs with the module barchart blocks, rather than at the level of detail grudgingly accepted in the 1970s to 1990s. It is all fine and well that the accounting department need not expend resources to measure project productivity in the field, but if the cost is to add an additional burden to the already overworked project manager and reduce the usefulness of the schedule to *this* project, the

field may fall back upon the bar chart and even the old ToDo list to manage the project.

A successful project trumps all, however, and the successes of better project managers who properly use the new tools will again lead others to relearn the lessons of the 1970s and 1980s. Perhaps we will have stealth project managers running bootleg CPM schedules under the radar. Perhaps these most successful project managers will demand and get the autonomy necessary to base their project plan upon the needs of the project and not other more global concerns. Perhaps the mighty ship *USS Scheduling* will continue another 180 degrees and usher in a new era of personal computing where a wireless connection to the web is used to provide and not drain resources from the project managers' credo, that is, the project comes first.

### 3.8. The Sixth Edition

The construction industry has long recognized this text as the leading scheduling authority. Many specifications prepared by the leading engineering design firms throughout the United States specify that the project CPM is to be prepared and administered in accordance with the principles stated in the text. In June 2004, the Planning & Scheduling Committee of AACE International recommended the 5th edition as the primary reference to be used to prepare for their new Planning and Scheduling (PSP) Professional Certification examination.

In 2002, a charter group (including co-authors O'Brien and Plotnick) formed the Project Management Institute (PMI) College of Scheduling (COS). One of the several reasons for forming the COS is the concern of many experienced schedulers that many bad construction schedules are being generated by "screen jockeys" using powerful software, such as Primavera P3, without a sound underlying understanding of scheduling and/or construction. A number of the issues raised with misuse of the additional power of such powerful software are addressed in Chapter 9 (Adding Complexity.)

All prior editions emphasized the development of a logical plan as the base of a meaningful schedule. In PDM output, the logic of the plan may not be clear or evident. This edition demonstrates the proper use of popular scheduling software products (such as Primavera's P3 and P3e/c). It also demonstrates how the software can be misused (intentionally or unintentionally) to produce or force incorrect results. A comparison is made between the P3 and P3e/c programs where applicable and the features of these products are compared with other popular software products.

There are options and practices described in the 6th edition that can result in output in which the logic plan can be more readily apparent.

Two published articles in the Technical Track at the COS first annual conference in 2004 addressed this problem with a new mathematical approach, which was highlighted in the ENR coverage of the conference. These insights are added to the 6th edition.

Case studies of the successful use of CPM scheduling on major projects in the past 5 years are updated. The chapter on the use of CPM in claims and litigation is expanded to include references to relevant litigation in the past 5 years. Use of a Windows approach in Time Impact Analysis is discussed in more detail. This consideration is important in determining whether delays are concurrent (or non-concurrent), which is important in allocating responsibility for delay. A chapter on the use of CPM in determining and proving disruption has also been added.

In the 5th edition, Chapter 26 closed the book with a brief reference to advanced topics such as PERT, SPERT, and GERT. These topics and risk analysis in scheduling are expanded with examples and illustrations.

The 6th edition expands the hands-on coverage of microcomputer software systems first covered in the 5th edition. A significant part of this coverage in the previous edition consisted of 43 screen inputs and/or outputs of the Primavera P3 System. Comments from users of the text noted that these screen shots were shrunk to 6" × 9" page size, making them hard to read. This problem was exacerbated by printing the screens in black and grey tones and equated to watching color TV on a black and white set. This edition necessarily has similar screens: however, the attached CD has the same screens in color and larger size (i.e., the size of the computer screen, which is almost three times the size of the screens in the book). We also added new P3 and P3e/c screen examples to this edition.

Over time, a dichotomy developed between ADM and PDM users. Primavera cut the Gordian knot by selecting PDM exclusively. On the other hand, to toss out all ADM experience would be an unconscionable waste. Two construction management professors, Richard Smyth at New York University and Fredric Plotnick at Drexel University, both said that ADM was the only way to teach scheduling theory, and that PDM had to be given its due as THE way to calculate and present schedules today. Each said that they do that by separating theory and computer practice.

As a result, this book is organized into the following sections:

- I. INTRODUCTION TO CPM PLANNING AND SCHEDULING
- II. THE THEORY OF CPM PLANNING AND SCHEDULING
- III. THE TOOLS OF CPM PLANNING AND SCHEDULING
- IV. THE PRACTICE OF CPM PLANNING
- V. THE PRACTICE OF CPM SCHEDULING
- VI. ADVANCED TOPICS

*This page intentionally left blank*

---

Part

# 2

## **The Theory of CPM Planning and Scheduling**

*This page intentionally left blank*



## Your New Tool— Read Before Using

Attached to the rear cover of this text is a CD-ROM disk including a fully functional demonstration copy of the Primavera P3 software product. This demonstration copy is limited only in the number of activities that can be included in schedules calculated with the software. Also provided is a fully functional, 90-day trial copy of Primavera Construction. (This may be extended by purchase of a license from Primavera). However, like the instructions provided when you purchase a new power saw, it is highly recommended that you fully read how these products work before you attempt to use them.

### 4.1. Primavera and Your Power Saw—Useful but Dangerous Tools

The defacto standard for scheduling software in the construction industry has been Primavera Project Planner, also known as P3. In 2000, Primavera Software Systems improved upon its P3 software with the introduction of Primavera Program Manager P3e for use by the manufacturing and IT industries, and subsequent release of Primavera Program Manager for Construction P3e/c. However, due to the additional power of P3e/c, requiring additional computer resources and training (both at the user and at the administrator level) in return for limited additional benefits for most small- to medium-sized contractors, engineers, and owners involved in the construction industry, P3e/c has not quite yet taken off in the construction venue. This shift from “the superintendent does it all on his laptop” to “the organization’s administrator sets company-wide coding standards” created some resistance to conversion. This resistance may change as the additional features of version 5.0 are recognized or yet other features are added that are of benefit

to this large base of smaller users. At some point, there may be a massive shift to the newer system. Primavera recognized this in 2004 to some extent with the release of a “P3e/c Lite,” marketed as Primavera Construction and aimed at small- to medium-sized construction firms.

Then again, as databases become larger, tie-in applications more desired, and wireless technologies become ubiquitous, P3e/c may be leapfrogged by an even more useful platform by Primavera. Similarly, the competitors of Primavera are not sleeping. However, for purposes of demonstration of the working of a standard CPM software tool, this text features Primavera Project Planner P3 with references to the other software provided by Primavera and its competitors where appropriate.

The major differences that distinguish one software system from another are the ease of input, the ease of and variety of means of reporting output, and the features that permit the user to get around some of the limitations of the mathematics upon which CPM is founded to more perfectly model the real world. As noted in the introduction to this text, in the real world, you may begin eating a portion of your breakfast while still cooking the rest. But would you ideally plan to do it on a regular basis? Even here, you are planning and scheduling your activities. You may begin drinking your coffee while cooking an egg, but you will want to heat the pan prior to pouring the egg in. If you desire a breakfast sandwich, you will hopefully start the toast going before the egg is fully cooked. Primavera (and other software systems) permits you to show cooking and eating the breakfast as overlapping activities without the need to show the detail of how and how much overlap is to be accomplished. The bar chart provided by Primavera (see Figure 4.1.1) may well show the two activities as starting at the same time. Worse, if not careful, the software may show you completing the eating before completing the cooking. To reiterate, it is the intention of this text to teach the proper means of planning and scheduling as well as the shortcut tools available so that your schedules will not make this mistake.

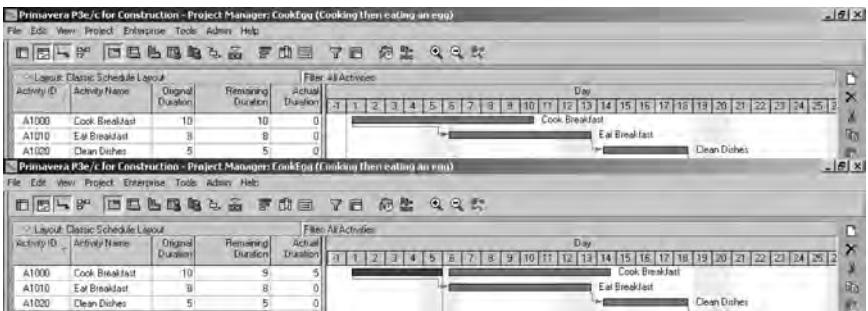

**Figure 4.1.1** Original plan is start cooking (10 min) and begin eating while finishing cooking. Actual was started cooking breakfast, dropped eggs, cleaned up, continue cooking. CPM scheduled at start and rescheduled at 5-min point.

## 4.2. How Does Primavera (or Other Scheduling Software) Work?

Quite a bit of discussion of the mathematical origins of CPM analysis and the migration of pure mathematics to an engineered system for the planning, scheduling, and control of a project, has been presented. At first, the process of CPM may seem trivial or it may seem strange and rather counterintuitive, but like any system based in mathematics, it is grounded in basic axioms. Modern software systems are forgiving and may allow the user to ignore some of these axioms, but only at the risk that if not truly understood, the calculated output may be less than accurate.

## 4.3. What Goes In . . .

Any project can be subdivided into a list of activities or tasks. For purposes of precise terminology of the Critical Path Method of Planning and Scheduling, tasks are scopes of work that are components of activities. An activity can be composed of one or several tasks. The order in which the tasks of an activity are performed may be irrelevant or may be so obvious that formal instructions would not be given to those performing such tasks. Thus, when changing a tire on a vehicle, the activity “remove lug nuts” is composed of tasks “remove first lug nut,” “remove second lug nut,” etc. and need not be separately specified, while the tasks of the activity “replace and tighten lug nuts” may either be stated as separate activities or not, depending upon the experience of the person placed in charge of this scope of work.

The level of detail of specific activities may vary, but it is an axiom of all Critical Path Methods of scheduling that each activity (or specified portion thereof) can start only upon 100 percent completion of some other activity (or specified portion thereof), except for a first or starting activity that does not have a stated predecessor. With an event-based system, such as PERT, each specified event can occur only after some other event has occurred, other than a first or starting event that does not have a stated predecessor. The methodology supports only “hard” relationships, even if the relationship is loosely defined, and does not support “fuzzy” relationships, of what *may* occur. Even the probabilistic methodologies of SPERT and GERT are based upon “hard” estimates of probabilities, and not merely upon random choice. CPM is a discipline of engineering and not merely an application of intuition. This is the basis of its many strengths, as well as its weaknesses.

## 4.4. The Initial Logic Network—Input

Often forgotten in classes on use of scheduling software is the idea that the software is only a tool and that the output will only be as good as the input.

This is the GIGO or “Garbage-In, Garbage-Out” rule. The purpose of the software tool is to assist with some of the laborious calculations that are required by this mathematical analysis but still requires care with the input, much like a power saw cuts through wood faster and cleaner than a hand saw, but still requires care in measuring where to cut.

#### 4.5. The Logic of the Logic Network

The backbone of the traditional implementation of the Critical Path Method is a graphical model of a project. The basic component of the model is the *arrow*. Each arrow represents one *activity* in the project. The tail of the arrow represents the starting point of the activity, and the head represents the completion. The arrow is not a vector and it is not drawn to scale. It can be curved or bent as required; however, it cannot be interrupted because it is a separate entity.

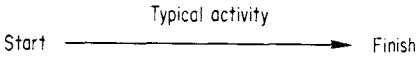

#### 4.6. Arrow Diagram

The arrows are arranged to show the plan, or logical sequence, in which the activities of a project are to be accomplished. This is done by answering two questions with each arrow:

1. Which arrows (activities) must *precede this one*?
2. Which arrows (activities) must *follow this one*?

The resulting logical flowchart is a network of arrows, usually referred to as either the arrow diagram or the network. For example, consider a routine checkup of your car as a project. Assume that you want the following work done:

- Rotate tires
- Lubricate
- Change oil
- Wax and polish
- Drain antifreeze

CPM is often referred to as a “decision maker.” This is a misnomer because CPM, being inanimate, cannot make decisions. However, the use of CPM encourages the user to make decisions to draw the arrow diagram.

In this example, a decision is required before any arrows can be drawn. The mechanic must decide whether to do the hoist work first or last. Assume that the mechanic decides to do the hoist work first. Accordingly, the first arrow will be

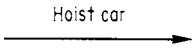

Following this are all of the arrows that could logically follow hoisting the car. From the work list, they are rotate tires, lubricate, and change oil.

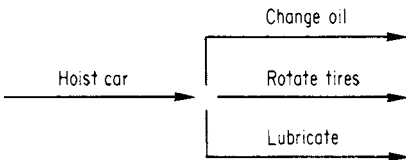

When the activity, lower car, is added, note that the general work list is not broken down into enough detail to show the mechanic's work plan. Adding this activity after the hoist work:

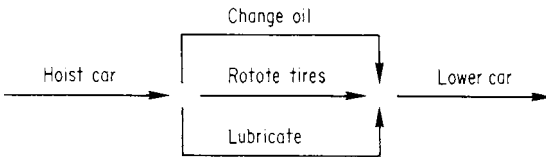

What does this really say? It says that the activities cannot start until the hoist is raised and must finish before the hoist is lowered. Something is missing, however. The activity, rotate tires, indicates that the mechanic must get the spare tire out while the car is on the hoist. That is not logical, and it certainly is not what the mechanic might be expected to do. Also, it is usual practice for the mechanic to loosen the tire lug nuts before raising the wheels clear of the ground. Change

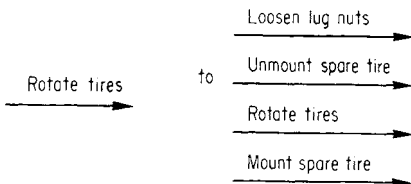

This part of the network then becomes

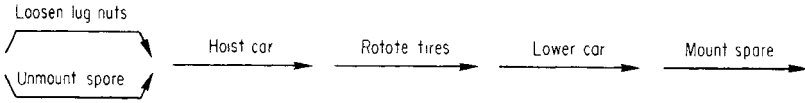

For lubricate, the first network indicates that oiling and checking items under the hood (battery, alternator, radiator, brake fluid, etc.) must be done while the car is up on the hoist. To do this, the mechanic would need stilts or a ladder.

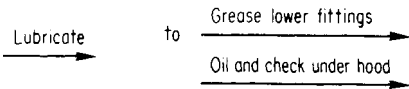

Similarly,

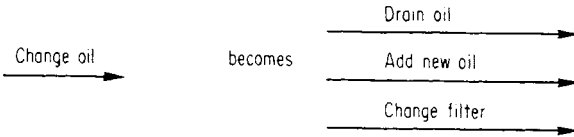

This part of the network then becomes

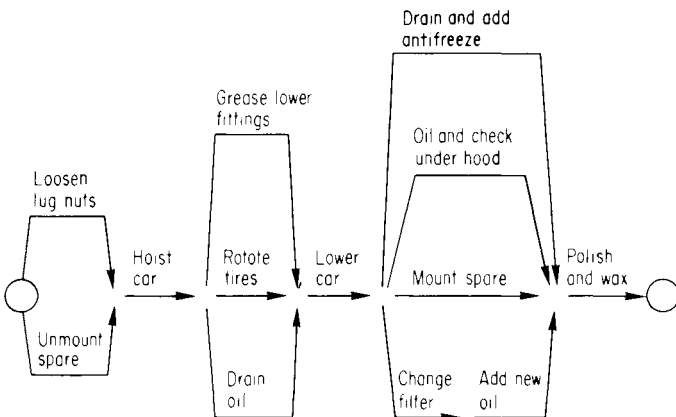
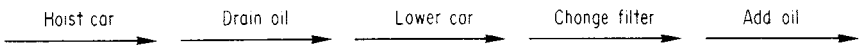

Figure 4.6.1 Arrow diagram, car checkup.

Combining the portions of the network and adding the two activities not previously shown, drain antifreeze and polish and wax car, the arrow diagram representing this everyday operation is as shown in Figure 4.6.1.

Preparing the arrow diagram focuses on one activity or a group of related activities at a time. The reason is obvious: Only one arrow is drawn at a time. The very simplicity of the reasoning gives strength to the technique. No one can thoughtfully consider all details of a multi-million dollar project simultaneously, but using the arrow diagram to record thoughts spotlights and plans one area at a time. As each area is completed, thoughts and plans are recorded by the arrow diagram.

#### 4.7. Logic Diagrams

The logic diagram is the most important single feature of the CPM method. Logic diagrams have long been used by mathematicians, and it was assumed by many that mathematician Kelley used the logic diagram to convey the basic plan sequence to the computer. In a 1983 meeting, Kelley stated that the entire algorithm was envisioned mathematically. He used the logic diagram, initially, to explain the approach to DuPont management. Introducing the logic diagram to reflect the intended sequence of a plan had a dramatic impact on the planning process. A number of abstract logical rules are useful in the preparation of a network. If activities  $A$ ,  $B$ , and  $C$  occur in series, their network representation is

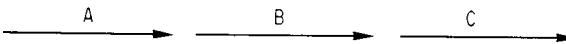

If the statement is that  $B$  and  $C$  follow  $A$ , this is one solution. A more correct one would be

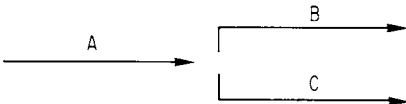

Examine the latter solution. Unlike the first one, it shows  $B$  and  $C$  as independent activities. When drawing network sequences, it is not proper to add logical connections that are not stated. Perhaps this is an obvious caution, but you must constantly guard against subtle, unintentional logical interconnections.

If activity *C* follows *B* and activity *D* follows *A*, what is the network expression? It may seem to be

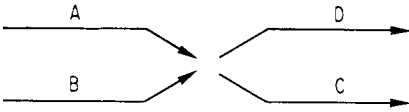

However, no connection between *C* and *A* or *B* and *D* was stated. Therefore, the proper relation is

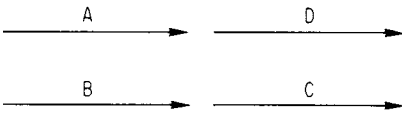

Now, if both *A* and *B* precede both *C* and *D*, the network expression is

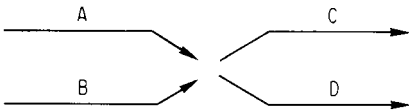

However, this is not correct if *A* and *B* precede *C* but only *B* precedes *D*. Stating this diagram as

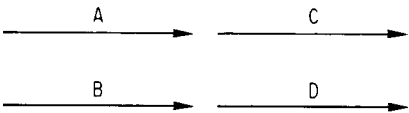

means that *B* is not shown as a precedent to *C*. And stating the diagram as

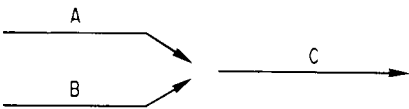

means that *B* is not shown as a precedent to *D*. The problem is that the arrow *B* cannot be broken into two parts; the arrow diagram is not permitted to “speak with a forked tongue.” The dilemma is solved by introducing the *logical connection*, an arrow that represents logic flow but no work. To differentiate from regular arrows, the no-work connections



are dashed-line arrows. In this example, the logical connection (or *logical restraint*) is

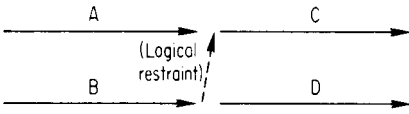

The network now shows that *C* follows *A* and *B* but *D* follows only *B*. The concept of the logical connection is common sense, but it is indispensable in CPM.

Now consider a network example with two parallel chains of activities. One of these chains is made up of activities *A*, *B*, and *C* in series. The other is made up of *X*, *Y*, and *Z* in series. *A* and *X* are the starting activities; *C* and *Z* are the terminal activities. This gives

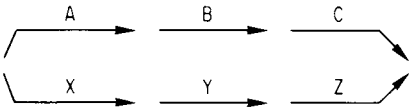

Now add an activity *M* originating at the project start. If activity *M* must precede *C* and *Y*, the result is

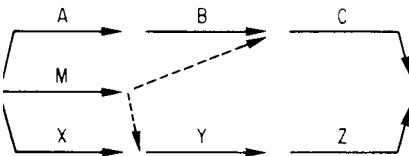

The point is that any number of logical restraints can originate from the finish of an activity. Similarly, any number can lead into the start of an activity. In the network

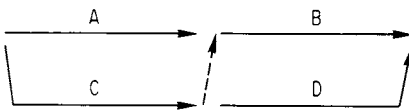

adding terminal activity *E*, which follows *A* but is independent of *C*, is not accomplished by



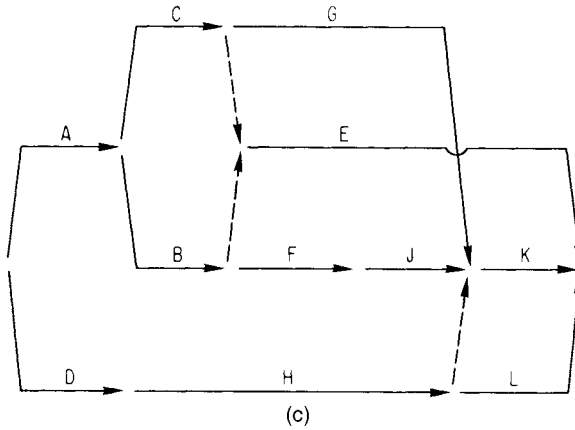
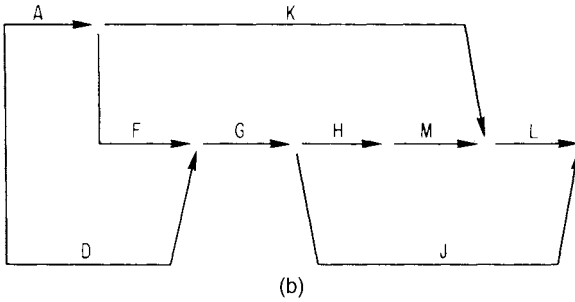
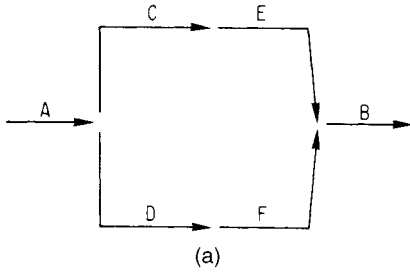

**Figure 4.7.1** Logic network examples. (a) Activities C and D follow A; activity E follows C. Activity F follows D; and E and F precede B. (b) G follows F but precedes H; K follows A but precedes L; F follows A; A and D start at the same time; J and L precede completion of the logic network; G follows D; J follows G; H follows G but precedes M; and M precedes L. (c) A and D start at the origin; J follows F but precedes K; C follows A but precedes G; H follows D but precedes L; B follows A but precedes E and F; E follows B and C; K follows G and H; and E, K and L precede completion of the logic network.

This is typical when unintentional logical connections are made. To keep *E* independent of *C*, add another logical restraint after *A*:

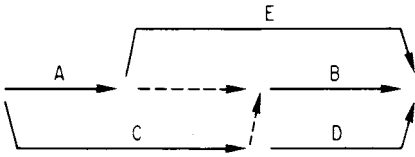

This might be termed a *logic splitter* or *logic spreader*. Logic cannot back up from *B* against the arrowhead, which functions as a check valve. Figure 4.7.1 offers more examples.

#### 4.8. Logical Loop

If activities *A*, *B*, *C*, and *D* are in series and activity *E* following *C* precedes *B*,

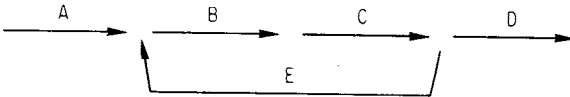

The portion *B*, *C*, and *E* is a *logical loop*. It is a question of “Which comes first, the chicken or the egg?” Since a loop is illogical, it has no place in a logical network. It might seem unlikely that anyone would draw a loop. In large complex networks, however, it is quite common for loops to be inadvertently inserted.

Figure 4.8.1 shows the site layout for a hospital project. Because the existing hospital was in a prime location, the new building was to be constructed immediately behind it. However, an annex building had to be demolished before new construction started. Since the service annex included the kitchen-cafeteria area, a temporary kitchen-cafeteria had to be established in the existing building until a new kitchen-cafeteria could be constructed and the new building was ready for occupancy. At that time, the temporary kitchen-cafeteria was to be vacated. This is easily shown in arrow diagram form:

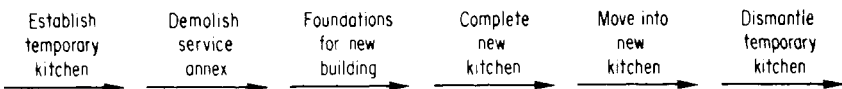

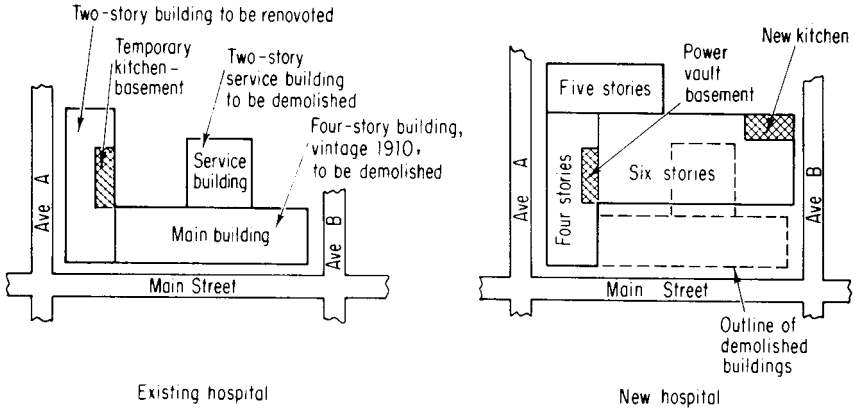
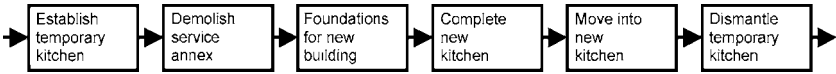
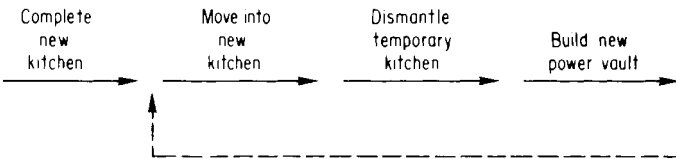

Figure 4.8.1 Hospital site layout.

The same information can also be shown in PDM (shown here for comparison only.)



However, a factor not noticed until the preparation of the arrow diagram was the location of the electric power distribution vault for the new building. The vault was to be the site in the old building occupied by the temporary kitchen. Adding that information to the network resulted in the following loop.



The situation was pointed out to the owner and the architect. Since the power vault was not needed until a year later, a new vault location was designed and constructed. Through the use of the CPM plan, a costly and inconvenient time loss was foreseen and avoided.

### 4.9. Non-construction Examples

Any number of non-construction projects can be planned using CPM. Some actual projects include:

- Shipbuilding
- City planning
- Refinery maintenance
- Architectural design
- Staffing a new plant
- Researching a project
- Embarkation of a construction battalion
- Cooking a meal
- Creating procedures for state approval of a new school
- Bringing a show to Broadway
- Preparing a corporate budget
- Preparing a city budget
- City approval of plans
- Purchasing a new house
- Purchasing a car
- Manufacturing one car
- Creating a family camping trip activity list

Although there is no one correct activity list for a family camping trip, this example assumes that a family consists of a father, a mother, and two children. A typical list might be the following.

- Prepare budget
- Pack car
- Collect site information
- Select site
- Purchase equipment
- Make equipment list
- Prepare food list
- Make camp site reservations
- Schedule vacation
- Plan clothing list

Figure 4.9.1 presents one plan that could be used to coordinate these activities.

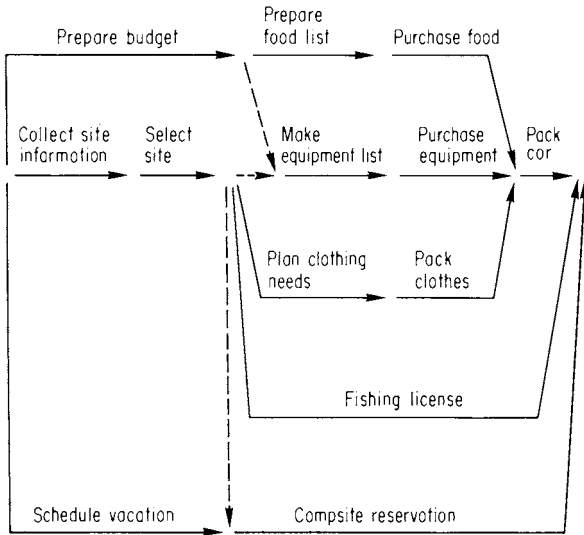

Figure 4.9.1 Family camping trip.

#### 4.10. Summary

This chapter discussed the concept of the network, as well the premise that CPM can encourage decision making but cannot make decisions itself. Preparing arrow and logic diagrams helps the planner to understand a project by clearly defining the activities required to complete it. CPM is particularly applicable to construction work, but its usefulness is by no means limited to the construction field.

## Network Construction

Chapter 4 discussed the concept and the fundamentals of construction of the CPM network. This chapter covers the practical mechanics of network construction. Since CPM is a logical and organized planning system, it is important that the physical layout of the network reflect the same logical organization. The thought required to separate the network's parts into practical subdivisions contributes to the overall plan. The network is often used to present the plan to strangers to the project. If the physical layout is clear, concise, and well arranged, first impressions will be good. However, CPM can also expose poor planning.

Figure 5.0.1 shows two networks with the same information. Both are logically correct, but the top network was drawn directly from a problem description without careful attention to physical layout. The bottom network is a rearrangement of the top one. It has only 12 activities. In a project network, the differences between network layouts and the possible resulting confusion would be multiplied a hundredfold.

### 5.1. Form and Format

The network is traditionally drawn on reproducible paper or Mylar. In preparing it, trial layouts should be sketched out before drawing it in finished form. The sketches are usually done on a blackboard, nonreproducible paper, vellum, or grid paper. Grid paper with non-reproducing squares is especially helpful in laying out a network. It can be used in the freehand sketch phase or for the finished network.

These freehand sketches should be saved and otherwise treated as the calculations of the design engineer's job book. After all, a specific size for a steel beam is not chosen merely because it "looks right" but only after preparation of a dimensionless rough draft, followed by selection of appropriate equations and careful calculation. Traditionally, the page upon

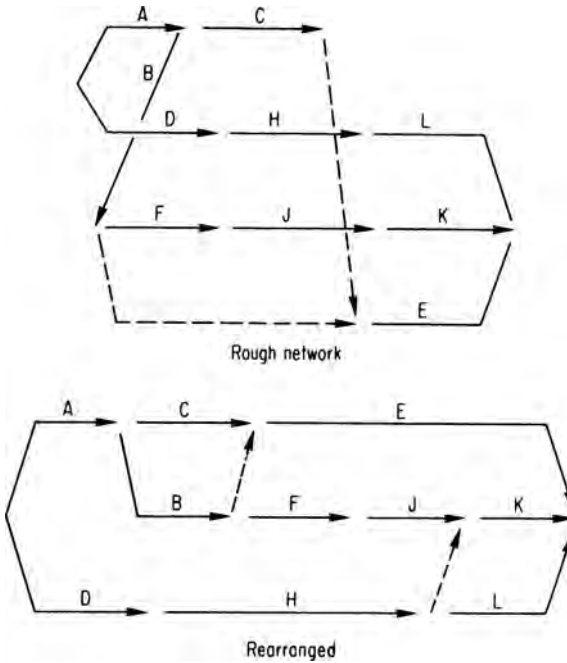

Figure 5.0.1 Rough and rearranged networks.

which these calculations are performed is stamped with a form noting the original designer with boxes for initials by the reviewer and often by a second reviewer. A check mark in the same color ink as the reviewer’s signature is placed next to each number or drawing element to show that each was checked. This calculation sheet is compiled into the job book that then goes to archived storage.

While today’s design engineers struggle with how to duplicate this process in a digital world, some variation of this method is still the norm. The job book may still be the base document reviewed if there is litigation relating to when design decisions were made. Similarly, the initial sketches of the CPM logic may be the base document reviewed if there is litigation relating to the contractor’s initial “plan of execution” of the work.

Because early networks were modest in size, drawing size was not a problem. As networks became larger, the size of the drawings increased. A huge network is unwieldy and difficult to handle, however. Although there may be times when long, rollout drawings are practical, for most work, it is better to break down larger networks onto a number of sheets.

The selection of the scope of each sheet is important. The sheet should not be crowded, but it should be well used. In subdividing the project so that it can be presented on a number of sheets, keep the practical use of the network in mind. For instance, if all the foundation work for a building appears



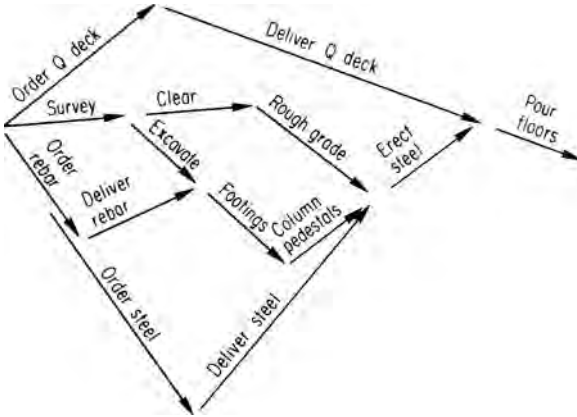

Figure 5.1.1 Random line example.

on one sheet, the field office will find the network easier to use, since the current field status can be located on one network sheet or two at a time.

There is no fixed rule for optimum sheet size. The Army Corps of Engineers uses a 34 × 44-inch sheet. A larger size can be used for drawing and then reduced for better handling. Many of the early diagrams were drawn with random direction lines (Figure 5.1.1) or wide-sweeping curves (Figure 5.1.2.) The clarity of hindsight obscures whatever reasons there might have been for originally using this method, which is mentioned here because people continually rediscover abandoned techniques and try to use them.

## 5.2. Events

The intersection of two or more activity arrows is termed an *event*. An event has a zero time dimension. However, all activities leading into an event must be completed before any of the activities leading out of the event can be started. This is just a restatement of the rules of network logic.

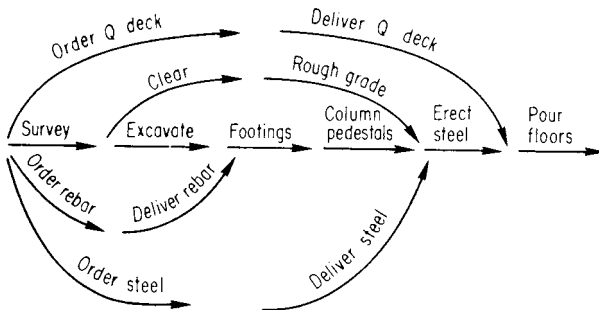
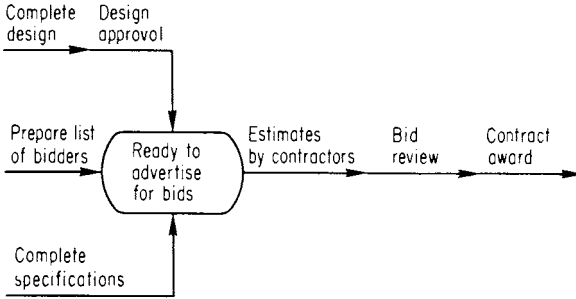

Figure 5.1.2 Sweeping curve example.



**Figure 5.2.1** Example of milestone event: ready to advertise for bids.

Certain key events are called *milestones*; they represent important intermediate goals within the network. For instance, “ready to advertise for bids” (Figure 5.2.1), is an important event. It represents an instant in time but has no time dimension of its own. To reach this particular event, all activities pertaining to the design and specifications for the project must be first completed. No action toward getting a contract can be taken until the logic flow has passed through the event.

On the CPM diagram, important events can be identified by name. Event titles are not emphasized; instead, events are assigned numbers. Because each activity is bounded by a starting and completion event, the event can be identified by the number.

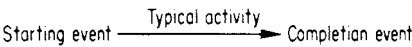

The number assigned to the starting event is referred to as the  $i$ ; the number assigned to the completion event is the  $j$ . (These designations were used by the founders of CPM and have remained in general use, probably because of their brevity.) Thus, the typical activity looks like:

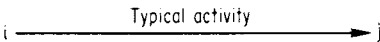

The  $i$ - $j$  number for an activity can be used as an abbreviated name for the activity. A number of rules must be followed in assigning event numbers to a network.

**Rule 1.** Each activity must have a unique  $i$ - $j$  description, but often two or more activities span the same events. For instance, between events 1 and 4 could be the following:

**TABLE 5.2.1 Activity List, Common Activity**

$i-j$	Description
1-4	Plumbing lines
1-4	Power conduits
1-4	Steam piping

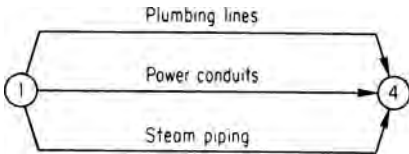

A list of these activities would read as shown in Table 5.2.1. This confusing situation is corrected by adding logical restraints originally called *dummies*. The term “dummy” was used because the connections say nothing new; it was added only so that unique event numbers could be introduced. The more proper term “restraint” is used now. The activity list now reads as shown in Table 5.2.2.

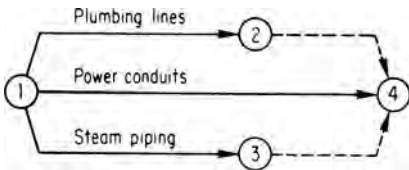

**Rule 2.** When event numbers are assigned, the number at the head (or  $j$  end) of the arrow should be greater than the event number at the tail (or  $i$  end). That is,  $j > i$ . In early computer programs, the ability of the computer to calculate the network often depended on this rule, as well as on the consecutive numbering of events. All computer programs handle nonconsecutive event numbers and random numbering

**TABLE 5.2.2 Activity List, Unique Numbers**

$i-j$	Description
1-2	Plumbing lines
1-3	Steam piping
1-4	Power conduits
2-4	Restraint
3-4	Restraint

(random numbering can be  $j > i$ ,  $j < i$ , or both in a network). Not only is random numbering a convenience, it is often a necessity. For instance, consider the partial network

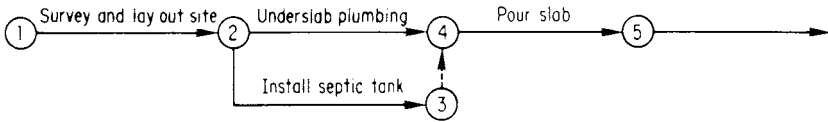

Assume that the network continues for perhaps 50 more event numbers. Now, suppose it is discovered that the activity clear and grade, which should follow activity 1–2, survey and lay out site, and precede both 2–3, install septic tank, and 2–4, underslab plumbing, was forgotten. Without random numbering, the network would have to be renumbered as follows.

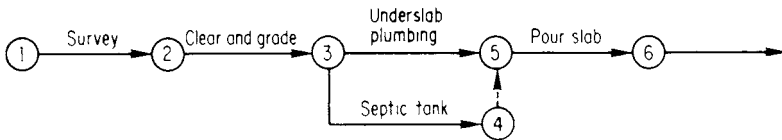

Since there would now be 51 event numbers, 50 of them would have to be changed (all except event 1). With random numbering, the revised network could be

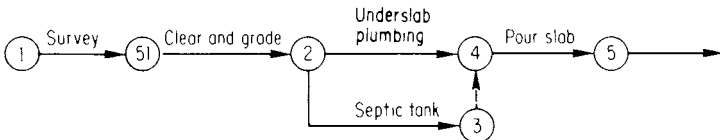

No event numbers would have to be changed and only one would have to be added. Since many of today's networks have in excess of 1000 events, random numbering is very important when activities must be added to the network.

Since random numbering is available, why even try to follow rule 2, which might be called the traditional rule for event numbering? First, numbering in the  $j > i$  manner makes it easier to locate events on the diagram. Second, logical loops are more easily identified. Using the example of a loop and numbering the events,

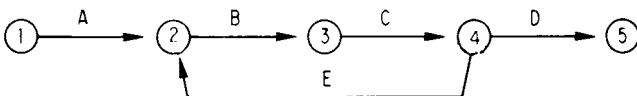

Note that  $4 > 2$ , or  $i > j$ , for activity  $E$  indicates a loop. Reverse the positions of 2 and 4:

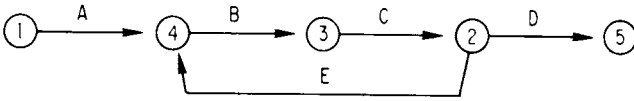

Then  $j > i$  for activity  $E$  but not for activities  $B$  and  $C$ .

Event numbers should not be added until a network is completed and numbers should be assigned in a regular fashion. This can be done horizontally (Figure 5.2.2a) or vertically (Figure 5.2.2b). Either one is acceptable. In the horizontal method, event numbers are assigned along a chain of activities until a junction event (a meeting of more than one activity) is reached. The routine is repeated until all chains into the junction event are numbered. In vertical event numbering, the numbers are assigned up and down vertically but still observe the  $j > i$  rule.

The vertical numbering system localizes numbers in areas of the diagram, which makes it easier to locate a particular activity on the network. The horizontal numbering system results in logical groupings of activities, so the  $i$ - $j$  list (or printout) has groupings of activities that are logically related. However, horizontal numbering can produce networks that make it difficult to locate an event number. Similarly, random numbers can make it difficult to locate a particular event on the network.

The number of digits in an event is limited by the computer program used. Older programs are often 3-digit-oriented. Since the average ratio of activities to events is about 1:5, the 3-digit concept limits the network size to about 1500 activities.

Today's major programs can accept 5 digits, which permits a network of 150,000 activities. Many programs can also accept alphabets, so that the maximum network size is essentially unlimited. Increased capacity allows many events, which can then be assigned digits by area or function, such as purchase material or equipment or drawing review.

In drafting the network, it is optional whether the event is circled or not.

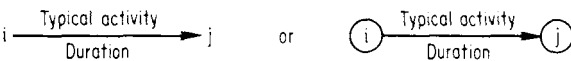

There is no significance to the event numbers except their value in identifying the activities. To the one who assigns the numbers, the logic is obvious. However, people not familiar with CPM often try to read unintended significance into the event numbers.

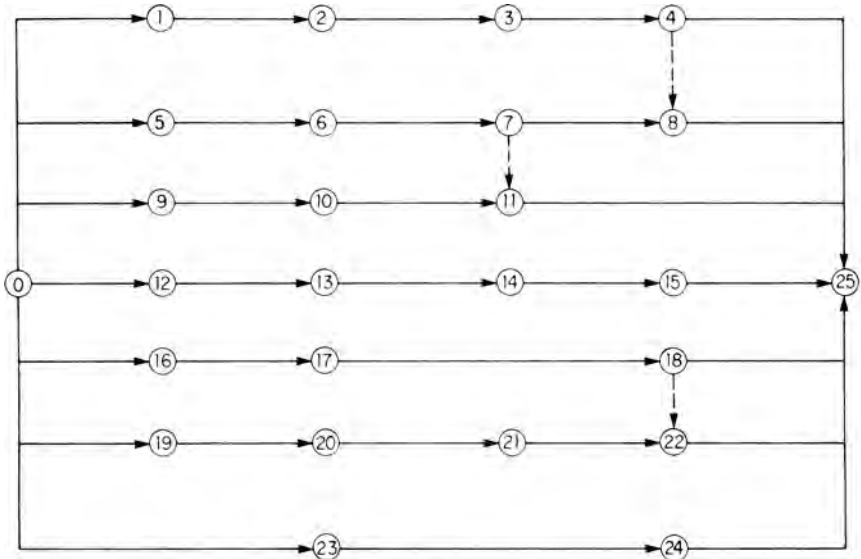

(a)

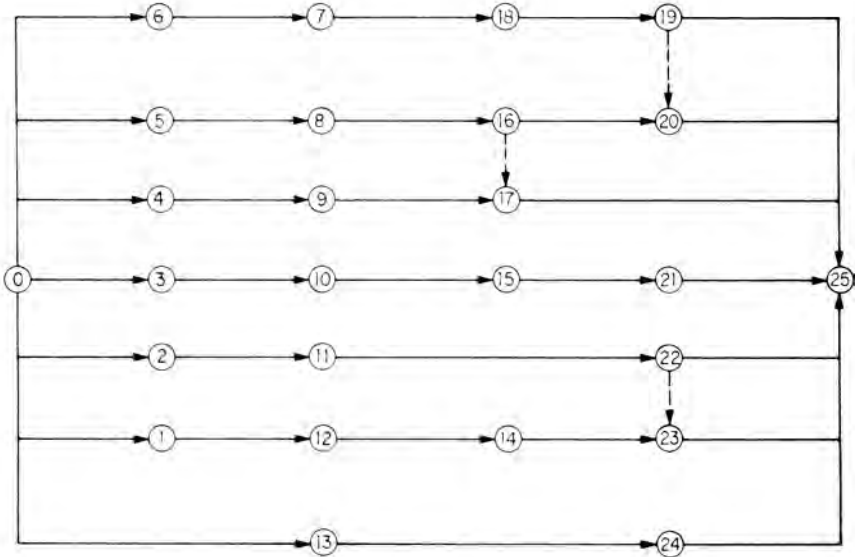

(b)

Figure 5.2.2 (a) Horizontal numbering, and (b) Vertical numbering.

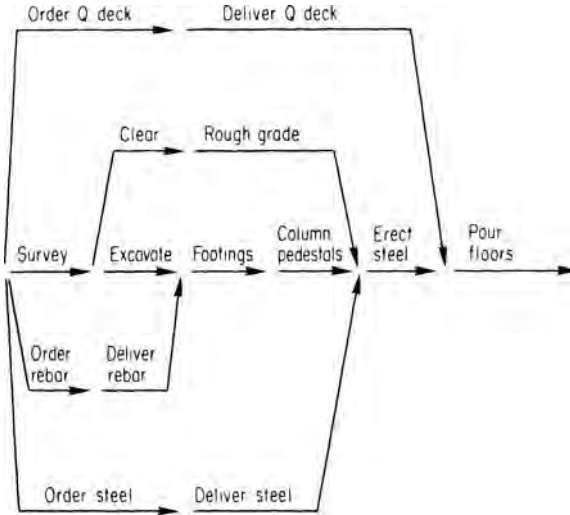

Figure 5.2.3 Horizontal format.

Activity descriptions should be written horizontally. To do this, a part of each arrow (except restraints) must be drawn on the horizontal (Figure 5.2.3). A comparison of the three cases shown in Figures 5.1.1, 5.1.2, and 5.2.3 illustrates the advantages of horizontal activity titles.

Another temptation for the drafter is to code activities rather than use full titles. The example network shown in Figure 5.2.4 is coded; compare

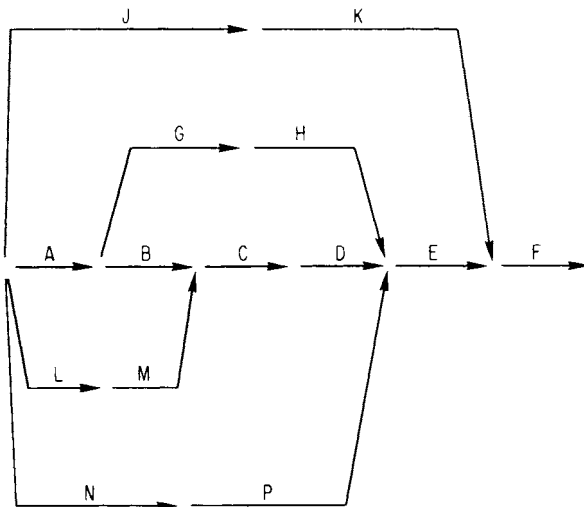
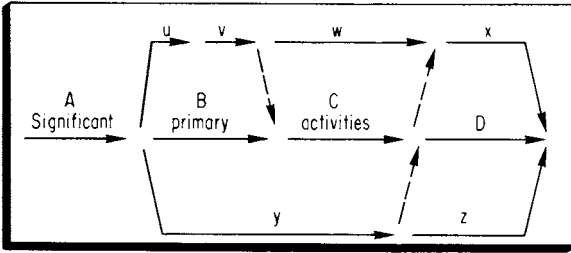

Figure 5.2.4 Untitled (coded) network.

Do this :



Rather than this:

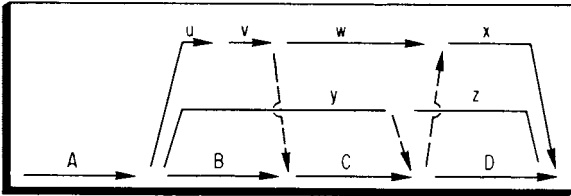

Figure 5.2.5 Significant primary activities.

it with Figure 5.2.3. A coded network is easier to prepare than a titled one, but is almost useless because not even the person who prepared the diagram can read it directly.

When arranging a network, center the significant activities on the sheet so that they function as the backbone of the network. These main activities put visual emphasis on the important areas and minimize crossover of arrows. Figure 5.2.5 illustrates the technique. In the past, some specifications have required that the critical path be the network backbone. This is not a valid requirement though, because the critical activities have not yet been identified when the network is being prepared. However, activities that are usually critical can be identified from experience; these are referred to as *significant*.

The arrow size and spacing are quite important. If the arrows are too long and are widely spread, the diagram will become too large and unwieldy. On the other hand, if the arrow arrangement is too tight, the network will be difficult to read. Also, a crowded network cannot be readily revised or amended. The usual arrow length is 2 to 3 inches but is not mandatory. In the example activity 1–4 must be the sum of the lengths of 1–2, 2–3, and 3–4. A minimum vertical distance of 2 to 3 inches between arrows leaves room for revisions.



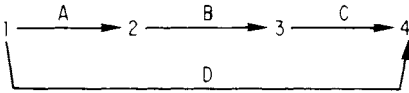

Backward arrows should be avoided because they are confusing and are drawn against the time flow of the network. They also increase the possibility of introducing unintended logical loops. In the example shown in Figure 5.2.6, the first network did not show a requirement that the hydro testing and insulation must precede the start of lath and plaster. The restraint arrow added to show this logic is a backward arrow.

Crossovers are a problem. It is inevitable that some lines of logic must cross others, but many crossovers can be eliminated by careful layout (see Figure 5.2.4.) There is no one method for showing crossovers. However, it is important that the lines do not intersect. In the example shown in Figure 5.2.7, the intersection of activities 12–14 and 9–16, illustrated in the lower left-hand corner, is not proper because it implies a logical crossroad that does not exist.

One solution to this problem is to use a pipeline technique (see Figure 5.2.7, upper left-hand corner). The crossover is shown in the same way that a pipe crossing is shown on piping drawings. Another solution is to show a broken arrow (see Figure 5.2.7, upper right-hand corner). Any good crossover technique can be used, but the same technique should be used consistently so that the network user can become accustomed to it. A second version of the broken arrow is shown in the lower right-hand corner of Figure 5.2.7. In this case, the parts of the broken arrow are in line. On large networks, it may not be practical to maintain the straight-line relation.

A broken arrow can also connect events on different sheets of a multisheet network, which is necessary when preparing large networks. However, coupled with backward arrows, broken arrows can lead to unintended loops. The best guard against loops is to use traditional event numbering,  $j > i$ . To make this effective, the events should not be numbered until the network is completed.

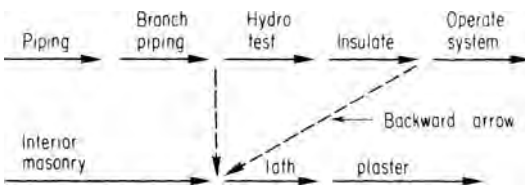
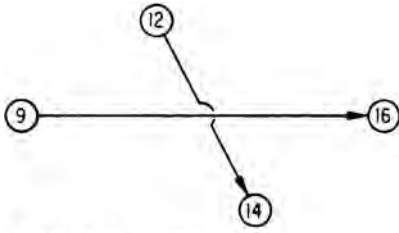
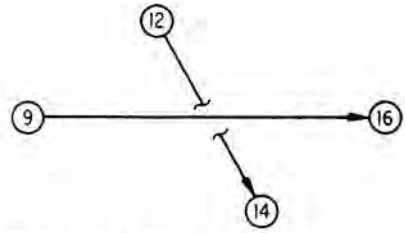

Figure 5.2.6 Section of network with backward arrow.



Pipeline - type crossover



Broken arrow crossover

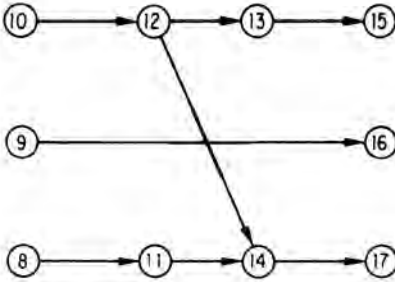

Improper crossover  
between 12-14 and 9-16

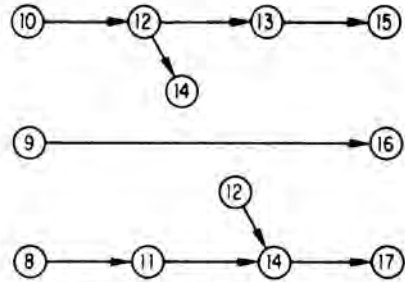

Another broken arrow crossover

Figure 5.2.7 Arrow crossover techniques.

Standard network  
(Many activities originating  
from single event)

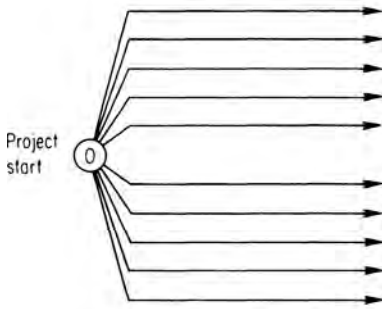

Bus-bar technique

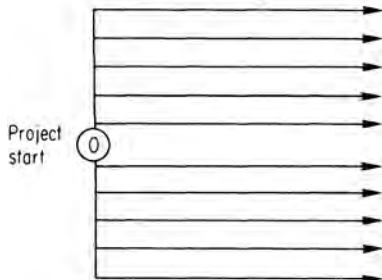

Figure 5.2.8 Standard versus bus bar technique.

At the project start, a number of activities usually originate. The result often looks like a traffic jam (Figure 5.2.8). The *bus bar* technique can reduce unproductive congestion of a network. Some network purists object to this technique because it violates the rule of intersecting arrows at points that are not events. Thus, the criterion the diagrammer uses in deciding whether to use the bus bar technique should be the clarity of the resulting network. If the technique is clever but confuses the user, it is a case of “the operation was a success but the patient died.”

### 5.3. Problems with Multisheet Networks

A difficult factor in multisheet networks is where to cut off the arrows on one sheet to start the next. For ease in drawing and to facilitate drawing use, the network should be interrupted at the point where the least number of arrows must be cut. Assume that the portion of the network shown in Figure 5.3.1 is to be on the end of one sheet and the start of the next. If the network is split as shown in Figure 5.3.2, it is more difficult

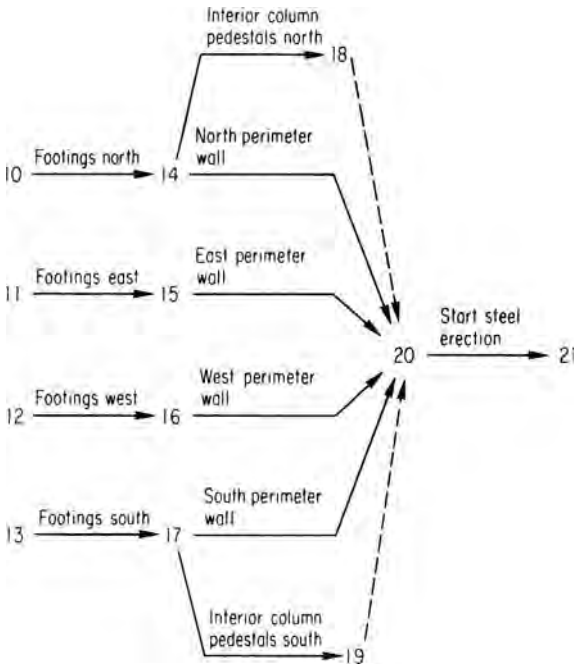

Figure 5.3.1 Multisheet network example: continuous network.

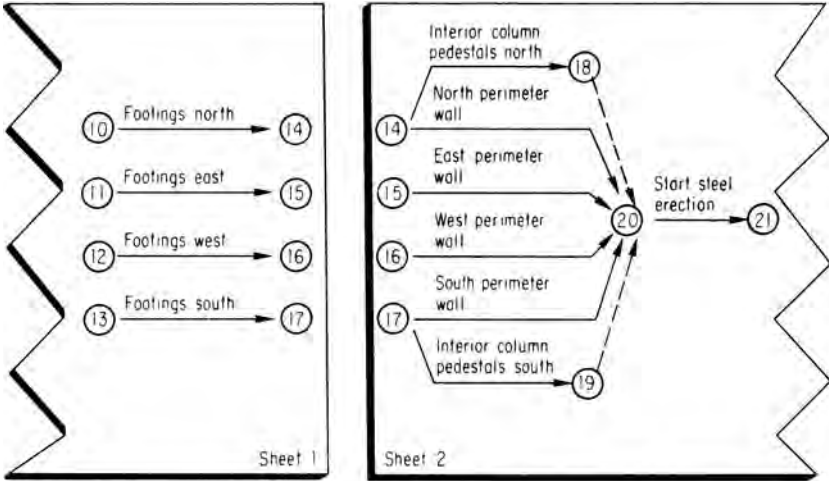

Figure 5.3.2 Multisheet example: poorly split network.

for the drafter to draw. More significantly, it does not present a clear picture to field workers or other users of the diagram. In Figure 5.3.3, the network is split at the end of the foundation work and prior to steel erection. Splitting the network at an important event meets the needs of both the diagrammer and the user of the diagram.

Figure 5.3.3 illustrates another useful technique when connecting events from sheet to sheet. The connecting event is highlighted with a

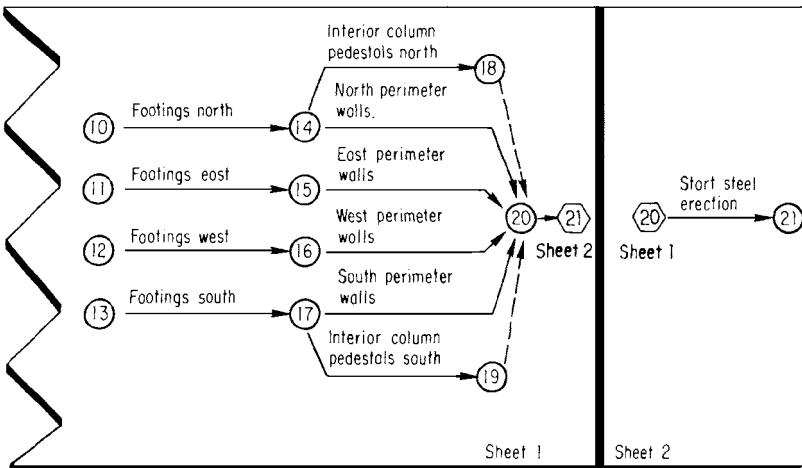

Figure 5.3.3 Multisheet network example: network split at logical place.

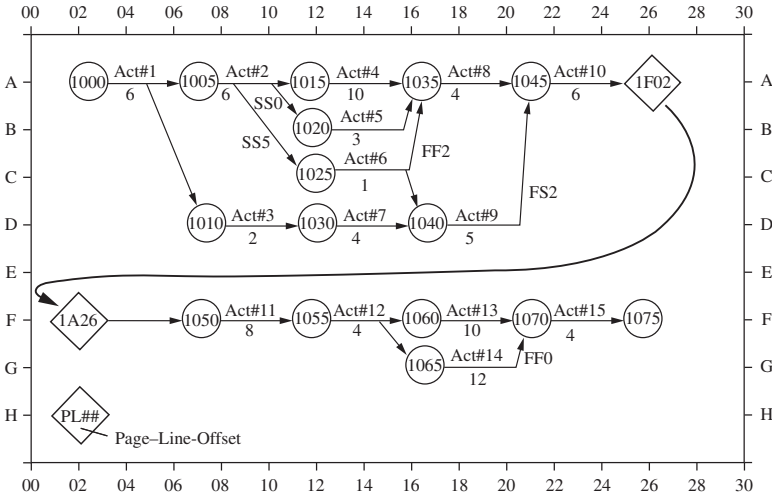

Figure 5.3.4 Page and grid location method.

hexagon. The number of the sheet to which the event connects is written outside the hexagon.

Yet another method used by EnProMaC is to provide coding symbols and an identification system for use in navigating the pure logic diagram but not regularly incorporated in the computer model and being strictly for locating activity or logic lines that traverse one or more sheets of the logic diagram. In this instance, a typical sheet is marked with grid of lines “A” through “T” for say, 20 lines, and “01” through “20” across the top of the sheet. When an activity arrow or logic line is to run off the end of the sheet, or needs to be connected to another activity at the far end of the same sheet or different sheet, the arrow is drawn to end at a diamond. The page and grid location of the diamond is noted and notated to another diamond where the arrow or line continues on a separate sheet, and the page and grid location of the second diamond is notated to the first diamond as in Figure 5.3.4 as shown. (Also see Figure 11.6.1c, the P3 for DOS pure logic graphic format.)

### 5.4. Summary

This chapter discussed the practical mechanics of network construction. Primarily, the network layout must be logical and organized. A confused diagram exposes confused planning. The drawing size should be reasonable, and multiple sheets should be used if necessary.

Activity descriptions should be on horizontal lines. Avoid wide-sweeping lines or random lines. Center significant chains of activities to form

a network backbone. Space the arrows so that additions may be made. Crossovers of logic lines can take a number of forms, but the form used should be consistent.

*i-j* event numbers are abbreviated activity designations and must be unique for each activity. The careful assignment of event numbers makes the network easier to use and avoids unintended logical loops. Random is used here in its literal sense: “without direction, rule, or method.”

## The Durations of the Logic Network

The preparation of the arrow diagram furnishes a number of advantages, including a

- disciplined method of preparing a plan,
- method of considering the project in detail, and
- graphic record of the plan, which can be useful in exchanging opinions and constructive criticism about the plan.

One thing that the arrow diagram lacks thus far is the dimension of time. It might be said that the portion of CPM described thus far has been qualitative but not quantitative.

The logic network may determine the order in which activities must be performed, but not when. To determine when the earliest time each activity first may be performed and the latest time when each activity must be performed requires not only logic but durations. Similarly, setting minimum and maximum limits upon the duration of an activity will have an impact upon the level of detail and the definition of specific activities. But keep in mind the order in which this material is presented—the accuracy of the pure logic network is paramount in a CPM analysis.

Thus an inspector, reading a specification limiting durations to 20 days or less, may reject a submission where certain activities have greater durations. But keep in mind that every specification has the added provision (either explicitly in writing or implicitly at law) that such limitations are “subject to the sound discretion of the Engineer.” An engineer is expected to understand the reason for this limitation and relax the limitation appropriately. Strict reliance upon the specification

without understanding the rationale of it can be treated in this, or any other review situation, as “practice outside the engineer’s field of expertise,” contrary to the obligations of licensure and placing the engineer at risk for discipline.

### 6.1. Definition of an Activity

The first step in determining activity duration is made when defining the activity. In the construction industry, a proper activity is a set of instructions, given to a competent foreman, who is then expected to complete such without further supervision or interaction with other than his/her own subordinates. In the manufacturing or IT industry, an activity is a process in a black box that once started does not require further interaction or supervision. Returning to the construction industry, an activity is further defined as being under the control of one, and only one, responsible individual. Thus, notwithstanding a specification indicating separate activities for each trade, if a crew of electricians is standing by to assist in a massive concrete pour that includes embedded conduit, the activity POUR CONCRETE includes the efforts of this separate trade and it would be improper to list such scope of work as a separate activity. Similarly, the installation of a MSE wall involves some backfill, often by a separate subcontractor or crew. But this portion of the backfill is dictated by the foreman of the MSE crew and thus this scope of work is included in the ERECT MSE WALL activity.

The definition of an activity is also controlled by its predecessors and successors. Even in PDM, where overlaps between activities are supported, at some level (even if not stated) each activity may start only when its predecessors are 100 percent complete and each activity is finished when any of its successors may start.

As an example, see Figure 6.1.1, which includes an activity “Form/Rebar/Pour Walls.” This is preceded in the logic network by “Form/Rebar/Pour Footing” and succeeded by “Rig Joists On To Wall.” Presume that it is intended to prefabricate a portion of the rebar. This subset of scope does not require the footing to be poured and, therefore, it should not be included as part of the wall activity. The prefab scope should be listed as a separate activity with predecessors back to delivery of rebar

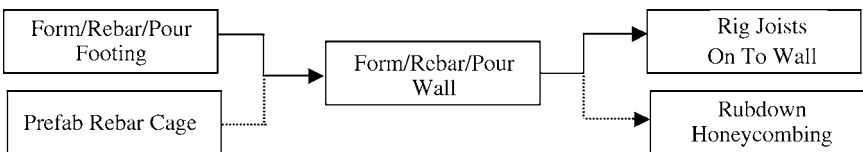

Figure 6.1.1 Activity description further defined by predecessors and successors.



and access to site. Even if this activity is not included in the logic network, the duration of the wall activity should not include such scope. Note how the duration of the activity would then differ from the bid estimate.

Similarly, once joists are rigged upon the wall, the wall activity is finished as far as the CPM analysis is concerned. From a cost perspective, an inspector may wish to reserve some retainage to provide assurance that the non-structural honeycombing is corrected, but the CPM activity should still be noted as 100 percent complete for schedule purposes. It is usually unrealistic to include an additional activity after each pour to provide for such scope and such scope may be included in the general punchlist activity or not at all. Nevertheless, the activity duration should not include time for this contingency. Again, this means that the duration may differ from the number of days reserved for this activity in the bid estimate.

## 6.2. Setting a Minimum and Maximum Duration

Setting a minimum duration is a matter of usage of the software systems available. In the construction industry, the typical minimum is 1 day. In the maintenance and turnaround industry, the minimum duration typically can be as low as 15 minutes. In city planning, in which activity descriptions are fairly broad, weeks can be used. In the manufacturing industry, it can range from as high as one shift to as low as one cycle of a machine. In the IT industry, minimum duration can be as low as a clock tick. However, full time units are usually used in CPM. If an activity is expected to take 3 days and 6 hours, the Scheduler will use 4 days.

What if the logic network provides for four activities of 2 hours each and by separate subcontractors in 1 day? The accuracy of the pure logic network is paramount in a CPM analysis, but the tool to be used may be limited to only one minimum unit; either all activities are measured in hours or none. We may further note that somebody better be providing careful supervision if four independent foremen are going to mesh their work in 1 day. The answer may be to combine all four to one activity or to improperly show all four as concurrent with a side comment to the users of the output or provide some other fudge. What is important is to understand and convey to all users of the schedule is that there is a problem with network logic at this point.

P3e/c provides a work-around for this problem by use of “Activity Steps.” Using this feature, each of the four activities may be listed as being components of a master activity that may be automatically statused as the components are completed. However, the internal logic between steps is not recorded or used as part of the calculations performed.

Setting a maximum duration is another matter, based upon the usage by the people using the schedule. The primary reason for setting maximum activity duration is to improve the quality and ease of updates to the schedule during the course of the project. A second reason, often cited, is to assist the reviewer in verifying the reasonableness of activity durations. A seasoned superintendent is a genius in the field of estimating the most likely duration for an activity. A myriad of factors influence the duration specified. It is important for the Scheduler to elicit these factors and record them along with the number provided to permit the superintendent to later verify his/her work or to allow less-knowledgeable individuals to understand the basis for the duration.

However, in practice, updates are not handled by the superintendent but by a less experienced individual. The choice of maximum duration and frequency of update is, therefore, set by the level of error that can be tolerated in the update. A seasoned superintendent may look at a two specified scopes of work and estimate their durations as 15 days and 35 days, respectively. After 2 weeks have passed, the superintendent may look at the work-in-progress and note remaining durations of 7 days and 18 days, respectively, noting less than anticipated performance in the first and better than anticipated performance in the second case. However, it is the most recently hired junior engineer or clerk on the site who may likely be assigned to collect update data (after taking job trailer lunch orders). Looking over the 15 day activity, the junior engineer may note that it looks “about” 60 percent complete, but after consulting the last update choose to enter 67 percent complete. Looking over the 35-day activity, the junior engineer probably will have no opinion at all and simply record  $35 - 10 = 25$  days remaining. In a project of 3-years’ duration being updated every 2 weeks does an error of 2 days in the remaining duration of one activity make any difference? Even if wrong, it will be corrected in the very next update. The 7-day error is more problematic and may well lead to the mis-scheduling of a follow-on subcontractor. If the possible error is greater than one update period, then the project team has an even greater problem. Thus many specifications base the setting of a maximum duration as not greater than twice the frequency of updates. However, as will be discussed in chapter 27, the contractor may well desire to update more frequently than required by the specification.

Returning to the question of the “sound discretion of the Engineer,” consider the situation where the duration is based strictly upon a measured quantity that will also be tracked for payment purposes. Thus if the contractor estimates 200,000 CY of soil to be moved over a duration of 70 days based upon an average production rate of 2850 CY/day, and the engineer is already tracking the actual quantities being moved, it is probably more accurate and certainly easier for the project team to

base remaining duration as a percent of 70 days rather than artificial segmentation of this scope of work into “acceptable” activities. However, the Engineer may require the contractor to check his estimate and desire to check the contractor’s estimate of this quantity against the Engineer’s estimate.

### 6.3. Estimating versus Scheduling Durations

One way to estimate the duration of an activity is to estimate labor hour requirements for the activity and divide that figure by the assumed size of the work crew. However, labor hour requirements are usually not available because almost all construction estimates are prepared by subtracting the work quantities by the physical categories. An activity often includes more than one work category, but it rarely includes all major categories.

Using basic CPM, it is not possible to make an accurate time estimate for an entire project on an off-the-cuff basis. If an estimator is experienced, however, it is possible to make very accurate time estimates once a project is properly broken down into discrete activities. The project can be compared to a steer: The meat cannot be consumed on the hoof, but by breaking the steer into hamburgers, it can be easily consumed.

There are situations in which it is not practical to forecast a time requirement, but the estimator makes the best judgment of the probable time factor. In subgrade work, for instance, unusual situations can develop or weather conditions might be a big factor. In such a situation, it is proper to add some contingency time. The more uncertain the conditions, the greater the contingency time that should be included. Breaking down the overall project into well-defined activities helps to reduce the contingency time required.

When a unique new structural or architectural system is planned, the architect-engineer is usually reluctant to place a time estimate on activities. In this case, a bracket approach is useful. The first tack is to ask how long the activity might take, starting with a high figure, such as 10 months, and working down. Then start with a low figure and work up from the minimum time the activity could take. The result is almost always a reasonable time range in which the activity could be accomplished. Within that range, a specific time estimate can then be selected.

While on this topic, it is important that the determination of duration be prepared independent of the contractor’s bid estimate. The bid estimate, prepared in a short timeframe, may be subject to errors and the preparation of the CPM is often the first post-award opportunity to cross-check the estimate. In addition, a seasoned superintendent may deploy resources in a manner differing from those assumed during the

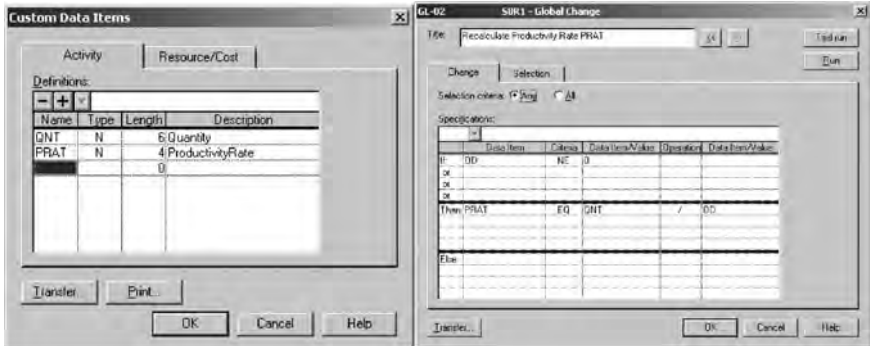

Figure 6.3.1 Use of custom data items and global change to calculate productivity rates.

rushed bid process, using larger or smaller crews or equipment. And, as previously noted, the scope of an activity for schedule purposes may vary from that for cost estimation. Such differences will, of course, have an impact upon the number of working days to perform an activity.

Two points made in the preceding paragraphs should be further discussed. The duration determined by the superintendent or project manager will be based upon certain assumptions and it is an estimate subject to some level of risk. The estimate of duration will be based upon the resources assigned thereto. This, in turn, will be based upon the quantity of work to be performed. Finally, whether verbalized or not, there will be a range of durations considered before choosing the most likely duration. As a Scheduler, it is important to record all of this background information and not simply the estimate of duration provided.

The recording of quantities permits the calculation of a rate of productivity that can be used to verify estimates of duration. Merely by glancing down the column of productivity rates for similar activities, the Scheduler (and entire project team) can detect durations that do not seem consistent and review each accordingly. (Figure 6.3.1)

In Primavera P3 and P3e/c software, use one custom activity code for quantity and a second for productivity rate. A standard activity code may also be reserved to note the units of quantity recorded. Enter the quantity (numeric) and create a Global Change to calculate the productivity rate for all non-zero duration activities (equal to quantity divided by original duration.)

#### 6.4. CPM versus PERT Durations

Note how the various precursors to modern CPM converge at this point. PERT requires input of the Optimistic, Most Likely, and Pessimistic estimates of duration between each event. Many modern software systems,

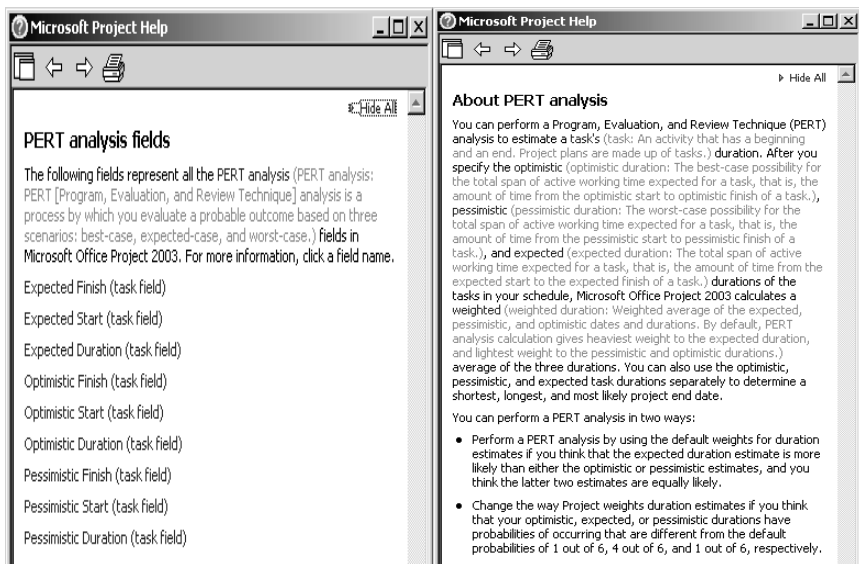

**Figure 6.4.1** MicroSoft Project permits the user to provide the earliest dates that the user hopes to start and finish (or optimistic duration), the latest dates (or pessimistic duration) anticipated, and the expected (or most likely) dates or durations anticipated.

such as MicroSoft Project (Figure 6.4.1), provide as a default that the durations will be calculated from the inputs of quantities of work and resources assigned. SPERT analysis, initially limited to an academic exercise, is now supported by software such as Monte Carlo and Pertmaster and provides default values for Optimistic and Pessimistic estimates of duration, subject to direct entry of these values by the Scheduler.

The PERT methodology of asking for Pessimistic, Optimistic, and Most Likely estimates of duration has a psychological as well as mathematical use. Project personnel first asked “In the near worst circumstances (or 95 percent of the time), what is the maximum duration that this may take?,” “In the near best circumstances (or best 5 percent of the time), what is the minimum duration that this may take?” and then “What do we expect is the most likely duration that this will take?,” will likely give a more accurate and less padded estimate than if asked straight out, “What duration should we assign to this activity?” Even if the answers to the first two questions are not recorded and are thrown out, the more accurate answer to the third question may justify the effort to ask three questions. On the other hand, if the information is given, why not record it? Even some basic CPM software programs, such as Microsoft Project, support recording and actually can use all three data points. Even if the software used does not support recording

all this information, the Scheduler may still record such (in raw notes or in a code field) for potential use.

Microsoft Project also provides for variations from the original PERT algorithm, allowing the user to vary the standard weighting from  $(O + 4M + P)/6$  and to compare the results to networks using only the Optimistic, Most Likely, or Pessimistic durations. (For reasons dealing with merge bias, or the mathematical issues raised when two or more paths of activities merge, this comparison can provide only a rough approximation of the probable optimistic, most likely and pessimistic duration for the project as a whole. This is further discussed in Chapter 38).

## **6.5. Summary**

Activity durations are based upon the project manager's estimate of the scope of work, resources to be assigned, and other factors and assumptions, all which should be recorded by the Scheduler. A proper activity is a set of instructions, given to a competent foreman, who is then expected to complete them without further supervision or interaction with other than his/her own subordinates. The maximum scope and duration for an activity should also be based on the ability of junior personnel to assess partial completion. The duration estimates of the project manager should be fresh, based upon the resources that the project manager intends to assign to the activity and should not be influenced by the estimates based upon quantity takeoff or other method prepared by an estimating department during the bid process. Asking for a Pessimistic, Optimistic, and Most Likely estimate of duration may be of use in obtaining unpadded and more accurate estimates, even if the extra information is not recorded.

## What Comes Out . . .

As may be noted from the preceding pages, a good deal of effort is required to prepare the logic network and make it ready for the software to do its job. Additional practical detail on acquiring the information for the logic network is provided in Part III of this text. But what do we expect the software to accomplish that makes the output more useful than a bar-chart and merits all this effort? A bar-chart indicates when the preparer intends or hopes to perform each activity. Thus, the preparation of a bar-chart calculates two attributes for each activity on the chart—the scheduled start and scheduled finish dates.

While this information is an improvement over that of a numbered to-do list, it is still somewhat limited. Other scheduling information that may be useful for management of a project includes whether and which of these activities may be capable of starting earlier than scheduled if additional resources become available or productivity exceeds expectations. A project manager may wish to know which of these activities are critical to the completion of the project and which may slip without such an impact, and to know the latest dates upon which an activity must start and be completed for the project to be completed by a specified date. Even if the completion date of the project is not imperiled, the slippage of one activity may have an impact upon the scheduling of other work, be this work by the same foreman or by another crew or subcontractor. Therefore, a project manager may wish to know which activities may slip without impact to a successor and by how much.

If a project manager is concerned with limited crews or other resources, he/she may even plan to allow some activities to slip. Some such shifts could have an impact to project completion. Some may only impact the start of another activity. And some may merely reduce the ability to allow other activities preceding the activity to slip. But others can be

shifted without any impact to a successor or reduction of options of a predecessor. As the project is being planned and scheduled at the outset, a project manager may wish to know these attributes for each activity.

The mathematics of CPM systems expand this level of information to indicate when an activity first **may** start and **may** finish based upon a stipulated start date for a project, when an activity **must** start and **must** finish if the project is to be completed by a stipulated date or by the earliest time possible, the number of days (or other units of time) between the time when an activity **may** and **must** so start or **may** and **must** so finish, and other attributes relating to the timing of performance of the activity, and those points in time immediately preceding and following an activity.

The last comment is important because the initial development of CPM was as a mathematical exercise with a primary emphasis upon events, or points in time, and only a secondary emphasis upon the activities between these events. While this is downplayed by some manuals teaching PDM and software tutorials, the mathematics of these systems continue to be based upon these concepts.

### 7.1. Attributes of an Event

One of the advertising campaigns of Primavera Systems was “This is an Activity Based World.” However, in many applications, precise knowledge of an activity or what must be done is rather sketchy. This would be especially true in an R&D (research and development) project, such as the Polaris Missile System for which PERT was developed in 1958. What are known are the various events or milestones that mark the path from project inception to project completion. Moreover, the *mathematics* of CPM that require “each activity to be 100 percent complete before the next activity may start” was initially accomplished by requiring that each activity (an arrow) double as the logic connecting two events (or nodes) representing points in time. Whether in CPM or PERT, the initial calculation was to determine the earliest and latest time that such events may occur based upon the logic and durations of activities (CPM) or between events (PERT). These attributes are expressed as  $T_E$  and  $T_L$ . The difference between  $T_E$  and  $T_L$  is the attribute known as total float in the United States, or slack in the UK, and is expressed as  $TF$ .

### 7.2. Attributes of an Activity

An activity, unlike an event, has duration. An activity, unlike an event, has a distinct start and finish and some period of time between the two. An event, being a single point in time, either has or has not occurred. However, an activity, having duration, may yet to have started, have



started but not yet finished, or have started and finished. Thus there exist a greater number of attributes affiliated with an activity than with an event. The *mathematics* of CPM places these activities between events to carry both the logic of the order of events and the durations between such events.

### 7.3. The Forward Pass— $T_E$ , $ES$ , and $EF$

Each activity will, therefore, have an attribute for the earliest time that the activity *may* start, expressed as  $ES$  and equal to the  $T_E$  of the event from which the activity springs, and for the earliest time the activity *may* finish, expressed as  $EF$ .

### 7.4. The Backward Pass— $T_L$ , $LF$ , and $LS$

Each activity will also have an attribute for the latest time that the activity *must* finish (if the project is to be complete on time or at the earliest possible time), expressed as  $LF$  and equal to the  $T_L$  of the event to which the activity goes, and for the latest time the activity *must* start, expressed as  $LS$ . Note that the attributes  $EF$  and  $LS$  are new and are not necessarily equal to one of the event attributes  $T_E$  or  $T_L$ .

### 7.5. The Backward Pass— $TF$ , $FF$ , and $IF$

For an activity, the attribute measuring the difference between when an activity may start and must start, the number of time units that the activity may slip without impact to timely completion of the project, is known as total float (or slack) and is expressed as  $TF$ . Similarly, the attribute measuring the difference between when an activity may finish and must finish is also known as total float (or slack) and is also expressed as  $TF$ . In the original and traditional format of CPM, now known as arrow diagramming method (ADM) or activity-on-arrow method (AOA), where the calculation of activity attributes require the intermediate step of calculation of event attributes (and thus guaranteeing that each activity be 100 percent complete before the next starts), the two attributes are indeed the same since  $LS - ES = TF = LF - EF$ . (The derivation of this equality is demonstrated in the next section.)

The attribute measuring the number of time units that an activity may slip without impact to another activity that may follow (or successor activities) is known as free float and is expressed as  $FF$ . The attribute measuring the number of time units that an activity may be deliberately deferred without reducing the ability to defer any other activity of the logic network is known as independent float and is expressed as  $IF$ .

There are several additional attributes for each activity that are not truly calculated by the mathematics of CPM but rather by various add-ons. One of the benefits of CPM over the use of a bar-chart is that it empowers the project superintendent (and perhaps his/her subordinates) to intelligently choose which activities to pursue most vigorously and which may be allowed to slip to some extent without adverse effect. Thus we speak of early start and early finish dates, upon which the superintendent *may* first expect to be able to perform an activity, and late finish and late start dates, upon which the superintendent *must* perform on or before, but we have not explicitly specified the dates between these two extremes, upon which the superintendent would like to perform the scope of the activity. There are possibly three steps from the attributes calculated by the mathematics of CPM to those calculated or assigned by other methodologies.

The first is the correction of the assumption of CPM of unlimited resources for multiple operations. While the resources assigned to any one activity may be carefully and properly chosen for optimal performance, pure CPM does not have the means to limit the number of concurrent operations. The results of the CPM calculation may at any one time require an unreasonable or unattainable number of craftsmen, pieces of support equipment or quantity of materials. Thus there may be the need for an additional calculation to determine the attributes of leveled start and leveled finish such that the usage of resources does not exceed the limits set. This additional analysis, if performed, must be reviewed carefully. If the analysis calculates leveled starts and finishes between the early and late starts and finishes calculated by the CPM algorithm, all is well. If, on the other hand, the leveling calculation pushes completion beyond the desired end date, the project team must revisit the original plan to determine if an alternate means exists to perform the project in the stipulated timeframe with the limited resources provided.

Often, a project manager will be satisfied that the schedule *can* be leveled, then throw away the printout and run the project using only the CPM algorithm generated attributes. This is because once the CPM is subject to leveling or further restriction, it returns to being a bar-chart. Rather than being a flexible guide to decision making, it can become a static picture of precisely how the day-to-day detail of the project should be run, which will quickly become out of date as the real world diverges from the model. In addition, a project manager will often include elements of “soft logic,” including the sequencing of crews, formwork, and other resources into the original logic such that the calculated *early* start is, in fact, a leveled start. (In chapter 29 on revisions, we discuss that this “soft logic” is the first area subject to adjustment if a need to recover from delay occurs.) This informal means of “leveling” is thus acceptable if not optimal on most small- to medium-sized projects. On the other hand, as projects become larger and involve a greater variety

of resources, a leveled schedule may become useful if not too restrictive of the initiatives of the project manager and the team.

Going beyond leveling, the degree of flexibility can be further narrowed by a process called smoothing. This algorithm will not lengthen the project but rather will first look at the possible choices for leveling the project and then choose the one most likely to result in the fewest instances of layoff and rehiring or fluctuation in resource usage. Thus two additional attributes, smoothed start and finish, are assigned. Finally, a project manager may, with or without the use of leveling and smoothing calculations, simply incorporate an additional layer of control as a command decision to stipulate a scheduled start and finish for each activity, preferably somewhere between the early start and late finish. This last step may be performed at the start of the project (and thus almost certain to be subject to later revision) or at the last moment during the standard 1, 2, or 3 week look-ahead field planning and scheduling sessions that have always occurred with or without a CPM.

## 7.6. Calculating the Attributes of an Event or Activity

A program manager, in setting a series of milestones towards the completion of a project, and a project manager, in ordering a number of activity bars (of length equivalent to duration) to create a bar-chart, both are manually performing the first half of the calculations required to ascertain the CPM attributes of an event or activity. Starting from the beginning of the project, each determines what is the first event or activity and then determines those events and activities that follow. The process continues until project completion is accomplished. Calculation of the earliest time that an event may occur or the earliest time that an activity may start and finish is performed in the same manner, starting from the beginning and running to the end—a *forward pass* through all of the events and activities of the project.

## 7.7. The Forward Pass— $T_E$ , $ES$ , and $EF$

By definition, the earliest time of the first event  $T_E$  or activity start  $ES$  is traditionally set as zero. (Primavera Software Systems sets such time as one.) The early finish of any activity  $EF$  is defined as equal to  $ES$  plus the duration of the activity. Thus far, the calculation is simple. However, other than the first event or activity, each other event or activity is preceded by one or more other events or activities. So the question becomes, “what is the  $T_E$  or  $ES$  of the next event or activity?”

If for example, an event is preceded by three other events, then that event’s  $T_E$  cannot occur until all three are completed and specifically until the latest  $T_E$  of the three predecessor events has occurred. If, for

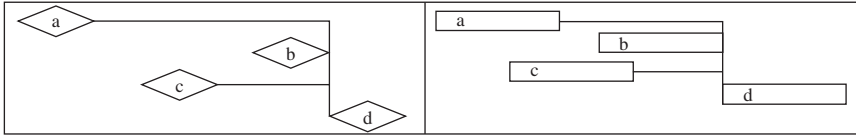

Figure 7.7.1 The forward pass –  $T_E$ , ES & EF.

example, an activity is preceded by three other activities, then that activity’s *ES* cannot start until all three are completed and specifically until the latest *EF* of the three predecessors. (Figure 7.7.1.)

Thus the attributes of  $T_E$ , *ES*, and *EF* may be defined by the equations:

$T_{E0} = 0$	$ES_0 = 0$
$T_E = \text{Latest } (T_{E \text{ PRED}} + D_{\text{PRED}})$	$EF = ES + D$
	$ES = \text{LEF}_{\text{PRED}}$

### 7.8. The Backward Pass— $T_L$ , *LF*, and *LS*

The key improvement of a CPM over the bar-chart methodology is to calculate and report not only the earliest or scheduled dates on which an event may occur or an activity may start and finish, but also the latest dates. There are some planning and scheduling problems that call for this as the primary information required, such as planning for a wedding or a company or industry conference. (What is the last date we can make changes to the invitation or brochure?) However, it is the combination of early dates and late dates that provides true empowerment to the project manager. Knowing that he/she may start five activities but only has the resources to perform four at any time is now replaced by knowing the impact to the project if any one or more of the activities are deferred.

The means of determining the latest dates for each event or activity is to go from the end of the project working backward—a *backward pass* through all of the events and activities to the start of the project. By definition, the latest time of the last event  $T_L$  or activity finish *LF* is traditionally set as equal to the earliest time of the last event  $T_E$  or activity finish *EF*. This is because, all other things being equal, it is more economical to complete a project as early as reasonably possible. Later additions and expansions to the original CPM algorithm permit the user to set a stipulated or mandated FNET finish-not-later-than date, but the original system did not have this option. Next, the late start of any activity *LS* is defined as equal to *LF* minus the duration of the activity. And, working backwards, this event or activity is preceded by another until we reach the start of the logic network. So the question becomes, “what is the  $T_L$  or *LF* of the preceding event or activity?”

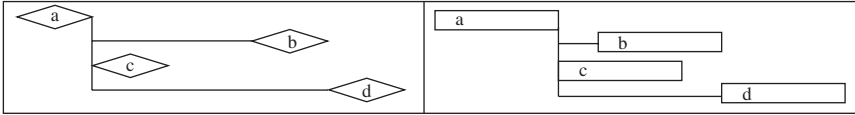

Figure 7.8.1 The backward pass –  $T_L$ ,  $LF$  &  $LS$ .

If, for example, an event is succeeded by three other events, then that event's  $T_L$  must occur prior to the earliest  $T_L$  of the three successor events. And if, for example, an activity is succeeded by three other activities, then that activity's  $LF$  must occur before the earliest  $LS$  of the three successors. (Figure 7.8.1.)

Thus the attributes of  $T_L$ ,  $LF$ , and  $LS$  can be defined by the equations:

$T_{L\text{end}} = 0$	$LF_{\text{end}} = EF_{\text{end}}$
$T_L = \text{Earliest } (T_{L\text{SUCC}} - D_{\text{SUCC}})$	$LS = LF - D$
	$LF = ELS_{\text{SUCC}}$

### 7.9. The Backward Pass— $TF$ , $FF$ , and $IF$

At this point, arithmetic calculations can determine the number of time units between the time when an event may start and when it must finish (if the project is to be completed by the earliest possible time), between when each activity may start and must start, and between when each activity may finish and must finish. The attribute of  $TF$  may be defined by the equations:

$TF = T_L - T_E$	$TF = LF - LS$
	$TF = EF - ES$

In the case of traditional CPM, these three equalities, all equal to  $TF$ , are thus all equal to each other. The activity attribute of free float is defined as the difference between the earliest of the early starts of all successors to an activity and the calculated early finish of that activity. (Figure 7.9.1)

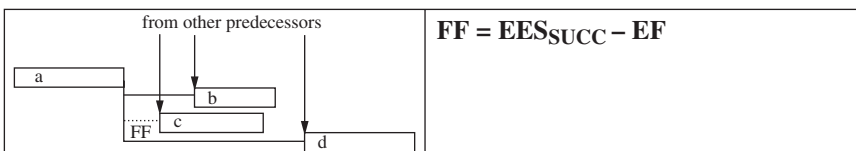
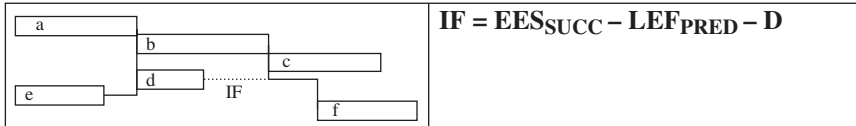

Figure 7.9.1 Free Float.



**Figure 7.9.2** Independent Float.

The activity attribute of independent float is defined as the difference between the earliest of the early starts of all successors to an activity and the latest of the early finishes of all predecessors of that activity. (Figure 7.9.2.)

Calculation of the attributes of leveled start and finish (as well as smoothed start and finish) is not so easily performed and cannot be solved by a single equation. This will be more fully discussed in Chapter 37.

## 7.10. Summary

By merely recording the relationships and probable durations between events, or the relationships and estimated durations of activities, the mathematics of PERT and CPM will calculate a number of attributes about the event or activity that would otherwise not be readily determined. These include, for an event, not only the earliest time that the event is expected to occur, but the latest, and the difference between these two times or dates. These include for an activity, not only the earliest time that the activity may be expected to start and finish, but the latest time that the activity must finish if the project is to be completed in the earliest possible time. Also computed are the attributes of total float, free float, and independent float, concepts that are discussed in the Chapter 8.

## Cranking the Engine

The first CPM and PERT logic networks calculated schedules by the new invention, the electronic computer. Manual simulation of the steps taken by the computer program, to prove that the model worked and to allow individuals to calculate smaller schedules, involved the use of a matrix. This was a natural step because mathematicians often used a graphic grid to solve problems. Figure 8.0.1 shows a portion of the logic network for the John Doe Project that will be developed in Chapter 18 with assigned time estimates.

### 8.1. Manual and Computer Solutions for PERT and ADM— The Matrix Method

Figure 8.1.1 (a) through (e) shows the development of the matrix (grid) for this small portion. The  $i$ -nodes are listed on the  $X$  axis down the side of the matrix, while the  $j$ -nodes are listed across the top of the matrix. Two columns are reserved for recording the earliest time the node can occur ( $T_{Ei}$ ) and calculation thereof; two rows are reserved for recording the latest time by which the node must occur ( $T_{Lj}$ ) and calculation thereof. A tabular listing of the CPM activities ( $i-j$ ), duration and calculated attributes of  $ES$ ,  $EF$ ,  $LS$ ,  $LF$ , and  $TF$  are at the right and this list may be longer or shorter than the number of rows assigned to the matrix. A true PERT system (unlike the NASA CPM/PERT) will report only the  $T_E$  and  $T_L$  for each event.

We previously noted the need in the original computer programs for sequential numbering of the nodes such that 1–2–3 or 3–5–12 are acceptable but 1–3–2 or 3–12–5 are not acceptable. This was explained as a means of reducing the amount of computer memory required to solve the CPM algorithm and is the basis for such restrictions and extensions

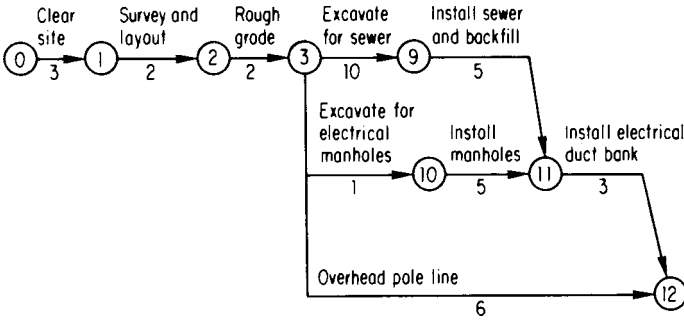

Figure 8.0.1 Activity time assignment: site preparation.

<i>i</i> / <i>j</i>	0	1	2	3	9	10	11	12	$T_{Ei}$	MAX	<i>i</i> - <i>j</i>	dur	ES	EF	LS	LF	TF
0																	
1																	
2																	
3																	
9																	
10																	
11																	
12																	
$T_{Lj}$																	
MIN																	

Figure 8.1.1 (a)

<i>i</i> / <i>j</i>	0	1	2	3	9	10	11	12	$T_{Ei}$	MAX	<i>i</i> - <i>j</i>	dur	ES	EF	LS	LF	TF
0	—																
1	—	—															
2	—	—	—														
3	—	—	—	—													
9	—	—	—	—	—												
10	—	—	—	—	—	—											
11	—	—	—	—	—	—	—										
12	—	—	—	—	—	—	—	—									
$T_{Lj}$																	
MIN																	

Figure 8.1.1 (b)

<i>i</i> / <i>j</i>	0	1	2	3	9	10	11	12	$T_{Ei}$	MAX	<i>i</i> - <i>j</i>	dur	ES	EF	LS	LF	TF
0	—	1	2	3	4	5	6	7									
1	—	—	8	9	10	11	12	13									
2	—	—	—	14	15	16	17	18									
3	—	—	—	—	19	20	21	22									
9	—	—	—	—	—	23	24	25									
10	—	—	—	—	—	—	26	27									
11	—	—	—	—	—	—	—	28									
12	—	—	—	—	—	—	—	—									
$T_{Lj}$																	
MIN																	

$$28 = 8 \times 7/2 = n(n - 1)/2$$

Figure 8.1.1 (c)



$i \setminus j$	0	1	2	3	9	10	11	12	$T_{Ei}$	MAX	$i - j$	dur	ES	EF	LS	LF	TF
0	—	3									0 - 1	3					
1	—	—															
2	—	—	—														
3	—	—	—	—													
9	—	—	—	—	—												
10	—	—	—	—	—	—											
11	—	—	—	—	—	—	—										
12	—	—	—	—	—	—	—	—									
$T_{Lj}$																	
MIN																	

Figure 8.1.1 (d)

(such as skip numbering) found in older specifications. The reason this numbering restriction reduces use of memory is that it drastically reduces the number of cells of the matrix. Thus for our example of a nine activity network using eight nodes, the number of cells possibly required can be reduced from 56 to 28, or from  $n^*(n-1)$  to  $n^*(n-1)/2$ . (If calculation of attributes for the milestones or events of the network, such as “activity” 3-3 are desired, an additional  $n$  cells will be required.) (Figure 8.1.1(c).)

Once we have prepared the matrix, we may do the “take-off” from the logic network. We copy activity  $i - j$  of 0 - 1 and duration of 3 to the tabular listing at the right, then transfer the duration of 3 to the intersection on the matrix of  $i = 0$  and  $j = 1$ . (Figure 8.1.1(d).)

Continuing, we duplicate this effort for the other activities of the logic network. A similar effort may be used to copy only the logic and durations between PERT event nodes to the matrix. (Figure 8.1.1(e).)

At this point we begin the solution. By definition,  $T_{E0}$ , the earliest time that the first event node may occur, is set to zero. Next, to calculate the  $T_{Ei}$  for node 1, we go to the column for  $j = 1$  and choose the maximum of duration plus previously calculated  $T_{Ei}$  for each row where a duration is entered, in this case 3. For a CPM, the  $T_{Ei}$  is copied to all activities having that  $i$  node.

The process is repeated until the forward pass is completed, as shown in Figures 8.1.2 (a) through (h).

$i \setminus j$	0	1	2	3	9	10	11	12	$T_{Ei}$	MAX	$i - j$	dur	ES	EF	LS	LF	TF
0	—	3									0 - 1	3					
1	—	—	2								1 - 2	2					
2	—	—	—	2							2 - 3	2					
3	—	—	—	—	10	1		6			3 - 9	10					
9	—	—	—	—	—		5				3 - 10	1					
10	—	—	—	—	—	—	5				3 - 12	6					
11	—	—	—	—	—	—	—	3			9 - 11	5					
12	—	—	—	—	—	—	—	—			10 - 11	5					
$T_{Lj}$											11 - 12	3					
MIN																	

Figure 8.1.1 (e)

$i \setminus j$	0	1	2	3	9	10	11	12	$T_{Ei}$	MAX	$i - j$	dur	ES	EF	LS	LF	TF
0	—	3							0	$T_{E0}=0$	0-1	3	0				
1	—	—	2								1-2	2					
2	—	—	—	2							2-3	2					
3	—	—	—	—	10	1		6			3-9	10					
9	—	—	—	—	—		5				3-10	1					
10	—	—	—	—	—	5					3-12	6					
11	—	—	—	—	—	—	—	3			9-11	5					
12	—	—	—	—	—	—	—	—			10-11	5					
$T_{Lj}$											11-12	3					
MIN													$T_{Ei}$				

Figure 8.1.2 (a) Determine  $\text{MAX}(T_{Ei} + D_{ij}) = \text{MAX}$  (earliest time for node  $i$  plus duration from  $i$  to  $j$ ).

$i \setminus j$	0	1	2	3	9	10	11	12	$T_{Ei}$	MAX	$i - j$	dur	ES	EF	LS	LF	TF
0	—	3							0	$T_{E0}=0$	0-1	3	0				
1	—	—	2						3	$3+0$	1-2	2	3				
2	—	—	—	2							2-3	2					
3	—	—	—	—	10	1		6			3-9	10					
9	—	—	—	—	—		5				3-10	1					
10	—	—	—	—	—	5					3-12	6					
11	—	—	—	—	—	—	—	3			9-11	5					
12	—	—	—	—	—	—	—	—			10-11	5					
$T_{Lj}$											11-12	3					
MIN													$T_{Ei}$				

Figure 8.1.2 (b) Determine  $\text{MAX}(T_{Ei} + D_{ij}) = \text{MAX}$  (earliest time for node  $i$  plus duration from  $i$  to  $j$ ).

$i \setminus j$	0	1	2	3	9	10	11	12	$T_{Ei}$	MAX	$i - j$	dur	ES	EF	LS	LF	TF
0	—	3							0	$T_{E0}=0$	0-1	3	0				
1	—	—	2						3		1-2	2	3				
2	—	—	—	2					5	$2+3$	2-3	2	5				
3	—	—	—	—	10	1		6			3-9	10					
9	—	—	—	—	—		5				3-10	1					
10	—	—	—	—	—	5					3-12	6					
11	—	—	—	—	—	—	—	3			9-11	5					
12	—	—	—	—	—	—	—	—			10-11	5					
$T_{Lj}$											11-12	3					
MIN													$T_{Ei}$				

Figure 8.1.2 (c) Determine  $\text{MAX}(T_{Ei} + D_{ij}) = \text{Earliest time for node } i \text{ plus duration from } i \text{ to } j$ .

$i \setminus j$	0	1	2	3	9	10	11	12	$T_{Ei}$	MAX	$i - j$	dur	ES	EF	LS	LF	TF
0	—	3							0	$T_{E0}=0$	0-1	3	0				
1	—	—	2						3		1-2	2	3				
2	—	—	—	2					5		2-3	2	5				
3	—	—	—	—	10	1		6	7	$2+5$	3-9	10	7				
9	—	—	—	—	—		5				3-10	1	7				
10	—	—	—	—	—	5					3-12	6	7				
11	—	—	—	—	—	—	—	3			9-11	5					
12	—	—	—	—	—	—	—	—			10-11	5					
$T_{Lj}$											11-12	3					
MIN													$T_{Ei}$				

Figure 8.1.2 (d) Determine  $\text{MAX}(T_{Ei} + D_{ij}) = \text{Earliest time for node } i \text{ plus duration from } i \text{ to } j$ .

$i \setminus j$	0	1	2	3	9	10	11	12	$T_{Ei}$	MAX	$i - j$	dur	ES	EF	LS	LF	TF
0	—	3							0	$T_{E0}=0$	0 - 1	3	0				
1	—	—	2						3		1 - 2	2	3				
2	—	—	—	2					5		2 - 3	2	5				
3	—	—	—	—	10	1		6 →	7		3 - 9	10	7				
9	—	—	—	—	—			5	17	10 + 7	3 - 10	1	7				
10	—	—	—	—	—			5			3 - 12	6	7				
11	—	—	—	—	—	—		3			9 - 11	5	17				
12	—	—	—	—	—	—	—	—			10 - 11	5					
$T_{Lj}$											11 - 12	3					
MIN													$T_{Ei}$				

Figure 8.1.2 (e) Determine  $\text{MAX}(T_{Ei} + D_{ij}) =$  Earliest time for node  $i$  plus duration from  $i$  to  $j$ .

$i \setminus j$	0	1	2	3	9	10	11	12	$T_{Ei}$	MAX	$i - j$	dur	ES	EF	LS	LF	TF
0	—	3							0	$T_{E0}=0$	0 - 1	3	0				
1	—	—	2						3		1 - 2	2	3				
2	—	—	—	2					5		2 - 3	2	5				
3	—	—	—	—	10	1		6 →	7		3 - 9	10	7				
9	—	—	—	—	—			5	17		3 - 10	1	7				
10	—	—	—	—	—			5	8	1+7	3 - 12	6	7				
11	—	—	—	—	—	—		3			9 - 11	5	17				
12	—	—	—	—	—	—	—	—			10 - 11	5	8				
$T_{Lj}$											11 - 12	3					
MIN													$T_{Ei}$				

Figure 8.1.2 (f) Determine  $\text{MAX}(T_{Ei} + D_{ij}) =$  Earliest time for node  $i$  plus duration from  $i$  to  $j$ .

$i \setminus j$	0	1	2	3	9	10	11	12	$T_{Ei}$	MAX	$i - j$	dur	ES	EF	LS	LF	TF
0	—	3							0	$T_{E0}=0$	0 - 1	3	0				
1	—	—	2						3		1 - 2	2	3				
2	—	—	—	2					5		2 - 3	2	5				
3	—	—	—	—	10	1		6	7		3 - 9	10	7				
9	—	—	—	—	—			5	17		3 - 10	1	7				
10	—	—	—	—	—			5	8		3 - 12	6	7				
11	—	—	—	—	—	—		3	22	5 + 17 5 + 8	9 - 11	5	17				
12	—	—	—	—	—	—	—	—			10 - 11	5	8				
$T_{Lj}$											11 - 12	3	22				
MIN													$T_{Ei}$				

Figure 8.1.2 (g) Determine  $\text{MAX}(T_{Ei} + D_{ij}) =$  Earliest time for node  $i$  plus duration from  $i$  to  $j$ .

$i \setminus j$	0	1	2	3	9	10	11	12	$T_{Ei}$	MAX	$i - j$	dur	ES	EF	LS	LF	TF
0	—	3							0	$T_{E0}=0$	0 - 1	3	0				
1	—	—	2						3		1 - 2	2	3				
2	—	—	—	2					5		2 - 3	2	5				
3	—	—	—	—	10	1		6 →	7		3 - 9	10	7				
9	—	—	—	—	—			5	17		3 - 10	1	7				
10	—	—	—	—	—			5	8		3 - 12	6	7				25
11	—	—	—	—	—	—		3 →	22		9 - 11	5	17				
12	—	—	—	—	—	—	—	—	25	6 + 7 3 + 22	10 - 11	5	8				
$T_{Lj}$									25		11 - 12	3	22				25
MIN													$T_{Ei}$				$T_{Lj}$

Figure 8.1.2 (h) Determine  $\text{MAX}(T_{Ei} + D_{ij}) =$  Earliest time for node  $i$  plus duration from  $i$  to  $j$ .

$i \setminus j$	0	1	2	3	9	10	11	12	$T_{Ei}$	MAX	$i - j$	dur	ES	EF	LS	LF	TF
0	—	3							0	$T_{E0} = 0$	0 - 1	3	0				
1	—	—	2						3		1 - 2	2	3				
2	—	—	—	2					5		2 - 3	2	5				
3	—	—	—	—	10	1		6	7		3 - 9	10	7				
9	—	—	—	—	—			5	17		3 - 10	1	7				
10	—	—	—	—	—			5	8		3 - 12	6	7				25
11	—	—	—	—	—	—	—	3	22		9 - 11	5	17				22
12	—	—	—	—	—	—	—	—	25		10 - 11	5	8				22
$T_{Lj}$								22	25		11 - 12	3	22				25
MIN								25 - 3	$T_{Ei}$				$T_{Ei}$				$T_{Lj}$

Figure 8.1.3 (a) Determine  $\text{MIN}(T_{Lj} - D_{ij}) =$  Latest time for node  $j$  minus duration from  $i$  to  $j$ .

At this point, we copy the  $T_{Ei}$  for the last node to the  $T_{Lj}$  for the last node since it is assumed that the project should finish as soon as possible. For the CPM tabulation, this late time is copied to the late finish attribute of those activities having the same  $j$  node.

Now we begin the backward pass. To calculate the  $T_{Lj}$  for node 11, we look to the row for  $i = 11$ , locate the durations listed on that row, and subtract them from the  $T_{Lj}$  previously calculated for that column. Thus,  $25 - 3 = 22$ . This process is repeated until we get back to  $j = 0$  as shown in Figures 8.1.3 (a) through (g).

Finally, if we are preparing a CPM, we calculate the secondary attributes of  $EF = ES + D$ ,  $LS = LF - D$  and  $TF = LF - EF = LS - ES$ . This step is not required if we are working with an event-based system, such as PERT. (Figure 8.1.4)

Although the matrix served its purpose in early work, there is an easier and more direct solution. When James Kelley, a member of the original CPM group, was asked why his group had not immediately seen an easier solution, he explained it this way: If both the mathematician and the engineer are confronted with the problem of how to move a pan of water from the kitchen table to the stove, both will solve it by lifting the pan from the table directly to the stove. The next day,

$i \setminus j$	0	1	2	3	9	10	11	12	$T_{Ei}$	MAX	$i - j$	dur	ES	EF	LS	LF	TF
0	—	3							0	$T_{E0} = 0$	0 - 1	3	0				
1	—	—	2						3		1 - 2	2	3				
2	—	—	—	2					5		2 - 3	2	5				
3	—	—	—	—	10	1		6	7		3 - 9	10	7				
9	—	—	—	—	—			5	17		3 - 10	1	7				17
10	—	—	—	—	—			5	8		3 - 12	6	7				25
11	—	—	—	—	—	—	—	3	22		9 - 11	5	17				22
12	—	—	—	—	—	—	—	—	25		10 - 11	5	8				22
$T_{Lj}$								17	22		11 - 12	3	22				25
MIN								22 - 5	$T_{Ei}$				$T_{Ei}$				$T_{Lj}$

Figure 8.1.3 (b) Determine  $\text{MIN}(T_{Lj} - D_{ij}) =$  Latest time for node  $j$  minus duration from  $i$  to  $j$ .

$i \setminus j$	0	1	2	3	9	10	11	12	$T_{Ei}$	MAX	$i - j$	dur	ES	EF	LS	LF	TF
0	—	3							0	$T_{E0} = 0$	0 - 1	3	0				
1	—	—	2						3		1 - 2	2	3				
2	—	—	—	2					5		2 - 3	2	5				
3	—	—	—	—	10	1		6	7		3 - 9	10	7				17
9	—	—	—	—	—	—	5	↑	17		3 - 10	1	7				17
10	—	—	—	—	—	—	—	5	8		3 - 12	6	7				25
11	—	—	—	—	—	—	—	—	3	22	9 - 11	5	17				22
12	—	—	—	—	—	—	—	—	25		10 - 11	5	8				22
$T_{Lj}$					17	17	22	25			11 - 12	3	22				25
MIN					22 - 5			$T_{Ei}$					$T_{Ei}$				$T_{Lj}$

Figure 8.1.3 (c) Determine  $\text{MIN}(T_{Lj} - D_{ij}) =$  Latest time for node  $j$  minus duration from  $i$  to  $j$ .

$i \setminus j$	0	1	2	3	9	10	11	12	$T_{Ei}$	MAX	$i - j$	dur	ES	EF	LS	LF	TF
0	—	3							0	$T_{E0} = 0$	0 - 1	3	0				
1	—	—	2						3		1 - 2	2	3				
2	—	—	—	2					5		2 - 3	2	5				7
3	—	—	—	—	10	↑	1	6	7		3 - 9	10	7				17
9	—	—	—	—	—	↑	—	5	17		3 - 10	1	7				17
10	—	—	—	—	—	—	—	5	8		3 - 12	6	7				25
11	—	—	—	—	—	—	—	—	3	22	9 - 11	5	17				22
12	—	—	—	—	—	—	—	—	25		10 - 11	5	8				22
$T_{Lj}$					7	17	22	25			11 - 12	3	22				25
MIN					25 - 6 17 - 1 17 - 10			$T_{Ei}$					$T_{Ei}$				$T_{Lj}$

Figure 8.1.3 (d) Determine  $\text{MIN}(T_{Lj} - D_{ij}) =$  Latest time for node  $j$  minus duration from  $i$  to  $j$ .

$i \setminus j$	0	1	2	3	9	10	11	12	$T_{Ei}$	MAX	$i - j$	dur	ES	EF	LS	LF	TF
0	—	3							0	$T_{E0} = 0$	0 - 1	3	0				
1	—	—	2						3		1 - 2	2	3				5
2	—	—	—	2					5		2 - 3	2	5				7
3	—	—	—	—	10	↑	1	6	7		3 - 9	10	7				17
9	—	—	—	—	—	—	5	↑	17		3 - 10	1	7				17
10	—	—	—	—	—	—	5	↑	8		3 - 12	6	7				25
11	—	—	—	—	—	—	—	—	3	22	9 - 11	5	17				22
12	—	—	—	—	—	—	—	—	25		10 - 11	5	8				22
$T_{Lj}$					5	7	17	22	25		11 - 12	3	22				25
MIN					7 - 2			$T_{Ei}$					$T_{Ei}$				$T_{Lj}$

Figure 8.1.3 (e) Determine  $\text{MIN}(T_{Lj} - D_{ij}) =$  Latest time for node  $j$  minus duration from  $i$  to  $j$ .

$i \setminus j$	0	1	2	3	9	10	11	12	$T_{Ei}$	MAX	$i - j$	dur	ES	EF	LS	LF	TF
0	—	3							0	$T_{E0} = 0$	0 - 1	3	0				3
1	—	—	2						3		1 - 2	2	3				5
2	—	—	—	2					5		2 - 3	2	5				7
3	—	—	—	—	10	↑	1	6	7		3 - 9	10	7				17
9	—	—	—	—	—	—	5	↑	17		3 - 10	1	7				17
10	—	—	—	—	—	—	5	↑	8		3 - 12	6	7				25
11	—	—	—	—	—	—	—	—	3	22	9 - 11	5	17				22
12	—	—	—	—	—	—	—	—	25		10 - 11	5	8				22
$T_{Lj}$					3	5	7	17	22	25	11 - 12	3	22				25
MIN					5 - 2			$T_{Ei}$					$T_{Ei}$				$T_{Lj}$

Figure 8.1.3 (f) Determine  $\text{MIN}(T_{Lj} - D_{ij}) =$  Latest time for node  $j$  minus duration from  $i$  to  $j$ .

$i \setminus j$	0	1	2	3	9	10	11	12	$T_{Ei}$	MAX	$i-j$	dur	ES	EF	LS	LF	TF
0	—	3							0	$T_{E0} = 0$	0-1	3	0			3	
1	—	—	2						3		1-2	2	3			5	
2	—	—	—	2					5		2-3	2	5			7	
3	—	—	—	—	10	1		6	7		3-9	10	7			17	
9	—	—	—	—	—		5		17		3-10	1	7			17	
10	—	—	—	—	—	—	5		8		3-12	6	7			25	
11	—	—	—	—	—	—	—	3	22		9-11	5	17			22	
12	—	—	—	—	—	—	—	—	25		10-11	5	8			22	
$T_{Lj}$	0	3	5	7	17	17	22	25			11-12	3	22			25	
MIN	3-3								$T_{Ei}$					$T_{Ei}$			

Figure 8.1.3 (g) Determine  $MIN (T_{Lj} - D_{ij}) =$  Latest time for node  $j$  minus duration from  $i$  to  $j$ .

the engineer, on finding the pan of water on the floor, will again move it directly to the stove. Under the same circumstances, the mathematician would first move the pan from the floor to the table and then from the table to the stove. Why? Because the mathematician has already solved the table-to-stove problem.

Similarly, having used the matrix approach before, it was natural for the CPM mathematicians to use it in solving the network manually.

### 8.2. Manual and Computer Solution for PERT and ADM—The Intuitive Method

#### Intuitive manual computation

The manual CPM computation now in use was probably developed concurrently by several persons. There is a famous phrase used by almost all college professors at some time or other in explaining a mathematical solution: “*Intuitively* we can understand this next step . . .” In this case, however, the computation *is* based upon common sense and *is* intuitively obvious. Since the matrix was still in use by the CPM originating team in late 1960, the intuitive solution probably originated in 1961. The mental block that probably deterred the mathematicians

$i \setminus j$	0	1	2	3	9	10	11	12	$T_{Ei}$	MAX	$i-j$	dur	ES	EF	LS	LF	TF
0	—	3							0	$T_{E0} = 0$	0-1	3	0	3	0	3	0
1	—	—	2						3		1-2	2	3	5	3	5	0
2	—	—	—	2					5		2-3	2	5	7	5	7	0
3	—	—	—	—	10	1		6	7		3-9	10	7	17	7	17	0
9	—	—	—	—	—		5		17		3-10	1	7	8	16	17	1
10	—	—	—	—	—	—	5		8		3-12	6	7	13	19	25	12
11	—	—	—	—	—	—	—	3	22		9-11	5	17	22	17	22	0
12	—	—	—	—	—	—	—	—	25		10-11	5	8	13	17	22	9
$T_{Lj}$	0	3	5	7	17	17	22	25			11-12	3	22	25	22	25	0
MIN									$T_{Ei}$					$T_{Ei}$			$T_{Lj}$

Figure 8.1.4 Determine  $EF = ES + D$ ;  $LS = LF - D$ ;  $TF = LF - EF = LS - ES$ .

from arriving at it is that the intuitive solution is logical rather than mathematical.

**Early event times  $T_E$**

Look at the first activity in Figure 8.0.1,

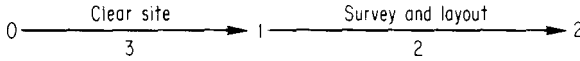

If the project is started at event 0, what is the earliest time for reaching event 1? According to estimate, 3 days would finish clearing the site. The early time  $T_E$  for event 1 is then 3 days. How early could event 2 be reached? The answer is, of course, 3 + 2, or at the end of the fifth project day. To keep track of those results, show them in a box just over the event:

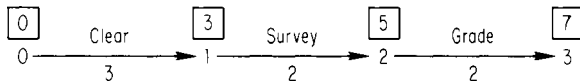

The earliest schedule for reaching event 3 is the sum of the times required to accomplish the first three activities, 3 + 2 + 2, or 7. Now look at event 9. Do not go back to the originating event to determine the  $T_E$  (early event time) for this event. Add the duration to the  $T_E$  for event 3, and the result is a  $T_E$  of 17 for event 9. To go on to event 11, two logic paths lead into this event:

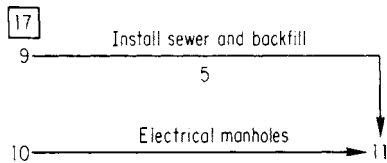

The earliest time for reaching event 11 is along path 3-9-11. This is  $T_E$  for event 9 plus the duration, or 17 + 5, or 22. Note this without enclosing it in a box, and then investigate the path through events 3-10-11:

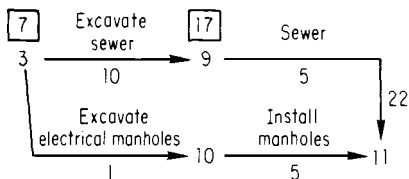

For event 10, the  $T_E$  is  $7 + 1$ , or 8. For event 11 along path 3–10–11, the early event time is  $8 + 5$ , or 13. The activities along path 0–1–2–3–10–11 can be accomplished in as early a time as 13 days; along path 0–1–2–3–9–11 they would take 22 days. What is  $T_E$  for event 11? The earliest time for reaching event 11 is the end of the twenty-second project day. Accordingly, discard the 13-day solution and select the longer 22-day answer as  $T_E$  for event 11:

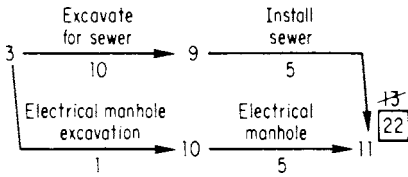

$T_E$  is always the larger value when there is a choice between two or more values.

A caution is in order here. Remember that the event numbers have no significance other than identification. Unfortunately, it is easy to add them in accidentally as durations or to use the event number rather than the  $T_E$ . This is particularly the case with one- or two-digit event numbers. To avoid the error, circle the event numbers, use three-digit event numbers, or do both.

Figure 8.2.1 is the entire site preparation network with times assigned and early event times noted. The  $T_E$  at event 12 is the choice of the time

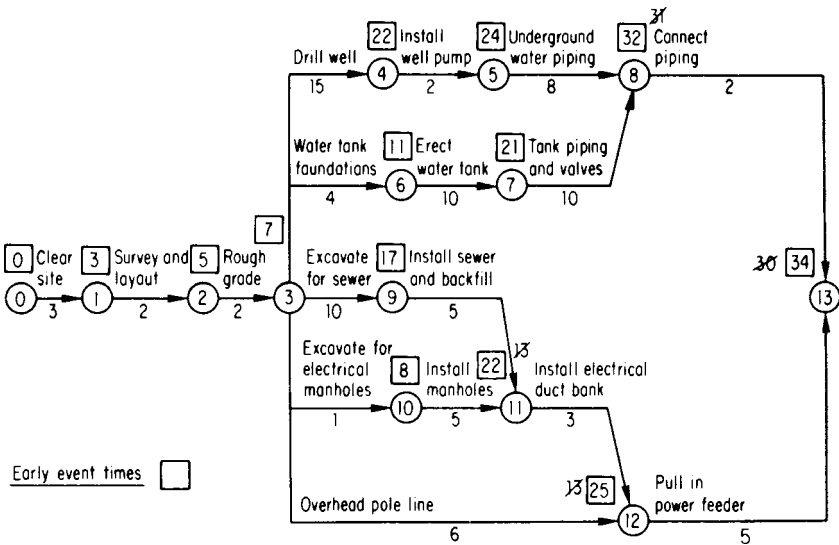

Figure 8.2.1 Early event times: site preparation.



along path 11–12 ( $22 + 3 = 25$ ) or along path 3–12 ( $7 + 6 = 13$ ). The  $T_E$  at event 12 is the longer time, or 25. The early event time at event 13 along this lower path is  $25 + 5 = 30$ .

Now observe the two upper paths. The path through events 3–4–5–8 totals 25 days. That, added to the  $T_E$  at event 3, gives an early time along the path to event 8 of  $7 + 25$ , or 32. Along the path through events 3–6–7–8, the activities total 24 days. This  $24 + 7$  is 31 days, which is less than 32. Thus, the  $T_E$  at event 8 is 32. The early time to event 13 along the upper path is 34 days. Since this is larger than 30 days, the  $T_E$  for this network is 34.

The result is 34 days, but what is the significance? Based on our logical sequence and time estimates, the shortest time in which this work could be completed is 34 working days, or about 7 weeks.

### Late Event Time $T_L$

The late event time  $T_L$  for an event is defined as the latest time at which an event can be reached without delaying the computed project duration. Keep in mind that “late” in this context is late in terms of this computed completion time rather than a desired or prescribed completion time. To determine late event times, work backward through the network. From Figure 8.2.1, the final event 13 has two activities (8–13 and 12–13) leading into it:

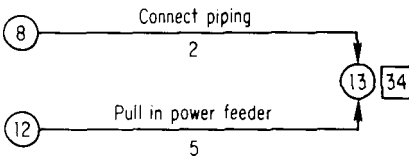

By definition, the late event time at event 13 is 34 days, since the late event time for the terminal event equals the early event time for that event. If event 13 is to be reached by time 34, event 8 must start no later than 34 less the duration of activity 8–13 ( $34 - 2$ ). Thus, the late event time for event 8 is 32. The late event time for event 12 is  $34 - 5$ , or 29.

In showing the late event times  $T_L$ , on the diagram, put them in circles to differentiate them from the  $T_E$  values. Figure 8.2.2 shows the late event times for this network. In determining  $T_0$  values, there is a choice between values when two or more arrow tails converge. On Figure 8.2.2 that occurs only at event 3, where the tails for five arrows converge. Figure 8.2.3 is an enlargement of the network at event 3.

From Table 8.2.1, the path backward from event 4 results in the “earlier” late event time at event 3.  $T_L$  is always the earlier value whenever there is a convergence of two or more arrow tails. Accordingly,  $T_L$

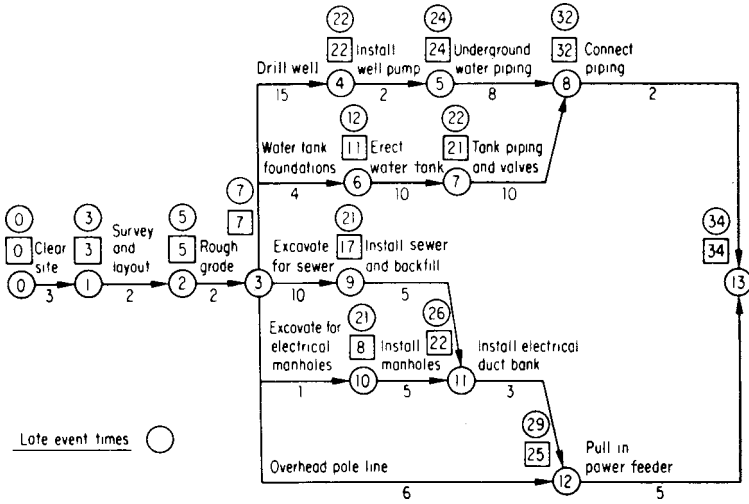

Figure 8.2.2 Late event times: site preparation.

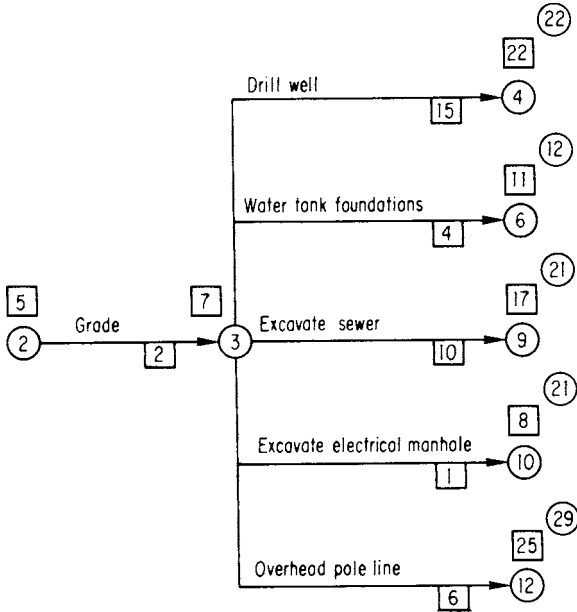

Figure 8.2.3 Network at event 3.

**TABLE 8.2.1 Late Event Times at Event 3**

Activity	Late event time	Duration, days	Late event time along this path from event 3
3-4	22	15	7
3-6	12	4	8
3-9	21	10	11
3-10	21	1	20
3-12	29	6	23

at event 3 is time 7. As a check, the late event time for the originating event should always be zero.

Computed event times, both early and late, is fundamental information. Nonetheless, network events are not very descriptive. For instance, how would you describe event 3 in Figure 8.2.3? You would probably term it “completion of grading.” But how would you indicate that it marks the logical starting point for five other activities? Certain key events, or milestones, are easily identified and are of interest. Among them are complete foundations, start steel erection, start studs, complete drywall, and start piping.

Because construction is work-oriented, activity descriptions better define the CPM plan. Accordingly, activity time information is the most useful format.

### 8.3. Activity Start and Finish Times

The source of activity start and finish times is event time calculation. Look at the typical activity:



Each activity must be bound by two events. The earliest time that an activity can start is when the *TE* for its starting (or *i*) event has been reached. That is,

$$\text{Early start} = ES = TE \text{ (event } i) = \boxed{i}$$

**TABLE 8.3.1 Activity Information First 9 Activities**

Activity	Duration, days	Description
0-1	3	Clear site
1-2	2	Survey and layout
2-3	2	Rough grade
3-4	15	Drill well
3-6	4	Water tank foundations
3-9	10	Excavate sewer
3-10	1	Excavate electrical manholes
3-12	6	Pole line
4-5	2	Well pump

If the early start ( $ES$ ) is known, the earliest time the activity can be completed is the start time plus the job duration ( $D$ ):

$$\text{Early finish} = EF = ES + \text{duration} = ES + D$$

After determining the early time for an activity, the late time is the  $TL$  for the finishing (or  $j$ ) event; that is,

$$\text{Late finish} = LF = TL (\text{event } j) = \textcircled{j}$$

After late finish, the late start is obviously

$$\text{Late start} = LS = LF - D$$

Certain information about activities can be summarized before any calculations are made. For instance, from Figure 8.2.1, the first nine activities offer the information shown in Table 8.3.1. After the event times are computed, the additional information shown in Table 8.3.2

**TABLE 8.3.2 Event Time Calculations First 9 Activities**

Activity	Duration, days	Description	ES	LF
0-1	3	Clear site	0	3
1-2	2	Survey and layout	3	5
2-3	2	Rough grade	5	7
3-4	15	Drill well	7	22
3-6	4	Water tank foundations	7	12
3-9	10	Excavate sewer	7	21
3-10	1	Excavate electrical manholes	7	21
3-12	6	Pole line	7	29
4-5	2	Well pump	22	24

**TABLE 8.3.3 Activity Time Calculations First 9 Activities**

Activity	Duration, days	Description	ES	EF	LS	LF
0-1	3	Clear site	0	3	0	3
1-2	2	Survey and layout	3	5	3	5
2-3	2	Rough grade	5	7	5	7
3-4	15	Drill well	7	22	7	22
3-6	4	Water tank foundations	7	11	8	12
3-9	10	Excavate sewer	7	17	11	21
3-10	1	Excavate electrical manholes	7	8	20	21
3-12	6	Pole line	7	13	23	29
4-5	2	Well pump	22	24	22	24

from Figure 8.2.2 can be listed. Adding duration to the *ES* column and subtracting it from the *LF* gives what is shown in Table 8.3.3.

#### 8.4. Critical Activities

The early CPM team referred to the critical path as the “main chain.” The term was dropped in favor of “critical path,” which was used by the early PERT group. The critical path determines the length of the project. It is the longest part into the last event, since it establishes the latest *TE* for the last event. Accordingly, the longest chain or path of activities through the network is the critical path.

The critical path is not always obvious. Look at the network for the John Doe plant (Figure 18.5.4.) You might guess at the critical path based upon experience, but without a project time estimate for each activity, you cannot identify it. Figure 8.4.1 is a plot of activity information on a time scale. Note that the activities 0-1, 1-2, 2-3, 3-4, and 4-5 show a solid connection; they are on the path of critical events (0-1-2-3-4-5, etc.). Look at the activity times for activity 4-5. The *ES* is 22, and the *LF* is 24. The time span between them is 24-22, or 2. Since the time span available equals the duration for activity 4-5, the activity must start on its *ES* and finish on its *EF* if the project is to finish by time 34. Note that for these critical activities, early start equals late start and early finish equals late finish.

In Figure 8.2.2, the critical path goes through events 0-1-2-3-4-5-8-13. Three conditions that each *critical activity* must meet are:

1. The early and late event times at the activity start must be equal:

$$\boxed{i} = \textcircled{i}$$

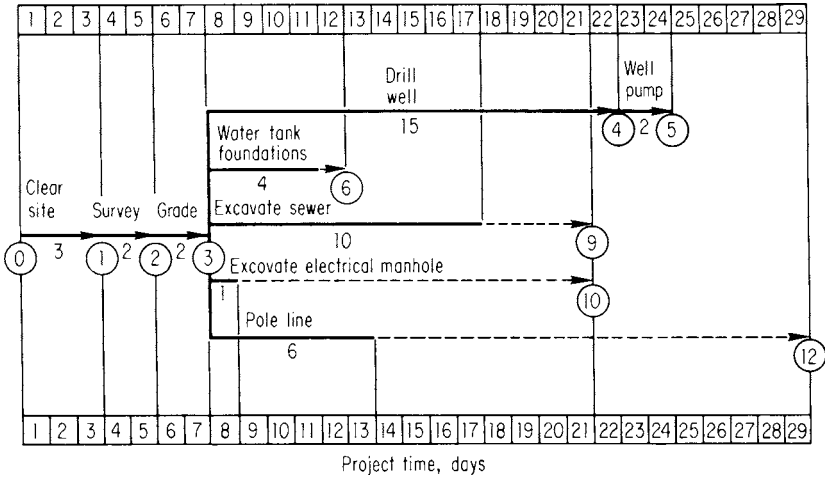

Figure 8.4.1 Plot of activity information on a time scale.

2. The early and late event times at the activity completion must be equal:

$$E_j = L_j$$

3. The difference between the *ES* and *LF* must equal the duration.

The first two conditions are easy to recognize when the network is manually computed with *TE* and *TL* on the diagram. People often forget to test for the third rule, however. Add an activity 3–5 to the network and call it deliver pipe. The delivery cannot start until the site is rough-graded (event 3), and it is needed before piping installation starts (event 5). If the delivery takes a week (duration = 5),

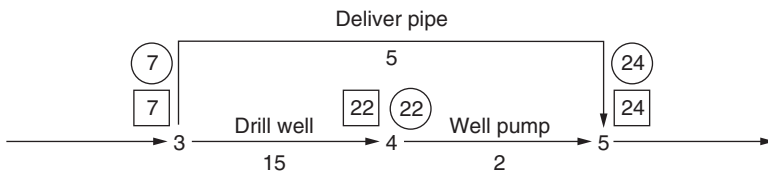

Activity 3–5 meets the first two conditions, but 24 – 7, or 17, is greater than an activity duration of 5; accordingly, activity 3–5 is not critical even though it spans two critical events.

Note that there can be any number of critical paths through the network. One path can spread out into a number of paths, and a number

of critical paths can converge into one. However, the critical path(s) must be a continuous chain of activities; it cannot be intermittent. Also, there must be at least one critical path from the first to the last event of the project.

### 8.5. Total Float

In preparing the CPM diagram for a channel improvement project, Corps of Engineers planners were certain that the critical path would be through the pile-driving activities, because pile driving had always been critical in the past. However, the Corps had reckoned without its own foresight.

Based on past experience, the Corps construction group had devised a scheme that enabled them to utilize two pile-driving rigs instead of one in the limited space available. That cut pile driving off the critical path. It was replaced by a land acquisition handled by the Corps real estate group. Their time estimate also was based on experience. In this case, the diagram served as a communication medium to advise all cognizant Corps groups of new planning factors. If activity 3–5, deliver pipe, is not critical, what differentiates it from a critical activity? Since it has an available working time span of 17 ( $24 - 7$ ) and a duration of 5, there is a latitude in scheduling it equal to  $17 - 5$ , or 12. We call this characteristic float:

$$\text{Float} = F = (LF - ES) - D$$

Since  $EF = ES + D$ ,

$$\begin{aligned}\text{Float} &= (LF - ES) - D = LF - (ES + D) \\ &= LF - EF\end{aligned}$$

Also, since  $(LF = LS + D)$  and  $(EF = ES + D)$ ,

$$\begin{aligned}\text{Float} &= LF - EF = (LS + D) - (ES + D) \\ &= LS - ES\end{aligned}$$

Getting away from formulas, it is reasonable for the difference between the early and late starts to equal the scheduling flexibility, or float. Also, the difference between the late and early finishes furnishes the same values.

In the network shown in Figure 8.2.2, the total float for all activities, by using each of the previously mentioned formulas, is shown in Table 8.5.1.

Case 1, shown in Figure 8.5.1, is a time scale plot of activities 3–9, 9–11, 11–12, and 12–13. The total float for each of the activities is 4. Does this mean that each of the activities has 4 days of float to use? The answer

TABLE 8.5.1 Float Calculations

Formula: $F = LF - ES - D$				
Activity	LF	-ES	-Duration	= Float
0-1	3	0	3	0
1-2	5	3	2	0
2-3	7	5	2	0
3-4	22	7	15	0
3-6	12	7	4	1

Activity	LF	-ES	-Duration	= Float
3-9	21	7	10	4
3-10	21	7	1	13
3-12	29	7	6	16
4-5	24	22	2	0

Formula: $F = LF - EF$			
Activity	LF	-EF	= Float
5-8	32	32	0
6-7	22	21	1
7-8	32	31	1
8-13	34	34	0

Formula: $F = LS - ES$			
Activity	LS (LF - D)	-ES	= Float
9-11	21	17	4
10-11	21	8	13
11-12	26	22	4
12-13	29	25	4

is a qualified yes. If none of the prior activities in this same chain has used the float, the answer is yes (see Table 8.5.2).

In case 2, shown in Figure 8.5.1, assume that activity 3-9 used the 4 days of float. That is, it started at time 11 instead of the *ES* of 7. The result is a solid link of activities following 3-9. When total float is used up by any one activity or a series of activities, all succeeding activities become critical.

Case 3, shown in Figure 8.5.1, illustrates the use of total float by different activities in the chain. Activity 3-9 starts two days after its early start, which reduces the float to two days. Activity 11-12 delays its start until the late start, and no float remains. Look at the float picture in the broader view. The *TE* for event 3 is 7; the *TL* for event 13 is 34. The difference, or 27 days, is the time span within which the four activities must be accomplished. Adding the durations of these four activities results in what is shown in Table 8.5.3.



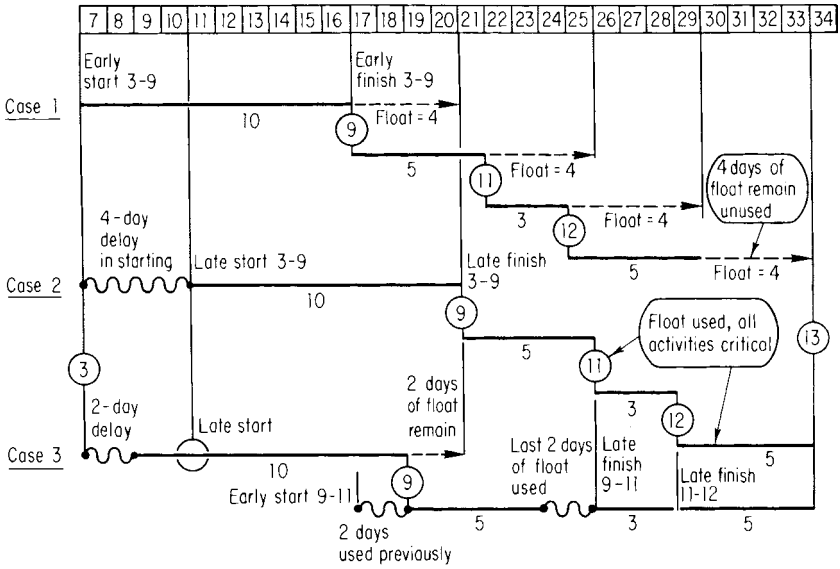

Figure 8.5.1 Time scale plot of activities.

TABLE 8.5.2 Total Float Path

Activity	ES	EF	LS	LF	Float, days
3-9	7	17	11	21	4
9-11	17	22	21	26	4
11-12	22	25	26	29	4
12-13	25	30	29	34	4

TABLE 8.5.3 Total Float Path Duration

Activity	Duration, days
3-9	10
9-11	5
11-12	3
12-13	5
Total	23

The available time span from event 3 to event 13 (27 days) less the total time for the activities in this chain (23 days) is 4 days float. This is another illustration of the shared aspect of float.

## 8.6. Free Float

The originators of the critical path method defined a variety of floats, including total float, free float, and independent float. The measure of float previously described is known as “total float.” It is both the most widely used version and the most practical one. Of the three types originally defined, only two appeared to have any practical use: total float and free float.

Free float is defined as that which, if used, will not delay the early start of a succeeding activity. The definition appears to offer a very useful identification. The formula, compared with the total float formula, is as follows:

$$\boxed{j} - \boxed{i} - D = \text{total float} = LT_j - ET_i - D = LF - EF = LS - ES$$

$$\boxed{j} - \boxed{i} - D = \text{free float} = ET_j - ET_i - D = EES_{(\text{succ})} - ES - D \\ = EES_{(\text{succ})} - EF$$

Looking past the formula, though, free float loses its luster. As an example, take Figure 8.6.1, which is part of the initial John Doe network between event 3 and event 13. All these activities have total float, however, as a string of activities emerges from a junction event, such as event 3, the early start for all activities has been controlled by the selection of the longest of all paths leading into that junction event.

In this example, the critical path from event 0 to event 3 determined that the early start time is 7. For a string of more than one activities, such as 3–9 or 3–10, in which the early finish for the  $j$  event is determined only by the early start figure coming out of the junction point, the formula necessarily produces a free float of 0. It is only when the string of activities joins another junction event, at which a new early start figure is determined by the longest path leading into the new juncture, that the free float formula produces a non-zero number. This number is produced because one or more other paths coming into the junction point establish an early start for that key junction, which is greater than the early finish time of the series of activities under a study.

Free float is really a comparative value of floats in parallel paths. All the activities shown in Figure 8.6.1 have float, and the lowest float value is 4. Thus the free float values are 0 for the lowest relative float path (3–9–11–12–13). However, the free float is also 0 on the activity

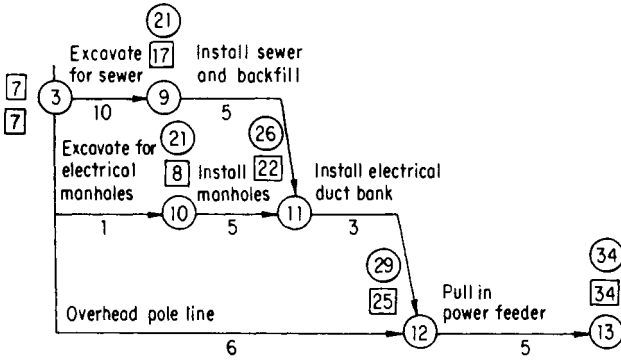

Network event time calculations

Float calculations

Activity	Duration	Free float [E <sub>i</sub> - E <sub>j</sub> - 0]	Total float [E <sub>j</sub> - E <sub>i</sub> - 0]
3-9	10	[17-7-10] = 0	[21-7-10] = 4
9-11	5	[22-17-5] = 0	[26-17-5] = 4
3-10	1	[8-7-1] = 0	[21-7-1] = 13
10-11	5	[22-8-5] = 9	[26-8-5] = 13
11-12	3	[25-22-3] = 0	[29-22-3] = 4
3-12	6	[25-7-6] = 12	[29-7-6] = 16
12-13	5	[34-25-5] = 4	[34-25-5] = 4

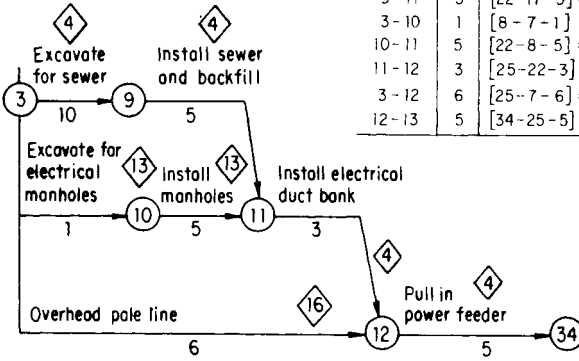

Plot of total float values

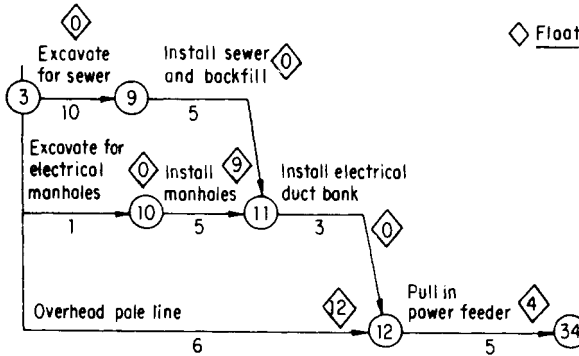

Plot of free float values

Figure 8.6.1 Free float compared with total float: John Doe project.

3–10, which initiates the path 3–10–11, but it is 9 on the second activity because that is the last activity before a junction point.

The free float for activity 3–12, which has only a single activity in the string, is dependent on the early event time at event 12, which is established by the longer path 3–9–11–12 and, therefore, has a non-zero free float value. Free float is, therefore, deceptive because it shows a zero value for the parallel path with the lowest total float and also for any series of initial activities with early finishes that are not dependent on another chain. In some cases, the free float will equal the total float value where a path of non-critical activities re-enter a critical path string of activities. It may be less than total float, but it will never be more. Many programs still print out free float even though it is virtually never used. Other times, the program may continue to generate free float but the printout is blanked off by request.

When a column listing, Free Float, is included in a report, it is usually to note the amount of slippage permitted for delivery of fabricated materials that will not delay the early start of a subsequent erection or installation activity. But as noted previously, the calculated attribute is misleading as project personnel would desire similar information relating to the submittal, approval, and fabrication activities preceding the delivery activity. Instead, each of these preceding activities has a calculated free float of zero because their successors each have but one predecessor. Non-zero free float can only exist where an activity has more than one predecessor. It is the consequence of the merger of multiple paths of logic.

Two solutions to this problem are theoretically possible. Each involves assignment of a new attribute “path free float” to calculate, record, and report the latest dates on which an activity must start or finish if not to delay the earliest start of its successor(s.) The first is to have a code field reserved for designation of an activity as being the last of a string or sub-path leading to the “not to be delayed” activity. The second requires coding of the restraints (such as in a RDM system) leading to a merger of paths with calculation of the “path free float,” (or “junior float” as suggested in Chapter 2), whenever the restraint is of a specified (such as “deliver material”) type. Each method has its benefits and limitations, but the programming for each is relatively simple once there is sufficient demand in the marketplace.

### **8.7. Independent Float**

Independent float represents the attribute that an activity start or finish may be deferred without reducing the ability or float of any other activity’s start or finish to be deferred. To some extent, it is a more reliable indicator of when an activity is “needed” than free float. However,

as noted previously, when independent float was first defined, there did not appear a practical use for its calculation. Thus, as early computers were rather limited in power, it was not calculated in most situations and became a largely ignored artifact.

As computers became more powerful, the ability to level (stay below a set level) and smooth (minimize cycles of increasing and decreasing—or hiring and firing) use of resources became part of commercially available software. It became clear that in deciding which activity may be deferred, the already calculated free float attribute was useful. However, it appears that since independent float was not already calculated, the programmers adding the leveling and smoothing modules to the CPM software did not see the benefit of modifying the basic calculation modules to provide this attribute.

The formula for independent float also is a bit more complex and this may have put off the programming team. The formula is expressed as:

$$IF = \text{independent float} = EES_{(succ)} - LLF_{(pred)} - Dur$$

or the earliest of the early starts of all successors to an activity, minus the latest late finish of all predecessors to an activity, minus the duration of the activity. In Figure 8.7.1, the only activity to have independent float would be Activity “H.” The early start of “I” is 40. The late finish of “A” is 10. The duration of “H” is 10. The independent float =  $IF = 40 - 10 - 10 = 20$ . Compare this to Activity “G.”  $ES_{(I)} - LF_{(F)} - DUR_{(G)} = 40 - 30 - 10 = 0$ .

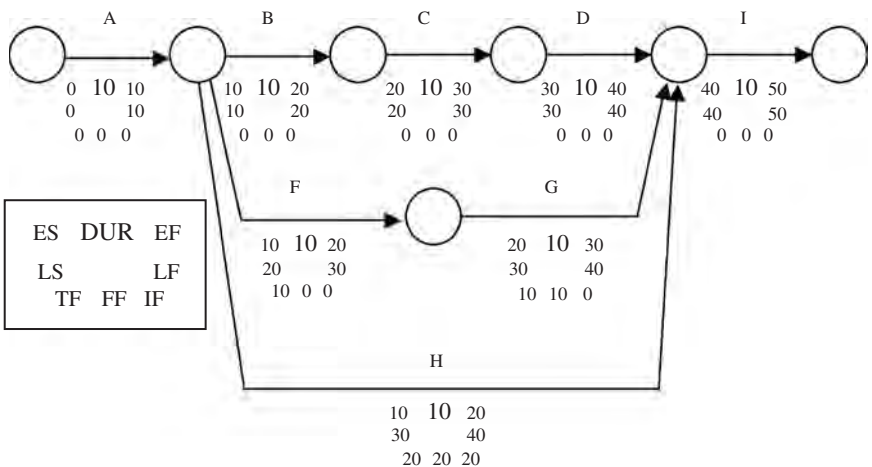

Figure 8.7.1 Comparison of total float, free float, and independent float.

### 8.8. Time Scale Network

Figure 8.4.1, which demonstrates the critical activities, is the front end of a plot of the site work activities according to a time scale. If all the activities are plotted according to a time scale, the result is a graphical calculation of the network. (See Figure 8.8.1 for a time scale network of the John Doe project.) The activities are plotted in solid line to scale, with dashed-line connections to the event connection point. The dotted section is equal to the float in the chain of activities.

In plotting a network in which a computer or manual calculation has not been made, all activities are plotted by early start. Float will appear as dotted lines following the last activity in a series. If the network has been calculated, either manually or by computer, the preferred plot is by late start. The early start plot gives the CPM calculation, but experience confirms that activities do not start at the earliest point. Accordingly, an early start plot will be patently incorrect at each update. And if the network is to be updated correctly, each review will require a time-consuming redraft. On the other hand, if the graphical plot is to a late start, redrafting will not be required unless a major change in approach is decided on. In fact, if the sequence and durations go unchanged, the graphical network (late start plot) can be made to remain correct by a simple shift of the horizontal time scale.

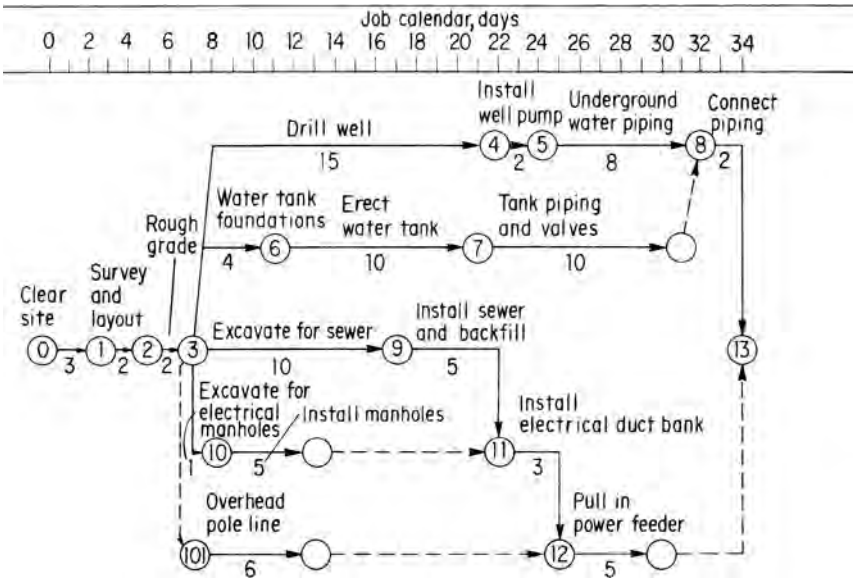

Figure 8.8.1 Time scale network: John Doe project. (Plotted to early times).

## 8.9. Computation Time

How long it takes to compute a network manually and how large a network can be hand-computed cannot be specifically answered because network characteristics vary. Why would anyone care to do these calculations by hand rather than by computer? Beyond the simple answer that a Scheduler or engineer should understand what is going on inside that black box, there are often situations in the field where a small network is developed for immediate use and there is not time to go back to the office. This provides the overall time frame, and often picks up obvious errors.

The John Doe networks have about 130 activities. (A rule of thumb: The number of activities in a network is about equal to 1.6 times the number of events.) You can hand-compute the John Doe networks faster than you could input data to a computer for one run. However, if you expect several runs, the computer is much faster. If a computer is available, you should probably use it for networks above 100 to 200 activities if you expect reruns. If you have a complex, tightly interconnected network, a network of 100 or 200 activities can be tedious to compute. Thus, there is no specific limit to hand computation. You will have to set your own limits based upon your own situation and experience.

## 8.10. Writing Your Own CPM Software

The basic rules for activity time computations are relatively simple, so simple that they are intuitively obvious. To reiterate the rules:

1. The *early start (ES)* of the first activity is defined as zero.
2. The *early finish (EF)* of any activity is the  $ES + \text{duration } (D)$ .
3. The  $ES$  of any other activity is the *latest* of the  $EF$ s of all predecessors to that activity.
4. The *late finish (LF)* of the last activity is defined as equal to the  $EF$ .
5. The *late start (LS)* of any activity is the  $LF - D$ .
6. The  $LF$  of any other activity is the *earliest* of the  $LS$ s of all successors to that activity.
7. The *total float (TF)* of any activity is equal to the  $LS - ES$ , which is also equal to the  $LF - EF$ .

As an aid, refer to the following simple diagram of a CPM activity:

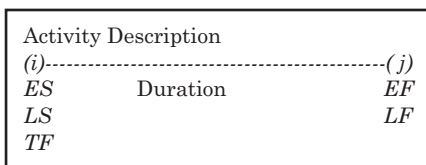

Armed with these equations and some common sense, you can write a fairly sophisticated software program in whatever language you prefer for solving activity time computations.

First, identify the first activity in the network. Intuitively, you can do this by looking at the left-hand side of the pure logic diagram. However, if our diagram was our first draft, it may look more like Figures 5.1.1 or 5.1.2 or perhaps an even rougher diagram where the first activity is not clearly at the left. (It is interesting to note that Figures 5.0.1, 5.1.1, and 5.1.2 could not be solved using the matrix method discussed in this chapter or by early computer systems that required a single starting activity.) So how do we know which is (or are) the first activity in a network?

Look at the preceding diagram. Note that the ( $j$ ) node for each activity will be the ( $i$ ) node for the next activity. Similarly, the ( $i$ ) node of each activity is the ( $j$ ) node of another activity—except for those activities that do not have a predecessor—first activities. So for the first module of your program, you can assign an  $ES$  of zero to all first activities of a logic network. After assigning an  $ES$  of zero, compute the  $EF$  as the  $ES$  + duration ( $D$ ). You can then compute the  $ES$ s of other activities.

Look at the next activity in the list of activities (or the next record in a database) without concern for the order in which the activities are listed. Note the ( $i$ ) node and search for the activities having the same node number in their ( $j$ ) column (see Figure 8.10.1.). Note its  $EF$ . If it has been previously calculated, store this number and look for others. You can then assign the latest  $EF$  as the  $ES$  of your target activity, and compute the  $EF$  as the  $ES$  +  $D$  of that activity.

If the  $EF$  has not yet been defined, then ask, “Which is larger, any known number or undefined?” The answer is always “undefined,” which is the entry you assign to the  $ES$  of your target activity. Complete each activity in your list until you reach the end of your list, then return to the top of your list and repeat the process for all activities with an “undefined”  $ES$ . Eventually, you will have determined an  $ES$  and calculated an  $EF$  for each activity in your list. This concludes the forward pass of your intuitive program.

The first step in the backward pass procedure is to determine the last activity (or multiple last activities, which is discussed in later chapters). Simply, the last activity is that in which the ( $j$ ) node does not appear as an ( $i$ ) node in a list of activities. The remainder of the program is left as an exercise for the student.

**CLASS EXERCISE:** Write, compile, and execute a CPM program for the first 17 activities of the John Doe project as depicted in Figure 18.5.1



PRED	SUCC	ACTIVITY DESCRIPTION	ORIG DUR	ED	EF	LS	LF	TF
1	2	SURVEY AND LAYOUT	2	0	2			
2	3	ROUGH GRADE	2	2	4			
3	4	DRILL WELL	15	4	19			
3	6	WATER TANK FOUNDATIONS	4	4	8			
3	9	EXCAVATE FOR SEWER	10	4	14			
3	10	EXCAVATE ELECTRIC MANHOLES	1	4	5			
3	12	OVERHEAD POLE LINE	6	4	10			
4	5	INSTALL WELL PUMP	2					
5	8	UNDERGROUND WATER PIPING	8					
6	7	ERECT WATER TANK	10					
7	8	TANK PIPING & VALVES	10					
8	13	CONNECT WATER PIPING	2					
9	11	INSTALL SEWER AND BACKFILL	5					
10	11	INSTALL ELECTRICAL MANHOLES	5					
11	12	INSTALL ELECTRICAL DUCT BANK	3					
12	13	PULL IN FEEDER	5					
13	14	BUILDING LAYOUT	1					
14	15	DRIVE AND POUR PILES	10					
14	23	EXCAVATE FOR OFFICE BUILDING	3					
15	16	EXCAVATE PLANT WAREHOUSE	5					
16	17	POUR PILE CAPS P-W	5					
17	18	FORM AND POUR GRADE BEAMS P-W	10					
18	19	BACKFILL AND COMPACT P-W	3					
18	21	FORM AND POUR RAILROAD LOADING DOCK P-W	5					
18	22	FORM AND POUR TRUCK LOADING DOCK P-W	5					
19	20	UNDERSLAB PLUMBING P-W	5					
20	22	UNDERSLAB CONDUIT P-W	5					
21	22		0					
22	29	FORM AND POUR SLABS P-W	10					
23	24	SPREAD FOOTINGS OFFICE	4					
24	25	FORM AND POUR GRADE BEAMS OFFICE	6					
25	26	BACKFILL AND COMPACT OFFICE	1					
26	27	UNDERSLAB PLUMBING OFFICE	3					
27	28	UNDERSLAB CONDUIT OFFICE	3					
28	29	FORM AND POUR SLABS OFFICE	3					
29	30	ERECT STRUCTURAL STEEL P-W	10					
30	31	PLUMB AND BOLT STEEL P-W	5					
31	32	ERECT CRANEWAY AND CRANE P-W	5					
31	33	ERECT MONORAIL TRACK P-W	3					
32	33		0					
33	34	ERECT BAR JOISTS P-W	3					
34	35	ERECT ROOF PLANKS P-W	3					
35	36	ERECT SIDING P-W	10					
35	37	BUILT-UP ROOFING P-W	5					
36	37		0					
37	80	PERIMETER FENCE	10					
37	90	PAVE PARKING AREA	5					
37	91	GRADE AND BALLAST RAILROAD SIDING	5					
37	92	ACCESS ROAD	10					
37	93	AREA LIGHTING	20					
38	43	INSTALL POWER CONDUIT P-W	20					
39	42	FRAME CEILING P-W	5					
40	47	TEST PIPING SYSTEMS P-W	10					
41	47	PREOPERATIONAL CHECK	5					
42	44	DRYWALL PARTITIONS P-W	10					
43	49	INSTALL BRANCH CONDUIT P-W	15					
44	45		0					
44	46		0					
44	48	CERAMIC TILE	10					
44	58	HANG INTERIOR DOORS P-W	10					
45	51	ROOM OUTLETS P-W	5					

PROJECT: O'BRIEN KREITZBERG & ASSOC., INC. JOHN DOE PROJECT ADM VERSION COMPUTER SIMULATION SOLUTION OF CPM

CPM IN CONSTRUCTION MANAGEMENT - 5TH EDITION

Figure 8.10.1 Manual calculation of ED, EF, LS, LF, and TF by simulated computer method.

You can expand your program to include features of modern proprietary software. For example, you can assign a title or description to each activity based on its unique *i-j* designation. Similarly, you can assign a date to each time designation, even addressing weekends and holidays by skipping them in your conversion list.

The basic system is indeed very simple and can be easily improved upon. You can improve the ease of use, include additional features, or add the capability to select and sort activities for more informative reports and graphics.

### 8.11. Manual and Computer Solution for PDM with Durations Between Activities

The addition of non-traditional types of restraints (leads) and durations between activities (lags) can make the calculation more tedious, but it is still understandable. Figure 8.11.1 illustrates the additional inputs to calculation of the early finish during the forward pass, and the late start during the backward pass. Notice that since it is no longer guaranteed that  $EF = ES + D$ , nor that  $LS = LF - D$ , the calculation of total float changes and that it is possible that  $LS - ES = TF_{(Start)}$  is not equal to  $LF - EF = TF_{(Finish)}$ .

Figure 8.11.2 illustrates the new calculations required to determine the  $ES$  and  $EF$  attributes of the forward pass. The initial  $ES$  is still defined as zero (or DataDate during an update) but the  $EF$  is now the greater of  $ES + D$  or  $EF_{(pred)} + lag$  or  $ES_{(pred)} + lag$ . The  $ES$  of subsequent activities is now calculated as the greater of the latest early finish of all predecessors plus lags or preceding early starts plus lags.

Figure 8.11.3 illustrates the new calculations required to determine the  $LF$  and  $LS$  attributes of the backward pass. The final  $LF$  is still defined as equal to the  $EF$  but the  $LS$  is now the lesser of  $LF - D$  or  $LS_{(succ)} - lag$  or  $LF_{(succ)} - lag$ . The  $LF$  of preceding activities is now calculated as the lesser of the earliest late starts of all predecessors minus lags or succeeding late finishes minus lags.

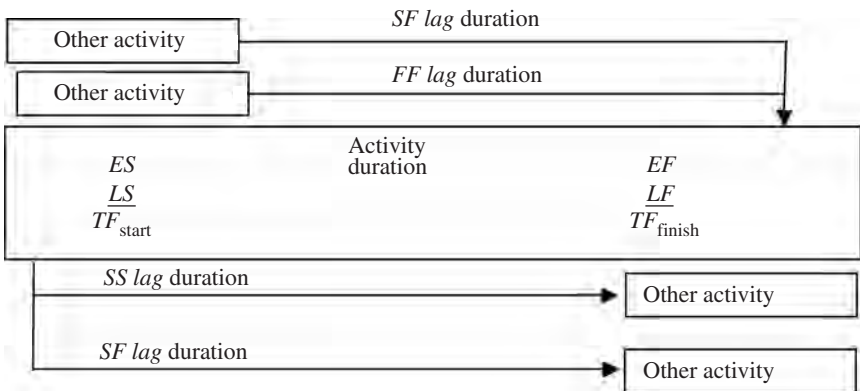
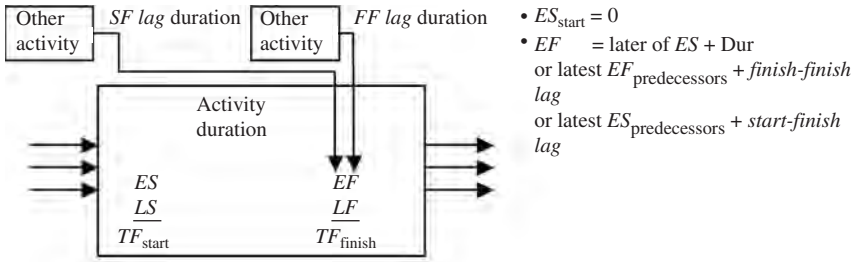
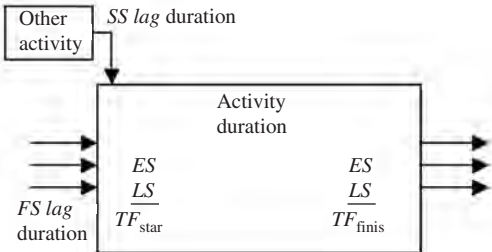

Figure 8.11.1 Additional Inputs to Early Start in PDM calculation.



- $ES_{start} = 0$
- $EF = \text{later of } ES + \text{Dur}$   
or latest  $EF_{predecessors} + \text{finish-finish lag}$   
or latest  $ES_{predecessors} + \text{start-finish lag}$



- $ES_{start} = 0$
- $ES = \text{later of latest } EF_{predecessors}$   
or latest  $EF_{predecessors} + \text{finish-start lag}$   
or latest  $ES_{predecessors} + \text{start-start lag}$

Figure 8.11.2 Forward pass.

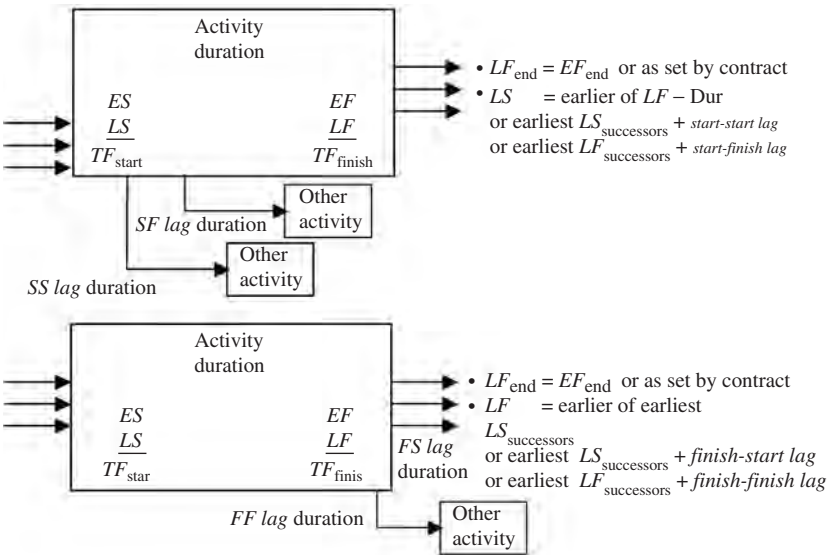

- $LF_{end} = EF_{end}$  or as set by contract
- $LS = \text{earlier of } LF - \text{Dur}$   
or earliest  $LS_{successors} + \text{start-start lag}$   
or earliest  $LF_{successors} + \text{start-finish lag}$

- $LF_{end} = EF_{end}$  or as set by contract
- $LF = \text{earlier of earliest } LS_{successors}$   
or earliest  $LS_{successors} + \text{finish-start lag}$   
or earliest  $LF_{successors} + \text{finish-finish lag}$

Figure 8.11.3 Backward pass.

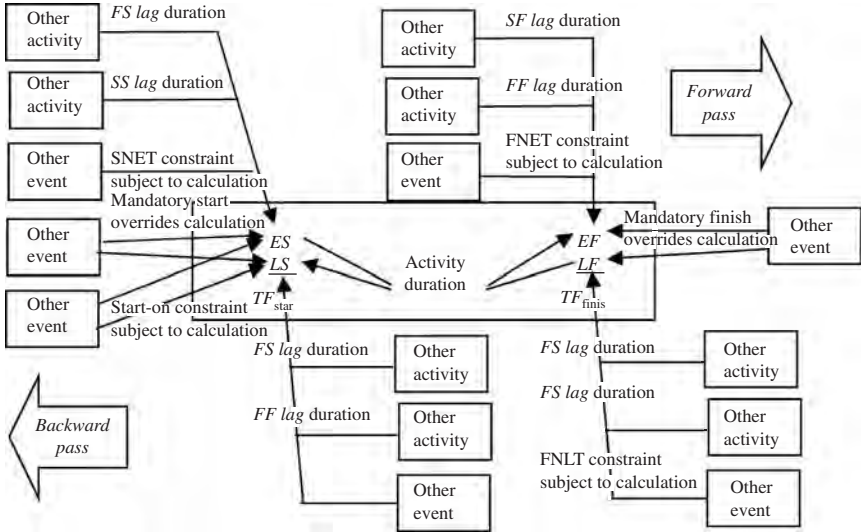

Figure 8.11.4 Additional calculations required to account for non-traditional restraints and constraints.

The problem only gets worse as we add in the additional calculations necessary to incorporate constraints that may override the logic of the CPM network as illustrated in Figure 8.11.4.

Solution of Figure 8.11.5 is left as an exercise for the student.

### 8.12. Summary

This chapter discussed the use of event times to compute activity times, specifically early start, early finish, late start, and late finish. The three rules for identifying a critical activity were started, and float time was defined.

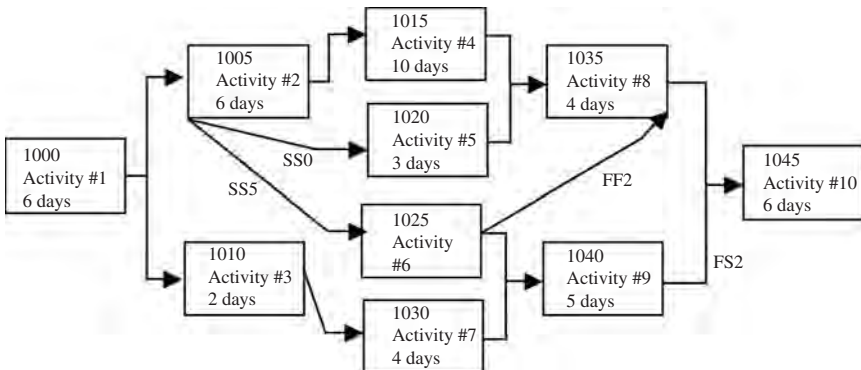

Figure 8.11.5 Sample network for student solution.

## Adding Complexity

The basic ADM model requires only three data fields: an  $i$  node, a  $j$  node, and a duration. As we saw in previous chapters, preparation of a computer program to perform the calculations of activity attributes for such a simple model is an easy exercise. To appreciate the multitude of possible misunderstandings that can be created, we examine some of the enhancements to the basic model.

### 9.1. Enhancements to the Basic System

Many features have been added to the basic concept of CPM. Some of these enhancements include the following.

- Separate tracking of original duration versus remaining duration
- Input or calculation of percent complete
- Defined subtasks and checkoff updating
- Reporting early starts/late starts/finishes with calendar dates
- Use of multiple calendars
- Multiple starting and ending activities
- Restraints and constraints to activities extraneous to the pure logic network
- Negative float and modifying the definition of criticality
- Continuous and interruptible performance
- Assigning actual start and finish dates to activities
- Choice of algorithm for work performed out-of-sequence of retained logic versus progress override

- Events and milestones
- Hammocks and summary network logic
- Association of user-defined code fields to activities
- Association of resources to activities
- Association of costs to activities
- Driving resources
- Multi-project scheduling
- Hierarchical coding structures
- Using the precedence diagramming method (PDM)
- Resource leveling and smoothing
- PERT, SPERT, and GERT

## **9.2. Original versus Remaining Durations**

Creation of separate data fields for original and remaining duration may seem trivial. However, in performing updates to the network, it is important to remember that you should only update the remaining duration of activities *that have actually started*.

If new information leads you to desire to change the duration of an activity not yet started, such a change is a revision to the network rather than an update of the existing schedule. Thus, since no work has yet begun, the duration to be changed would be the original duration. As we have discussed, the mixing of information based upon observations (updates) and hopes and expectations (revisions) can dilute the value of the resulting calculations as a tool of analysis for the project. Another problem that occurs when changing the remaining duration of an activity not yet started is an erroneous report of progress.

But what remaining duration should we use if the activity is started and then work is to be suspended for a period of time? One school of thought suggests increasing the remaining duration to cover both the anticipated period of inactivity plus the remaining duration of actual work. Notice that the definition of remaining duration now is remaining duration plus-something-else, linguistically a poor definition. A better method to handle such a situation is to report a remaining duration of anticipated work days only, and subject the remaining portion of the activity to a constraint. This method recognizes that your statement that work remaining will be deferred until a future date is a *revision* to the logic.

## **9.3. Percent Complete**

If a new field is added for percent complete, the first issue is to determine percent complete of *what*. To illustrate, different personnel may

report differing percents complete for the same activity. The project cost accountant may be interested in the percent of budget expended or percent of earned value for the activity. For installation of a pump, an activity which can take 5 days, 90 percent of the cost is both expended and earned when the pump is rough rigged and set in the first day. Final positioning, milling, and connections may take another 4 days, and 90 percent of the labor, so that from a foreman's viewpoint, only 10 percent of the activity is complete. From the Scheduler's viewpoint, 4 of 5 days remain, so 20 percent of the activity is complete.

From the owner's viewpoint, the installation will not be 100 percent complete until the pump is successfully tested. Then again, from the Scheduler's viewpoint, the activity will be 100 percent complete when its successors are capable of starting.

If after the pump has been rough rigged a problem is encountered, requiring reporting the remaining duration as 7 days, will we report negative percent complete, 20 percent complete, or 90 percent complete? Most software programs will report 0 percent complete.

If an actual start date field has been added and an actual start reported for this activity (see more on problems on Actuals later in this chapter), and for an activity of original duration of 10 days, 10 days have passed to reach the 50 percent complete point, is the remaining duration to be calculated as the remaining 50 percent of the original duration (that is, 5 days remaining) or based upon the performance to date (that is, another 10 days)?

#### 9.4. Defined Subtasks and Check-off Updating

Part of the definition of an activity is that it is a set of instructions given to an entity that may perform it without further intervention. However, the performance of the activity may involve several discrete tasks. These tasks may be performed in a specified order, or one of several specified orders or in any order. For example, in rotating the tires of an automobile, removal of the nuts holding each wheel in place may be performed in any order but must be replaced in one of several specified orders. Rarely need the master mechanic specify an exact order to an assistant. A pre-flight checklist is another example. However, although a specified order of these tasks may not be required, some means to check off and record that each step has been taken is desired.

Several methods can be used to implement such additional functionality. The description of the activity may refer the user of the CPM printout to a separate check-off list. Or the activity description may be annotated on the printout by means of logs or notes, as depicted in Figures 9.4.1, 2 and 3. Or a true, interactive check-off system may be implemented, as by Primavera's P3e/c's Step function as depicted in Figure 9.4.4.

Log	
INSTALL UTILITIES - STA 4+07 TO 12+75	
Mask	
1	<input type="checkbox"/> GAS 4+50 TO 10+50 - 12 LATERALS & 2 STREETS
2	<input type="checkbox"/> STORM 4+07 TO 4+55 & 10+05 TO 10+50
3	<input type="checkbox"/> UDRAIN 4+17.25 TO 9+07.06 & 10+35.50 TO 12+68.50

Figure 9.4.1 Primavera P3 Logs note detail of utility installation activity under direction of one foreman.

Activity ID	Activity Description	Orig Dur	Rem Dur	Cal ID	Early Start	Early Finish	Total Float	Actual Start	Rem Dur	% Comp	Actual Finish
6004	Construct SR222 - Drain PPG -	25	5	1	21AUG03A	30JUL04	38	21AUG03	5	80	

Log	
Mask	
<input type="checkbox"/>	D1 to D2 450mm 16m 1M 1S
<input type="checkbox"/>	D2 to D4 450mm 120m 1S
<input type="checkbox"/>	xD3 to D4 450mm 15m 1M
<input type="checkbox"/>	xD4 to D7 450mm 84m 1M
<input type="checkbox"/>	xD3 to D16 450mm 2m 1M
<input type="checkbox"/>	xD5 to D6 450mm 20m 1S
<input type="checkbox"/>	xD6 to D7 450mm 15m 1M
<input type="checkbox"/>	D7 to D8 450mm 14m 1S
<input type="checkbox"/>	xD8 to D14 600mm 99m 1S
<input type="checkbox"/>	xD14 to D15 600mm 7m 1EndS
<input type="checkbox"/>	xD20 to D19 1050mm 72m 2EndW
<input type="checkbox"/>	xD14 to D13 450mm 23m
<input type="checkbox"/>	xD13 to D12 450mm 2m 1M
<input type="checkbox"/>	xD12 to D11 450mm 14m 1M
<input type="checkbox"/>	xD11 to D10 450mm 59m 1S
<input type="checkbox"/>	xD17 to D18 750mm 10m 1M

Figure 9.4.2 Primavera P3 Logs note individual bents of a drainage pipe. Each line is checked off as performed.

Activity ID	Activity Description	Orig Dur	Rem Dur	Cal ID	Early Start	Early Finish	Total Float	Actual Start	Rem Dur	% Comp	Actual Finish
6004	Construct SR222 - Drain PPG -	25	5	1	21AUG03A	30JUL04	38	21AUG03	5	80	

Figure 9.4.3 Primavera P3 Logs note individual bents of a drainage pipe. Each bent is checked off as performed.

Activity ID	Activity Name	Original Duration	Remaining Duration	Schedule %	Start	Finish	Resources
P111230	PLACE 2 SURFACE COURSE	4	4	0%	27-May-02	30-May-02	Foreman, Highway Laborer, Operator, etc.
P111235	REMOVE TEMP. CONSTR. BARRIER	1	1	0%	27-May-02	27-May-02	Equipment Operator, Truck Crane, etc.

Step Name	Complete	Step Weight	Weight Percent	Comp.
Place 1st Surface Course	0%	19.0	66.7	
Place 2nd Surface Course	0%	9.5	33.3	

Figure 9.4.4 Primavera P3e/c Steps allows user to specify tasks within the “Place 2 SURFACE COURSE” activity. User may check-off as work performed – 19mm 1st Course is 67 percent, 9.5mm 2nd Course is 33 percent of this 4-day activity.



The sole caveat is that defined subtasks or Steps cannot take the place of activities. Since there is no logic between the subtasks, much less logic that may transcend the group of subtasks within an activity (for example, deliver rebar to the rebar subtask of “Form/Rebar/Pour Wall” activity), this feature regresses scheduling back to a ToDo list. The sole danger created by the addition of “Steps” is not technical but psychological, that is, the user must use these to supplement the description of an activity and not to replace the proper use of activities and fall back to the use of a ToDo list.

### 9.5. Calendar versus Work Period Conventions

The original implementation of ADM, including *i* node, *j* node, and duration, works solely with numbers and not dates. Thus an activity may be reported to have an early start of Day 5 and early finish of Day 12. If for each of the calculated fields *ES*, *EF*, *LS* and *LF* we add fields to report such day numbers in date format, our output will be much more useful to the user. However, the use of dates does create new opportunities for misunderstanding.

Let us assume a 5-work day per week calendar with day ZERO being 01FEB99 (Figure 9.5.1):

Our first option is to assign a date to each day number (Figure 9.5.2). This assumes that each day entails 24 hours. Activity A would finish at 7:59 AM on 08FEB and Activity B would start at 8:00 AM on 08FEB. This can be misleading since, in the real world, we would probably finish Activity A at 4:00 PM on 05FEB, and a foreman reading the schedule might think that he or she had until 08FEB to complete Activity A.

Our second option is to assign two dates to each day number, one if the day number is an early (or late) start and one if the day number is an early (or late) finish. Here, we explicitly understand that the “day” ends at 4:00 PM, and that even with overtime, we will certainly finish before midnight.

FEBRUARY 1999							WORK DAYS																				
MON	TUE	WED	THU	FRI	SAT	SUN	MON	TUE	WED	THU	FRI	SAT	SUN														
1	2	3	4	5	6	7	0	1	2	3	4	-	-														
8	9	10	11	12	13	14	5	6	7	8	9	-	-														
15	16	17	18	19	20	21	10	11	12	13	14	-	-														
22	23	24	25	26	27	28	15	16	17	18	19	-	-														
Act A OD=5							Act B OD=7							Act C OD=1							Act D OD=2						
1-----2-----3-----4-----5																											
ES/EF	0			5			12			12			13			13			15								
option 1	01FEB			08FEB			08FEB			17FEB			17FEB			18FEB			18FEB			22FEB					
option 2	01FEB			05FEB			06FEB			16FEB			17FEB			17FEB			18FEB			19FEB					

Figure 9.5.1 Calendar days versus project days.

	Act A OD=5		Dummy OD=0		Act B OD=7		Act C OD=1		Act D OD=2	
	1-----2		2-----3		3-----4		4-----4		4-----5	
ES/EF	0	5	5	5	5	12	12	13	13	15
option 1	01FEB	08FEB	08FEB	08FEB	08FEB	17FEB	17FEB	18FEB	18FEB	22FEB
option 2	01FEB	05FEB	08FEB	05FEB	08FEB	16FEB	17FEB	17FEB	18FEB	19FEB

Figure 9.5.2 Problems with calendars. Option #1 work “ends” at 7:59 AM . Option #2 work “ends” at 4:00 PM.

This second option looks less likely to be misunderstood at first glance. The 1-day Activity C both starts and finishes on 17FEB. But what if Activity B is a logic restraint or milestone having zero duration?

Option 2 now causes confusion by listing the late start for Activity B as occurring *before* its early start. If the logic restraint (or “dummy”) spans a weekend, the late start may be reported several days earlier than the early start. Schedulers and users of the software know what is meant, but third parties think the software is flawed or worse. A third option was created by several software vendors, which reported the early (and late) finishes for logic restraints or milestones as equal to the early (or late) starts (Figure 9.5.3). This caused even more confusion for some users. At least one software vendor gave individual users the choice of options 1, 2 or 3 in the setup or configuration screen for the software. (Imagine the confusion when a data disk prepared by a contractor is run by the engineer using a different configuration choice.) At least one software vendor solved this dilemma by declaring that logic restraints or milestones, having no duration and thus being a point in time, will not report any value for an early (or late) finish. However, such logic restraints or milestones must be so declared, and an activity having zero duration, but not declared as a milestone, will default to option 1.

### 9.6. Multiple Calendars

In the real world, there are some activities which may only be performed during the work week, and if not finished on Friday, will continue on the following Monday. There are also some activities, such as the curing of concrete, which proceed equally well on weekends as on weekdays. In the original implementations this was addressed by accepting that the specific dates for any activity, being merely an estimate, may be off by several days.

	Act A OD=5		Dummy OD=0		Act B OD=7		Act C OD=1		Act D OD=2	
	1-----2		2-----3		3-----4		4-----4		4-----5	
ES/EF	0	5	5	5	5	12	12	13	13	15
option 3	01FEB	05FEB	08FEB	08FEB	08FEB	16FEB	17FEB	17FEB	18FEB	19FEB
option 4	01FEB	05FEB	08FEB	---	08FEB	16FEB	17FEB	17FEB	18FEB	19FEB

Figure 9.5.3 Problems with calendars. Option # 2 has different rules for duration > zero and duration = zero. Option #4 does not print finish dates for “dummy” activity logic restraints and milestones with duration = zero.

But as computers became more powerful and software more complex, the capability of multiple calendars was introduced, first into special high end software, then into the basic products marketed by the software companies. As expected, the use of multiple calendars creates several potential misunderstandings.

Our first problem is that multiple calendars create a dilemma in defining and calculating float. As we have learned,  $TF$  (total float) is equal to the  $LS$  (late start) of an activity minus its  $ES$  (early start). When we calculate Day 10 minus Day 5 we always get 5 days of float. But exactly how much is 10FEB99 minus 01FEB99?

Typically, the total float is reported in units from the same calendar as the original duration. Thus, if an activity performed on a 5 day per week calendar has an  $ES = 01FEB99$  and an  $LS = 08FEB99$ , the software will calculate  $TF = LS - ES = 5$  days. But if the same activity were performed on a 7 day per week calendar, the software will calculate  $TF = LS - ES = 7$  days. If requesting a report sorted by criticality, that is, by total float, the activity on the 7 day per week calendar will not be located in the proper position.

Even more disconcerting, in changing from a 5 day per week calendar to a 7 day per week calendar and back, especially if weekends are spanned, is that the software may calculate a critical path with varying amounts of float on the path (Figure 9.6.1.).

Since, mathematically, the use of multiple calendars degrades the value of calculations of the total float attribute, the use of them should be limited unless the progress of work during any one timeframe will vary significantly depending upon the calendar used. For example, if cure time for concrete is 1 week, the choice of 5 work days or 7 calendar days is irrelevant. However, if the cure time is 3 days, it will make a difference if the pour is made on a Monday or Friday. However, when one considers the tolerance or chance of error of the activities preceding and succeeding the cure activity, the error raised by leaving the cure on a 5 day or work calendar is probably insignificant compared to the loss of accuracy of the total float attribute. Thus the decision of which calendar to use for the cure activity is left to the sound discretion of the Scheduler or knowledgeable Engineer.

Yet another dimension of multiple calendar issues is when one activity may have multiple calendars. This issue occurs when separate calendars are assigned for activities and for individual resources. As an example, suppose an activity requires two limited resources, special equipment and an inspector. The activity may only be worked only on weekdays. The equipment is only available on the 1st through 10th of each month. The last day of the activity requires an inspector, who is never available on Fridays.

Different software vendors treat the use resource calendars in different fashions. Microsoft Project resource calendars work in conjunction with Activity calendars, thus a day off in either means no work.

FEBRUARY 1999							5 DAY/WEEK CAL WORK DAYS							7 DAY/WEEK CAL WORK DAYS						
MON	TUE	WED	THU	FRI	SAT	SUN	MON	TUE	WED	THU	FRI	SAT	SUN	MON	TUE	WED	THU	FRI	SAT	SUN
1	2	3	4	5	6	7	0	1	2	3	4	-	-	0	1	2	3	4	5	6
8	9	10	11	12	13	14	5	6	7	8	9	-	-	7	8	9	10	11	12	13
15	16	17	18	19	20	21	10	11	12	13	14	-	-	14	15	16	17	18	19	20
22	23	24	25	26	27	28	15	16	17	18	19	-	-	21	22	23	24	25	26	27

	Act A OD=3	Act B OD=3	Act C OD=4	Act D OD=2	Act E OD=2
	5-day-calendar	7-day-calendar	5-day-calendar	5-day-calendar	5-day-calendar
	Prepare fdn	Erect bridge	Form deck	Rebar deck	Pour deck
CAL 1 ES/EF	0 0+3	3 3	5 5 5+4	9 9 9+2	11 11 11+2
CAL 2 ES/EF	0	3 3	6 7	11 11	15 15
option 2	01FEB MON	03FEB WED	04FEB THU	06FEB SAT	08FEB MON
				11FEB THU	12FEB FRI
					15FEB MON
					16FEB TUE
					17FEB WED

CAL 1 LS/LF	1 4-3	4 4	5 5 9-4	9 9 11-2	11 11 13-2
CAL 2 LS/LF	1	4 4	7 7	11 11	15 15
option 2	02FEB TUE	04FEB THU	05FEB FRI	07FEB SUN	08FEB MON
				11FEB THU	12FEB FRI
					15FEB MON
					16FEB TUE
					17FEB WED

FLOAT	1	5-day	1	1	7-day	1	0	5-day	0	0	5-day	0	0	5-day	0
-------	---	-------	---	---	-------	---	---	-------	---	---	-------	---	---	-------	---

TOTAL FLOAT REPORT								
INODE	JNODE	RD	%	CAL	TITLE	ESTART	EFINISH	TF
3	4	4	0	1	FORM DECK	08FEB99	11FEB99	0
4	5	2	0	1	REBAR DECK	12FEB99	15FEB99	0
5	6	2	0	1	POUR DECK	16FEB99	17FEB99	0
1	2	3	0	1	PREPARE FOUNDATION	01FEB99	03FEB99	1
2	3	3	0	2	ERECT BRIDGE	04FEB99	06FEB99	1

ADJUSTED TOTAL FLOAT REPORT								
INODE	JNODE	RD	%	CAL	TITLE	ESTART	EFINISH	TF
1	2	3	0	1	PREPARE FOUNDATION	01FEB99	03FEB99	1
2	3	3	0	2	ERECT BRIDGE	04FEB99	06FEB99	1
3	4	4	0	1	FORM DECK	08FEB99	11FEB99	0
4	5	2	0	1	REBAR DECK	12FEB99	15FEB99	0
5	6	2	0	1	POUR DECK	16FEB99	17FEB99	0

Figure 9.6.1 Problems with multiple calendars. Confused reporting of total float.

Primavera resource calendars override the activity calendars, thus, an activity non-work day designated as a resource available day, is worked. Obviously, the user must read and understand the rules relating to calendar priority prior to use of this feature.

### 9.7. Multiple Starting and Ending Activities

The original CPM model, based upon the matrix mathematical approach and the limitations of the limited memory of 1950s computers, required that every network start with only one activity and end with only one activity. Several of the lower end software programs today still have this limitation. In addition to being a software limitation, this is usually good practice, as it precludes “dangling” activities. However, in many instances, there is a legitimate reason for having multiple starts and completions. An example of multiple starts is when two (or more) projects, with differing notice-to-proceed dates, are combined into one larger network to account for the interrelationships between the two projects. Obviously, this could be handled without special software by having a common starting activity named “START OF NETWORK” followed by the two specified

notice-to-proceed activities. A more difficult problem is when there are two (or more) end products to the network. An example of this situation is a building with commercial and residential rental space, each of which may be rented and occupied prior to completion of the other section, as shown in Figure 9.7.1. In this situation, it is advantageous to have two critical paths, one to completion of the commercial section as-soon-as-possible, and one to the residential section, as-soon-as-possible.

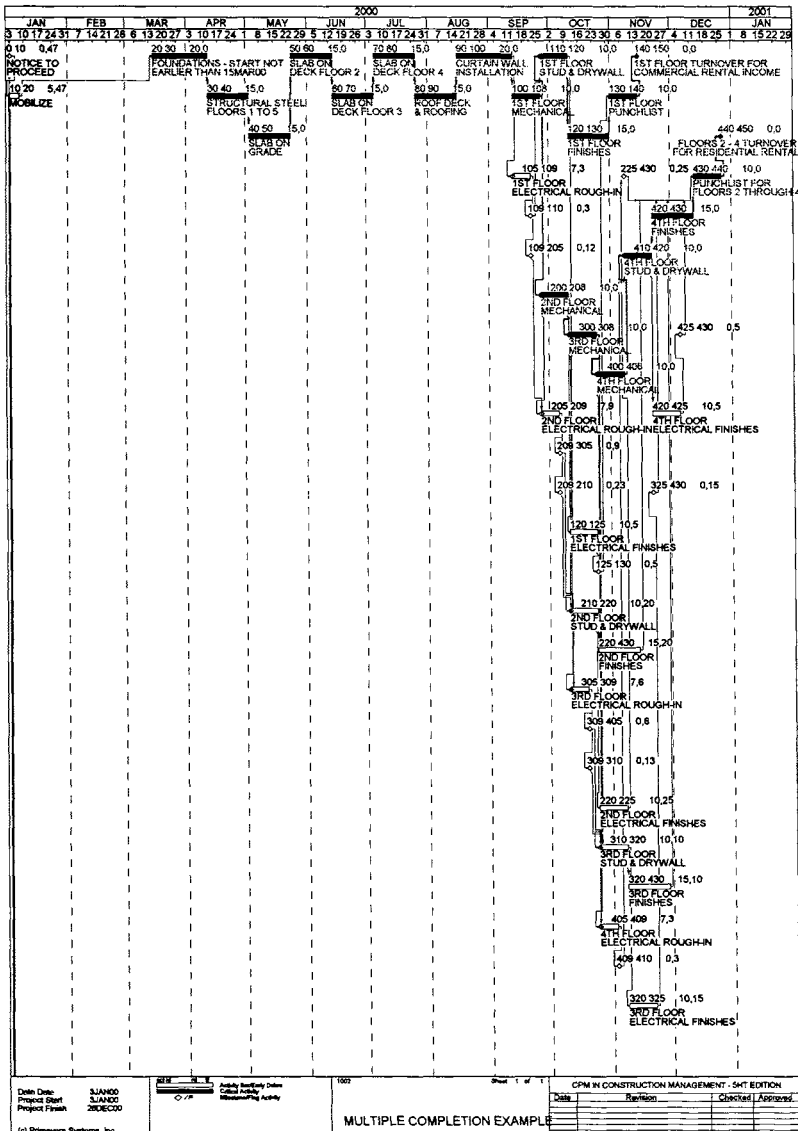

Figure 9.7.1 Multiple completions of project, both being calculated critical.

The original CPM model, and many programs even today, cannot handle this type of problem. (As noted in Chapter 8, a simple computer program that you can write can handle this problem.) A schedule prepared using a software package that can handle this problem, and subsequently loaded to a software package which cannot handle this problem, may either fail, yielding only an error message, or create a hidden internal logic restraint to the latest finish, resulting in one “true” critical path and the mistaken impression that work on the other section may be deferred without economic consequence.

### 9.8. Artificial Constraints to Dates

The ability to add artificial constraints (not based upon explicitly stated logic) is of great benefit to the user of CPM software. Such constraints should be divided into two classes, those that could be handled by the original CPM model with the addition of hidden internal logic restraints, and those that may require overriding of the basic precept of CPM, that each activity must be finished before its successor may begin.

If we want to say that an activity can not start until at least a specified date has been reached, we may provide that activity with a start-not-earlier-than (SNET) constraint. This could be stated in the traditional model by creating a logic restraint, from the starting activity to the activity in question, having a duration sufficient to delay the activity until (at least) that date. Of course, each update will require laborious recalculation of the remaining duration required to push to (at least) that date. Similarly, if we state a specific activity may finish-not-later-than (FNLT) a specified date, we could add a logic restraint to the ending activity with a sufficient duration to assure that a deadline is included in the network. (Note the problem of multiple ending activities, and that this solution, used by some software programs, creates the one “true” critical path problem there stated) (Figure 9.8.1).

On the other hand, constraints such as SNLT, FNET, mandatory-start-on, and mandatory-finish-on will override the basic premises of CPM and must be used with extreme caution.

First, we must agree on what the terms mean. The SNLT constraint may be interpreted as saying that an activity *may* start on the specified date, notwithstanding predecessor logic or unanticipated delays to *other* activities. Or, the SNLT constraint may be interpreted as saying that an activity *must* start on or before a specified date. The impact of the constraint is to the late start of the activity. In this case, the *forward pass* of the CPM calculations will not be impacted by this constraint, and the project will still show completion based upon the logic-based calculation. This second definition is used by Primavera Systems software.

Comparing, in Figure 9.8.2, Example #1 to Example #2, note that the SNLT constraint is highlighted only for the late start of Activity #3. However, both the late start and late finish of Activity #3 and all of its

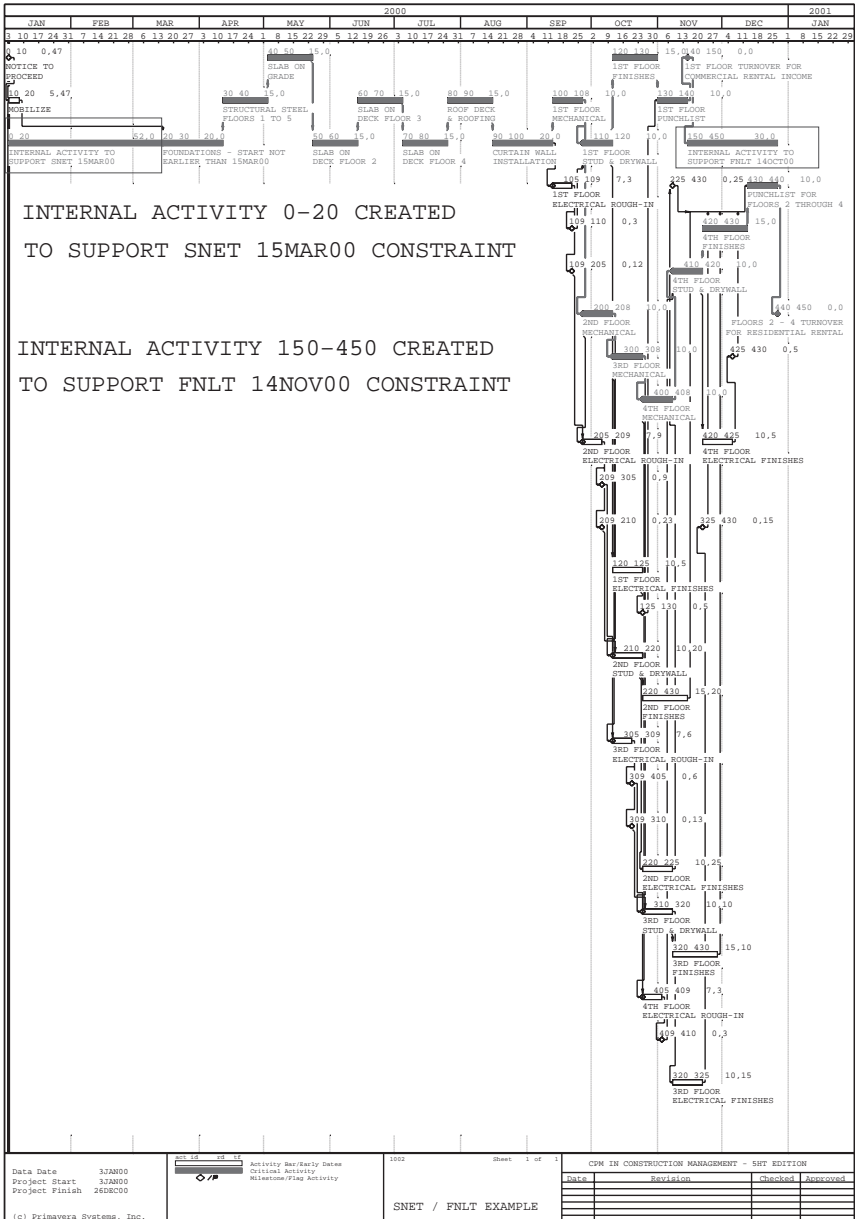

Figure 9.8.1 Internal logic for supporting SNET and FNLt constraints.

PRIMAVERA PROJECT PLANNER										
						START DATE		1FEB99	FIN DATE	25FEB99
						DATA DATE	1FEB99	PAGE NO.	1	
PRED	SUCC	ORIG DUR	REM DUR	%	ACTIVITY DESCRIPTION	EARLY START	EARLY FINISH	LATE START	LATE FINISH	TOTAL FLOAT
EXAMPLE #1 -- NO CONSTRAINTS										
1010	1015	5	5	0	ACTIVITY #1	1FEB99	5FEB99	1FEB99	5FEB99	0
1015	1020	5	5	0	ACTIVITY #2	6FEB99	10FEB99	6FEB99	10FEB99	0
1020	1025	5	5	0	ACTIVITY #3	11FEB99	15FEB99	11FEB99	15FEB99	0
1025	1030	5	5	0	ACTIVITY #4	16FEB99	20FEB99	16FEB99	20FEB99	0
1030	1035	5	5	0	ACTIVITY #5	21FEB99	25FEB99	21FEB99	25FEB99	0
EXAMPLE #2 -- SNLT CONSTRAINT OF 8FEB99 TO ACTIVITY 1020										
1010	1015	5	5	0	ACTIVITY #1	1FEB99	5FEB99	29JAN99	2FEB99	-3
1015	1020	5	5	0	ACTIVITY #2	6FEB99	10FEB99	3FEB99	7FEB99	-3
1020	1025	5	5	0	ACTIVITY #3	11FEB99	15FEB99	8FEB99*	12FEB99	-3
1025	1030	5	5	0	ACTIVITY #4	16FEB99	20FEB99	16FEB99	20FEB99	0
1030	1035	5	5	0	ACTIVITY #5	21FEB99	25FEB99	21FEB99	25FEB99	0
EXAMPLE #3 -- MANDATORY START CONSTRAINT OF 8FEB99 TO ACTIVITY 1030										
1010	1015	5	5	0	ACTIVITY #1	1FEB99	5FEB99	29JAN99	2FEB99	-3
1015	1020	5	5	0	ACTIVITY #2	6FEB99	10FEB99	3FEB99	7FEB99	-3
1020	1025	5	5	0	ACTIVITY #3	8FEB99*	12FEB99	8FEB99*	12FEB99	0
1025	1030	5	5	0	ACTIVITY #4	13FEB99	17FEB99	13FEB99	17FEB99	0
1030	1035	5	5	0	ACTIVITY #5	18FEB99	22FEB99	18FEB99	22FEB99	0
EXAMPLE #4 -- START ON CONSTRAINT OF 8FEB99 TO ACTIVITY 1020										
1010	1015	5	5	0	ACTIVITY #1	1FEB99	5FEB99	29JAN99	2FEB99	-3
1015	1020	5	5	0	ACTIVITY #2	6FEB99	10FEB99	3FEB99	7FEB99	-3
1020	1025	5	5	0	ACTIVITY #3	11FEB99*	15FEB99	8FEB99*	12FEB99	-3
1025	1030	5	5	0	ACTIVITY #4	16FEB99	20FEB99	16FEB99	20FEB99	0
1030	1035	5	5	0	ACTIVITY #5	21FEB99	25FEB99	21FEB99	25FEB99	0

Figure 9.8.2 Compare effect of constraints.

predecessors are impacted by this constraint. Note also the gap of 3 days between the late finish of Activity #3 and late start of Activity #4, in violation of the basic algorithm of CPM. Since the forward pass is not impacted by this constraint, project completion is calculated as the same time as if no constraint were used. However, an independent critical path is charted to this activity. In summary, the use of the SNLT constraint is treated exactly as the FNET constraint, creating an independent completion deadline (completion of all activities required for the start of this activity), but not impacting the mandated completion date for other activities or for the project.

Primavera recognizes the other definition noted previously under the designation of a mandatory start. Comparing, in Figure 9.8.2, Example #1 to Example #3, note that here both the early start and late start of Activity #3 are highlighted as set to the constrained date of 8FEB99. Here, the CPM calculated completion of 25FEB99 has been overridden, and a newly calculated completion date of 22FEB99 was calculated based upon Activity #3 starting on 08FEB99. Although Activity #3's early and late starts are highlighted in the tabular report, and activities precedent to Activity #3 are noted as having negative float, the assumption stated, that Activity #3 will start on 08FEB99, is accepted and used in all other calculations.

Analogous definitions and modification to basic CPM theory applies to the use of FNET and mandatory finish constraints. Here, the impact of the FNET constraint is to the early finish, isolating such activity as an independently starting activity for purposes of float calculation, but not altering the project length. Similarly, the mandatory finish constraint will impact all successors to the constrained activity and push the project completion date back as if a SNET constraint had been used.



**CLASS EXERCISE:** Modify your CPM computer program prepared in Chapter 8 to permit the use of SNET and FNLТ constraints. What additional modifications are required for SNLT, FNET, and mandatory start and finish activities?

## 9.9. Artificial Constraints to Algorithms

Although the constraints noted previously plug in a specific date to override what would otherwise be calculated by the standard CPM algorithm, other constraints accomplish the same end by substituting a date calculated during the backward pass with one calculated during the forward pass. Two such constraints are the zero total float (ZTF) and zero free float (ZFF.) The ZTF constraint does exactly what it sounds like; it substitutes the  $LF$  date calculated during the backward pass with the  $EF$  date calculated during the forward pass. Since the  $LF$  now equals the  $EF$ ,  $LF - EF = TF = 0$ . Thus a new additional critical path will be calculated from this point back to the start of the network. This feature is often useful when there is a commercial reason for completing an interim milestone as soon as possible (such as the commercial space in a mixed residential and commercial building) without setting a specific contractual deadline.

The ZFF constraint may be used to plan to delay an activity until the succeeding activity (which may have more than one predecessor) is ready to start. An example would be for delivery of equipment that is to be placed upon a new foundation. It may be desirable to not plan the delivery until the date that the completion of the foundation is expected. Note that if the foundation is completed early, some advantage may be lost by the use of ZFF. The revised algorithm for the zero free float constraint substitutes the  $EF$  and  $ES$  calculated during the forward pass with the  $LF$  and  $LS$  calculated during the backward pass. Since the forward pass has been completed by the time the backward pass is being made, the impact of these substitutions will affect only the one activity having the ZFF constraint, unlike the ZTF constraint, which also impacts all activities preceding the constrained activity.

## 9.10. Negative Float

Once we permit an activity, or even a project, to have a constraint to its completion date, we alter one of the basic theory rules of CPM, namely that the late finish of the last activity is equal to the early finish of the last activity (reflecting the desire to complete as early as possible.) If the FNLТ constraint is earlier than the calculated  $LF$  of an activity, then the activity *must* be completed earlier than it *may* be completed and the calculation of  $TF$  will be a negative number.

There are two ways of looking at the question of criticality for a schedule that has negative float. The first is that all activities having negative float must be expedited to bring the project back on schedule. The second is that only the most negative activities now constitute the critical path. This question leads to the more general problem stated in the next section.

### **9.11. Definition of Criticality**

The classic definition of critical, as on the critical path, is that total float equals zero. Two caveats to this definition are required due to extensions of traditional CPM. The first is when a designated completion date is specified (for example, by a FNLTL) and such a constraint creates negative float, a question arises as to whether all activities having total float less than or equal to zero are critical, or only those having the maximum negative float.

A subspecies of this problem may occur when a specified FNLTL completion date is beyond the calculated completion date. In this case, various computer programs may either use the earlier of the calculated or FNLTL date, or treat the FNLTL date as a mandated completion date. In the first case, the total float along the critical path will be calculated as zero. In the second case, the total float along the critical path will be a positive number.

As an example, Primavera Project Planner software allows two means to designate a FNLTL deadline for a project. In the opening or OVERVIEW screen, a field exists for noting the FNLTL deadline (Figure 9.11.1). In addition, the specified activities at the end of the network may be constrained by a FNLTL deadline (Figure 9.11.2). In the first case, if the FNLTL field is used on the OVERVIEW screen (whether or not such information is duplicated for the ending activity on the network), the software will calculate a positive total float for activities on the critical path. If the FNLTL field in the OVERVIEW screen is left blank, but a FNLTL constraint is entered for the ending activity in the network, the software will calculate a total float of zero for activities on the critical path.

The second caveat to the traditional definition of criticality is based upon experience. Considering that the original duration of each of the activities in a network is merely an educated estimate, and considering that a project may last several months or years, many practitioners believe that it is misleading to designate the activities having zero float as being “critical” for the purposes of highlighting, but ignoring those activities having one or 2, 5, or even 10 days of float.

In a tabular printout, this problem may be solved by appropriate use of filters (selections) and sorts. For example, preparation of a critical activity report may involve a filter permitting only activities with a

**Project Overview**

Project directory: d:\98p360\p3files

Project group/ Project name: DOE0

Project ID: Number/Version: Initial 05JUN00

Project title: JOHN DOE PROJECT PDM VERSION

Company name: O'BRIEN KREITZBERG & ASSOC., INC.

Access: Read Write      Decimal places: 2

Planning unit: Day      Activity count: 155

Project start: 05JUN00

Data date: 05JUN00      Project must finish by: 03APR01

Early finish: 03APR01

Exclusive

Targets:

Target	Number/Version	Data Date
1		
2		

Figure 9.11.1 FNLTL box, if used, will set this date as LF of project.

**Constraints**

Early constraint

Start

Finish

Late constraint

Start

Finish

    03APR01

Start on

Mandatory

Start

Finish

Expected finish

Float constraint

Zero total float

Zero free float

Leveling: Normal

Figure 9.11.2 FNLTL box, if used, will set earlier of this date or calculated LF as the LF of this activity.

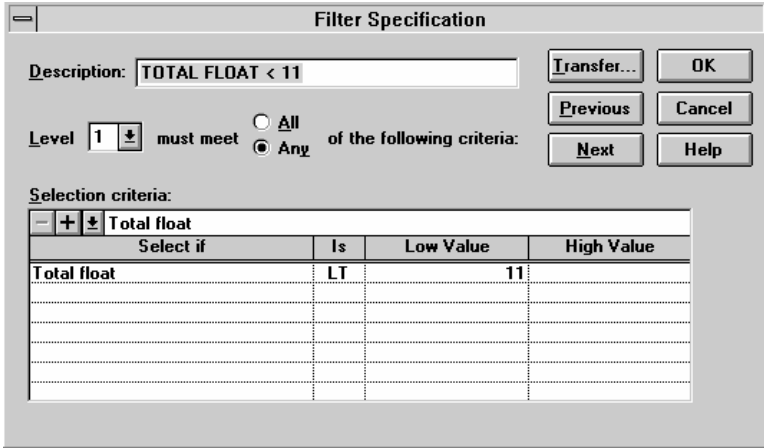

Figure 9.11.3 Filter defining “critical” as all activities with less than 11 days total float.

total float less than 11 days, then, sorted by early start (Figures 9.11.3, 4 and 5).

In a graphical representation, where the critical path may be highlighted (for example in another color or solid versus hollow bar), a special software switch or dialog box is required to designate criticality (Figures 9.11.6, 7 and 8).

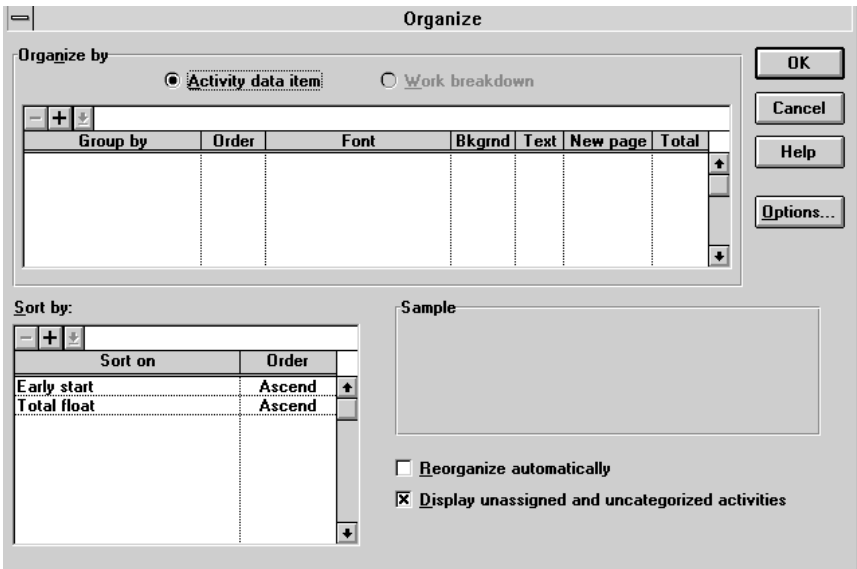

Figure 9.11.4 Sort instruction to list by early start, then by most critical for each date.

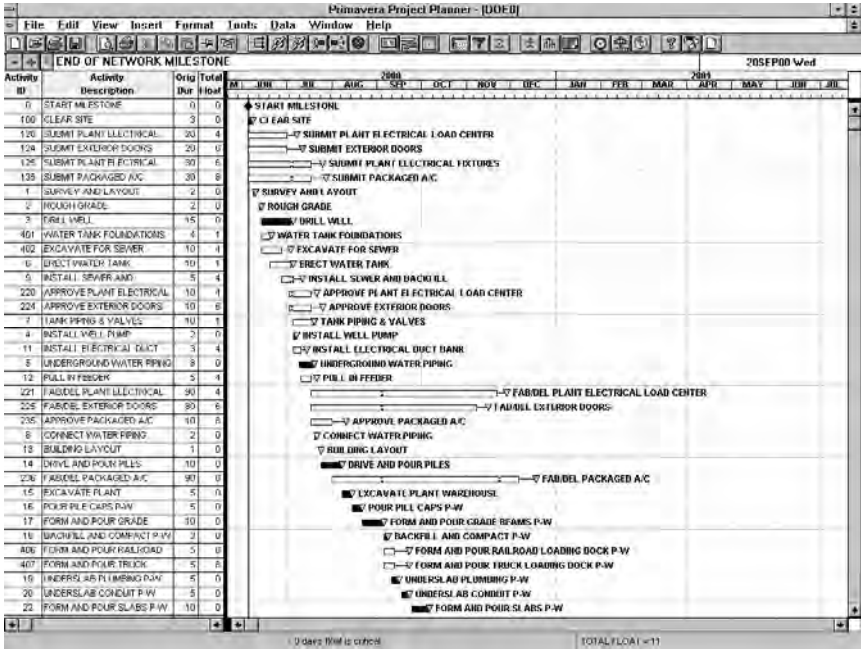

Figure 9.11.5 Graphic created by use of filter and sort instruction to list only “near-critical” activities.

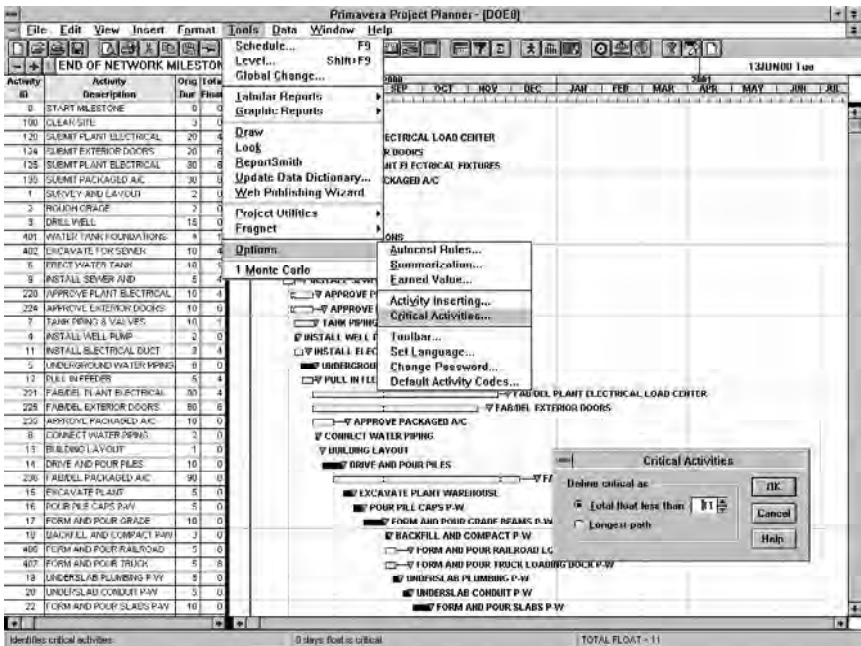

Figure 9.11.6 Critical Activities to be designated as all those with under 11 days of total float.

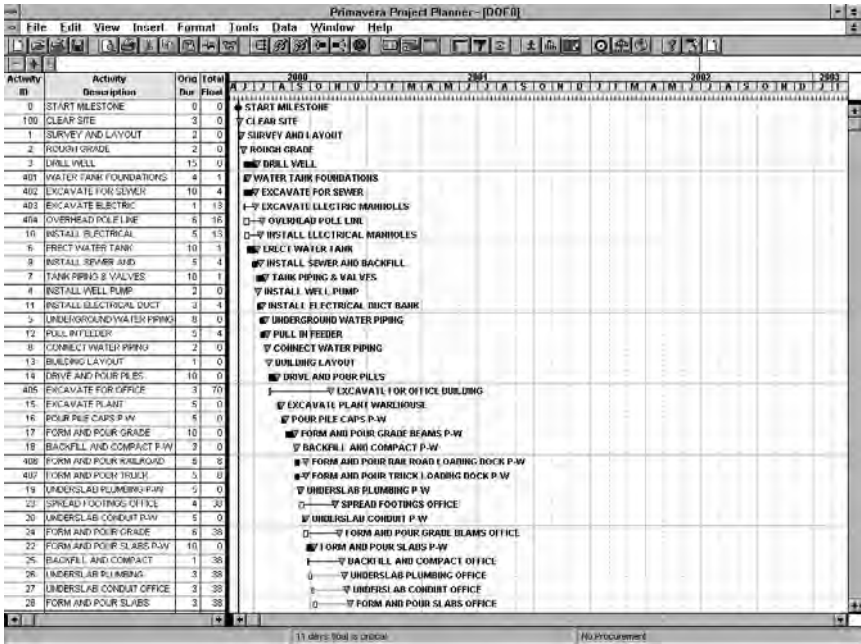

Figure 9.11.7 Critical Activities now designated as those with under 11 days of total float.

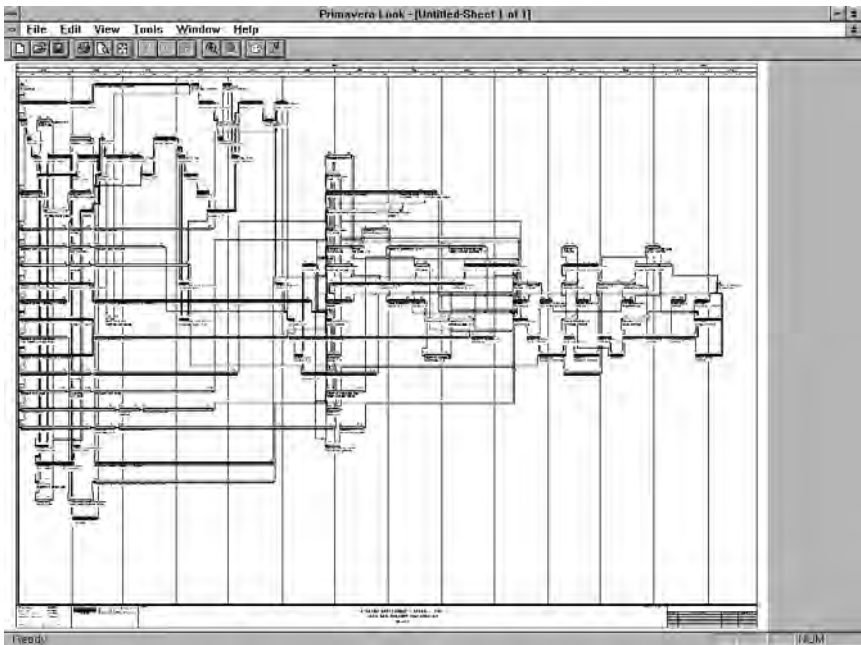

Figure 9.11.8 Critical Activities now designated as those with under 11 days of total float.

### 9.12. Continuous versus Interruptible Performance

With the ability to constrain the finish of an activity occurs the question of whether this will also constrain the start of the activity or may the activity start as planned and then, after a period of non-work, the remainder of the activity scope may be completed. Another way to pose this issue is to ask if work on a specific activity must be performed continuously or may work on the activity be interrupted (Figure 9.12.1). If the activity may be interrupted, an associated issue is to determine where or when. Computer software that converts the CPM output to a bar chart graphical format has a particularly difficult problem with this and tends to solve it by showing a bar spanning from start to finish, without regard for the stated work day duration. Obviously, at this point, the float calculation of  $EF - ES$  is no longer equal to that of  $LF - LS$ . Although it may seem obvious that the determination of interpretability may differ from activity to activity, software systems that support this ability do it on a project basis. As this issue is raised more often in the PDM variant of CPM by the use of  $FF$  or finish-to-finish relationships, it is further discussed in Chapter 11.

### 9.13. Actual Start and Finish Dates

The assigning of actual start and finish dates to activities can cause additional confusion and, depending upon the software algorithm, create additional misunderstandings. As noted previously, nominal preparatory work or material deliveries can result in incorrect reporting of actual start dates (for scheduling purposes), while nominal or schedule unrelated work remaining can result in incorrect reporting of actual finish dates. A typical problem caused is the reporting of work out-of-sequence, with activities reported started (or even complete) prior to completion of their predecessors. Several software systems, recognizing such reporting as antithetical to proper scheduling rules, refuse to accept such data, report an error, and stop processing. Other programs accept the data, generating output of questionable validity. Still other programs accept the data, but print an exception report highlighting the potential problem.

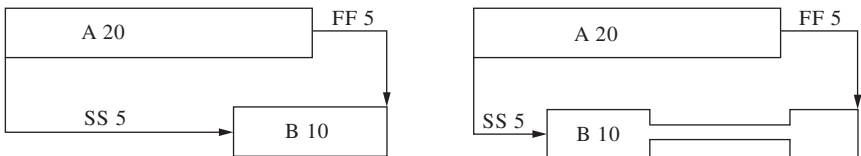

Figure 9.12.1 Continuous vs. Interruptible Activities.

Reiterating the issues raised in the previous section, an actual start date should not normally be reported until an activity's predecessors are complete. Thus nominal preparatory work should not generate an actual start date. An indication this has occurred is when an actual start is reported, but no reduction in remaining duration (RD) or positive percent complete is reported. Similarly, remaining minor or cosmetic repair work, typically considered punchlist work, should not delay reporting of an actual finish date. The actual start of incurring costs or earning revenue should not trip the actual start; holdbacks for costs unrelated to the start of successors should not delay reporting of actual completion.

### 9.14. Retained Logic versus Progress Overrides

Although the basic algorithm of CPM calls for performing the forward pass from the beginning of the network, using zero durations for those activities that are complete, a special problem can occur when work is performed out-of-sequence. In such cases, when an activity has started even though its predecessors may not be complete, a question arises: can

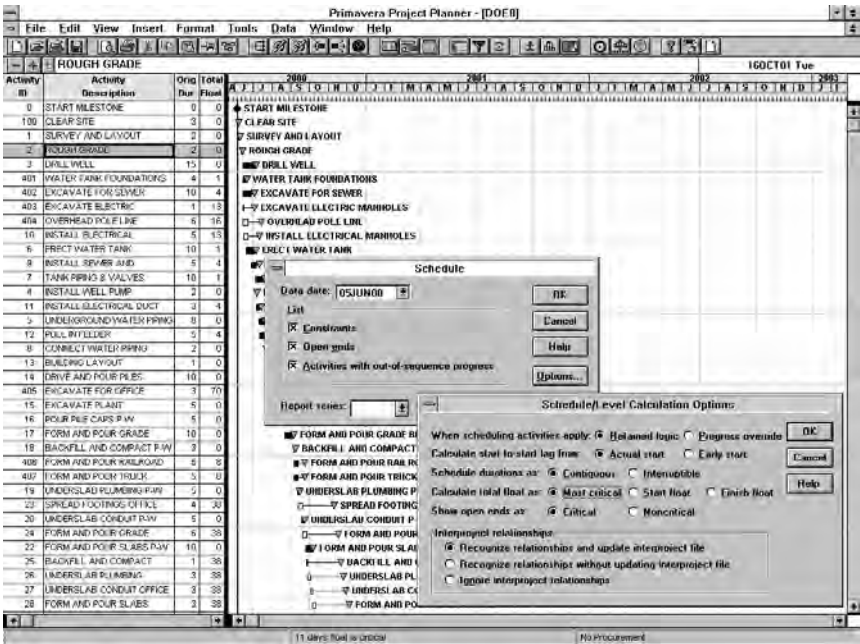

Figure 9.14.1 Choice of Retained Logic vs. Progress Override.



the remainder of this activity be completed or must work on this activity stop until all predecessors are complete?

There are logically three possible answers to this question under the traditional method of CPM calculation. (There is also a fourth possible answer using the PDM implementation of CPM, discussed in Chapter 11.) The first is that the work performed is incidental to the main thrust of this activity and that all further work must await completion of previously stated predecessors, the traditional answer. Second, that this activity may continue, but its successors will be delayed until this activity's predecessors are complete. This is an implied *FF* relationship permitted in PDM but not in ADM without very special computer software. And third, that having shown that we can break the logic relationship, it is construed to be broken, and that further work on this activity and all successors may continue without regard to the uncompleted predecessor work.

In Primavera software, the first option is called **RETAINED LOGIC** and the third is called **PROGRESS OVERRIDE**. Option 2 is not supported. The user selects which of these two algorithms are to be used for the project in a project configuration screen (Figure 9.14.1).

### 9.15. Events and Milestones

Noted previously were the calculation algorithms for both the original ADM variant of CPM and PERT and also some of the issues related to converting the calculated numerical output of the CPM algorithm to dates. It is important to remember that the mathematical basis for these algorithms is to calculate the early and late times of events, or points in time  $T_E$  and  $T_L$ , and only as a secondary calculation to determine the attributes of the activities for early and late start and finish, *ES*, *EF*, *LS*, and *LF*. It is unfortunate that the concept, as well as the proper reporting of event,s has often been ignored by software vendors focusing upon converting the CPM output to a bar chart style graphical user interface (GUI.) What is missed is that events, including important events or milestones, do not have a start and finish but are in fact one point in time. The confusion engendered over whether the *ES* – *EF* dates for a milestone should be reported as 08FEB – 08FEB or as 08FEB – 05FEB and the requirement of software systems to designate milestones as “START” or “FINISH” are only symptoms of the problem.

A recognition of this problem was made by some of the early vendors of the ADM variant of CPM by allowing milestones to be designated by having identical *i* and *j* nodes, such as “45 – 45.” These early programs had limited GUI capabilities and were limited to reporting the milestone date as either an “early” or “late” date in appropriate tabular columns. Recognition that milestones and other zero duration events are, in fact, points in time

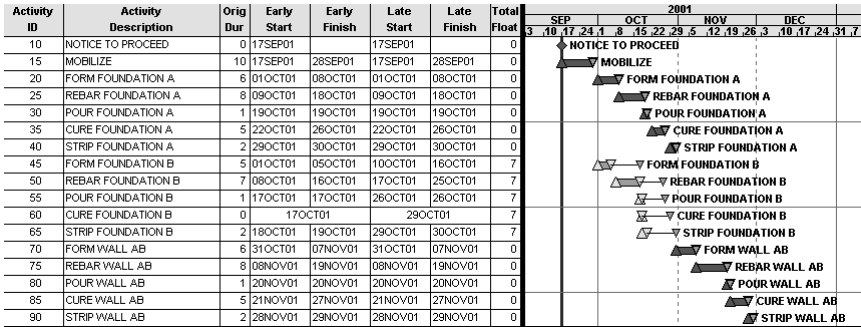

Figure 9.15.1 Possible depiction of a milestone or zero duration activity.

and neither “start” nor “finish” dates is now possible to properly depict, as in Figure 9.15.1, but not currently supported by software vendors.

From a conceptual point of view, the erosion of the concept of events, or points in time, is also troubling. As repeated throughout this text, the basic concept of CPM is that each activity may start only at a point in time after the finish, or 100 percent completion, of all predecessors to that activity. The backward pass likewise requires that the activity must finish prior to that point in time prior to the earliest of late start dates of all successors to that activity. Where these rules are relaxed, as will be discussed in Chapter 11 on the PDM variant of CPM, there is a significant danger of loss of accuracy in the initial CPM and a further loss of accuracy in updates during the course of the project.

### 9.16. Hammocks and Summary Network Logic

The original ADM methodology is based upon points in time, or nodes, separated by activities or additional “dummy activity” logic restraints. Measurement from the first node to the last node of the logic network, via the critical path, constitutes the total project duration. Often, as a means of reviewing the forest of an overview of the project rather than the trees of individual activities, it is desired to know the total duration between two points or nodes of the project, whether these have been officially designated milestones or not. For this purpose, a special type of activity was developed called a “hammock.”

The hammock activity is neither a true activity nor is it a logic restraint, but merely designates the start and completion of a subset of the total network. If CPM calculations are performed from the start of this sub-network to its end, the longest, or “critical” path, will calculate the total duration of this sub-network. This duration will then be recorded and reported as the calculated duration of the hammock.

Implementation of this concept by various software vendors may be done correctly, that is, by requiring a true logic path from start to end, or literally ignore the logic and merely subtract the  $T_E$  of the  $i$  node from that of the  $j$  node of the hammock activity to calculate the hammock duration.

### 9.17. Summary Activity Bars

The hammock activity summarizes portions of the logic, from one point in time to another. There is an alternate means to summarize the many activities of the project, the summary bar by activity code. While the hammock approach may be used to condense as one bar all work from the completion of a building foundation until completion of the roof, the summary activity bar may condense all work by a specific subcontractor, such as the plumber. The first step, of course, is to have a code field on which to summarize and to provide descriptions for the various values that may populate the field. The second step is to organize by that code field (Figure 9.17.1.)

A solid bar from the first to the last activity to be performed by this subcontractor may be used, or the bar may be “necked” to distinguish periods of activity and inactivity. Finally, it may be desirable to color bars based upon some code field and this can be accomplished in the pattern sub-dialog box. (See Figure 9.17.2 with “Neck” box checked and patterns chosen by contractor type.)

Shown in Figure 9.17.3 is a portion of the detail of the project organized by contractor type. Figure 9.17.4 provides one view of the same information in a summarized format, and necked to distinguish work and non-work periods. A careful look at the black and white graphic in

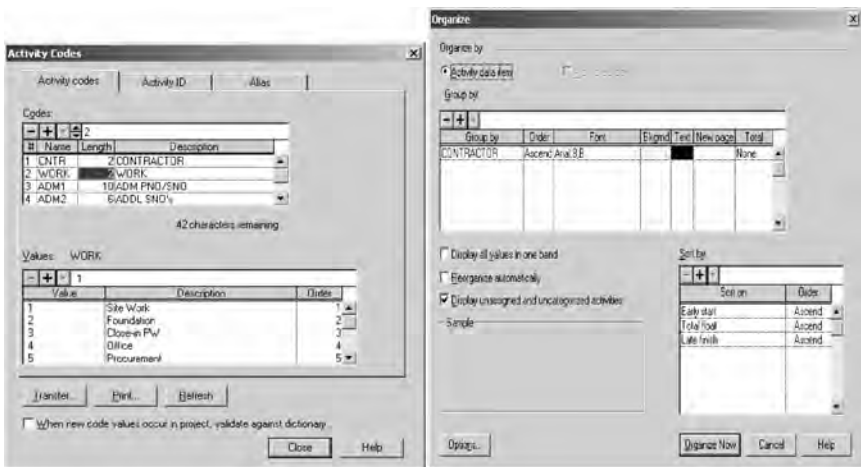

Figure 9.17.1 Activity code dictionary and organize dialog boxes.

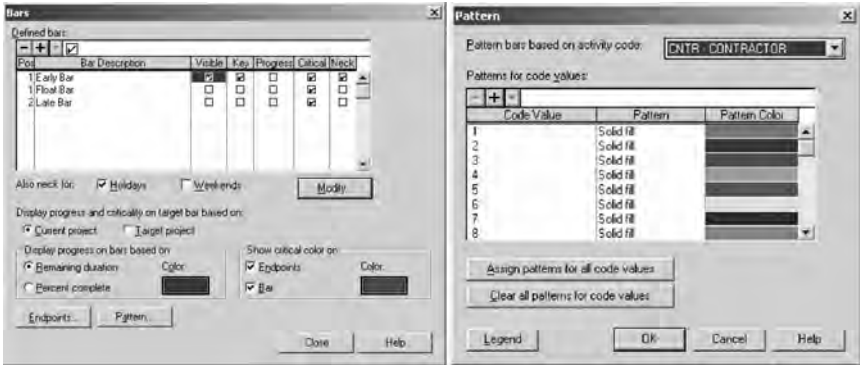

Figure 9.17.2 Bar dialog box. Pattern sub-dialog box.

the printed text, or full color illustration on the CD, may indicate the value of setting pattern colors. Critical activities (per the Scheduler's definition of criticality), such as Activity 38, are indicated by a red line down the middle of the bar in the detailed view. Obviously, this type of information is not available in the summarized view.

If pattern colors are chosen, the summary bar may be one bar or it may be separated into constituent activities. In Figure 9.17.5, the activities of the project are first reorganized by work area, then the summary box dialog box is used to choose individual bars rather than the one summarized bar of the underlying figure. Figure 9.17.6 displays the result,

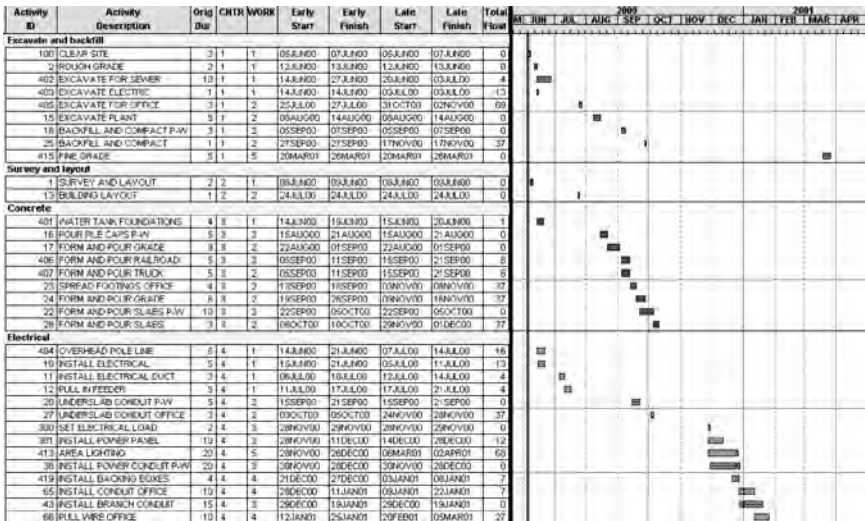

Figure 9.17.3 Detail of project, organized by subcontractor.

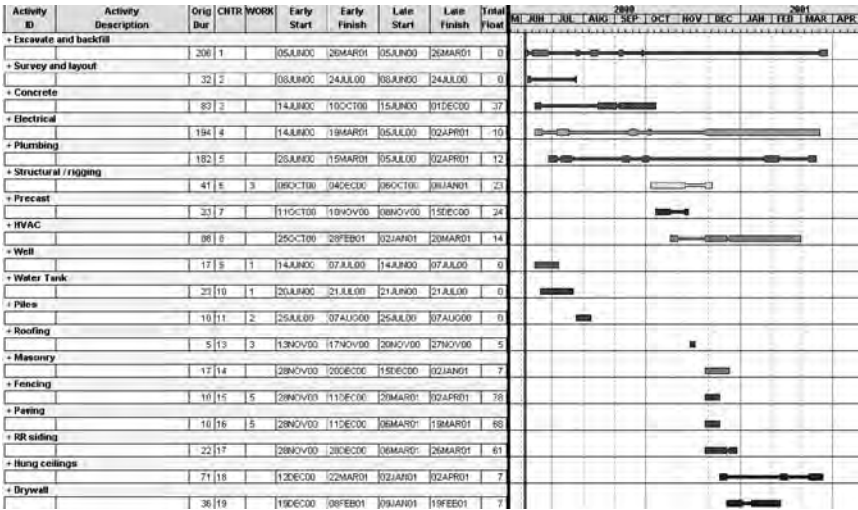

Figure 9.17.4 Summary of project, organized by subcontractor.

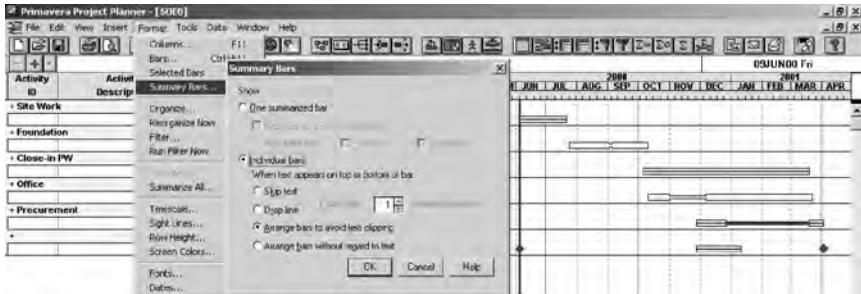

Figure 9.17.5 Summary Bar Dialog Box.

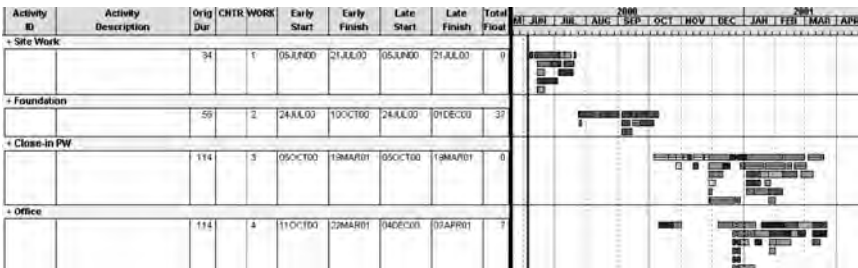

Figure 9.17.6 Summary Bar showing individual activities.

indicating the total number of crews performing work in each area at any time and to which subcontractors these crews report.

Yes, this information is being presented in bar chart format. The point is that the effort to record the logic behind the CPM allows the software to then produce such sophisticated bar charts. And these bar charts may be updated on a monthly, weekly, or even daily basis by merely adding current update data and recalculation.

### **9.18. User-defined Code Fields**

The ability to attach codes to various activities is generally a boon to users of a schedule. Such user-defined codes, including perhaps a code for responsible party, or area of the project, permits software filters and sorts to prepare custom reports of say, activities to be performed by one responsible party, sorted by area of the project. A hidden benefit of such code usage is promoting the discipline of having only one party responsible for any one activity. But in the real world some exceptions may occur, such as (on a union project) having electricians as observers on a large concrete pour that includes numerous embedded conduits. How can this activity be coded to assure it being listed on the electrical responsibility report as well as the concrete crew report? More importantly, in an effort to achieve perfect coding, will adding phantom activities or other manipulations compromise the network? The key is to remember that the coding structure is to augment and not control the network preparation.

### **9.19. Adding Resources to Activities**

Similarly, the addition of assigning of resources to an activity is a benefit to the Scheduler. Assignment of resources helps clarify the limited description assigned to the activity. Assignment of resources helps define the duration assigned to the activity. For example, a 2-craftspeople crew may take 10 days to perform a task, while a 10-craftspeople crew might take only 2 days. A statement of the crew size helps validate the duration assigned by defining how the Scheduler chose such duration. However, such listing of resources as an explanation of the scope and duration of the activity does not imply that no other resources may be required to accomplish the activity, nor that the resources listed will be used exclusively for such activity.

Let us assume that a crew of three boilermakers will rig and set two pumps in two adjacent but distinctly separate structures on the same day. Each activity will be given the minimum duration used on this project, that is, 1 day. Each activity will be assigned three boilermakers. The total manpower to be used that day, however, will be three and not six. Might we assign 1.5 craftspeople to each activity? Yes, if we wish to count beans rather than produce a schedule.

If measurement of total manhours or mandays is desired, then possibly two separate data fields may be assigned to the activity. The first to state the resources required to perform the activity (three craftsmen, one backhoe and driver, etc.) and another to state the quantity of resources to be used (three craftspeople  $\times$  4 hours each or 12 manhours, 1 hour of the backhoe). Again, the key is to remember that the assignment of resources is to augment and not control the network preparation.

## 9.20. Adding Costs and Cost Codes to Activities

Assignment of costs to activities creates even a greater risk of compromising the scheduling benefits of the CPM network. For although a cost-loaded network has many benefits, the key is to remember that the assignment of costs is to augment and not control the network preparation.

If, however, the CPM is to be used for accounting purposes, and to the tolerances of accounting (*to the penny!*), then the viability of the CPM as a scheduling tool may be gravely compromised. The chance of its meeting the needs of an accounting department are also low. The term *tolerances* used here is instructive. Costs to an accountant have a low tolerance. If payroll is to be generated from any system, it had better be correct, to the penny, and correct to the penny relating to benefits and taxes. A looser tolerance is required for estimating purposes and for cost engineering or productivity studies. An even rougher estimate or looser tolerance is required for scheduling purposes. If such a looser tolerance is permitted, if costs are added to augment the network rather than control the network, then several benefits may accrue to the users of the network.

These include (1) additional clarity to the definition of an activity, (2) a means to roughly forecast cash flow, and (3) a means to compare the validity of the network versus the bid estimate. As noted previously, the resources attached to an activity are approximate. Extrapolating such resources (labor, equipment, and material) with average wages, rental costs, and purchase prices, therefore, will be expected to create an approximate cost.

Such approximations are acceptable for payment purposes also since (1) even the most detail-oriented project engineer would measure and pay for concrete only to the nearest cubic yard and (2) even if one activity is overvalued by several hundreds of dollars, the total for the project will be correct, to the penny.

The use of a cost-loaded CPM for payment purposes raises another serious issue for the scheduling professional. An implied definition of any activity is a scope which requires completion of its predecessors and is

required for the start of its successors. Thus, in the real world, some portion of any named activity may be performed and payment earned before its predecessors are complete and the truly defined activity begins; and some portion of any named activity may remain incomplete, although its successors can begin, and the truly defined activity can be deemed complete for scheduling purposes. As an example, consider the erection sequence of form-rebar-pour slab-on-grade, walls, and elevated slab. It is likely that the delivery of all rebar for the three activities would be accomplished at once, thus, depending upon the wording of the construction contract, justifying payment for delivered materials for all three activities. It is also possible that some cosmetic flaws may exist in the concrete wall, although it is capable of supporting the elevated slab.

In the first case, it would be inappropriate to indicate an actual start or schedule percent complete for the walls and elevated slab rebar prior to the pouring of the slab-on-grade. In the second case, it would be inappropriate to fail to provide an actual finish date or grant less than 100 percent for work on the wall. Many software systems provide a means to either unlink percent complete from schedule progress or to report two percent completes for each activity, a schedule percent complete and a cost percent complete. Primavera provides both of these options as well as per-project configuration switches (Figure 9.20.1).

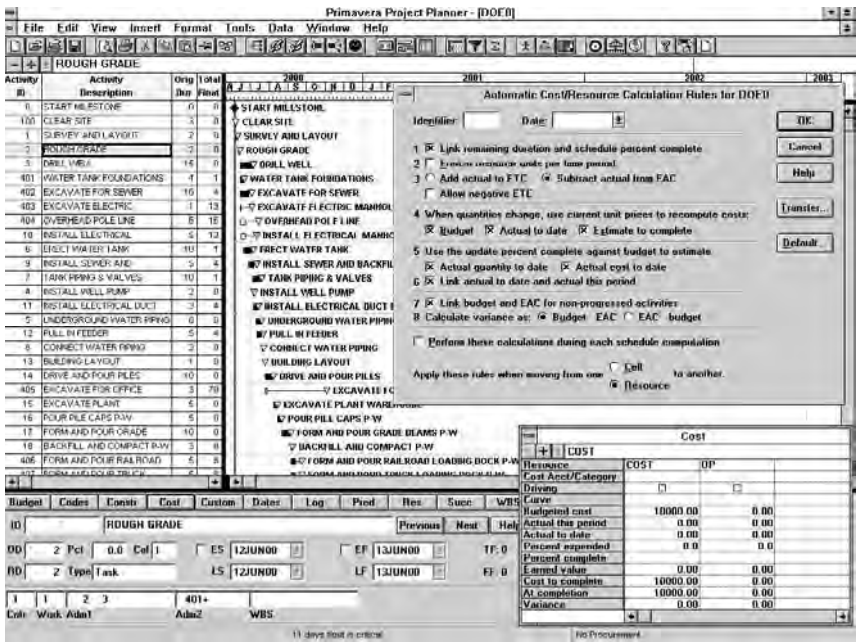

Figure 9.20.1 Configuration screen to choose linkage of percent complete schedule versus cost.



Another problem with assignment of costs to activities is that any one activity may have a number of different “costs” associated therewith. The first is the budgeted cost. The next is the actual cost experienced in the field. Then, there is the earned value, including unassigned overheads and profits. If an activity has been altered by a change order, these three “costs” will be duplicated. If multiple change orders impact the activity, multiple duplications may be called for. Software products may track one or several of these multiple fields and the subsidiary fields associated with them. For example, in Primavera, the user may report an activity 50 percent complete for schedule, have spent 90 percent of its budget, and yet have earned only 30 percent of its specified value.

### 9.21. Resource Driven Scheduling

Throughout our discussions of various scheduling algorithm alternatives, we have so far used a model that requires the Scheduler to determine an original duration for each activity. As a large project is broken down into small definable tasks, the estimation of duration for such tasks is made easier. In most cases, a Scheduler or project manager may estimate the duration of such tasks with a reasonable degree of accuracy. Factors that influence the estimate of duration include, but are not limited to, the number of manhours estimated for the task, the chosen utilization of resources, and an understanding that both the crew size may vary and even the number of hours may vary during a day, depending upon the progress of the work.

Sometimes, however, estimation of duration may be both more and less difficult. Less difficult because performance is based strictly upon the usage of key resources (people, computer access time, etc.); more difficult because the availability of key resources may run according to their own calendars rather than the common calendar of the project. On the other hand, the effort of determining an estimated duration now becomes a purely mechanical task that is best done by the computer. The Scheduler need only enter the estimated number of manhours (or other units of resource usage), the number of craftspeople (or other units of resource), and a calendar of resource availability to permit the software to determine the duration of the activity.

Again, seemingly simple, but if a room of project managers were given the same information, it is likely that more than one estimate of individual task duration would be the end result. One area of divergence may be the assumption of linear or constant usage of a resource versus an expectation of ramp-up, production, and taper-off usage. Here, some project managers may assume in their duration estimates that although a nominal crew, of say 10 masons, will build a wall, for the first 2 days only two key craftspeople will begin at the corners, and at the end of the

activity, only two craftspeople will top off the parapet. In a large wall forming activity, although the number of craftspeople remains constant, productivity will be lower for the first 2 days as a learning curve develops. Note that in both of these instances, finer detail could better alleviate the estimating difficulty, but would make reporting and updating more difficult.

Software solutions may also result in divergent results. While one software product may assume a linear assignment of resources, another may assume or permit a nonlinear assignment, such as the bell-shaped curve or slow-at-first then full-production triangular curve suggested previously.

If more than one resource is assigned to an activity, which one or ones will be used to determine the activity duration? Some (usually limited) resources may be designated as *driving* the scheduling of an activity, while others (openly available) may passively be called for as required. If two or more resources are designated as driving, the activity may be constrained to production only when both are present or different portions may proceed independent of the resource needs of the others. Note that the latter case may be represented by two (or more) activities having common predecessors and successors.

Both P3 and the newer P3e/c support the type of activity where the calculated duration increases incrementally as one of several resources become available until all work is accomplished. The type of activity when the calculated duration increases incrementally only during periods of time when two or more resources are jointly available until all work is accomplished is supported by P3 but not by P3e/c. However, since this type of activity is used rarely and the same calculation can be obtained via a work-around (creating a special “activity calendar” limited to dates when both resources are available), this should not be seen as a significant problem.

Finally, if a limited quantity of some resource is available for the project, to be divided among several activities, which one should go first? This question, relating to resource leveling and smoothing, and dealing with the various software algorithms for adding such additional sequencing restraints, is discussed in Chapter 37.

## **9.22. Master Schedules Local versus System-wide Updating**

Managing two or more projects that are somehow related poses a new set of requirements upon the process of planning and scheduling. However, it is again important to remember that the primary purpose of the CPM is for planning and scheduling for the benefit of the project (usually matching the needs of those performing the work) and not for reporting to upper management, the cost department, regional resource directors, or third-party dignitaries. Any additional benefit that may be

obtained from a good CPM is welcome, so long as obtaining it does not reduce the quality or usefulness of the CPM to the project.

One implementation of a master schedule involves designating several independently controlled projects as being part of a “group.” Perhaps the group shares common resources, such as heavy construction equipment or key personnel, or a common program, such as multiple projects occurring at an airport site or modules to a computer program, or a common supervisor. By taking away power from the project manager for an individual project and requiring all project managers to adopt common codes and procedures, the CPM may provide benefits to managers who are not directly responsible for the implementation of this project. There may even be additional benefits for the project manager who has sublimated control over the CPM due to the reciprocal information from other projects subjected to this process.

What may be these potential benefits? In a large construction company, the heavy equipment manager will be able to see not only the short-term needs of various projects, but the mid- and long-term needs. Allocation of equipment could be planned upon strategic reasons rather than “who asked first.” Decisions could even be centralized as to whether an individual project manager has the right to rent equipment outside of the company to keep a project “on schedule.”

What are the potential costs? Obviously, the process of planning must be somewhat institutionalized so that each activity requiring heavy equipment is so coded, and that common company-wide codes are used for such equipment. If using software such as Primavera P3, the order of the code fields must also be consistent as roll-ups among projects within a group are by code field #1, #2, #3, etc., rather than by the code field name. In any case, it is likely that all project managers will be required to use the same software system. If the heavy equipment manager desires reliable information that is good for other than long-range purposes, what will be the impact if project One is updated each Monday, project Two each Friday, project Three on the first Monday of the month, and project Four on the 1st and 15th of each month? And yet, the timing of updates may be more dependent upon the owner’s specification or the availability of the company’s in-house Scheduler to perform only so many updates on any one day than upon the needs of the heavy equipment manager. Finally, if the project manager has a weekly meeting of foremen on Monday mornings and updates are set by company needs to be on Monday afternoons (with results available Wednesday), the team will likely schedule its work based upon the reliable, old-fashioned, hand-drawn, 3-week schedules and the entire CPM effort will be converted from a tool to help the field to just an extra paperwork burden.

Another problem with the concept of master schedules is determining the proper hierarchy of projects. The program manager of the airport

authority wants to know how many large cranes are on the site and tells all contractors to use a specific code for a crane in code field #5. This may well conflict with the construction company master schedule system. What to do? Have a “company-wide” program with one or several major projects excluded or have duplicate CPMs for the airport project, that is, one coded to the company master schedule and one coded to the airport authority master schedule?

Other rollup or summarization issues may arise from differing systems of measurement from one project to the next. It is all well and good that productivity by quantities installed be reported for company-wide accounting, but if some projects use metric and others English measurements, the specified coding field is not going to work.

### 9.23. Activity Types

The original activity of the 1956 era CPM was generally described as the effort between two points in time. Alas, that simple definition is no longer so straightforward. The bridging of many simple activities from the point in time before the first to the point in time following the last has been described previously as a hammock. As noted, a hammock “activity” is not assigned a duration, rather the duration between the two aforementioned points in time is calculated. In the Primavera for DOS software product, the means to designate such an activity was on the constraint screen, listing such as “hammock constraint.” Probably more accurately, the Primavera for Windows product creates a new input attribute for each activity, the activity type, and designates such summary activities by coding such as a Hammock type activity (Figure 9.23.1 through Figure 9.23.3).

Primavera does not check the logic validity of designated hammocks, instead only calculating the  $EF - ES = \text{Duration}$  between the start of its earliest predecessor and finish of its latest successor. It is up to the individual Scheduler to validate the logic actually runs from start to end. Primavera also supports another faux hammock type designated as a WBS activity. Here, the logic is determined automatically from the first



Figure 9.23.1 Activity types.

```

ACTIVITY FORM                               DINI
I node: 3  J node: 13                      TF: 0
Title: Hammock #1                          PCT: 0.0
ES: 14JUN00 EF: 21JUL00  Orig. duration: 27*  Actual Start:
LS: 14JUN00 LF: 21JUL00  Rem. duration: 27*  Actual Finish:

Activity Codes:
-----
DATE CONSTRAINTS:

Start no earlier than          Start no later than
Finish no earlier than        Finish no later than
      Start on
Mandatory Start                Mandatory Finish

FLOAT AND DURATION CONSTRAINTS:  (Choose one) HA
Zero Free Float (ZFF)           Zero Total Float (ZTF)
Hammock Activity (HA)           Expected Finish (XF)
                                Expected Finish Date

Start Flag (SF), Finish Flag (FF),
Start Milestone (SM), Finish Milestone (FM) or None (Blank):
-----
Commands: Add Delete Edit Help More Next Return autoSort Transfer View Window
Windows :Act.codes Budget Constraints Dates Financial Log Pred Res Succ cUstom
    
```

Figure 9.23.2 P3 for DOS designation of Hammock as a constraint type.

activity of a specific WBS code to the last. As the schedule changes during the course of the project, the logic also will shift accordingly.

Other options on how an activity is to be treated have also been added. The traditional activity is designated as a task activity, composed of one or more discrete tasks to be performed. In attempting to simulate a zero duration event (or node in ADM), Primavera required the designation of a zero duration activity (or node in PDM) as a milestone. Since even a zero duration activity has a start and finish, it became important to distinguish whether the simulated event was before the start or after the finish of the zero duration activity, thus being designated as a start milestone or finish milestone. Since Primavera has always supported PDM, even its treatment of ADM milestones (or events) was in this fashion, rather than the more traditional method of designating an event as activity #12 – 12 (with the *j* node equal to the *i* node.)

Another activity type is the flag. This special activity type may be placed following one or more other activities and calculates the earliest early start date of its predecessors if designated a start flag, or the latest early finish of its predecessors if designated a finish flag.



Figure 9.23.3 P3 for Windows designation of Hammock as an activity type.

Primavera P3 also supports two types of activities when the duration is driven by resource calendars rather than by the activity calendar. The first is the independent type activity. If such an activity is driven by one resource, it progresses according to the resource calendar of that resource. If such an activity is driven by two or more resources, it progresses whenever any one of the resources is available.

The second of the resource activity types is the meeting activity. As the name implies, for this activity to progress, requires that all driving resources are available. Thus a meeting activity requires (as driving resources) both Steve and Mary, with Steve being available only the first 2 weeks each month and Mary being available only on Thursdays and Fridays, the activity can only experience progress for 4 days each month.

P3e/c no longer supports the meeting activity. A workaround suggested to Primavera by the authors is to code such activities as task activities assigned to a “Steve and Mary” calendar. The only stipulation to this workaround is that the “Steve and Mary” calendar will have to be manually adjusted rather than automatically following the individual calendars of Steve and Mary as they schedule their individual vacations and other appointments.

## **9.24. Hierarchical Codes**

Professional Schedulers know that it is the plan and the process of planning that brings the greatest return in the use of CPM. The reporting of progress and its impact upon the remainder of the plan is an important secondary aspect of CPM. The reporting of progress for the purpose of measurement of past performance is by far third priority. However, once progress may be measured, whether against a good plan, a poor plan, or no plan, some members of upper management want that measurement summarized according to hierarchies that often have little meaning at the level of the project and in assisting the project team to achieve good performance and a project completed in a timely manner.

It is the job of the Scheduler to understand these forms of hierarchy and to implement each in a manner that does not unduly conflict with the primary purposes of CPM. The literature on these topics, from such sources as the Project Management Institute (PMI), Association for Advancement of Cost Engineering International (AACEi), and American Society of Civil Engineers (ASCE) each deal with reporting within these hierarchies. Three such hierarchies discussed in Primavera’s P3e/c manual “Moving from P3 to P3e/c” include EPS (Enterprise Project Structure), WBS (Work Breakdown Structure), and OBS (Organizational Breakdown Structure), Although the definitions used by Primavera, MicroSoft, other software vendors, and in various scholarly articles may vary, a general definition of each may be as follows.

- **EPS, Enterprise Project Structure:** “The EPS is a hierarchy that represents the breakdown of projects in a company.” This may include “phases of projects or other major groupings . . . while projects always represent the lowest level of the hierarchy.” Higher levels of the hierarchy may group projects by project manager, client, office, fiscal year, or other level of summary. Note that the choice of group upon which to summarize is entirely subjective. Whether a summary can be made of all client projects serviced by each project manager for the vice president of projects or of all project managers servicing each client for the vice president of sales is a decision that will be made above the vice presidential level.
- **WBS, Work Breakdown Structure:** “The WBS is a hierarchical arrangement of the products and services produced during and by a project.” In many industries other than construction, hierarchies exist where a product is constructed of modules or components provided by other entities. These components may, in turn, be constructed of sub-components provided by others. However, at each level of component assembly, there may be little interaction among individuals.

In the construction industry, while some work is of a modular nature, it is more likely that the entire team of diverse individuals will weave in and out during the course of the entire project; thus making the design of the hierarchy a much more academic exercise. Thus, in the construction industry the WBS is often tied to the summarization format of an estimating or accounting department. Examples may include:

- Location, e.g., structure #1, #2, floor #1, #2, quadrant NE, SW, etc.
- system, e.g., potable water, utility water, etc.
- CSI division, materials, e.g., rebar, concrete, pipe, conduit
- work type, e.g., formwork, rebar, concrete, cure, strip

However, the decision of whether to summarize by structure then system or by system then structure is entirely subjective. More seriously, activities spanning the WBS breakdown may cause problems. Thus, while large foundations may involve separate activities for forms, rebar, and pouring, small foundations may require only one activity of 1-day duration. The temptation of upper management to demand that this activity be broken into three (to match three WBS codes) often will prevail. Reporting by the field against three “accounting” codes rather than one activity can be expected to be less than complete. Field crews attempting to utilize a 3-week look-ahead cluttered with duplicate codes for the same “activity” will abandon it for more simple field scheduling tools.

- **OBS, Organizational Breakdown Structure:** “The OBS is an outline of managers responsible for the projects in your company.” Whether this hierarchy is of named individuals (John, Mary, and Steve) or

roles (Superintendent, Foreman, and Craftsman), the applicability of this structure is more useful in an organization where personnel have fixed responsibilities. The OBS also presumes a simple hierarchy of reporting and authorizations and may be difficult to implement in an organization where matrix management is practiced.

In non-construction industries such a code is often useful where a named individual (or resource) is required for two or more separate products or services that may occur on different branches of the WBS tree. When the work product requires several layers of review and approvals, a WBS may be very useful. In the construction industry, even when projects get large enough to call for area superintendents, there is rarely enough of an OBS below the project manager to warrant separate coding.

The trick with hierarchical codes, like other codes, is to have them add value to the reporting system of the CPM schedule without distracting from the basic strengths (the choice of activities and logic relationships) of the CPM logic network.

### **9.25. Summary**

As we have seen, the basic Critical Path Methodology, while bringing logic to the planning and scheduling process and being a vast improvement over simple bar charts, has limitations inherent in any model of the real world. The good news is that the methodology is flexible enough to permit numerous enhancements while still maintaining the basic concept, that each activity must await completion of its predecessors before starting and in turn, must be complete before its successors may start. Each of the enhancements noted brings additional usefulness to the users of the Critical Path Methodology, but at the cost of requiring both the CPM preparer and CPM reviewer to address the ambiguities of non-standard terminology and algorithms, and requiring both to verify that the enhancements have not been used to accidentally or purposefully obfuscate this model of reality.



---

Chapter  
**10**

## **PDM and Precedence Networks**

In the early 1960s, Professor John W. Fondahl of Stanford University, an established expert on noncomputerized solutions to CPM and PERT networks, was one of the early supporters of the precedence method, or PDM. He called it the circle-and-connecting-arrow technique. His study for the Navy's Bureau of Yards and Docks included descriptive materials and gave the technique early impetus, particularly in Navy projects.

An IBM brochure credited the H. B. Zachry Company of San Antonio with the development of the precedence form of CPM. In cooperation with IBM, Zachry developed computer programs that could handle precedence network computations on the IBM 1130 and IBM 360. This was particularly significant because, in 1964, C. R. Phillips and J. J. Moder indicated the availability of only one computerized approach to precedence networks vs. 60 for CPM and PERT.<sup>1</sup>

The form for precedence networks was originally termed "activity on node." The activity description is shown in a box or oval, with the sequence or flow shown with interconnecting lines. In some cases, arrowheads are not used, although this leaves more opportunity for ambiguous network situations.

Figure 10.0.1 shows the John Doe network in precedence form. Seventeen precedence activities are shown, the same number as the regular activity-oriented CPM network. Simplicity of form is purported to be one of the advantages of precedence networks. When

---

<sup>1</sup>Joseph J. Moder and Cecil R. Phillips, *Project Management with CPM and PERT*, Reinhold New York, 1964.

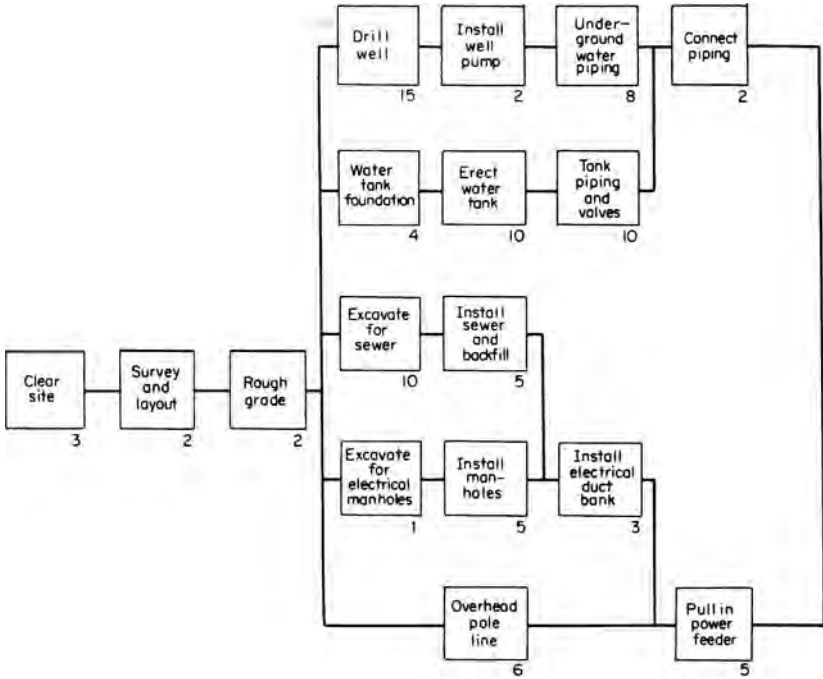

Figure 10.0.1 John Doe network in precedence form.

activities have to be subdivided to show phased progress, the precedence network can result in a lower number of notations, in some cases, more than a 50 percent reduction. Consequently, the precedence network has the advantage of a simple appearance and, to those who use them continually, interpreting them can be straightforward. Unfortunately, the ability to interpret them is not as easily acquired by someone accustomed to CPM.

### 10.1. Precedence Logic

One reason for the apparent simplicity of precedence networks is that a work item can be connected from either its start or its finish. This allows a start-finish logic presentation with no need to break the work item down. The translation of the John Doe network into precedence form shown in Figure 10.0.1 consists of only one type of connection: end to start. Figure 10.1.1 illustrates the three basic precedence relations: start to start, end to end, and end to start. Although precedence networks are simpler in appearance than regular CPM diagrams, greater thought must be given to reading and interpreting them.

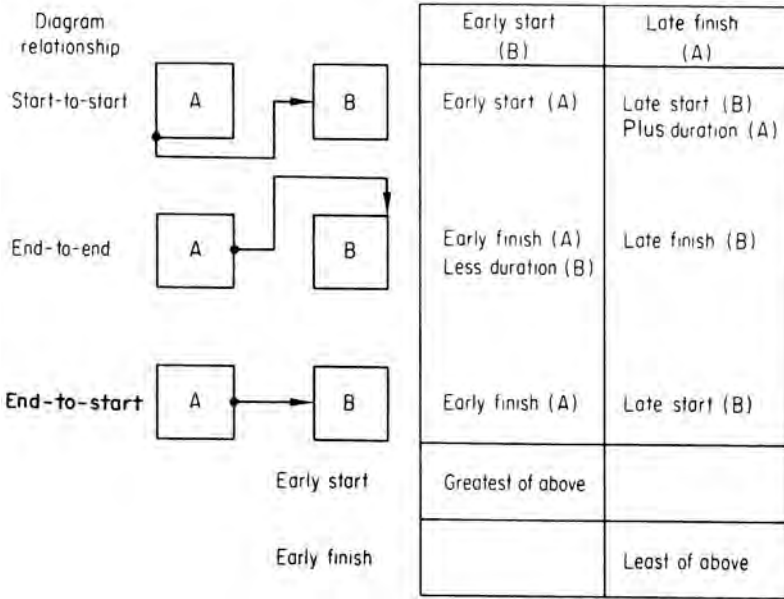

Figure 10.1.1 Typical precedence relations.

Another characteristic of PDM diagrams is the use of lead and lag factors. In CPM, lead activities that logically delay the start of a particular activity or group of activities can be introduced (Figure 10.1.2). Assigning a duration to the lead activity imposes a delaying factor in the CPM calculation. (The effect can be achieved in many CPM computer programs by locking in an event date to occur “not earlier than.”)

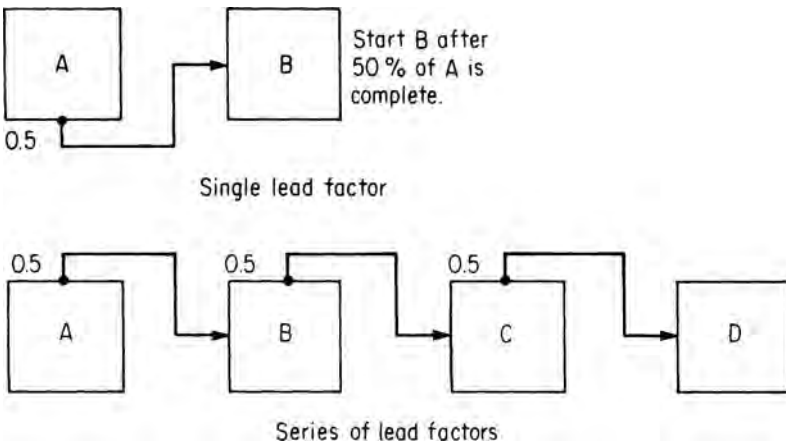

Figure 10.1.2 Lead factors.

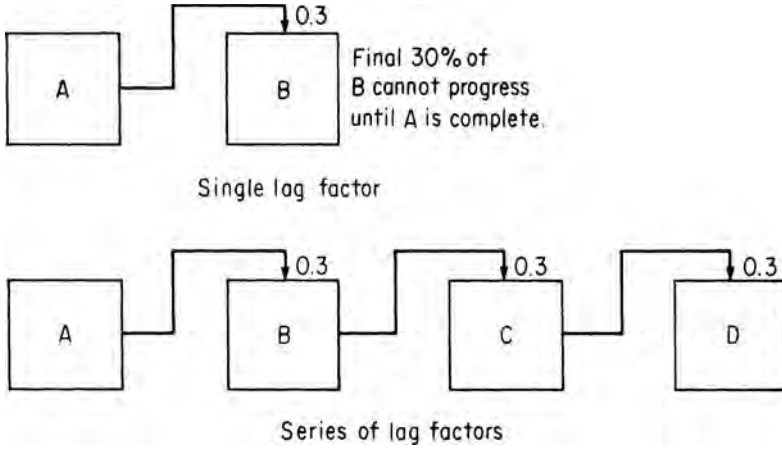

Figure 10.1.3 Shows use of lead and lag factors.

Similarly, a large activity can be imposed to direct the completion of an activity to occur some period of time after either the start or the completion of another activity (Figure 10.1.3).

The lead/lag factors assigned to PDM work packages can replace the multiple activities required in CPM to reflect start-complete or start-continue-complete; that is, they can replace the multiple activities required in CPM to create an interim event or events at which other activities start or conclude (Figure 10.1.4 and 10.1.5).

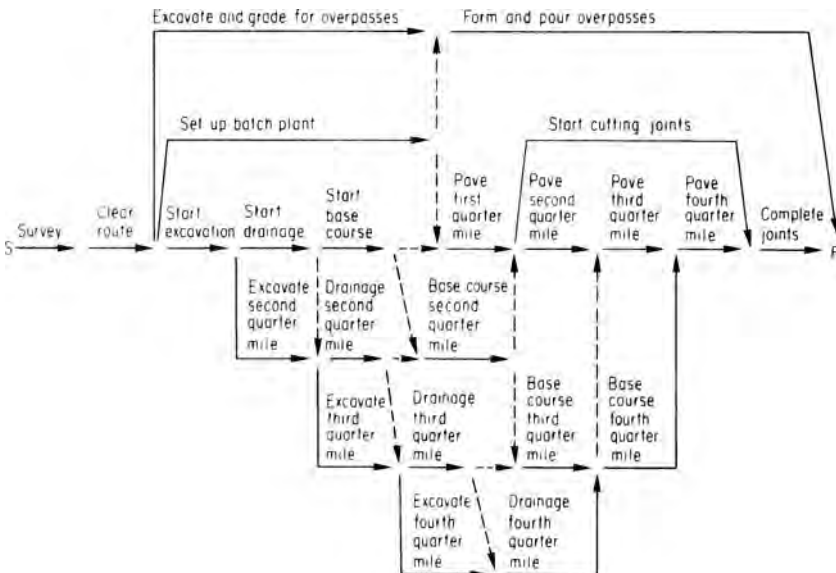

Figure 10.1.4 ADM version of network for 1-mile highway

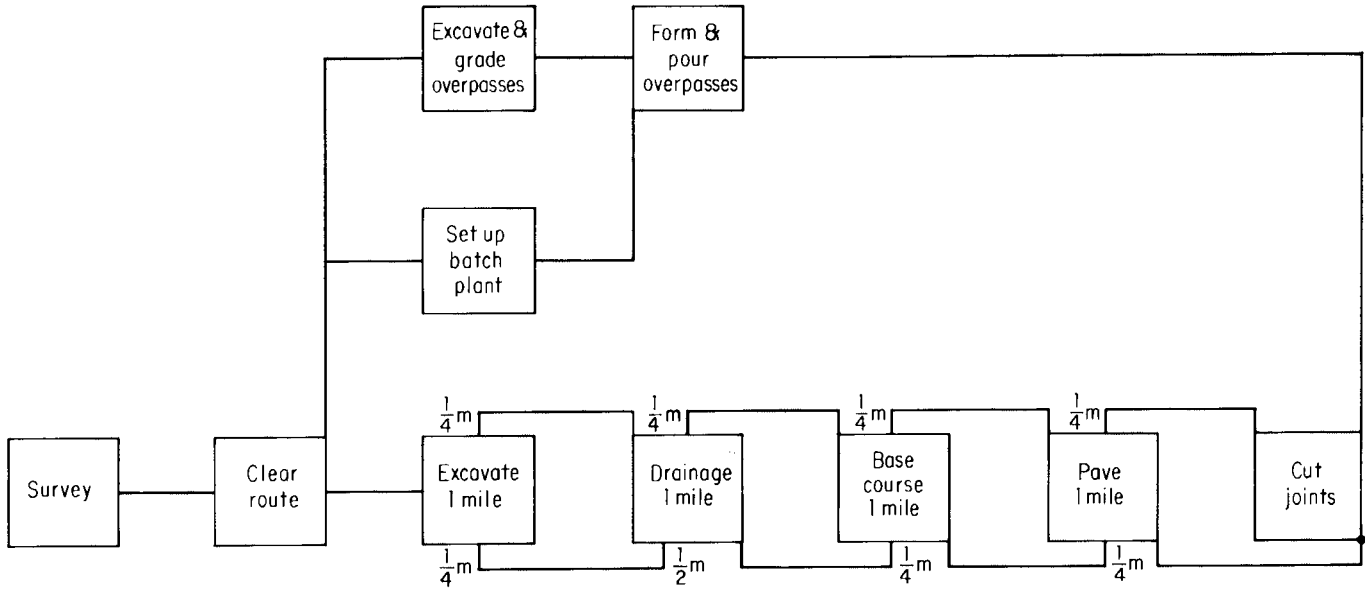

Figure 10.1.5 PDM version of network for 1-mile highway

The result can be a network diagram that is apparently simpler than a regular CPM network because it takes fewer work package “boxes” to describe the same set of circumstances. Although the depiction appears simpler, PDM diagram users have to think harder to understand the logic depicted. Perhaps the greatest strength of the CPM network diagram is its ability to first record the logical sequence of a plan and then to communicate that logic. PDM, in its sophistication, takes a step backward in communications capability.

Experienced schedulers using PDM on a regular basis have stated that they can fine-tune and change schedules more readily with computerized PDM. At the same time, the leads and lags make hand calculation of PDM less practical, if not impractical. Further, time scaling of PDM is more difficult than time scaling of CPM. Since time scaling is, in itself, a calculation, the difficulty in doing it confirms two things: (1) that manual calculation of PDM is impractical, and (2) that PDM obfuscates the use of a network as a means of communicating information.

That is a very significant loss. From the earliest period of using network methods, it was clear that communicating the results is vital to the effective implementation of a network-generated schedule. The network schedule itself becomes moot and meaningless if project managers are unable or unwilling to understand the output. Early CPM programs suffered from overenthusiasm and overwhelming pages of computer printouts. Since then, sensitivity to the communications aspects of CPM has become a vital part of ensuring the effective utilization of CPM results.

PDM has the paradoxical characteristics of apparent simplicity and built-in sophistication. The result is that the PDM scheduler becomes the project guru rather than a participating project team participator.

## **10.2. Work Package Calculations**

In theory, work package time calculations are quite similar to CPM event calculations. The first stage is the establishment of a work item and duration chart. A table of relations is then constructed on the basis of the typical relations shown in Figure 10.1.1. The early start time for the first work item is zero, although a calendar start date can be inserted later. The early start time at the beginning, or each of the other work items, is the greatest of the paths entering the beginning of the work item. The value of the paths is computed by the following methods:

1. *Start to start:* The early start time for the preceding work item is the early start time for the work item.

2. *End to start*: The early finish time for the preceding work item is the early start time for the work item.
3. *End to end*: The early finish time for the preceding work item less the duration of the work item itself is the early start time for the work item.

The longest path to the beginning of a work item determines the item's early start time. The early finish time for a work item is the item's early start time plus the duration. By definition, the late finish time for the last work item is set equal to the early finish time for that item, which establishes a critical path. The late finish times for other work items are determined by subtracting or a backward pass from the late, or the finish, time for the terminal event. The late finish times for other work items are the least of the paths leading into completion of the work item, as follows:

1. *End to start*: The late finish time is the latest start time for the following work items.
2. *End to end*: The late finish time for the work item is equal to the late finish time for the following work item.
3. *Start to start*: The late start time for the following work item plus the duration of the work item itself determines the late finish time for the work item.

Late start time equals late finish time less duration. Float for a work item can be calculated by the same formulas utilized in the CPM approach. Similarly, the critical path can be identified using the standard rules. As noted, the introduction of lead and lag factors (easily handled by computer) makes manual calculations difficult, if not impractical.

### 10.3. Computer Calculation

For a golden period in the 1980s and early 1990s, computer programs could handle either PDM or ADM. Ironically, the initial programs utilized an internal translation of PDM into an ADM format, calculation by ADM, and retranslation back into the PDM format.

One problem in inputting the PDM diagram is the lack of event numbers. If all of the activities were end-to-start, the work package numbers could be used similarly to *i-j*. However, the complexity introduced by start-to-start, start-to-end, and end-to-end relations required a cumbersome cataloging of predecessor and successor work items.

Figure 10.3.1 presents a simplified ADM printout. Figure 10.3.2 presents the simplified PDM printout for the John Doe example. It is very

D'BRIEN KRITZBERG & ASSOC., INC.		PRIMAVERA PROJECT PLANNER		JOHN DOE PROJECT ADM VERSION									
REPORT DATE	CPM IN CONSTRUCTION MANAGEMENT - 5TH EDITION	START DATE	5/JUN/00	FIN DATE	1/APR/01								
1-3 SORT LISTING	DOJO AS-PLAN 05/JUN/00	DATA DATE	5/JUN/00	PAGE NO.	1								
PRBD	SUCC	ORIG	REV	DUR	DUR	%	CODE	ACTIVITY DESCRIPTION	EARLY START	EARLY FINISH	LATE START	LATE FINISH	TOTAL FLOAT
0	1	3	3	0			1	1 CLEAR SITE	5/JUN/00	7/JUN/00	5/JUN/00	7/JUN/00	0
0	210	10	10	0				SUBMIT FOUNDATION PERM	5/JUN/00	16/JUN/00	3/JUL/00	17/JUL/00	20
0	212	20	20	0				SUBMIT STRUCTURAL STEEL	5/JUN/00	30/JUN/00	26/JUL/00	24/AUG/00	38
0	214	20	20	0				SUBMIT CRANE	5/JUN/00	30/JUN/00	7/JUL/00	3/AUG/00	23
0	216	20	20	0				SUBMIT IAR JOISTS	5/JUN/00	30/JUN/00	11/AUG/00	8/SEP/00	48
0	218	20	20	0				SUBMIT SIDING	5/JUN/00	30/JUN/00	7/AUG/00	18/SEP/00	44
0	220	20	20	0				SUBMIT PLANT ELECTRICAL LOAD CENTER	5/JUN/00	30/JUN/00	9/JUN/00	7/JUL/00	4
0	222	20	20	0				SUBMIT POWER PANELS - PLANT	5/JUN/00	30/JUN/00	19/JUL/00	15/AUG/00	31
0	224	20	20	0				SUBMIT EXTERIOR DOORS	5/JUN/00	30/JUN/00	27/JUL/00	23/AUG/00	37
0	225	30	30	0				SUBMIT PLANT ELECTRICAL FIXTURES	5/JUN/00	17/JUL/00	27/JUL/00	7/SEP/00	37
0	227	20	20	0				SUBMIT PLANT HEATING AND VENTILATING FANS	5/JUN/00	30/JUN/00	3/AUG/00	30/AUG/00	42
0	229	20	20	0				SUBMIT BOILER	5/JUN/00	30/JUN/00	22/SEP/00	19/OCT/00	77
0	231	20	20	0				SUBMIT OIL TANK	5/JUN/00	30/JUN/00	14/NOV/00	12/DEC/00	114
0	233	40	40	0				SUBMIT PRECAST	5/JUN/00	31/JUL/00	11/AUG/00	6/OCT/00	48
0	235	30	30	0				SUBMIT PACKAGED A/C	5/JUN/00	17/JUL/00	15/JUN/00	27/JUL/00	8
1	2	2	2	0			1	2 SURVEY AND LAYOUT	8/JUN/00	9/JUN/00	8/JUN/00	9/JUN/00	0
2	3	2	2	0			1	1 ROUGH GRADE	12/JUN/00	13/JUN/00	12/JUN/00	13/JUN/00	0
3	4	15	15	0			1	9 DRILL WELL	14/JUN/00	5/JUL/00	14/JUN/00	5/JUL/00	0
3	5	4	4	0			1	3 WATER TANK FOUNDATIONS	14/JUN/00	19/JUN/00	15/JUN/00	20/JUN/00	1
3	9	10	10	0			1	1 EXCAVATE FOR SEWER	14/JUN/00	27/JUN/00	26/JUN/00	3/JUL/00	4
3	10	3	3	0			1	1 EXCAVATE ELECTRIC MANHOLES	14/JUN/00	14/JUN/00	3/JUL/00	8/JUL/00	13
3	12	6	6	0			1	4 OVERHEAD POLE LINE	14/JUN/00	21/JUN/00	7/JUL/00	14/JUL/00	16
4	5	2	2	0			1	9 INSTALL WELL PUMP	6/JUL/00	7/JUL/00	6/JUL/00	7/JUL/00	0
5	8	8	8	0			1	5 UNDERGROUND WATER PIPING	16/JUL/00	19/JUL/00	16/JUL/00	19/JUL/00	0
6	7	10	10	0			1	110 ERECT WATER TANK	20/JUN/00	30/JUL/00	21/JUN/00	5/JUL/00	1
7	8	10	10	0			1	110 TANK PIPING & VALVES	5/JUL/00	18/JUL/00	6/JUL/00	19/JUL/00	1
8	13	2	2	0			1	110 CONNECT WATER PIPING	20/JUL/00	21/JUL/00	20/JUL/00	21/JUL/00	0
9	11	5	5	0			1	5 INSTALL SEWER AND BACKFILL	28/JUN/00	5/JUL/00	5/JUL/00	11/JUL/00	4
10	11	5	5	0			1	4 INSTALL ELECTRICAL MANHOLES	15/JUN/00	21/JUN/00	5/JUL/00	11/JUL/00	13
11	12	3	3	0			1	4 INSTALL ELECTRICAL DUCT BANK	6/JUL/00	18/JUL/00	12/JUL/00	14/JUL/00	4
12	13	5	5	0			1	4 BULL IN FEEDER	21/JUL/00	17/JUL/00	17/JUL/00	21/JUL/00	0
13	14	1	1	0			2	2 BUILDING LAYOUT	24/JUL/00	24/JUL/00	24/JUL/00	24/JUL/00	0
14	15	10	10	0			2	211 DRIVE AND POOR PILES	25/JUL/00	7/AUG/00	25/JUL/00	7/AUG/00	0
14	23	3	3	0			2	1 EXCAVATE FOR OFFICE BUILDING	25/JUL/00	27/JUL/00	14/NOV/00	30/NOV/00	78
15	16	5	5	0			2	1 EXCAVATE PLANT WAREHOUSE	8/AUG/00	14/AUG/00	8/AUG/00	14/AUG/00	0
16	17	5	5	0			2	3 FOUR PILE CAPS P-W	15/AUG/00	21/AUG/00	15/AUG/00	21/AUG/00	0
17	18	10	10	0			2	3 FORM AND POUR GRADE BEAMS P-W	22/AUG/00	5/SEP/00	22/AUG/00	5/SEP/00	0
18	19	3	3	0			2	1 BACKFILL AND COMPACT P-W	6/SEP/00	8/SEP/00	6/SEP/00	8/SEP/00	0
18	21	5	5	0			2	3 FORM AND POUR RAILROAD LOADING DOCK P-W	6/SEP/00	12/SEP/00	18/SEP/00	22/SEP/00	8
18	22	5	5	0			2	3 FORM AND FOUR TRUCK LOADING DOCK P-W	6/SEP/00	12/SEP/00	18/SEP/00	22/SEP/00	8
19	20	5	5	0			2	5 UNDERSLAB PLUMBING P-W	11/SEP/00	15/SEP/00	11/SEP/00	15/SEP/00	0
20	22	5	5	0			2	4 UNDERSLAB CONDUIT P-W	19/SEP/00	22/SEP/00	18/SEP/00	22/SEP/00	0
21	22	0	0	0					13/SEP/00	12/SEP/00	25/SEP/00	22/SEP/00	8
22	29	10	10	0			2	3 FORM AND POUR SLABS P-W	25/SEP/00	6/OCT/00	25/SEP/00	6/OCT/00	0
23	24	4	4	0			2	3 SPREAD FOOTINGS OFFICE	11/SEP/00	18/SEP/00	6/NOV/00	9/NOV/00	38
24	25	6	6	0			2	3 FORM AND POUR GRADE BEAMS OFFICE	19/SEP/00	26/SEP/00	10/NOV/00	17/NOV/00	38
25	26	1	1	0			2	1 BACKFILL AND COMPACT OFFICE	27/SEP/00	27/SEP/00	20/NOV/00	20/NOV/00	38

Figure 10.3.1 *i-j* sort of initial baseline of John Doe project.

similar to the CPM printout with restraints deleted. (In fact, CPM outputs can have any activities, including restraints, suppressed to simplify the volume of output.) Although the output is simple in appearance, it cannot be used in this form to track a path through the diagram.

In a field situation, in which the master network and printouts are in PDM format, a CPM-oriented contractor scheduler complained that he could not match the PDM output with the diagram. The PDM project manager scheduler retorted, "Of course not, only I can do that." What the



O'BRIEN KREITZBERG & ASSOC., INC.				PRIMAVERA PROJECT PLANNER		JOHN DOE PROJECT PDM VERSION				
REPORT DATE				CPM IN CONSTRUCTION MANAGEMENT - 5TH EDITION		START DATE 5JUN00		FIN DATE 20JUL01		
Classic Schedule Report - Sort by Activity ID						DATA DATE	5JUN00	PAGE NO.	1	
ACTIVITY ID	ORIG DUR	REM DUR	%	CODE	ACTIVITY DESCRIPTION	EARLY START	EARLY FINISH	LATE START	LATE FINISH	TOTAL FLOAT
0	0	0	0		START MILESTONE	5JUN00		5JUN00		0
1	2	2	0	1 2	SURVEY AND LAYOUT	8JUN00	9JUN00	12JUN00	13JUN00	2
2	2	2	0	1 1	ROUGH GRADE	12JUN00	13JUN00	14JUN00	15JUN00	2
3	15	15	0	1 9	DRILL WELL	14JUN00	5JUL00	16JUN00	7JUL00	2
4	2	2	0	1 3	INSTALL WELL PUMP	6JUL00	7JUL00	10JUL00	11JUL00	2
5	8	8	0	1 5	UNDERGROUND WATER PIPING	10JUL00	19JUL00	12JUL00	21JUL00	2
6	10	10	0	110	ERECT WATER TANK	20JUN00	3JUL00	23JUN00	7JUL00	3
7	10	10	0	110	TANK PIPING & VALVES	5JUL00	10JUL00	10JUL00	21JUL00	3
8	2	2	0	110	CONNECT WATER PIPING	20JUL00	21JUL00	24JUL00	25JUL00	2
9	5	5	0	1 5	INSTALL SEWER AND BACKFILL	28JUN00	5JUL00	7JUL00	13JUL00	6
10	5	5	0	1 4	INSTALL ELECTRICAL MANHOLES	15JUN00	21JUN00	7JUL00	13JUL00	15
11	3	3	0	1 4	INSTALL ELECTRICAL DUCT BANK	6JUL00	10JUL00	14JUL00	18JUL00	6
12	5	5	0	1 4	PULL IN FEEDER	11JUL00	17JUL00	19JUL00	25JUL00	6
13	1	1	0	2 2	BUILDING LAYOUT	24JUL00	24JUL00	26JUL00	26JUL00	2
14	10	10	0	211	DRIVE AND POUR PILES	25JUL00	7AUG00	27JUL00	9AUG00	2
15	5	5	0	2 1	EXCAVATE PLANT WAREHOUSE	8AUG00	14AUG00	10AUG00	16AUG00	2
16	5	5	0	2 3	POUR PILE CAPS P-W	15AUG00	21AUG00	17AUG00	23AUG00	2
17	10	10	0	2 3	FORM AND POUR GRADE BEAMS P-W	22AUG00	5SEP00	24AUG00	7SEP00	2
18	3	3	0	2 1	BACKFILL AND COMPACT P-W	6SEP00	8SEP00	8SEP00	12SEP00	2
19	5	5	0	2 5	UNDERSLAB PLUMBING P-W	11SEP00	15SEP00	13SEP00	19SEP00	2
20	5	5	0	2 4	UNDERSLAB CONDUIT P-W	18SEP00	22SEP00	20SEP00	26SEP00	2
22	10	10	0	2 3	FORM AND POUR SLABS P-W	25SEP00	6OCT00	27SEP00	10OCT00	2
23	4	4	0	2 3	SPREAD FOOTINGS OFFICE	13SEP00	18SEP00	13SEP00	18SEP00	0
24	6	6	0	2 3	FORM AND POUR GRADE BEAMS OFFICE	19SEP00	26SEP00	19SEP00	26SEP00	0
25	1	1	0	2 1	BACKFILL AND COMPACT OFFICE	27SEP00	27SEP00	27SEP00	27SEP00	0
26	3	3	0	2 5	UNDERSLAB PLUMBING OFFICE	28SEP00	20OCT00	28SEP00	20OCT00	0
27	3	3	0	2 4	UNDERSLAB CONDUIT OFFICE	30CT00	50CT00	30CT00	50CT00	0
28	3	3	0	2 3	FORM AND POUR SLABS OFFICE	6OCT00	10OCT00	6OCT00	10OCT00	0
29	10	10	0	3 6	ERECT STRUCTURAL STEEL P-W	11OCT00	24OCT00	11OCT00	24OCT00	0
30	5	5	0	3 6	PLUMB AND BOLT STEEL P-W	25OCT00	31OCT00	25OCT00	31OCT00	0
31	5	5	0	3 6	ERECT CRANEWAY AND CRANE P-W	1NOV00	7NOV00	1NOV00	7NOV00	0
33	3	3	0	3 6	ERECT BAR JOISTS P-W	8NOV00	10NOV00	8NOV00	10NOV00	0
34	3	3	0	3 7	ERECT ROOF PLANKS P-W	13NOV00	15NOV00	13NOV00	15NOV00	0
35	10	10	0	312	ERECT SIDING P-W	16NOV00	30NOV00	16NOV00	30NOV00	0

Figure 10.3.2 John Doe project PDM printout.

project manager really meant was that the contractor scheduler had not been given sufficient output to understand the PDM. In effect, the basic output is a *scheduling directive*, not a scheduling tool for mutual use.

Figure 10.3.3 presents the John Doe PDM master output with predecessors. This output demonstrates that the purportedly simple PDM can become cumbersome when presented in usable form.

# 156 The Theory of CPM Planning and Scheduling

O'BRIEN KREITZBERG & ASSOC., INC.				PRIMAVERA PROJECT PLANNER		JOHN DOE PROJECT PDM VERSION				
REPORT DATE 1SEP98		RUN NO. 19		CPM IN CONSTRUCTION MANAGEMENT - 5TH EDITION		START DATE 5JUN00		FIN DATE 20JUL01		
Schedule Report - Predecessors & Successors						DATA DATE 5JUN00 PAGE NO. 1				
ACTIVITY ID	ORIG	REB	DUR	CODE	ACTIVITY DESCRIPTION	EARLY START	EARLY FINISH	LATE START	LATE FINISH	TOTAL FLOAT
	0	0	0		START MILESTONE	5JUN00		5JUN00		0
..	100*	3	3	0 SU	CLEAR SITE	5JUN00	7JUN00	7JUN00	9JUN00	2
..	110*	10	10	0 SU	SUBMIT FOUNDATION REBAR	5JUN00	16JUN00	6JUL00	19JUL00	22
..	112*	20	20	0 SU	SUBMIT STRUCTURAL STEEL	5JUN00	30JUN00	5JUN00	30JUN00	0
..	114*	20	20	0 SU	SUBMIT CRANE	5JUN00	30JUN00	11JUL00	7AUG00	25
..	116*	20	20	0 SU	SUBMIT BAR JOISTS	5JUN00	30JUN00	15AUG00	12SEP00	50
..	118*	20	20	0 SU	SUBMIT SIDING	5JUN00	30JUN00	9AUG00	6SEP00	46
..	120*	20	20	0 SU	SUBMIT PLANT ELECTRICAL LOAD CENTER	5JUN00	30JUN00	13JUN00	11JUL00	6
..	122*	20	20	0 SU	SUBMIT POWER PANELS - PLANT	5JUN00	30JUN00	21JUL00	17AUG00	33
..	124*	20	20	0 SU	SUBMIT EXTERIOR DOORS	5JUN00	30JUN00	15JUN00	13JUL00	8
..	125*	30	30	0 SU	SUBMIT PLANT ELECTRICAL FIXTURES	5JUN00	17JUL00	15JUN00	27JUL00	8
..	127*	20	20	0 SU	SUBMIT PLANT HEATING AND VENTILATING FANS	5JUN00	30JUN00	7AUG00	15EP00	44
..	129*	20	20	0 SU	SUBMIT BOILER	5JUN00	30JUN00	26SEP00	23OCT00	79
..	131*	20	20	0 SU	SUBMIT OIL TANK	5JUN00	30JUN00	16NOV00	14DEC00	116
..	133*	40	40	0 SU	SUBMIT PRECAST	5JUN00	31JUL00	29NOV00	25JAN01	124
..	135*	30	30	0 SU	SUBMIT PACKAGED A/C	5JUN00	17JUL00	3OCT00	19NOV00	84
..	100*	3	3	0 FR	CLEAR SITE	5JUN00	7JUN00	7JUN00	9JUN00	2
	1	2	2	0	1 SURVEY AND LAYOUT	8JUN00	9JUN00	12JUN00	13JUN00	2
	2*	2	2	0 SU	ROUGH GRADE	12JUN00	13JUN00	14JUN00	15JUN00	2
..	1*	2	2	0 FR	SURVEY AND LAYOUT	8JUN00	9JUN00	12JUN00	13JUN00	2
	2	2	2	0	1 ROUGH GRADE	12JUN00	13JUN00	14JUN00	15JUN00	2
..	3*	15	15	0 SU	DRILL WELL	14JUN00	5JUL00	16JUN00	7JUL00	2
..	401*	4	4	0 SU	WATER TANK FOUNDATIONS	14JUN00	19JUN00	19JUN00	22JUN00	3
..	402*	10	10	0 SU	EXCAVATE FOR SEWER	14JUN00	27JUN00	22JUN00	6JUL00	15
..	403*	1	1	0 SU	EXCAVATE ELECTRIC MANHOLES	14JUN00	14JUN00	6JUL00	6JUL00	6
..	404*	6	6	0 SU	OVERHEAD POLE LINE	14JUN00	21JUN00	11JUL00	18JUL00	18
..	2*	2	2	0 FR	ROUGH GRADE	12JUN00	13JUN00	14JUN00	15JUN00	2
	3	15	15	0	1 DRILL WELL	14JUN00	5JUL00	16JUN00	7JUL00	2
..	4*	2	2	0 SU	INSTALL WELL PUMP	6JUL00	7JUL00	10JUL00	11JUL00	2
..	3*	15	15	0 FR	DRILL WELL	14JUN00	5JUL00	16JUN00	7JUL00	2
	4	2	2	0	1 INSTALL WELL PUMP	6JUL00	7JUL00	10JUL00	11JUL00	2
..	5*	8	8	0 SU	UNDERGROUND WATER PIPING	10JUL00	19JUL00	12JUL00	21JUL00	2
..	4*	2	2	0 FR	INSTALL WELL PUMP	6JUL00	7JUL00	10JUL00	11JUL00	2
	5	8	8	0	1 UNDERGROUND WATER PIPING	10JUL00	19JUL00	12JUL00	21JUL00	2
..	8*	2	2	0 SU	CONNECT WATER PIPING	20JUL00	21JUL00	24JUL00	25JUL00	2
..	401*	4	4	0 FR	WATER TANK FOUNDATIONS	14JUN00	19JUN00	19JUN00	22JUN00	3
	6	10	10	0	1 ERECT WATER TANK	20JUN00	3JUL00	23JUN00	7JUL00	3
..	7*	10	10	0 SU	TANK PIPING & VALVES	5JUL00	18JUL00	10JUL00	21JUL00	3

Figure 10.3.3 John Doe project PDM output with all precedence activities.

## 10.4. Project Example

Figure 10.4.1 is a sample project network consisting of 34 work items. The work item identification numbers identify work items by functions. For instance, concrete items are grouped in the 300 series, and the electrical items are in the 700 series.

The networks indicate interrelations between work items and also options having to do with lag time factors. Three of the four lag time

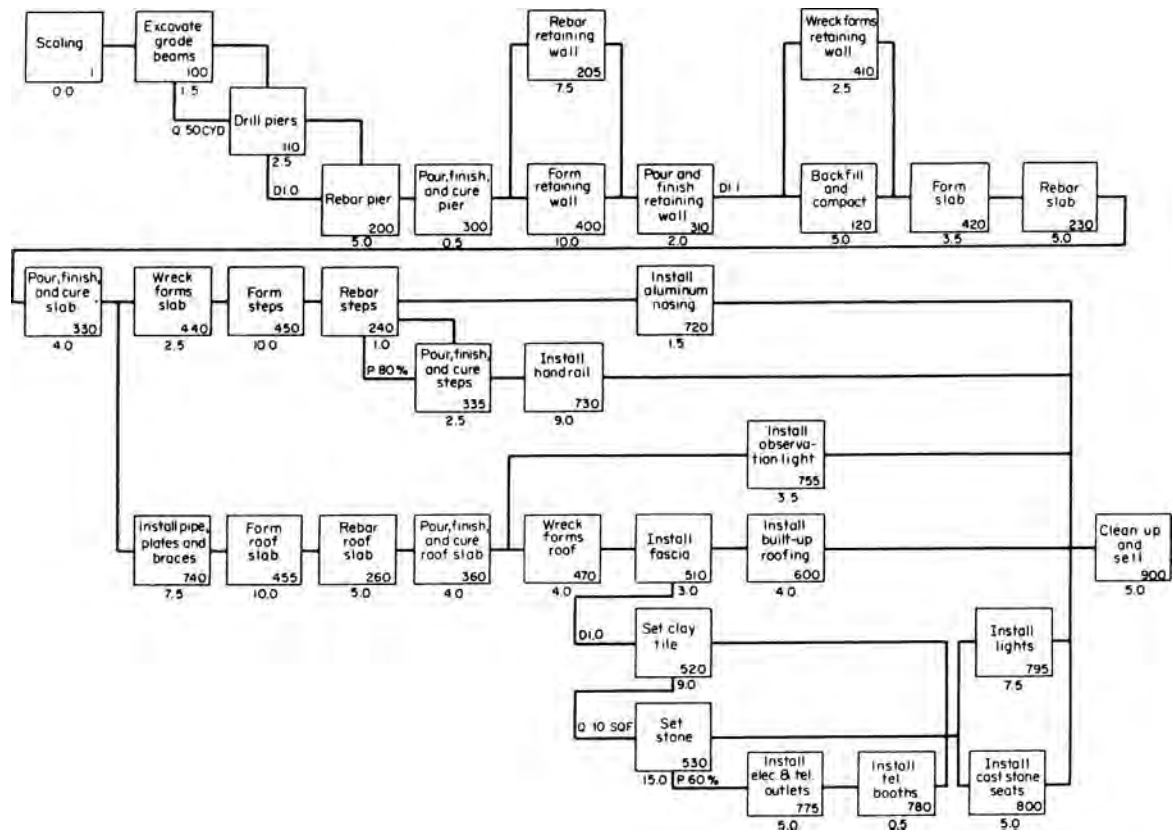

Figure 10.4.1 Precedence example.

JOB NO. 1440		*** EARLY START ***						4 MAY		PAGE 1		
WORK ITEM	DESCRIPTION	DURATH	REMAIN DURATH	PC	CAL HR	FC S D	EARLY START	LATE START	EARLY FINISH	LATE FINISH	TOTAL SLACK	FREE SLACK
* 100	EXCAVATE GRADE BEAMS	1.5	1.5		8 1 5		4MAY	4MAY	5MAY	5MAY	.0	.0
* 1	WORK ITEM FOR SCALING CALENDAR	.0	.0		8 1 5		4MAY	4MAY	4MAY	4MAY	.0	.0
* 110	DRILL PIERS	2.5	2.5		8 1 5		4MAY	4MAY	6MAY	6MAY	.0	LAG
* 200	REBAR PIER	5.0	5.0		8 1 5		5MAY	5MAY	12MAY	12MAY	.0	LAG
* 300	POUR, FINISH AND CURE PIER	.5	.6		8 1 7		12MAY	12MAY	12MAY	12MAY	.0	.0
* 400	FORM RETAINING WALL	10.0	10.0		8 1 5		12MAY	12MAY	26MAY	26MAY	.0	.0
205	REBAR RETAINING WALL	7.5	7.5		8 1 5		12MAY	15MAY	22MAY	26MAY	2.5	2.5
* 310	POUR AND FINISH RETAINING WALL	2.0	2.0		8 1 5		26MAY	26MAY	28MAY	28MAY	.0	.0
* 120	BACKFILL AND COMPACT	5.0	5.0		8 1 5		1JUN	1JUN	8JUN	8JUN	.0	LAG
410	WRECK FORMS RETAINING WALL	2.5	2.5		8 1 5		1JUN	4JUN	4JUN	8JUN	2.5	LAG
* 420	FORM SLAB	3.5	3.5		8 1 5		8JUN	8JUN	12JUN	12JUN	.0	.0
* 230	REBAR SLAB	5.0	5.0		8 1 5		12JUN	12JUN	19JUN	19JUN	.0	.0
* 330	POUR, FINISH AND CURE SLAB	4.0	4.1		-714		19JUN	19JUN	24JUN	24JUN	.0	.0
* 740	INSTALL PIPE, PLATES AND BRACES	7.5	7.5		8 1 5		24JUN	24JUN	6JUL	6JUL	.0	.0
440	WRECK FORMS SLAB	2.5	2.5		8 1 5		24JUN	11AUG	26JUN	14AUG	33.3	.0
450	FORM STEPS	10.0	10.0		8 1 5		26JUN	14AUG	13JUL	28AUG	33.3	.0
* 455	FORM ROOF SLAB	10.0	10.0		8 1 5		6JUL	6JUL	20JUL	20JUL	.0	.0
240	REBAR STEPS	1.0	1.0		8 1 5		13JUL	28AUG	14JUL	31AUG	33.3	.0
335	POUR, FINISH AND CURE STEPS	2.5	2.5		-714		14JUL	28AUG	16JUL	15SEP	33.3	LAG
720	INSTALL ALUMINUM HOISING	1.5	1.5		8 1 5		14JUL	14SEP	16JUL	15SEP	42.4	42.4
730	INSTALL HAND RAIL	9.0	9.0		8 1 5		16JUL	15SEP	29JUL	15SEP	33.3	33.3
* 260	REBAR ROOF SLAB	5.0	5.0		8 1 5		20JUL	20JUL	27JUL	27JUL	.0	.0
* 360	POUR, FINISH AND CURE ROOF SLAB	4.0	4.1		-714		27JUL	27JUL	30JUL	30JUL	.0	.0
* 470	WRECK FORMS ROOF	4.0	4.0		8 1 5		30JUL	30JUL	5AUG	5AUG	.0	.0
755	INSTALL OBSERVATION LIGHT	3.5	3.5		8 1 5		30JUL	10SEP	5AUG	15SEP	28.5	28.5
* 510	INSTALL FASCIA	3.0	3.0		8 1 5		5AUG	5AUG	10AUG	10AUG	.0	.0
* 520	SET CLAY TILE	9.0	9.0		8 1 5		6AUG	6AUG	19AUG	19AUG	.0	LAG

Figure 10.4.2 Precedence output, early start sort (partial).

options have been included in the network. Duration for work items is shown in the small boxes under the work items.

The network indicates that the drilling of piers (work item 110) may begin after 50 yd<sup>3</sup> of excavation has been completed in work item 100. This is represented by the line leading from 100 to 110, which shows that part of the duration of work item 110 may be concurrent with work item 100. The estimated quantity of work item 100 is 150 yd<sup>3</sup>, so work item 100 may start after approximately 33% of the excavation operation has been done or, in direct proportion, after half a day has elapsed. The top line leading from work item 100 to work item 110 indicates that the second work item cannot be completed until at least half a day after the completion of the first work item 100.

The rebar of pier 200 is shown to begin at least 1 day following the start of drilling the piers. This is shown by a lag time of 1 day on the connecting line. The relation of work items 205 and 400 to item 300 and following work item 310 is very similar to the other diagramming relation showing concurrent activity.

Between work items 310 and 410, a delay of 1 day is shown. The lag permits 1 day of curing before the form stripping is started, and it could have been included by adding one more day to work item 310 or by introducing a work item 311 called *initial cure*. A CPM network can duplicate the delay and lag options in the precedence network, but additional arrows or activities are required.

The work item report is a listing printed in early start sequence (Figure 10.4.2). In addition to the obvious descriptive material, the PC column in Figure 10.4.2 contains the amount of the operation completed in shift, shifts per day, and days per week of the calendar factor. Precedence programs will accept schedule dates and, therefore, can produce negative slack.

## 10.5. Summary

PERT has virtually disappeared from the construction scheduling scene, but PDM use has grown dramatically. A more recent comer than CPM, it offers the appeal of newness. Susceptible to ready adjustment and fine-tuning, it can be readily utilized by a sophisticated scheduler.

Much has been claimed for the simplicity PDM offers in regard to both network diagrams and printouts, but as in tip-of-the-iceberg cases, more is hidden than seen in many PDM schedules.

*This page intentionally left blank*

## Respecting the Power of PDM

We have all heard stories of how the modern computer is like the mythical genie, that is, it does exactly what you tell it rather than what you actually want it to do. One of the advantages of the ADM (Arrow Diagramming Method) methodology is that in its stark simplicity, it forces the user to say exactly what he or she wants. The simple rule of ADM, that each activity may start only after its predecessors are finished, is easily understood. Moreover, although differing practitioners and writers of computer software may try to “add” features to ADM, the basic precepts of the methodology are difficult to abuse.

PDM (Precedence Diagramming Method) is the much more powerful system; so powerful that its inner workings are rarely understood by the user. One of the most cited advantages of PDM is its use of lead and lag factors, or more succinctly, duration between activities or portions thereof to supplement the information given by the duration of an activity. Unfortunately, there does not exist a universally agreed set of definitions relating to what is meant by lead and lag factors. One result of this lack is that various software vendors may each use a differing definition without even realizing the problem.

### 11.1. Durations between Activities: Percent Lead/Lag Relationships

As an example, let us look at the simplest lead/lag relationship: Activity B is to start after 50 percent of A is complete. This is often the exact language of the project manager or superintendent and what was said is what was meant. However, popular software tools available cannot accept that relationship as stated. To say that activity B is to start 5 days after the start of a 10-day activity A is not the same as saying that activity B is to

Start B after 50% of A is complete

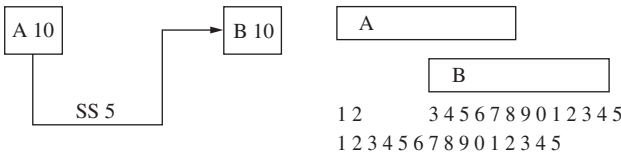

Figure 11.1.1 Ambiguous language of PDM.

start 5 days before activity A is calculated (expected) to finish. Neither is it the same as saying that activity B is to start when 5 days of activity A are performed. None of these approximations and “fudges” is the same as use of the percentile provided by the project manager, and as noted in Chapter 9.3, the definition of percent complete is also somewhat vague.

Assume that both A and B have original durations of 10. To enter this information into commercially available software systems, you might state that A and B are connected by a start-to-start relationship with a lag factor of 5, as shown in Figure 11.1.1. The computer relentlessly will accept what we just said and perform its calculations accordingly, but it is not correct.

What we have just stated is *not* that Activity B may start after 50 percent of activity A is *complete* (or having achieved 5 days of *progress*), but rather that Activity B may start 5 days after Activity A has *started* (or having achieved 5 days of *passage*). This misunderstanding can have several unintended consequences.

What if actual progress on activity A is better than anticipated? If on day 4 we report that activity A is 50 percent done (5 days progress and 5 days remaining duration), we would then need to adjust the start and completion dates of all successors of A. In fact, such information will impact only those successors of A following A’s completion. Although we thought we told the computer to start after A is 50 percent done, which now is day 5, the computer will blindly schedule activity B to be incapable of starting until day 6, as shown in Figure 11.1.2. Similarly, if on day 5 we report that activity A is only 20 percent complete (2 days progress and

Start B after 50% of A is complete



Day 5 data day

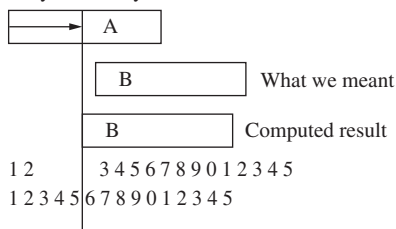

Figure 11.1.2 Ambiguous language of PDM.



8 days remaining duration), the computer will blindly schedule activity B to start on day 6 rather than properly reporting that the start of activity B will be delayed until day 8. This illustrates only one of the many “sources of misunderstanding” common in PDM. And as different practitioners and computer software writers add features to the basic system, additional interpretations and misunderstandings will occur.

## 11.2. Defining Overlapping Activities: Durations between Activities

As discussed in Chapter 10, PDM permits logic relationships other than *FS*. Some of the relationships available in theory and supported to varying degrees by software vendors are shown in Table 11.2.1. If lag factors are included, or the number of time units between, say the finish of A and start of B, the possible number of relationships expands, as illustrated in Table 11.2.2. The distinctions between some of these types of relationships may appear obscure, but as shown in Table 11.2.3, the same problem can have differing results based upon which type of start-to-start or finish-to-finish relationship is used.

The MSCS program (Management Scheduling and Control System by McDonnell-Douglas Aircraft Co.), written in the 1960s to run on a main-frame computer, understood some of these nuances and had separate codes for two types of lag, passage and progress. However, the differences between their designations of the start-to-start and the begin-to-begin codes and the finish-to-finish and end-to-end codes were poorly documented and subject to misinterpretation.

The list of Table 11.2.2 is not complete. Referring back to Figure 10.4.1 suggests a restraint based upon measured units performed or installed, such as between Activity 100 and 110 or 520 and 530, which call for the second activity to start after 0.50 cubic yards of excavation and 0.10 square feet of clay tile are respectively complete. This is the information that would be provided by the project superintendent performing the work. In ADM, this information may be retained. In PDM, as supported by commercial software, the conversion of 0.50 CY to a start-plus-lag-to-start format will not convey this information to the project team.

The migration of software to microcomputers in the 1980s entailed, at that time, severe memory limitations and resulted in the progress definitions being dropped from many software programs. Lag measuring

**TABLE 11.2.1** Types of PDM Relationships

FS	Finish to Start	Activity B may Start after Activity A is Finished
SS	Start to Finish	Activity B may Start after Activity A is Started
FF	Finish to Finish	Activity B may Finish after Activity A is Finished
SF	Start to Finish	Activity B may Finish after Activity A is Started

**TABLE 11.2.2 Explanded Set of PDM Relationships**

RDM	P3	MSCS	Formula	Description
FS	FS	C	$ES_b = EF_a + Lag_{ab}$	FINISH to START Progress FS “n” Finish to Start B may start “n” units after duration of A is reduced to zero
ES	FS*		$ES_b = AF_a + Lag_{ab}$	END to START Passage FS “n” Finish to Start B may start “n” units after A reported finished
SS	SS	B	$ES_b = ES_a + Lag_{ab}$	START to START Passage SS “n” Start to Start B may start “n” units after the Early Start of remainder of A, if A reported started
BS	SS*		$ES_b = AS_a + Lag_{ab}$	BEGINNING to START Passage SS “n” Start to Start B may start “n” units after A reported started
PS	—	S	for $Lag_{ab} \geq OD_a$ ; $ES_b = ES_a - OD_a + RD_a + Lag_{ab}$	PROCESSED to START Progress SS “n” Start to Start B may start after duration of A is reduced by “n” units
RS	—	—	for $Lag_{ab} \geq OD_a$ ; $ES_b = ES_a + RD_a - Lag_{ab}$	REMAINING to START Progress SS “n” Start to Start B may start after duration of A is reduced to “n” units
FF	FF	E	$EF_b = EF_a + Lag_{ab}$	FINISH to FINISH Passage FF “n” Finish to Finish B may finish “n” units after A is reported finished
EF	FF*		$EF_b = AF_a + Lag_{ab}$	END to FINISH Passage FF “n” Finish to Finish B may finish “n” units after A is reported finished

FR	—	F	for $Lag_{ab} \geq OD_a$ ; $EF_b = EF_a + \min(RD_b, Lag_{ab})$	FINISH to REMAINDER Progress FF “n” Finish to Finish B may finish “n” units after duration of A is reduced to zero
FP	—	—	for $Lag_{ab} \geq OD_a$ ; $EF_b = EF_a + \min(RD_b, (OD_b - Lag_{ab}))$	FINISH to PROGRESSED Progress FF “n” Finish to Finish B may continue beyond “n” units to finish after duration of A is reduced to zero
SF	SF	W	$EF_b = ES_a + Lag_{ab}$	START to FINISH Passage SF “n” Start to Finish B may finish “n” units after Early Start of remainder of A, if A reported started
BF	SF*		$EF_b = AS_a + Lag_{ab}$	Passage SF “n” Start to Finish B may finish “n” units after A reported started
PR	—	—	for $Lag_{ab} \geq OD_a$ and $Lag_{ab} \geq OD_b$ ; $EF_b = ES_a - OD_a + RD_a + Lag_{ab1} + \min(RD_b, Lag_{ab2})$ NOTE TWO LAGS ARE REQUIRED	PROGRESSED to REMAINDER Progress SF “n” “m” Start to Finish B may finish “m” units after duration of A is reduced by “n” units
RR	—	—	for $Lag_{ab} \geq OD_a$ and $Lag_{ab} \geq OD_b$ ; $EF_b = ES_a + RD_a - Lag_{ab1} + \min(RD_b, Lag_{ab2})$ NOTE TWO LAGS ARE REQUIRED	REMAINDER to REMAINDER Progress SF “n” “m” Start to Finish B may finish “m” units after duration of A is reduced to “n” units
RP	—	—	for $Lag_{ab} \geq OD_a$ and $Lag_{ab} \geq OD_b$ ; $EF_b = ES_a + RD_a - Lag_{ab1} + \min(RD_b, (OD_b - Lag_{ab2}))$ NOTE TWO LAGS ARE REQUIRED	REMAINDER to PROGRESSED Progress SF “n” “m” Start to Finish B may continue beyond “m” units after duration of A is reduced to “n” units
PP	—	—	for $Lag_{ab} \geq OD_a$ and $Lag_{ab} \geq OD_b$ ; $EF_b = ES_a - OD_a + RD_a + Lag_{ab1} + \min(RD_b, (OD_b - Lag_{ab2}))$ NOTE TWO LAGS ARE REQUIRED	PROGRESSED to PROGRESSED Progress SF “n” “m” Start to Finish B may continue beyond “m” units after duration of A is reduced by “n” units

TABLE 11.2.3 Differing Results Based upon Choice of Relationship Code.

Graphic	Code	Formula	Calculation
	PS	$ES_b = ES_a - OD_a + RD_a + Lag_{ab}$	$10 - 10 + 5 + 7 = 12$
	SS	$ES + Lag$	$10 + 7 = 17$
	BS	$AS + Lag$	$6 + 7 = 13$
	FR	$EF_b + EF_a + \min(RD_b, Lag_{ab})$	$20 + \min(6, 7) = 26$
	FF	$EF + Lag$	$20 + 7 = 27$
	EF	$AF + Lag$	$18 + 7 = 25$

Example for Start-to-Start: Activity A has 10 day original duration, started on day 6, has 5 days remaining duration. It is linked to Activity B by a Start-to-Start restraint with a 7 day lag. Activity B has a 8 day original duration. The update is on day 10.

- PS algorithm starts at early start (data date) and reduces lag by 5 days to match the 5 day reduction in activity duration, with resulting calculation of early start of B being day 12.
- SS algorithm starts at early start (data date) and adds 7 days lag (unless lag is reduced by update input,) with resulting calculation of early start of B being day 17.
- BS algorithm starts at actual start date recorded as day 6 and adds 7 days lag, with resulting calculation of early start of B being day 13

Example for Finish-to-Finish: Activity A was started on day 6 and finished on day 18. It is linked to Activity B by a Finish-to-Finish restraint with a 7 day lag. Activity B has a 8 day original duration, started on day 15 and still has 6 days remaining duration. The update is on day 20.

- FR algorithm starts at early start (data date) plus zero remaining duration of Activity A and then reduces lag by 2 days to match the 2 day reduction in Activity B duration, with resulting calculation of early finish of B being day 26.
- FF algorithm starts at early start (data date) plus zero remaining duration of Activity A and adds 7 days lag (unless lag is reduced by update input,) with resulting calculation of early finish of B being day 27.
- EF algorithm starts at actual finish date recorded as day 18 and adds 7 days lag, with resulting calculation of early finish of B being day 25.

days passage rather than days progress continues to mystify and plague users of scheduling software today. One example often encountered is when project personnel updating a schedule enter a percent complete or remaining duration for an activity, but do not have the time or information to note the start and completion dates for that activity.

This can create a problem if the network includes nontraditional relationships. Assume Activity A had a 10-day duration and a SS relationship with a 5-day lag to Activity B. Assume Activity A now is 99.9 percent complete and has a remaining duration of 0, but that an actual start date has not been entered. Now we update and reschedule. The computer does exactly what it is told. Five days after the reported start date, or since there is none, 5 days after the data date, Activity B can start (Figure 11.2.1).

These special, nontraditional relationships require that start and finish dates are entered to properly calculate the schedule. So although

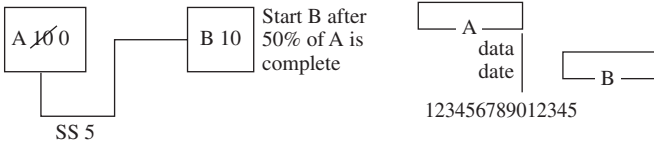

Figure 11.2.1 Updating the PDM network.

the software will allow the user to enter progress without reporting actual start and finish dates, if the network has relationships other than the traditional *FS*s, incorrect results can be calculated.

Even without the additional problems caused by including reported actual start and finish dates in the calculation algorithms, additional effort is required to update networks that include nontraditional relationships with lags. In fact, many software products do not include the measurement of lag from a reported actual start date but instead measure from the latest data date. Some programs, such as Primavera, permit the user to choose whether to measure from the actual start or early start (being the data date for the first activity not already completed; Figure 11.2.2).

If actual dates are not used, then the lag must be manually updated whenever the duration of an activity is updated. Here, even if an activity

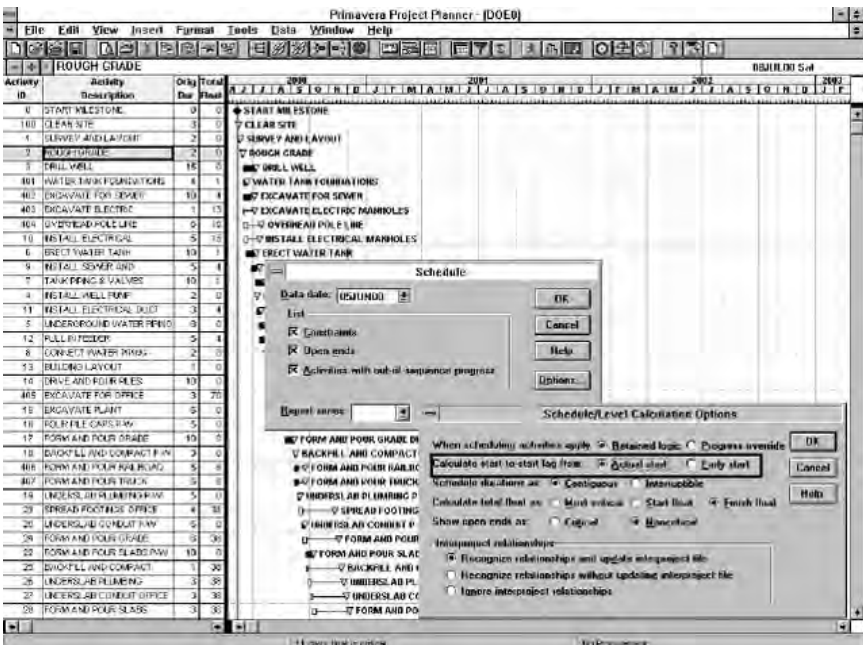

Figure 11.2.2 Actual start versus early start options.

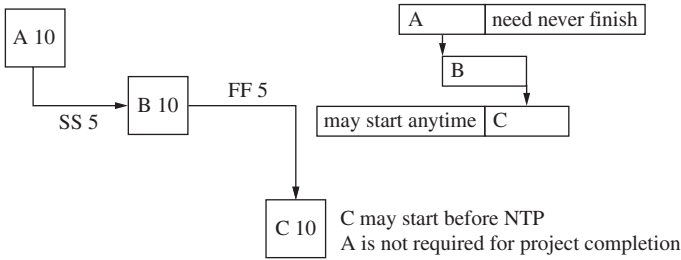

Figure 11.2.3 Orphaned relationships.

is started, completed, has reported actual start and finish dates, a remaining duration of 0 and percent complete of 100 percent, if the lag is not manually reduced to 0, successor activities will be scheduled based on the data date plus the lag. The computer will accept what we just said and perform its calculations accordingly.

Another common problem with nontraditional logic relationships is their failure to ensure that each activity has a predecessor before its start and a successor after its finish. This problem is exacerbated with advanced software that plots the activity as a bar on the computer screen when data relating to the activity is entered.

Reviewing Figure 11.2.3, if Activity A is connected to successors only by means of start-to-start relationships, then its finish is not required according to the logic of the network. Similarly, if Activity C is connected to predecessors only by means of finish-to-finish relationships, then it may start at any time, even before the notice to proceed, beginning with the first day in the project calendar.

Some software programs address this problem. For example, the MSCS program, with a combination or joint relationship code, used a “Z” code to combine a start-to-start and a finish-to-finish relationship with similar lag. Since this is a popular use of nontraditional relationships, it allows this combination relationship to be designated with one entry and reduces the chance of creating orphan activity starts or finishes.

Note that the example given in Figure 11.2.4 will only properly work if the duration of A and B are the same, keeping the two activities in lockstep. If the two durations are not the same, one of the two relationships will be overridden by the other. For example, assume that two

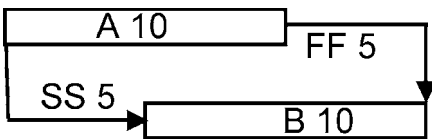
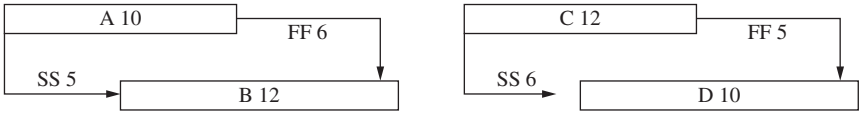

Figure 11.2.4 “SS5” + “FF5” code equals MSCS “Z5” code.



**Figure 11.2.5** Passage type of lags. Note only one lag will drive second activity if durations are not equal.

activities of unequal duration are linked with the instruction that the second may start when the first is 50 percent complete and the first must finish before the final 50 percent of the second can be accomplished. In Figure 11.2.5, the total duration of A plus B is the greater of  $10 + 6 = 16$  or  $5 + 12 = 17$ . Thus, the FF6 lag may be ignored in the initial schedule. However, if A takes longer than expected and has an actual duration of 15, B may still be expected to start 5 days after the start of A, but will not be able to finish until  $15 + 6 = 21$  days after the start of A.

Similarly, the total duration of C plus D is the greater of  $12 + 5 = 17$  or  $6 + 10 = 16$ . Thus the SS6 lag may be ignored in the initial schedule. If the actual duration of C is better than expected, the SS6 lag may become the driving relationship.

The two examples also highlight an important point that may be missed if the lags measure passage of time rather than progress of reducing the original duration of the activities. The expressed wording of the project manager is that the SS lag relates to the first activity and the FF lag relates to the second activity. This is more clearly depicted in Figure 11.2.6, which displays the lags as progress in reducing the original duration. Unlike the example in the prior figure, here the start of B will be earlier if A is performed faster than anticipated. Similarly, for a progress style lag, should activity D start and progress partially out of sequence such that it has only a remaining duration of 4 by the time C is complete, the lag will likewise be reduced from 5 to 4 days.

Because the SS lag relates to the predecessor activity while the FF lag relates to the successor activity, a special problem exists for the SF relationship. If we assign to a SF relationship a passage type of lag, the lag merely represents how the two bars line up on the bar chart. On the other hand, if we assign to a SF relationship a progress type of lag, we need two lags, one to measure from the start of A and the second to measure to the end of B, as shown in Figure 11.2.7.



**Figure 11.2.6** Progress type of lags.

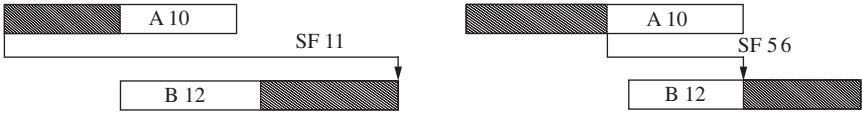

Figure 11.2.7 Examples of passage versus progress type of start-to-finish lag.

### 11.3. Negative Durations between Activities

In addition to durations of activities and durations between activities (or lags), there exists yet another possible type of duration in PDM consisting of a negative duration. This may be used to convert the stated, “Activity B may start 3 days before the Activity A is finished” to the lead lag expression “FS -3.” However, even though such a statement may commonly be made, and such a lead/lag may be used to “move the bars on the screen” for the initial schedule printout, the comment and expression are inherently logically flawed.

The actual comment should be heard as “Activity B may start 3 days before the expected finish of Activity A” and the same logical information is better provided by a start-to-start restraint with a lag equal to the original duration minus 3 days. In either case, the actual completion or finish of Activity A is not required by Activity B (nor any other activity unless there are other restraints). Thus, although there appears to be a finish-to-something relationship required by PDM, the reality is that the finish of Activity A is orphaned, as shown in Figure 11.3.1.

Obviously, if the finish-to-start negative lag is greater than the duration of the activity, all that is being accomplished is the movement of bars on the bar chart. Similarly, a start-to-start, or finish-to-finish or start-to-finish relationship with negative lag does not have a physical referent and is “just moving bars.”

### 11.4. Remaining Durations between Activities

The very first enhancement to the Kelley-Walker basic CPM algorithm, discussed in Chapter 9, is the distinction between original duration and remaining duration. This added feature allows the Scheduler or other individual reviewing an update to the CPM to note the status of work in

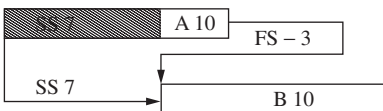
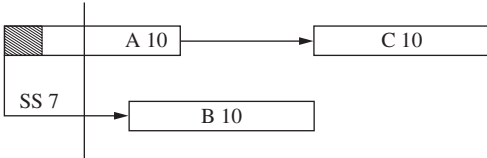

Figure 11.3.1 Finish-to-start negative 3 equals start-to-start plus 7.





**Figure 11.4.1** The problem of 2 days of progress over 5 days of time—when can B start?

progress, and further to compare the reduction in duration versus the passage of time since the start of the activity. It would seem obvious that similar tracking may be desired for the lags or durations between activities.

As an example, assuming 2 days have been performed of activity A, as in Figure 11.4.1, the Scheduler could note from the tabular printout that 8 days of work remain for Activity A, after which its successor C may start. However, the Scheduler could not determine the number of days remaining until Activity B may start without solving an arithmetic problem mentally or scribbled in the margin of the report. To some extent this may be an artifact of the dichotomy between the two definitions of the lag duration, that is, deducting the number of work days of Activity A performed or counting the number of days from the update data date to the early start of B. Either way, this is important information if the lags are provided for reasons other than simply moving bars on the Gantt chart view.

### 11.5. Impact of Percent Complete Upon Durations between Activities

If the lag in Figure 11.4.1 represents 70 percent of the performance of Activity A, then when performance of Activity A reaches 50 percent, this will also represent that 71.4 percent of the portion of A required to start B is complete and only 2 days or 28.6 percent of that portion of A remains incomplete. Note how this example explicitly portrays the basis of the theory of PDM. There is a definable 70 percent portion of Activity A preceding B rather than just any 70 percent of Activity A. Even if the passage definition is used, stating that Activity B may start 7 days after the start of A, there is an implicit understanding that the component subtasks of A must be performed in a certain sequence, and that 5 days after the start of A, 71.4 percent of these subtasks will be complete and only 28.6 percent remain to be performed.

But what if the reality on the jobsite is that progress is being made on Activity A, but not on the portions required to start Activity B? If the lags are anything other than simply to move bars on the Gantt chart,

there should be some means to decouple the reporting of progress of A, or passage of time since A started, from the countdown to B.

### 11.6. PDM and Hammocks

The use of hammocks in PDM creates a special problem of semantics. A hammock is a summary activity from one event or point in time to another, such events being the *i* node and *j* node of an activity in the ADM system. The PDM system does not have such nodes. It truly does not support point-in-time events. Even a milestone of zero duration is calculated as having a separate start and finish, or must be designated as a start milestone or finish milestone.

As a result, the machinations required to effectuate a hammock make the proper usage of “dummies” in ADM look like “kid’s play.” Assume from the John Doe project that we wish to create a hammock to summarize the work between the completion of rough grading and the start of building layout. In ADM this is rather simple. A hammock is created from the *j* node of 2–3 to the *i* node of 13–14. The software then computes the duration to be 27 days between these two activities (Figures 11.6.1a, b, and c).

However, in PDM the process is not quite so simple. Since there is no event (node) following Activity #2, it is necessary to go to the successors of Activity #2 and link to the new hammock by means of a start-to-start relationship, as shown in Figure 11.6.2. Ideally, there should be such a link from each and every successor the Activity #2, although the figure shows only two successors so linked. The finish of the hammock

TD-01				DINI
I NODE	J NODE	ORIG DUR	DESCRIPTION	
2	3	2	ROUGH GRADE	
3	13	27*	Hammock #1	
3	4	15	DRILL WELL	
3	6	4	WATER TANK FOUNDATIONS	
3	9	10	EXCAVATE FOR SEWER	
3	10	1	EXCAVATE ELECTRIC MANHOLES	
3	12	6	OVERHEAD POLE LINE	
4	5	2	INSTALL WELL PUMP	
5	8	8	UNDERGROUND WATER PIPING	
6	7	10	ERECT WATER TANK	
7	8	10	TANK PIPING & VALVES	
8	13	2	CONNECT WATER PIPING	
9	11	5	INSTALL SEWER AND BACKFILL	
10	11	5	INSTALL ELECTRICAL MANHOLES	
11	12	3	INSTALL ELECTRICAL DUCT BANK	
12	13	5	PULL IN FEEDER	
13	14	1	BUILDING LAYOUT	

ACT ID:                    DES:                    RES:                    ACC:

Commands: Add Copy Delete Edit Help Insert-res Next Return autoSort Table

Figure 11.6.1(a) Hammock in ADM. Tabular view, P35.0 for DOS.

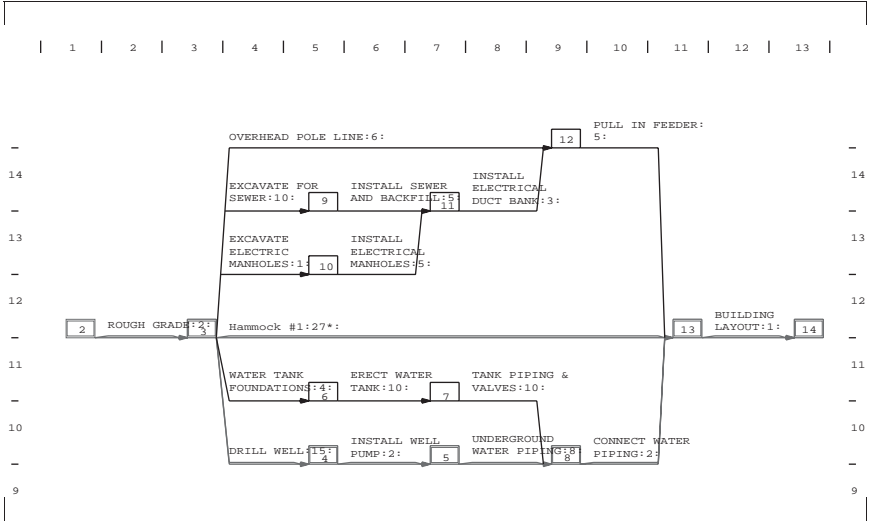

Figure 11.6.1(b) Hammock in ADM. Graphic view, P3 5.0 for DOS

is similarly linked to each of the predecessors of Activity #13 by means of a finish-to-finish relationship. The hammock duration is calculated from the start of the earliest successor to Activity #2 to the finish of the latest predecessor of Activity #13, rather like reversing the calculation rules for other activities.

This will move the bars on the initial Gantt chart, but will it continue to be accurate as the project is updated? Since the calculation is from the

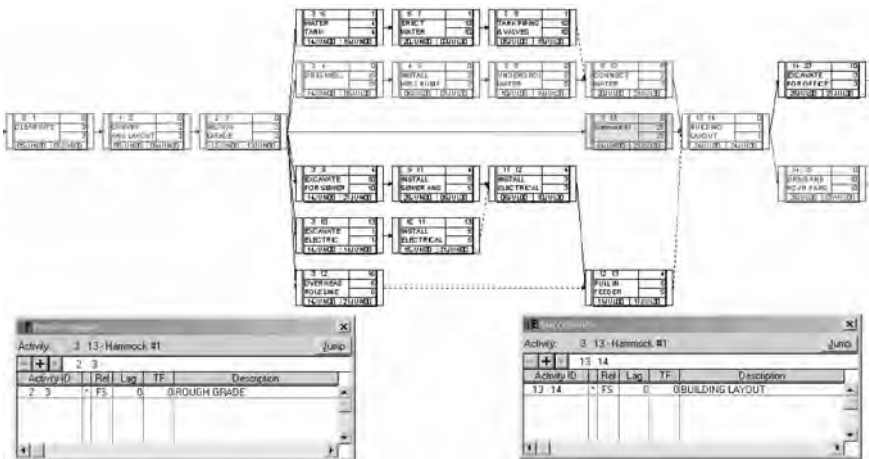

Figure 11.6.1(c) Hammock in ADM. Graphic view, P3 3.1 for Windows.

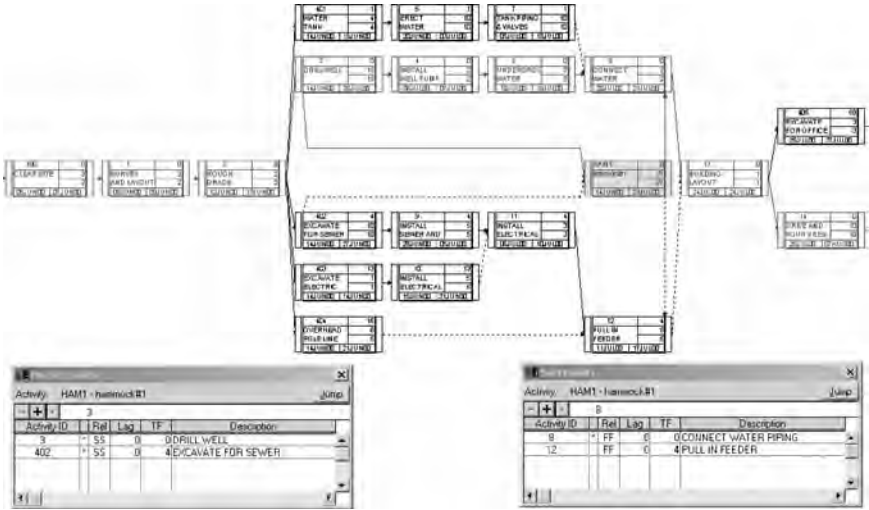

Figure 11.6.2 Hammock in PDM.

start of the successors of Activity #2 rather than its finish, should the successors not start immediately after completion of the rough grading, the calculated actual duration of the hammock will be incorrectly low.

A more serious problem occurs if we desire to start a hammock at the end of an activity with successors that are not driven by that activity but each has more critical predecessors. Assume that we desire a hammock from end of the electrical work of “pull in feeder” to the start of “set electrical load center.” This hammock, and its calculated duration, may be very useful in that it shows the time period when the electrical

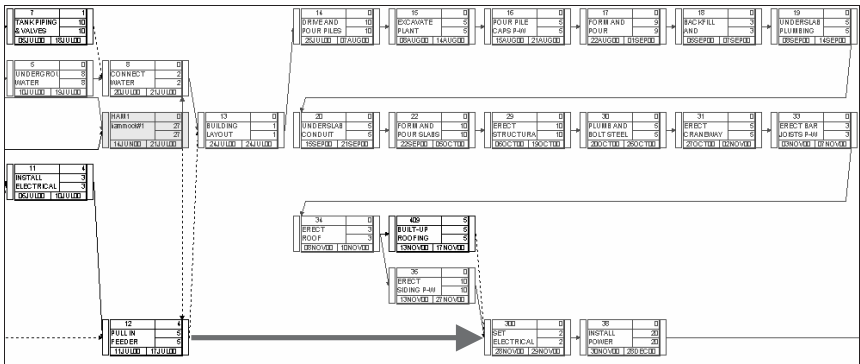
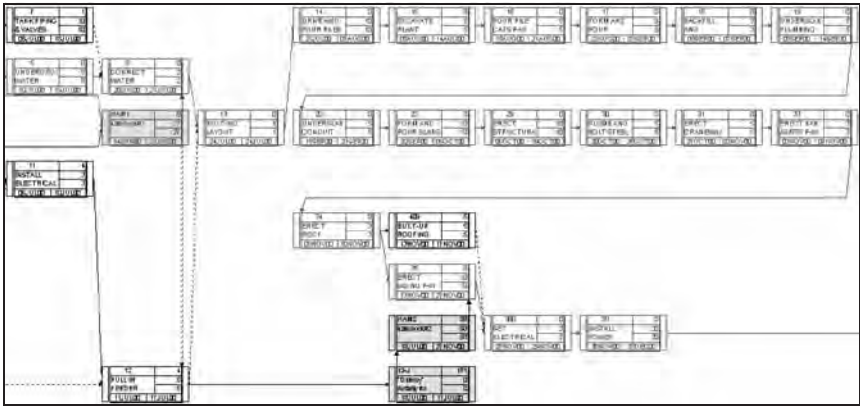

Figure 11.6.3 Cannot create a Hammock from Activity #12 to #300 as start of #13 is driven by #8.



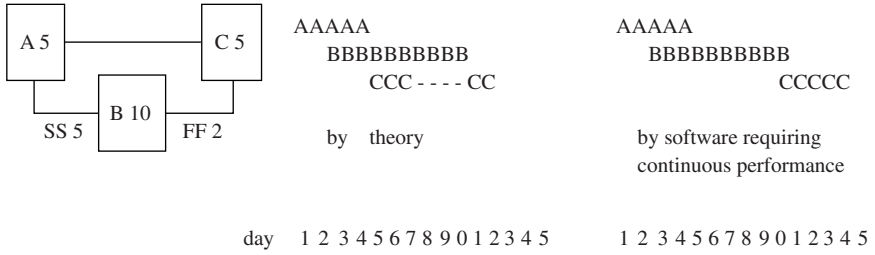

Figure 11.7.1 Interruptible versus continuous progress.

but permitting the user to specify activities as interruptible. The option is available on a per project basis and all activities within the project are affected by the choice (Figure 11.7.2).

On the other hand, standard reports do not specify which option was chosen (although it is specified in Primavera’s excellent diagnostic report). Thus, reviewing only a tabular report or graphic bar chart or time-scaled logic network will not reveal which algorithm was used.

Finally, on the topic of continuous versus interruptible durations, note that the progress type of lags model the real world such that, in

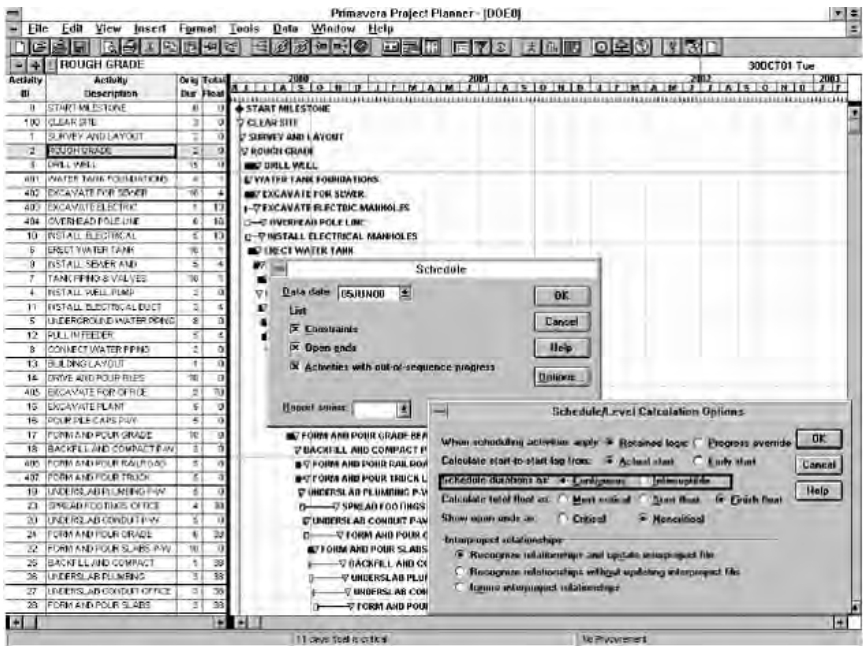
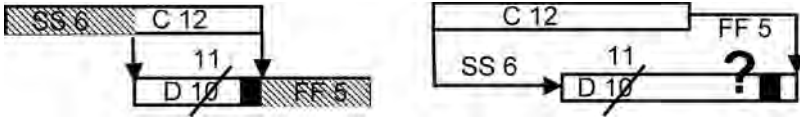

Figure 11.7.2 Choice of contiguous versus interruptible options.



**Figure 11.7.3** Continuous versus interruptible duration for progress versus passage type of lag.

Figure 11.7.3, Activity D will be performed for 5 days, rest 1 day, and continue for another 5 days for a total of 10 days worked over an 11-day period. Use of the passage type of lag leaves totally open the question of what portion of D cannot be performed and the timing of the rest period.

### 11.8. Undefined Subtasks and Relationships to Other Activities

The additional features of PDM may appear revolutionary, however, most can be duplicated in ADM by splitting activities into greater detail while utilizing only the traditional FS relationship. This is illustrated in Figure 11.8.1. Thus the 10-day duration Activity A followed by a 5-day duration Activity B via a 3-day SS lag, and by a 6-day duration Activity C via a 2-day FF lag may be rewritten into ADM: A 3-day duration Activity A1 followed by a 7-day duration Activity A2 and a 5-day duration Activity B (presumably followed by some other activity), and a 2-day duration Activity C2 preceded by a 4-day duration Activity C1 (presumably following some other activity) and Activity A1. Finally, if we desire that C1 and C2 be performed continuously and without interruption, we would apply a ZFF (zero free float) constraint to Activity C1.

The use of PDM to accomplish all of this is certainly easier. However, the precise scope of A1 versus A2 and C1 versus C2 are unknown.

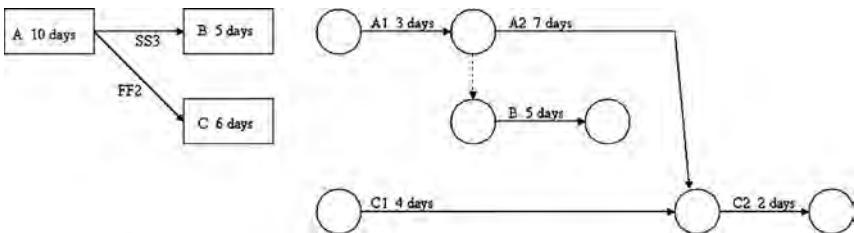

**Figure 11.8.1** Conversion of PDM to ADM.

If Activity A is erecting a brick wall, is the distinction between A1 and A2 the corners versus the middle (so that adjoining walls may be started) or right side versus left side (so that a window frame may be installed) or lower versus upper courses (where a scaffold is required)? (We have ignored the other option of upper course before the lower course as we know this to be nonsensical, but would we know this if the generalized activity was “install instrumentation,” some of which interacted with installations by other trades?) Also, in this example, the *SS* and *FF* relationships are progress based rather than passage based, as we assume that Activity B may start only when Activity A1 (or the first 3 days of scope of Activity A) is completed, rather than merely 3 days after Activity A has started.

### 11.9. Multiple Calendars

Although we discussed some of the problems associated with multiple calendars used in ADM in Chapter 9, in PDM, the problems of multiple calendars are raised to a whole new level. A typical application for using a lag factor for the traditional *FS* (finish-to-start) relationship is form,

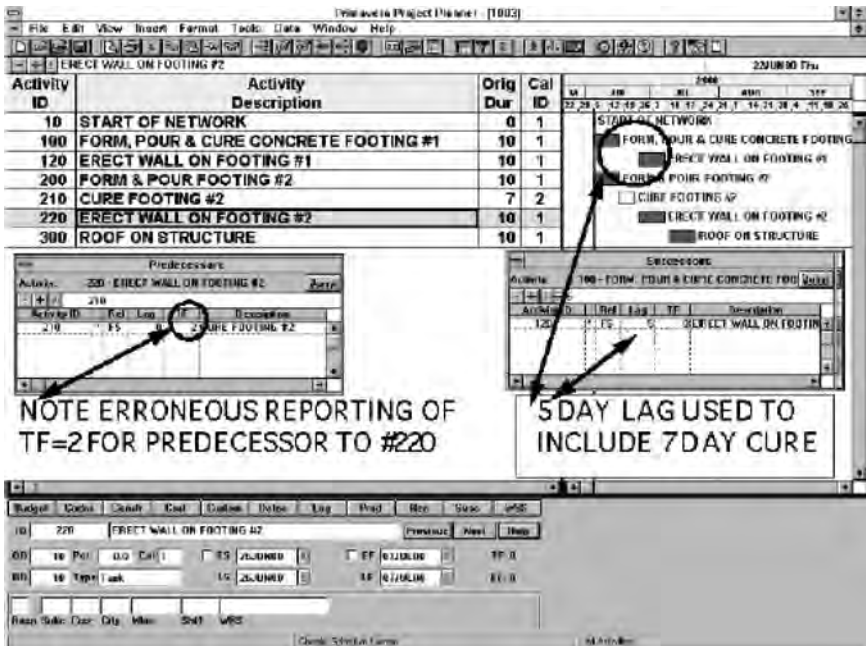

Figure 11.9.1 Problems with multiple calendars.



pour, and cure concrete, with a duration of 3 work days and 7 calendar days for curing. Typically, software designates one calendar associated with the activity, which is also used to define all lag factors associated with its successors (Figure 11.9.1).

In this case, because the cure time is 7 calendar days, we can overcome the problem by stating the lag as 5 work days. However, if the cure time is 2 calendar days, then it makes a difference if the pour is completed on Monday or Friday. Considering the variety of possible lag factors used with *SS* (start-to-start) and *FF* (finish-to-finish) relationships, you can see how easily multiple calendars create multiple interpretations and misunderstandings.

#### Class Exercise: Discuss Preparation of a Network in ADM and PDM

Our concrete crew only works Monday through Friday. We are required to form and pour a concrete slab, which we will pour in two segments and which will take 20 days. We may begin forming a wall on a poured slab 48 hours after the concrete is poured. Therefore, 2 days after 50 percent of the concrete slab is poured, we can begin forming the walls. The forming and pouring of walls will also take 20 days.

### 11.10. Retained Logic versus Progress Override

In addition to the three possible answers to the question noted in Chapter 9 on ADM networks, in theory, a fourth possible answer exists for PDM networks. This is that some additional portion of an activity can continue to be performed but that the activity cannot finish until all predecessors are complete—an implied *FF* relationship (possibly with some lag) included in all preceding *FS* relationships. In fact, this option would alleviate many of the problems of how to address work performed out-of-sequence.

An exciting extension of this concept would be for the software to explicitly insert the appropriate *FF* relationships whenever out-of-sequence work is reported, highlighted for notice to the scheduling professional, and editable for modifying the amount of *FF* lag or deletion, if appropriate. To our knowledge, neither of these two options have been included in any of the commercial software programs available (Figure 11.10.1).

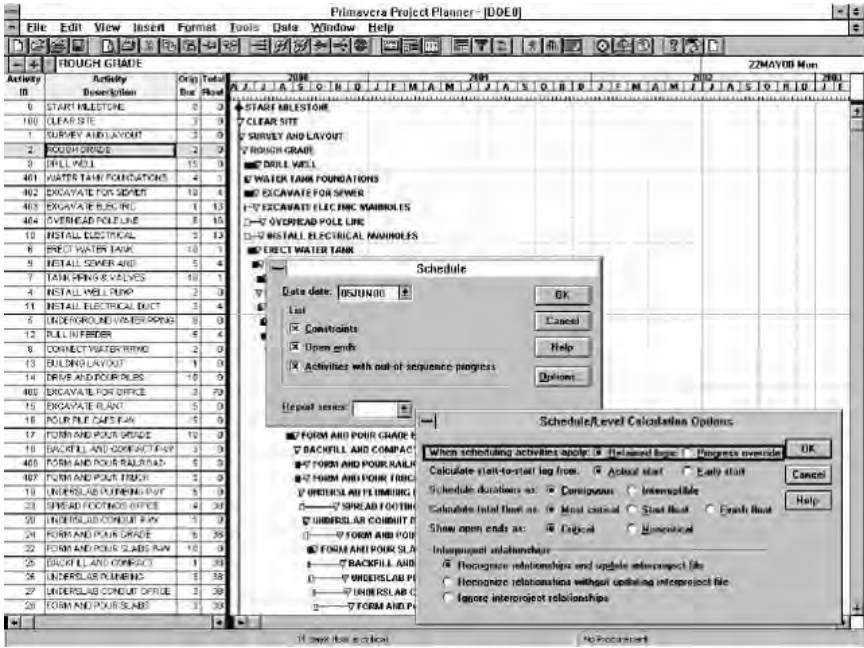

Figure 11.10.1 Retained logic versus progress override options.

### 11.11. Total Float Calculation

We earlier learned that the value of total float (*TF*) is calculated as the late start (*LS*) minus the early start (*ES*), which is also equal to the late finish (*LF*) minus the early finish (*EF*). This is because both:

$$ES + \text{duration} = EF \text{ and } LS + \text{duration} = LF$$

If the finish of an activity is controlled not by the duration of the activity but by the *FF* relationship from another activity, you can add the assumption of continuous, uninterrupted activities as noted previously to determine when the *desired*, rather than *earliest* start can occur, but the need for a true predecessor of that activity must still be addressed in many situations.

In Figure 11.11.1, the critical path runs from A through the start of B to C to D. B must be started on day 6 if the project is to be completed at its earliest possible time. However, once Activity B has started, it has 2 days float. So how is the float defined for Activity B? You could choose a start float as being the *TF* or a finish float as being the *TF*, or the more critical of the two, a most critical float as being the critical float. Some software explicitly states which calculation is used for determining *TF*;

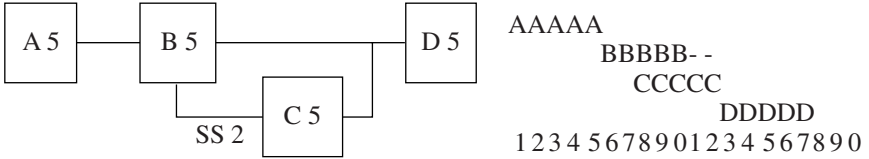

Figure 11.11.1 Total float in PDM.

other programs require that you reference a diagnostic printout or the reference manual for the software. Of course, when this problem is combined with the problems of multiple calendars, an activity’s float is closer to an opinion than a calculated number.

### 11.12. Erroneous Loop Errors

A final problem is erroneous reporting of loop errors for logic that would not be correct in ADM, but is acceptable under PDM theory. Looking at the right diagram of Figure 11.12.1, if we were to use the power of PDM to combine the two drywall activities into one activity with a duration of 7 days, a start-to-start relation to rough-in electrical of 2 days lag, and a finish-to-finish relationship back to drywall of 2 days lag, we would be saying the same as the diagram on the left. Logically, the diagram makes sense. However, all but one of the software products we reviewed declared a logical loop because Activity A was listed before Activity B, which was listed before Activity A. The loop detection subroutine created for the old ADM networks failed to accommodate the new possibilities of PDM.

Interestingly, because hammock activities are treated differently for calculation purposes in Primavera software, a hammock starting from and going to the same activity will not trigger this error message in P3 or SureTrak, but will do so in P3e/c and Primavera Construction (Figure 11.12.2).

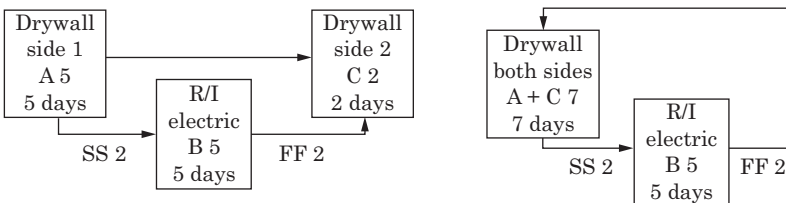

Figure 11.12.1 Erroneous report of loop error.

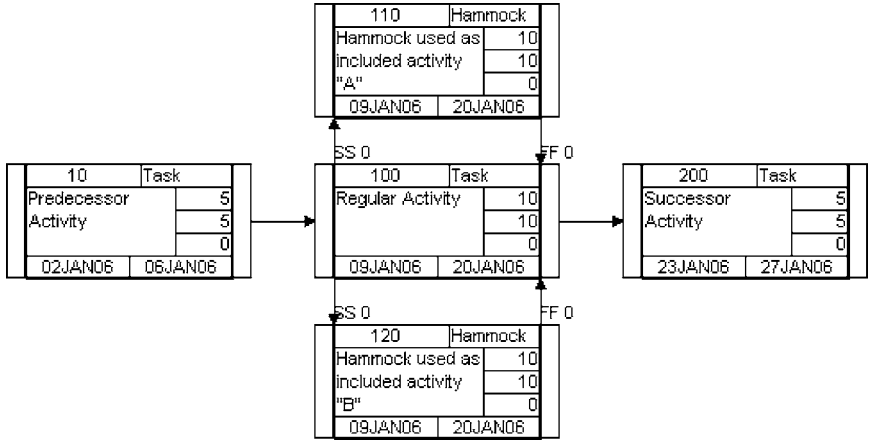

Figure 11.12.2 Hammock as included activity accepted by P3 and SureTrak, but not by P3e/c.

### 11.13. Summary

As we have seen, the Precedence Diagramming Method variant of the Critical Path Method of schedule analysis brings a great deal of additional power to the project control team in creating a model of the real world of scheduling. However, it also brings the capability of ignoring the basic regimen required of the planning professional in preparing a proper logic network, and depicting possible schedules based upon guesswork rather than logic. This new power is there for experienced schedulers to be properly used and not abused.

## **Enhancements and Extensions by Software Vendors**

Numerous software vendors have written programs to solve the CPM algorithm. Many of these vendors added additional features not found in the basic theory. In addition, many of these vendors have added features to better utilize the calculated results, including various filtering and sorting routines for tabular reports and for graphical representation of the plan and the schedule for the target project.

It would be impossible in a, hopefully, enduring text to discuss all or even many of the excellent software products that are available to the project management team for schedule preparation and monitoring. Most major vendors develop a “*new and improved*” version of their software each year. Whereas keystroke instructions tend to remain constant from year to year in an effort to maintain customer loyalty, bold changes in approach (such as Windows 95 from the Windows 3.x family) are not unknown. Changes in the operating system (such as Windows 3.x to 95 to 98 to 2000 to XP) will also play a role in the changing features and benefits of a software product, as will the changes in computing architecture and power (such as going from 16 to 32 to 64 bit technology). Therefore, this text discusses several of the many software products available, with keystroke details of one system to illustrate how any of these (or other) systems “*add value*” to the basic CPM algorithm.

### **12.1. Overview of Primavera Project Planner P3**

The personal computer (as opposed to mainframe computer) software with which the authors have the most experience is Primavera Project Planner by Primavera Systems, Inc. Primavera, like many other software vendors

over the past several years, migrated to the graphical user interface (GUI) standards set by Microsoft Windows. Thus, although earlier versions may use a <ALT-F><ALT-Q> sequence to Quit certain functions, current versions use Microsoft Windows' <ALT-F><ALT-X> to eXit such functions as well as the familiar mouse point and click exit commands.

Primavera Project Planner, also known as P3, is a high-end scheduling software product. To the ability to solve the CPM algorithm, P3 adds the ability to examine the CPM calculations in a myriad of views, both tabular and graphical. The high-end software package also permits users to view summaries of numerous projects with data that may be located on one computer, on other computers via a network, or even on machines connected via the web.

Primavera's P3 product provides a very large number of configuration options that alter the fundamental purpose of the software, the algorithm for solving the CPM analysis. Users may choose to have out-of-sequence work override the dictated logic, or to retain the original logic. Users may choose from several option for the definition of total float. Users may choose to have lag durations counted from the early or actual start of the activity. In effect, the users write the rules on how the software will solve the CPM analysis, and individuals who review printed output must be vigilant in determining what set of rules have been used. With the significantly increased power created by these options, comes the need for them to be used knowledgeably and responsibly.

## **12.2. Overview of Suretrak Project Planner**

Primavera Systems also provides and supports Suretrak software. Suretrak, sometimes referred to as "*Primavera light*," was actually written by a different group of software programmers and the similarities to Primavera Project Planner (or P3) are by design rather than default. As a result of this divergent background, several small but fundamental differences exist between the two software products.

Perhaps the most significant of these is that the algorithm used to calculate the CPM attributes of early start, late start, early finish and late finish differ. Because Primavera chose to have both programs use a common data format, it is possible for a project prepared using one software program to be read and even updated in the other. But, depending upon the specific CPM network and specific update, it is possible that such an update of a network in Primavera Project Planner (P3) will yield different results than in Suretrak. These types of problems, however, will only occur if non-traditional lead/lag relationships are used in the network. (See Figures 12.2.1 for common Base Network in P3 and Suretrak, and Figure 12.2.2 for divergent Updated Network in P3 and Suretrak.)

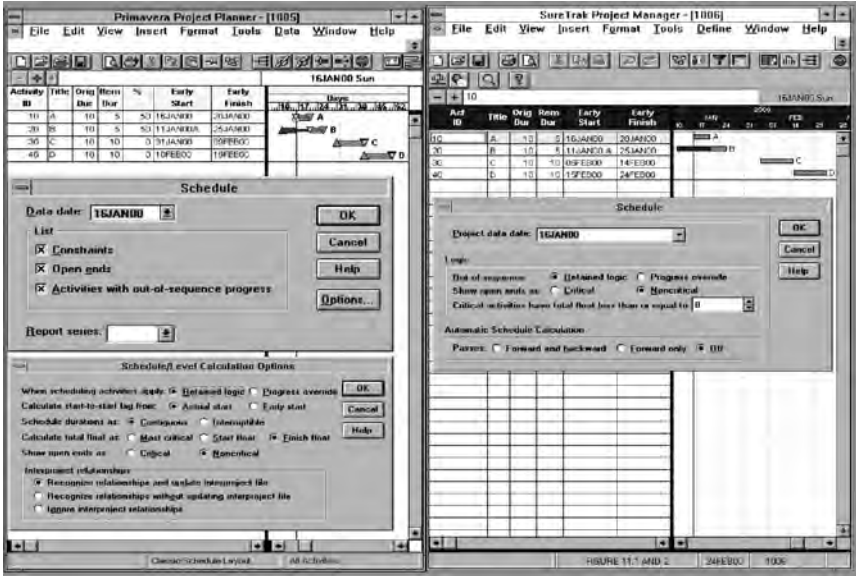
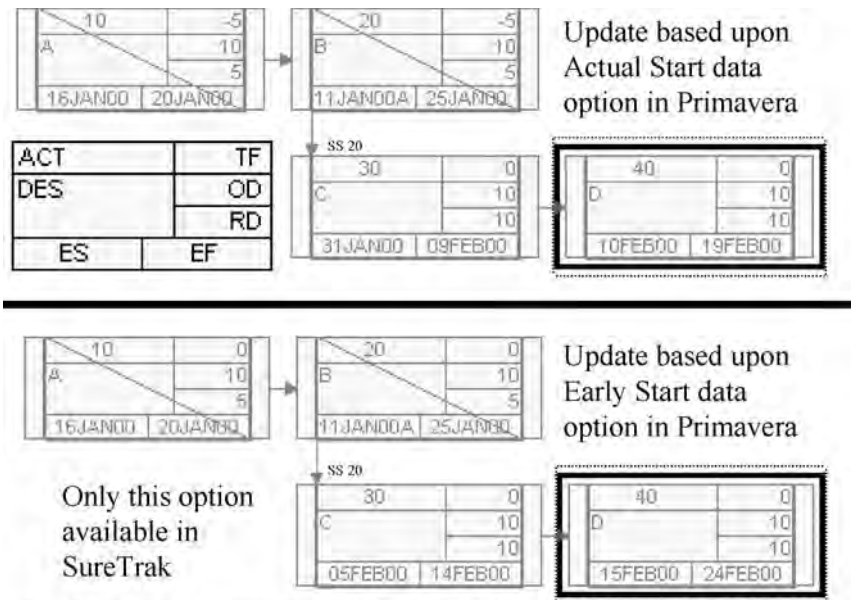

Figure 12.2.1 Comparison of P3 and Suretrak schedule option screens.



Same network - same update data - different calculation modes

Figure 12.2.2 Comparison of schedule output for various algorithm options.

As of the printing of this 6th edition, Primavera is continuing to provide support for, but is no longer selling, either its classic P3 Project Planner or SureTrak software. Its sales emphasis is now upon its new flagship of P3e/c Primavera for Construction and Engineering (version 5.0) and a reduced-cost (and feature) version for smaller construction project use, Primavera Contractor.

### **12.3. Overview of P3e/c Primavera Program Manager**

Primavera Engineering & Construction, formerly P3e/c for Construction, is the latest extension of its Primavera Project Planner for the Enterprise or P3e software launched in 1999. Version 5.0 rectifies a number of the features lost from its P3 software, including reintroduction of recording of suspend and resume dates for calculation of actual durations, and adds new features and benefits of particular use to construction industry users, such as incorporating a new means of tracking critical and near-critical paths and an UNDO function.

The basic premise of Enterprise software is that a company, agency or other organization has limits to the resources that it can field and that the intelligent allocation of these resources requires a common database that provides the status of all projects or programs (groups of projects) under the common umbrella. In some industries, such as IT and pharmaceutical, the ability to be “first-to-market” trumps all other factors in determining the success of a project. In such a case, the allocation of scarce resources to one or two champions is preferable to each project taking its “fair share.”

While P3e/c has added a great deal of power to group projects and to perform rollups on resource usage by one project or by the entire group, expanding this to allow tracking of up to several hundred projects required a more robust database engine. Primavera’s scaling up of its software initially to handle enterprise issues inadvertently caused some difficulties to users of P3 software due to problems similar to those encountered between users of P3 and SureTrak. For example, the convention for determining which calendar applies to “lag” duration between activities differs between P3 and SureTrak, which assign the calendar of the predecessor activity, and Microsoft Project (or “MSP”), which assigns these to the calendar of the successor activity. (The old MSCS mainframe system allowed the user to assign any defined calendar to each lag. This is another example of “lost art.”) The new P3e system, designed to accept input from many sources (including MSP), chose the calendar of the successor activity. Introduction of P3e/c solved this problem by allowing the user to set a system-wide choice



of modes. This has been supplemented in more recent upgrades to also include a system-wide choice of the project default calendar or a 24/7/365 calendar.

The greater capabilities of an enterprise system also comes at another cost—that of increasing the complexities of operating the system. A crash can no longer take down only one project for a few minutes until the file copy of the last update (on a floppy diskette) is located; rather the entire enterprise can be taken down. Thus such larger systems tend to require a hierarchy of computer architecture, as noted in the *P3e/c Administrator's Guide* (see Figure 12.3.1.).

The manual to explain the concepts of project management and all the functionality of the software requires 444 pages. The manual for the administrator runs to 469 pages. While this may seem daunting for most construction project managers, project engineers, and casual users, in most cases, the larger systems will be set up in a company's headquarters while smaller setups, even for a single laptop, are possible via a user-friendly wizard. The administrator's guide is so large because it

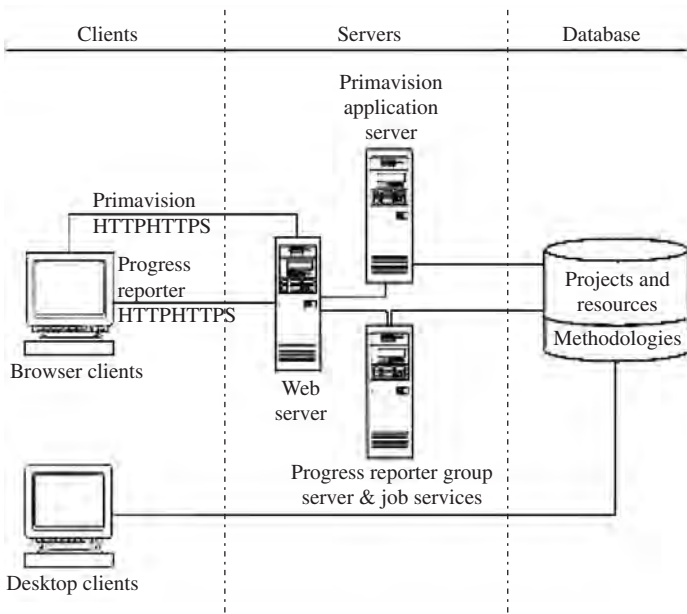

**Figure 12.3.1** Architecture of fully installed P3e/c. From *P3e/c for Construction Administrator's Guide* p 7, with permission.

has options for handling companies of the size of Bechtel, all the way down to a small Mom and Pop subcontractor.

Some of the other features made available in the P3e/c series include the following.

- linking of drawings, specifications, documents, photographs, and other “objects” to specific activities,
- assigning of “steps” or tasks as a subset or checklist for an activity,
- adding the functionality of the previously separate software known as Claims Digger,
- setting thresholds to alert a manager (who may be reviewing hundreds of projects) of a potential problem, and
- providing superior graphics, especially for “management by exception.”

#### **12.4. Overview of Primavera Contractor**

Primavera also launched a low-end and lower cost product to work seamlessly with its P3e/c software and to replace its existing entry level SureTrak software. While SureTrak may have been called “Primavera Lite” due to lesser functionalities, Primavera Contractor has all the functionality of P3e/c but is limited to 750 activities. This limit severely reduces its usefulness for construction projects as a typical recommendation for the number of activities is one per \$10,000 of value, thus limiting its use to projects under \$8 million. (Other formulas may increase this to projects of double this size depending upon the typical crew size.)

While there may be workarounds to the limits set, each has serious drawbacks. Larger or longer duration “summary” activities can be supplemented by an unlimited number of “steps” or tasks, but only at the expense of reducing the rigor of the CPM logic network. Assuming that a subcontractor could have only his/her work on a separate CPM will only work if the work of the subcontractor is totally independent of work by others on the project. It is predicted that other means of limitation will be developed by Primavera, such as a maximum number of projects or a lockout, which would permit a subcontractor to load an entire (larger than 750 activity) network but be able to update progress and view resource and cost data on its own activities.

#### **12.5. Overview of Microsoft Project Professional 2003**

Any discussion of microcomputer software that does not discuss the software sold by Microsoft would be incomplete. Microsoft Project for Windows brings to scheduling all of the strong points of other Microsoft

products, namely a standard graphical user interface (GUI), a standard set of instructions for navigating through the various menus, and a high level of connectivity with other Microsoft products.

Microsoft Project is a relatively low-level scheduling product. This does not imply that it is inferior, but merely that it is attuned to the needs of “occasional” schedulers and managers, who rarely must utilize the product. Its learning curve is low. Few options exist relating to fundamental issues such as the solution algorithm. The downside of a low-learning curve and an aversion to complexity, however, is an inability (or at least difficulty) in handling various non-standard scheduling situations.

Microsoft Project is well suited for the small or non-complex project. In writing our own scheduling software earlier in the text, we determined that the basic algorithm is quite simple. Microsoft Project may be used to provide the high quality of graphics noted in other Microsoft products. And in some areas, such as extremely short-term scheduling (to the minute), it exceeds the abilities of higher end products. Also, its inclusion of an UNDO feature is highly desirable, if difficult to implement in larger and more complex systems.

Several of the shortcomings of Microsoft Project are founded in Microsoft’s trait of assuming users’ desires from limited user input and acting thereon without overrides. A prime example of this is the assumption that the schedule will be created and edited solely upon the computer. As a result of this assumption, Microsoft Project *assigns* activity numbers as activities are entered. If an activity is later added, it will be assigned the next sequential number, or if *inserted*, the task will be assigned the activity number of the task it was inserted before, and that and all subsequent tasks will be automatically renumbered. Thus, the ability to refer to a task by an abbreviation, its task number, on printed output is severely limited. If a task description should require modification (including correcting misspellings, etc.), there is no means to compare a recent update to a prior update or the initial schedule. In essence, the task number is useless as a reference, other than for the temporary program usage, in establishing additional logic restraints.

Despite these drawbacks, for individuals who want to schedule their own time or schedule for a limited number of subordinates on a relatively small project, Microsoft Project is an effective tool.

## 12.6. Overview of Welcom Open Plan

Another of the various scheduling software products that has gained a recognized market share is Welcom Software’s Open Plan, currently in Version 3.1 as of the publication of this text. Joining the trend of Primavera, Version 3.x has migrated from a project centric product to

Overview

Welcome to Open Plan 3.1. This version of Open Plan contains exciting new features and major enhancements to features in previous versions. Several enhancements have been made to the Welcom Security Administrator as well.

To view information about each feature, click the appropriate link in the navigation pane at the left.

Many enhancements to this version of Open Plan are in response to Software Fault Reports (SFRs). Where appropriate, the relevant SFR numbers are identified.

Future releases of Open Plan will not be tested for compatibility with MS Windows 95, 98, or 98SE.

Figure 12.6.1 Open Plan opening screen.

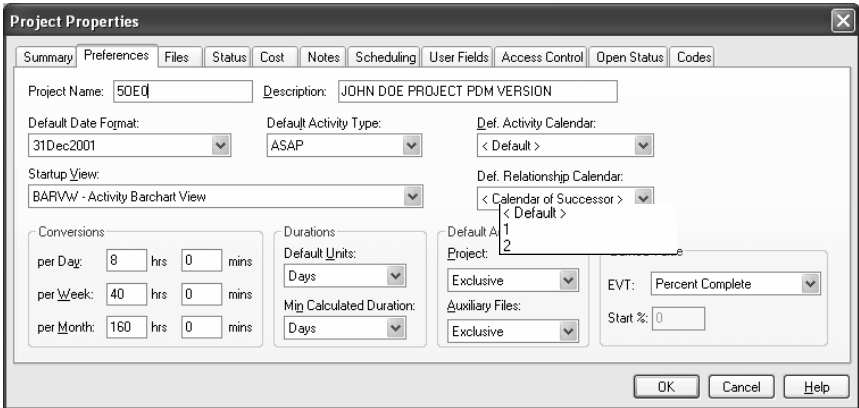

Figure 12.6.2 Open Plan Project Properties – User may set default calendar for lags, but not to predecessor.

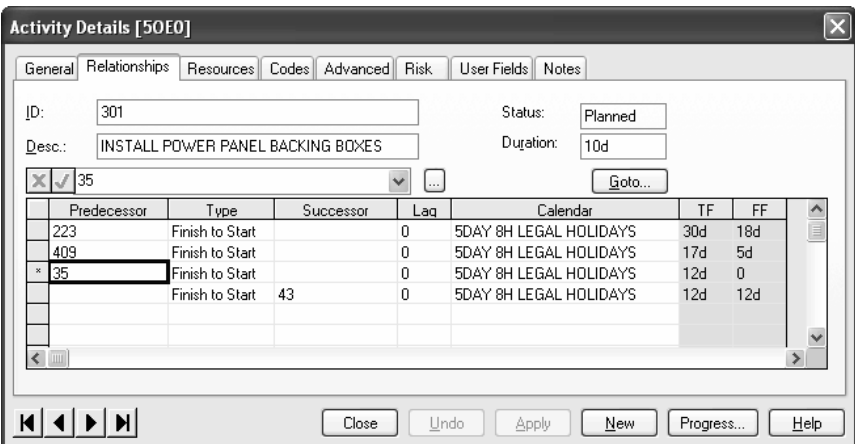

Figure 12.6.3 Open Plan Activity Details dialog box at Relationships tab.

an enterprise wide product. Thus, Open Plan 3.x provides a single database for all projects versus Version 2.6 and prior versions that allowed multiple databases. This is noted in the Open Plan 3.0 Data Migration manual (page 3) which states, "Since Open Plan 3.0 stores its data in only one location, duplication of file names is not allowed. There can be only one file of a given type with a given name. Previous versions of Open Plan allowed you to store your data in almost any drive/folder. As a result you may currently have more than one copy of a file in different folders."

A prime concern with the software is that the product appears to be going through growing pains. A great deal of the material included in the manual and on the ReadMe files of the CD on which the software is provided deals with "minor" changes, in response to "Software Fault Reports" reported by current users (Figure 12.6.1). However, a strong commitment to quality may be derived from an opening screen that points out these faults and caveats of future limitations before even going into what the product does (for new, first time customers).

Some of the "faults" described are not so much faults as much as questions of style that have plagued all CPM software vendors. One example is default rule for the calendar to be used for lag durations. While most of the construction industry has used a standard of calculating the duration based upon the calendar of the preceding activity, Open Plan has generally set its default to the calendar of the succeeding activity. This difference may be more than compensated for by Open Plan's ability to allow the user to set the calendar for each individual lag; however, individually resetting 16,000 lag calendars in a 10,000 activity network may be rather time consuming (Figure 12.6.2). Also, if using this feature, the user must remember if changing the calendar of an activity to change the calendar of each lag following the activity. One may next expect that Welcom would follow the example of Primavera (in P3e/c and Primavera Construction) to allow the user to choose which protocol will be used as a default, while Primavera and Microsoft may well consider allowing users to individually set lag calendars.

The big change has been to accomplish the migration from project centric scheduling to enterprise wide scheduling, requiring new project naming procedures and means to migrate information from the older system. The newer database system has other unintended consequences, leading to various special issues for those users migrating from prior versions of the software, much of which have been corrected by Welcom's SFR system and notification of appropriate patches to registered users.

Going beyond these issues of administration and default standards, the Open Plan product appears robust and relatively user friendly. The layout of the dialog box for input and review of relationships is highly intuitive as shown in Figure 12.6.3.

The layout of the logic network may also be displayed graphically as depicted in Figure 12.6.4. Obviously, as the number of activities

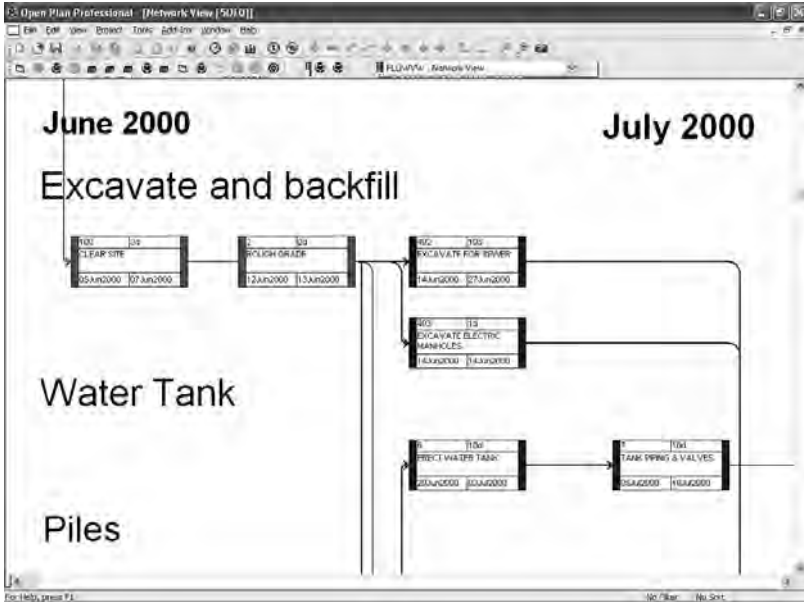

Figure 12.6.4 Open Plan Network View

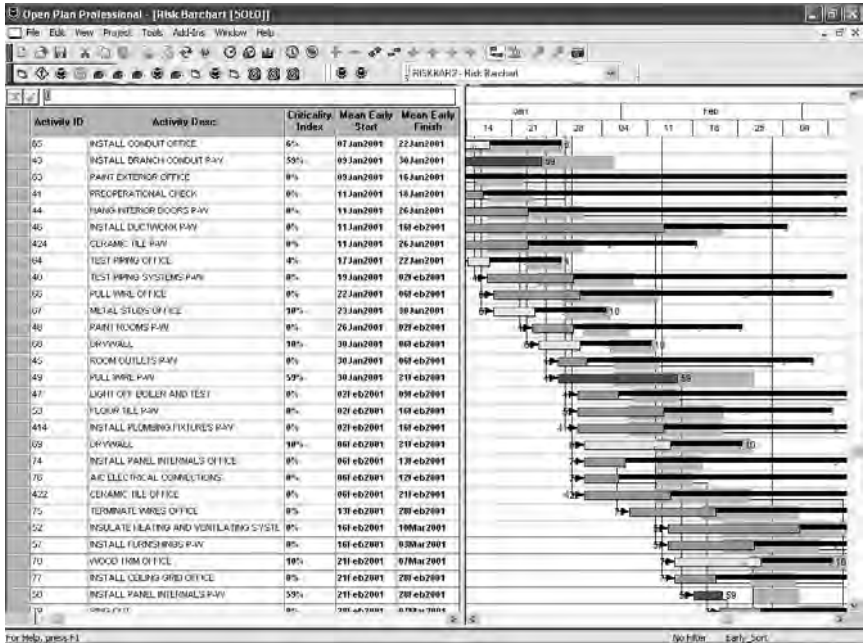

Figure 12.6.5 Open Plan bar chart showing Monte Carlo risk analysis data. Bar chart highlights criticality index and mean dates  
 Green = Never Critical  
 Yellow = 0–50% chance of being critical  
 Red = 51–100% chance of being critical  
 Gray bar represents Mean Early Start – Mean Early Finish bar

increases, the Open Plan Network View will become more difficult to read, but the implementation with curved logic restraint arrows is well done.

One feature of particular use is the automated ability to trace the critical path of a project even where multiple calendars and non-traditional relationships cause the activities of such to have positive float, as previously illustrated in Figures 9.6.1 and 11.9.1. Finally, since Open Plan incorporates a SPERT style Monte Carlo analysis as part of its basic package, it creates the ability to highlight not only the most probable critical path, but also activities that have a lesser but still high probability of becoming critical as depicted in Figure 12.6.5. (See Chapters 22.10 and 38.2 for further detail on this type of analysis.)

*This page intentionally left blank*



---

Part

# 3

## **The Tools of CPM Planning and Scheduling**

*This page intentionally left blank*

## Measure Twice—Cut Once

The mathematical basis of CPM theory has been discussed. And the features and benefits of various software tools have been discussed. So now we can discuss the practice of CPM planning and scheduling. As noted, these tools should assist the entire project team to better plan and manage a project based upon the myriad of information known at the outset of the project and as may be further known during the course of the project. But these tools alone, like a power saw, will only lead you into trouble faster if you do not take the effort to implement a system of data acquisition and a system of data verification. The old carpenter's saying, "measure twice—cut once," is also applicable to a CPM tool.

### 13.1. Preparing to Collect the Input

A CPM is not a mere checklist of tasks to be performed. CPM also is not a mere ordering of items included in the estimate. Preparing the CPM requires a fresh look at the detail of the subject project. The level of this review requires making decisions and it is imperative that the person who will be primarily responsible for the execution of the work is involved during the entire data collection phase. In construction, this person is usually the superintendent chosen to run the project. It is the team of this superintendent, who will provide the intelligence for the logic network, and the Scheduler, who will draw out this information and code it for calculation by the computer, that makes CPM the tool that it is. Read the help wanted advertisements in the newspapers or on the internet. It is no coincidence that the highest paid construction position is that of the superintendent and the second highest is that of the scheduler. The salary for construction estimators, who provide the life-blood for the company, may be close, but are definitely in third place.

### 13.2. The Pure Logic Diagram

The mathematical basis of CPM is the logic network. If you are going to *use* the mathematics of the CPM logic network to schedule the project, rather than merely display your preconceived guesses or desires of how the project should be scheduled, it is important to focus upon the input to the logic network and not to the output of the dates to be calculated. Remember, it is understood that you intuitively know how to schedule the many tasks in your project and in your life. The benefit of CPM is to do so via an analytical methodology as a crosscheck and possible improvement over the intuitive process. More importantly, by stressing the planning function to be performed before scheduling, it allows the input of multiple parties to be factored into the final product.

### 13.3. A Team Effort. . . on the Blackboard or Sketch Pad

The essence of the planning function is that the planning process should be performed without the need for the calculations to be performed by the computer. Also of primary importance is that the professional Scheduler cannot perform this task alone, in a vacuum. The preparation of the plan must be a team effort. The role of the Scheduler is to elicit the information known by the various members of the team that will be responsible for the performance of the project. This role includes the need to nudge, cajole, or otherwise obtain information from each of these individuals that may not seem important for *this* individual to perform his or her scope of work, but may be necessary for other members who must interface with the performance of such scope. The role of the other members of the team is to provide an understanding of what each must do, what resources are required to perform such scope, and what is or may be required from other members of the team or other third parties to perform such scope. It is important for the Scheduler to draw out all assumptions of the necessary support for the performance of each activity from the members of the team, and it is to be expected that the process of recording all of this information will be sloppy, involving repeated erasures and insertions. Thus, it is suggested that the entire process of preparing the pure logic network is best performed on a blackboard (or whiteboard with copy-to-paper capability) or sketchpad.

### 13.4. Format for Ease of Data Collection versus for Ease of Data Entry to Chosen Software

The absolute need for the Scheduler to determine the variety of information to be collected for each activity included in the pure logic network was previously discussed. Although obtaining the information

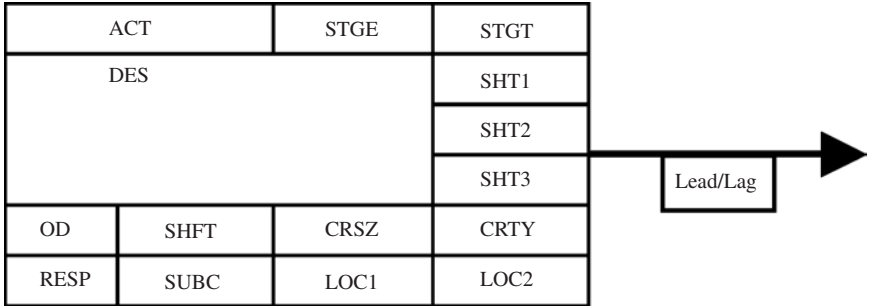

Figure 13.4.1 Large node format: activity in box with codes.

needed for “other team member’s use” during the planning session may be deemed akin to “pulling teeth,” attempts to collect such information at a later time are usually useless. Thus, the first session of the team should be devoted strictly to what information each team member wants from the final product for his or her constituencies (clients, customers, immediate and senior managements, immediate and tiered subordinates, regulatory agencies, and other “interested” parties.) A format to record all of this information should then be adopted by the Scheduler, both for ease of recording the information and as a reminder to extract the information before moving onto the next activity.

Some schemes for such a format include either the creation of a table, either within a printed (or drafted) box, or placement of the same information in a regular manner without the need for a bordered box (Figures 13.4.1 and 13.4.2).

### 13.5. Bar Chart: May Be Based upon Logic, but Is not a Logic Network

Preparation of a bar chart or charts by the various team members of their selected portions of the works (to be combined by the Scheduler) is not only not the best practice, but may be counter-productive. Since each of the team members, in preparing their bar charts, has (presumably) spent some level of time and effort in the proper placement of the bars, there will be a natural reluctance to repeating all of the thought processes

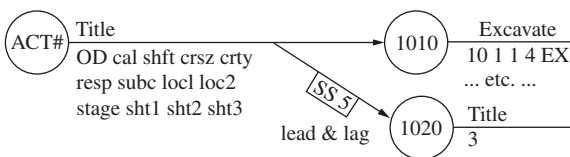

Figure 13.4.2 Small node format: activity on arrow with codes.

just expended. Moreover, many construction professionals view scheduling solely as the scheduling of their crews, and only afford a cursory cross-check that the physical infrastructure (upon which he/she may direct the crew) will be ready and available to work upon. Thus, the concept of planning and scheduling is reduced to only that of scheduling.

### 13.6. Logic Restrained Bar Chart

A logic-restrained bar chart is a slightly better precursor to preparing a CPM in that some of the thought behind the placement of bars is recorded, but it is still not the best practice and may continue to be counter-productive.

### 13.7. Freehand

As suggested previously, perhaps the most efficacious method for recording the information acquired in this collaborative effort is a freehand diagram on the blackboard or sketchpad. Activities can be placed in boxes with activity data in preset positions within the box or represented by lines (arrows) with the activity data arranged around the arrow, as depicted in Figures 13.4.1 and 13.4.2. One advantage of the arrow method is a greater ability to sneak an extra activity between two previously drawn items. If non-traditional relationships (other than finish-to-start) or lags (durations between activities) are used, some care must be used to distinguish a line representing an activity from that representing additional logic.

Remember that you, as the Scheduler, are in charge of this phase of data collection and that *any* internally consistent means of recording the data is acceptable so long as it will permit you to later transcribe the data to a computer format for calculation. Thus, the freehand drawing need not strictly comply with the rules relating to drafting according to the standards of PERT, the ADM or PDM variants of CPM, the special notations of GERT networks, or custom variations.

### 13.8. PERT

Several examples are provided in this section, ranging from the uncertainties best recorded by PERT, to traditional ADM, to the more powerful PDM, to a GERT network, to a format that may record all

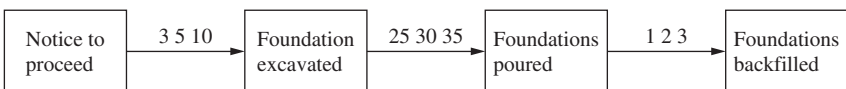

**Figure 13.8.1** PERT—Events (deliverables) known, scope of activities (to achieve deliverables) uncertain.

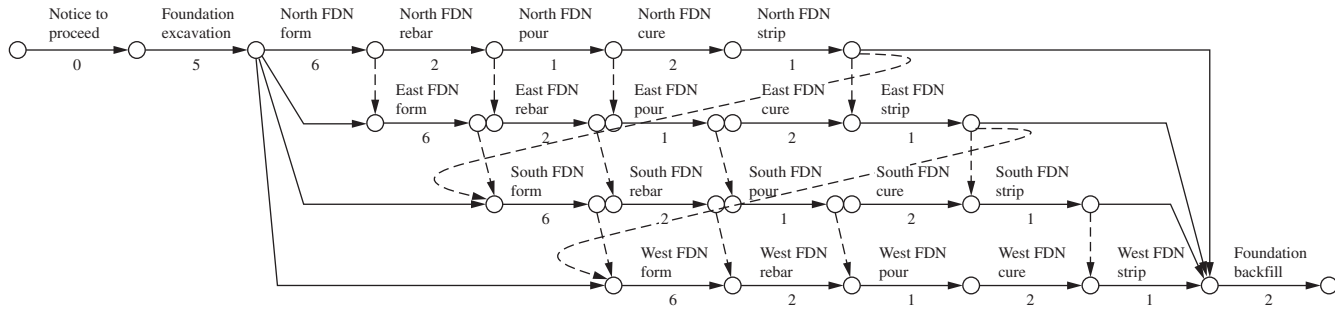
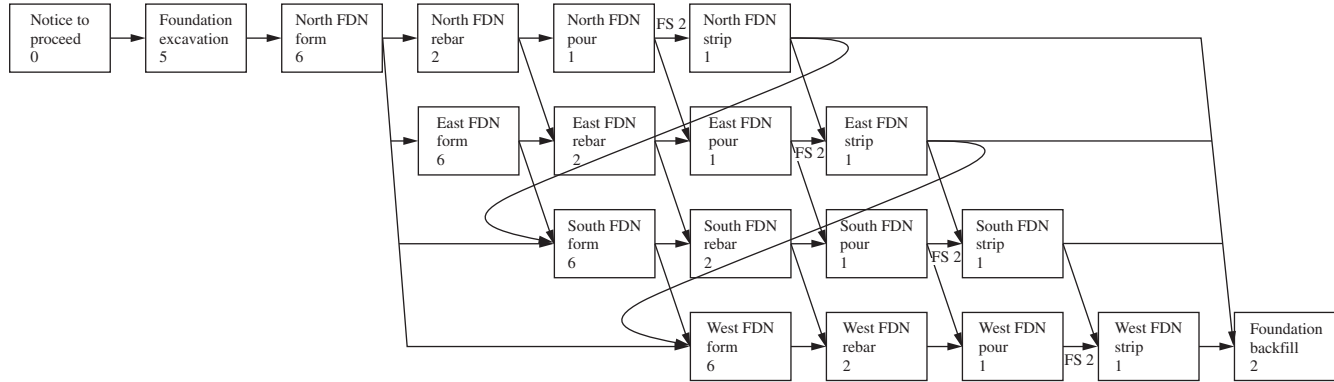

Figure 13.8.2 ADM—Events and activities known, relationships simple.



**Figure 13.8.3** PDM—Activities known, relationships complex. (Sole methodology currently supported by Primavera software.)



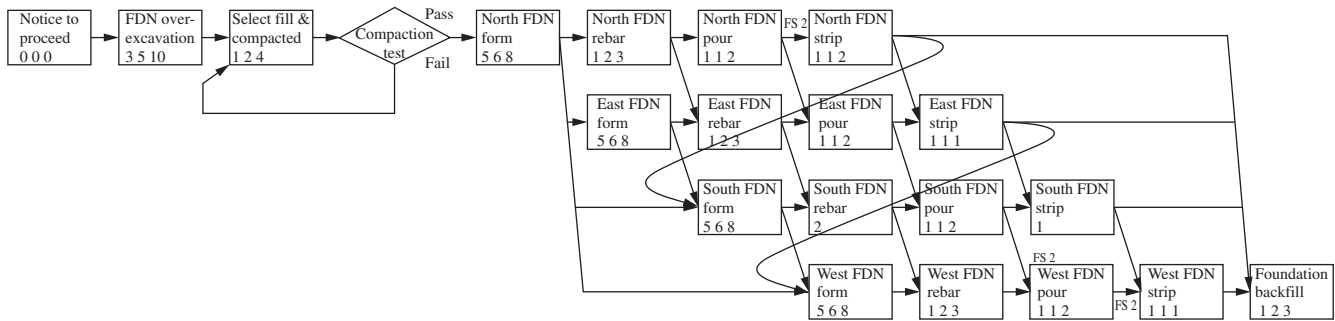

Figure 13.8.4 GERT—Choice of path to be taken.

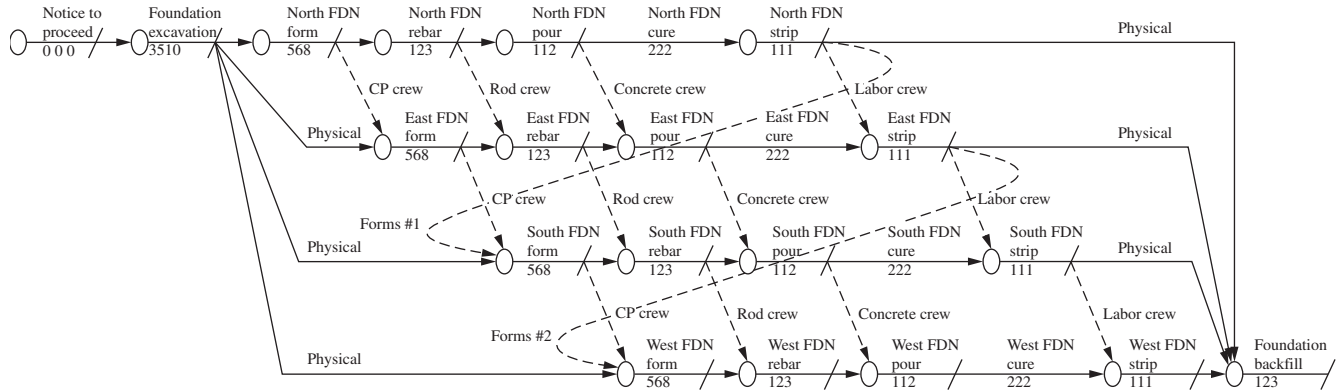

Figure 13.8.5 RDCPM™—Recording reasons for relationships.

necessary data for an implementation of RDCPM.<sup>TM</sup> A small foundation is to be excavated, possibly requiring over-excavation and compaction (and testing of the compaction,) and four foundation walls are to be formed, set with reinforcing steel, and poured. A maximum of two sets of forms is desired by the contractor. Upon completion, the foundation may be backfilled (Figures 13.8.1 through 13.8.5).

### **13.9. Summary**

The collection of data for the CPM logic network must be a team effort led by the experienced Scheduler. Advance preparation of lists of activities or bar chart schedules may be counter-productive as the team member performing such work may then be reluctant to repeat such drudgery as part of the team effort. The exact format used by the Scheduler to record the information acquired is not so important as the need for consistency and ability for this (or another) Scheduler to transcribe these notes to the selected software product.

*This page intentionally left blank*

---

Chapter  
**14**

## Choosing Codes

The usefulness of the schedule produced by the CPM software from the logic network will be determined to a large degree by two distinct factors: the validity of the input and the ability of the Scheduler to fashion the output in a format that will be understood by management and that will, in fact, assist those individuals charged with performance. Your choice of appropriate codes at the outset of data acquisition is the key to both of these endeavors. As the team develops the logic diagram and determines appropriate estimates of duration for each activity, a myriad of detail will be examined. If the Scheduler does not note these details at the time they are first being determined, it is unlikely that any member of the team will be inclined to go back and retrace the steps taken. Thus the first step to be taken, before asking “what comes after the notice to proceed,” is to set aside an hour to discuss who will be using the CPM output and what these individuals would like to see.

### 14.1. Calendar

Many, if not most, projects are developed using only one calendar, being either a 7-day per week calendar or a 5-day per week calendar or a 5-day per week with major holidays excluded calendar. Durations of activities that do not match this one calendar are modified accordingly. The inconsistencies that occur using this approximation are usually less than the tolerance of error of the estimates of duration. This merely repeats the comment that the printed dates calculated by the CPM software are mere approximations and should not be taken literally.

For example, if a duration (or lag) is included for the curing of concrete for 7 calendar days, such may be noted as requiring 5 work days. If those 5 work days extend over Thanksgiving weekend, which holiday

is often given 2 days, the total duration may equal 9 calendar days and print the early start of the successor accordingly. This is not to suggest that the contractor would wait until this printed date to perform the next step of work. An inspector citing the printed CPM date as a reason to deny the contractor permission or support for continued work would be as wrong as one who rejected a  $2 \times 4$  stud for being only  $1\frac{1}{2} \times 3\frac{1}{2}$  in dimension.

If multiple calendars are used, there should be some careful thought provided prior to beginning the process of developing the CPM. After all, the durations of the activities, and possibly the logic, will be determined by these decisions. The first comment is that if there is the possibility that this project will be “rolled up” or merged with other projects for an enterprise view, you may wish to create several company-wide standard calendars. Some of the software systems available will understand only one Calendar #1 and will assume that the Calendar #1 of multiple projects being merged (or “rolled up” for senior corporate review) is the same. (P3e/c appears to have corrected this error by giving the user the choice of enterprise-wide global calendars or project-specific calendars.) However, beyond this is the use of the CPM by members of the project team and their understanding of multiple calendars. It is recommended that Calendar #1 (both globally and for each project) be the standard 5-day per week with major holidays excluded calendar and Calendar #2 be a 7-day per week with no holiday calendar.

In P3e/c there is the option to choose which calendar will be assigned as a default. The drop-down box choice of calendar and long-name description of calendar reduces the potential confusion of designation of Calendar #1 or #2 or #3, but also increases the width of the column required to display this information and may increase the effort required to enter the information.

This too can be ameliorated by renaming your standard calendars as “5d,” “6D” and “7D,” renaming the column from “Calendar” to “Cal” and adjusting the column width appropriately (Figure 14.1.1).

In defining and choosing special calendars or weather calendars it is important to differentiate between anticipated conditions and unanticipated conditions. For example, in the northern portion of the United States, there are contractual restrictions to performing certain types of work during the winter months. Other work can be performed during this period but may be subject to a loss of productivity. Yet other work can be performed during this period without hindrance by the weather. If, for example, certain work is prohibited or not capable of being performed during the month of February, such as placement of an asphalt surface coat (either due to temperature restrictions or a general closure of asphalt plants), it is proper to have an “Asphalt Winter Calendar” with zero work days in February. But if contractors in a specific locale have experienced

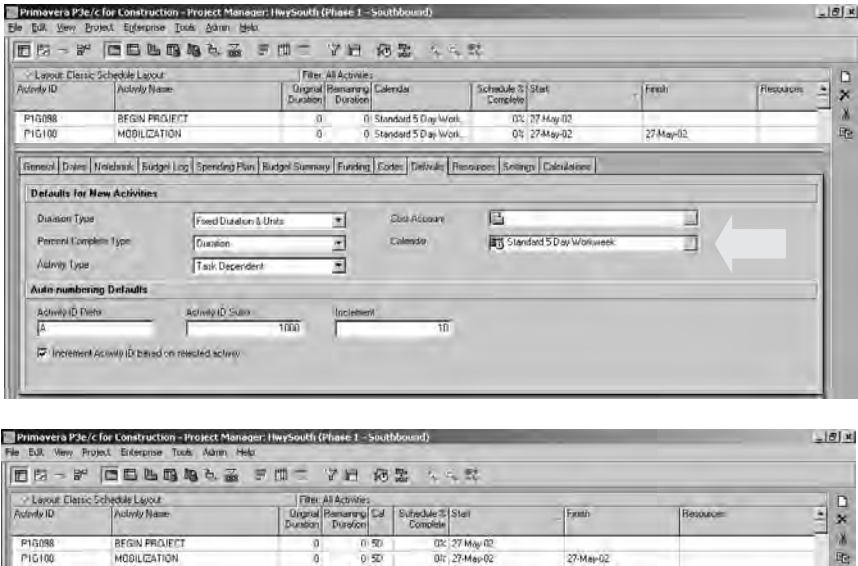

Figure 14.1.1 Multiple calendars in P3e/c.

between 7 and 13 days over the past 5 years during which concrete cannot be poured, the correct number of “weather days” to incorporate in a “Concrete Winter Calendar” is 10 and not 13. While the contract documents (or common law) may provide that the contractor receive an extension of time if the number of “weather days” exceed 13, it is not anticipated that the contractor will experience 13 days of “weather” in an average year.

The important element is to not add contingency to contingency. If the durations provided by the superintendent or the team provide for the contingency of an occasional “weather day” in June, the standard “Outdoor Calendar” should not duplicate this contingency. Since one of the main purposes of the CPM is to advise all parties in advance of when they need to provide support for the work next being performed, a great deal of contingency spread throughout the project increases the likelihood that the anticipated date of performance will be a self-fulfilling prophesy. As previously noted, contingency for events with dates of occurrence that cannot be specifically determined in advance but may generally be anticipated, such as the likelihood of a hurricane in Florida in October, or the known chance of delay to repair a crane, belong at the end of the project as a project contingency. Remember that the CPM calculates the early start, or the earliest date on which the activity *may* first be performed, and advises all parties to prepare to capitalize upon that target if it is achieved.

## 14.2. Deliverable and Responsible Entity: SHT1, SHT2, RESP, and SUBC

Most construction projects are tied to a set of contract documents including plans and specifications. Presumably the activities that will be included in the CPM logic network will be determined by reviewing these plans and specifications. Remembering that activity descriptions are merely abbreviations of these discrete “scopes of work,” it only makes sense to provide a tie back to the construction plans or specifications being reviewed as that abbreviation was worded. In most cases in the construction world, a reference to one plan, or perhaps one plan and one section, is sufficient to point the users of the CPM to those documents with the scope that is included in the activity description. In some cases, such as highway work where there is a specified sequence of construction, a third set of drawings or traffic control plans (TCPs) may be referenced. Or perhaps a separate set of environmental drawings need to be referenced to properly perform each activity. In the manufacturing and maintenance turnaround worlds, there may also be the need for multiple instructions for each activity. For example, in one logic network for maintenance procedures required in refueling of a nuclear power plant (where downtime can cost \$50,000 per hour), the manuals of seven separate agencies had to be referenced for each activity. This is not to suggest that every drawing reviewed needs to be noted. Where a feature is covered by one drawing spread over several sheets, perhaps only the first in the series needs to be noted. Moreover, referencing of the engineer’s drawings compliments the engineer and indicates that the contractor intends to honor the engineering effort included in the contract documents.

Who is responsible for performing the activity is also important. If neither the owner nor the contractor takes responsibility for seeing that some activity is performed, the chances that it will be performed in a timely manner are somewhat reduced. A responsible party code should be limited to very few possible choices: the owner, the prime contractor, and perhaps a third-party utility or other agency. In some states, multiple prime contractors may be at this level. The next level is the subcontractor level and may include a multitude of entities. By assigning a code for a subcontractor to each activity, it will then be possible to print out a schedule including the activities to be performed by that subcontractor. This, in turn, may further encourage the subcontractor to use the CPM as a tool.

Similarly, specifying the engineer as a subcontractor to the owner reinforces for all parties the correct lines of authority and ultimate responsibility for deficiencies of subordinates. Encouraging the engineer to replace the generic “ENG” code with codes noting specific departments or even individuals who will perform the stated tasks will also aid to make the CPM a tool of the entire project team.



### 14.3. Key Resources: CRTY, CRSZ, MHRS, SUPV and EQUIP

The durations estimated by a superintendent or team member also will be based upon the resources that will be brought to bear upon performance of the work. It is important here to not merely copy labor hours or equipment hours from an estimate since the scope of work defined by an activity may differ from that covered by an item on the estimate. While the estimator may have premised a rate of productivity upon a certain crew size or certain equipment usage, it is now for the team to determine if this should be the appropriate crew or equipment that can be made available and be supported in the stipulated locale. (It is not yet time to determine if the crew is available in this time frame. We have not yet calculated the time frame at this stage of preparing the logic network and the fine tuning of leveling labor and equipment usage is best deferred until we have completed the logic network and determined the needs of the entire project.) A number of factors go into estimating the duration of the activity, including the size and composition of the crew to perform the work

### 14.4. O.T., Night Work, and Special Supervision or Inspection

It is the job of the professional Scheduler to record *all* of the detail upon which the estimation of duration is based. If a project is anticipated to have periods of scheduled overtime or special shifts, it may be beneficial to record these in a separate code field for ease of review and summarization. Here again, the fine line between an engineer who exercises discretion and a technician who merely performs by rote can be noted. The choice between noting that certain work will entail an extended day or will be performed at night by use of a dedicated calendar, or by notation to a dedicated code field or by notation to a log, note, or memo field, should be based upon whether the special condition will impact the calculation beyond the error inherent in the original estimate of duration and the potential need for members of the project team to highlight or summarize such activities.

### 14.5. Quantities and Rates of Productivity

The durations estimated by a superintendent or team member also will be based upon the quantity of work to be performed. It is important here to not merely copy quantities from an estimate since the scope of work defined by an activity may differ from that covered by an item on the estimate. To some extent, there may be some overlap and there may be

some portions skipped in this process. The purpose of recording this information is to verify the schedule and not to make the schedule verify the estimate.

### **14.6. Location, Location, Location**

Since a good part of the rationale for preparing the CPM is to assist the team members in the field to perform their specified portions of the works, it may be very helpful to provide additional coding so that you can filter or select portions of the total works. Thus, in addition to noting the responsible team member or subcontractor to perform a specified scope, it may be useful to note the location of the work in a large project by area. This may include area, sub-area, alternate breakdown of area, phase, stage, step, etc. In setting up appropriate codes for location, different team members need a varying degree of specificity, thus, you may desire to have codes for both broad areas and more detailed sub-areas. You should code for both physical (e.g., second floor) and functional locations, such as “high pressure steam system.”

For certain work, you may even wish to have an alternate designation for location, especially if the design drawings (and specialty subcontractors using them) use an alternate designation for location. (This often occurs in highway work where the environmental drawings are prepared by a separate design consultant than those of the traffic control plans and those of highway design.) Similarly, you may wish to provide alternate codes for the designated phasing and staging envisioned by the disparate design teams involved in preparing the contract documents.

However, it is of utmost importance that your pure logic network not merely mimic the sequences noted from these various contract documents, but reflect actual independent review of each step to determine that each has a predecessor based upon physical reality and all necessary resources to be performed. In fact, logic loops requiring “a pipe to be placed before excavating an area before placing the pipe” are often discovered by the designers’ proposed sequencing during this process.

It is strongly suggested that you do not rely upon these code fields as the primary description of the activity. In many instances, a printout or screen view may not provide the code information and the description of the activity must be ascertained completely from the 24 / 36 / 48 characters of the given description. Abbreviation may be necessary, but each activity description must include information on location as well as on the scope to be performed. A good rule of thumb is that no two activity

descriptions should be exactly the same (otherwise known as the unique description rule of many specifications).

A fair degree of thought is often required prior to assigning the appropriate coding for location. In some software systems, such as Primavera P3 Planner, individual codes are independent and may not be subdivided nor summarized. Thus separate alternate codes are required to summarize work in the NW quadrant of the 5th floor of one of several buildings on the site. A separate code will be needed for the building, for the building's 5th floor, for the NW quadrant of the building and for the NW quadrant of the 5th floor of the building. (It is likely that some trades will want to summarize on NW quadrants for all floors of the building or only the 5th floor of the building, but not for the 5th floor of all buildings on the site). Other software systems, such as P3e/c, allow using some logic within a code (such as location = A5NW to refer to Building "A," 5th floor, NW quadrant), to avoid duplicate data entry. Of course the important point is to collect all the information any member of the team may possibly want at some future time since going back to add information to the network is time consuming at the very least.

#### **14.7. Budget Codes for Cost of Labor, Equipment, and Materials**

It cannot be overly stressed that cost accounting, or even cost estimating, views the detail breakdown of a project from an entirely different viewpoint from that of planning and scheduling. The primary difference from both a mathematical and practical viewpoint is that both accounting and estimating feature a hierarchical breakdown that may be summarized at various levels leading to one project cost. Accounting codes may be concerned with who is performing discrete portions of the project, for which department is this person working, to which division does this department belong, etc. Estimating codes may be concerned with the type of material quantity being installed or erected in place, the subcontract or trade that will bid and later perform the work, the CSI division of the specification that describes the material or type of work to be performed, etc.

Planning and Scheduling is not hierarchical. It may be suggested that the schedule for a 1-year project be divided into months, weeks, and even days, but a summary for scheduling purposes (rather than cost) rarely will be by month. And when looking at a pure logic plan, prior to calculation, the only summary desired is for a rough grouping of the activities between major interim milestones of the project. Even here, a significant portion of the total number of activities will bypass summarization

in this fashion. While a schedule view may organize and perhaps summarize activities by subcontract, the CPM is not the sum of these summaries but rather the interplay of the individual activities both within and between the various subcontracts.

A similar issue of viewpoint arises where other forms of hierarchical design are imposed upon a CPM plan. Whenever there is a requirement that each activity must be properly coded to one and only one resource code, cost code, WBS, OBS, or EPS, there will be activities that simply do not fit and the “fudge” imposed to meet the specification will mean that the schedule will not properly model how instructions are provided and how work is performed in the field. The indivisible base unit of a CPM logic network is the activity, “a set of instructions given to a competent foreman.” Activities must not be broken apart or combined to meet the needs of reporting codes.

With all of this in mind, budget codes may be assigned to activities if it is understood that it must be the reports to the departments of resource allocation, estimating, and accounting, and those organized by WBS, OBS, and EPS that are permitted a degree of approximation. Otherwise, there is the risk that the project will fail, dragging all who are involved into Chapter 11, but all under perfect control. The key is to use the codes and not the activities.

If the software product to be used (or specification) permits only one budget or cost code per activity, the most significant code must be chosen, with the recognition that costs that should go to other codes will be misallocated here. Even if multiple cost codes are permitted, there is a limit to how many codes reasonably can be assigned to an activity. If multiple cost codes are assigned to one activity, cost reports will list the activity separately under each cost code (Figures 14.7.1 and 14.7.2).



Figure 14.7.1 P3 multiple cost codes.

Activity ID	Activity Description	Orig Dur	Rev Dur	Early Start	Early Finish	Total Float	Resource	Budgeted Cost	2008															
									DEC	JAN	FEB	MAR	APR	MAY	JUN	JUL	AUG	SEP	OCT	NOV				
<b>Equipment-Crane</b>																								
<b>Building Structure</b>																								
BA710	Erect Structural Frame	20	20	02DEC08	02JAN09	0	EQUIPMENT	50,000.00	Erect Structural Frame															
BA712	Floor Decking	14	14	02JAN09	02FEB09	0	EQUIPMENT	41,720.00	Floor Decking															
BA720	Concrete First and Second Floor	15	15	01EVL09	02MAR09	0	EQUIPMENT	44,700.00	Concrete First and Second Floor															
BA730	Concrete Basement Slab	10	10	02MAR09	02APR09	0	EQUIPMENT	29,200.00	Concrete Basement Slab															
<b>Finisher</b>																								
<b>Building Structure</b>																								
BA720	Concrete First and Second Floor	16	16	01FEB09	02MAR09	0	FINISH	5,700.00	Concrete First and Second Floor															
BA730	Concrete Basement Slab	10	10	02MAR09	02APR09	0	FINISH	3,840.00	Concrete Basement Slab															
<b>Ironworker</b>																								
<b>Building Structure</b>																								
BA710	Erect Structural Frame	20	20	02DEC08	02JAN09	0	IRON	52,000.00	Erect Structural Frame															
BA712	Floor Decking	14	14	02JAN09	02FEB09	0	IRON	29,120.00	Floor Decking															
BA720	Concrete First and Second Floor	15	15	01FEB09	02MAR09	0	IRON	7,800.00	Concrete First and Second Floor															
BA730	Concrete Basement Slab	10	10	02MAR09	02APR09	0	IRON	5,200.00	Concrete Basement Slab															
<b>Laborer-Construction</b>																								
<b>Building Structure</b>																								
BA720	Concrete First and Second Floor	15	15	01FEB09	02MAR09	0	LABORER	9,500.00	Concrete First and Second Floor															
BA730	Erect Stairwell and Elevator Walls	10	10	02MAR09	02APR09	0	LABORER	9,500.00	Erect Stairwell and Elevator Walls															
BA735	Concrete Basement Slab	10	10	02MAR09	02APR09	0	LABORER	6,400.00	Concrete Basement Slab															
<b>Rough Carpenter</b>																								
<b>Building Structure</b>																								
BA720	Concrete First and Second Floor	15	15	01FEB09	02MAR09	0	ROUGH CARP	7,200.00	Concrete First and Second Floor															
BA730	Concrete Basement Slab	10	10	02MAR09	02APR09	0	ROUGH CARP	5,720.00	Concrete Basement Slab															

Figure 14.7.2 Multiple cost codes for one activity means activity is listed several times in cost reports.

### 14.8. A Word About Codes Tied to the Activity ID

It is important to always remember that the codes that you associate with an activity are for the primary purpose of allowing the users of the CPM to best view the plan and calculated schedule information. The codes are not actually part of the logic and are not used by the software in the calculations performed. The purpose of the schedule is for scheduling and if the arbitrary coding structure conflicts with a proper depiction of logic, it is the logic that must prevail. Thus, if a location code indicates 1st, 2nd, 3rd, 4th, 5th floor, and a specific shear wall spans two floors, it must be entered into the logic network as one activity and not as two activities. The Scheduler will have to decide which floor code (2nd or 3rd) is to be used for summarizing work. It is okay that the summaries may be “off.” It is not okay to compromise the validity of the CPM logic.

This type of issue typically becomes more acute when efforts are made to place “intelligence” within the Activity ID. Keeping in mind that both the Scheduler and field personnel will be required to either handwrite or key in the Activity ID number on numerous occasions, it is suggested that the Activity ID number be kept simple and as short as practicable. Since project personnel may desire to locate a particular activity upon the pure logic diagrams initially prepared, it may be useful to provide some coding within the Activity ID to locate the activity on the network. However, if the pure logic network diagrams are not regularly referenced, or if the logic is modified during the project, such efforts at coding will be wasted. Perhaps the best advice is to code the Activity IDs to make reference by field personnel easy.

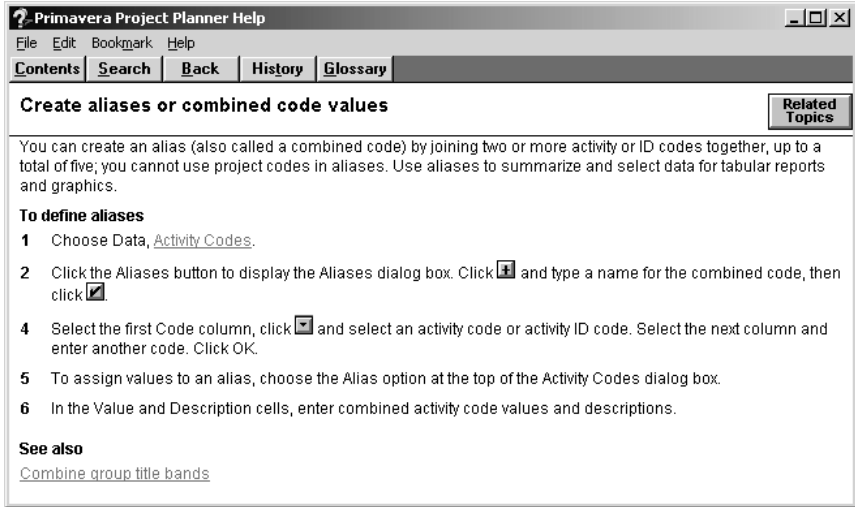

Figure 14.9.1 Primavera Alias described.

## 14.9. A Word About Aliases

Suppose that two location codes are used. One may be by floor, (e.g., 1st, 2nd, 3rd, 4th), while the other may be by quadrant (e.g., NE, NW, SW, SE). P3 and SureTrak, unlike the more sophisticated P3e/c and Primavera Contractor, do not support intelligence within a code or sub-codes (e.g., 1NE, 1NW, . . . , 4SW, 4SE). Reports must either be organized by floor then quadrant or quadrant then floor. If it is desired that the reports list all choices at the same level of summary, it is necessary to use a workaround provided by Primavera called an “alias.”

In Primavera P3 Project Planner, a means exists to get around the “Building ‘A,’ 5th Floor, NW Quadrant” coding noted in the preceding section by the use of “Aliases.” (Figure 14.9.1 and 14.9.2)

## 14.10. Summary

Choosing the codes to be assigned to each activity is the first step in data acquisition for preparing the CPM. The proper choice of codes is important and will greatly impact the usefulness of the CPM. Some codes, such as activity type, calendar, and responsible entity, must be coordinated with the activity scope, description, and duration. Others, such as key resources, overtime, and productivity, may be used to validate the durations chosen. Still others, such as location and cost, may be used to enhance the data stream from the CPM effort, but must yield accuracy to the “set of instructions given to a competent foreman” that may transcend the sharp boundaries of such codes.

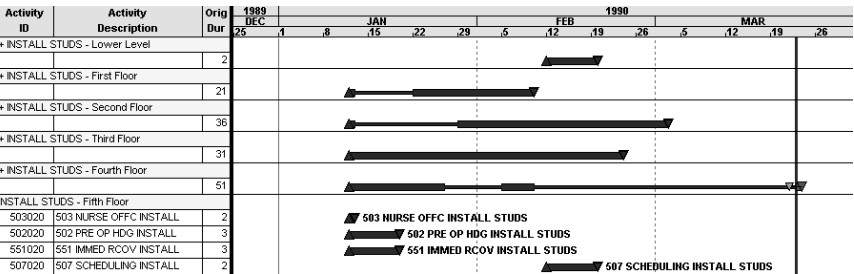
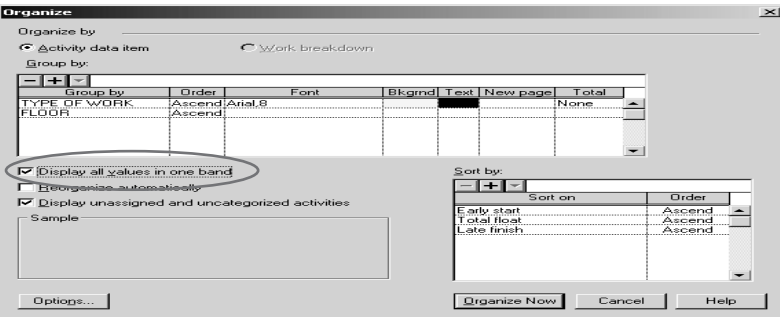
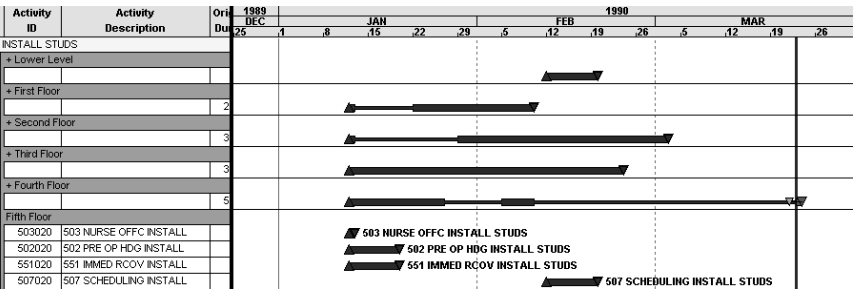
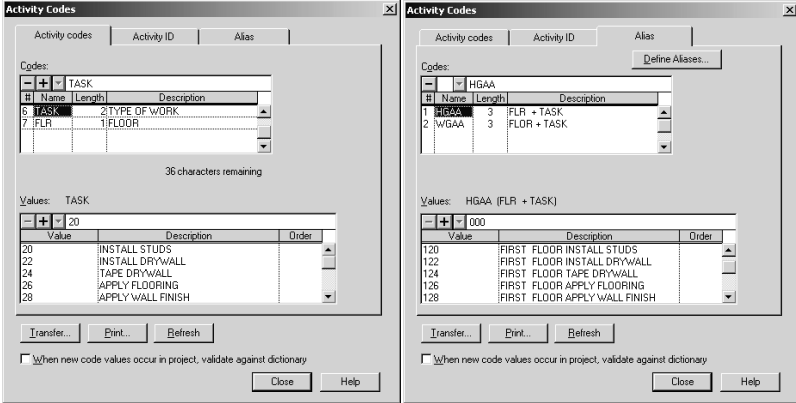

Figure 14.9.2 Primavera Alias illustrated.

*This page intentionally left blank*



## Acquiring Information to Initial Schedule

The process of acquiring the information for the initial CPM logic network appears relatively simple, but it is actually a fine dance between the Scheduler, project manager, and other members of the project team. The Scheduler must alternatively be a supportive assistant, a bit of a psychologist, a “jack,” if not master, of many fields of construction technique and a nudge. Once the discussion over the choice of coding structures has been completed, the process starts with the seemingly innocuous question, “What is the first activity to be performed after notice-to-proceed?”

The Scheduler must carefully determine data for all of the code fields for this activity—engineering drawing sheet number, crew size and composition, equipment requirements, quantity of work to be performed, best estimate of duration, physical and functional location on the project, resource codes, resource units and cost. And, then, the second question: “What must you or others do before you can start this first activity?” Invariably, the project manager will have skipped several steps between NTP and the “first” activity. For example, the project manager may state the first activity is the building foundation. But what about the excavation for the foundation? What about clearing and grubbing before excavation? What about erosion control before clearing and grubbing? What about the submittal and approval of the erosion and sedimentation control plan? What about ...?

After what may be an annoying half hour or so, the team will finally get all the way back to the notice-to-proceed. And when the Scheduler is assured that each activity has all of its predecessors identified—physical, crew, equipment, forms, material, access, etc.—the next step can

take place. “Starting from the new first activity after NTP, what is the NEXT activity that is to be performed other than the one(s) already noted?” Assuming a positive answer, this must be chased back to NTP in a similar fashion.

The process must then be repeated until reaching project completion—a long and tedious endeavor. Next, perhaps after a coffee break, the process should be repeated starting from the first activity: “What must others do before this activity may start? What must you do before this activity may start?” During this step, some logic links may be deemed to be superfluous and should be removed. The process should be repeated until all members of the team are satisfied with the logic.

This is the practice of planning and scheduling. The computerization of this information is merely a technical detail.

### **15.1. The Activity Description—a Gross Abbreviation**

We have defined an activity as “a set of instructions . . . .” The activity description, or title, used to describe an activity will, by necessity, be a gross abbreviation. After all, depending upon the software chosen, the description must fit within 24, 36, 48, or 64 characters. Even where an extended description is supported by software, invariably only the first 48 to 64 characters can be viewed in a tabular listing of activities. And yet, a whole paragraph may not be enough to fully inform the foreman, or person to be responsible for the activity, of the scope to be performed. Thus another skill required by the Scheduler is to be able to squeeze that whole paragraph down to 48 characters.

The Scheduler should consider who will read these descriptions. It is of utmost importance that the foreman, the project superintendent, and the resident engineer understand the descriptions. Thus, abbreviations of scope and location should be chosen based upon usage by these individuals. Often, the abbreviations used in the contract drawings may be incorporated. However, the choice of terminology (e.g., whether electrical installation is split into “Conduit,” “Cable,” and “Connect,” or into “Pipe,” “Pull,” and “Terminate”) is best left to the project manager or superintendent in charge of that scope of work.

It is useful if the upper management of the contractor, owner, and other interested parties can understand the description, but the CPM is meant as a tool to help the contractor construct the project and this primary purpose should not be compromised. It is important that each description be unique and not appear elsewhere in the schedule. Although one view of all the activities may organize all of the activities by floor, another view may organize the activities by function. Having five activities titled “Install light fixtures” for a 5-story structure is less than fully descriptive.

## 15.2. Activity ID, Activity Codes and Logs

In the world of construction, not every craftsperson has immediate access to a computer interface. Information is provided by the superintendent to the foremen not by email to a desktop, laptop, or PDA, but rather on a piece of paper. Thus, although the activity number or ID may include some code or “intelligence,” and although additional codes and logs or notebooks may be attached to an activity, only the information that is on the printed page will be useful to the primary end-user. As noted previously, the activity description must, therefore, be capable of telling this person the location of the work and enough about the work to distinguish it from other activities.

However, judicious use of codes, logs, and short notebook entries that fit on the printed page in a readable manner may *add* to description. The best example is tying the activity to the specific sheets of the plans or specifications via a code. For those individuals working in fields where team leaders are expected to have immediate access to at least a PDA, the ability of products such as Primavera P3e/c to create a hyperlink between the activity and underlying engineering documents is very useful. Coding by physical location is also helpful, but this information should also be in the description.

## 15.3. The Activity Further Defined by Resources Assigned

The assignment of resources to an activity, either on a nominal basis via an activity code or a more quantitatively correct resource code, further defines the activity to the scope of work requiring these resources. As noted previously, it is important to remember that the resource is helping to further define the activity and not expand or limit the activity scope to the accounting code of the resource code.

## 15.4. The Activity Further Defined by Predecessors and Successors

We have noted that its predecessors and successors also control the definition of an activity. The scope of the activity is limited to that work that may be performed after completion of all of its predecessors and to that work that must be performed prior to the start of any of its successors. Although not every minor task on the project need be incorporated into an activity, some effort should be made to be assured that any significant scope of work is included in some activity—and that just because the title sounds right, does not mean that this activity includes that scope.

### 15.5. The Checklist of Sub-tasks

Taking this principle one step further, if a list of tasks is attached to an activity, it is important to check that each task of this list requires the completion of all of the predecessors of the activity and is required for all of the successors of the activity. The logic of the CPM, which is the main strength of the methodology, should not be allowed to become fuzzy just to allow somebody to claim that every task is included in one of the activities.

### 15.6. The Checklist of Sub-deliverables (Events)

On the other hand, if it is the purpose of the project to provide a number of deliverables and not simply one completion, it is suggested that a milestone is provided for each of these sub-deliverables. For example, if construction of segments of a roadway project require each mini water basin to be secured prior to disturbance, a clear milestone indicating that all erosion and sedimentation control activities have been completed for each segment is suggested.

### 15.7. Summary

Acquiring activity information for a CPM logic network is more than just compiling a list of activities. The first step is always to determine who may be using the CPM and to choose appropriate codes to permit easy dissemination of the activity information collected. The resources assigned to the activity as well as by the predecessors and successor to that activity will also define the scope of the activity. If an activity consists of a number of discrete tasks, these may be listed in a log or note to the activity or as Steps in P3e/c. However, it is important to list as such tasks or subtasks only those of such scope as is within the original set of instructions to be given the foreman or other line-level responsible party.

## Acquiring the Durations

The time to add the durations is as the scope of the activities are being determined. Although some older texts suggest first making a list of activities, placing them in order, and only then determining durations, assigning resources and codes, and finally adding costs, it should be obvious that much of the work of determining the scope of the activity will be performed not once but several times by this approach. By the time all of the information is collected, the chances of the activity scope initially envisioned being the same is small.

Thus, this is also the time to record all of the activity codes, resource codes, cost codes, rough estimates of quantities, and “first rough draft” of costs. All of this information is in the mind of the project manager as “the next” activity is contemplated. The skill of the Scheduler is to elicit all of this information and properly record it at this time.

### **16.1. Best Estimate with Utilization of Resources Envisioned**

So at this point the project manager has stated “the next” activity and the team has at least quickly glanced at the engineering drawing or specification that most clearly describes its scope. The project manager suggests which crew is to perform this work with what equipment and other required resources. Although we should already know the physical restraint leading to this “next” activity, we may also now record where the crew and equipment and forms and other resources are coming from. Having noted all of these resources, the project manager can then provide a best estimate for duration for this one activity.

## 16.2. Compare with PERT Durations: Optimistic, Most Likely, Pessimistic

Often the project manager may give a range of durations. This should be encouraged. After duly recording the high and low estimates (perhaps even encouraging an increase to the pessimistic duration), the Scheduler should ask for the “most likely” duration. Compare this with the practice of PERT, where the scope of the work is much fuzzier and a range of durations is a necessity. Whether the high and low durations are recorded to custom code fields or simply kept as part of the Scheduler’s notes, this exercise helps alleviate the anxieties of the project manager, leading to the provision of less padded and more accurate information.

## 16.3. Schedule Durations versus Estimating Durations

Although the Scheduler should strongly dissuade the project manager from consulting the bid estimate during preparation of the logic network and recording of durations of the activities therein, once the information is collected for the CPM, it should be compared to the bid estimate. Either by use of custom code fields or by exporting to spreadsheet software such as Excel, the durations of the CPM can be roughly converted to mandays and the mandays to manhours by the formula:

$$\text{duration} \times \text{crew size} \times 8 = \text{approximate manhours}$$

If the total number of manhours of the CPM is within 5 percent of the total of the bid estimate, this should be considered a “good fit.” Keeping in mind that the crew size code field is for a nominal size crew (which may actually be larger or smaller or vary as the work progresses), ancillary manpower for support may or may not be included in the nominal crew size, the rounding to days (1 day is the minimum unit) and other rounding errors, an exact correlation is unlikely. It is not unusual for the bid estimate to have more manhours than the CPM to cover support tasks that are not otherwise included in the CPM. Subtotals by discipline are also possible, although the level of acceptable variance should be increased.

If the variance between the number of manhours of the CPM and bid estimate appear to be too large, a careful review of each must be performed. It is as likely that a bid error has been made as an error in preparing the CPM. Although such a situation is never welcome, it is better to know this information going into the project than at a point 30 percent into the project.

### 16.4. Estimated Durations versus Calculated Durations

The differences in definitions and tolerances between the estimating and scheduling disciplines should likewise point out the problems that may be expected by systems that estimate durations based upon available resources. In many fields, but especially construction, the choice of crew size is an art and often, a 4-person crew may get no greater production than a 3-person crew. Even when this is not true and a 4-person crew may be expected to produce 33 percent more than a 3-person crew, the different tolerances, noted previously, make it unlikely to have an exact match between the durations calculated from assigned resources and those determined during the bid estimate.

### 16.5. Do We Add Contingency Here?

We encourage high and low estimates of duration, however, we do not want to add contingency to the activity. If the project manager believes that there is a significant chance of a major variance to the “most likely” duration, this should be recorded (perhaps in a custom code field or perhaps only in a log or note). For example, if the project manager estimates duration for excavation by stating “most likely 1 week to 10 days, unless we hit rock, in which case it could be 3 to 4 weeks,” the Scheduler should

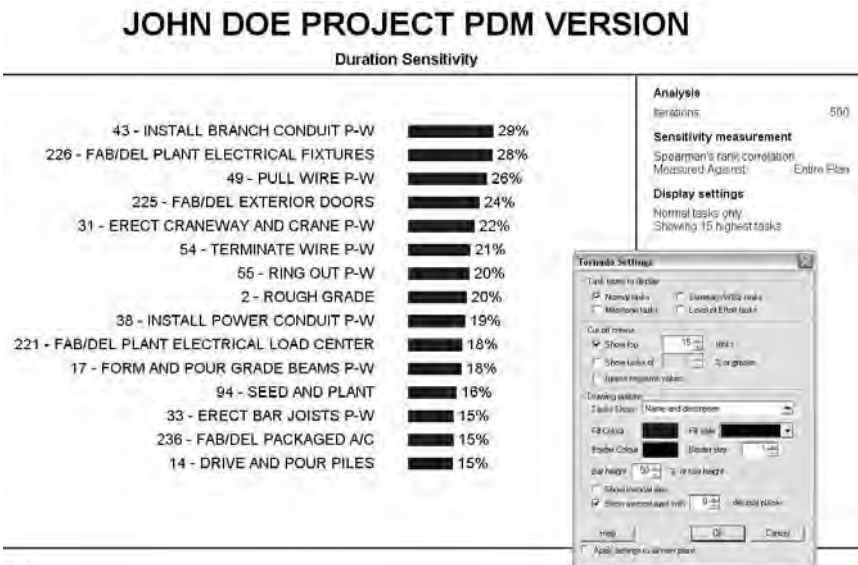

Figure 16.5.1 PERTmaster analysis measures likelihood that a change in duration of one activity may shift the critical path

record all of this comment in codes and logs but enter 6 work days or 8 calendar days as the duration. If a SPERT type of software is available (such as Primavera's Monte Carlo or Pertmaster), a separate run using this stored information can indicate the likelihood that this contingency will impact the project.

### **16.6. Estimated Durations versus Expected Completion Dates: "as Good as the Promise"**

One special problem in determining duration is when control of the activity is out of the hands of the project manager. Such a situation may exist where a vendor promises delivery by a certain date (based upon a stipulated not-to-exceed release date) but can provide no further detail or means to check delivery progress until this activity is complete. Obviously, the Scheduler can count the number of days to this date or use a constraint for the software to calculate this duration. However, it must be remembered that the expected completion date is only as good as the promise. This may not seem like a significant issue at the time the CPM is prepared, but it can become a more serious problem during the course of the project since updates may then also be based upon this initial promise unless a substantial additional effort is made with each update to verify the promise.

### **16.7. Productivity**

If quantities of work to be performed are recorded as the activity and its duration are determined, yet another crosscheck may be performed. Again, either using a custom code field or export to Excel, an attribute of productivity or quantity per day can be calculated. Then, after grouping activities of similar scope, a quick visual comparison can be made and any activities having a significantly different productivity from the others can be examined to verify the given duration. Obviously, this definition of productivity (being divorced from the size of crew or other resources assigned the activity) will differ from that used by the estimating department.

### **16.8. Durations and the Project Calendar or Calendars**

In determining durations, it is important to understand the project calendar or calendars. Is the duration for a 1-week activity 5 days or 7 days? Should we increase durations to account for holidays? Should we increase durations to account for seasonal weather? The use of multiple calendars



is complicated as a result of the desire to utilize the calculated value of float and by the additional level of complexity it causes.

If using only one calendar, the process is somewhat simplified. Situations such as performing outside work in the “off” season can be dealt with by adjustment of durations accordingly; but with log or memo notes to remind the Scheduler and others that readjustment may be required if the project is delayed for an extended period. If using two or more calendars, the process is somewhat more complex. If the architecture of the software product provides for a global calendar, holidays common to all (or even most) calendars should be provided here. Depending upon the sophistication of the software, repeating holidays may or may not require multiple entries from year to year.

For example, in SureTrak, it is necessary to enter each holiday separately, such as 01JAN05, 01JAN06, 01JAN07. In Primavera P3, P3e/c and Primavera Construction, it is possible to enter a repeating date, such as 01JAN, with a check mark in the adjoining repeat box (Figure 16.8.1). Users moving from P3 to SureTrak and back often have difficulties, as SureTrak will interpret the repeating holiday as a one-time occurrence in the first year only. In the MSCS software of yesteryear, it was possible to enter as a holiday the fourth Thursday of November (Thanksgiving in the US), but this feature is now a “lost art” and does not appear to be available in the popular software products currently available, instead requiring hand entry of 24NOV05, 23NOV06, and 22NOV07.

Since the global calendar will include all common holidays, the standard 5-day per week calendar should not. It is important to not duplicate

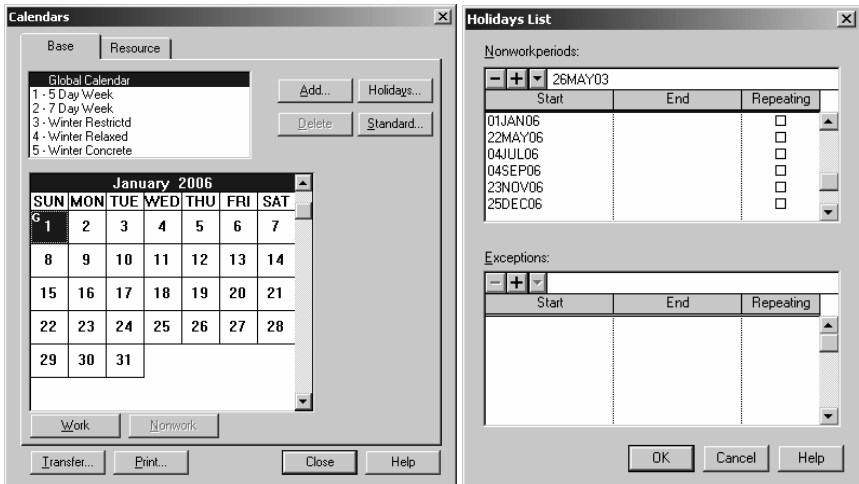

Figure 16.8.1 Global calendar and global holiday list.

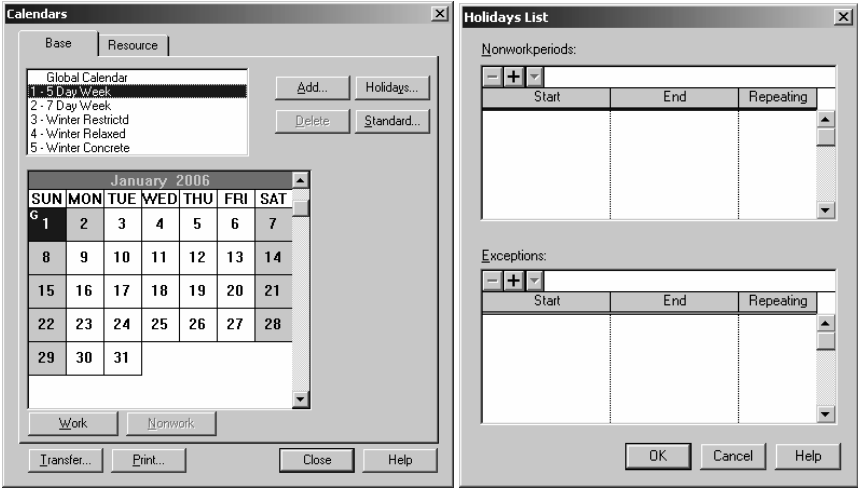

Figure 16.8.2 5-Day week calendar and holiday list. Note that January 2 is calculated as a holiday since January 1 is a Sunday.

holidays in both the global calendar and individual calendars since many software products, such as those of Primavera, will helpfully move the holiday already on a non-work day to the next non-work day (Figure 16.8.2). Thus if 01JAN is set as a holiday in both the global and 5-day per week calendars, and if 01JAN06 occurs on a Sunday, the global calendar will

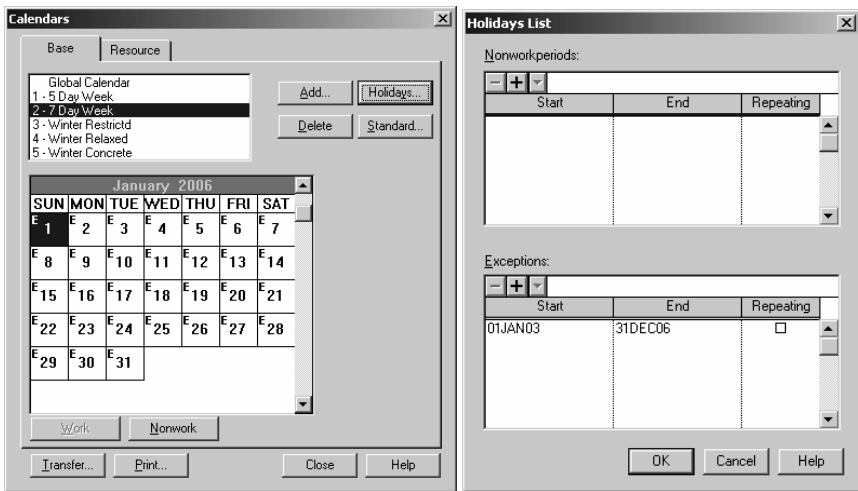

Figure 16.8.3 7-Day calendar and holiday list exceptions.

declare 02JAN06 a non-work day, and Calendar #1 will declare 03JAN06 as a non-work day. For the 7-day per week calendar, the Scheduler should set the exceptions to global holidays as 01JAN to 31DEC (Figure 16.8.3).

If creating a weather-restrained calendar, it is very important to list as non-work days only the average or even the minimum number of bad weather days anticipated. Put another way, the weather-restrained calendar should include as work-days the *maximum* number of days that may be reasonably anticipated. The number of non-work days should be significantly fewer than that set by various public agencies as the maximum beyond which the contractor is entitled to an extension of time. (It should be noted that such maximums, deemed to be beyond what the reasonable contract *may* expect, should be at least one standard deviation greater than the average number of weather days for the time period.) (Figure 16.8.4).

Care should be taken to not list as non-work days those dates immediately before or after a holiday on the global calendar as noted previously. Care should also be taken to not add contingency to contingency. Since the calendars are not usually shown in the standard tabular printouts or standard screen view of the schedule, such things represent another “hidden” element to the schedule calculation and its interpretation. It is, therefore, important that care is taken in setting up the calendars and that the initial narrative describing the logic network and schedule discusses the calendar(s) used.

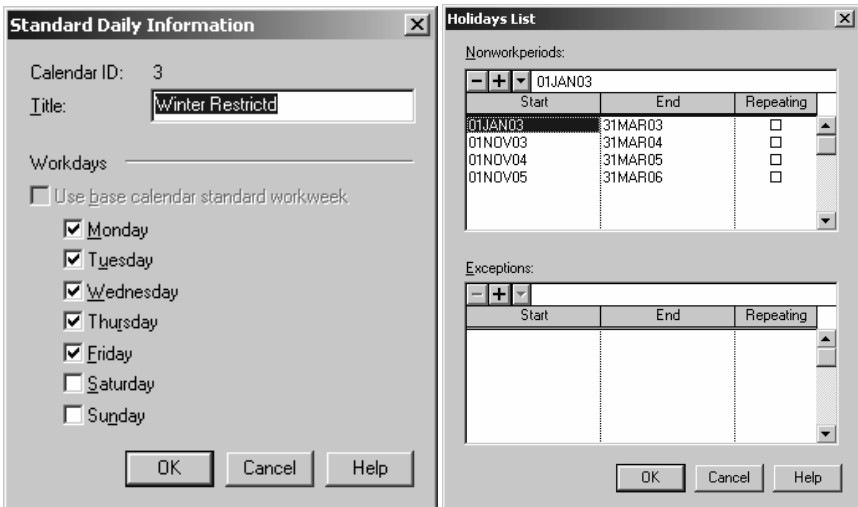

Figure 16.8.4 Winter restricted calendar standards and holiday list.

### 16.9. Summary

Durations for individual activities should be estimated as the activity scope is determined along with the recording of crew size and other assigned resources. Durations should not be based upon information in the bid estimate. The project manager should be encouraged to give ranges of duration concluding with a “most likely” duration. Contingencies for foreseeable, but not expected, situations should not be factored into the duration, but should be noted and recorded separately. Once all activities and durations have been provided and recorded, the durations can be crosschecked against the bid estimate and against the durations of similarly scoped activities for the purpose of validation.

## Specifying the Relationships Between Activities

A ToDo list has activities. An ordered ToDo list includes some inkling of the relationship between items on the list. A bar chart, obviously, includes some thought behind the ordering of the bars, but such information is rarely recorded in a systematic way. The primary benefit of CPM is the logic network of relationships between activities.

### 17.1. Mandatory and Discretionary Physical Restraints

It is a basic tenet of CPM that each activity (other than the first in the network) must follow some other activity. It is a basic tenet of the ADM variant of CPM that an activity may start only when each of its predecessors is 100 percent complete. The same rule is applicable to the PDM variant of CPM in a modified format, that is, an activity may start only when some definable (if unspecified) portion of each of its predecessors is 100 percent complete.

In the real world this means that an activity may start only when the physical infrastructure upon which it will be built is in place and necessary resources are made available for its performance. Part of the day-to-day planning process may include finding and allocating the resources necessary for a project and making those last minute decisions of “who goes first” when resources are scarce, however; the requirement for a physical infrastructure precedent to performing an activity is generally immutable. It is generally understood that each activity must be preceded by at least one physical restraint.

In practice, this must be part of the interview process in preparing the CPM logic. When a project manager suggests that a crew will perform

activity #1, then #2, then #3, and so forth in adjacent locations, the Scheduler must slow the project manager down and require physical logic (not scheduling of the crew) to be the primary consideration. Thus, in location #1 a sequence for a foundation may be “excavate, form, rebar, pour,” and so forth.

Perhaps as this is being done some of the resource logic may be penciled-in, but all parties must be aware that even in the planning stage, it may be discovered that excavation for location #2 will be more extensive and that it is not the intent of the project manager to lay off the formwork and subsequent crews while this more extensive excavation is being accomplished. That is, a more economical plan may be to work #1, #3, #4, #5, and then #2.

While the rule requiring at least one physical restraint prior to each activity is often stated as, “You cannot put up the roof until the walls are up,” this is subject to some discretion. There may be an instance where a large item of equipment is prefabricated onto a skid at the factory (to reduce cost of installation) and will be delivered to the project on a date beyond that when the walls and roof would otherwise be complete. In such a case, the project manager may plan to leave a hole in the wall and (if necessary) provide falsework to allow timely erection of the roof prior to this late delivery date. This option requires some degree of prior planning based upon prior notice of the problem, this being best provided by the process of preparing the CPM.

## **17.2. Mandatory and Discretionary Resource Restraints**

Only after all of the physical logic of the CPM has been recorded in the interview process, and either hand calculated or keyed to the software package of choice and the project been given its first schedule run, is it possible to check those “penciled-in” crew restraints and add others based upon the needs of the physical logic. Other resource restraints, including construction equipment, forms, and materials, may be added at this time. However, unless the resources specified are expected to be scarce, it is probably better to leave such determinations until shortly before the work is actually to be performed.

On the other hand, if there is an economic plan to shift forms from one structure to the next, or move a crane the fewest number of times, or to utilize the “A” team crew on certain activities, now is the time to add these to the plan. The contractor is entitled as part of the contract to marshal his forces and other resources to their best economic advantage. This is the time to give notice of the “plan of execution” that all parties to the contract are expected to support.

### 17.3. Mandatory and Discretionary Timing Constraints

The earliest implementations of CPM did not have the capability to “lock-in” specific dates on which an activity may or must start or finish. Therefore, constraints, with some exceptions, may be provided for by the standard use of logic or restraints, such as a “timing activity” of some number of days between NTP and a vendor delivery. This older method did have the disadvantage of requiring manual computation of remaining duration with each update, the problem being addressed by the use of a constraint rather than restraint. However, since the hallmark of CPM is that it uses a logic network to calculate a schedule of dates, any use of constraints to “lock-in” such dates without the benefit of the logic must be viewed with some degree of skepticism.

A SNET (start-not-earlier-than) constraint may be mandatory to set the start of the project NTP (notice-to-proceed). This may be accomplished in some software when initiating a new project by setting the project start date, and assuming that NTP is the first activity. A SNET constraint may also be appropriate if access to some areas of the project is to be delayed but is promised *in the contract* to be in place by a date certain.

In the event that certain *events* are not expected to take place until a promised date and further details of the *activities* leading to such events are outside the control of the project manager, such as vendor deliveries, a SNET constraint may be chosen as the means of entering this logic to the CPM. However, if the Scheduler intends to use an update strategy incorporating a look-ahead report, it should be understood that the use of this type of constraint will hide the status of the delivery until just before it is expected to arrive. The project manager is then entirely at the mercy of the vendor’s promise. It is suggested that for this application, to use an expected finish constraint (assuming the software supports such) to an activity of fabricate and deliver. This has the benefit of placing the continued fabrication on each look-ahead report to alert the project manager (or subordinate) to call the vendor at least once a month to verify that all is going well.

A FNLT (finish-not-later-than) constraint may be mandatory to set the deadline for project completion and also for project milestones required *in the contract* to be completed by a specified date. A FNLT constraint may also be desired by a contractor to set internal deadlines. Other timing constraints, such as SNLT (start-not-later-than), FNET (finish-not-earlier-than), and those that require the activity to start or finish on a specific date without regard to the logic are even more suspect and should be carefully reviewed to determine if they are truly appropriate.

#### **17.4. The Misuse of Restraints and Constraints: “Nailing the Bar Down Where It Belongs”**

It must be emphasized that the purpose of restraints (between activities) and constraints (to an activity) is not to produce a schedule, but rather to produce a logic from which the CPM software algorithm can calculate a schedule. Use of restraints to schedule an activity to occur on or about a specific date is inappropriate. One example noted some years ago was a CPM submittal that tied installation of an elevator to installation of a water cooler at the other end of the building. When the contractor was asked the logic of this restraint, the reply was “We want to start the elevator in mid-November; this was the only activity that finished around then.”

Use of SNET and FNLTL constraints simply to “nail down the activity bar in the correct place on the chart” is similarly flawed. There must be a coherent reason why the activity constrained cannot start or must finish by the specified date that is unconnected to the status of other preceding or succeeding activities. Likewise, the use of expected finish constraints clearly states the project manager’s lack of knowledge about the process leading to the “promised date” and should raise suspicions among all who use or review the CPM accordingly.

#### **17.5. The Need to Document the Basis of Each Restraint and Constraint**

The Scheduler does not create but rather records the logic provided by the project manager and project team. It is, therefore, important for the Scheduler to document not only the restraints and constraints, but the reasoning behind each. Is a restraint due to a physical requirement or simply to allow reuse of formwork or to suggest the preferred (but not certain) sequence of assignment for the crew performing the work? The software may not have an appropriate slot to record this information (as descriptive, log and note fields are usually assigned to activities and not to the relationships between activities) but the data may be noted in the Scheduler’s notes or in electronic format outside of the CPM software database. (For example, in an expanded spreadsheet having fields for activity, successor, relationship, lag, and reason, as noted in Chapter 2.)

#### **17.6. Choosing the Type of Relationship between Activities**

Life used to be so simple when there was only one type of relationship. That was the finish-to-start relationship provided in the original ADM version of CPM. Theory by Dr. Fondahl and others in the late 1950s and early



1960s, and software by various academicians, private companies, and computer service bureaus in the late 1960s and early 1970s, addressed the expansion of the tools to address other types of relationships, specifically the case where two activities overlap. Software supporting additional means of showing two activities overlap was developed for the mass market (on PCs rather than mainframes) in the 1980s. However, the use of non-traditional relationships is more than being able to show the overlap of two activities. The theory concerns the “how and why” of the overlap.

### **17.7. The Case for Restricting Relationships to Traditional “FS” Without Lag**

The sad fact is that the limits of the ADM variant of CPM meant that users did not have to know or appreciate the theory behind CPM. On the other hand, the newer non-traditional types of relationship permitted by the PDM variant of CPM require this knowledge and appreciation. The axiom of CPM remains, that is, an activity may start only when some definable (if unspecified) portion of each of its predecessors is 100 percent complete and an activity may finish only when some definable scope of work is 100 percent complete.

If the project manager states that “Activity B may start when Activity A is 90 percent complete,” the software does not care if the project manager can articulate the tasks comprising the 10 percent of Activity A that is not necessary for Activity B. The Scheduler, however, must demand this information. Since the Scheduler works for the project manager, and the project manager may not desire to be bothered with thinking out (much less reciting) the detail required, the demand is often not met, and after all, this detail is not required by the software so why bother.

The abuses caused by this lack of understanding, as well as by those who deliberately misuse the power of PDM, have led many owners and engineers to place restrictions in their contract documents and specifications. For example, in the early 2000s, PADOT promulgated a new guide specification that mandated use of software that runs only PDM, but restricts the type of relationships to the traditional finish-to-start without lag. This is not quite an example of punishing all for the misdeeds of a few, but comes close. Usually, the professional engineers of PADOT will use engineering discretion and allow limited use of non-traditional relationships if the Scheduler can demonstrate that there is actually logic behind the overlaps.

### **17.8. The Need for Non-Traditional Relationships**

Use of ADM in the late 1950s, 1960s, 1970s, and 1980s often required fudges and workarounds to make the mathematical logic network properly model the real world. The additional power of PDM often was the

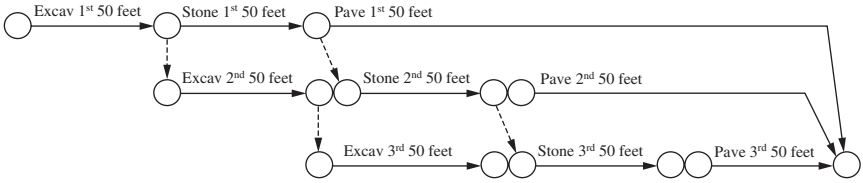

Figure 17.8.1 ADM.

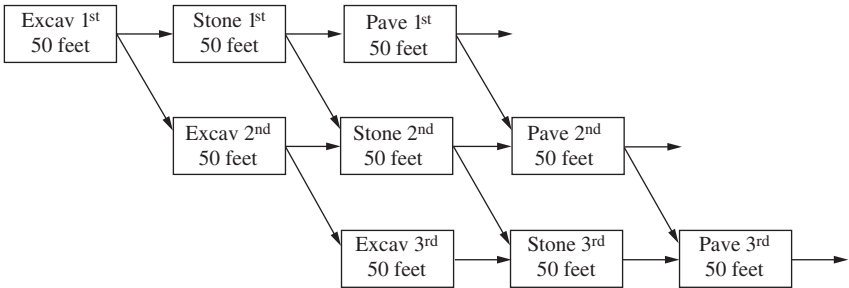

Figure 17.8.2 PDM.

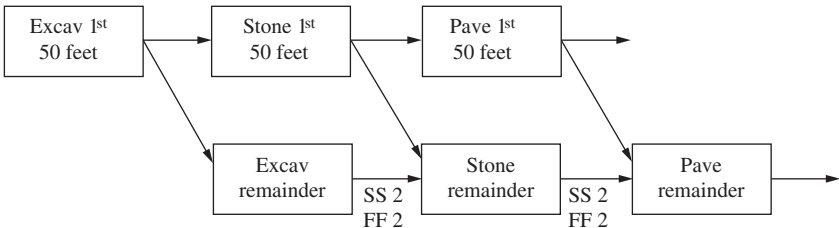

Figure 17.8.3 PDM with some overlap.

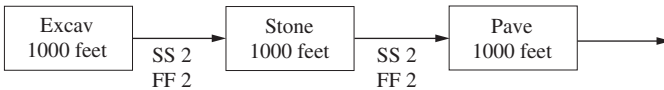
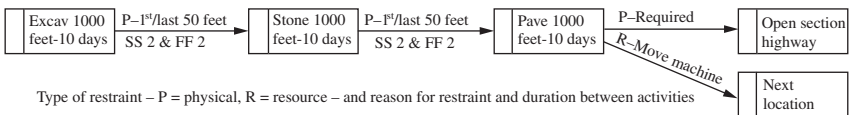

Figure 17.8.4 PDM with more overlap.



Type of restraint – P = physical, R = resource – and reason for restraint and duration between activities

Figure 17.8.5 RDM—Rationale of restraints recorded.

best answer to these issues. The Scheduler in preparing the CPM must not only properly model the real world for the initial schedule submission, but must do so in a manner that makes using and updating the CPM simple enough that such will be willingly embraced by the field.

Note Figure 17.8.1, an example of a 1000-foot long highway project in ADM. Three separate crews (possibly three separate subcontractors) are involved in constructing the highway. Crew #1 excavates the first 50 feet, then continues while crew #2 places stone. When crew #2 completes the first 50 feet, crew #3 may begin paving. (Even in this hypothetical example, it is recognized that crew #3 may but need not begin immediately.) Note that to prevent false logic, a large number of “dummy activities” or logic restraints are required.

In the 1960s, to prevent the CPM from becoming a huge mass of meaningless detail, various practitioners would create various fudges, the most usual to create one activity of “Excavate / Stone / Pave” after graphically detailing on the side the detail of Figure 17.8.1. However, this fudge effectively prevented selecting or sorting by crew or subcontractor or properly cost loading the network. Each such situation had to be solved in its own special way.

The same information can be recorded in PDM as in Figure 17.8.2. Note that only traditional finish-to-start logic without lags is used, but the need for the “dummies” is removed. However, the number of activities is the same and the job of updating the CPM (recording the actual start and finish for each activity) is not trivial.

Now we can begin to condense the network to show the dependencies between crews without overstating the obvious. Looking at Figure 17.8.3, note how a minimum number of tasks of larger activities need be spelled out to fully describe the relationships between crews.

However, now that overlaps are possible, they can be misused. Figure 17.8.4 shows the logic fully collapsed by used of non-traditional logic and lags. Referring back to Chapter 2, how will the software correct for reduced durations if larger crews are used? How will the software treat an update situation where progress on excavation is slowed by worse than anticipated conditions?

Further extension of PDM theory and software, as suggested by the RDM approach, as shown in Figure 17.8.5, may allow the network to be similarly condensed but still retain the information implicit in the original ADM model.

## 17.9. The Desire for Non-Traditional Relationship and Resulting Misuse

While the use of PDM non-traditional relationships and lags, as shown in Figures 17.8.3 and 17.8.4, are perhaps better “fudges” than the ADM

logic of Figure 17.8.1, the availability of the shortcut, plus placement of the tool in the hands of “screen jockies” who understand the software but not the theory of CPM has led to abuses. It is so easy to say, “When concrete is 30 percent done, we will start mechanical installation and when mechanical installation is 30 percent done we will begin electrical work,” rather than perform the work necessary to prepare a proper CPM logic network.

### 17.10. Non-Traditional Relationships Supported by Popular Software

Non-traditional relationships supported by Primavera include the following.

- Start-to-start, with lag counting days from the actual start date recorded (or data date if PCT > 0 and no date is recorded)
- Finish-to-finish, with lag counting days from the actual finish date recorded (or data date if PCT = 100 and no date is recorded)
- Start-to-finish, with lag counting days from the actual start date recorded (or data date if PCT > 0 and no date is recorded)
- Matching start-to-start and finish-to-finish restraints, with matching or non-matching lags
- Matching start-to-start and finish-to-start, finish-to-finish and finish-to-start and other combinations are neither rejected nor flagged for probable error
- P3 lags are based on the calendar of the predecessor, P3e/c lags are based on the calendar of either predecessor or successor as chosen on a project wide basis in user option settings

Non-traditional relationships supported by Microsoft Project include the following

- Start-to-start, with lag counting days from the actual start date recorded
- Finish-to-finish, with lag counting days from the actual finish date recorded
- Start-to-finish, with lag counting days from the actual start date recorded
- A maximum of one relationship may be placed between any two activities
- Lag durations are based upon the calendar of the successor activity

### 17.11. Minimum Restrictions for Proper Usage of PDM

The provision of power to a saw made the work of sawing easier but perhaps made the work of cutting harder. Not only is it much more important to measure and mark before cutting, but the frame of the power saw makes it much more difficult to see the markings. The power of PDM as implemented by modern software causes a similar problem in that the logic ties between activities or even summary activities are much easier to add, but it is more difficult to see what is to be added and what has already been added.

### 17.12. Review the Strengths of ADM: Expand the Definitions

A set of minimum rules for PDM should start with remembering that although the software allows the user to abbreviate the detail between two summary activities (or two activities with constituent tasks that are interrelated), the Scheduler should be cognizant that at some level *something* has to be 100 percent complete before *something else* can start. Thus, the Scheduler may understand that a SS5 restraint indicates that some definable portion of Activity A (requiring 5 days of the presumably larger duration of A) must be complete before starting Activity B. And the Scheduler should record this knowledge even if only in his/her notes. With this backup, the Scheduler should be able to persuade a knowledgeable engineer to allow non-traditional relationships, even if such are prohibited by the specification.

### 17.13. Start of Each Activity Must Have Predecessor

A second minimum or immutable rule is that the *start* of each activity (other than the first) must have a physical predecessor. In other words, that *something* had to be in place before this activity may be performed. Even if it is obvious to all that this activity should not be performed until near the end of another activity, there is *something* that must be in place before it can start.

### 17.14. Finish of Each Activity Must have Successor

A third minimum rule is that the *finish* of each activity (other than the last) must have a physical successor and that this activity must be 100 percent complete for *something else* to occur, even if it is turning over the keys to the owner. The successor may be the start of another activity

(finish-to-start) or to the start of some definable portion of another activity (finish-to-finish.)

### 17.15. Real World Relationships between Activities

Given that popular software may not support all of the real world relationships that the project team may convey, it is the job of the Scheduler to not only provide the necessary “fudge” to input information to the computer, but also to both provide appropriate interpretation to all the various users of the CPM. The Scheduler must set reminders for other project control personnel to adjust update information accordingly.

The project manager may say, for a 10-day activity, that a specific successor may start when 30 percent has been completed. If using Primavera products, the Scheduler must choose to enter an SS3 relationship, which states B may start 3 days after A has started without regard for progress, or a FS-7 relationship, which states that B may start when the remaining duration of A has been reduced by 3 days from 10 to 7.

Of these two options, it is recommended that the Scheduler not use the one requiring negative lag as such use may create a “hidden” open end (as discussed in Chapter 11) and will generally increase the level of skepticism among reviewers of the CPM. The Scheduler must thereafter be always vigilant to adjust the lag if changing the original duration and during each update involving this activity, perhaps even to the point of reserving an activity code to flag all activities having such lag durations between activities.

Similarly, if the project manager states that the last 5 days of a 20-day Activity C usually cannot be performed until Activity B is complete, the “fudge” of an FF5 relationship must be followed by vigilance to make the necessary adjustments if the remaining duration of C unexpectedly falls below 5 days. But, if the project manager states that the last 5 days of C cannot be performed until 30 percent of A is complete, the best a Scheduler can do with the tools available is utilize a SF8 relationship and place an appropriate explanation as a log or note *to the activity*, since notes cannot be attached to a relationship.

### 17.16. The Final Forward Pass

We return to the instruction given at the end of the first section of Chapter 15. After a short coffee break, the interview process should be repeated starting from the first activity, asking for each activity if all necessary predecessor logic, physical, crews, forms, equipment, materials, access, inspectors, and so forth, is either explicitly or implicitly in place. It may be useful to invite all major members of the project team,

including major subcontractors, vendors, and the owner and engineer, to this exercise.

### 17.17. The Final Backward Pass

One final pass should be made, starting from the last activity working backward, to delete any logic that has accidentally crept in. For example, it is a common error that a project manager may assign a crew to Activity A, then B, then C, then off to Activity X. Later, the project manager may assign another crew to Activity D, then E, then F, then off to Activity X. Obviously, Activity X requires only one of these two crews and the restraint from either Activity C or F (or both) should be cut. If the intent is the first crew available can do this work, neither should be listed as a hard restraint. Remember that the purpose of the CPM is to plan the work and not schedule full utilization of the resources. There are other software tools for that exercise.

### 17.18. Choosing the Algorithm for the Initial Schedule

The choices of algorithm for the initial schedule are fewer than those available for updates. However, some care must still be used in making these decisions. Moreover, this may be the best time to plan what choices will be made for future updates to the schedule. If it is desired to perform individual activities subject to a *FF* relationship without interruption, and moreover to not tell field forces that they *may* begin such activities earlier (but then be subject to interruption), the contiguous schedule duration switch should be chosen. However, if the crew foreman is to be given early notice that the activity *may* start, even if it may be interrupted, leaving the operational decision of exactly when to start such work to the foreman, choose the interruptible schedule duration switch.

Unless it is desired to have the computer close off open ends to the network that the Scheduler has left in error, the “show open ends as critical” switch should be used. Finally, if the use of non-traditional relationships may cause the  $LF - EF = TF$  to not equal the  $LS - ES = TF$ , it is generally recommended to print as the total float the more critical of the two.

Planning for the future, retained logic provides the more conservative (if often too conservative) result, but since the CPM is meant to act as a guide and not as explicit instructions to the field, the more conservative warning is usually recommended. Finally, unless coordinating between several software systems, such as P3 and SureTrak (which does not support the option), it is best to utilize the calculate start-to-start lag from actual start. If sharing files between the home office and field, running on either P3 or SureTrak (or between P3 and Microsoft

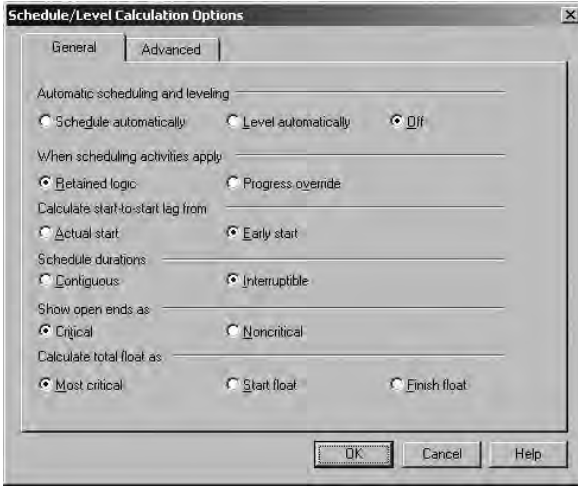

Figure 17.18.1 Schedule calculation algorithm switches.

Project), it is best to use the early start option. These switches are shown in Figure 17.18.1.

If using the latest Primavera flagship software, P3e/c or Primavera Construction, other options must be addressed such as shown in Figure 17.18.2. Choosing to ignore relationships to and from other projects begs the question why such were applied. If HQ required such to be shown, but not to be used in calculating the impact of such on this project, the option may be checked. A possible use may be for running various “what if” scenarios.

Similarly, if expected finish constraints are used properly, there should be no reason to not include their use in the calculation of the schedule.

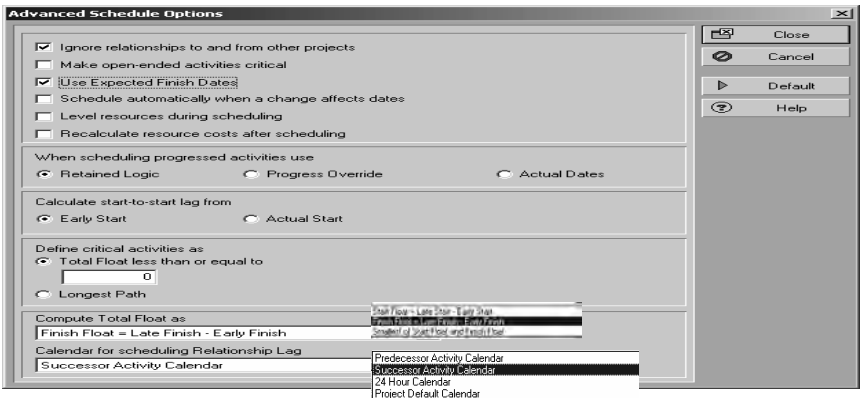

Figure 17.18.2 P3e/c advanced schedule options.



If they are now outmoded, it may be best to delete them rather than show a logic file that says one thing and has results based on another. Here again, the option may be used to good effect for “what if” planning.

Finally, the Scheduler must specify what calendar convention was used when specifying durations between activities or lags, either that of the predecessor (as in P3 and SureTrak), successor (as in Microsoft Project and Open Plan), a 24/7/365 calendar (having no holidays or non-work periods), or the default project calendar (however set by the Scheduler).

In the choices available for updates, a new option is available for calculating the finish date for work being performed out-of-sequence. The actual dates option allows the Scheduler to enter, as an actual date, the date on which it is now anticipated that the activity will be complete. Thus, rather than requiring the project manager to state that Activity A is 70 percent complete, or has 3 days remaining duration, the Scheduler can now accept “I plan to have it complete by next Tuesday.” Since this is poor scheduling practice, it is not recommended.

### 17.19. Summary

Setting and recording the relationships between activities is the step that distinguishes CPM from a ToDo list or a Gantt chart. It is important that the start of each activity (other than the first) be preceded by a relationship from another activity representing a physical dependency. Similarly, it is important that the finish of each activity (other than the last) be succeeded by a relationship to another activity representing a physical dependency. Assuming unlimited resources that would be enough; to account for less than unlimited resources, additional relationships may be placed between activities to communicate the preferred flow of such resources. Constraints, or locked in dates, should be used sparingly and should be properly documented for need.

It is recommended that the use of non-traditional relationships and lag durations between activities be kept to the minimum necessary to make the CPM easier to use in the field and not simply to make the preparation of the CPM easier. If used, a check must be performed to assure that the start of each activity has a predecessor and the finish of each activity has a successor. The Scheduler must work with the tools of the software being used to “fudge” what is said about relationships into what the software will accept, but then be vigilant in remembering and explaining the inaccuracies this causes.

A final walk through the project from start to end, and then from end back to start, is a good way to check that the CPM logic is correct. The Scheduler must take care in choosing what algorithm will be used in calculating the CPM so as to not have his/her careful work negated.

*This page intentionally left blank*

## **Example Project: The John Doe Project**

In this chapter, a basic network is planned for the construction of a combination plant-office-warehouse for a small industrial firm, the John Doe Company.

A plan of the entire complex is shown in Figure 18.3.1, and a perspective of the building and exterior elevations are shown in Figure 18.3.2. Figure 18.3.3 shows a site plan section of the electrical service and sewer. The floor plan for the plant is shown in Figure 18.3.4; the office in Figure 18.3.5; and the warehouse in Figure 18.3.6. The list of activities is broken down by building area where applicable. Exterior elevation views of the building are shown in Figure 18.3.2, and interior sections are shown in Figures 18.3.7 and 18.3.8.

### **18.1. Acquiring Information to Initial Schedule**

Creation of the logic network, as discussed in this chapter, may be slightly atypical in that a transcript of the interview process is not provided; rather, the results of the interview are presented. Also, since the reader may not be familiar with the construction techniques discussed, several lists of activities will be first itemized and only later placed in a logical order; a step not usually undertaken in the real world by a professional Scheduler.

The basis for the interview process includes the drawings as depicted in this chapter, additional drawings and specifications as may be envisioned, and facts and opinions known only to the project manager and other team members. For example, funding of the project is to be from current income of the owner and we will see the impact of this fact upon the logic network.

## 18.2. Choosing Appropriate Codes

What information may we wish to obtain from the completed CPM? Provision of the calculated dates (*ES*, *EF*, *LS* and *LF*) and total float (*TF*) are attributes of the algorithm and do not require additional coding. The project has several buildings and other structures, therefore, perhaps we want a code for location. There are several drawings and we certainly would want to note which drawing most exemplifies the scope of work being discussed. Several subcontractors will be employed, and the owner has indicated that he wishes to perform some portion of the work, possibly by other contractors. Since funding is an issue, an approximate cost for each activity may be useful; however, it is not contemplated that payment will be made from the CPM so that an exact cost is not necessary.

Durations will be, in part, determined by crew size and these assumptions should be recorded. Also, if the labor market in the locale of the project is tight, it will be important to know if the total manpower required exceeds the supply. For purposes of illustration in this text, these codes can be added to the logic network at varying times. However, in the real world, it may be close to impossible to get the team together again to add one more code for each activity and, therefore, as far as practicable, all such information would be collected for each activity at once.

## 18.3. Activity List

The site is in a low area overgrown with scrub timber and bushes; the soil is a sand and gravel mixture overlaid by clay. Cast-in-place piles will be driven to about 30 feet for the plant and warehouse foundations. The office building will be on spread footings. No water supply is available, so a well and a 50,000-gallon elevated water tower will be installed. Sewage and power trunk lines are 2000 feet away. Power connections will be by overhead pole line, up to 200 feet from the building; from this point in, the power line will run underground. The sewer will pass under part of the power line. The activities representing these areas are

- Survey and layout
- Drill well
- Clear site
- Install well pump
- Rough grade
- Install underground water supply

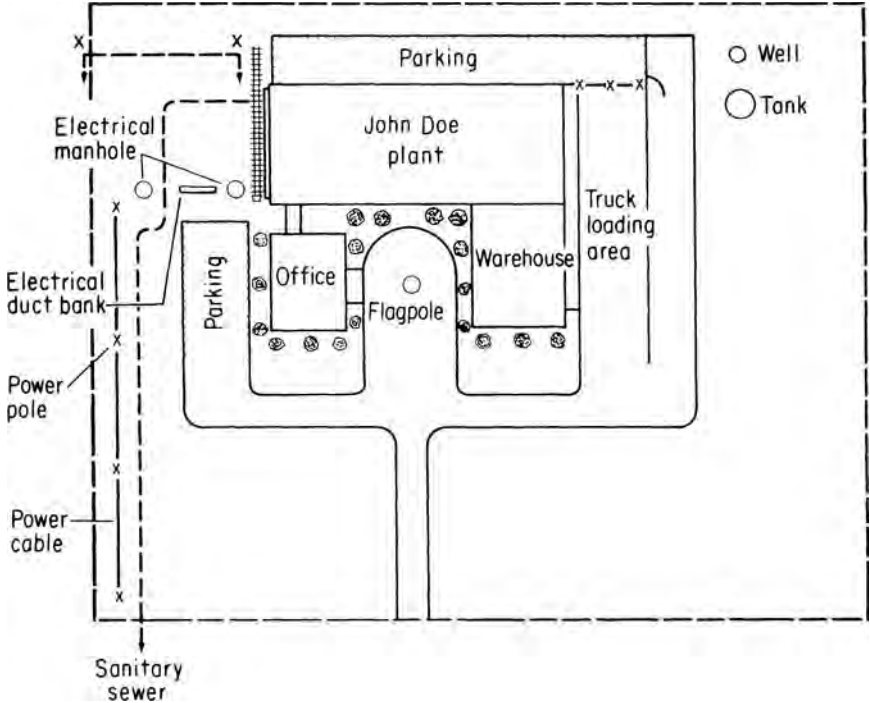
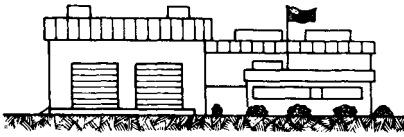
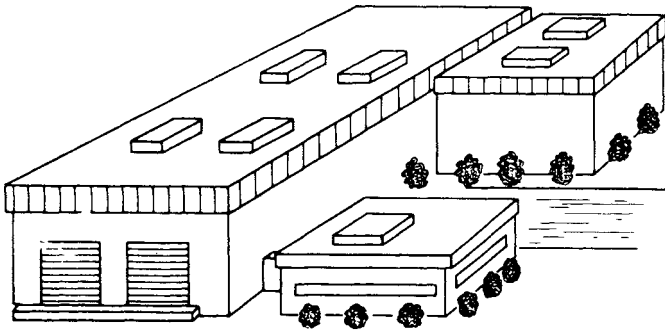
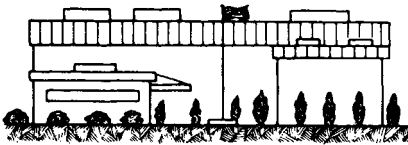

Figure 18.3.1 Site plan, John Doe project.

- Drive and pour piles
- Excavate for sewer
- Excavate plant and warehouse
- Install sewer
- Pour pile caps
- Set pole line
- Excavate office building
- Excavate for electrical manholes
- Pour spread footings
- Install electrical manholes
- Pour grade beams
- Energize power feeder
- Install power feeder



South elevation



East elevation

Figure 18.3.2 Building, John Doe Co., with elevations.

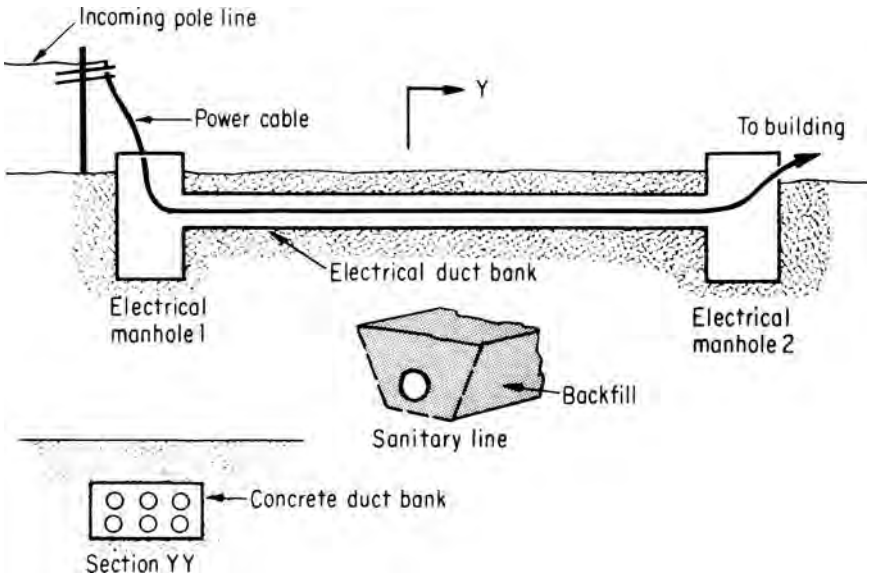

Figure 18.3.3 Electrical ductbank section XX. (See Figure 18.3.1.)

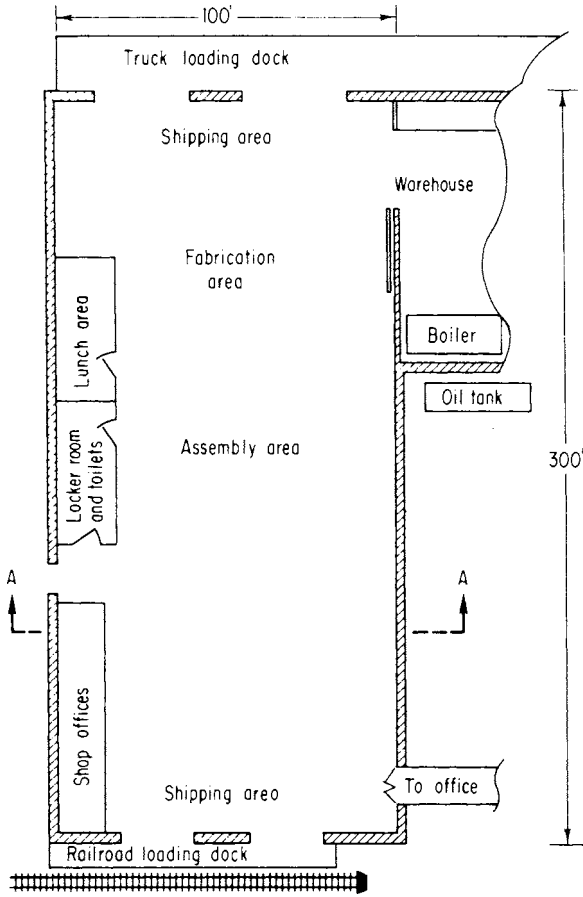

Figure 18.3.4 Plant floor plan.

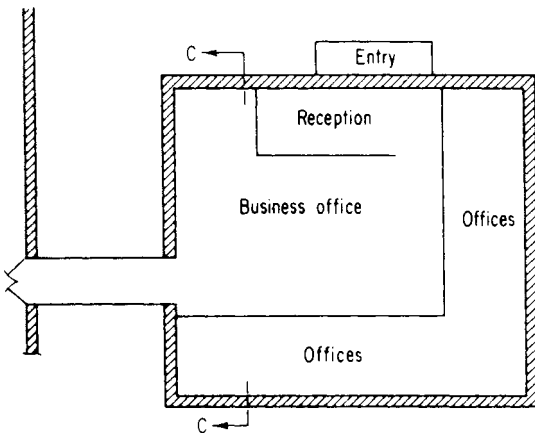

Figure 18.3.5 Office floor plan.

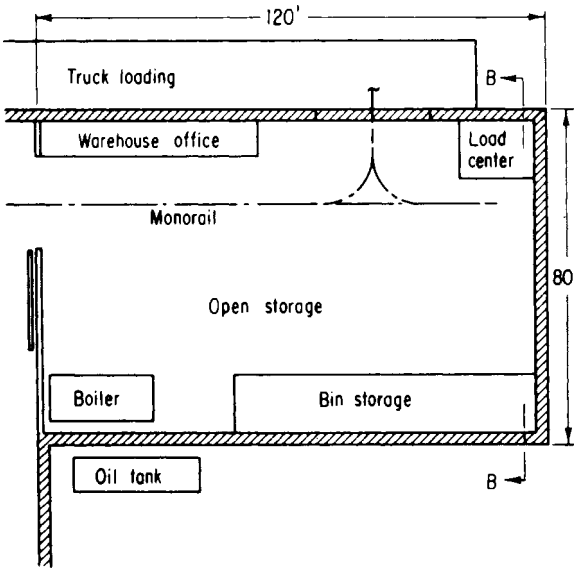

Figure 18.3.6 Warehouse floor plan.

The plant and warehouse structures are to be structural steel with high-tensile bolted connections. The plant will have an overhead craneway running the length of the building; the warehouse will have a monorail. The roof system will be bar joists and precast concrete planks covered with 20-year built-up roofing. The siding of both buildings will be insulated metal panels with insulated glass upper panels

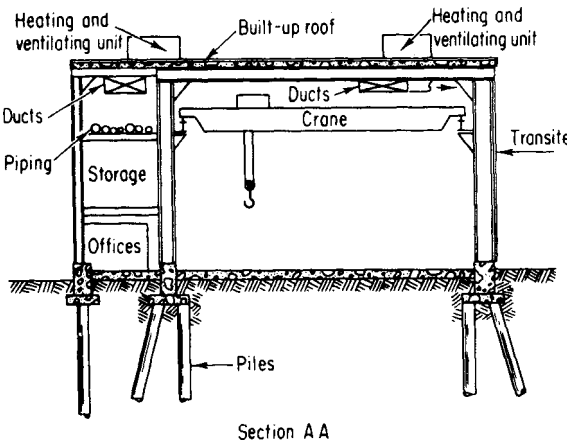
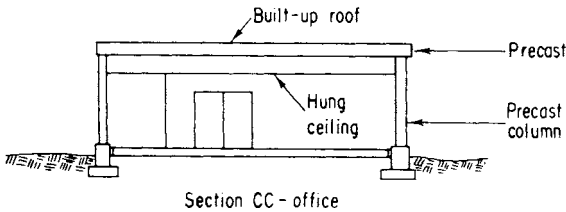
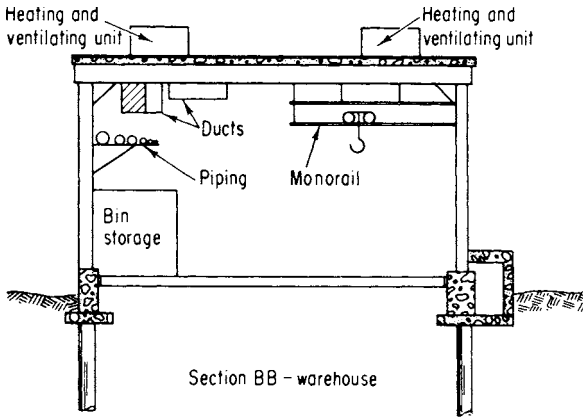

Figure 18.3.7 Interior section AA. (See Figure 18.3.4.)





**Figure 18.3.8** Interior sections BB and CC. (See Figures 18.3.5 and 18.3.6.)

to admit light. Both buildings will have concrete floor slabs, which will be poured on compacted sand. The activities representing this work are

- Erect structural steel
- Apply built-up roofing
- Bolt up steel
- Compact slab subgrade
- Erect craneway
- Install underslab plumbing
- Erect monorail track
- Pour floor slabs
- Install underslab conduit
- Erect bar joists
- Erect roof planks
- Erect siding

When the plant and warehouse shells are erected, interior partitions (offices, bathrooms, etc.) will be made of concrete block. The interior ceilings are hung with integrated HVAC and fluorescent light fixtures; the loading docks will be reinforced concrete. The railroad siding must be brought in from a spur line one mile away. This adds the following activities:

- Masonry partitions
- Grade and ballast
- Office ceilings
- Railroad siding
- Piping systems
- Form and pour truck loading dock
- Power conduit
- Form and pour railroad loading dock
- Branch conduit
- Install boiler
- Install electrical load center
- Install fuel tank
- Install power panel boxes
- Install plumbing fixtures
- Install power panel insides
- Crane
- Monorail
- Heating and ventilating units (roof)
- Paint interior
- Ceramic tile (lavatory and lunchroom)
- Pull wire
- Exterior doors
- Electrical fixtures
- Interior doors
- Floor tile (offices)
- Ductwork

The office building is designed as a precast concrete structure with masonry walls. The roof system is designed as precast planks with single-ply roofing. The partitions are to be metal studs with drywall.

The ceiling is to be hung. The building will have a self-contained air-conditioning unit. The activities include

- Erect precast structure
- Roofing
- Erect roof
- Exterior masonry (cavity wall)
- Windows and glaze
- Interior doors
- Paint interior
- Plumbing fixtures
- Paint exterior
- Ceramic tile (lavatory)
- Lighting panel
- Metal studs
- Wiring
- Trim and millwork
- Flooring
- Hung ceiling
- Exterior doors
- Drywall

The project outside work includes

- Fine grade
- Seed; plant shrubs and trees
- Flagpole
- Pave parking area
- Access road
- Area lighting
- Perimeter fence

#### **18.4. Could We Prepare a Bar Chart?**

At this point, having a detailed list of activities and perhaps (from the bid estimate) durations, we could easily prepare a bar chart. We can place each activity as a bar of duration length in a position following those other activities already placed. Of course, as we move down the

list of several hundred activities, the desire to check whether each new activity may have some impact upon an activity bar previously placed, and thus the requirement of determining all the other bars that will then have to be moved, decreases dramatically. If we are told, “good news, our subcontractor says that the activity can be done in half the time we expected,” we may simply choose not to go back and realign all the bars that could benefit from this news. Perhaps there is a better way to do this. Perhaps we should try using a CPM logic arrow diagram.

### 18.5. Network Logic in ADM

The first rough arrow diagram usually becomes the activity list. For a number of reasons, this owner elects to proceed in a definite fashion. To expedite the project, the site preparation and utilities work are to be put out as a separate package to be accomplished before the foundation contractor moves onto the site.

The foundation contract is to include pile driving, excavation, and all concrete for the plant, warehouse, and office.

Since the owner expects to finance the building from current income, the warehouse and plant areas must be completed before any work on the office building starts. Steel erection is to start after the slabs are poured. The office will be temporarily located in the warehouse while the office building is in construction.

Figure 18.5.1 represents the site preparation and utilities portion of the project. Note that the events have been numbered according to the traditional  $j > i$  and by the horizontal method.

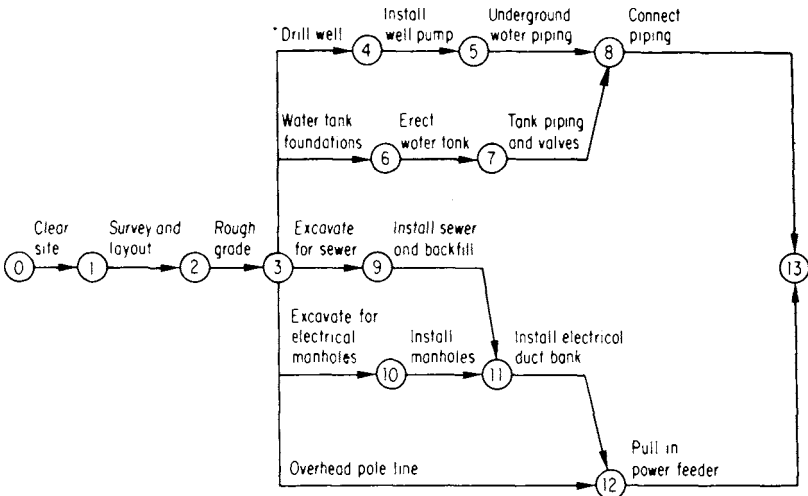

Figure 18.5.1 CPM network of site preparation and utilities.

**Event 0.** The project starts.

- 0–1 *Clear site.* Necessary before any survey work can start.
- 1–2 *Survey and layout.* Cannot start before the site is cleared; otherwise, many of the survey stakes would be lost in the clearing operation.
- 2–3 *Rough grade.* Cannot start until the area has been laid out. This activity ties up the whole site with earth-moving equipment.
- 3–4 *Drill well.* Cannot start until the rough grading operation is completed.
- 4–5 *Install well pump.* Cannot be done until well is completed and cased.
- 5–8 *Underground water piping.* Although this might be started earlier, the site contractor prefers to work from the pump toward the building site.
- 3–6 *Water tank foundation.* After the rough grading, these simple foundations can be installed.
- 6–7 *Erect water tank.* The water tank cannot be erected until the foundations are poured.
- 7–8 *Tank piping and valves.* Cannot be fabricated and erected until the tank is completed.
- 8–13 *Connect piping.* The water piping cannot be linked up until both sections are completed.
- 3–9 *Excavate for sewer.* Can be started after rough grading.
- 9–11 *Install sewer and backfill.* Immediately follows the sewer excavation, working from the low point uphill.
- 3–10 *Excavate for electrical manholes.* Can start after rough grading.
- 10–11 *Install electrical manholes.* Cannot start until the excavation is completed.
- 11–12 *Install electrical duct bank.* Is started after the electrical manholes are complete. The start of this also depends on the completion of the sewer line, because that line is deeper than the duct bank.
- 3–12 *Overhead pole line.* Can be started after the site is rough graded.
- 12–13 *Pull in power feeder.* Can start after both the duct bank and the overhead pole line are ready to receive the cable.

**Event 13.** The site preparation and utilities work are complete. Figure 18.5.2 represents the foundation and concrete work for the John Doe project.

- 13–14 *Building layout.* Necessary before foundation work can start.
- 14–15 *Drive and pour piles.* After layout, this is the first step in the plant and warehouse foundation work.
- 15–16 *Excavate.* Follows piping, including fine grading to finish grading.
- 16–17 *Pour pile caps.* Starts after the fine grading.
- 17–18 *Form and pour grade beams.* These are poured across the exterior pile caps in this project.

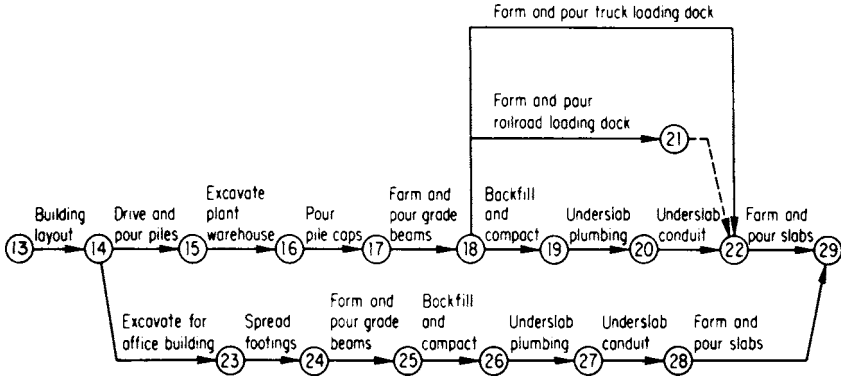

Figure 18.5.2 CPM network of foundation contract.

- 18–21 *Form and pour railroad loading dock.* This dock is essentially an extension of the grade beams.
- 18–22 *Form and pour truck loading dock.* This dock, at the opposite end of the building from the railroad dock, also backs on the grade beams.
- 18–19 *Backfill and compact.* Cannot start until the grade beams are ready to contain the fill.
- 19–20 *Underslab plumbing.* Cannot be installed until the backfill is complete.
- 20–22 *Underslab conduit.* Is installed after the plumbing because the plumbing lines are deeper.
- 22–29 *Form and pour slabs.* The loading dock sides and underslab preparation must be completed before the slabs are poured.
- 14–23 *Excavate for office building.* Can start after the building layout work is complete.
- 23–24 *Spread footings.* Can be placed after the excavation is done.
- 24–25 *Form and pour grade beams.* Are poured on top of the spread footings.
- 25–26 *Backfill and compact.* Is done after the grade beams are finished.
- 26–27 *Underslab plumbing.* Is installed in the backfill.

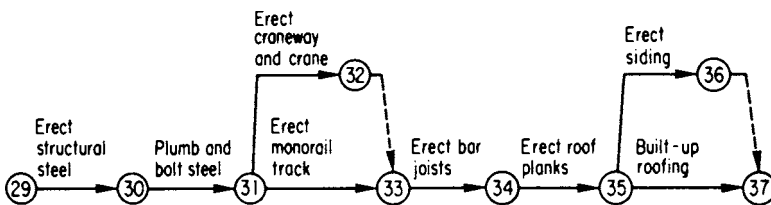

Figure 18.5.3 CPM network: close-in, plant, and warehouse.

- 27–28 *Underslab conduit.* Is installed on top of the plumbing lines.
- 28–29 *Form and pour slabs.* Can be done after the underslab preparations are complete.

**Event 29.** The foundations and concrete contract are completed. Figure 18.5.3 represents the erection of the framework for the plant and warehouse and also the closing-in of those buildings.

- 29–30 *Erect structural steel.* Follows the completion of foundations.
- 30–31 *Plumbing and bolt steel.* Cannot be done until the steel has been erected.
- 31–32 *Erect craneway and crane.* Can be done after the steel is bolted up. To make rigging easier, it is planned before the installation of the bar joists system.
- 31–33 *Erect monorail track.* Although this is not as difficult to erect as the craneway, it is convenient to erect it before the bar joists.
- 33–34 *Erect bar joists.* Can start after structural steel and major rigging are erected.
- 34–35 *Erect roofplanks.* Cannot be done until the bar joists system is complete.
- 35–37 *Single ply roofing.* Goes on top of the roof planks.
- 35–36 *Erect siding.* Follows the roof planking for safety reasons and because the flashing detail makes it more practical.

**Event 37.** The building is closed in, and interior work can start. Figure 18.5.4 represents the interior work for the plant and warehouse. At this point, the general, mechanical, and electrical contractors can initiate activities.

- 37–38 *Set electrical load center.* Located on the slab in the warehouse. This is a package unit.
- 37–43 *Power panel backing boxes.* Can be mounted on the masonry walls and structural steel.
- 38–43 *Power conduit.* Main runs start after the electrical load center is set in place.
- 43–49 *Install branch conduit.* These runs follow the installation of the main conduit runs and the backing boxes for the power panels.
- 49–50 *Pull wire.* Follows completion of the conduit system.
- 50–54 *Terminate wires.* These are terminated after the panel internals are in place.
- 55–56 *Ringout.* After the wiring is connected, the circuits are checked out.
- 45–51 *Room outlets.* Start after branch conduit and drywall are complete.

Logical restraints 49–45 and 44–45 operate as spreaders. If 44–45 were not there, “ceramic tile” would depend on “branch conduit.” If 49–45 were not there, “pull wire” would depend on “drywall.”

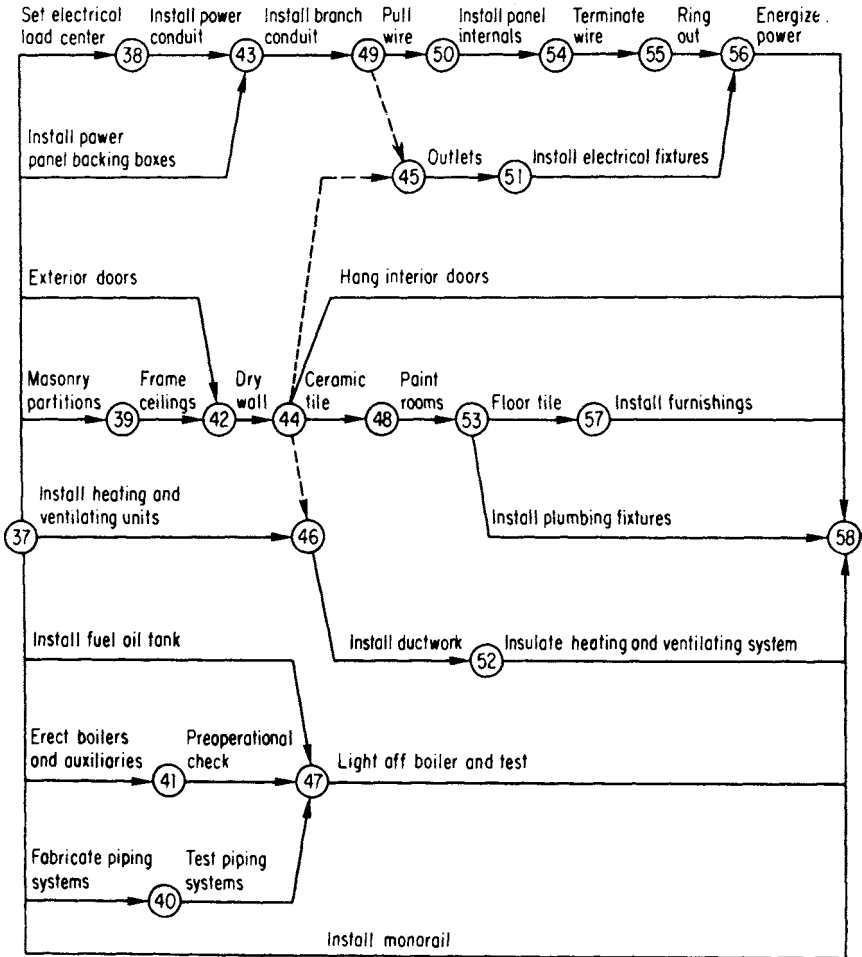

Figure 18.5.4 CPM network: interior work, plant, and warehouse.

- 51–56 *Install electrical fixtures.* Follows the completion of the room outlets.
- 37–39 *Masonry partitions.* Start as soon as the building is closed in.
- 39–42 *Hung ceiling.* Is supported on the masonry partitions.
- 37–42 *Exterior doors.* Can be hung after the building is closed in, but must be installed prior to the drywall.
- 42–44 *Drywall.* Cannot start until the building is weather-tight and the partitions are framed out. (Includes studs and door bucks.)
- 44–58 *Hang interior doors.* Can follow drywall installation.
- 44–48 *Ceramic tile.* Can follow drywall.
- 48–53 *Paint rooms.* Follows the drywall and ceramic tile installation.
- 53–57 *Floor tile.* Should be held off until room painting is complete.



- 57–58 *Furnishings.* Are installed last.
- 53–58 *Plumbing fixtures.* Are installed after painting.
- 37–46 *Install heating and ventilating units.* Can be installed after the built-up roofing; they are on the roof.
- 46–52 *Ductwork.* Can be installed after the heating and ventilating units and room drywall are complete.
- 52–58 *Insulate heating and ventilating ducts.* Cannot be done until the ductwork is in place.
- 37–41 *Erect boiler and auxiliaries.* Equipment is in the warehouse, and erection is best done after the warehouse is closed in. The unit is small enough to move through the regular shipping door.
- 41–47 *Preoperational check.* A routine check after the boiler is installed.
- 37–40 *Fabricate piping systems.* Can be done after the building is closed in.
- 40–47 *Testing piping.* Follows completion of the piping systems.
- 37–47 *Install fuel oil tank.* Is planned to start after the building siding is on so that the excavation will not interfere with the siding work.
- 47–58 *Light off the boiler.* Cannot be done until the piping systems are tested, boiler is checked out, and fuel oil tank is ready.
- 37–58 *Install monorail.* Can be done any time between the close-in and completion of the building.

Figure 18.5.5 represents the structure and interior work for the office building. At the owner's request, this follows the completion of the plant and warehouse, which occurs by event 58.

- 58–59 *Erect precast.* The first operation in the office building, since the foundations were previously prepared.
- 59–60 *Erect roof.* Must follow the erection of the structure. Because it uses the same crane rigging, it follows closely.
- 60–61 *Exterior masonry.* Follows the roof erection.
- 60–76 *Package air-conditioning.* Can be set as soon as the roof is completed.
- 61–77 *Ductwork.* Can commence when the building is closed in. If started earlier, this operation would interfere with the masonry scaffolds.
- 61–63 *Built-up roofing.* Follows masonry so that the roofers are not mopping tar on the masons, which might be called preferential logic—the operation could physically commence at event 60.
- 61–62 *Exterior doors.* Installation must wait for the door bucks, which go up with the masonry.
- 61–68 *Glazing.* Is done in the windows, which went up with the exterior masonry.
- 61–64 *Piping installation.* Can start after the exterior masonry is closed in.
- 61–65 *Install backing boxes.* Since the boxes mount on the masonry and structure, the installation can start after the masonry is placed.
- 63–80 *Paint exterior.* Starts after the roofing is on and the doors are installed.

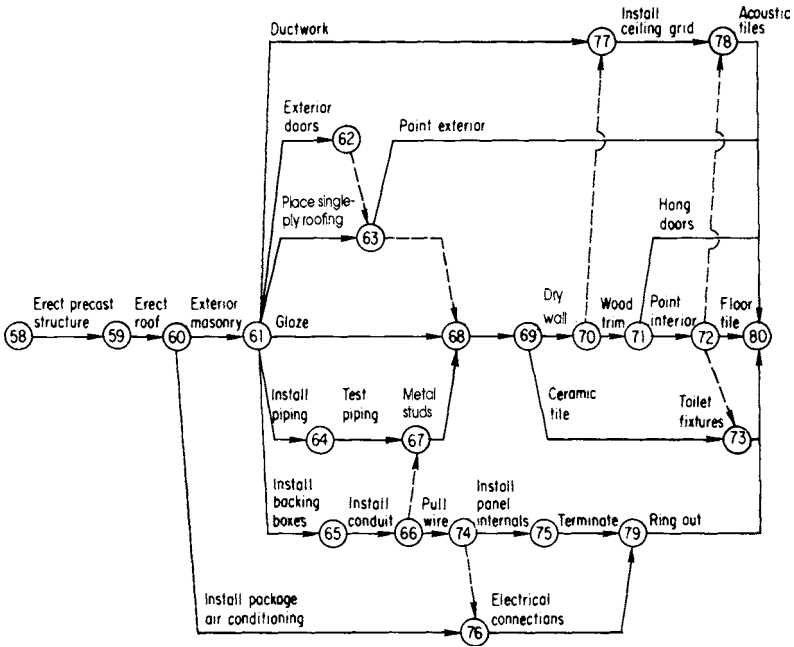

Figure 18.5.5 CPM network: office building.

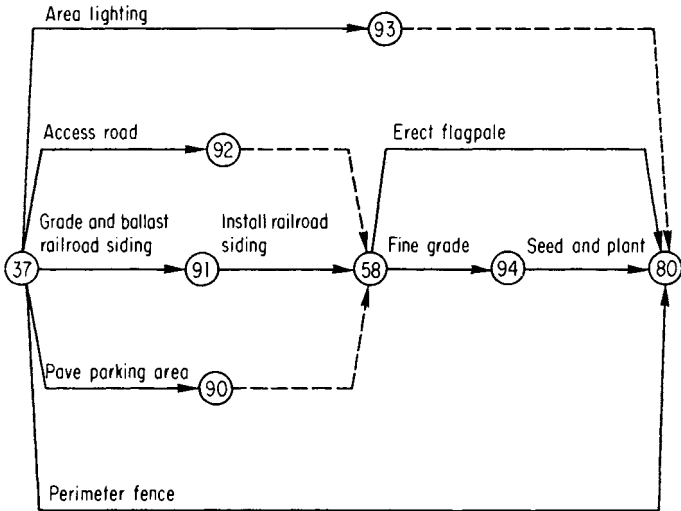

Figure 18.5.6 CPM network: site work.

- 64–67 *Test piping.* Follows the piping installation.
- 65–66 *Install conduit.* Follows backing boxes, since this is smaller branch conduit rather than a main feeder.
- 66–74 *Pull wire.* Done after the conduit is in place.
- 67–67 *Metal studs.* Follow the piping tests and the conduit installation because portions of these systems are embedded in or behind the drywall.
- 68–69 *Drywall.* Cannot start until the building is weather-tight (“glaze,” “roofing,” and “exterior doors”) and the metal studs are installed.
- 69–70 *Restraint.*
- 69–73 *Ceramic tile.* Also follows drywall.
- 70–71 *Wood trim.* Placed after the drywall.
- 71–72 *Paint interior.* Follows the wood trim.
- 72–80 *Floor tile.* Follows the painting in order to protect the tile.
- 73–80 *Lavatory fixtures.* Installed after the interior painting and ceramic tile in order to protect the fixtures.
- 74–75 *Install electrical panel internals.* Follows the pulling of wires.
- 75–79 *Terminate wires.* Follows the installation of panel internals.
- 76–79 *Electrical connections (air-conditioning).* Follows the air-conditioning equipment installation and the electrical panel installation.
- 77–78 *Install ceiling grid.* Is preceded by ductwork and the drywall.
- 78–80 *Acoustic tiles.* Can be installed after the ceiling grid is installed and the interiors are painted.
- 79–80 *Ringout.* Of electrical systems; comes after systems are complete.

Figure 18.5.6 represents the site work, which starts when the structural work is completed (event 37). Note that random numbering was used for this diagram because all digits up to 80 had been used in preceding sections of the diagram. All of the following can commence when the structural contractor moves off the site.

- 37–93 *Area lighting.*
- 37–92 *Access road.*
- 37–91 *Grade and ballast railroad siding.*
- 37–90 *Pave parking areas.*
- 37–80 *Perimeter fence.*
- 91–58 *Railroad siding.* Follows grading and ballast of the bed.

The access road, parking, and railroad siding have to be ready by the completion of the plant and warehouse (event 58). The final activities for the office building include

- 58–80 *Erect flagpole.*
- 58–94 *Fine grade.*
- 94–80 *Seed and plant.*

In preparing the six sections of the CPM description of the John Doe project, the standard routine of considering the overall project by its several physical components was followed. This family of individual networks can be effective. If drawing space is a limitation, the drawings could be sheets one through six of one network.

### **18.6. Logic Changes Examples**

If the initial logic is incorrect or the situation changes, the network is changed by adding to, deleting from, or revising the logic network. For instance:

**Example 1.** What changes to the John Doe network would be required to run the office building in parallel with the plant and warehouse?

**Solution.** To run the office building in parallel with the plant and warehouse, only two activities must be changed:

28–29     Connects directly to the start of the office. To do this, change 28–29 to 28–99.

58–59     Must be unconnected from the warehouse completion. Change 68–59 to 99–59.

**Example 2.** If the sewer passes under the water tank location, what work sequence changes are necessary?

**Solution.** If the sewer passes under the water tank foundations, activity 9–11, install sewer, will have to precede 3–6, tank foundations. Do not do this with restraint 11–3 or you will have a loop. First, add a spreader restraint between event 3 and the start of the tank foundations.

**Example 3.** If the plant building underslab plumbing is deeper than the office building sewer, how is the restriction shown?

**Solution.** If the plant plumbing is deeper than the office sewer, a restraint activity, 20–26, might be in order.

**Example 4.** If the electrical load center is to be masonry-enclosed, show the changes required.

**Solution.** To show the electrical load center enclosed, a restraint from event 38 to the start of masonry partitions is necessary. Activity 37–39 must be preceded by a restraint to avoid a loop.

**Example 5.** If the boiler is too large for the building doors, how are the necessary logical changes shown?

**Solution.** If the boiler is too large for the building doors, activity 35–36, erect siding, must be amended to leave an opening for the boiler in the warehouse section. Then an activity, 47–42, must be added to close in the building before drywall is erected.

**Example 6.** If the primary power feeder is to be pulled in by the building contractor, what changes are necessary?

**Solution.** If the power feeder is to be pulled in by the building contractor, activity 12–13 must be replaced by a restraint, 12–13. Also, an activity 37–66, power feeder, must be added.

**Example 7.** If “boiler test” depends on regular power, what changes are required in the diagram?

**Solution.** If “boiler test” (activity 47–58) depends on “power availability, a restraint from 56–58 completion to event 47 is necessary: Activity 56–58 must be followed by a restraint to avoid a loop.

In these examples, the changed logic is always tested for loops. This is especially true when the revised logic requires a connection from a lower  $j$  to a higher number  $i$ . It is permissible to violate the  $j > i$  rule when necessary, but doing so increases the opportunity for loops.

### 18.7. Network Logic in PDM

The same network in PDM format is shown in Figures 18.7.1, 18.7.2, and 18.7.3. Figure 18.7.1 depicts the logic up to the point where the two buildings could be built one-at-a-time or concurrently. Figure 18.7.2

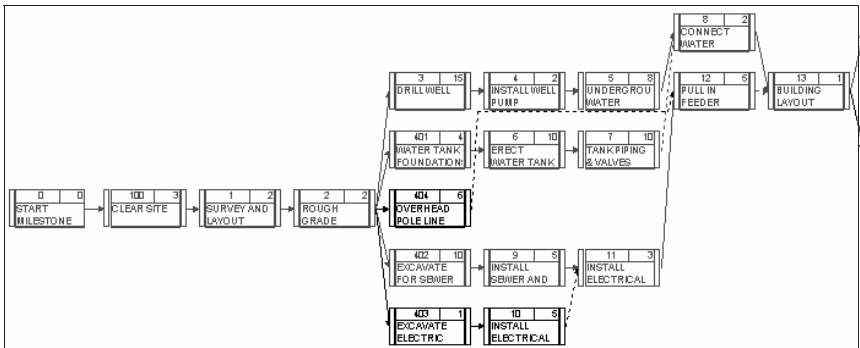

Figure 18.7.1 John Doe in PDM initial site work.

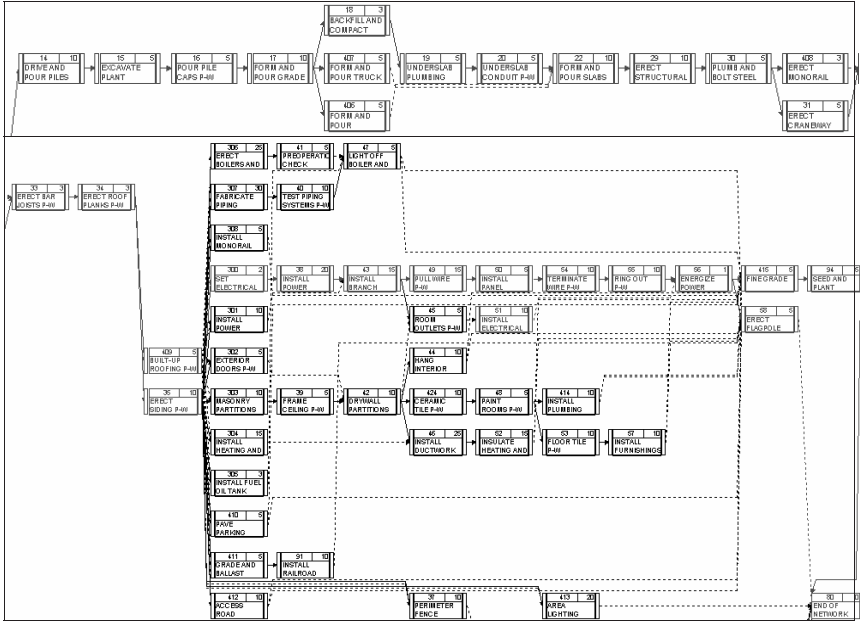

Figure 18.7.2 John Doe in PDM Plant-Warehouse.

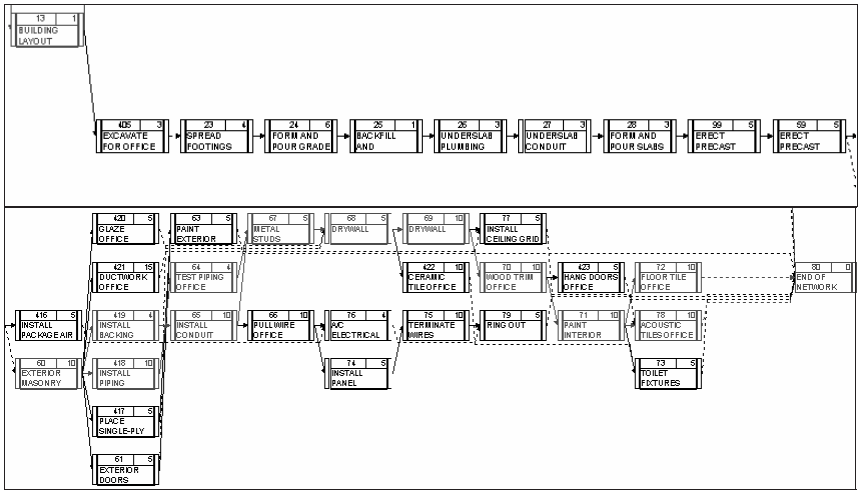

Figure 18.7.3 John Doe in PDM Office.

Contract/Category
1. Site work
2. Foundation
3. Close-in PW
4. Office
5. Procurement

Figure 18.8.1 Contract Category Codes.

depicts work on the warehouse and Figure 18.7.3 depicts work on the office. Whether the logic between activities in this straight-forward conversion (involving only traditional finish-to-start restraints without lags) is more or less understandable than the ADM diagrams, is left to the individual student’s opinion.

**18.8. Populating the Codes**

Assume the project team desires only two codes and that these include Contract/Category and Trade/Subcontract. A code dictionary could be created, as suggested in Figures 18.8.1 and 18.8.2. Pure CPM calculations then can generate a printout, as shown in Figure 18.8.3.

**18.9. Checking the Output**

The computer output should be checked for errors. This is quite important, because CPM data are susceptible to error when transferred from the network to computer.

Failure to check the computer output has caused embarrassment more than once. In one instance, the head of a school board received a telegram stating “Good news!,” which went on to advise him that his project end date had improved by 3 weeks. This was followed several

Trade/Subcontract		
1. Excavate and backfill	10. Water tank	19. Drywall
2. Survey and layout	11. Piles	20. Tile
3. Concrete	12. Siding	21. Doors
4. Electrical	13. Roofing	22. Paint
5. Plumbing	14. Masonry	23. Floor tile
6. Structural/rigging	15. Fencing	24. Furnishings
7. Precast	16. Paving	25. Glaze
8. HVAC	17. RR siding	26. Carpentry
9. Well	18. Hung ceilings	27. Site work

Figure 18.8.2 Trade subcontract codes.

I	J	DURATION			DESCRIPTION	START		FINISH		TOTAL FLOAT
						EAR	LAT	EAR	LAT	
0	1	3	1	1	CLEAR SITE			3	3	0
1	2	2	1	2	SURVEY AND LAYOUT	3	3	5	5	0
2	3	2	1	1	ROUGH GRADE	5	5	7	7	0
3	4	15	1	9	DRILL WELL	7	7	22	22	0
3	6	4	1	3	WATER TANK FOUNDATIONS	7	8	11	12	1
3	9	10	1	1	EXCAVATE FOR SEWER	7	11	17	21	4
3	10	1	1	1	EXCAVATE ELECTRICAL MANHOLES	7	20	8	21	13
3	12	6	1	4	OVERHEAD POLE LINE	7	23	13	29	16
4	5	2	1	9	INSTALL WELL PUMP	22	22	24	24	0
5	8	8	1	5	UNDERGROUND WATER PIPING	24	24	32	32	0
6	7	10	1	10	ERECT WATER TOWER	11	12	21	22	1
7	8	10	1	10	TANK PIPING AND VALVES	21	22	31	32	1
8	13	2	1	10	CONNECT WATER PIPING	32	32	34	34	0
9	11	5	1	5	INSTALL SEWER AND BACKFILL	17	21	22	26	4
10	11	5	1	4	INSTALL ELECTRICAL MANHOLES	8	21	13	26	13
11	12	3	1	4	ELECTRICAL DUCT BANK	22	26	25	29	4
12	13	5	1	4	PULL IN POWER FEEDER	25	29	30	34	4
13	14	1	2	2	BUILDING LAYOUT	34	34	35	35	0
14	15	10	2	11	DRIVE AND POUR PILES	35	35	45	45	0
14	23	3	2	1	EXCAVATE FOR OFFICE BUILDING	35	65	38	68	30
15	16	5	2	1	EXCAVATE FOR PLANT WAREHOUSE	45	45	50	50	0
16	17	5	2	3	POUR PILE CAPS PLANT-WAREHSE	50	50	55	55	0
17	18	10	2	3	FORM + POUR GRADE BEAMS P-W	55	55	65	65	0
18	19	3	2	1	BACKFILL AND COMPACT P-W	65	65	68	68	0
18	21	5	2	3	FORM + POUR RR LOAD DOCK P-W	65	73	70	78	8
18	22	5	2	3	FORM + POUR TK LOAD DOCK P-W	65	73	70	78	8
19	20	5	2	5	UNDERSLAB PLUMBING P-W	68	68	73	73	0
20	22	5	2	4	UNDERSLAB CONDUIT P-W	73	73	78	78	0
21	22	0			RESTRAINT	70	78	70	78	8
22	29	10	2	3	FORM + POUR SLABS P-W	78	78	88	88	0
23	24	4	2	3	SPREAD FOOTINGS OFFICE	38	68	42	72	30
24	25	6	2	3	FORM + POUR GRADE BEAMS OFF	42	72	48	78	30
25	26	1	2	1	BACKFILL + COMPACT OFFICE	48	78	49	79	30
26	27	3	2	5	UNDERSLAB PLUMBING OFFICE	49	79	52	82	30
27	28	3	2	4	UNDERSLAB CONDUIT OFFICE	52	82	55	85	30
28	29	3	2	3	FORM + POUR OFFICE SLAB	55	85	58	88	30
29	30	10	3	6	ERECT STRUCT STEEL P-W	88	89	98	98	0
30	31	5	3	6	PLUMB STEEL AND BOLT P-W	98	98	103	103	0
31	32	5	3	6	ERECT CRANE WAY AND CRANE P-W	103	103	108	108	0
31	33	3	3	6	ERECT MONORAIL TRACK P-W	103	105	106	108	2
32	33	0			RESTRAINT	108	108	108	108	0
33	34	3	3	6	ERECT BAR JOISTS P-W	108	108	111	111	0
34	35	3	3	7	ERECT ROOF PLANKS P-W	111	111	114	114	0
35	36	10	3	12	ERECT SIDING P-W	114	114	124	124	0
35	37	5	3	13	BUILT UP ROOFING P-W	114	119	119	124	5
36	37	0			RESTRAINT	124	124	124	124	0

Figure 18.8.3 John Doe Output-Ordinal Dates.



I	J	DURATION			DESCRIPTION	START		FINISH		TOTAL FLOAT
						EAR	LAT	EAR	LAT	
37	38	2	3	4	SET ELECTRICAL LOAD CENTER PW	124	124	126	126	0
37	42	5	3	6	ERECT EXTERIOR DOORS P-W	124	147	129	152	23
37	43	10	3	4	POWER PANEL BACKFILL BOXES P-W	124	136	134	146	12
37	39	10	3	14	MASONRY PARTITIONS P-W	124	137	134	147	13
37	46	15	3	8	INSTALL H + V UNITS P-W	124	147	139	162	23
37	40	30	3	8	FABRICATE PIPING P-W	124	157	154	187	33
37	41	25	3	8	ERECT BOILER + AUXILIARY P-W	124	167	149	192	43
37	47	3	3	8	INSTALL FUEL TANK P-W	124	154	127	197	70
37	58	5	3	6	INSTALL MONORAIL WAREHOUSE	124	197	129	202	73
37	80	10	5	15	PERIMETER FENCE	124	276	134	286	152
37	90	5	5	16	PAVE PARKING AREA	124	197	129	202	73
37	91	5	5	17	GRADE + BALLAST RR SIDING	124	187	129	192	63
37	92	10	5	16	ACCESS ROAD	124	192	134	202	68
37	93	20	5	4	AREA LIGHTING	124	266	144	286	142
38	43	20	3	4	INSTALL POWER CONDUIT P-W	126	126	146	146	0
39	42	5	3	18	FRAME CEILINGS P-W	134	147	139	152	13
40	47	10	3	8	TEST PIPING SYSTEMS P-W	154	187	164	197	33
41	47	5	3	8	PREOPERATIONAL BOILER CHECK	149	192	154	197	43
42	44	10	3	19	DRYWELL PARTITIONS P-W	139	152	149	162	13
43	49	15	3	4	INSTALL BRANCH CONDUIT P-W	146	146	161	161	0
44	45	0			RESTRAINT	149	186	149	186	37
44	46	0			RESTRAINT	149	162	149	162	13
44	48	10	3	20	CERAMIC TILE	149	167	159	177	18
44	58	10	3	21	HANG INTERIOR DOORS P-W	149	192	159	202	43
45	51	5	3	4	ROOM OUTLETS P-W	161	186	166	191	25
46	52	25	3	8	INSTALL DUCTWORK P-W	149	162	174	187	13
47	58	5	3	8	LIGHTOFF BOILER AND TEST	164	197	169	202	33
48	53	5	3	22	PAINT ROOMS P-W	159	177	164	182	18
49	45	0			RESTRAINT	161	186	161	186	25
49	50	15	3	4	PULL WIRE P-W	161	161	176	176	0
50	54	5	3	4	INSTALL PANEL INTERNALS P-W	176	176	181	181	0
51	56	10	3	4	INSTALL ELECTRICAL FIXTURES	166	191	176	201	25
52	58	15	3	8	INSULATE H + V SYSTEM P-W	174	187	189	202	13
53	57	10	3	22	FLOOR TILE P-W	164	182	174	192	18
53	58	10	3	5	INSTALL PLUMBING FIXTURES P-W	164	192	174	202	28
54	55	10	3	4	TERMINATE WIRES P-W	181	181	191	191	0
55	56	10	3	4	RINGOUT P-W	191	191	201	201	0
56	58	1	3	4	ENERGIZE POWER	201	201	202	202	0
57	58	10	3	24	INSTALL FURNISHING P-W	174	192	184	202	18
58	59	5	4	7	ERECT PRECAST STRUCT. OFFICE	202	202	207	207	0
58	94	5	5	1	FINE GRADE	202	276	207	281	74
58	80	5	5	29	ERECT FLAGPOLE	202	281	207	286	79
59	60	5	4	7	ERECT PRECAST ROOF OFFICE	207	207	212	212	0
60	61	10	4	14	EXTERIOR MASONRY OFFICE	212	212	222	222	0
60	76	5	4	8	INSTALL PACKAGE AIR CONDITR	212	272	217	277	60
61	62	5	4	21	EXTERIOR DOORS OFFICE	222	236	227	241	14

Figure 18.8.3 (Continued)

I	J	DURATION			DESCRIPTION	START		FINISH		TOTAL FLOAT
						EAR	LAT	EAR	LAT	
61	63	5	4	17	ROOFING OFFICE	222	236	227	241	14
61	77	15	4	8	DUCTWORK OFFICE	222	256	237	271	34
61	68	5	4	25	GLAZE OFFICE	222	236	227	241	14
61	64	10	4	8	INSTALL PIPING OFFICE	222	222	232	232	0
61	65	4	4	4	INSTALL ELEC BACKING BOXES	222	222	226	226	0
62	63	0			RESTRAINT	227	241	227	241	14
63	68	0			RESTRAINT	227	241	227	241	14
63	80	5	4	22	PAINT OFFICE EXTERIOR	227	281	232	286	54
64	67	4	4	8	TEST PIPING OFFICE	232	232	236	236	0
65	66	10	4	4	INSTALL CONDUIT OFFICE	226	226	236	236	0
66	67	0			RESTRAINT	236	236	236	236	0
66	74	10	4	4	PULL WIRE OFFICE	236	256	246	266	20
67	68	5	4	19	PARTITIONS OFFICE	236	236	241	241	0
68	69	5	4	19	DRYWALL OFFICE	241	241	246	246	0
69	70	10	4	19	DRYWALL OFFICE	246	246	256	256	0
69	73	10	4	20	CERAMIC TILE OFFICE	246	271	256	281	25
70	77	0			RESTRAINT	256	271	256	271	15
70	71	10	4	26	WOOD TRIM OFFICE	256	256	266	266	0
71	72	10	4	22	PAINT INTERIOR OFFICE	266	266	276	276	0
71	80	5	4	21	HANG DOORS OFFICE	266	281	271	286	15
72	80	10	4	20	FLOOR TILE OFFICE	276	276	286	286	0
72	78	0			RESTRAINT	276	276	276	276	0
72	73	0			RESTRAINT	276	281	276	281	5
73	80	5	4	5	TOILET FIXTURES OFFICE	276	281	281	286	5
74	76	0			RESTRAINT	246	277	246	277	31
74	75	5	5	4	INSTALL PANEL INTERNALS OFFICE	246	266	251	271	20
75	79	10	4	4	TERMINATE WIRES OFFICE	251	271	261	281	20
76	79	4	4	4	AIR CONDITIONING ELEC CONNECT	246	277	250	281	31
77	78	5	4	18	INSTALL CEILING GRID OFFICE	256	271	261	276	15
78	80	10	4	18	ACOUSTIC TILE OFFICE	276	276	286	286	0
79	80	5	4	4	RINGOUT ELEC.	261	281	266	286	20
90	58	0			RESTRAINT	129	202	129	202	73
91	58	10	5	17	INSTALL RR SIDING	129	192	139	202	63
92	58	0			RESTRAINT	134	202	134	202	68
93	80	0			RESTRAINT	144	286	144	286	142
94	80	5	5	27	SEED + PLANT	207	281	212	286	74
					E N D					

Figure 18.8.3 (Continued)

hours later by another telegram that should have been in red ink (to match the consultant's face). It noted that an error in the run had been overlooked, and the project date had really been delayed by one week.

The computer can be programmed to locate many mechanical errors, but it will not object to a statement that the moon is made of green cheese, nor can it pass on the practicality of CPM results.

The human factor is indispensable, which is one advantage to manual computation. Although people may make many small errors, they are not likely to miss a big mistake. For instance, in a hand calculation, a loop will not just slip by, but it fools the computer every time.

It is also a good idea to trace the critical path on the CPM network. To assist in checking this, a list of activities in order of total float is useful. First, the critical activities are listed and then the float is listed in ascending order. The list is also useful for a fast review of the project by management. Figure 18.9.1 shows the sort by total float for the John Doe project.

Another popular list is the *early start* sort where the activities are listed in order of early start (*ES*) times. This list exhibits the activities in the order in which they *could* start. The activities for each date are listed, starting with the critical and low-float activities. Figure 18.9.2 shows the early start sort for the John Doe project. Figure 18.9.3 shows the John Doe project listed by work category.

Although these and other sorts can be useful, it is important not to get bogged down generating great amounts of data. Large amounts of data are more likely to alienate field people than impress them. CPM is only half as effective if people in the field do not actively participate in the preparation and use of the information.

To work effectively with field people, find out what information they want and the form in which they want it in. One field superintendent asked, "Will CPM shorten my scheduling work?" We gave him a hardy "yes"; then he noted that it would take him a considerable length of time just to page through the 2-inch stack of paper that was the early start sort for his project.

As a result of his constructive criticism, we began furnishing him only the listing of work for the next 2 months in both early- and late-start formats. There was no need to supply CPM information for the next year when we were furnishing a new computer run each month.

For management, the early start sort is usually too detailed, making it difficult to see the forest for the trees. A sort of critical and near-critical activities are sufficient to report on the project status in clear and concise terms.

Another caution about computed CPM information: It will be no better than the input of network information. A soil mechanics professor had a similar caution about soil strength formulas. He advised against formulas integrating, differentiating, and extrapolating field information to the  $n$ th degree. His premise was that there is an inherent danger in cloaking rough field data in polished mathematical formulas.

In one refinery application, the field was unresponsive even to the abbreviated early start sort. One of the plant engineers had an inspiration and, with scissors, cut out the description list (less all the computed activity

I	J	DURATION			DESCRIPTION	START		FINISH		TOTAL FLOAT
						EAR	LAT	EAR	LAT	
0	1	3	1	1	CLEAR SITE			3	3	0
1	2	2	1	2	SURVEY AND LAYOUT	3	3	5	5	0
2	3	2	1	1	ROUGH GRADE	5	5	7	7	0
3	4	15	1	7	DRILL WELL	7	7	22	22	0
4	5	2	1	5	INSTALL WELL PUMP	22	22	24	24	0
5	8	8	1	5	UNDERGROUND WATER PIPING	24	24	32	32	0
8	13	2	1	5	CONNECT WATER PIPING	32	32	34	34	0
13	14	1	2	2	BUILDING LAYOUT	34	34	35	35	0
14	15	10	2	7	DRIVE AND POUR PILES	35	35	45	45	0
15	16	5	2	1	EXCAVATE FOR PLANT WAREHOUSE	45	45	50	50	0
16	17	5	2	3	POUR PILE CAPS PLANT-WAREHSE	50	50	55	55	0
17	18	10	2	3	FORM + POUR GRADE BEAMS P-W	55	55	65	65	0
18	19	3	2	1	BACKFILL AND COMPACT P-W	65	65	68	68	0
19	20	5	2	5	UNDERSLAB PLUMBING P-W	68	68	73	73	0
20	22	5	2	4	UNDERSLAB CONDUIT P-W	73	73	78	78	0
22	29	10	2	3	FORM + POUR SLABS P-W	78	78	88	88	0
29	30	10	3	6	ERECT STRUCT STEEL P-W	88	88	98	98	0
30	31	5	3	6	PLUMB STEEL AND BOLT P-W	98	98	103	103	0
31	32	5	3	6	ERECT CRANE WAY AND CRANE P-W	103	103	108	108	0
32	33	0			RESTRAINT	108	108	108	108	0
33	34	3	3	6	ERECT BAR JOISTS P-W	108	108	111	111	0
34	35	3	3	6	ERECT ROOF PLANKS P-W	111	111	114	114	0
35	36	10	3	7	ERECT SIDING P-W	114	114	124	124	0
36	37	0			RESTRAINT	124	124	124	124	0
37	38	2	3	4	SET ELECTRICAL LOAD CENTER PW	124	124	126	126	0
38	43	20	3	4	INSTALL POWER CONDUIT P-W	126	126	146	146	0
43	49	15	3	4	INSTALL BRANCH CONDUIT P-W	146	146	161	161	0
49	50	15	3	4	PULL WIRE P-W	161	161	176	176	0
50	54	5	3	4	INSTALL PANEL INTERNALS P-W	176	176	181	181	0
54	55	10	3	4	TERMINATE WIRES P-W	181	181	191	191	0
55	56	10	3	4	RINGOUT P-W	191	191	201	201	0
56	58	1	3	4	ENERGIZE POWER	201	201	202	202	0
58	59	5	4	6	ERECT PRECAST STRUCT. OFFICE	202	202	207	207	0
59	60	5	4	6	ERECT PRECAST ROOF OFFICE	207	207	212	212	0
60	61	10	4	7	EXTERIOR MASONRY OFFICE	212	212	222	222	0
61	64	10	4	5	INSTALL PIPING OFFICE	222	222	232	232	0
61	65	4	4	4	INSTALL ELEC BACKING BOXES	222	222	226	226	0
64	67	4	4	5	TEST PIPING OFFICE	232	232	236	236	0
65	66	10	4	4	INSTALL CONDUIT OFFICE	226	226	236	236	0
66	67	0			RESTRAINT	236	236	236	236	0
67	68	5	4	7	LATH PARTITIONS OFFICE	236	236	241	241	0
68	69	5	4	7	PLASTER SCRATCH AND BROWN	241	241	246	246	0
69	70	10	4	7	PLASTER WHITE COATS	246	246	256	256	0
70	71	10	4	8	WOOD TRIM OFFICE	256	256	266	266	0

Figure 18.9.1 Partial sort by total float for the John Doe project.

I	J	DURATION			DESCRIPTION	START		FINISH		TOTAL FLOAT
						EAR	LAT	EAR	LAT	
71	72	10	4	7	PAINT INTERIOR OFFICE	266	266	276	276	0
72	80	10	4	7	FLOOR TILE OFFICE	276	276	286	286	0
72	78	0			RESTRAINT	276	276	276	276	0
78	80	10	4	7	ACOUSTIC TILE OFFICE	276	276	286	286	0
3	6	4	1	3	WATER TANK FOUNDATIONS	7	8	11	12	1
6	7	10	1	6	ERECT WATER TOWER	11	12	21	22	1
7	8	10	1	5	TANK PIPING AND VALVES	21	22	31	32	1
31	33	3	3	6	ERECT MONORAIL TRACK P-W	103	105	106	108	2
3	9	10	1	1	EXCAVATE FOR SEWER	7	11	17	21	4
9	11	5	1	5	INSTALL SEWER AND BACKFILL	17	21	22	26	4
11	12	3	1	4	ELECTRICAL DUCT BANK	22	26	25	29	4
12	13	5	1	4	PULL IN POWER FEEDER	25	29	30	34	4
35	37	5	3	7	BUILT UP ROOFING P-W	114	119	119	124	5
72	73	0			RESTRAINT	276	281	276	281	5
73	80	5	4	5	TOILET FIXTURES OFFICE	276	281	281	286	5
18	21	5	2	3	FORM + POUR RR LOAD DOCK P-W	65	73	70	78	8
18	22	5	2	3	FORM + POUR TK LOAD DOCK P-W	65	73	70	78	8
21	22	0			RESTRAINT	70	78	70	78	8
37	43	10	3	4	POWER PANEL BACKFILL BOXES P-	124	136	134	146	12
3	10	1	1	1	EXCAVATE ELECTRICAL MANHOLES	7	20	8	21	13
10	11	5	1	4	INSTALL ELECTRICAL MANHOLES	8	21	13	26	13
37	39	10	3	7	MASONRY PARTITIONS P-W	124	137	134	147	13
39	42	5	3	8	FRAME CEILINGS P-W	134	147	139	152	13
42	44	10	3	8	DRYWALL PARTITIONS P-W	139	152	149	162	13
44	46	0			RESTRAINT	149	162	149	162	13
46	52	25	3	7	INSTALL DUCTWORK P-W	149	162	174	187	13
52	58	15	3	7	INSULATE H + V SYSTEM P-W	174	187	189	202	13
61	62	5	4	8	EXTERIOR DOORS OFFICE	222	236	227	241	14
61	63	5	4	7	BUILT UP ROOFING OFFICE	222	236	227	241	14
61	68	5	4	7	GLAZE OFFICE	222	236	227	241	14
62	63	0			RESTRAINT	227	241	227	241	14
63	68	0			RESTRAINT	227	241	227	241	14
70	77	0			RESTRAINT	256	271	256	271	15
71	80	5	4	8	HANG DOORS OFFICE	266	281	271	286	15
77	78	5	4	8	INSTALL CEILING GRID OFFICE	256	271	261	276	15
3	12	6	1	4	OVERHEAD POLE LINE	7	23	13	29	16
44	48	10	3	7	CERAMIC TILE	149	167	159	177	18

Figure 18.9.1 (Continued)

times and *i-j* numbers). Once the output was reduced to a plain list, the field people were willing to work with it.

There is often a psychological barrier to anything associated with a computer. In some cases, it is justified. Periodically, computer specialists come up with their own breakthroughs in network analysis.

I	J	DUR- ATION	CONTRAC- TOR	WORK CATEGORY	DESCRIPTION	START		FINISH		TOTAL FLOAT
						EAR	LAT	EAR	LAT	
0	1	3	1	1	CLEAR SITE			3	3	0
11	2	2	1	2	SURVEY AND LAYOUT	3	3	5	5	0
2	3	2	1	1	ROUGH GRADE	5	5	7	7	0
3	4	15	1	7	DRILL WELL	7	7	22	22	0
3	6	4	1	3	WATER TANK FOUNDATIONS	7	8	11	12	1
3	9	10	1	1	EXCAVATE FOR SEWER	7	11	17	21	4
3	10	1	1	1	EXCAVATE ELECTRICAL MANHOLES	7	20	8	21	13
3	12	6	1	4	OVERHEAD POLE LINE	7	23	13	29	16
10	11	5	1	4	INSTALL ELECTRICAL MANHOLES	8	21	13	26	13
6	7	10	1	6	ERECT WATER TOWER	11	12	21	22	1
9	11	5	1	5	INSTALL SEWER AND BACKFILL	17	21	22	26	4
7	8	10	1	5	TANK PIPING AND VALVES	21	22	31	32	1
4	5	2	1	5	INSTALL WELL PUMP	22	22	24	24	0
11	12	3	1	4	ELECTRICAL DUCT BANK	22	26	25	29	4
5	8	8	1	5	UNDERGROUND WATER PIPING	24	24	32	32	0
12	13	5	1	4	PULL IN POWER FEEDER	25	29	30	34	4
8	13	2	1	5	CONNECT WATER PIPING	32	32	34	34	0
13	14	1	2	2	BUILDING LAYOUT	34	34	35	35	0
14	15	10	2	7	DRIVE AND POUR PILES	35	35	45	45	0
14	23	3	2	1	EXCAVATE FOR OFFICE BUILDING	35	65	38	68	30
23	24	4	2	3	SPREAD FOOTINGS OFFICE	38	68	42	72	30
24	25	6	2	3	FORM + POUR GRADE BEAMS OFF	42	72	48	78	30
15	16	5	2	1	EXCAVATE FOR PLANT WAREHOUSE	45	45	50	50	0
25	26	1	2	1	BACKFILL + COMPACT OFFICE	48	78	49	79	30
26	27	3	2	5	UNDERSLAB PLUMBING OFFICE	49	79	52	82	30
16	17	5	2	3	POUR PILE CAPS PLANT-WAREHOUSE	50	50	55	55	0
27	28	3	2	4	UNDERSLAB CONDUIT OFFICE	52	82	55	85	30

Figure 18.9.2 Partial early start sort for the John Doe project.

For instance, at least three different computer-oriented groups have advocated methods of generating computer outputs similar to CPM without drawing a diagram. Such a computed result is naturally suspect. First, if people in the field have strong reservations about the computed results of an arrow diagram, how would they react to a computed schedule not based on a diagram or their tangible plan? Second, if the CPM computation must be carefully checked for errors, what can the diagram-less computer output be checked against?

It is possible to generate an output without a diagram to support it. As an expedient in high-rise work, we have prepared the basic CPM plan for one floor and then regenerated it to suit the total number of similar floors. The same method was effective in a dormitory renovation with eight similar wings and for the KKMC military complex in Saudi Arabia.

I	J	DURATION	CONTRACT	WORK CATEGORY	DESCRIPTION	START		FINISH		TOTAL FLOAT
						EAR	LAT	EAR	LAT	
13	14	1	2	2	BUILDING LAYOUT	34	34	35	35	0
3	6	4	1	3	WATER TANK FOUNDATIONS	7	8	11	12	1
16	17	5	2	3	POUR PILE CAPS PLANT-WAREHOUSE	50	50	55	55	0
17	18	10	2	3	FORM + POUR GRADE BEAMS P-W	55	55	65	65	0
18	21	5	2	3	FORM + POUR RR LOAD DOCK P-W	65	73	70	78	8
18	22	5	2	3	FORM + POUR TK LOAD DOCK P-W	65	73	70	78	8
22	29	10	2	3	FORM + POUR SLABS P-W	78	78	88	88	0
23	24	4	2	3	SPREAD FOOTINGS OFFICE	38	68	42	72	30
24	25	6	2	3	FORM + POUR GRADE BEAMS OFF	42	72	48	78	30
28	29	3	2	3	FORM + POUR OFFICE SLAB	55	85	58	88	30
3	12	6	1	4	OVERHEAD POLE LINE	7	23	13	29	16
10	11	5	1	4	INSTALL ELECTRICAL MANHOLES	8	21	13	26	13
11	12	3	1	4	ELECTRICAL DUCT BANK	22	26	25	29	4
12	13	5	1	4	PULL IN POWER FEEDER	25	29	30	34	4
20	22	5	2	4	UNDERSLAB CONDUIT P-W	73	73	78	78	0
27	28	3	2	4	UNDERSLAB CONDUIT OFFICE	52	82	55	85	30
37	38	2	3	4	SET ELECTRICAL LOAD CENTER PW	124	124	126	126	0
37	43	10	3	4	POWER PANEL BACKFILL BOXES P-	124	136	134	146	12
37	93	20	5	4	AREA LIGHTING	124	266	144	286	142
38	43	20	3	4	INSTALL POWER CONDUIT P-W	126	126	146	146	0
43	49	15	3	4	INSTALL BRANCH CONDUIT P-W	146	146	161	161	0
45	51	5	3	4	ROOM OUTLETS P-W	161	186	166	191	25
49	50	15	3	4	PULL WIRE P-W	161	161	176	176	0
50	54	5	3	4	INSTALL PANEL INTERNALS P-W	176	176	181	181	0
51	56	10	3	4	INSTALL ELECTRICAL FIXTURES	166	191	176	201	25
54	55	10	3	4	TERMINATE WIRES P-W	181	181	191	191	0
55	56	10	3	4	RINGOUT P-W	191	191	201	201	0

Figure 18.9.3 John Doe project output by work category (partial).

In both cases, however, we prepared a finished CPM diagram to support the computations.

Proponents of diagram-less schedules see the arrow diagram preparation as drudgery. Granted, it can be tedious, but the value of doing it more than justifies the effort because it offers a graphical representation of the planners' thoughts.

Proponents of computerized techniques believe the planner must visualize an arrow diagram without the aid of paper and pencil and without the benefits of the record furnished by the diagram. The planner is also likely to miss many of the subtle connections that the arrow diagram shows. Although efforts to do without diagrams are sincere and apparently offer useful results to those who advocate them, they would appear to have limited application.

I	J	DURATION	CONTRACT	WORK CATEGORY	DESCRIPTION	START		FINISH		TOTAL FLOAT
						EAR	LAT	EAR	LAT	
57	58	10	3	24	INSTALL FURNISHING P-W	174	192	184	202	18
56	58	1	3	4	ENERGIZE POWER	201	201	202	202	0
58	59	5	4	7	ERECT PRECAST STRUCT, OFFICE	202	202	207	207	0
59	60	5	4	7	ERECT PRECAST ROOF, OFFICE	207	207	212	212	0
60	61	10	4	14	EXTERIOR MASONRY, OFFICE	212	212	222	222	0
60	76	5	4	8	INSTALL PACKAGE AIR CONDITIONER	212	272	217	277	60
61	62	5	4	21	EXTERIOR DOORS, OFFICE	222	236	227	241	14
61	63	5	4	17	BUILT-UP ROOFING, OFFICE	222	236	227	241	14
61	77	15	4	8	DUCTWORK, OFFICE	222	256	237	271	34
61	58	5	4	25	GLAZE, OFFICE	222	236	227	241	14
61	64	10	4	8	INSTALL PIPING, OFFICE	222	222	232	232	0
61	65	4	4	4	INSTALL ELEC. BACKING BOXES	222	222	226	226	0
65	66	10	4	4	INSTALL CONDUIT, OFFICE	226	226	236	236	0
63	80	5	4	22	PAINT OFFICE EXTERIOR	227	281	232	286	54
64	67	4	4	3	TEST PIPING, OFFICE	232	232	236	236	0
66	74	10	4	4	PULL WIRE, OFFICE	236	236	246	266	20
67	68	5	4	19	START PARTITIONS, OFFICE	236	236	241	241	0
68	69	5	4	19	DRYWALL, OFFICE	241	241	246	246	0
69	70	10	4	19	DRYWALL, OFFICE	246	246	256	256	0
69	73	10	4	20	CERAMIC TILE, OFFICE	246	271	256	281	25
76	79	4	4	4	AIR CONDITIONING ELEC. CONNECT	246	277	250	281	31
70	71	10	4	26	WOOD TRIM, OFFICE	256	256	266	266	0
77	78	5	4	18	CEILING GRID, OFFICE	256	271	261	276	15
71	72	10	4	22	PAINT INTERIOR, OFFICE	266	266	276	276	0
71	90	5	4	21	HANG DOORS, OFFICE	266	281	271	286	15
72	80	10	4	20	FLOOR TILE, OFFICE	276	276	286	286	0
78	80	10	4	18	ACCUSTIC TILE, OFFICE	276	276	286	286	0

Figure 18.9.4 John Doe project output by contract.

An extension of the diagram-less computer output is the generation of a diagram by a computer based on the CPM output, which is discussed in a later chapter.

Figure 18.9.4 is the John Doe project output by contract.

### 18.10. Calendar Dates

So far, the lists given in this chapter have been in terms of project days. Is a project calendar necessary to use outputs? No. The computer, in a relatively easy step, can calendar-date the output. Figure 18.10.1 is the



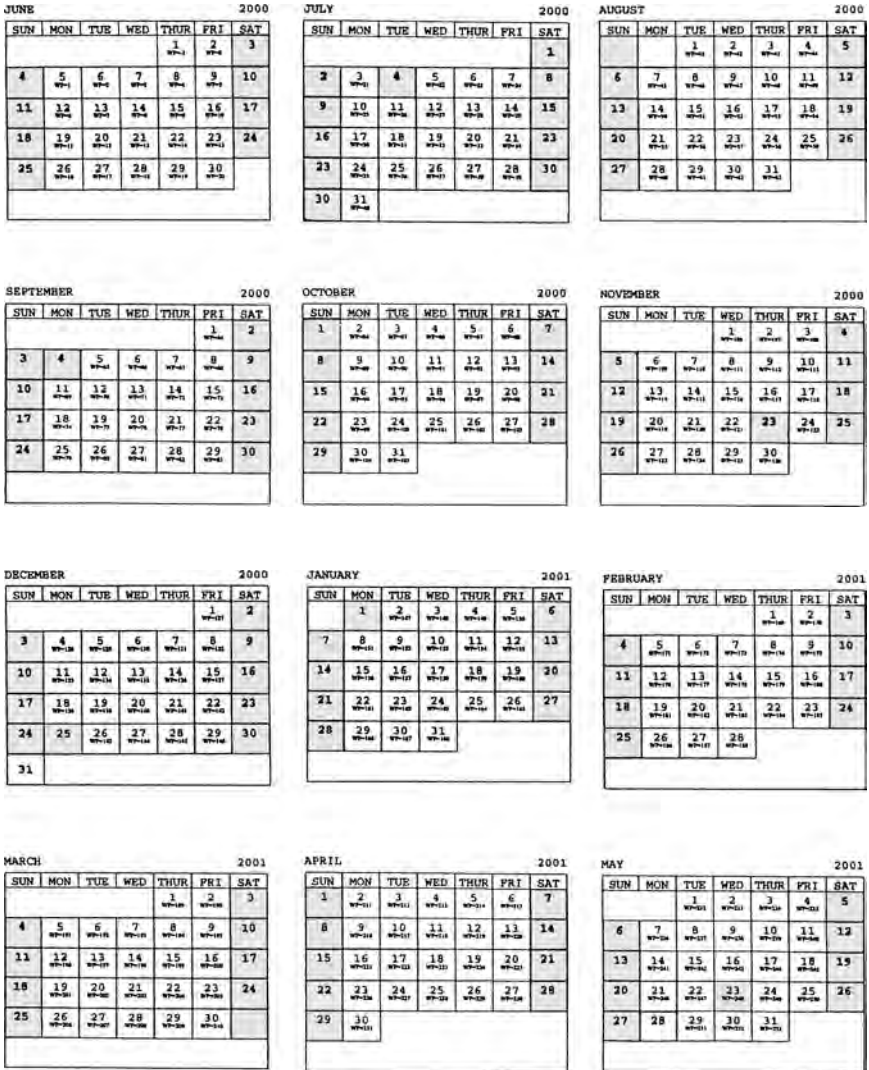

Figure 18.10.1 John Doe project calendar.

project calendar for the John Doe project. It assumes a June 1 start date and skips weekends and holidays. For activity 4–5, install well pump, the ES is 22 and the LF is 24. From the project calendar, the ES is July 5 and the LF is July 7, 2000. The activity times list is equivalent to the list of calendar times shown in Table 18.10.1.

Although the calendar-oriented information is more useful, the addition of as many as eight more digits per line does make it more difficult

TABLE 18.10.1 Calendar Dates Replace Project Days

Activity	Duration (days)	Description	ES*	EF*	LS*	LF*	Float (days)
0-1	3	Clear site	7-1	7-3	7-1	7-3	0
1-2	2	Survey	7-3	7-8	7-3	7-8	0
2-3	2	Rough grade	7-8	7-10	7-8	7-10	0
3-4	15	Drill well	7-10	7-31	7-10	7-31	0
3-6	4	Water tank foundations	7-10	7-16	7-13	7-17	1
3-9	10	Excavate sewer	7-10	7-24	7-16	7-30	4
3-10	1	Excavate electrical manholes	7-10	7-13	7-29	7-30	13
3-12	6	Pole line	7-10	7-20	8-3	8-11	16
4-5	2	Well pump	7-31	8-4	7-31	8-4	0

\*Numbers in column refer to calendar dates; e.g., 7-1 means July 1."

to read the activity list. Since early start and late finish are the two dates usually referred to, the *EF* and *LS* columns are often omitted in the calendar-dated summary of activity times. The float column is the fastest way to pick out the critical path.

If a project starts on July 29 instead of July 1, will you need to construct a new calendar? The difference in project days between July 1 and 29 is  $20 - 1$ , or 19. Look up the date for project day 10 under  $19 + 10$ , or 29, and the date is August 11. Therefore, one project calendar can be used for a number of projects.

To use the calendar to determine project days between two dates, enter the table at each date and subtract the reference numbers to get net project days. Conversely, the table can be entered at any date and calendar days can be added (or subtracted) to identify a date separated from another date by a set number of days.

The project calendar can also be generated day for day (i.e., 365 days per year or 366 in a leap year). The result will schedule work on holidays and weekends. Although seemingly illogical, this calendar is useful for contracts in which schedules (and extensions) are expressed in calendar days.

## 18.11. Summary

In this chapter, a sample light industrial project was planned with CPM. The activities involved in each section of the project were defined and the CPM network for each section was drawn. In describing the network construction, an index or dictionary approach was used. This can be very useful in CPM, but it is not often employed because of the additional effort required.

---

Part

# 4

## The Practice of CPM Planning

*This page intentionally left blank*

## Equipment and Workforce Planning

Time and cost dimensions have been discussed in connection with planning and scheduling projects. Workforce and equipment have been assumed to be available as needed. This, of course, is not usual. Planners, superintendents, and/or engineers responsible for projects keep their forces level by juggling float activities. In doing so, they must work critical and low-float activities first; the activities with more float are worked as fill-in jobs. As the project progresses, the float values change, which makes regular updating important in scheduling activities.

### 19.1. Workforce Leveling

Assume that phase 1 of the John Doe project is to be done overseas by Seabees; one category (e.g., jack-of-all-trades) of workforce is then assigned to each activity. Assume also that equipment is available as needed. See Table 19.1.1.

To determine the workforce requirements for the project, draw the arrow diagram to scale and plot the workforce against time. The first step is to draw the critical path, 0–1–2–3–4–5–8–13, and plot the critical workforce. This must be the initial step, because this portion of the workforce requirements are fixed. Figure 19.1.1 shows the plot of critical path and associated workforce.

In the float paths, there is flexibility in plotting the workforce. To get a planning datum of maximum needs, first plot all of the float paths, starting at the early start times. The first path plotted is the low-float path, 3–6–7–8. Since workforce is plotted on early start, the result is an early peak of workforce requirements. The peak requirement is 31 workers if all activities start early, and it occurs on day 11.

TABLE 19.1.1 Resources Required for John Doe Project

<i>i-j</i>	Activity	Workers
0-1	Clear	4
1-2	Survey	5
2-3	Grade	4
3-4	Well	3
3-6	Tank foundations	4
3-9	Excavate sewer	6
3-10	Excavate manhole	2
3-12	Pole line installation	6
4-5	Pump	2
5-8	Underground pipe	8
6-7	Tank	10
7-8	Tank pipe	6
8-13	Connect	4
9-11	Install sewer	8
10-11	Electrical manhole	6
11-12	Duct bank	10
12-13	Feeder	5

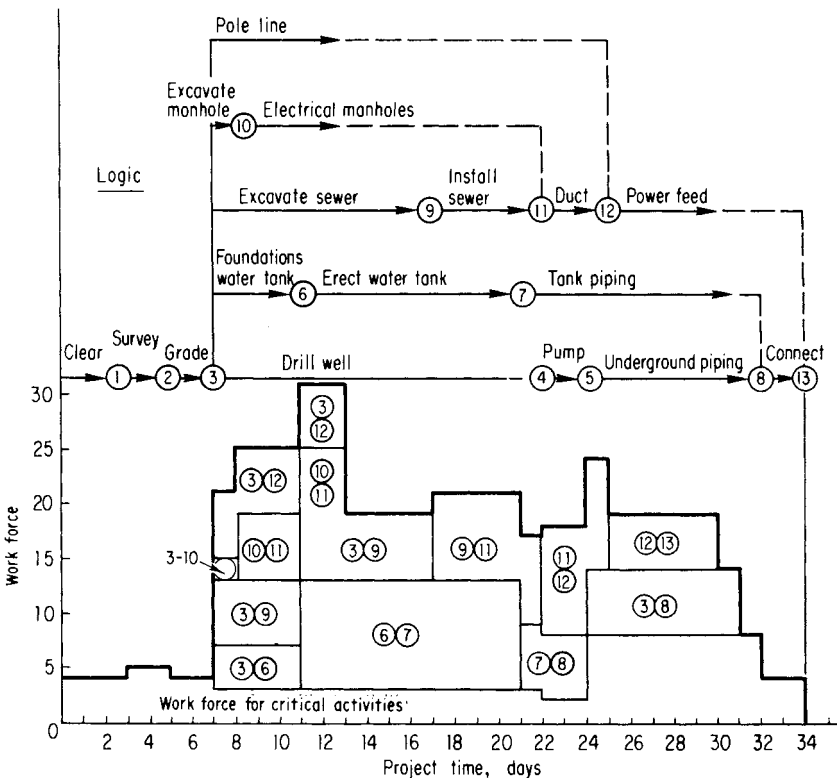

Figure 19.1.1 Peak workforce requirements based upon early start.

Figure 19.1.2 shows a similar workforce plot based on the starting float activities and their late start dates. The peak workforce requirement in this case is 34 workers, and it does not occur until day 24. Figure 19.1.3 shows both the early start (light line) and the late start (heavy line) workforce curves. Area A is common to both curves. Areas B and C are under the early start curve only. Areas D and E are under the late start curve only. The areas under the curves represent workforce (workers × project time). Since the workforces under the curves must be equal, the differences between the late start and early start curves must be equal. That is:

Since

$$A + B + C = A + D + E$$

then

$$B + C = D + E$$

In this case,  $B + C = 108$  worker-days =  $D + E$ .

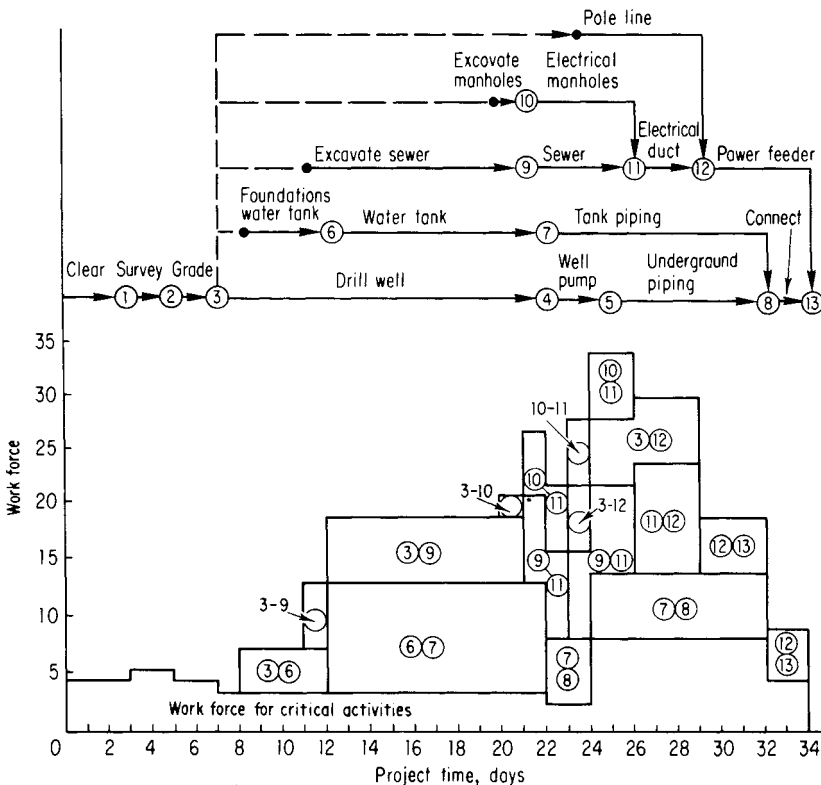

Figure 19.1.2 Peak workforce requirements based upon late start.

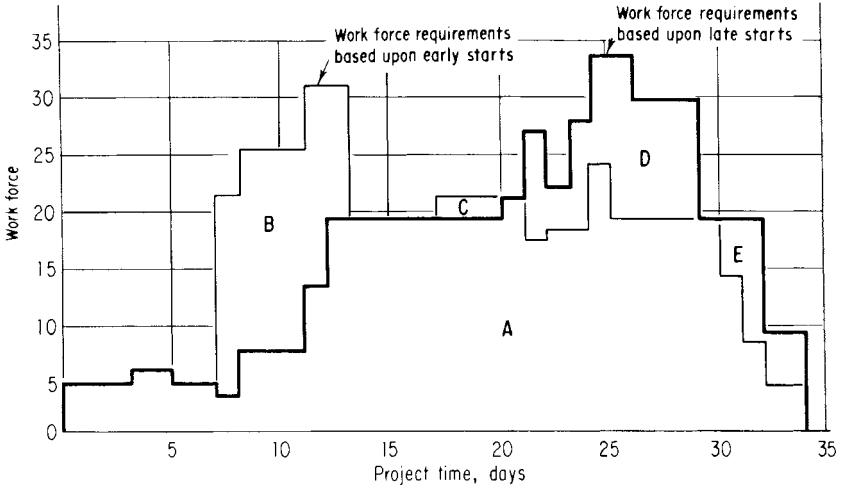

Figure 19.1.3 Combined peak workforce requirements for both early and late start dates.

Having estimated the peak, or worst cases, how can you level the workforce requirements? In this simplified example, it is relatively easy. Looking at Figure 19.1.3, the minimum level must be in excess of 20 workers. Since the early start curve is the more level of the two, work from it. By shifting the 3–12 activity to start on day 13 instead of day 7, the workforce can be built up slower and held to under 25 workers. See Figure 19.1.4. Because the estimated crew size is fixed, the job superintendent can level beyond the graph of Figure 19.1.4 only by further shifting the crew sizes. When shifting activities to the workforce, keep in mind that the logical sequence must not be violated. (Note this leveling routine assumes activities may be interrupted and later resumed without additional time and cost for remobilization.)

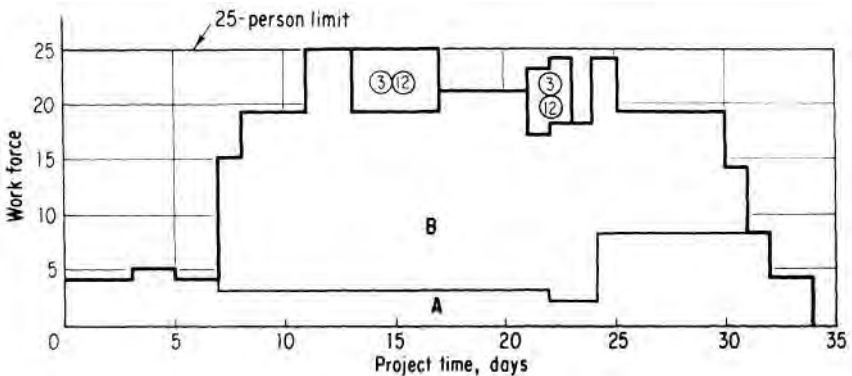

Figure 19.1.4 Leveled workforce.



Having worked out a level workforce plan for the Seabees, assume that only 20 workers will be assigned to the project. Figure 19.1.5 plots one solution to this problem (there is no single correct solution). The particular solution of 40 days is the minimum time in which this project can be completed with only 20 workers.

In arriving at this solution, a number of factors should be noted. First, there is no longer a critical path. Every path through the network now has interruptions during in which the workforce is unavailable. Because there is no critical path, the critical activities do not have to be carried out in immediate succession. However, the critical path is a good starting point for scheduling activities because you cannot complete the project in less than 34 days. If you do follow the "old" critical path,

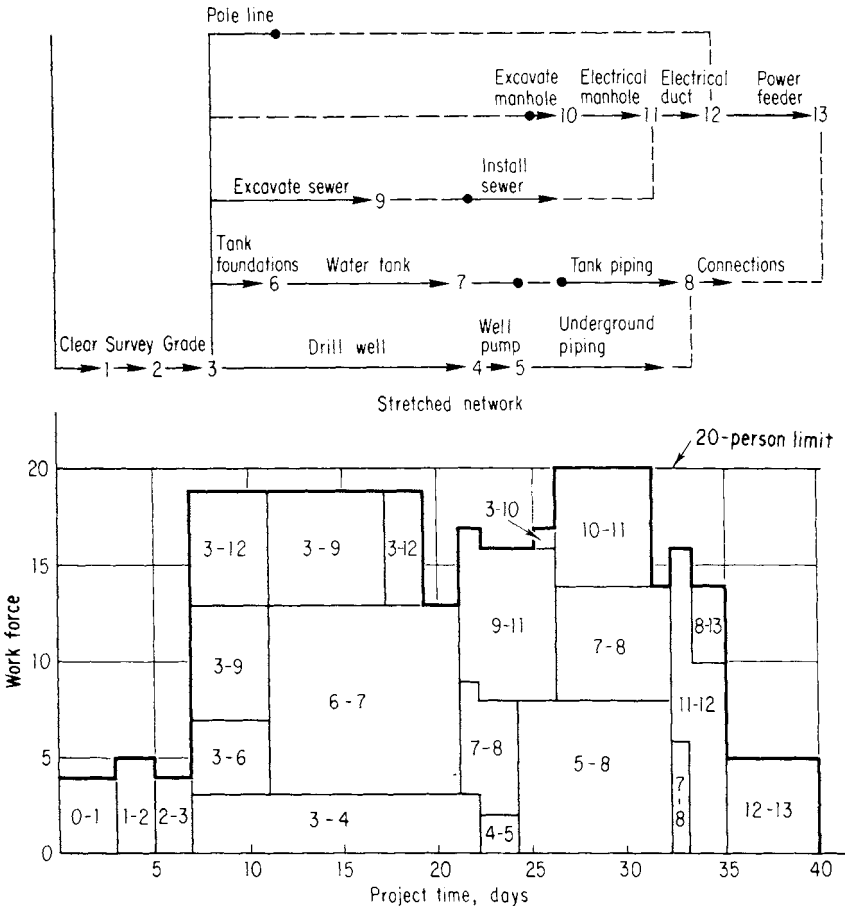

Figure 19.1.5 Limited workforce.

you cannot complete it in 34 days. Even though there is no critical path, no activity can be started before this early start because the work must still be accomplished in the same logical sequence.

In meeting the workforce restrictions, activity splitting is allowed. That is, you can start an activity, leave it, and come back to complete it. This occurred in activity 3–12, pole line installation. Note also that certain impractical scheduling tends to occur. For instance, activity 9–11, install sewer, follows 3–9, excavate sewer, by 2 days. Unless the climate is quite dry, the field superintendent will not likely hold fast to this schedule. The superintendent will start installing sewer on day 17 with the 7 workers available rather than the 8-person crew specified. If this is done, activity 3–12, pole line installation, will probably be delayed until day 27, which will still allow completion by day 40 with a slower build-up to the full crew.

Although there is an advantage to having Seabee jack-of-all-trades as workers, there is one slight complication. Keeping the same total work crews, you must specify the number of petty officers and construction men for each activity. See Table 19.1.2.

Figure 19.1.6 is similar to Figure 19.1.1 except that the workforce is broken into the two categories of petty officers and construction workers. Adding the two curves together results in the same total use requirements as Figure 19.1.1 (10 petty officers plus 21 construction workers on day 11 equals 31, etc.).

**TABLE 19.1.2 Multiple Resources Required for John Doe Project**

<i>i-j</i>	Activity	Number of petty officers	Number of construction workers
0-1	Clear site	4	0
1-2	Survey and layout	2	3
2-3	Grade	4	0
3-4	Drill well	1	2
3-6	Water tank foundations	1	3
3-9	Excavate sewer	2	4
3-10	Excavate manhole	1	1
3-12	Pole line installation	2	4
4-5	Well pump	1	1
5-8	Underground piping	1	7
6-7	Erect water tank	3	7
7-8	Tank piping	2	4
8-13	Connect piping	2	2
9-11	Install sewer	1	7
10-11	Electrical manhole	2	4
11-12	Duct bank	2	8
12-13	Power feeder	1	4

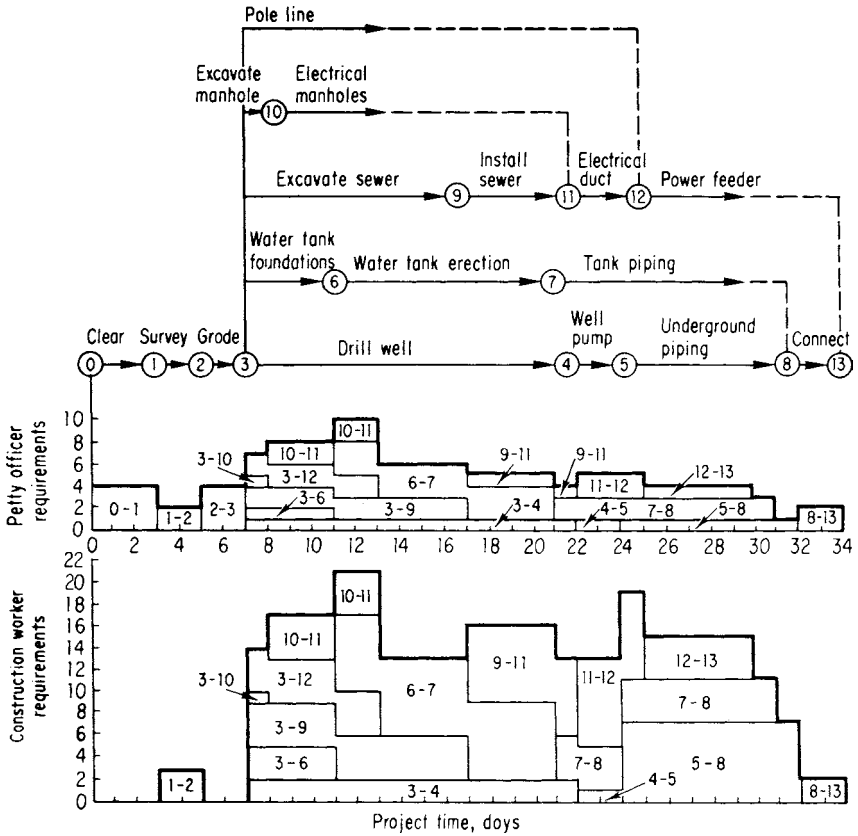

Figure 19.16 Peak workforce requirements (two categories).

If the 20 Seabees are made up of 5 petty officers and 15 construction workers, what is the effect on the schedule? When handling more than one type of workforce, the graphical plot becomes too unwieldy; another graphical approach is used to level the resources.

The first step in this method is to list all of the activities in ascending order of their end event  $j$ . The list is shown in the first column of Figure 19.1.7 (the event numbers must be assigned in the classical order  $j > i$ ). First on the list is the first activity 0-1, and last on the list are the two terminal activities, 8-13 and 12-13. The others, being in order of end events, are arranged in proper logical order.

If the workforce is scheduled in this order, you will be observing the network logical order. The second column has the activity durations. The third and fourth columns list the workforce requirements. With this information, you can schedule the project without further recourse to the network.

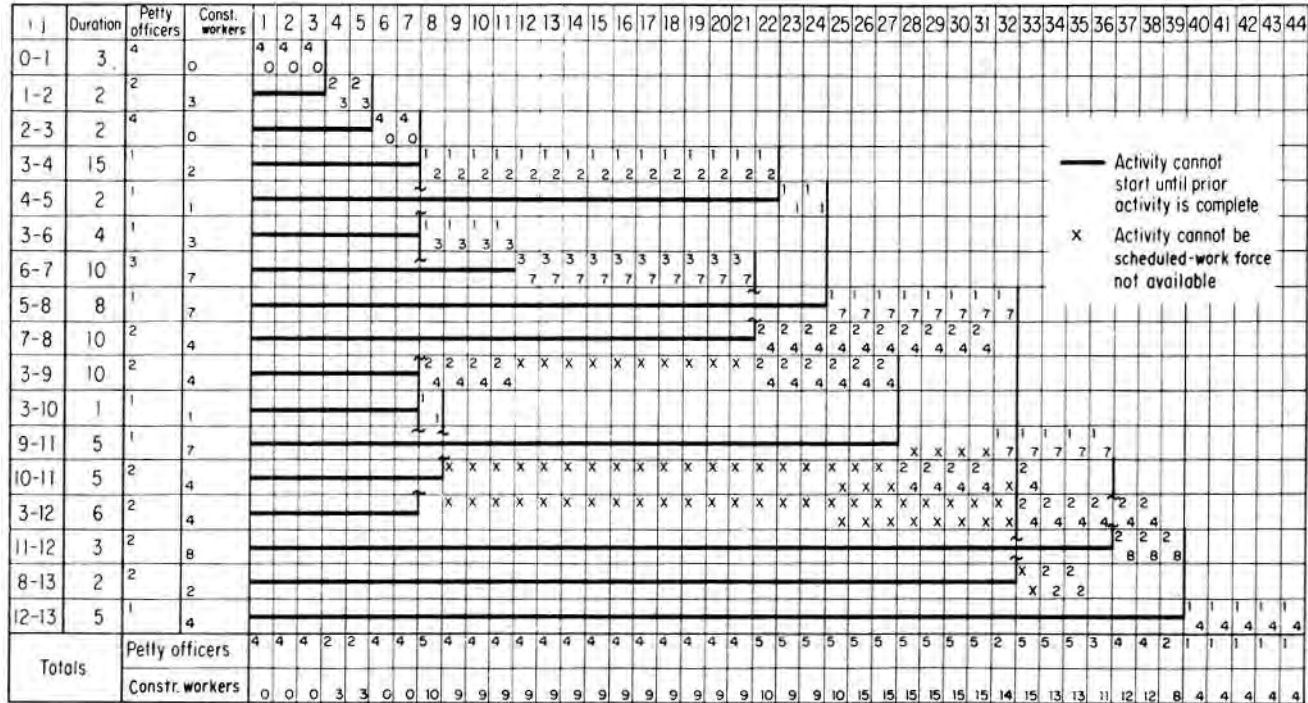

Figure 19.1.7 Workforce calculation: Limits 5 petty officers, 15 construction workers.

Starting at the top line in Figure 19.1.7, schedule four petty officers for the first three days for activity 0–1. The next activity, 1–2, cannot logically start until 0–1 is completed; the heavy line represents the logical restriction. Two petty officers and three construction workers are assigned to the activity. Proceed in this manner until activity 3–9; it logically could commence at day 8, and it does. On day 12, however, there are not enough petty officers, so the activity is interrupted until day 22. This interruption is represented with an X on the days that a workforce is not available.

The procedure, then, is simple: Consider each activity in order; determine the logical point at which it could start; and then schedule the activity as soon as the workforce is available. In this example, dividing the workforce into two categories lengthened the project from 40 to 44 days. Although basic CPM networks of several hundred activities can easily be manually computed, manual techniques are slow and complicated. A network of perhaps 50 activities is the practical limit for manually calculating workforce requirements. It will also vary considerably with the complexity of the network and the number of different categories of skill and equipment to be scheduled.

## 19.2. Computerized Resources Planning

Computer analysis is much more economical of time and money than manual analysis for most workforce studies, and a number of programs have been developed for workforce leveling. Two of the earliest programs were resource and manpower scheduling (RAMPS) by CEIR and resource planning and scheduling method (RPSM) by Mauchly Associates. However, the two pioneer programs were designed for computer hardware that is now obsolete.

Other major systems developed to handle resources as well as basic schedules included PMS by IBM and integrated civil engineering systems (ICES) by MIT. McDonnell Automation (McAuto) was part of the original PMS team, which utilized that experience in its development of the McAuto Management Scheduling and Control System (MSCS) program, which handled all phases of resource planning and scheduling.

The PROJECT/2 system (Project Software & Development Inc.) developed by Robert Daniels of the original ICES group had comprehensive resource capabilities.

MSCS and PROJECT/2 provided the best resource capabilities during the 1970s. There were other systems, including resource planning and control (RPC) by the author and MDC Systems, in development and use since 1966. RPC gave results similar to those of MSCS and PROJECT/2,

but it used resource parameter variation rather than automatic leveling. This optimized human direction, using the computer to test results.

The systems typically have three phases: The first is a CPM nominal time run; the second is a resource compilation called unlimited run; and in the third, the resources available are limited and two outputs are generated. One of which is a table of resources vs. time. The second is the schedule needed to achieve that use; it employs the logical sequence of the network but is no longer time-limited. The resource-limited project duration will be greater than (or possibly equal to) the normal time duration.

A computer program's unlimited phase would generate the usage shown in Table 19.2.1 for the two categories of peak requirements given in Figure 19.1.6.

A typical program can generate a schedule for the unlimited resources phase, but it would contain the same information as the CPM output. Accordingly, the schedule is not usually printed out for this step.

In the next step, with the petty officer supply limited to 5 and the construction workers to 15, the use calculated in Figure 19.1.7 is as shown in Table 19.2.2. The schedule of this manpower is as shown in Table 19.2.3.

This output is kept on disk so that any desired sort or listing can be furnished. The usual ones are *i-j*, start-end. In this case, the sort is *j-i*, which is unusual, but it matches the order of activities given in

**TABLE 19.2.1 Resource Usage Table**

Time	P*	C*	Time	P*	C*
1	4	0	18	5	16
2	4	0	19	5	16
3	4	0	20	5	16
4	2	3	21	5	16
5	2	3	22	4	13
6	4	0	23	5	13
7	4	0	24	5	13
8	7	14	25	5	19
9	8	17	26	4	15
10	8	17	27	4	15
11	8	17	28	4	15
12	10	21	29	4	15
13	10	21	30	4	15
14	6	13	31	3	11
15	6	13	32	1	7
16	6	13	33	2	2
17	6	13	34	2	2

\*P = petty officer; C = construction worker.

**TABLE 19.2.2 Resource Usage Table**

Time	P*	C*	Time	P*	C*
1	4	0	23	5	9
2	4	0	24	5	9
3	4	0	25	5	15
4	2	3	26	5	15
5	2	3	27	5	15
6	4	0	28	5	15
7	4	0	29	5	15
8	5	10	30	5	15
9	4	9	31	5	15
10	4	9	32	2	14
11	4	9	33	5	15
12	4	9	34	5	13
13	4	9	35	5	13
14	4	9	36	3	11
15	4	9	37	4	12
16	4	9	38	4	12
17	4	9	39	2	8
18	4	9	40	1	4
19	4	9	41	1	4
20	4	9	42	1	4
21	4	9	43	1	4
22	5	10	44	1	4

\*P = petty officer; C = construction worker.

**TABLE 19.2.3 Resource-Limited Schedule (Based on Five Petty Officers, Fifteen Construction Workers)**

<i>i-j</i>	Duration, days	Description	Workforce*		Start	End
			P	C		
0-1	3	Clear site	4		0	3
1-2	2	Survey and layout	2	3	4	6
2-3	2	Grade	4		6	7
3-4	15	Drill well	1	2	8	22
4-5	2	Well pump	1	1	23	24
3-6	4	Water tank foundation	1	3	8	11
6-7	10	Erect water tank	3	7	12	21
5-8	8	Underground piping	1	7	25	32
7-8	10	Tank piping	2	4	22	31
3-9	10	Excavate sewer	2	4	8	11&
3-9	10	Excavate sewer	2	4	22	27&
3-10	1	Excavate manhole	1	1	8	8
9-11	5	Install sewer	1	7	32	36
10-11	5	Electrical manhole	2	4	28	31&
10-11	5	Electrical manhole	2	4	33	33&
3-12	6	Pole line installation	2	4	33	38
11-12	3	Duct bank	2	8	37	39
8-13	2	Connect piping	2	2	34	35
12-13	5	Power feeder	1	4	40	44

\*P = petty officers; C = construction workers; & = split activity.

Table 19.2.2. Note that there is no critical path or float. This is the schedule that must be followed to achieve the level usage. Look at activities 3–9 and 10–11. The activities are split, scheduled at two separate times. This is indicated by the ampersand.

### **Resource applications**

Analyzing and planning workforce and equipment by a network should be preceded with using the basic CPM technique. Often, basic CPM techniques are sufficient to meet all planning and scheduling needs of a project. On the other hand, there are some applications in which CPM alone is inadequate and resources must be analyzed, such as jobs requiring heavy-equipment when constructing earth-fill dams and highways.

Careful scheduling of equipment across one or several projects has an immediate payoff. Contractors owning equipment are usually in a constant rental quandary. Should they rent out their idle equipment or will they have to rent extra equipment themselves in the near future? In heavy construction work, equipment (not time) is the limiting factor. In one highway project of 220 working days, the addition of 5 pieces of equipment shortened the project by 40 days. The time reduction of almost 20 percent was achieved by means of an equipment increase of less than 10 percent.

In a water treatment plant project, a series of resource vs. schedule runs were made to measure the minimum number of tradespeople required per contractor. In addition to the numbers of tradespeople needed, a second concern was crowding in work areas with a high density of piping, equipment, and controls. A maximum number of tradespeople per controlling area was posed as a limit. The runs identified at least two instances in which the minimum levels of tradespeople required by all the contractors together reached the cumulative population allowable for crowded areas.

On that same project, there was a concern that the electrical contractor was understaffed. Figure 19.2.1 is a histogram showing the projected electrical workforce based on early activity starts in the project's finishing stages. The plot demonstrates that a leveled force of about 25 electrical workers could readily complete the project on time. However, the late start histogram (Figure 19.2.2) shows that if the float is used up and the electrical work is not commenced until April (a 3-month slippage), a peak force of about 40 electricians will be required. By using the early start approach and a crew of 20 electricians, the schedule was leveled and the work was completed on time.

Most production processes that stay on-stream for long periods of time cannot be maintained during the production cycle. When the unit is shut down, either on schedule or because of a malfunction, the plant



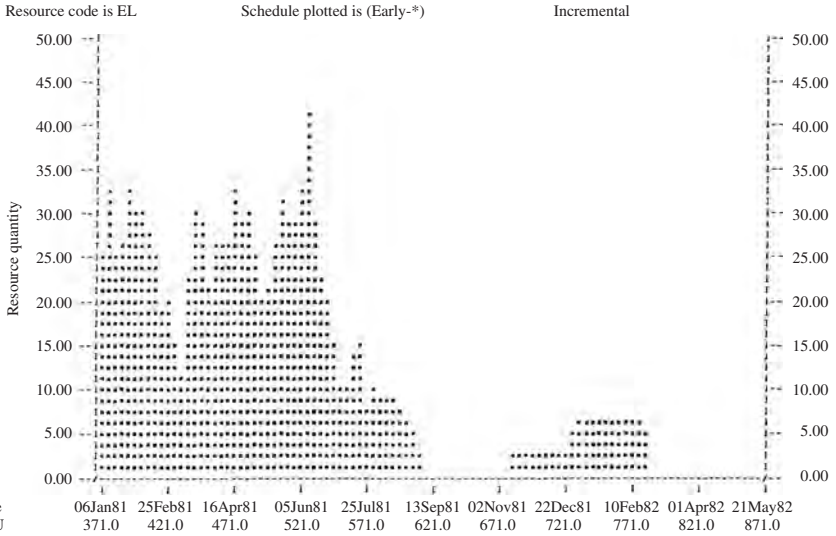

OKA PROJECTED ELECTRICAL MANPOWER HISTOGRAM - BASED ON ACTIVITY EARLY START DATES

**Figure 19.2.1** Projected electrical workforce histogram based upon early activity start dates.

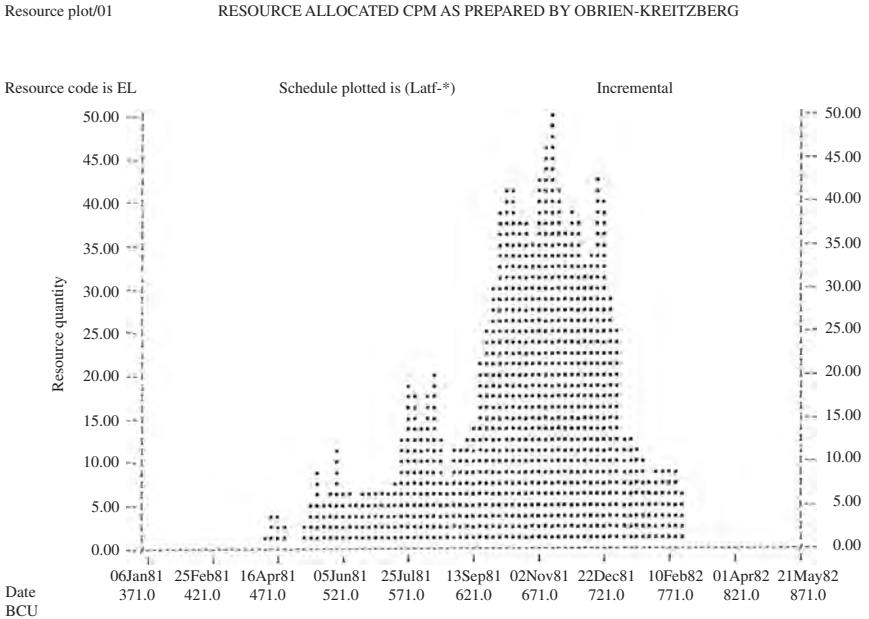

OKA PROJECTED ELECTRICAL MANPOWER HISTOGRAM-BASED ON ACTIVITY LATE START DATES

**Figure 19.2.2** Projected electrical workforce histogram based upon late activity start dates.

maintenance department performs maintenance work on the unit. The work is usually pushed around the clock because downtime is costly. The time from off-stream to on-stream is usually referred to as turnaround and is particularly applicable to chemical and refinery units. However, maintenance of large power generation stations, boilers, and similar plants or equipment also is in the turnaround category. Power or production plant outages are handled similarly. The payback for time savings can be tremendous. On one nuclear power plant outage, the cost/loss was \$800,000 per day.

A utility company used resource planning for the scheduled maintenance of a special super-pressure turbine. Studies were carried out 2 months prior to the scheduled shutdown. One month prior to that date, the machine developed bearing noises and had to be shut down early. The maintenance forces were committed to another turnaround already in progress and the workforce originally scheduled for the new turbine could not be assigned. While the unit was down, the company estimated an out-of-pocket cost of \$25,000 per day because of the lower efficiency of the standby units used to replace it.

While the unit was in its four-day cooldown, new computer analysis were made reflecting the reduced initial workforce levels. The schedule that was initially generated retained the original maintenance project length by shifting work that could wait to a later time in the project when a larger workforce would be available. The project schedule was updated regularly.

In the second week, subcontracted work was identified as the critical path. A workforce analysis indicated that there was no need for the maintenance force to work on Easter weekend, which resulted in considerable money savings in addition to an earlier online time for the unit.

Refineries also have the problem of fixed workforce and limited time to accomplish substantial turnaround assignments. Resource planning has been used to reduce downtime, but even the best schedule can achieve only a limited time reduction.

### **19.3. Multiproject Scheduling**

Figure 19.3.1 shows five concurrent subordinate networks interconnected to produce one major NASA project network. In this case, each subordinate network is termed a fragnet (fragmentary network). To compute the major network, it would be necessary only to interconnect the nine unconnected initial networks by using nine logical restraints tied back to a starting event of node. Similarly, each of the concluding, or terminating, events would have to be interconnected to provide a continuous network from start to finish. Calculation could then be by basic CPM program.

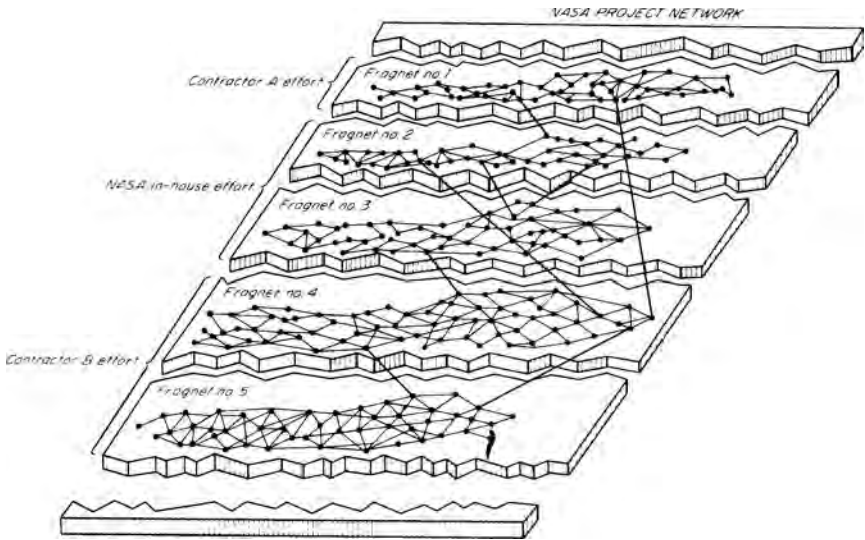

**Figure 19.3.1** Multiproject networks.

If the calculation is performed on this basis, there will be one critical path through the longest project, with each of the others showing float. Also, the calculation on this basis will show equivalent calendar starting dates for all projects.

In order to bring the projects into line with reality, the starting restraints are assigned times to reflect the staggering of the actual project parts, or fragnets. Similarly, lag, or concluding time, durations can be assigned so that the phasing will apply to the completion event.

To assist in establishing time values for lead and lag arrows (activities with no work activity by time duration at the start of a project are termed lead; those at the conclusion are used to establish phasing or lag), the fragnets can be calculated before they are interconnected. Often, the interconnection points are dictated to some degree by the time values. That is, when there is the possibility of a choice, as in preferential logic, the interface between two areas—particularly functional areas—is established by completion time. Figure 19.3.2 shows more summary fragnets and more complex interconnections.

Fragnets, or individual networks, do not have to be physically connected in order to be computed on a common basis. The connections can be made by merging nodes or adding logical restraints to the input. To interpret results, however, it is advisable to note them, at least on the summary network.

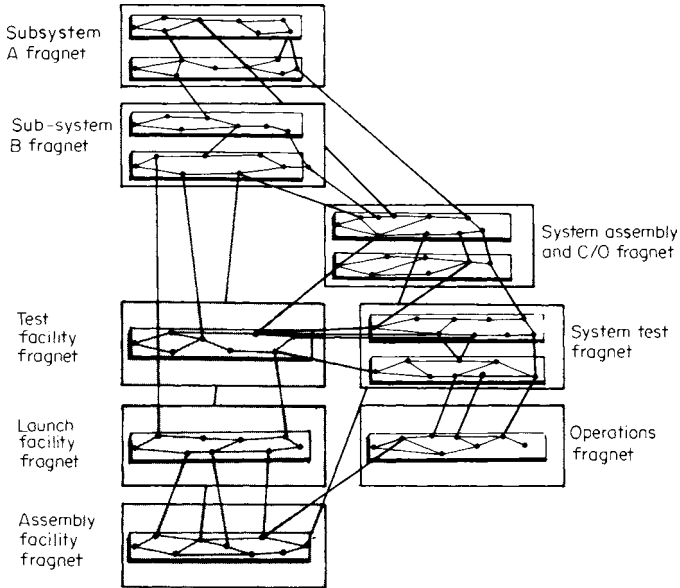

**Figure 19.3.2** Functional multiproject network.

Multiproject scheduling is one of the best bases for project resource planning and scheduling, because a special skill or resource must often be mobilized and utilized across many networks simultaneously. Also, in multiproject network scheduling, there is often substantial concurrency of activities and flexibility in completing the schedules of some subprojects. This can provide greater float opportunities and reduce peak resource projections.

Perini Construction, in an early CPM application, used multiproject resource planning to schedule special equipment for installing piling for bridge piers, each of which required 100 piles. Overall project time available for piling was less than a year between spring flood seasons. A total of more than 700 pilings was needed, and each had to be drilled and placed to an average depth of more than 200 feet at an average drilling rate of 10 feet/h.

To accomplish this, 2 special drilling rigs were designed and manufactured in France at a cost of \$500,000. Each machine served several purposes: drilling holes, placing caissons, placing piles, and removing caissons after placing piles (extraction). CPM was used to evaluate, in great depth, the placing of a set of piles. Setup and moving times were included in the calculations, and an average cycle of 36 h was predicted and subsequently confirmed by field information.

At this rate, with an allowance for a seven-day week, the piling could not be completed prior to the flood season. The detailed analysis pointed out that, not only was additional equipment required, but that it could be a specialized caisson extractor rather than a full-fledged combination unit. The new extracting machine cost only 20 percent of the multipurpose machine and resulted in a reduction of more than 25% of the overall project duration.

Figure 19.3.3 shows three networks that make up a program for three design projects. Each has three types of design personnel: mechanical engineer *m*, a breadboard designer *b*, and an electronics technician *t*. The networks represent concurrent work on three different projects by one functional design area. Note that it is not physically required for these networks to be joined by arrows. In this case, the connection at the conclusion is by two or three lag arrows, and the common zero starting node establishes the initiation point. The calculation will determine the minimum reasonable time span for the three projects with the use of the design workforce available. Note that since these are sample networks, descriptions are not written on the activities as they normally would be.

The problem was solved with the RPSM calculation, and the results are shown in Table 19.3.1. The first stage of calculation indicated that

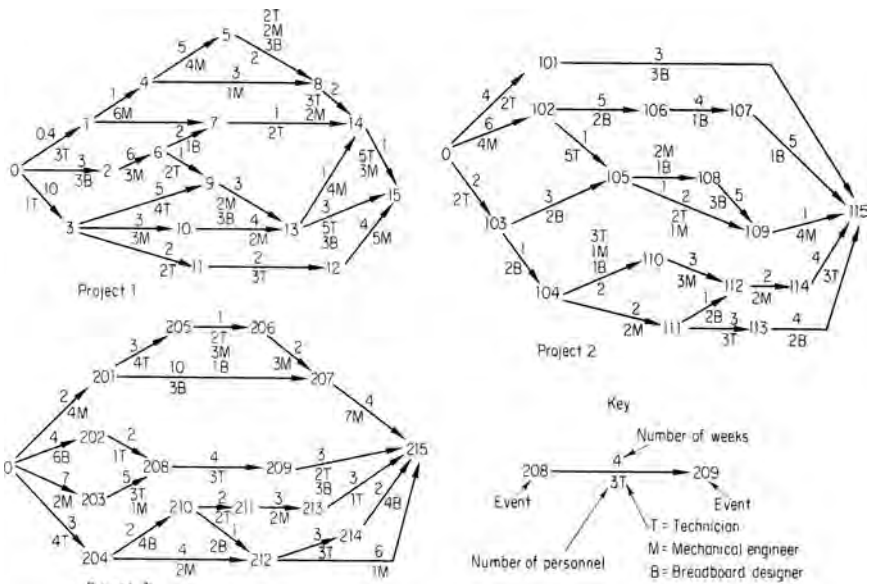

Figure 19.3.3 Design networks.

**TABLE 19.3.1 RPSM Usage for Unlimited and Limited Manpower**

(a) Unlimited Manpower				(b) 10 t; 10 m; 10 b				(c) 12 t; 12 m; 12 b			
Time	<i>b</i>	<i>m</i>	<i>t</i>	Time	<i>b</i>	<i>m</i>	<i>t</i>	Time	<i>b</i>	<i>m</i>	<i>t</i>
1	9	10	12	1	3	10	10	1	9	10	12
2	9	10	12	2	3	10	10	2	9	10	12
3	17	12	13	3	10	6	9	3	12	12	11
4	21	15	12	4	10	10	10	4	12	11	9
5	18	15	11	5	10	10	10	5	11	12	11
6	16	18	11	6	5	9	5	6	11	12	7
7	13	13	13	7	5	5	10	7	12	12	10
8	13	16	11	8	8	10	4	8	11	12	8
9	13	12	11	9	9	10	4	9	11	11	11
10	14	8	11	10	9	9	6	10	12	8	11
11	15	9	16	11	8	10	9	11	12	11	11
12	11	9	18	12	9	10	9	12	12	11	11
13	4	11	14	13	10	8	10	13	12	8	12
14	3	11	13	14	10	5	10	14	11	1	12
15	3	12	7	15	10	4	9	15	11	6	10
16	6	14	3	16	9	5	10	16	9	12	12
17	9	7	2	17	8	4	10	17	9	11	12
18	7	7	2	18	10	6	9	18	11	11	6
19	7	4	7	19	10	7	9	19	11	11	11
20	4	3	10	20	10	9	10	20	4	10	10
21	3		5	21	10	7	7	21	3	7	5
22	9	9	7	22		7					
23	9	7	7								
24	9	7	7								
25	8	7	2								
26	4	7									
27		8	3								
28		4	3								
29		3	5								

the projects could be completed in 21 weeks by using a maximum of 21 designers, 18 mechanical engineers, and 18 technicians. In the next step, the computer was instructed that the department had only 10 people available in each class, and it, therefore, noted a time extension from 21 to 29 weeks. At that point, a solution was attempted by determining an optimum resource use within the basic CPM time. Part *c* indicates that, with a 20 percent increase in workforce, a 33 percent time reduction could be achieved.

### 19.4. Turnaround Application

Maintenance operation in the petrochemical industry offers one of the most typical illustrations of multiproject operations. Many individual mini projects go on concurrently with one or more major projects. The

use of CPM has been well established in preplanning these highly coordinated operations.

One such turnaround was planned and implemented at a refinery in Puerto Rico. Key personnel had previously been exposed to CPM through courses, seminars, and literature. Management decided to use CPM to plan a major maintenance turnaround of the No. 2 crude distillation unit, including a catalytic cracker. Two months prior to the scheduled turnaround, the first CPM networks were prepared by the conference method. Key process, maintenance, contract, and engineering personnel for the turnaround met to discuss the work items to be included.

As the scope of each work item was discussed, a network defining the logical sequence of work was developed on a blackboard, and the information was subsequently transcribed to a reproducible drawing. Normal crew sizes were assumed, and time and workforce estimates were added to the networks to complete the arrow diagram. The individual subnetworks were linked together to form a multiproject plan.

Figure 19.4.1 shows a summary of CPM for the crude heater overhaul, which determined the longest major job in the turnaround. Figure 19.4.2 shows the typical overhaul plan for three similar units, and there were more than 40 such plans for different pieces of equipment.

In the planning, there were several major sequential operations, but the majority could occur concurrently. The establishment of a reasonable working schedule required either resource allocation or the introduction of preferential logic. In this case, computerized

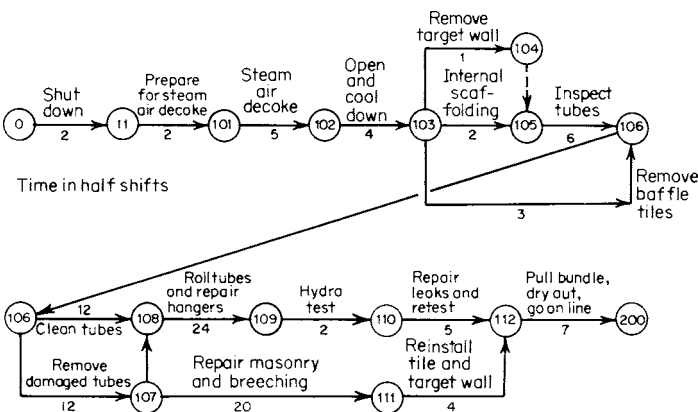

Figure 19.4.1 Summary plan for crude heater overhaul.

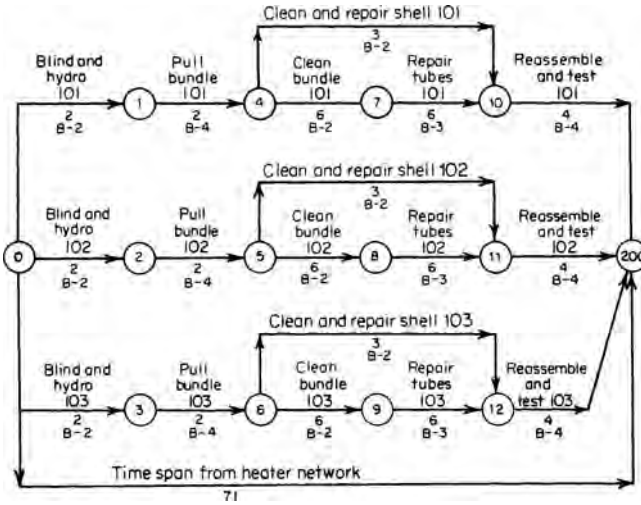

Figure 19.4.2 Summary plan for overhaul of three units similar to the plan illustrated in Figure 19.4.1.

resource planning was used to establish the role of more than 400 people assigned to the 3-week operation.

During the actual turnaround, the CPM group assigned a representative to each shift to work directly with the shift coordinator. The representatives' role was to assist the coordinators in using the CPM information and also to collect status information on completed work and work in progress. On a daily basis, the completed activities were noted in the project computer input and a new CPM and resource calculation was made. The resulting resource-usage tables forecasted workforce trends.

An interesting characteristic of the trend forecast is that, for it to be effective, the workforce estimating didn't have to be accurate, just consistent. Accordingly, if the resource computation called for 40 workers and 50 were assigned, it could be anticipated that the workforce requirements would show a downward trend as the 50 gain on the work time estimated for a 40-person crew. If this daily trend remained steady, it was inferred that the original workforce requirements were too low and a crew of 50 was the proper size. On the other hand, if the estimated crew was being used and the workforce requirements trended downward, it was assumed that the estimates were too conservative.

In the project, the first several daily reports confirmed the forecasted 18-day project duration. On the sixth daily report, it was reported that a noncritical area could be completed 2 days early, and



the 10th report confirmed all earlier trends, which were that all work would be completed 4 days early. On the 13th day, the unit was turned over to process and daily reports ceased.

Thus, the trend analysis method was effective. The first four reports indicated an adequate workforce, which was actually somewhat below the original projected requirement. On the fifth report, a downward trend was noticed. Further, it was noted that a shortage of cleaned bundles for exchangers was causing an excess of available boilermakers. And it was also evident that when bundles became available, the trend in the craft would reverse and so create a workforce shortage. The sixth report recommended that a workforce reduction could start. The next two reports noted that the shift of some of the workforce to another, unexpected, shutdown would not impede the progress of the job at hand. With further workforce analysis, it was determined that on the July 4th holiday, only critical jobs had to be worked, which saved substantial overtime. Figure 19.4.3 shows an actual report used in the turnaround.

**Status Report for No. 2 Crude and  
Vac Unit Turnaround**

As a start of time unit 15, 1st shift Thursday, June 27.

**Duration**

Completion by Saturday, July 13 (72 time units) is still feasible, but only if all tube repair and replacement in the vacuum-heater can be accomplished within the 18 shifts (32 units) originally allotted. A definitive reevaluation of the tube work has not been made as yet. All other work is on schedule.

**Manpower**

1. Manpower computation definitely indicates that present work force is adequate to maintain schedule.
2. Further, it is doubtful that additional manpower would expedite the critical vacuum heater repair as working room has become limiting factor.

**Critical Areas**

1. Vacuum heater—*most critical*
  2. Crude heater
  3. Insulation of tower and vessel skirts (sandblasting scheduled for Sunday)
  4. Crude tower work
- \*Need division to go ahead with seal welding over-rolled tubes in crude heater. Work could start NOW

**Time Losses**

1. Without acetylene and oxygen in the critical vacuum heater area for over 2 h today.
2. Chemical cleaning; not working second shift. Eight dirty bundles available.
3. Lack of heat exchanger slings limits high-pressure cleaning of heat exchangers to two a day instead of four.
4. No ice for water cans. Time lost by people walking to other areas for water.

Figure 19.4.3 Turnaround analytical report. (Courtesy: Hydrocarbon Processing and Petroleum Refiner.)

### 19.5. Examples of Resource Loading on John Doe Project

As another example, the John Doe project, after resource loading, would generate a graphical resource analysis as shown in Figure 19.5.1.

The number of craftspersons required per day is noted upon the left-hand scale and also above the bars representing weeks. The cumulative number of mandays required are noted upon the right-hand scale. What appears as obvious is that the spikes in late November and early December are unrealistic, both in terms of season and numbers of craftspersons. However, if the various crafts are broken down separately, as shown in Figure 19.5.2, then this initial conclusion is refuted. Although the total number of craftsmen approaches 80, the maximum for any one craft is 15.

On the other hand, what would you do if only 10 electricians could be provided to this site? Figure 19.5.3 shows the use of electricians using standard CPM scheduling calculations. Figure 19.5.4 shows the use of electricians if leveling software routines are used limiting the number to 10. Note that while the number of electricians has been reduced to the stipulated limit of 10, the project completion date has slipped from 20JUL01 to 03AUG01.

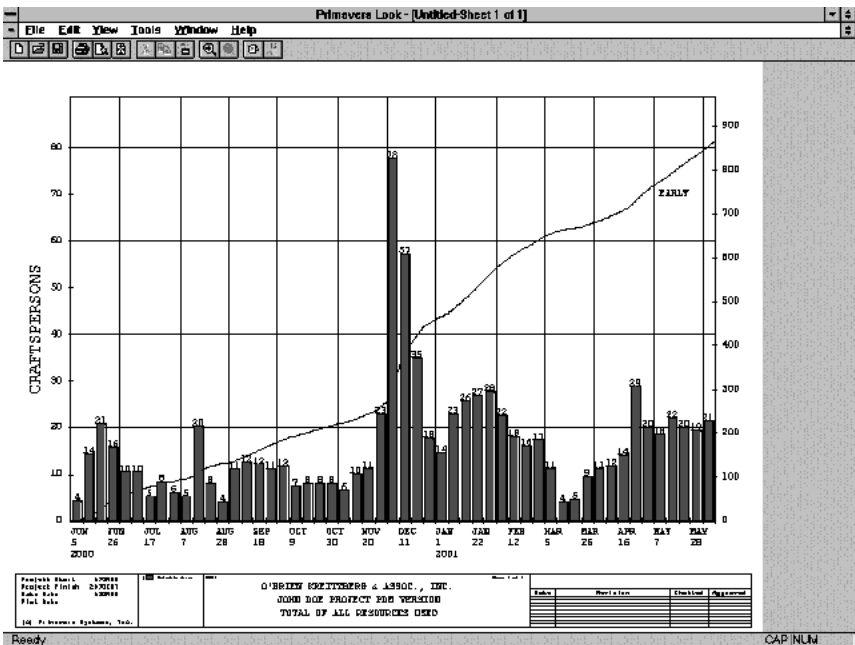

Figure 19.5.1 John Doe project resource histogram and cumulative curve for early dates.

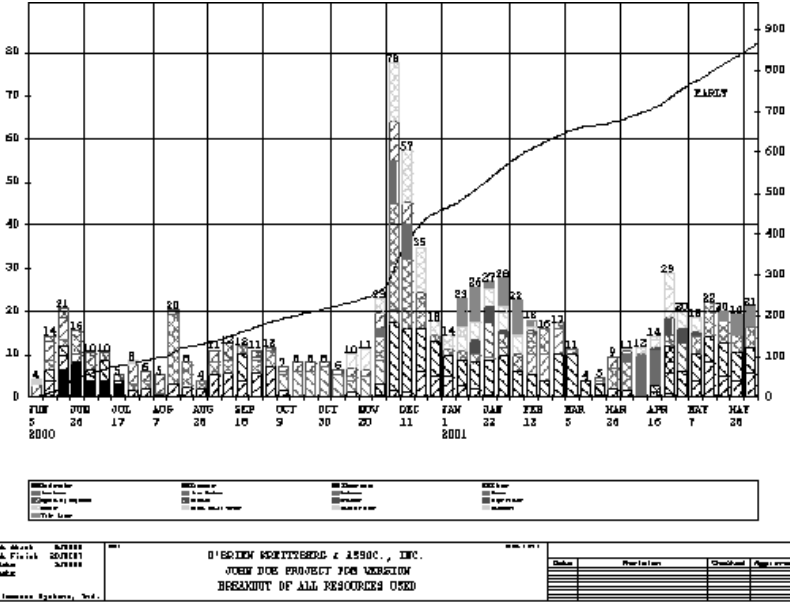

Figure 19.5.2 Resource histogram with stacked resources.

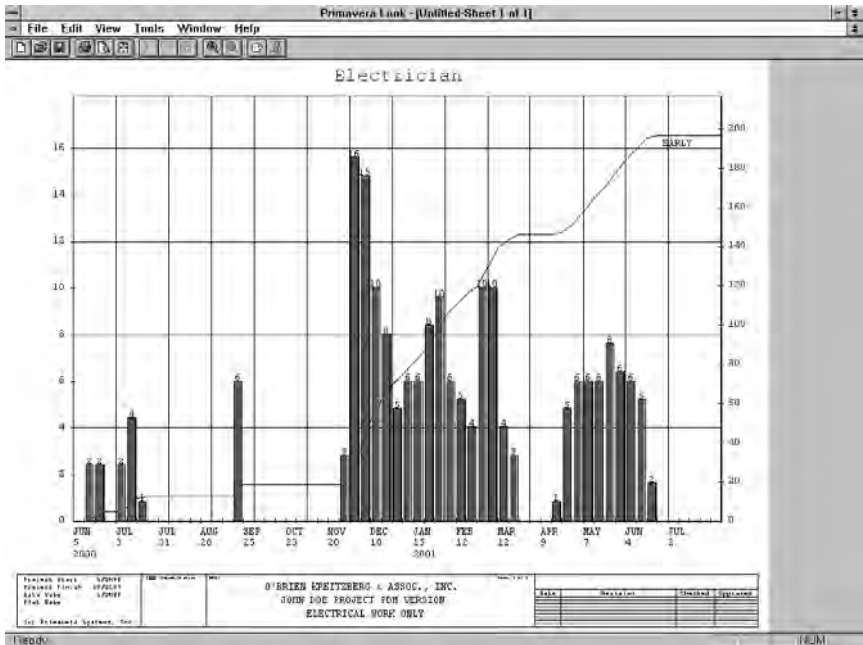

Figure 19.5.3 John Doe project—unleveled use of electricians.

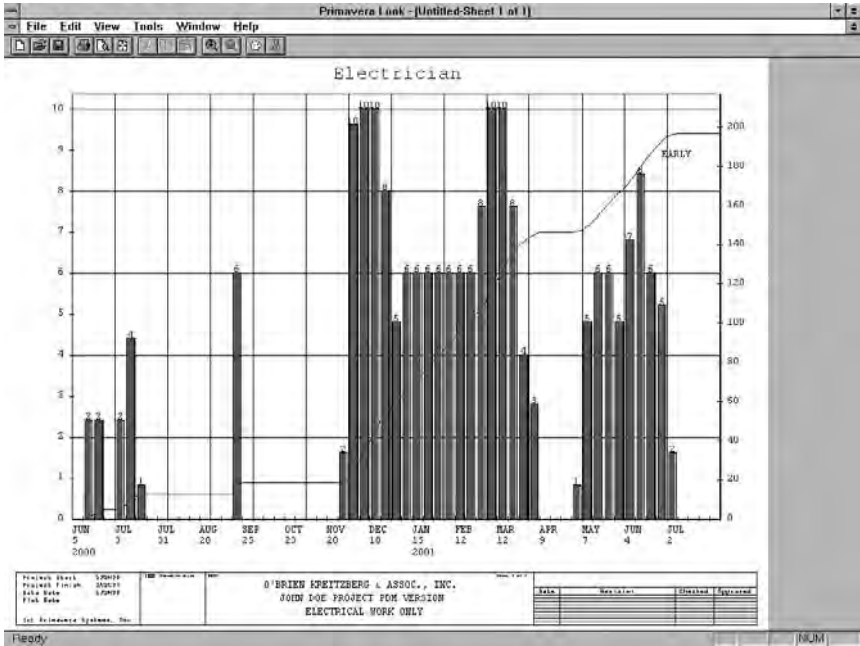

Figure 19.5.4 John Doe project—leveled for a maximum of 10 electricians.

### 19.6. Resource Leveling Significance

Network planning had its genesis from 1958 to 1964. At that time, proven computer programs from not only CPM but also PDM and resource leveling were available. Resource leveling was considered an option, and it was often not used because of the money, time, and effort required. However, John W. Fondahl (Civil Engineering Emeritus of Stanford University) believed that considering resources in scheduling was so important that he devoted more than half of his Peurfoy Construction Research Award Lecture\* to that topic. Referring to networking techniques, he stated:

“They offer examples of our failure to effectively implement techniques after they have been introduced. Consider the topic of resource leveling. Almost all construction projects are affected by the availability and economics of usage of resources. In most cases, the importance of resource leveling is a matter of reducing costs by avoiding peaks and valleys in daily requirements. However, in many cases it is essential because there are

\*Presented at the November 5, 1990 ASCE National Convention, recorded in the *Journal of Construction Engineering and Management*, vol. 117, no. 3, September 1991, pp. 380–392.

availability limits that must be met. Even where such limits don't exist initially, they can be introduced once decisions on plant and equipment capacities have been made or major purchases have occurred."

While resource-leveling techniques have been available since the early 1960s, for many years they were largely ignored in CPM applications. A schedule based on early start dates for each activity was generally issued. Such a schedule is almost always uneconomical and is often completely impossible.

Professor Fondahl presented an example problem in which his construction planning and scheduling classes have addressed for more than 25 years. The project involves a small warehouse project with 30 activities. Sequence relationships, durations, and resource requirements for the resource are given, and the students plot the network diagram and make the basic scheduling calculations. The resulting project duration (without resource limitation) is 28 days.

An early-start-based calculation shows a high (20 units) and irregular requirement for resource C. Sufficient resources are available for resources A and B. The students manually level the network and determine that the network can be done with resource C limited to 4 units in 28 days. However, the schedule is now very tight.

In 1977, Professor Fondahl added a contract clause that limited the extensions of time to changes that exceeded the total float on channels involved. (Also, time extensions were limited to the amount by which the total float path was exceeded.) In the problem, a change order that was issued before the project started affected four activities and increased their durations. In each case, the duration increase did not exceed either activity total float or free float. The project was subject to the same resource limitations, and it was assumed that the contractor had performed a conventional network analysis without resource leveling. On the basis of the CPM calculations, with extended durations, the 28-day duration was not exceeded and no time extension would be allowed.

By using the same procedures as before, the students determined that the project duration was extended to 50 days. (Professor Fondahl notes that resource-leveling answers are heuristic, and that "eyeball" solutions using "judgment manipulations" can bring the answer to a rock-bottom solution of 47 days.)

Professor Fondahl then had the students

level both the original problem and the change order problem using one of the more powerful commercial software packages. The results obtained are 31 days and 52 days, respectively. An apparent reason for the poorer results is that, even though this is a sophisticated program, it lacks the ability to interrupt activities that are interruptible.

He described the concept of a “resource critical” activity in this way:

“If critical activities are performed at their estimated duration but start late, the project duration will also be delayed. One reason for starting late is that sufficient resources are unavailable in the resource pool. These resources will only be available when activities using them are completed and, therefore, those activities are able to release a sufficient number of the required resource units. Often, those activities that must release resource units may not be critical in the sense of having zero float. However, if they fail to release the resource units needed by a critical activity, they delay that activity and, hence, the project. Therefore, an activity having positive float can still be “resource critical,” since it will delay completion if it fails to release resources on time. In more complex networks, there may be several activities that release resources to the resource pool on a given date and, therefore, to a critical activity that needs some of these resource units from the pool. In these cases, there may not be a single specific activity in the group that must release its units and that, therefore, can be identified as being “resource critical.”

Some of Professor Fondahl’s conclusions in regard to resource leveling are:

“The results shown in these simple problems indicate that the conventional concepts of float time break down in a resource-constrained project. Float times may be much less than computed or may not exist at all, and project duration may not be determined by the conventionally calculated critical path. Again, since almost any construction project either must be resource-leveled to achieve a feasible solution or should be resource-leveled to achieve an economic solution, we have a problem that is almost always present but seems to be universally ignored. Some, and often many, of the conventional CPM data are not valid. The originally calculated network data, including float data, are useful as a basis for establishing and applying priority rules in heuristic leveling procedures. However, once leveling has been performed, float times may have little meaning.

A resource-critical activity is only critical based on the current leveled schedule. If its duration increases, project duration will increase if the job program remains the same. However, a new leveling run or a leveling run with different priority rules may produce a different job program, which may or may not show a longer project duration. Since it has not yet proved practical to use mathematically optimum solutions, we must depend on heuristic solutions whose results, in turn, depend on the particular “fit” that is achieved on a given leveling run. Thus a 1-day delay of a resource critical activity might, if releveling were performed, produce a one-day project delay or no delay, or more than a 1-day delay.

In summary, on this subject of implementation, I am using this example to say that, after 30 years, very few practitioners, or even those teaching the subject, seem to be aware of some of the basic shortcomings of widely used network scheduling techniques.”

## 19.7. Summary

Resources such as workforce, equipment and money, can be assigned to CPM activities. For a simple network, maximum workforce requirements can be forecast and leveled by two manual techniques. When resource limits are set in, the project duration can be lengthened. Manual techniques are limited and cannot handle large networks. Large networks are an excellent area for computer application.

When a schedule is resource-constrained (i.e., certain resources are not available to support critical activities), the network float concept no longer controls identification of controlling activities. In multiproject systems, such as turnarounds, the identification of the critical path is often less important than the cataloging of all the work to be done.

*This page intentionally left blank*



## Procurement

Materials are integral to any construction project. If materials are delivered early, a particular activity usually cannot be sped up because the progress of other activities controls the activity's early start time. Failure to deliver the materials for an activity can, however, delay the activity indefinitely. Thus, the project purchasing agent or materials coordinator has a difficult job. If materials are delivered late, the project is delayed. If they are delivered early, the field group complains about extra handling and storage. The problem is most acute in urban areas, where project supervisors generally want to unload materials immediately from truck or railcar to final location.

### 20.1. Scheduling Materials Procurement

Just as subcontractors complain that the general contractor neglects their situations, most purchasing agents complain that their own companies fail to keep them informed about material needs. Obviously, this problem can be solved with CPM. Because almost every activity requires materials of some sort, someone would have to review all of the activities in order to control the delivery of all the materials.

A practical method of reducing the workload is to separate materials into two classes: commodities and key materials. Materials that can be ordered out of stock for delivery in a week or less can be classified as commodities, and the schedule for the first shipment of any type of commodity is useful. Key materials are those with long delivery times or those that involve custom orders.

Reviewing the network computer run can furnish all of the necessary information about materials, particularly the order in which key materials should be requisitioned. If an activity is added to the diagram for

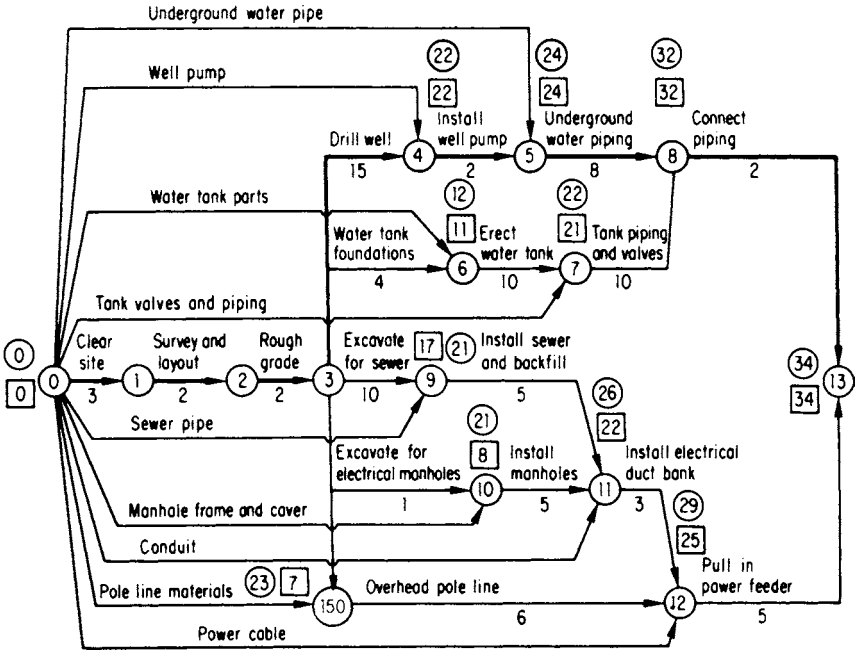

Figure 20.1.1 Deliveries for John Doe project site preparation; zero delivery.

each key delivery, necessary information about the delivery is generated as part of the computer run.

Figure 20.1.1 shows the site preparation network for the John Doe project with the delivery activity shown in Table 20.1.1.

Note that well pump and water tank would definitely be key deliveries. The other materials could be commodities or custom items depending on

TABLE 20.1.1 Material Delivery Activities for John Doe Project

Activity	Delivery
0-4	Well pump
0-5	Underground water pump
0-6	Water tank parts
0-7	Tank valves and piping
0-9	Sewer pipe
0-10	Manhole frame and cover
0-11	Conduit
0-12	Power cable
0-150	Poles, crossbars, guys, insulators

TABLE 20.1.2 Calculations if All Materials Available

<i>i-j</i>	Duration (days)	Description	ES	EF	LS	LF	Float (days)
0-4	0	Well pump	0	0	22	22	22
0-5	0	Underground pipe	0	0	24	24	24
0-6	0	Water tank	0	0	12	12	12
0-7	0	Tank valves	0	0	22	22	22
0-9	0	Sewer pipe	0	0	21	21	21
0-10	0	Manhole frame and cover	0	0	21	21	21
0-11	0	Conduit	0	0	26	26	26
0-12	0	Power feeder	0	0	29	29	29
0-150	0	Pole line materials	0	0	23	23	23

the specifications to be met. If it is assumed that all materials are on hand (for instance, if the owner is furnishing them), the time duration for the activities is zero. The computed information for the deliveries is shown in Table 20.1.2.

Because materials are not usually available at the start of a project, a reasonable delivery time estimate is assigned to the delivery activities, as shown in Table 20.1.3. These durations are added to Figure 20.1.2.

Event times are computed on the diagram. The activity times for deliveries are shown in Table 20.1.4.

Introducing delivery times increases this portion of the project from 34 to 52 days. The critical path has shifted; it is now through events 0-6-7-8-13. The old and new event times are shown in Table 20.1.5.

Out of a possible 28 event times, 21 have changed. Using the new late-start information, the purchasing department can deliver the materials in the order shown in Tables 20.1.6 and 20.1.7.

TABLE 20.1.3 Durations for Procurement of Materials

Activity	Assume	Duration (days)	
0-4	Well pump	Stock delivery, 4 weeks	20
0-5	Underground water pipe	Mechanical joint, 6 weeks	30
0-6	Water tank parts	Standard size, 6 weeks	30
0-7	Tank valves	Standard gate valves, 4 weeks	20
0-9	Sewer pipe	Terra cotta, 1 week	5
0-10	Manhole cover	Stock, 1 week	5
0-11	Conduit	Stock, 1 week	5
0-12	Power feeder	Special order, 8 weeks	40
0-150	Pole material	Stock order, 2 weeks	10

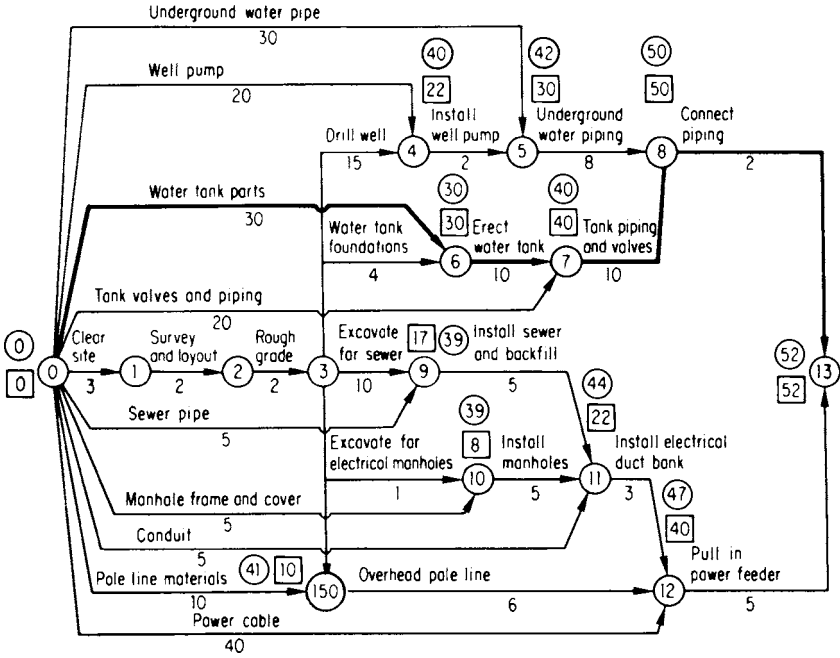

Figure 20.1.2 Delivery times for John Doe project site preparation.

Although the list gives the order in which materials should be ordered, it has two distinct weaknesses. First, although the late start dates for ordering are important, they are extremes. If the order is placed this late, all activities following the delivery will be critical. Second, the early start times have very little value. In this example, the purchasing department could initiate nine orders the first day of the project. What

TABLE 20.1.4 Calculations Including Procurement Time for Materials

<i>i-j</i>	Duration (days)	Description	ES	EF	LS	LF	Float (days)
0-4	20	Well pump	0	20	20	40	20
0-5	30	Underground water pipe	0	30	12	42	12
0-6	30	Water tank	0	30	0	30	0
0-7	20	Tank valves	0	20	20	40	20
0-9	5	Sewer pipe	0	5	34	39	34
0-10	5	Manhole cover	0	5	34	39	34
0-11	5	Conduit	0	5	39	44	39
0-12	40	Power feeder	0	40	7	47	7
0-150	10	Pole material	0	10	31	41	31

TABLE 20.1.5 Impact of Procurement Durations

Early event times			Late event times	
Old	New	Event	Old	New
3	3	1	3	21
5	5	2	5	23
7	7	3	7	25
22	22	4	22	40
24	30	5	24	42
11	30	6	12	30
21	40	7	22	40
32	50	8	32	50
17	17	9	21	39
8	8	10	21	39
22	22	11	26	44
25	40	12	29	47
34	52	13	34	52
—	10	150	—	41
Changes 7			Changes 14	

if an enthusiastic buyer orders the sewer pipe and conduit on the first project day? The conduit will arrive on site about 8 weeks before it is needed; the sewer pipe will be 7 weeks early. The field group will have a storage problem and develop a poor opinion of the office group.

These problems have often discouraged the use of CPM for coordinating materials procurement. The real defect in the system is that the early start time is unrelated to the field work. Leaving the delivery arrows to represent delivery times, adds another set of arrows to represent the actual movement of the material from storage to the job site. The “on-site material” arrows have zero time duration and the same late finish times as the delivery arrows.

Figure 20.1.3 shows the nine new arrows. Because they have a zero time duration, early start equals early finish and late finish equals late start. The *ES*, *LF*, and float times are shown in Table 20.1.8.

Note that the late finish times for these activities are the same as the late finish times for the delivery arrows. However, the early start times and float times are now related to the field progress. On this basis, the

TABLE 20.1.6 Most Critical Procurement

Activity	Description	Late start
0-6	Water tank	0
0-12	Power feeder	7
0-5	Underground water pipe	12

TABLE 20.1.7 Less Critical Procurement

Activity	Description	Late start
0-4	Well pump	20
0-7	Tank valves	20
0-150	Pole material	31
0-9	Sewer pipe	34
0-10	Manhole cover	34
0-11	Conduit	39

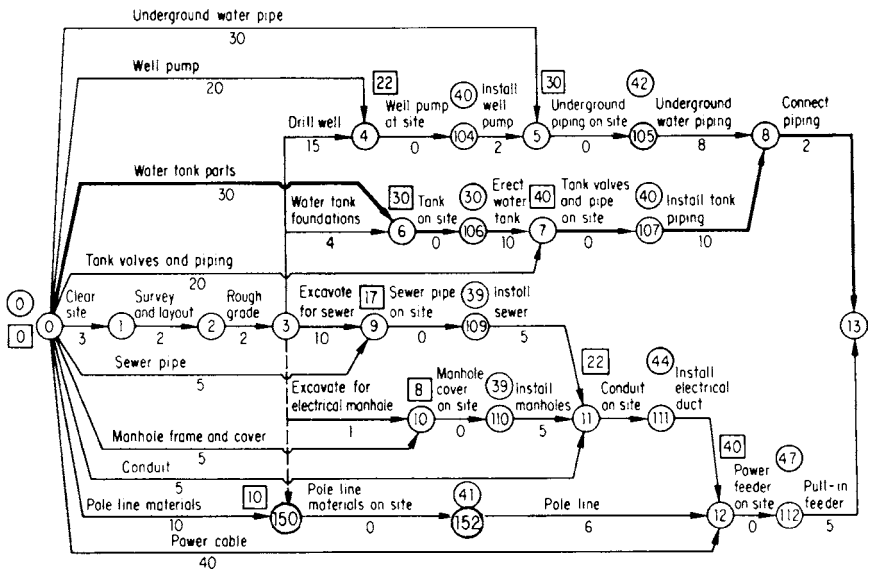

Figure 20.1.3 On-site delivery times.

TABLE 20.1.8 Calculated On-site Delivery Times

Activity	Description	ES	LF	Float (days)
4-104	Well pump at site	22	40	18
5-105	Underground pipe at site	30	42	12
6-106	Water tank at site	30	30	0
7-107	Tank valves at site	40	40	0
9-109	Sewer pipe at site	17	39	22
10-110	Manhole cover at site	8	39	31
11-111	Conduit at site	22	44	22
12-112	Power feeder at site	40	47	7
150-152	Pole material at site	10	41	31

**TABLE 20.1.9 Priority of Material Procurement**

Priority	Position on first order list	Delivery as early as	Delivery no later than	Float (days)
1. Water tank	1	30	30	0
2. Tank valves	5	40	40	0
3. Power feeder	2	40	47	7
4. Underground pipe	3	30	42	12
5. Well pump	4	22	40	18
6. Sewer pipe	7	17	39	22
7. Conduit	9	22	44	22
8. Manhole cover at site	8	8	39	31
9. Pole material	6	10	41	31

priority of ordering is as shown in Table 20.1.9. Note that all but two of the items are in a different position of priority on the second list.

In addition to the time required for material delivery and the determination of the delivery time, which should be specified on the order, a number of other steps in materials procurement are time consuming and must not be neglected. These can include approving shop drawings, the architect's review of the shop drawings, a resubmittal time for any shop drawing corrections, and review by other agencies. These steps can sometimes be accelerated for critical activities (when they are, in fact, identified as critical). However, there is a tendency to minimize the impact of routine steps, so take care to properly reflect them on your diagram.

Figure 20.1.4 shows the interrelation between two material orders (hardware and door bucks) before either material reaches the job site. Note that in this example the door buck delivery has 5 days float because

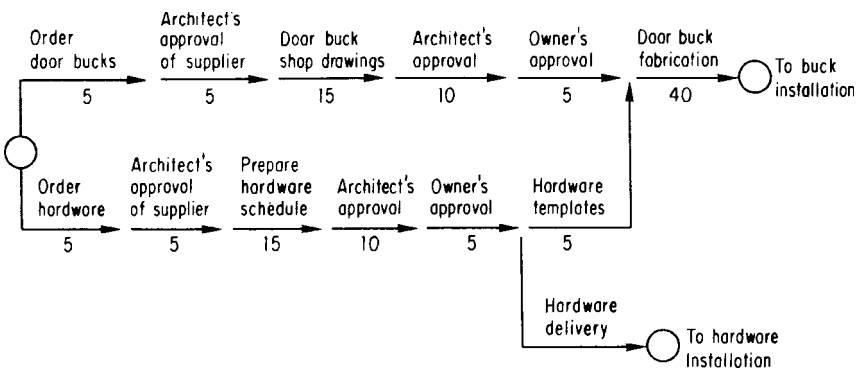

**Figure 20.1.4** Typical material procurement cycle.

of the time required to prepare hardware templates. Larger equipment might require additional time for the submission of formal bids. In Figure 20.1.1, the addition of 9 simple delivery arrows almost doubled the network size. In this network, the number of arrows showing the total materials procurement could easily be more than double the number of arrows showing the associated field work.

Because the average project requires several separate sheets to represent its network, it is recommended that the materials procurement work be on its own sheet to avoid confusion between the office and field functions. Of course, the “materials at site” arrows must remain with the field portion of the network. Figure 20.1.5 shows the materials portion of the John Doe project, and some typical material lead times for a process plant project are shown in Table 20.1.10.

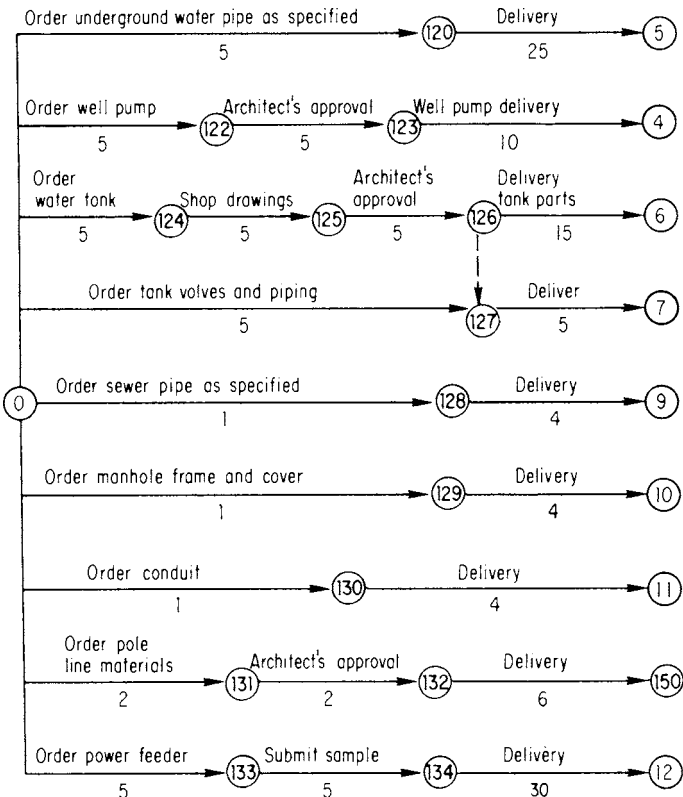

Figure 20.1.5 John Doe project material procurement.



**TABLE 20.1.10 Material Lead Times for a Process Plant**

	Approval of drawings, weeks	Anticipated delivery (after approval and release), weeks
Building		
Enclosure		
Structural steel	4-6	8-13
Steel joists	2-4	8-10
Siding	3-4	13-26
Mechanical		
HVAC-fans	2-4	13-18
HVAC-chillers	4-6	18-26
Agitators/mixers	6-8	26-32
Centrifugal blowers	4-6	20-26
Compressors (packaged centrifugal)	8-10	26-39
Compressors (packaged reciprocating)	6-8	26-30
Electrical equipment		
Motor control centers	8-10	26-40
Switch gear (low voltage)	8-10	36-40
Switch gear (high voltage)	8-10	40-52
Transformers (low voltage)	6-8	30-39
Transformers (high voltage)	6-8	40-52
Motors (to 150 hp)	6-8	16-26
Motors (over 150 hp)	6-8	26-39
		(dependent on horsepower)
Turbines	8-10	40-50
Power cable (600 V)	N/R	30-52
		(dependent on quantity)
Bus duct	6-8	26-36
Cable tray	6-8	18-26
Conduit (rigid aluminum)	N/R	Stock-28
Conduit (E.M.T.)	N/R	Stock-26
Emergency generators	10-12	26-30
Architectural		
Hollow metal frames	8-10	12-18
Hardware	10-12	18-26
Process equipment		
Pressure vessels (carbon steel)		
Small (noncode)	4-6	18-26*
Small (—under 20,000 lb)	4-6	26-36*
Large (code—over 20,000 lb)	6-8	36-40
Towers (w/o internals/trays)	6-8	46-50
Towers (with internals/trays)	8-10	52-60
Jacketed vessels/tanks	8-10	52-60
Field-erected tanks	8-10	40-52
		(includes erection)
Heat exchangers		
Shell and tube (small)	4-6	18-20
Shell and tube (large)	6-8	36-46
Fintube	4-6	18-26
Plate type	4-6	36-40
Air-cooled exchangers	4-6	26-36

(Continued)

**TABLE 20.1.10 Material Lead Times for a Process Plant (Continued)**

	Approval of drawings, weeks	Anticipated delivery (after approval and release), weeks
Process equipment		
Conveyors		
Pneumatic	6–8	26–30
Screw	6–8	24–30
Live roller and drag	6–8	24–28
Vibrating	6–8	26–30
Bucket elevators	6–8	26–30
Belt	6–8	30–34
Pumps		
Centrifugal	4–6	20–26
Centrifugal (horizontal)	6–8	26–32
Centrifugal (turbine)	6–8	24–30
Metering	4–6	20–34
Positive displacement	4–6	20–24
Vacuum	6–8	26–30
Reciprocating	6–8	26–30
Dryers, filters, and scrubbers		
Instrument air dryers	8–10	24–30
Filters	6–8	20–26
Dust collectors	6–8	30–40
Fume scrubbers	6–8	20–30
Control valves	3–4	20–24
Instrumentation		
Displacement-type flowmeters	3–4	18–26
D.P. transmitters	4–5	16–22
Liquid level gauges	3–4	18–20
Transducers	3–4	14–28
Level switches	3–4	12–16
Pressure switches	3–4	16–18
Controllers	4–5	18–20
Recorders	4–5	18–20
Thermometers	3–4	14–16
Pressure gauges	3–4	16–20
Pipe, valves, flanges, and fittings	N/A	Stock to 52 weeks
Materials handling equipment		
Monorail hoists		
	4–6	18–26 (dependent on capacity)
Traveling/trolley cranes		
	4–6	30–42 (dependent on capacity)
Forklift trucks		
	4–6	26–30

\*Add 4 weeks for stainless.

## 20.2. John Doe Example

As noted previously, it is not usual to incorporate commodity or stock items in the CPM network. Many projects have a three- to nine-month excavation, foundation (piles), and foundation concrete phase with a short cycle startup for the design mix and rebar delivery. In this typical situation, the site and foundation work schedule has float built into it for the procurement process.

In the John Doe site example, the owner would do well to provide the water tank and well pump. Another approach would be to evaluate the requirement to provide all site services prior to event 34. If the site activities could be put in parallel with the foundation work, more time would be available for site equipment procurement.

The site equipment procurement has been treated previously. To consider procurement for the balance of the John Doe project, the network should be modified to create more definitive delivery points. For instance, event 37 is a common starting point for all plant activities. Accordingly, it is not the best delivery node. Adding logic spreaders between event 37 and key delivery points will establish more definitive delivery information. This is shown in Figure 20.2.1.

Table 20.2.1 lists the sequence of procurement activities (i.e., submit and approve shop drawings, fabricate, and deliver) for 14 items. These 14

**TABLE 20.2.1 John Doe Project Procurement**

Item	Starting event	Submit	Event	Approve	Event	Fabricate	Event
		shop drawings, work days		shop drawings, work days		and deliver, work days	
Foundation rebar	0	10	210	10	211	10	16
Structural steel	0	20	212	10	213	40	23
Crane	0	20	214	10	215	50	31
Bar joists	0	20	216	10	217	30	33
Siding	0	20	218	10	219	40	35
Plant electrical load center	0	20	220	10	221	90	300
Power panels—plant	0	20	222	10	223	75	301
Exterior doors	0	20	224	10	225	80	303
Plant electrical fixtures	0	30	225	15	226	75	51
Plant heating and ventilating fans	0	20	227	10	228	75	304
Boiler	0	20	229	10	230	60	306
Oil tank	0	20	231	10	232	50	305
Precast	0	40	223	10	234	30	58
Packaging A/C	0	30	235	10	236	90	60

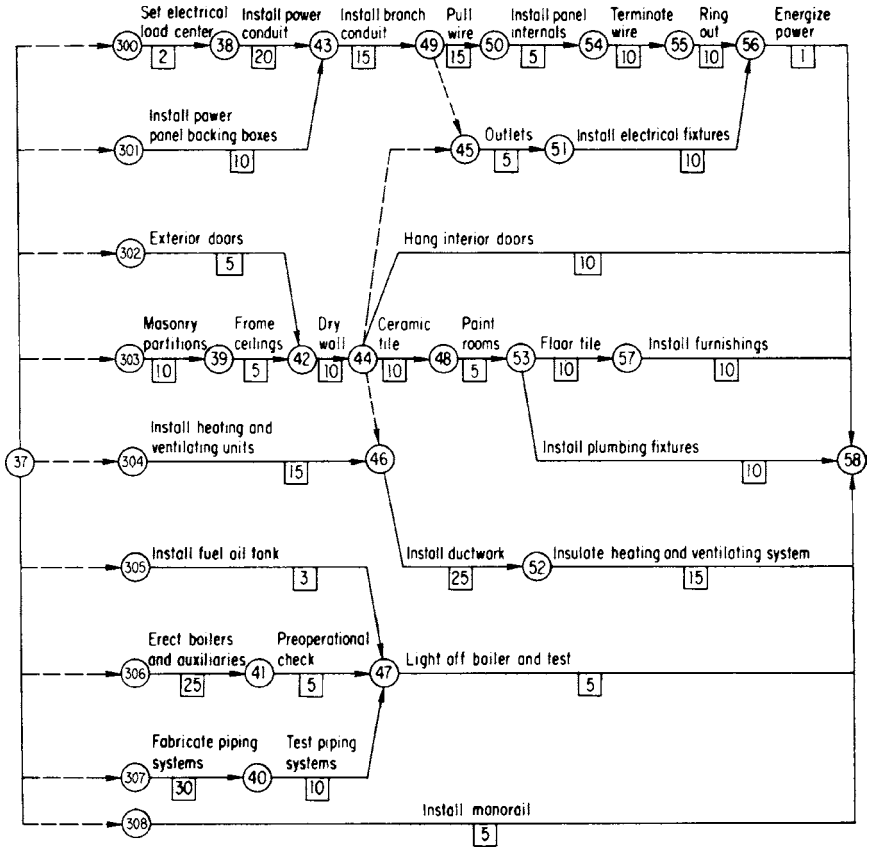

Figure 20.2.1 John Doe plant with added delivery points.

items were added to the computer master file and a new computation was made. The procurement portion of the John Doe project (after the site work) is listed by late start (in order of float priority) in Figure 20.2.2.

Note that the example procurement times are in the expeditious range. If the times, especially for switch gear, were taken from the prior typical procurement time tables, procurement would control the schedule. Assuming this is unacceptable, the owner has two choices: either expedite (i.e., shorten) the procurement dates or preorder (i.e., order before selecting the contractor) key equipment, such as the well pump, water tank, electrical switch gear, and steel.

Figure 20.2.3 is a partial sort of the John Doe project by specification section. It can be used by the purchasing department when preparing subcontracts or purchase orders to determine the scope of work under each specification section.

REPORT DATE CPM IN CONSTRUCTION MANAGEMENT - 6TH EDITION START DATE 5/JUN00 FIN DATE 20/JUL01  
 PROCUREMENT DATA DATE 5/JUN00 PAGE NO. 1

PRED	SUCC	ORIG REM	DUR	DUR	%	CODE	ACTIVITY DESCRIPTION	EARLY START	EARLY FINISH	LATE START	LATE FINISH	TOTAL FLOAT
0	212	20	20	0	0		SUBMIT STRUCTURAL STEEL	5/JUN00	30/JUN00	5/JUN00	30/JUN00	0
0	220	20	20	0	0		SUBMIT PLANT ELECTRICAL LOAD CENTER	5/JUN00	30/JUN00	13/JUN00	13/JUL00	6
212	213	10	10	0	0		APPROVE STRUCTURAL STEEL	3/JUL00	17/JUL00	3/JUL00	17/JUL00	0
0	210	10	10	0	0		SUBMIT FOUNDATION REBAR	5/JUN00	16/JUN00	6/JUL00	15/JUL00	22
0	214	20	20	0	0		SUBMIT CRANE	5/JUN00	30/JUN00	13/JUL00	7/AGO00	25
220	221	10	10	0	0		APPROVE PLANT ELECTRICAL LOAD CENTER	3/JUL00	17/JUL00	13/JUL00	25/JUL00	6
0	224	20	20	0	0		SUBMIT EXTERIOR DOORS	5/JUN00	30/JUN00	17/JUL00	11/AGO00	29
0	225	30	30	0	0		SUBMIT PLANT ELECTRICAL FIXTURES	5/JUN00	17/JUL00	17/JUL00	25/AGO00	29
210	211	10	10	0	0		APPROVE FOUNDATION REBAR	3/JUN00	30/JUN00	20/JUL00	2/AGO00	22
0	222	20	20	0	0		SUBMIT POWER PANELS - PLANT	5/JUN00	30/JUN00	21/JUL00	17/AGO00	33
0	227	20	20	0	0		SUBMIT PLANT HEATING AND VENTILATING FANS	5/JUN00	30/JUN00	7/AGO00	1/SEP00	44
214	215	10	10	0	0		APPROVE CRANE	3/JUL00	17/JUL00	8/AGO00	21/AGO00	25
0	218	20	20	0	0		SUBMIT SIDING	5/JUN00	30/JUN00	9/AGO00	6/SEP00	46
224	225	10	10	0	0		APPROVE EXTERIOR DOORS	3/JUL00	17/JUL00	14/AGO00	25/AGO00	25
0	215	20	20	0	0		SUBMIT BAR JOISTS	5/JUN00	30/JUN00	15/AGO00	1/SEP00	56
222	223	10	10	0	0		APPROVE POWER PANELS - PLANT	3/JUL00	17/JUL00	18/AGO00	31/AGO00	33
227	228	10	10	0	0		APPROVE PLANT HEATING AND VENTILATING FANS	3/JUL00	17/JUL00	5/SEP00	1/SEP00	44
218	219	10	10	0	0		APPROVE SIDING	3/JUL00	17/JUL00	7/SEP00	20/SEP00	46
216	217	10	10	0	0		APPROVE BAR JOISTS	3/JUL00	17/JUL00	11/SEP00	26/SEP00	51
0	229	20	20	0	0		SUBMIT BOILER	5/JUN00	30/JUN00	26/SEP00	23/OCT00	71
0	235	30	30	0	0		SUBMIT PACKAGED A/C	5/JUN00	17/JUL00	3/OCT00	13/NOV00	84
229	230	10	10	0	0		APPROVE BOILER	3/JUL00	17/JUL00	24/OCT00	6/NOV00	75
225	226	15	15	0	0		APPROVE PLANT ELECTRICAL FIXTURES	18/JUL00	7/AGO00	30/OCT00	17/NOV00	71
235	236	10	10	0	0		APPROVE PACKAGED A/C	18/JUL00	31/JUL00	14/NOV00	2/NOV00	84
0	231	20	20	0	0		SUBMIT OIL TANK	5/JUN00	30/JUN00	16/NOV00	14/DEC00	114
0	233	40	40	0	0		SUBMIT PRECAST	5/JUN00	31/JUL00	29/NOV00	25/JAN01	124
231	232	10	10	0	0		APPROVE OIL TANK	3/JUL00	17/JUL00	15/DEC00	2/DEC00	114
307	40	30	30	0	0		FABRICATE PIPING SYSTEMS	1/DEC00	15/JAN01	19/JAN01	1/MAR01	31
233	234	10	10	0	0		APPROVE PRECAST	1/NOV00	14/NOV00	26/JAN01	8/FEB01	124

Figure 20.2.2 Procurement activities sorted by late start.

REPORT DATE CPM IN CONSTRUCTION MANAGEMENT - 6TH EDITION START DATE 5/JUN00 FIN DATE 20/JUL01  
 SUB-TRADE REPORT DATA DATE 5/JUN00 PAGE NO. 1

PRED	SUCC	ORIG REM	DUR	DUR	%	CODE	ACTIVITY DESCRIPTION	EARLY START	EARLY FINISH	LATE START	LATE FINISH	TOTAL FLOAT
0	1	3	3	0	1	1	CLEAR SITE	5/JUN00	7/JUN00	7/JUN00	9/JUN00	2
2	3	2	2	0	1	1	ROUGH GRADE	15/JUN00	13/JUN00	14/JUN00	15/JUN00	3
3	9	10	10	0	1	1	EXCAVATE FOR SEWER	14/JUN00	27/JUN00	22/JUN00	6/JUL00	6
3	10	1	1	0	1	1	EXCAVATE ELECTRIC MANHOLES	14/JUN00	14/JUN00	6/JUL00	6/JUL00	15
14	23	3	3	0	2	1	EXCAVATE FOR OFFICE BUILDING	26/JUL00	27/JUL00	8/SEP00	12/SEP00	32
15	16	5	5	0	2	1	EXCAVATE PLANT WAREHOUSE	8/AGO00	14/AGO00	10/AGO00	16/AGO00	2
18	19	3	3	0	2	1	BACKFILL AND COMPACT P-W	8/SEP00	8/SEP00	6/SEP00	12/SEP00	2
25	24	1	1	0	2	1	BACKFILL AND COMPACT OFFICE	27/SEP00	27/SEP00	27/SEP00	27/SEP00	0
58	94	5	5	0	5	1	FINE GRADE	21/MAR01	29/MAR01	9/JUL01	13/JUL01	74
1	2	2	2	0	2	2	SURVEY AND LAYOUT	8/JUN00	9/JUN00	12/JUN00	13/JUN00	2
13	14	1	1	0	2	2	BUILDING LAYOUT	24/JUL00	24/JUL00	26/JUL00	26/JUL00	2
3	6	4	4	0	2	3	WATER TANK FOUNDATIONS	14/JUN00	19/JUN00	13/JUN00	22/JUN00	3
16	17	5	5	0	2	3	FOUR FEET CASE P-W	15/AGO00	21/AGO00	17/AGO00	23/AGO00	6
17	18	10	10	0	2	3	FORM AND POUR GRADE BEAMS P-W	22/AGO00	5/SEP00	24/AGO00	7/SEP00	2
18	22	5	5	0	2	3	FORM AND POUR RAILROAD LOADING DOCK P-W	6/SEP00	12/SEP00	20/SEP00	26/SEP00	10
18	22	5	5	0	2	3	FORM AND POUR TRUCK LOADING DOCK P-W	6/SEP00	12/SEP00	20/SEP00	26/SEP00	10
23	24	4	4	0	2	3	SPREAD FOOTINGS OFFICE	13/SEP00	18/SEP00	13/SEP00	18/SEP00	0
24	25	6	6	0	2	3	FORM AND FOUR GRADE BEAMS OFFICE	19/SEP00	26/SEP00	19/SEP00	26/SEP00	0
22	29	10	10	0	2	3	FORM AND FOUR SLABS P-W	25/SEP00	6/OCT00	27/SEP00	10/OCT00	2
28	29	3	3	0	2	3	FURN AND POUR SLABS OFFICE	6/OCT00	10/OCT00	6/OCT00	10/OCT00	0
3	12	6	6	0	1	4	OVERHEAD POLE LINE	14/JUN00	21/JUN00	13/JUL00	18/JUL00	18
10	11	5	5	0	1	4	INSTALL ELECTRICAL MANHOLES	15/JUN00	21/JUN00	7/JUL00	13/JUL00	15
11	12	3	3	0	1	4	INSTALL ELECTRICAL DUCT BANK	6/JUL00	10/JUL00	14/JUL00	18/JUL00	6
12	13	5	5	0	1	4	PULL IN FEEDER	13/JUL00	17/JUL00	13/JUL00	25/JUL00	6
20	22	5	5	0	1	4	UNDERSLAB CONDUIT P-W	13/SEP00	22/SEP00	20/SEP00	24/SEP00	2
27	28	3	3	0	2	4	UNDERSLAB CONDUIT OFFICE	3/OCT00	5/OCT00	3/OCT00	5/OCT00	0
300	38	2	2	0	3	4	SET ELECTRICAL LOAD CENTER	1/DEC00	4/DEC00	1/DEC00	4/DEC00	0
301	43	10	10	0	3	4	INSTALL POWER PANEL BACKING BOXES	1/DEC00	14/DEC00	19/DEC00	31/JAN01	12
37	93	20	20	0	5	4	AREA LIGHTING	1/DEC00	29/DEC00	23/FEB01	2/MAR01	58
38	43	20	20	0	3	4	INSTALL POWER CONDUIT P-W	5/DEC00	14/JAN01	5/DEC00	31/JAN01	0
43	49	15	15	0	3	4	INSTALL BRANCH CONDUIT P-W	4/JAN01	24/JAN01	4/JAN01	24/JAN01	0
49	50	15	15	0	3	4	PULL WIRE P-W	25/JAN01	14/FEB01	25/JAN01	14/FEB01	0
45	51	5	5	0	3	4	ROOM OUTLETS P-W	25/JAN01	31/JAN01	1/MAR01	7/MAR01	25
51	56	10	10	0	3	4	INSTALL ELECTRICAL FIXTURES	1/FEB01	14/FEB01	8/MAR01	21/MAR01	25
50	54	5	5	0	3	4	INSTALL PANEL INTERNALS P-W	15/FEB01	21/FEB01	15/FEB01	21/FEB01	0
54	55	10	10	0	3	4	TERMINATE WIRES P-W	22/FEB01	7/MAR01	22/FEB01	7/MAR01	0
55	56	10	10	0	3	4	ENERGIZER POWER	9/MAR01	21/MAR01	9/MAR01	21/MAR01	0
56	58	1	1	0	3	4	ENERGIZER POWER	22/MAR01	22/MAR01	22/MAR01	22/MAR01	0
61	65	4	4	0	4	4	INSTALL BACKING BOXES	20/APR01	25/APR01	20/APR01	25/APR01	0
65	66	10	10	0	4	4	INSTALL CONDUIT OFFICE	26/APR01	9/MAY01	26/APR01	9/MAY01	0
66	74	10	10	0	4	4	PULL WIRE OFFICE	10/MAY01	23/MAY01	8/JUN01	21/JUN01	20
74	75	4	4	0	4	4	INSTALL PANEL INTERNALS OFFICE	24/MAY01	31/MAY01	23/JUN01	28/JUN01	20
74	79	4	4	0	4	4	A/C ELECTRICAL CONNECTIONS	24/MAY01	30/MAY01	10/JUL01	13/JUL01	31
75	79	10	10	0	4	4	TERMINATE WIRES OFFICE	1/JUN01	14/JUN01	29/JUN01	13/JUL01	20
79	80	5	5	0	4	4	RING OUT	15/JUN00	21/JUN01	16/JUL01	20/JUL01	20
9	11	5	5	0	1	5	INSTALL SEWER AND BACKFILL	28/OCT00	5/JUL00	7/JUL00	13/JUL00	6
5	8	8	8	0	1	5	UNDERGROUND WATER PIPING	10/NOV00	19/JUL00	23/JUL00	21/JUL00	2
19	20	5	5	0	2	5	UNDERSLAB CONDUIT P-W	11/SEP00	18/SEP00	11/SEP00	18/SEP00	2
26	27	3	3	0	2	5	UNDERSLAB PLUMBING OFFICE	28/SEP00	20/OCT00	28/SEP00	20/OCT00	0
53	58	10	10	0	3	5	INSTALL PLUMBING FIXTURES P-W	30/JAN01	12/FEB01	9/MAR01	22/MAR01	28

Figure 20.2.3 Partial list of John Doe project, sorted by specification section (Second code field).

### 20.3. Summary

If procurement is ignored in the scheduling process, materials and equipment deliveries can become the controlling factors by default. In most major projects, there is enough nonmaterials-oriented front-end work to allow time to order materials through the contractor. However, in special situations (renovations, overseas projects, and/or fast-track projects) it might be necessary for the owner to preorder equipment or materials.

---

Chapter  
**21**

## Preconstruction

In practice, and in this book, we have emphasized the use of CPM in planning and implementing construction. If a project is considered in terms of its construction phase only, the application of CPM can save both time and money. When used only in the construction phase, CPM is used as a control. However, many advantages other than just construction activities can be achieved by the earlier use of CPM in a project.

Construction is that time when the iceberg emerges and the entire project can be viewed and understood by many people. Problems are evident and activity is manifest. In most projects today, however, the time spent on construction is equaled by the time spent on the preconstruction design phase. Further, in public projects, the administrative review cycle often equals in time the design and construction periods. Thus, in the public or quasipublic sectors, the preconstruction project time (following identification of the project in a budget) is often twice the actual construction period.

Obviously, if disciplined project control techniques are applied early, substantial time can be saved and, therefore, subsequent cost savings can be achieved at a relatively low unit cost. In fact, the preconstruction phase of a project is the most probable area for applying cost-optimization techniques. Inputting additional funding during this phase can result in tremendous reductions in time.

Figure 21.0.1 illustrates the typical cash flow over 62 months between the budgeting and the opening of an elementary school. Although the school authorities on the date of budget approval might have the feeling that they have spent or committed the entire amount of money for the school, they have actually spent less than 20% of the overall budget for the next 40 months.

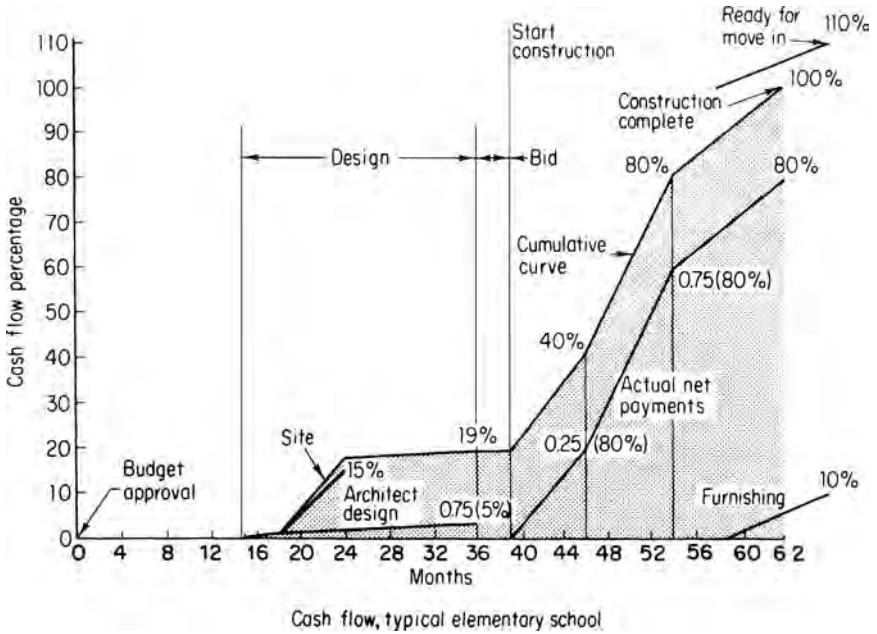

Figure 21.0.1 Cash flow typical elementary school.

In this example, in-house staff costs are not recognized, but they should be, because they can add another 10% or so to the cost of the project. Also, these costs are more heavily drawn on in the project's first 20 months than later, usually diminishing as others carry the project to completion. This example is a perfect illustration of why it is not easy to spend money even when the decision to do so has been reached.

The typical building project has four major phases or categories of progress:

1. *Predesign.* Predesign activities is the period between budget preparation and approval and the initiation of design. Usually the owner has primary responsibility for progress, including programming, in this phase.
2. *Design.* This is the phase in which the architect, engineer, A-E, or in-house design staff is primarily responsible for the project's progress.
3. *Construction.* In this phase it is the contractor or in-house construction force responsible for project progress.
4. *Furnish or move-in,* with the owner or contractor having primary responsibility.



### 21.1. Predesign Phase

One of the least-defined, intangible, and time-consuming phases of a project is the predesign portion. During this period, the owner, with technical staff and/or consultants, is very busy with a number of important roles, often performed by omission or default rather than carried out in a rigorous, planned manner. The seeds of many project problems are planted in this field of neglect.

Most all major projects seem to result from an evolutionary type of aggregate thinking from many sources that gathers pressure, both political and personal, until the project has been articulated. Key characteristics are power structure and consensus. Actually, this phase of the project should go through the following stages: establishment of goals, means of accomplishing goals, decision to proceed, identification of a funding source, and budget approval.

The decision to proceed requires identifying specific projects and the development of preliminary cost estimates, usually on the basis of gross estimating factors, such as costs per square or cubic foot. After a project has been given a budget and funding is available to meet the budget, the predesign phase moves to other stages.

Site selection, such as for a hospital addition or a school replacement or other finite location situation, is often part of the basic decision to proceed with a project. In many cases, however, a new site should or must be considered. Usually site consideration precedes the selection of a designer, because the design should be a function of the site. A number of nontechnical factors may funnel the choice of a site into a specific direction, such as

1. *Encumbrances.* Are there tenants who will have to be relocated? Are there structures to be removed?
2. *Land cost.* What are the economic values and factors?
3. *Transportation.* Is the location adequately served, and is it served by media suitable to the character of the facility's needs?
4. *Utilities.* What are the availability? Are there potential problems?
5. *Neighborhoods.* Is the environment suitable for the facility? Is the facility suitable for the environment?
6. *Zoning.* Does local zoning conform to the use intended?
7. *Community.* How will the community react to the facility?
8. *Subsurface conditions.* Will the foundations require unusual support? Are there unusual problems to be overcome?

There are other factors, but it is clear that when choosing a site, many factors must be carefully evaluated and considered. Unfortunately, many

site considerations are often considered in hindsight rather than at the proper time.

The last predesign activity is developing a specific program that identifies the owner's intent regarding the functional use of the project. This philosophical statement is important to the designer, but it is often presented in such a perfunctory, nonspecific fashion that the designer, through trial-and-error, ends up establishing the philosophy. It is clearly the owner's responsibility to establish these requirements and to interpret them in terms of cost impact prior to selecting a designer. Programming is a unique talent, requiring a combination of a consultant's knowledge and expertise.

Functional planning requires the availability or the assembly of pertinent information regarding the project. Demographic sources, such as the U.S. Census Bureau, city and state planning organizations, and in-house sources should be reviewed. Information should be arranged and stored so that it is accessible for reviewing future projects or for reconsidering the project underway. If information is stored in a computer databank, such exercises as modeling, gaming, or simulation of various alternatives, can be used to test the results of different potential approaches.

The functional programming effort should be tied back to the budgetary estimate, which it should either affirm or revise. Since the functional program incorporates the policy in regard to any project, it should be approved by the owner or proper authority.

A concomitant to the functional program is the architectural program, to which the functional program is necessarily related. The architectural program can be incorporated in the schematic design phase by the architect or furnished to the architect.

Typically, projects do not have formal program documents, which results in uncertainty at the beginning of the design phase. Because designers are not compensated for uncertainty, their only defense is to proceed slowly during the early stages of design, developing a program-type statement that can be confirmed or revised by their clients at a later time. Unfortunately, clients often change their minds almost constantly.

From the design point of view, this is not only time-consuming but expensive. Virtually the only defense designers have to carefully control the progress of the design, holding off every activity until a high level of definition has been achieved. This is expensive to designers and to owners, because the true design work is placed in too short a time for economical implementation.

The predesign phase is a frustrating one for schedulers and schedules. Many factors influence the viability of a project. In most cases, timing is not the controlling factor, but in a few situations it is paramount. The 1976 bicentennial celebration was a fixed time frame. World fairs and

Olympic games have a similar challenge of well-publicized fixed completion dates.

## 21.2. Design

Designing a project involves a relatively complex series of activities that become increasingly detailed as a project moves through the various design phases of schematic development, preliminary design, and working drawings.

**Schematic development.** This is also called the *sketch phase*, during which “concept” plans are developed by the architect and the basic engineering system is made. Design criteria are specified, and schematic drawings are prepared. A set of perspective sketches, or renderings, is usually prepared. The basic budgetary cost is confirmed, but only in very broad terms.

**Preliminary design.** This phase, also called *design development*, occurs after the approval of the sketch or schematic phase. The drawings are refined to a degree sufficient to permit the development of dimensioned space layouts. Heating and ventilating systems, main feeders or ducts, electrical main feeders, and dendrite dimensions of the structural framework are identified in this phase. Utility requirements are also defined and specific requirements are determined. A preliminary cost estimate is prepared, relatively firm at this stage.

**Working drawings.** This phase is also termed *contract documents* or *final design* and includes about two-thirds of the design work but fewer of the decisions, as well as a disproportionate amount of the design period (usually about half). The design, as defined in the prior stages, is developed in complete detail, including dimensions, so that it can be priced by prospective contractors. The contract documents include both drawings and specifications.

As the project design proceeds, each change becomes more difficult and expensive to implement. Each revision requires many more reviews and changes in related items. The range of changes that can be accepted gracefully narrows and costs much more as the design phase proceeds. This is illustrated in Figure 21.2.1.

In most cases, the design phase is essentially unscheduled and uncoordinated, even by the designer. This is partially understandable because specific interconnections among phases and disciplines, such as structural, mechanical, electrical, and plumbing, are difficult to express. Nevertheless, the design phase should be closely coordinated and interconnected at all stages so that field work will run smoothly. Otherwise,

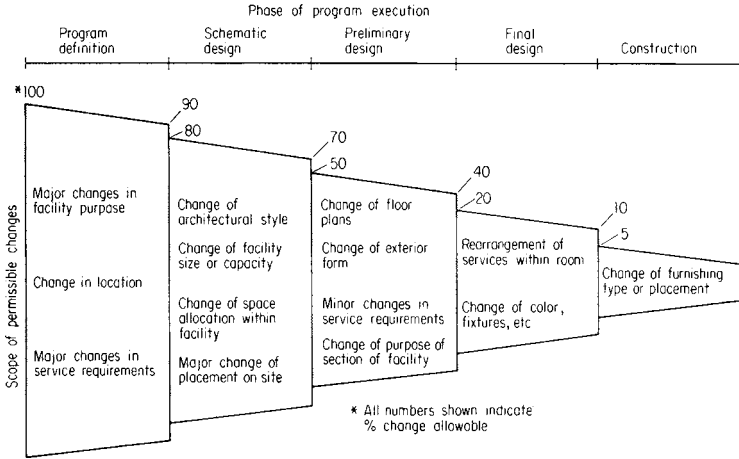

Figure 21.2.1 Design change funnel.

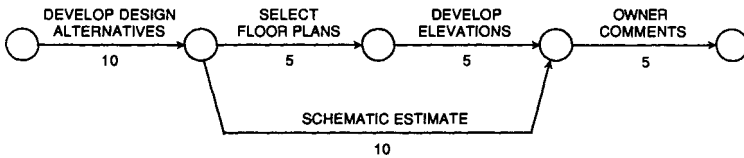

Figure 21.2.2 John Doe schematic design.

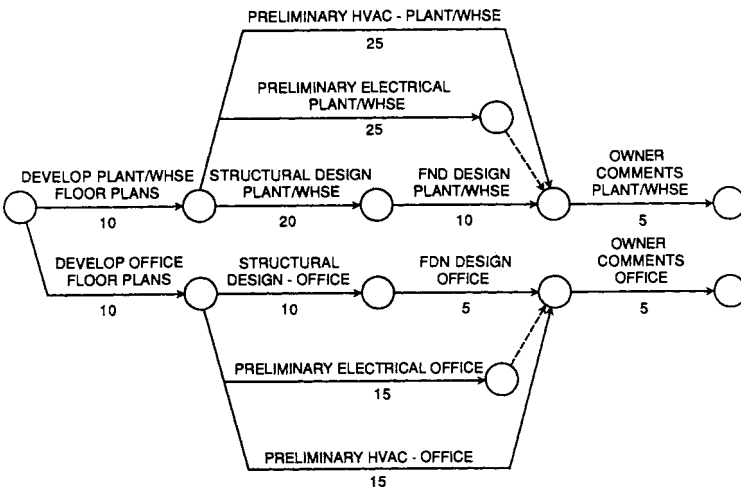

Figure 21.2.3 John Doe preliminary design.

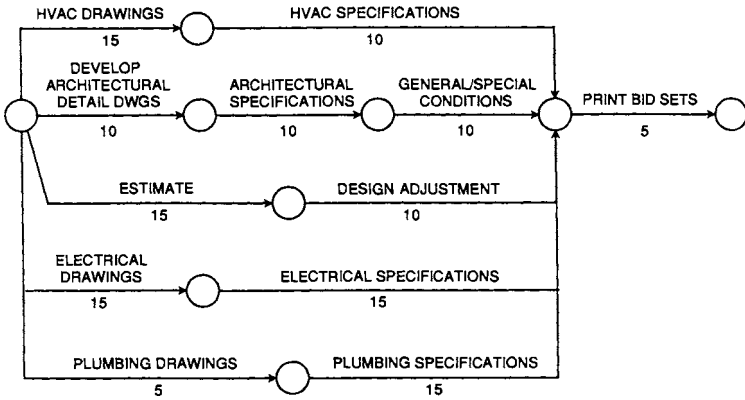

Figure 21.2.4 Contract documents: plant & warehouse.

it could result in a fantastically large scheduling network. The usual compromise is the scheduling of concurrent activities in broader terms with an implied understanding that continual physical liaison must be carried out.

Figure 21.2.2 is a CPM network for the schematic phase of design for the John Doe project, and Figure 21.2.3 is the network for the following preliminary design phase. Note that the design splits into two packages—plant-warehouse (P/W) and office—in the preliminary design phase. Figure 21.2.4 is the CPM for preparing contract documents for the plant-warehouse, and Figure 21.2.5 is the CPM for preparing contract documents for the office. Figures 21.2.6 to 21.2.9 are Figures 21.2.2 to 21.2.5 with CPM calculations added. Figure 21.2.10 is a

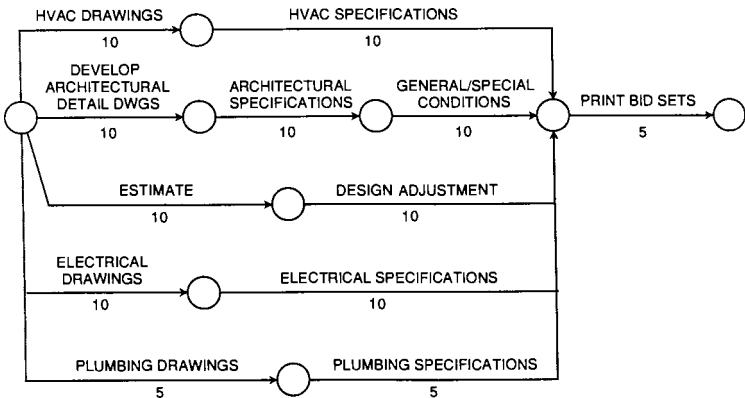

Figure 21.2.5 Contract documents: office.

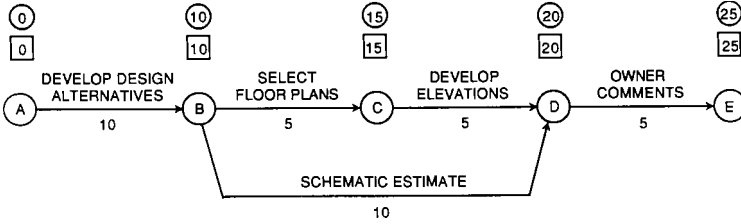

Figure 21.2.6 John Doe schematic design.

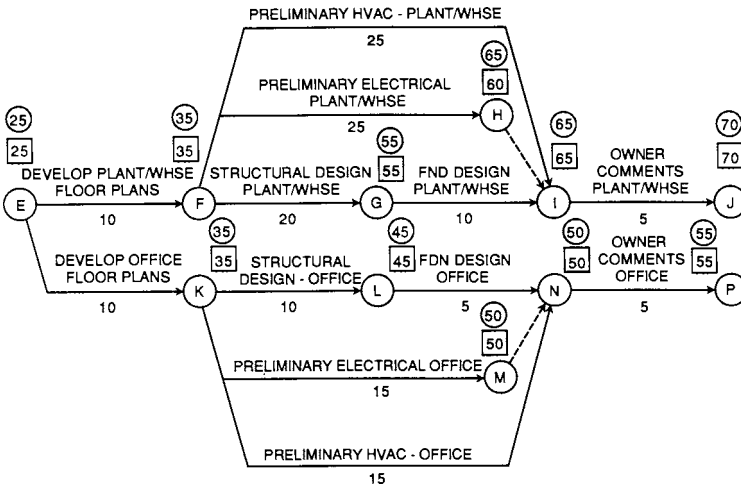

Figure 21.2.7 John Doe preliminary design.

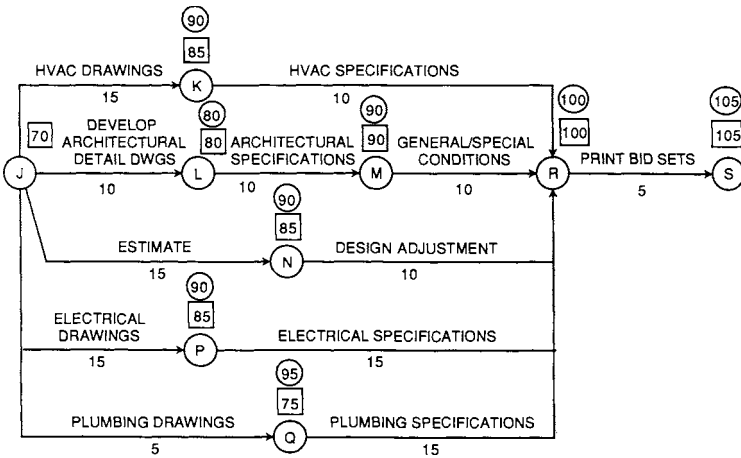

Figure 21.2.8 Contract documents: plant & warehouse.

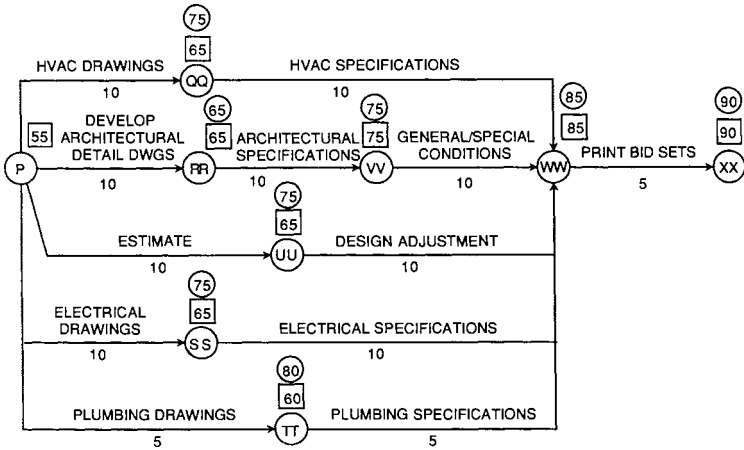

Figure 21.2.9 Contract documents: office.

summary level CPM that shows the entire preconstruction plan for the design of the John Doe project.

Figure 21.2.11 shows a network representing the design stages of a city school project. In this case, the project is located within city limits, so that the usual agency reviews are required. Note the “rejection cycle,” which is a loop and cannot be computerized. It is in shorthand to indicate that the full schematic design cycle sequence is represented (presumably with shorter durations). Because projects such as John Doe are placed in industrial parks, fewer reviews are required, and any reviews are generally required by the state more often than by a township or county. However, the site development of an industrial park is not inexpensive and should itself be planned as illustrated in Figure 21.2.12.

During the design stage, there is a continual interplay between the designer and the owner. The owner reviews the design at major points in development and should be available daily for information. Quite often, the owner is furnishing or specifying special equipment that requires his or her attention. Both architect and owner are involved in various agency or company reviews.

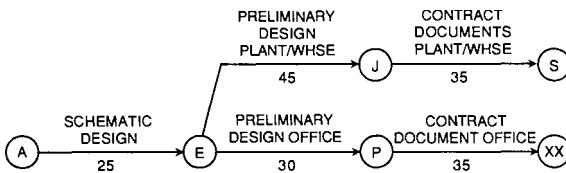

Figure 21.2.10 Summary level CPM for John Doe project.

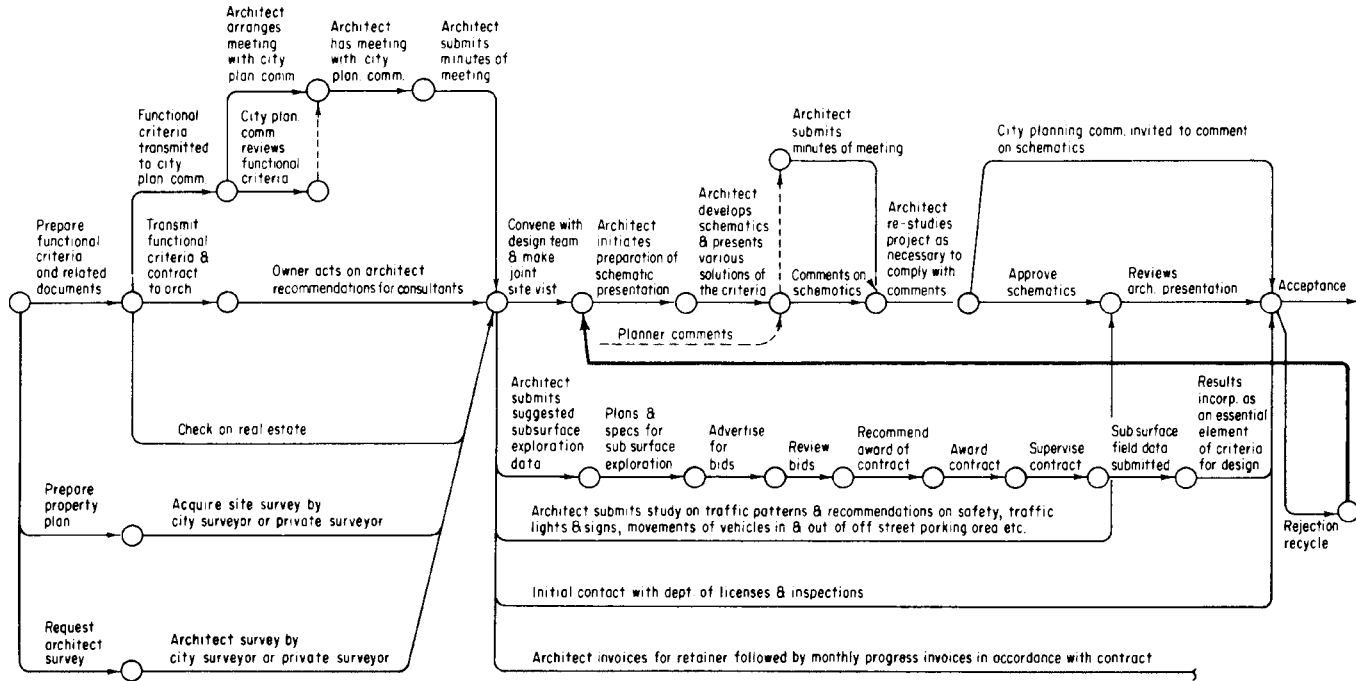

Figure 21.2.11 Network for city school design phase.



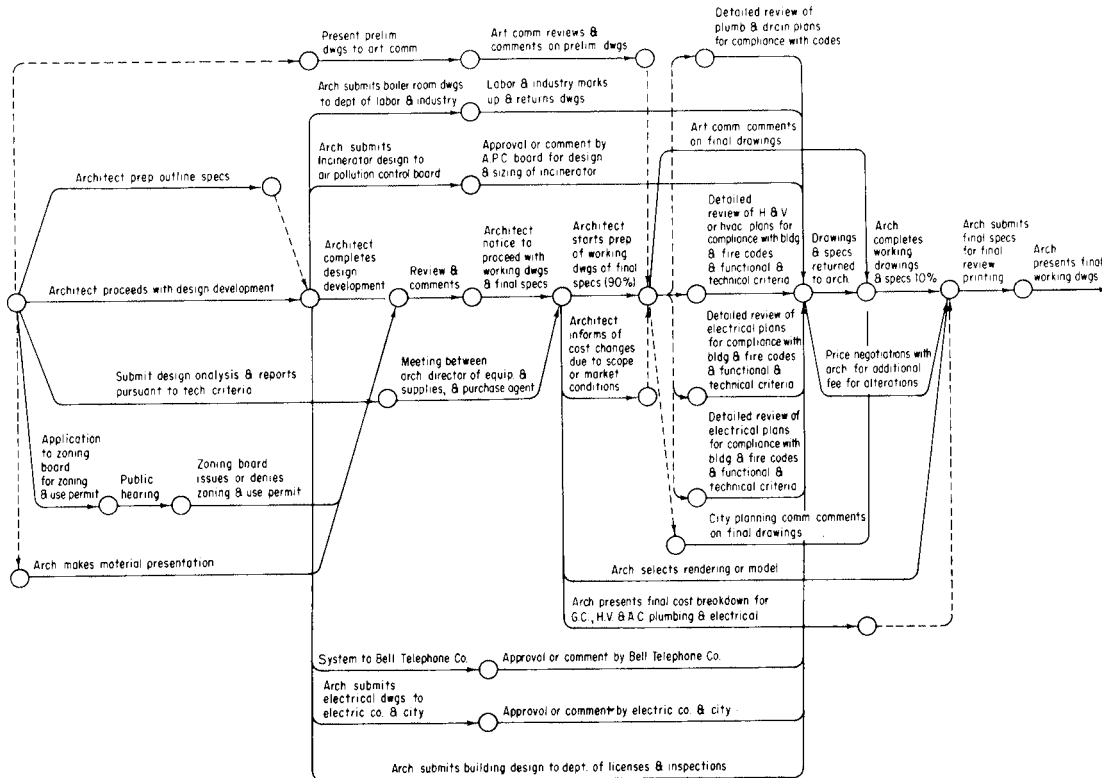

Figure 21.2.11 (Continued).

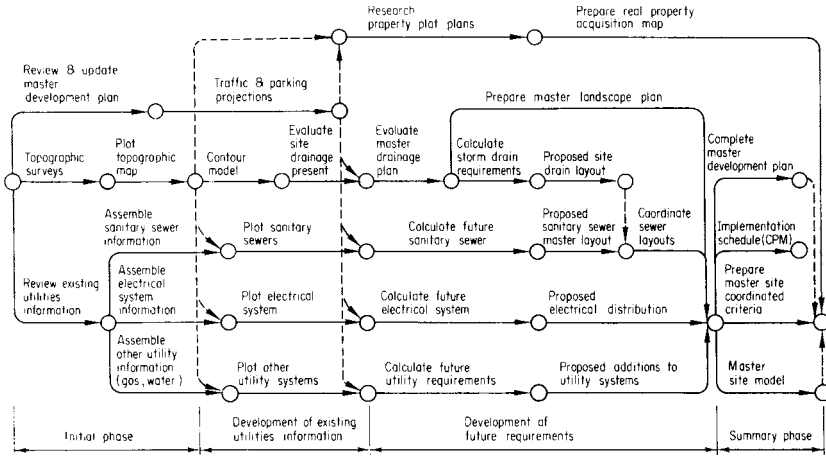

Figure 21.2.12 CPM plan for site development.

The design phase offers a tremendous potential for time gains or losses. When an owner is handling many projects concurrently, it is good practice to use resource allocation for design and management staff so that project progress of all projects is calculated and structured rather than left to chance.

Just as the designer typically exercises patience until external pressures force a decision from the owner, the owner, assuming that the designer can work around problems without losing substantial time, typically delays decisions.

With so many people concerned about and responsible for a project, substantial periods of time are usually spent in review and administrative planning. Often, these activities are overlapped as each individual tends to see his or her own part in the project as the most important and, therefore, is willing to take more than their fair share of project time in arriving at an important decision or confirmation. Also, in the early planning stages, people generally do not regard the planning time they use as really affecting the final delivery date because it seems so far away.

In reviewing one Department of Labor administrative project, a network was established that resulted in the review cycles being reduced and a better chain of responsible personnel established. However, one startling fact that emerged was the physical handling of the documents that required review. It was found that the internal mailing system was so slow that it took up 20% of the preconstruction phase of the project. Because of the importance of the project, this was changed and all documents hand-carried to and from project personnel.

### 21.3. Summary

To achieve the real benefits of logic and control through network analysis, project management should be instituted as early as practicable, preferably about the time a project is identified in a budget. Installation and implementation of CPM in the actual construction phase is of great importance, but many opportunities to save time and money will be missed if this control is instituted too late.

*This page intentionally left blank*

## Evolution of the Project Schedule

CPM separates planning and scheduling, and once project information is collected and expressed as a network plan and activity time estimates assigned, CPM calculations can be made. Planning ceases and scheduling starts when the first computation is performed that shows a project duration. The project duration is then compared with the desired schedule and scheduling begins. The first comparison is for end date.

### 22.1. Preliminary Schedule

The owner sets the schedule using the advice from the designer and other confidants, but generally undertakes establishing the schedule personally. The typical schedule is usually a tight one—intentionally and unintentionally—and reflects the requirements that the project fulfill for the owner. (Often by the time the design is completed, much of the time originally available has been used in the preconstruction stages.) The accidentally short construction schedule occurs when the owner is not knowledgeable of, or realistic about, the time necessary to construct the project at hand.

Completion of a construction project is not only key to the owner but to the contractor as well. The contractor must have some definite opinion about the overall length of the project in order to make a meaningful bid on it. Inevitably there are additional costs, such as increased wages and basic overhead, that are tied to the length of the job rather than to the specific level of field activity the job entails. Although some of the contractor's overhead can be spread throughout the job, some contingent amount must be included in the bid to cover possible risk or exposure to an extended contract.

## 22.2. Preconstruction Analysis

An owner who includes only a completion date in the contract has very little control of the progress of the job. To establish a more feasible schedule, many owners are using a preconstruction evaluation completed by their staff, consultants, or the construction manager, if one has already been assigned, to use as the basis of evaluating their schedule. A preconstruction study by knowledgeable staff can inform the owner that a reasonable contractor under normal circumstances cannot meet their date. The owner will then have a number of alternatives.

One alternative is to identify the contract time as a tight one and program overtime into the project on a preset basis, such as 6 or 7 days a week. Another option is to require that the contractor work double shifts, although this can result in severe budget ramifications. Also, such an approach must be evaluated in terms of area work practice. Some labor unions require full premium for double shifts, whereas others impose only a nominal increase. Some unions will not work on an accelerated basis, regardless of salary premium. Another alternative is for the preconstruction schedule study team to establish a phased, projected series of dates at which parts of the project can be taken over by the owner. Often, this option meets the owner's true requirements: The phasing is made part of the contract, and no additional cost is programmed into the project.

When a preconstruction evaluation has been made, the owner has two basic approaches. First, he can state that the study validates the required completion dates and include a contractual that stipulates damages are based on reality and will be imposed. Second, the owner can furnish the preconstruction evaluation to all of the bidders. In the first instance, the scheduling information provided to the contractor is only a narrative statement. The owner does not include the results of the study as part of the contract documents.

The recommended approach is to include a summary network and/or computer run of the network for the bidding contractors to use. This section can be marked "Information only," but it gives the contractors a rapid method of evaluating one way in which the project can be accomplished. When more detailed scheduling information is offered, it should also be conditioned in this way. Including a network does not mean that the contractor must perform the project in a specific manner. Instead, it suggests one way to do it. The owner is, after all, attempting to buy the contractors' innovative thinking as one of his basic skills.

## 22.3. Contractor Preconstruction Analysis

In most cases, bidding contractors do not make a serious evaluation of the contractual time requirements unless the requirements are unusually and obviously stringent. Twenty years ago, liquidated damages assigned by engineers were usually a slap on the wrist of \$100 per day. (Compare

this with the hospital that had a \$200,000 per month, or \$6,700 per calendar day, time damage.) Even today, liquidated damages are generally set fairly low.

A contractor who responds to a bid by including a condition is definitely found to be nonresponsive by public agencies and may be found nonresponsive by private organizations. The contractor whose bid questions or conditions the time frame of a contract is usually rejected. Therefore, most contractors will not do so, but they may state their reservations about the projected dates after the award of the contract.

Experienced contractors know that there will be unforeseen conditions and unexpected situations for which time extensions will be allowed. Contractors also expect changes by owners and anticipate that either the owners will relax end dates or, if need be, they will successfully handle any delay claims by the owners. Further, liquidated damages have traditionally been set too low by owners who are unaware that their claims for damages are usually limited to the liquidated damages specified.

#### 22.4. Milestones

A preconstruction schedule can be used to develop something more than an end date. A network evaluation can identify key milestones. The analysis tells the owner that if certain things do not occur by certain stages of the project, there is no way in which the end date can be met. Therefore, the section in the contract on scheduling can establish the milestones as specific days following the notice to proceed.

Normally, the only scheduling requirement included in a contract is the end date by which the contractor agrees to complete the project. Although general language is usually included that stipulates the contractor must remain on schedule, when contractors run behind, they can always allege that they are going to increase the workforce, work overtime when required, or bring more subcontractors onto the project. There are usually no definite means of establishing that they have failed to meet their contractual obligations.

Establishing *milestones* as a contractual requirement helps the owner to control the project's progress, and it provides a definite area to control the performance of the contractor. The contract language should, however, be flexible enough to permit the owner to adjust milestone dates if a contractor requests it and can demonstrate a realistic means of readjusting the schedule. Requests such as this should be in writing and require the signature of the owner.

Typical milestones include the completion of foundations, structures, close-ins and watertightness of structures, start of temporary heat, complete basic air handling system, complete permanent heat, and complete lighting systems. Milestone dates can also be established by area. Thus, in a hospital, certain areas could be designated for acceptance by

the owner in stages. Typical initial areas are the ambulatory care and staff administrative spaces. If the owner intends to take phased occupancy, the decision should be made early in the design stage so the layout of the facility will reflect the incremental occupancy intended. Also, the mechanical and electrical systems may require controls by local area.

### 22.5. The John Doe Schedule

Figure 22.5.1 shows, on a summary level, a basic 429 workday schedule suggested by the John Doe networks. If the end date of the initial plan is later than the desired date, the first area to examine is the critical path.

There are two distinct methods for shortening the critical path. First, examine the path for series sequences that could be parallel. For instance, in the John Doe project, the critical path could be shortened by 74 days if the company were able to revise its ground rule about doing the office building after the warehouse. If that is not possible, other possible areas of overlap should be studied:

1. In the foundation contract, perform the pile caps (16–17) and grade beams (17–18) in parallel rather than in series. Time savings, 5 days.
2. In the foundation contract, perform the underslab plumbing (19–20) and conduit (20–22) in parallel rather than in series. Time savings, 5 days.
3. Perform the floor slabs (22–29) in parallel with the structural steel and craneway erection (29–33). This would be possible by working from opposite ends of the building. Time savings, 10 days.
4. Start siding erection earlier, at event 33 instead of 35. Time savings, 5 days.

If all of these changes were implemented, it would result in a total time savings of 25 days. The plant-warehouse area does not offer much opportunity for time savings because several paths would have to be shortened. As noted in Chapter 20, Procurement, 18 days can be saved by prepurchasing the well pump and water tank.

If the time reduction of 43 days is not sufficient, re-examine the critical activities with longer durations. Perhaps by adding equipment and

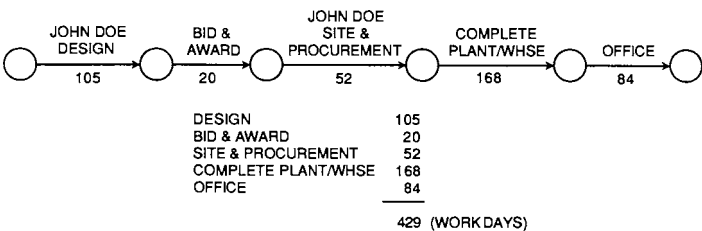

Figure 22.5.1 John Doe schedule without expediting summary level.



increasing the workforce, the time for some of the critical activities could be shortened. For instance:

- 15–16 Shorten “excavation” from 5 to 3 days.
- 16–17 Shorten “pour pile caps” from 5 to 3 days.
- 17–18 Shorten “grade beams” from 10 to 5 days.

And so on. Take care not to arbitrarily shorten durations. An unfortunate tendency is to be optimistic when estimating the project time required for an activity. Some people fall into the trap of using the best time they have ever experienced. Further, it is easy to overlook the time inevitably lost in coordinating many activities. Experienced estimators include this factor in their estimates.

### 22.6. Resources

The CPM calculation assumes unlimited resources, that is, enough people and equipment available to do each activity. This is fairly reasonable and can usually be maintained for critical activities. However, the superintendent must use float time as a guide in spreading out crew assignments. Although it is theoretically possible to call workers out one day and lay them off the next, no sensible contractor wants this reputation with craftsmen or small subcontractors.

To set up the CPM schedule to take this situation into account, crew scheduling arrows can be added. In Figure 22.6.1, which shows the John Doe project site work, note the access road and parking lot. If they are to

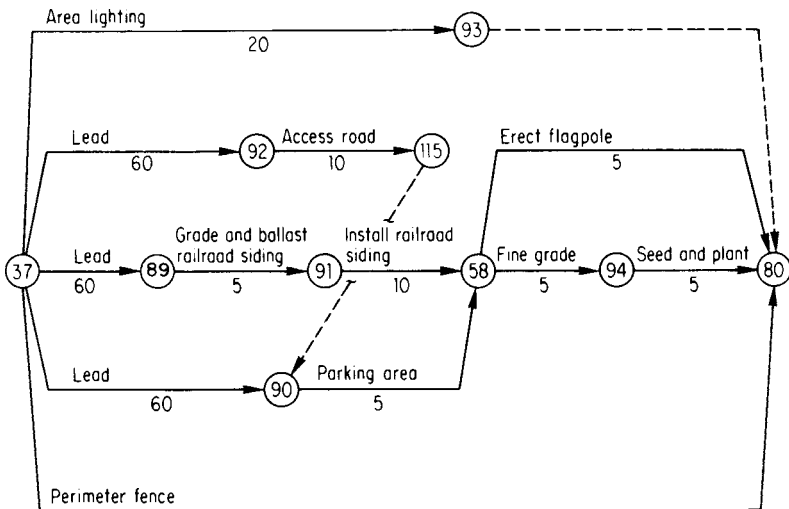

Figure 22.6.1 Lead and sequence arrows; site work.

be done by the same contractor, it would be reasonable to schedule them in series rather than in parallel. This can be done by changing activities 92–58 to 92–115 and then adding one sequencing arrow 115–90. That schedules the access road before the parking lot and allows the same paving equipment to be used on both activities. It also reduces total float by five days.

Other examples can be seen in the John Doe project foundation work (Fig. 22.6.2). For instance, the general contractor has to call in the plumber and the electrician for underslab work. One reasonable method is to schedule the critical work first. To do this, a CPM computation must be made before the schedule sequence arrows are added. In the network, the plant-warehouse work is critical, so the addition of sequence arrow 20–26 will schedule the office building underslab plumbing after the critical plant-warehouse underslab plumbing. This will reduce the float in path 26–27–28–29 from 30 to 6 days.

To sequence the conduit work, do not add arrow 22–27, because this will make an illogical sequence. It will make the concrete work in the two loading docks precedent to the office underslab conduit, 27–28. Add a logic spreader to separate event 22 into two events. For instance, 22–116, where 116 is the completion of the loading docks and precedes the slab pour and 22–27 will then provide a proper crew sequence.

A useful technique in sequencing crews is to bar graph the CPM output by trade or specialty, such as plastering, painting, or concrete. This could be quite a task if you were to attempt to bar graph the entire CPM output, but it is not unreasonable to do it by hand selecting only key categories. The bar graphs can also be generated by computer. Using the bar graph “family” for a category, the best sequencing can be determined; then the schedule arrows necessary to set the sequence added to the network.

Schedule arrows can be very effective in changing CPM from a pure plan into a workable schedule, but a strong note of caution. Schedule arrows are pseudo rather than true logic and are more likely to go awry

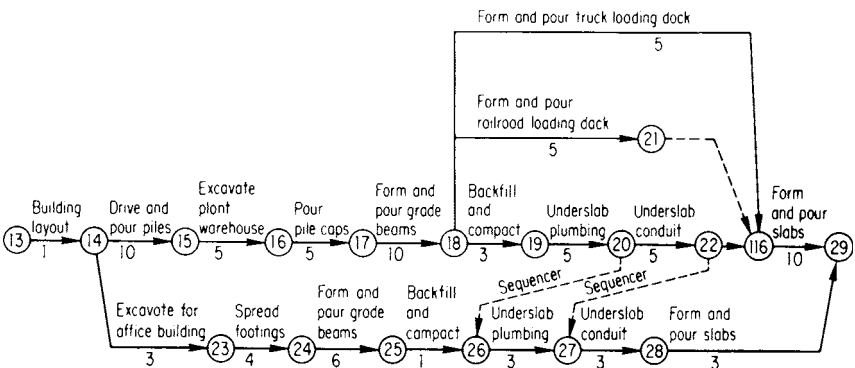

Figure 22.6.2 Work sequence arrows; foundation contract.

as the project progresses. This can produce some very illogical results, which the field group is usually the first to note. The bad impact on field workers is difficult to erase. The use of schedule arrows is recommended, but with discretion.

### 22.7. Fast Track

From the standard John Doe networks, the minimum time from start of design to close-in is:

Design	105 workdays
Bid/award	20
Site and procurement	52
Foundations	54
Close-in	<u>36</u>
	267

Using a compressed fast track (Figure 22.7.1), close-in milestone can be reached in:

Start design	35 workdays
Structural design	20
Bid/award steel	20
Fab/deliver steel	90
Close-in stage	<u>36</u>
	201

This is a time savings of 66 days, or 15% of total. If the owner can reconsider the delay in starting the office building, the time savings with fast track will be:

Total time	429 workdays
Less fast track	(66)
Less parallel office building	<u>(78)</u>
Net time	285, or 33 percent reduction

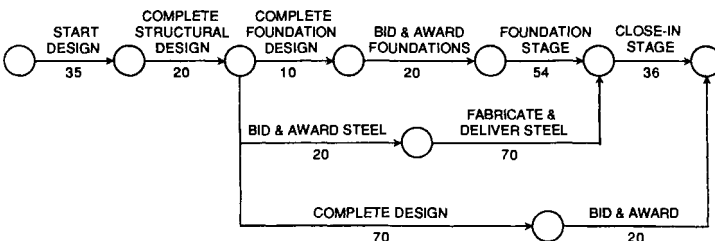

Figure 22.7.1 Fast-track network.

## **22.8. Responsibility**

Construction scheduling is usually the responsibility of the contractor and the concern of the owner. When there is a single construction contract, the contractor is the key to all scheduling problems and solutions. In certain cases, the owner is either required to or chooses to undertake contracts with several prime contractors. In this case, the owner becomes the coordinating contractor.

Although it would appear obvious that the owner must take positive management control steps, that usually just does not happen. In most situations, the owner hopes for the best and, except in the very worst cases, the individual contractors usually accept the poor level of coordination even though they might have legal grounds for action because of delays caused by other prime contractors. Owners who recognize their responsibilities often retain either project managers and/or construction managers to carry those responsibilities out.

Usually, the contractor does not preplan or schedule a project when bidding on it. The reason is economy, since contractors can expect to win only between 10 and 20 percent of the jobs they bid on and the money spent on planning jobs not acquired is wasted. This reality points to a very significant advantage in using the construction manager (CM) approach. The CM can apply preplanning using a preconstruction working plan to identify problems and set an environment of thoughtfulness in regard to the construction schedule. The owner, or CM, can also use the same preconstruction study to establish a reasonable schedule or to develop special construction phasing or work-arounds. Each costs more, and the owner should expect to pay more for the service. Of course, the final working plan and schedule are developed after the successful contractor has been determined.

Often, completion of the contract provisions is assumed to be completion of the project, but the turnover of the facility from the contractor to the owner often includes a punch list of items remaining to be finished. The items may be trivial or they may involve substantial additional labor. The relationship between the owner and the contractor at the conclusion of a project can be directly influenced by the number of and difficulty of completing the items on the punch list.

## **22.9. Schedule versus Calendar**

After a suitable end date has been realized by adjusting the network, look at the practicality of the dates computed. For instance, in the John Doe networks, all foundation work is to be finished in late fall. This is reasonable, and it allows a little room for the unexpected. In an actual high-rise project, however, the plumbing tests were predicted for November. They were delayed for a few weeks, and the hard-freeze period set in. What should have been a one-week test took six weeks to accomplish.

So look at the dates computed and compare the activity with the weather you might expect at that time of year. This is an area in which you are much better equipped than the computer.

What if you find that the concrete, earthwork, and so on are going to occur at an unfavorable time of year? First, face up to the fact that a winter job will cost more or try to delay the project until spring. If your end date is acceptable, set up your schedule on this basis. If you cannot afford the delay, consider applying overtime, extra crews, and so on at the start of the project to complete as much as possible before the onset of bad weather.

What do you do about work that must necessarily be done during a period of bad weather? The question was perhaps best answered by a Pennsylvania Dutch concrete superintendent when asked what he would do if it rained during a big slab pour: "I'd just let it rain." If you must work through seasonal bad weather, add project time to account for lower working efficiency. The factor will vary from Canada southward, of course.

You do not have to alter each time estimate to account for the weather factor. This would obscure the facts. A practical method is to use weather arrows. Assume, for instance, that the portion of the John Doe project network between events 29 and 37 is to be accomplished in January and February. The total durations for the sequence of work is 36 days. In the middle Atlantic states, we could assume an efficiency of 60 percent; 3 days work accomplished in each 5 project days. To introduce this factor into the network, add an activity "weather factor" (29–37) with a duration of 60 days. In Montana, the efficiency factor might drop to 40 percent; in Alaska, it might be even lower; in Texas, the schedule could be almost normal.

The Texas Department of Highways and Pennsylvania Department of Transportation (PennDOT) have published their own schedules of productive days anticipated per month for highway construction subject to weather influences. The PennDOT schedule is shown in Table 22.9.1.

**TABLE 22.9.1 PennDOT Anticipated Workdays Per Month**

Month	Workdays	Cumulative Workdays	Conversion Factor, Workdays to Calendar Days	Cumulative Calendar Days
Jan.	2	2	15.50	31
Feb.	2	4	14.00	59
Mar.	7	11	4.429	90
Apr.	12	23	2.500	120
May	18	41	1.722	151
June	18	59	1.667	181
July	18	77	1.722	212
Aug.	18	95	1.722	243
Sept.	18	113	1.667	273
Oct.	15	128	2.067	304
Nov.	5	133	6.00	334
Dec.	2	135	15.50	365

## 22.10. Contingency

Achievement of the end date desired is not necessarily an acceptable schedule. CPM is not a crystal ball. Even though the activity and time estimates used in the network are based on experience, a project rarely finishes ahead of its computed end date. Poor weather, difficult site conditions, labor disputes, change orders, and so on, are unavoidable and unpredictable. There is a definite tendency for the actual completion date to exceed the first CPM end date. It is, then, reasonable to allow for some contingency between the CPM end and the actual desired completion dates.

There is no definite answer on how much contingency to allow for, because it will vary with the specific circumstances of the project. However, if you need a 12-month period for completion of the project, set your CPM goal at about 11 months, and so forth. Some people have been reluctant to set a flat contingency at the end of the schedule. Contingency can be buried in the activity estimates, but if it is, you will not be able to separate true estimates from contingency.

Another approach is setting contingency based on anticipated site conditions or any predictable problems that can be projected with some reasonableness. Then, in a fashion similar to the weather arrow, a specific contingency can be identified and assigned only to that area it impacts. For instance, the availability of space to shake out structural steel will impact the time frame in which the structural steel is erected; difficult site access is solved after construction roads are in place; and storage of equipment and materials becomes less of a problem when foundations are ready and the equipment and materials can be set in place.

A more mathematical approach to this issue is to look at the consequences of merge bias upon the amount of contingency required. Assume that each “Most Likely” duration given is an estimate somewhere between a “best case” or Optimistic duration and “worst case” or Pessimistic duration. We would expect that the “worst case” estimates are further from the “Most Likely” than the “best case” estimates. Let us assume only a slight skewing of this nature, such as the “best case” is 15 percent better than the “Most Likely,” but the “worst case” duration is 20 percent greater than the “Most Likely.”

Now consider the John Doe project. If a subset of activities are extracted such that there is only one linear chain of activities forming the network, and the durations are randomized to between 15 percent less than estimated to 20 percent more than estimated, it would be expected that this skewing to the high side would tend to make the project take longer than the simple CPM calculation (Figure 22.10.1).

And in fact, due simply to this skewing between “best case” and “worst case,” there is only a 14 percent chance of completion by the 21DEC04 date calculated by the CPM algorithm. Similarly, there is only



Now consider only a slightly more complex logic network. When there are multiple paths to a network, there is the statistical chance that the critical path durations may all be lower than anticipated, but that the durations of a near-critical path may be higher than anticipated. In such a case, what was the near-critical path may become critical and extend the total project duration, notwithstanding the reductions of the original critical path. The project just cannot win—if the durations of the critical path are higher than anticipated, the project takes longer—and if they are shorter than anticipated, another path may yet make the project take longer. This bias toward the project as always taking longer whenever two or more logic paths merge is known as the merge bias. The greater the number of near-critical paths that merge, the greater the bias.

For the John Doe Project, there is a 66 percent chance that the critical path will be 0–100–1–2–3–8–13–14 . . . , a 33 percent chance that the critical path will be 0–100–1–2–3–401–6–7–8–13–14 . . . , and a 1 percent chance that the critical path will be 0–100–1–2–3–402–9–11–12–13–14 . . . . (Figure 22.10.3). In this instance, the chances of completion on time due to the merge bias are reduced from 14 percent to 11 percent, the 50 percent chance of completion is extended to 23DEC04 and the 95 percent chance of completion is extended to 08JAN05. The 99 percent chance of completion remains at 12JAN05, although not all logic networks are as forgiving (Figure 22.10.4). In general, the more complex the logic network and the greater the number

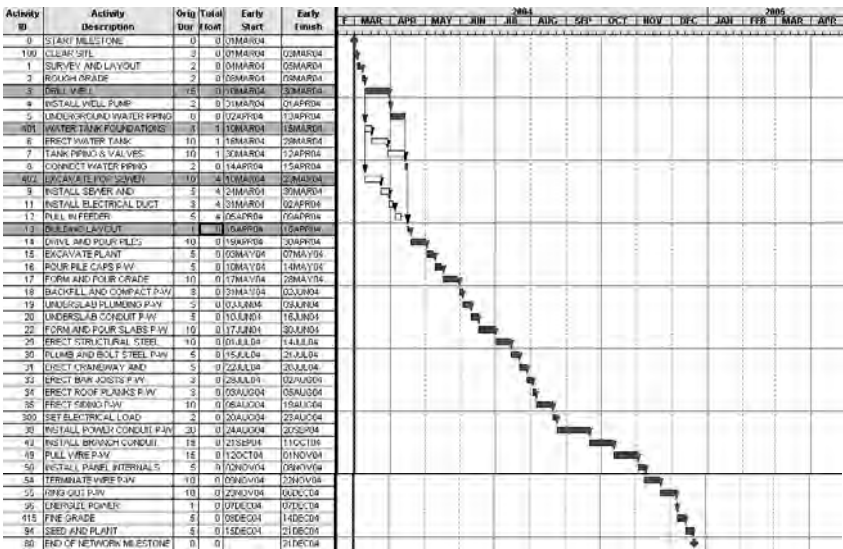

Figure 22.10.3 Alternate Critical Paths for a project without long duration procurement activities.



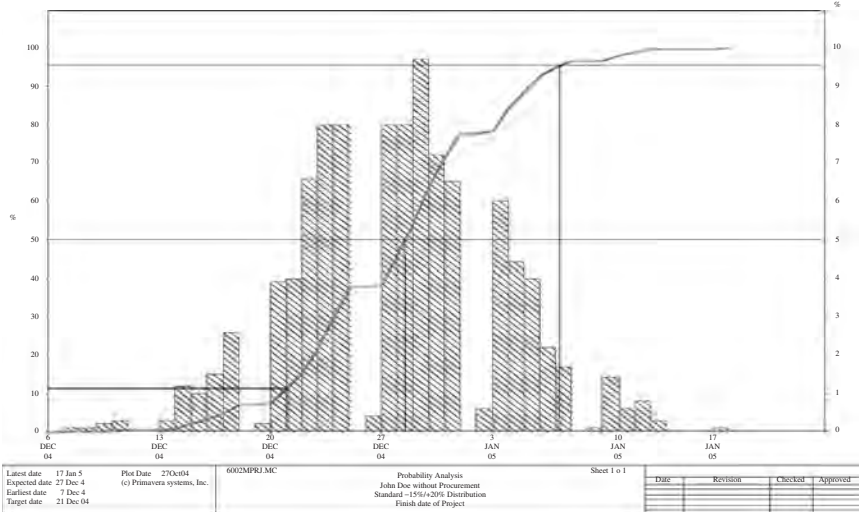

Figure 22.10.4 Probability for a project without long duration procurement activities.

of near-critical paths, the greater the chance that a merge bias will cause an overrun.

If long lead procurement items are also included in the base network, the chance of late completion becomes even greater. The long lead item “fabricate and deliver packaged air conditioners,” of 90 days’ duration, should be a source of real concern in a real world situation. Here too, when the default bracket of durations of -15 percent to +20 percent is applied, the calculated total float of only 8 days is quickly consumed, creating a potentially overriding new critical path. The likelihood of this occurring in our model (17 percent) matches that of the real world, reducing the chance of timely completion to only 2 percent, with only a 50 percent chance of completion by 07JAN05 and only a 95 percent chance of completion by 25JAN05, more than a month after the calculated completion date for this nominally 10-month project (Figure 22.10.5 through Figure 22.10.7).

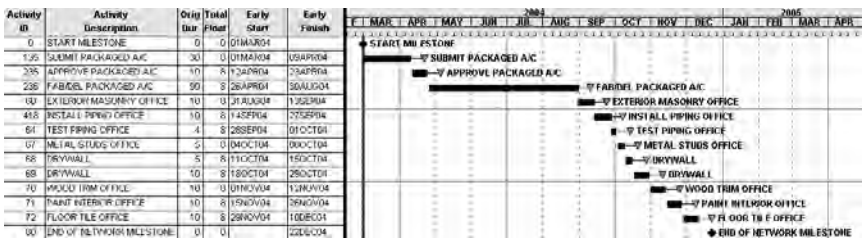

Figure 22.10.5 Alternate Critical Path for a project with long duration procurement activities.

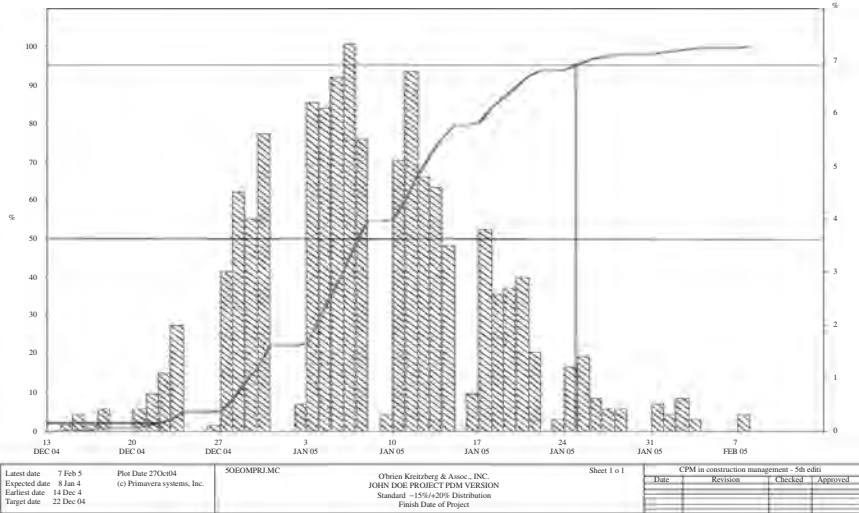

Figure 22.10.6 Probability for a project with long duration procurement activities.

The general rule here is that activities having longer (and thus less detailed) durations are more likely to have serious overruns (as 20 percent of 50 days is larger than 20 percent of 10 days) and are more likely to have their float consumed and become an alternate critical path and extend the completion date of the project. If it is important to complete the project by a specific date, some level of contingency must be allowed at the end. The amount of contingency required will vary from network to network and can

Activity status:		* Completed		+ Underway					
Activity	Description	PCT CRIT	Precursor Activities	Description	REL Type	PCT CRIT	Relative Free Float		
0	Start milestone	100	None						
135	Submit packaged A/C	17	0	Start milestone	FS 0.0	100	0.0		
235	Approve packaged A/C	17	135	Submit packaged A/C	FS 0.0	17	0.0		
236	Fab/Del Packaged A/C	17	235	Approve packaged A/C	FS 0.0	17	0.0		
60	Exterior masonry office	17	59	Erect Precast Roof Office	FS 0.0	0	30.3		
418	Install piping Office	9	236	Fab/Del packaged A/C	FS 0.0	17	0.0		
64	Test piping office	9	60	Exterior masonry office	FS 0.0	17	0.0		
67	Metal studs office	17	418	Install piping office	FS 0.0	9	0.0		
68	Drywall	17	64	Test piping office	FS 0.0	9	0.6		
69	Drywall	17	65	Install conduit office	FS 0.0	9	0.6		
70	Wood trim office	17	67	Exterior doors office	FS 0.0	0	14.8		
71	Paint interior office	17	68	Metal studs office	FS 0.0	17	0.0		
72	Floor tile office	10	420	Glaze office	FS 0.0	0	14.8		
80	End of network milestone	100	69	Drywall	FS 0.0	17	0.0		
			70	Drywall	FS 0.0	17	0.0		
			71	Wood trim office	FS 0.0	17	0.0		
			72	Paint interior office	FS 0.0	17	0.0		
			37	Perimeter fence	FS 0.0	0	84.8		
			58	Erect flagpole	FS 0.0	0	6.0		
			63	Paint exterior office	FS 0.0	0	68.8		
			72	floor tile office	FS 0.0	10	11.5		
			73	Toilet fixtures office	FS 0.0	0	18.6		
			78	Acoustic tiles office	FS 0.0	8	13.5		
			79	Ring-out	FS 0.0	0	34.2		

Figure 22.10.7 Probability of this Alternate Critical Path.

be calculated by SPERT style software. However, for construction projects a general rule of thumb still calls for 1 month for a 12-month project, “and so forth.”

### 22.11. Schedule Manipulation

Contractors can use the conversion of the basic plan into a schedule as an opportunity to manipulate the schedule in their favor. In one major hospital project, the contractor submitted a network plan for a 4-year project that showed a very easy and extended schedule for foundations and structure spanning more than 50 percent of the 4-year time frame available. All the mechanical, electrical, and finish work was crowded into less than half the time allotted for the project. To the scheduling reviewer, it was clear that the contractor intended to set up a schedule that would be easy to meet during the front end, thus keeping the project management team off his back, while claiming that the final portions of the very complex project could be achieved in record time. The construction manager had imposed an extensive CPM specification, which unfortunately failed to establish interim milestones. The lack of milestones allowed this contractor’s hybrid approach (i.e., slow start, fast finish) to meet the letter, even when clearly not meeting the spirit of the specification.

Because it is important to have a baseline as-planned schedule, the CPM consultant recommended accepting the schedule while pointing out its obvious weaknesses to the contractor. Further, it was clearly noted that if the contractor did not perform more quickly than his schedule called for during the first 2 years, there was no practical probability that he would complete the project on time.

Manipulating a schedule can be a two-edged sword, as it was in this case. The contractor did have delays during the early portion of the project, but his schedule did not support any delay due to changes caused by unforeseen conditions. Accordingly, he was properly denied time extensions that he might otherwise have been allowed.

In the same project, the contractor also attempted to have the network defined as 100 percent critical. Given enough time and effort, he doubtless could have succeeded, but what he ended up with was a network showing approximately 80 percent of the activities as critical. This is clearly incorrect from a logical viewpoint. In accepting the network as an as-planned baseline, the construction manager pointed out that it appeared to be resource-balanced and that it violated the industry definition of “critical.” Therefore, the network would not be an appropriate basis for determining activities in which delays could readily be overcome by doubling relatively small work crews in special craft areas.

In effect, the contractor had submitted a plan in which he hoped would identify every activity as critical, and so managed to avoid defining the

truly critical activities of the project. Thus, he lost a valuable tool for evaluating delays and assigning responsibility.

Another type of manipulation that is becoming more frequent is the short schedule, where the contractor submits a project plan that involves substantially less time than the scheduled time required by the owner. The shortfall is usually substantial, often as much as a year in a three-to four-year project. The contractor asserts that the bid for the job was on the basis of the short schedule and that any failure on the part of the owner to completely support the short schedule will itself be a proper basis for delay claims.

In reviewing a short schedule, the owner should be certain that sufficient time is allowed for shop drawing approval and other managerial reviews required by the specifications. Also, it is appropriate to question the considerations for weather and any unusual conditions included in the plan. In a multiple prime project, the schedule should be reviewed to be certain that primes other than the general contractor have sufficient working time and that, in a general construction contract, that the major subcontractors have sufficient time to complete their work. The contractor submitting the short schedule should be required to certify that the other major primes or major subcontractors have reviewed and agreed to the plan.

If the contractor submitting the short schedule persists in claiming it is long enough, one suggested approach has been to issue a change order at no cost and, thereby, change the end date for completion to agree with the short schedule. However, if the owner believes that is an unrealistically short date, calling the contractor's bluff may have built-in legal problems.

Short schedules can also be addressed directly in the scheduling specification. The specification can state that any schedule that is substantially shorter than that required (i.e., 10% or more) will be considered unrealistic. It could also state that a foreshortened period will be considered a scheduling contingency and that the owner will make his best effort to support the short schedule without foregoing any prerogatives, such as the mandated time for review of shop drawings or the right to review only priority shop drawings.

## **22.12. Working Schedule**

After the adjustments discussed previously, the CPM schedule is established. But is it really a schedule? The critical activities have definite start and completion dates, but what about the activities with float? For activities having a float of 10 days or less, the CPM dates are fairly definite, but it is not reasonable to consider an activity with 100 days float as scheduled.

A number of attempts to make the CPM schedule more definitive have been instituted. One method is a computer routine that allocates the total float to each activity, which can be done by either a flat allocation per activity or an allocation proportioned to the activities' durations. Although there is nothing particularly wrong with this routine, there is also nothing particularly useful either. Because the float allocation is arbitrary, it only clouds the network information. Also, there is no judgment factor in machine-handled allocation of float. Obviously, some activities should receive a larger proportion of float than others (if the method of float allocation is to be used). Contractors usually prefer to retain all the actual float unallocated and try to work as close to early start dates as practical.

The character of the network affects its tightness. The John Doe network would be described as very tight. Tightness, or lack of large float values, is the result of the network tying back into strong events or nodes, which results in a definitive schedule and is desirable. But do not force it. Don't introduce fake logic to achieve a definitive schedule, because the results will be a fake schedule.

It is entirely reasonable to introduce lead or lag arrows into float paths to schedule certain items. For instance, three activities in the John Doe site work that could start in early January are 37–91, grade and ballast railroad siding; 37–90, pave parking area; and 37–92, access road. Although those three items could logically commence at event 37, none should be scheduled in January in the northern part of the country. Because each activity has more than 12 weeks float (37–90 has 73 days; 37–91 has 63 days; and 37–92 has 68 days), the 3 could obviously be scheduled for a more suitable time of year by introducing a lead arrow in front of each activity, as shown in Figure 22.6.1.

The lead arrow is essentially a restraint with time added. If 12 weeks duration is assigned to each lead arrow, the 3 activities will have early start times in late March. (In many programs, an activity can be assigned a "not earlier than" date to restrain the start. Similarly, activities can be assigned "not later than" dates or an activity start can be locked in place.)

Fine grading and seeding could start as early as mid-April or as late as mid-August. A choice should be made whether to use a spring or fall seeding. Because a fall planting would follow the completion date, assume a spring planting. To do that, use a lag arrow after the seeding. This does not affect the early start date for seeding, but it does bring the late start date to an earlier time.

If all of the available float time is assigned to either a lead or a lag arrow, the activities in that chain become critical. On some occasions, it is useful to force certain paths to become critical. In a high-rise building project, for instance, concrete work was no longer critical because it

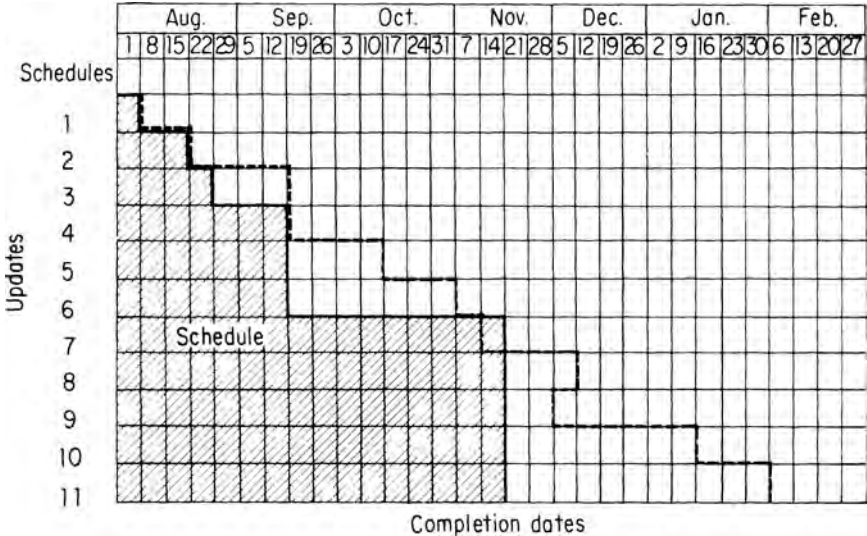

Figure 22.12.1 Schedule slippage over 11 updates. Latest date to stay on schedule: project date.

had been expedited and, thus, another path had become critical. Although concrete work was no longer critical for the overall project completion, it was still critical in regard to the schedule. The roof pour was scheduled for late November, and the completion was a race against temperature. The concrete crew won. By completing the last slab before winter protection was needed, many thousands of dollars were saved. This was more than enough to pay for the overtime required to maintain a fast schedule.

Under pressure by the owner, a scheduling consultant manipulated the schedule of the contractor working on a large water pollution control plant by applying the various methods necessary to shorten the schedule projections so that the end date projections would meet (or appear to meet) the needs of the project. Figure 22.12.1 shows a series of 11 updates for the project, over which time a key milestone date actually slipped 6 months but appeared to slip only 2.5 months because of schedule manipulation. At the time, the “schedule embezzlement” was performed with the best of intentions. It was also recorded in the narrative reports provided with the monthly schedule updates. However, the shortening and paralleling of activities were accomplished independently by the scheduling consultant and, therefore, were not truly part of the contractor’s plan.

Experience has taught a clear lesson that the approved schedule plan should be changed only with the permission of the project manager and should be documented in the narrative update at the time the change

is made. Further, the basis for the change or changes should be clearly and rationally explained (e.g., additional equipment brought in, additional crews added, or other logical reasons).

### **22.13. Summary**

The first CPM computation is a plan, not a schedule. After adjusting the project completion date by changing sequences and time estimates, an end date is determined. The date should precede the desired completion with a suitable contingency. The intermediate dates should be reviewed with the realities of seasonal weather. Seasonal factors can be accounted for if necessary. The schedule at this point can still be rather loose.

Lead and lag arrows can adjust float to position activities within the range of their CPM dates. Schedule sequence arrows can be used to provide a schedule using fewer crews. Scheduling arrows can add to the effectiveness of the CPM results, but one error in their use can far outweigh their benefits.

The owner sets the overall schedule dates, often on the basis of uninformed intuition. Preconstruction schedule analysis by a construction manager can bear important results. Milestones help in controlling the schedule. The basic schedule can be expedited, but a major time reduction requires either changes in basic policy or major efforts, such as fast tracking.

*This page intentionally left blank*



---

Chapter  
**23**

## **CPM and Cost Control**

So far, project planning has been discussed in terms of the time dimension only. Although the original Remington Rand-DuPont team tied money to the network in a very sophisticated fashion, the construction industry was not ready to assimilate two new concepts at the same time. Just as you cannot learn to run until you have learned to walk, a cost system based on CPM could not be useful until CPM was accepted.

### **23.1. CPM Cost Estimate**

The first, and perhaps most difficult, step in using CPM for cost control is estimating costs by activity. The traditional method of estimating begins, of course, with the takeoff of material quantities from the drawings and specifications. Then, based on cost records, material unit costs are assigned. Finally, there are overhead costs, including estimates of anticipated supervision and equipment costs as well as a factored portion of the home office costs. Adding all of these costs together results in an accurate bid price. CPM does not offer a replacement for this type of cost estimate.

To use CPM in project cost control, a cost must be assigned to each CPM activity. Contractors can expect to be the low bidder on an average of perhaps 10 percent of the work they bid on, and since CPM should only be done on low bids, they can expect to have to do a CPM cost breakdown on only 10 percent of their project estimates.

One way to prepare the CPM cost estimates would be to undertake a second quantity takeoff by activity. This way, the same unit costs and overhead factors would be assigned to those quantities as before. The total resulting activity costs should equal the contract price. The re-estimate would cost about 50 percent more than the original estimate, though, and the adjustments required to equate it to the contract price would be an accountant's nightmare. Moreover, this method is a

compromise between traditional estimating procedures and breaking down projects into CPM activities.

Preparing a cost estimate by CPM activity can be inexpensive, fast, and sufficiently accurate if done properly. Keep in mind that the contractor knows the answer that his CPM estimate must achieve. Why not start with that answer, the contract price, and work backward? Actually that is even easier than estimating by quantity takeoff. Almost every contract requires that the bid include a cost breakdown which, when approved by the owner, becomes the basis for progress payments. The specified cost breakdown should be in categories compatible with CPM analysis:

Clearing	Roofing
Rough grading	Hung ceilings
Excavation—general	Structural steel
Excavation—utilities	Bar joists
Footings	Insulated metal panels
Foundation work	Masonry—exterior
Grade beams	Masonry—interior
Floor slabs	Windows
Underfloor plumbing	Glazing
Underfloor conduit	Doors—exterior
Major equipment (by item)	Doors—interior
Ductwork	Heating plant
Power conduit	Water piping
Branch conduit	Insulation
Switchgear	Air conditioning
Wiring	Plumbing fixtures
Drywall	Hardware
Paint	

The Construction Specifications Institute's (CSI) 16 specification standard divisions, which have become construction industry standards, a definite, industrywide shift to a common terminology has been established. The sub-breakdown of the 16 CSI divisions MASTERFORMAT into about 250 BROADSCOPE categories and an unlimited number of NARROWSCOPE categories provides the means to identify all estimating factors in common terms. With the increasing use of computers to write specifications, the use of MASTERFORMAT is increasing. Further, that increased use of MASTERFORMAT is resulting in an increasing number of estimates structured on the same numbering system. As of 2004, CSI is promulgating a new breakdown of 50 divisions to be referenced by a standard six digit code that replaces the current five digit code.

Especially with computerized estimates, categories can be summarized from the standard estimating sheets without re-estimating quantities or recalculating costs. Also, the architect or construction manager can review the cost breakdown by using quantities from the control estimate. Thus, the CPM cost estimate has stayed within the boundaries of usual estimating practices.

Once the architect, construction manager, and/or owner have approved the broad category cost breakdown, the next phase is to further break down costs into activity costs. This can be done informally, for example, by assigning project time to the activities. The cost assignment will be realistic and accurate because of the detailed breakdown of the diagram. For instance, in the John Doe project, if the cost for the category “foundation concrete” is \$144,300, we can list all the activities involving foundation concrete by just sorting and listing under that code, as shown in Table 23.1.1.

The yardage breakdown by activity can be approximate, but the total should equal the exact figure taken from the original detailed estimate. If the actual yardage for the office grade beams (24–25) was 57 yd<sup>3</sup> and the plant slab (22–29) was 1490 yd<sup>3</sup>, the effects of such differences on the total cost would be insignificant.

The breakdown of costs by activity will take additional time; and since time is money, the contractor will incur a cost. With practice, however, this cost should become nominal.

Another approach to keeping the effort and cost of assigning costs low is to utilize the cost code feature of many popular software products. As the logic network is initially being developed, each new activity added should be assigned a cost code derived either from the categories listed previously, or from the contractor’s own estimating system. Many of the popular software products support multiple cost codes to be assigned to one activity, but keep in mind that the cost coding is for general categorization only,

**TABLE 23.1.1 John Doe Project Concrete Costs**

<i>i-j</i>	Description	Approximate Cubic Yards	Cost (\$)
3–6	Water tank foundation	20	5,000
16–17	Pour pile caps	200	50,000
17–18	Grade beams, plant-warehouse	200	70,000
18–21	RR loading dock	50	15,000
18–22	Truck loading dock	50	15,000
23–24	Spread footings, office	100	17,500
24–25	Grade beams, office	60	21,000
22–29	Slab, plant-warehouse (12-in reinforced)	1500	225,000
28–29	Slab, office (6-in mesh)	<u>120</u>	<u>18,000</u>
	Total	2300	436,000

rather than for accounting purposes, and should be kept as high level and simple as possible. The goal should be to have fewer than 100 distinct cost codes for this exercise.

At this point, and again as each activity is being added to the network, the project manager should be encouraged to throw a “wild guess” for cost at each activity. If multiple cost codes have been assigned, then a “wild guess” cost estimate must be entered for each cost code. The total of all of the “wild guess” costs for each cost code may be higher or lower than that for each category of the cost breakdown or bid estimate, but it can be assumed that the error for each activity should be consistent.

It is then a simple matter for the Scheduler to factor costs by cost code, up or down, to match the desired total. This can be done by the use of global changes to the costs for each cost code, or by first exporting the costs and cost codes to an Excel or other spreadsheet file, factoring, and then importing the adjusted costs. The Scheduler can also take this process one step further by adjusting the cost of the first of a string of similar activities up (for example by an industry standard of 7 percent) to account for the learning curve. Obviously, the Engineer can challenge any gross adjustments that cannot be supported as attempts at front loading. This process can be repeated to adjust all costs to include a proportionate share of overheads and profit.

The suggestion is often made to defer cost loading until the activities and logic of the network have been approved since the addition or deletion of activities would require repeating this balancing process. Either way, the goal is to reduce the effort required by the project manager by shifting the burden that the “the numbers must add up correctly” to the Scheduler.

## **23.2. Progress Payments**

Figure 23.2.1 shows the first sheet of the John Doe project printout with costs added for all activities. (Even when costs are in the master file, they can be excluded from the printout.) A primary use for CPM cost data is as the basis for progress payments. Figure 23.2.2 shows the cost summary for one trade (electrical). CPM places progress evaluation on a well-defined basis—activity completion rather than the traditional percentage estimates. Because agreement on project status can be immediate with CPM, progress payment invoices based on that status should be approved for payment with no delay. Figure 23.2.3 shows a sample CPM-based invoice for update 2.

To the contractor, faster payment of invoices represents definite cash savings. If the approval time for invoices is shortened by 2 weeks, the savings in interest on a \$300,000 invoice would be approximately  $2/52 \times 10\% \times \$300,000$ , or \$1154. On a \$9 million project, the savings would be \$34,620. It would be reasonable to expect these savings to average 0.5% of the project cost. Additional, intangible, savings would be the lower cost of preparing and justifying invoices.

### John Doe Update #1A Cost Report

<u>PNO</u>	<u>SNO</u>	<u>PCT</u>	<u>Budget Cost</u>	<u>Cost-to-Date</u>	<u>Cost-to-Compl</u>
0	1	100	\$28,000.00	\$28,000.00	\$0.00
0	4	0	\$0.00	\$0.00	\$0.00
0	210	100	\$0.00	\$0.00	\$0.00
0	212	100	\$0.00	\$0.00	\$0.00
0	214	100	\$0.00	\$0.00	\$0.00
0	216	100	\$0.00	\$0.00	\$0.00
0	218	0	\$0.00	\$0.00	\$0.00
0	220	100	\$0.00	\$0.00	\$0.00
0	222	100	\$0.00	\$0.00	\$0.00
0	224	50	\$0.00	\$0.00	\$0.00
0	225	67	\$0.00	\$0.00	\$0.00
0	227	50	\$0.00	\$0.00	\$0.00
0	229	0	\$0.00	\$0.00	\$0.00
0	231	0	\$0.00	\$0.00	\$0.00
0	235	100	\$0.00	\$0.00	\$0.00
0	237	100	\$0.00	\$0.00	\$0.00
1	2	100	\$2,500.00	\$2,500.00	\$0.00
2	3	100	\$10,000.00	\$0.00	\$10,000.00
3	4	100	\$10,000.00	\$10,000.00	\$0.00
3	6	0	\$5,000.00	\$0.00	\$5,000.00
3	9	100	\$21,500.00	\$21,500.00	\$0.00
3	10	100	\$1,000.00	\$1,000.00	\$0.00
3	12	100	\$30,000.00	\$30,000.00	\$0.00
4	5	0	\$11,250.00	\$0.00	\$11,250.00
5	8	0	\$18,000.00	\$0.00	\$18,000.00
6	7	0	\$225,000.00	\$0.00	\$225,000.00
7	8	0	\$40,000.00	\$0.00	\$40,000.00
8	58	0	\$2,000.00	\$0.00	\$2,000.00
9	11	100	\$65,000.00	\$65,000.00	\$0.00
10	11	100	\$6,500.00	\$6,500.00	\$0.00
11	12	100	\$7,500.00	\$7,500.00	\$0.00
12	13	100	\$6,000.00	\$6,000.00	\$0.00
13	14	100	\$4,000.00	\$4,000.00	\$0.00
14	15	50	<u>\$70,000.00</u>	<u>\$35,000.00</u>	<u>\$35,000.00</u>
			\$563,250.00	\$217,000.00	\$346,250.00

Figure 23.2.1 John Doe project printout, Lotus format: first sheet of *i-j*.

COST REPORT /01  
 SORT KEYS ARE 11J

JOHN DOE BASELINE CPM SCHEDULE  
 PREPARED BY D'ARRIEN-KREITZBERG & ASSOC., INC.

PAGE 1

I NODE	J NODE	ACTIVITY DESCRIPTION	RFM DUR	CNTR TYPE	WORK CAT.	SPEC SEC.	TOTAL COST	PERCENT COMPLETE	TO DATE COST
10	11	INSTALL ELECTRICAL MANHOLES	5.0	EL	1-4	0250	\$3,800	0	\$0
11	12	INST ELEC DUCTBANK	3.0	EL	1-4	0250	\$4,500	0	\$0
12	13	PULL IN POWER FEEDER	5.0	EL	1-4	0250	\$3,600	0	\$0
20	22	UNDERSLAB CONDUIT P-W	5.0	EL	2-4	1640	\$4,500	0	\$0
27	28	UNDERSLAB CONDUIT OFFICE	3.0	EL	2-4	1640	\$3,000	0	\$0
37	38	SET ELECTRICAL LOD CENTER PW	2.0	EL	3-4	1640	\$14,500	0	\$0
37	43	POWER PANEL BACKING BOXES P	10.0	EL	3-4	1640	\$11,000	0	\$0
37	93	AREA LIGHTING	20.0	EL	5-4	0250	\$20,000	0	\$0
38	43	INSTALL POWER CONDUIT P-W	20.0	EL	3-4	1640	\$12,500	0	\$0
43	49	INSTALL BRANCH CONDUIT P-W	15.0	EL	3-4	1640	\$17,500	0	\$0
45	51	ROOM OUTLETS P-W	5.0	EL	3-4	0810	\$10,000	0	\$0
49	50	PULL WIRE P-W	15.0	EL	3-4	1640	\$23,000	0	\$0
50	54	INSTALL PANEL INTERNALS P-W	5.0	EL	3-4	1640	\$4,500	0	\$0
51	56	INSTALL ELECTRICAL FIXTURES	10.0	EL	3-4	1650	\$10,000	0	\$0
54	55	TERMINATE WIRFS P-W	10.0	EL	3-4	1640	\$4,500	0	\$0
55	56	RINGOUT P-W	10.0	EL	3-4	1640	\$1,750	0	\$0
56	58	ENERGIZE POWER	1.0	EL	3-4	1640	\$1,000	0	\$0
61	65	INSTALL ELEC HACKING BOXES	4.0	EL	4-4	1640	\$2,000	0	\$0
65	66	INSTALL CONDUIT OFFICE	10.0	EL	4-4	1640	\$6,000	0	\$0
66	74	PULL WIRE OFFICE	10.0	EL	4-4	1640	\$6,000	0	\$0
74	75	INSTALL PANEL INTERNALS OFFICE	5.0	EL	5-5	1640	\$3,000	0	\$0
75	79	TERMINATE WIRES OFFICE	10.0	EL	4-4	1640	\$4,000	0	\$0
76	79	AIR CONDITIONNG ELEC CONNEC	4.0	EL	4-4	1640	\$1,000	0	\$0
79	80	RINGOUT ELECT	5.0	EL	4-4	1640	\$1,500	0	\$0

Figure 23.2.2 Cost summary for electrical trade.

## John Doe Update #2 Cost Report

*Sort by Electrical*

<u>PNO</u>	<u>SNO</u>	<u>PCT</u>	<u>Budget Cost</u>	<u>Cost-to-Date</u>	<u>Cost-to-Compl</u>
3	12	100	30000.00	30000.00	0.00
10	11	100	6500.00	6500.00	0.00
11	12	100	7500.00	7500.00	0.00
12	13	100	6000.00	6000.00	0.00
20	22	100	7500.00	7500.00	0.00
27	28	0	5000.00	0.00	5000.00
37	93	0	33000.00	0.00	33000.00
38	43	0	21000.00	0.00	21000.00
43	49	0	29000.00	0.00	29000.00
45	51	0	16500.00	0.00	16500.00
49	50	0	38000.00	0.00	38000.00
50	54	0	7500.00	0.00	7500.00
51	56	0	31000.00	0.00	31000.00
54	55	0	7500.00	0.00	7500.00
55	56	0	5000.00	0.00	5000.00
56	58	0	2000.00	0.00	2000.00
61	65	0	4000.00	0.00	4000.00
65	66	0	9000.00	0.00	9000.00
66	74	0	10000.00	0.00	10000.00
74	75	0	5000.00	0.00	5000.00
75	79	0	7500.00	0.00	7500.00
76	79	0	2000.00	0.00	2000.00
79	80	0	2500.00	0.00	2500.00
300	38	0	0.00	0.00	0.00
301	43	0	0.00	0.00	0.00
40	47	0	5000.00	0.00	5000.00
41	47	0	2000.00	0.00	2000.00
46	52	0	25000.00	0.00	25000.00
47	58	0	1500.00	0.00	1500.00
52	58	0	10000.00	0.00	10000.00
61	64	0	9000.00	0.00	9000.00
61	77	0	16000.00	0.00	16000.00
64	67	0	1000.00	0.00	1000.00
98	76	0	0.00	0.00	0.00
304	46	0	0.00	0.00	0.00
305	47	0	0.00	0.00	0.00
306	41	0	0.00	0.00	0.00
307	40	0	0.00	0.00	0.00
Total cost-to-date				57,500	
Billed-to-date				0	
This invoice				57,500	

Figure 23.2.3 CPM-based invoice for update 2 (electrical work).

The owner's (as well as the construction manager's and architect's) tangible savings stem from the shorter time required to approve invoices. This frees staff for other work. More important to the owner, however, is the assurance that the invoices paid represent a correct and equitable portion of the contract.

### 23.3. Cost Forecasting

The costs of the activities for the first portion of the John Doe network are shown in Table 23.3.1. Time and cost dimensions can be combined to forecast the rate of spending on a project. If the project is on schedule, the contractor will earn the cost of an activity somewhere between the early finish and the late finish dates. Plot the cumulative cost of activities completed against project time, and cost against early completions will give the maximum amount of money required on any project day. On any project day  $x$ , the plot determines a maximum-minimum range of funds required. The actual amount will be somewhere between the two. For the contractor, this is the forecast of his earning rate on the project. Working backward, the contractor can borrow just the amount of money needed to finance the project until sufficient cash is derived from invoices to make the project financially independent.

The contractor's savings will depend on his mode of financing. If the sum is being borrowed outright, a specific savings in interest is achieved by borrowing less. If the contractor is working against a credit commitment, this approach will define the number of projects that can be handled within that amount.

**TABLE 23.3.1 John Doe Project Activity Costs**

	Activity	Cost, \$
0-1	Clear	28,000
1-2	Survey	2,500
2-3	Rough grade	10,000
3-4	Drill well	10,000
3-6	Water tank foundations	5,000
3-9	Sewer excavation	21,500
3-10	Excavate for manhole	1,000
3-12	Overhead pole line	30,000
4-5	Well pump	11,250
5-8	Underground pipe	18,000
6-7	Water tank	225,000
7-8	Tank piping	40,000
8-13	Connect piping	2,000
9-11	Sewer	65,000
10-11	Electrical manholes	6,500
11-12	Electrical duct bank	7,500
12-13	Power feeder	<u>6,000</u>
	Total	<u>489,250</u>



The owner's savings from the cash forecast are even more definite. If financing the project from securities, the owner can liquidate at the latest time practical and thus earn interest for the maximum length of time and maintain the principal at its largest practical value. If the owner receives the total construction fund in one lump sum, as in a bond issue, the greater portion can be scheduled for higher-interest, long-term investments and only the part that must be held for near-term use has to be placed in lower-interest, short-term investments.

Figure 23.3.1 shows a plot of the John Doe project site preparation costs based on early finish times. Figure 23.3.2 gives a similar plot of

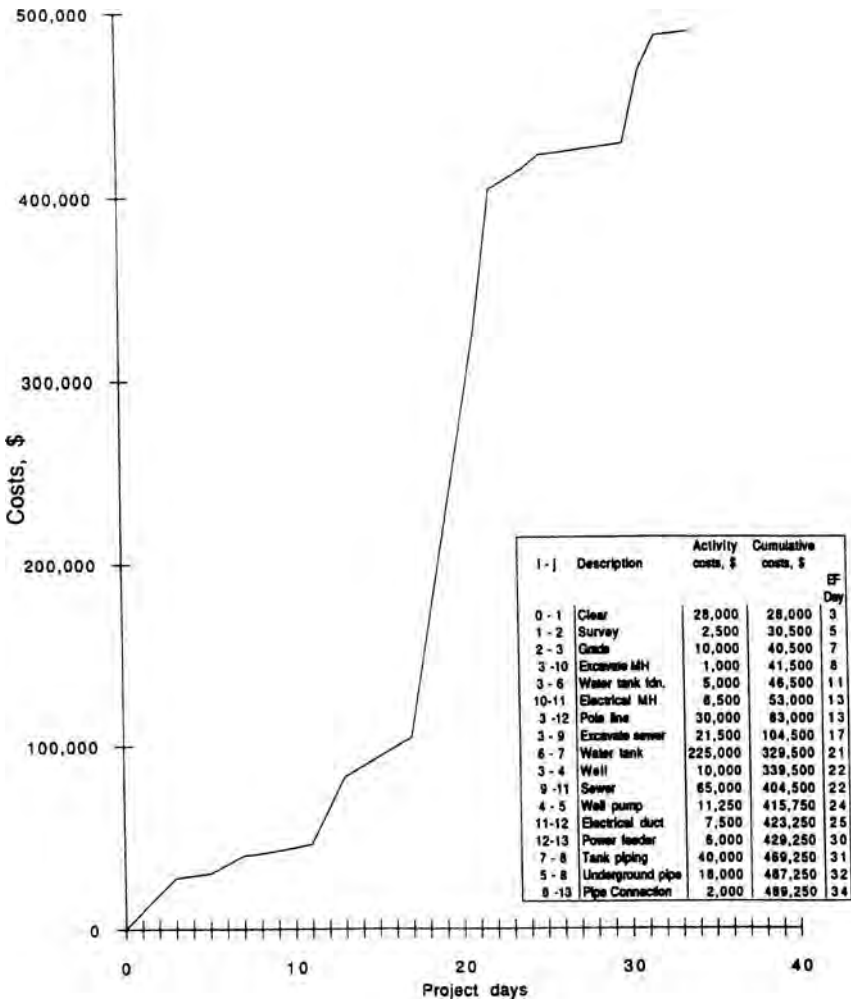

Figure 23.3.1 Project days. Cost vs. time: early-finish basis.

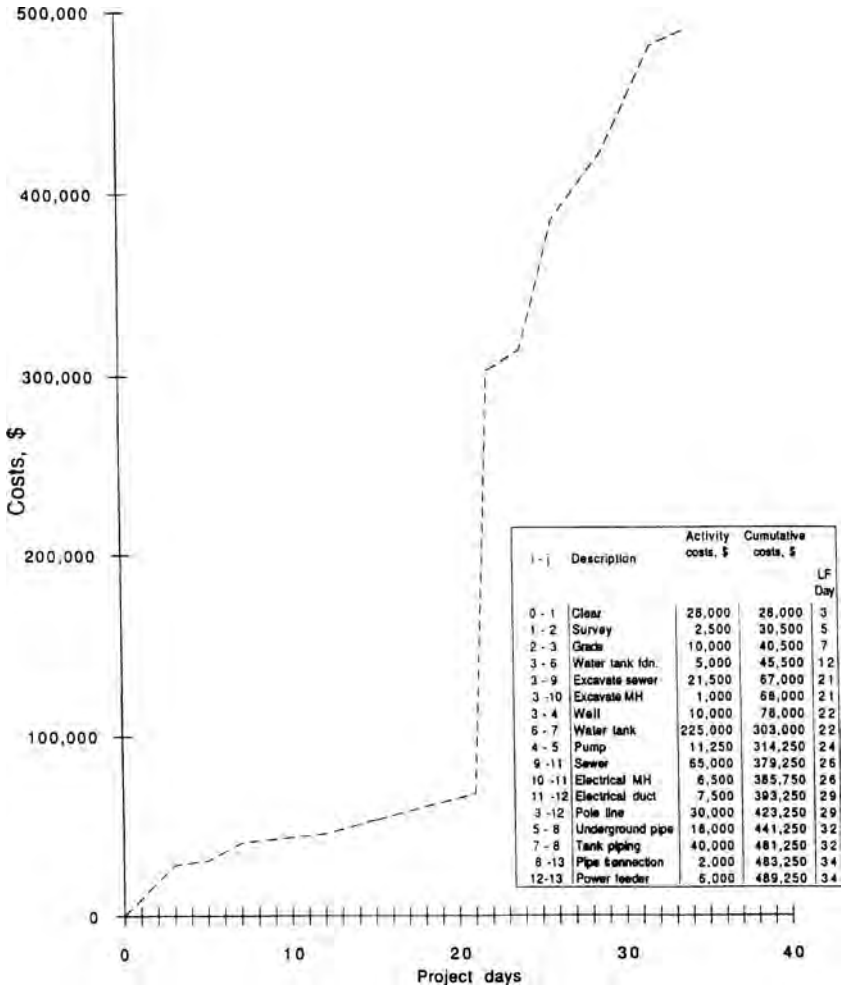

Figure 23.3.2 Project days. Cost vs. time: late-finish basis.

money vs. time but is based on late finish times. Figure 23.3.3 shows both curves on the same plot. In larger network samples, the early and late finish cost curves tend to parallel to each other. Also, the curves are usually smooth and have very few inflection points. The time scale is usually in weeks or months, which is of more concern for the broad financial control of a project.

The cost forecast is meaningful because it is plotted to a true time scale, whereas the example plot was done manually, the computer can

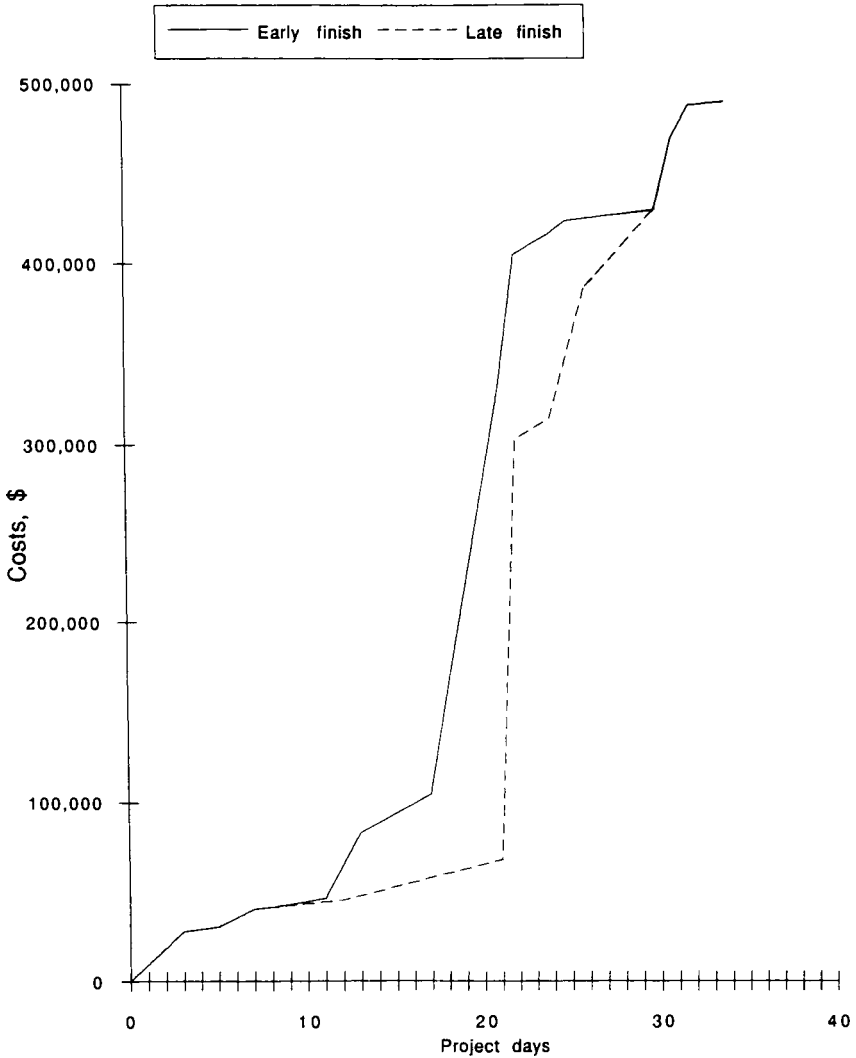

Figure 23.3.3 Project days. Comparison of early- and late-finish costs vs. time curves.

provide computer-generated curves when the network is cost-loaded. Figures 23.3.4 and 23.3.5 are the computer-generated cost forecasts, and Figure 23.3.6 is the cost basis for the John Doe *i-j* sort. As the project moves slightly ahead of or behind schedule, curves to reflect those conditions can easily be generated. The recommended updating frequency for the cost curves is quarterly.

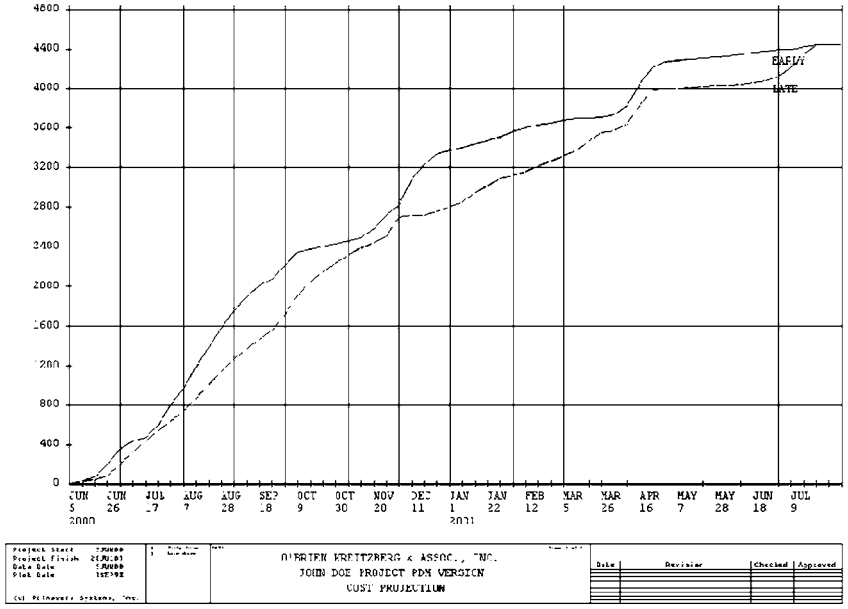

Figure 23.3.4 Computer generated cost forecast for the John Doe project—Early & Late—Cumulative.

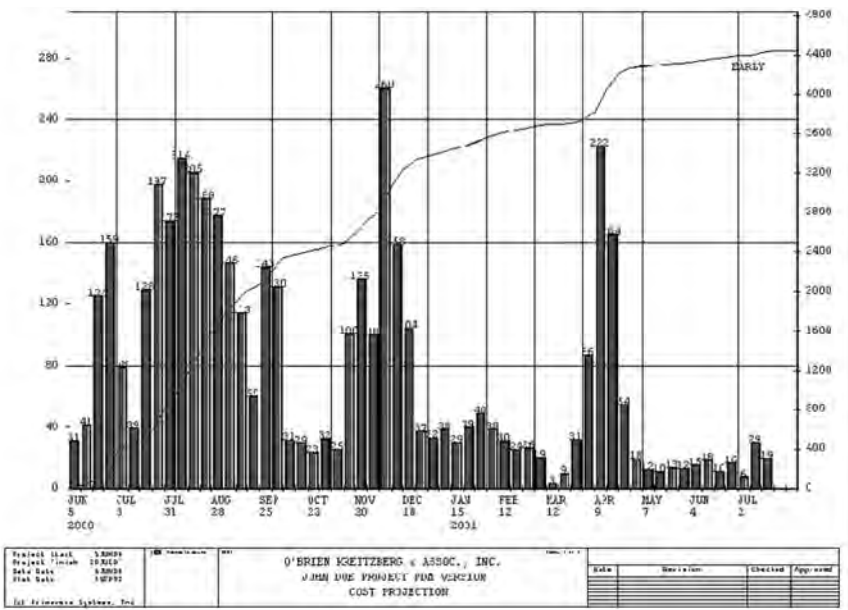

Figure 23.3.5 Computer generated cost forecast for the John Doe project—Early dates—Cumulative and Histogram.

i	j	DUR- ATION		DESCRIPTION	COSTS	
0	1	3	1	1	CLEAR SITE	28,000
1	2	2	1	2	SURVEY AND LAYOUT	2,500
2	3	2	1	1	ROUGH GRADE	10,000
3	4	15	1	7	DRILL WELL	10,000
3	6	4	1	3	WATER TANK FOUNDATIONS	5,000
3	9	10	1	1	EXCAVATE FOR SEWER	21,500
3	10	1	1	1	EXCAVATE ELECTRICAL MANHOLES	1,000
3	12	6	1	4	OVERHEAD POLE LINE	30,000
4	5	2	1	5	INSTALL WELL PUMP	11,250
5	8	1	5	5	UNDERGROUND WATER PIPING	18,000
6	7	10	1	6	ERECT WATER TOWER	225,000
7	8	10	1	5	TANK PIPING AND VALVES	40,000
8	13	2	1	5	CONNECT WATER PIPING	2,000
9	11	5	1	3	INSTALL SEWER AND BACKFILL	65,000
10	11	5	1	4	INSTALL ELECTRICAL MANHOLES	6,500
11	12	3	1	4	ELECTRICAL DUCT BANK	7,500
12	13	5	1	4	PULL IN POWER FEEDER	6,000
13	14	1	2	7	BUILDING LAYOUT	4,000
14	15	10	2	7	DRIVE AND POUR PILES	70,000
14	23	3	2	1	EXCAVATE FOR OFFICE BUILDING	27,000
15	16	5	2	1	EXCAVATE FOR PLANT WAREHOUSE	86,000
16	17	5	2	3	POUR PILE CAPS PLANT WAREHOUSE	50,000
17	18	10	2	3	FORM + POUR GRADE BEAMS P-W	70,000
18	19	3	2	1	BACKFILL AND COMPACT P-W	9,000
18	21	5	2	3	FORM + POUR RR LOAD DOCK P-W	15,000
18	22	5	2	3	FORM + POUR TK LOAD DOCK P-W	15,000
19	20	5	2	5	UNDERSLAB PLUMBING P-W	12,000
20	22	5	2	4	UNDERSLAB CONDUIT P-W	7,500
21	22	0			RESTRAINT	
22	29	10	2	3	FORM + POUR SLABS P-W	225,000
22	24	4	2	3	SPREAD FOOTINGS OFFICE	17,500
24	25	6	2	3	FORM + POUR GRADE BEAMS OFF	21,000
25	26	1	2	1	BACKFILL + COMPACT OFFICE	1,800
26	27	3	2	5	UNDERSLAB PLUMBING OFFICE	9,000
27	28	3	2	4	UNDERSLAB CONDUIT OFFICE	5,000
28	29	3	2	3	FORM + POUR OFFICE SLAB	18,000
29	30	10	3	6	ERECT STRUCT STEEL P-W	50,000
30	31	5	3	6	PLUMB STEEL AND BOLT P-W	15,000
31	32	5	3	6	ERECT CRANE WAY AND CRANE P-W	20,000
31	33	3	3	6	ERECT MONORAIL TRACK P-W	10,000
33	34	3	3	6	ERECT BAR JOISTS P-W	15,000
34	35	3	3	6	ERECT ROOF PLANKS P-W	15,000
35	36	10	3	7	ERECT SIDING P-W	75,000
35	37	5	3	7	BUILT UP ROOFING P-W	175,000
37	38	3	3	4	SET ELECTRICAL LOAD CENTER PW	30,500
37	42	5	3	6	ERECT EXTERIOR DOORS P-W	30,000
37	43	10	3	4	POWER PANEL BACKFILL BOXES P-	18,000
37	39	10	3	7	MASONRY PARTITIONS P-W	80,000
37	46	15	3	5	INSTALL H + V UNITS P-W	120,000
37	40	30	3	5	FABRICATE PIPING P-W	60,000
37	41	25	3	5	ERECT BOILER + AUXILIARY P-W	25,000
37	47	3	3	5	INSTALL FUEL TANK P-W	15,000
37	58	5	3	7	INSTALL MONORAIL WAREHOUSE	25,000
37	80	10	5	7	PERIMETER FENCE	25,000
37	90	5	5	7	PAVE PARKING AREA	35,000
37	91	5	5	1	GRADE + BALLAST RR SIDING	20,000
37	92	10	5	7	ACCESS ROAD	25,000
37	93	20	5	4	AREA LIGHTING	33,000
37	43	20	3	4	INSTALL POWER CONDUIT P-W	21,000
39	42	5	3	8	FRAME CEILING P-W	25,000
40	47	10	3	5	TEST PIPING SYSTEMS P-W	5,000

i	j	DUR- ATION		DESCRIPTION	COSTS	
41	47	5	3	5	PREOPERATIONAL BOILER CHECK	2,000
42	44	10	3	8	DRYWELL PARTITIONS P-W	35,000
43	49	15	3	4	INSTALL BRANCH CONDUIT P-W	29,000
44	48	10	3	7	CERAMIC TILE	10,000
44	58	10	3	8	HANG INTERIOR DOORS P-W	20,000
45	51	5	3	4	ROOM OUTLETS P-W	16,500
46	52	25	3	7	INSTALL DUCTWORK P-W	25,000
47	58	5	3	5	LIGHTOFF BOILER AND TEST	1,500
48	53	5	3	7	PAINT ROOMS P-W	15,000
49	50	15	3	4	PULL WIRE P-W	38,000
50	54	5	3	4	INSTALL PANEL INTERNALS P-W	7,500
51	56	10	3	4	INSTALL ELECTRICAL FIXTURES	31,000
52	58	15	3	7	INSULATE H + V SYSTEM P-W	10,000
53	57	10	3	7	FLOOR TILE P-W	20,000
53	58	10	3	5	INSTALL PLUMBING FIXTURES P-W	20,000
54	55	10	3	4	TERMINATE WIRES P-W	7,500
55	56	10	3	4	RINGOUT P-W	5,000
56	58	1	3	4	ENERGIZE POWER	2,000
57	58	10	3	7	INSTALL FURNISHING P-W	30,000
58	59	5	4	6	ERECT PRECAST STRUCT. OFFICE	20,000
58	94	5	5	1	FINE GRADE	5,000
58	80	5	5	7	ERECT FLAGPOLE	1,500
59	60	5	4	6	ERECT PRECAST ROOF OFFICE	30,000
60	61	10	4	7	EXTERIOR MASONRY OFFICE	380,000
60	76	5	4	5	INSTALL PACKAGE AIR CONDITR	40,000
61	62	5	4	8	EXTERIOR DOORS OFFICE	3,600
61	63	5	4	7	BUILT UP ROOFING OFFICE	32,000
61	77	15	4	7	DUCTWORK OFFICE	16,000
61	68	5	4	7	GLAZE OFFICE	12,000
61	64	10	4	5	INSTALL PIPING OFFICE	9,000
61	65	4	4	4	INSTALL ELEC BACKING BOXES	4,000
63	80	5	4	7	PAINT OFFICE EXTERIOR	6,000
64	67	4	4	5	TEST PIPING OFFICE	1,000
65	66	10	4	4	INSTALL CONDUIT OFFICE	9,000
66	74	10	4	4	PULL WIRE OFFICE	10,000
67	68	5	4	7	PARTITIONS OFFICE STUDS	5,000
68	69	5	4	7	START DRY WALL	5,000
69	70	10	4	7	FINISH DRY WALL	10,000
69	73	10	4	7	CERAMIC TILE OFFICE	9,000
70	77	0			RESTRAINT	
70	71	10	4	8	WOOD TRIM OFFICE	12,000
71	72	10	4	7	PAINT INTERIOR OFFICE	16,000
71	80	5	4	8	HANG DOORS OFFICE	10,000
72	80	10	4	7	FLOOR TILE OFFICE	18,000
73	80	5	4	5	TOILET FIXTURES OFFICE	10,000
74	75	5	5	5	INSTALL PANEL INTERNALS OFFICE	5,000
75	79	10	4	4	TERMINATE WIRES OFFICE	7,500
76	79	4	4	4	AIR CONDITIONING ELEC CONNECT	2,000
77	75	5	4	8	INSTALL CEILING GRID OFFICE	10,000
78	80	10	4	7	ACOUSTIC TILE OFFICE	20,000
79	80	5	4	4	RINGOUT ELECT.	2,500
91	58	10	5	7	INSTALL RR SIDING	50,000
94	80	5	5	7	SEED + PLANT	20,000
					E N D	

Figure 23.3.6 Cost basis for the John Doe project (i-j).

When an owner is forecasting the finances of a fixed-price contract, unless a change order is added to the contract, the time may change but the costs will not. What if a major change is made or the contract is cost plus? In this case, the cost changes can be introduced by changing the cost values for the affected activities.

The cost savings possible using CPM cost forecasting are difficult to assess. However, the uncommitted construction funds, which are 100% of the project cost at project day 0 and 0% at the end of construction, roughly average 50% over the life of the project. Figure 23.3.7 represents a project cost vs. time curve.

The uncommitted area (cost  $\times$  time) approximately equals the money payable to the contractor. If an owner has the total construction fund at the start of the project, part of it can be invested in long-term bonds yielding about 6% interest. Another portion can be held in short-term notes yielding about 4%. Over the life of the project, an average interest of about 5% can be realized on the uncommitted funds (or about 50% of the project cost). For a 1-year project, this could amount to 2% of the cost. A 2-year project would be more nearly average, and the total earnings on the uncommitted funds for that period would be about 5%.

The use of accurate CPM cost forecast curves to predict how much money will be needed each month to pay for a project can guide the owner in investing any as yet uncommitted funds. However, the contingency cash required at any given time will be 2 to 4 percent lower because of accurate CPM cash forecasting. The additional peace of mind such accuracy will provide for the owner's investment counselor can be counted only for its intangible value.

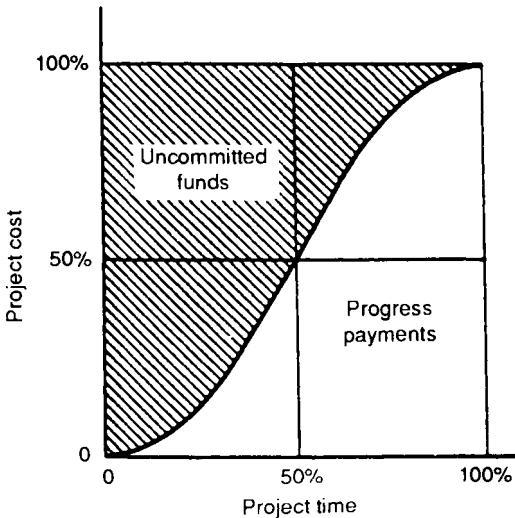

Figure 23.3.7 Project cost vs. time curve.

### 23.4. Network Time Expediting

The cost assigned to each activity is the normal cost, that is, the cost of doing the activity with a normal crew under normal conditions. But there are cases in which owners want projects completed on an expedited basis or contractors must expedite their efforts to complete projects on schedule. The traditional approach is to put the entire project on a crash overtime basis. This is quite expensive for two reasons. First, it usually occurs late in the project when the workforce is at a peak. Second, most of the work activities done on a crash basis are float jobs, the completion of which does not shorten the project by even a day.

*Crash* is defined as the shortest time within which an activity can be accomplished by using a larger crew, overtime, extra shifts, or any combination of the three. Some activities which it might appear that expediting cannot affect are crashed by using such special techniques as high early-strength cement. By definition, *normal* time must be longer than crash time (Figure 23.3.7).

To shorten an activity duration from normal to crash, the activity costs are inevitably increased. The increase results from premium time costs, inefficiency of larger crews, and increased material costs (such as extra forms and high early-strength cement). The cost that is associated with the crash time is known as the *crash cost*. For the John Doe site preparation network, the crash times might be like the ones shown in Table 23.4.1.

**TABLE 23.4.1 John Doe Project Crash Times**

<i>i-j</i>	Description	Normal time, days	Method of expediting	Crash time, days
0-1	Clear	3	Overtime	2
1-2	Survey	2	Extra crew, overtime	1
2-3	Rough grade	2	Extra crew, overtime	1
3-4	Drill well	15	Double shifts	8
3-6	Water tank foundations	4	Extra crew, overtime	3
3-9	Excavate sewer	10	Extra equipment, overtime	6
3-10	Excavate manhole	1		1
3-12	Pole line	6	Extra equipment, overtime	4
4-5	Well pump	2	Extra crew, overtime	1
5-8	Underground pipe	8	Extra crew, overtime	6
6-7	Erect tank	10	Overtime	8
7-8	Tank piping	10	Extra crew, overtime	8
8-13	Connect piping	2	Overtime	1
9-11	Sewer	5	Extra crew, overtime	3
10-11	Electrical manhole	5	Extra crew, overtime	4
11-12	Duct bank	3	Extra crew, overtime	2
12-13	Power feed	5	Third shift	2

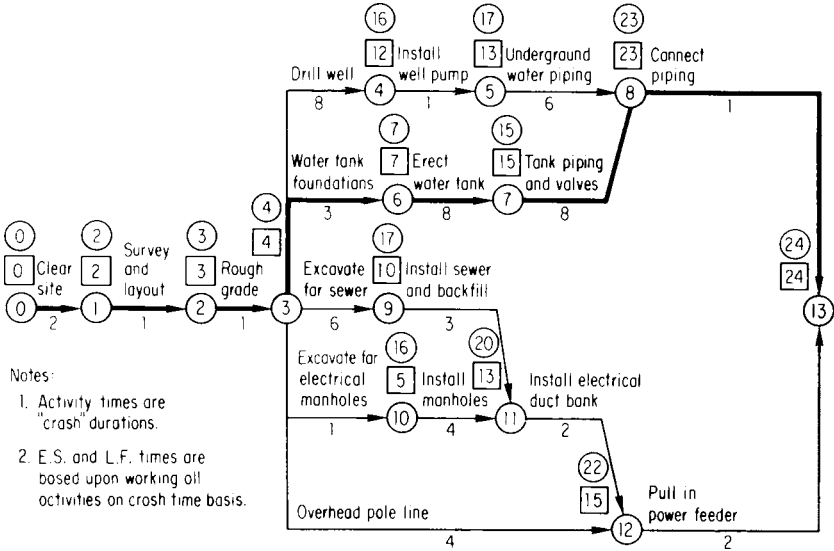

Figure 23.4.1 Full-crash plan for the John Doe project.

Figure 23.4.1 shows the calculation of crash event times. Note that it is just a basic CPM calculation. The normal and crash results are compared in Table 23.4.2.

Note that the total crash duration of the project is 10 days shorter than its normal duration. Note also that the critical path has shifted. Estimated crash costs are shown in Table 23.4.3.

The crash cost to pick up 10 days appears to be \$160,750, or \$16,075 per day. However, what if you do not need to expedite the completion by the full 10 days? Figure 23.4.2 shows a plot of normal versus crash times and costs for the activity drill well. For a cost difference of \$7,000, the operation can be expedited in 7 days, an average extra cost of \$1,000 per day. A linear connection between normal and crash points is generally a reasonable assumption; minor variations tend to cancel out. How much would drilling the well cost if it were to be done in 11 days? The answer, from Figure 23.4.1, is \$14,000. The cost of expediting a particular activity is a linear plot of the crash and normal costs, but that assumption does not apply to the costs of expediting an overall project.

To cut 1 day off the 34-day John Doe site preparation project, cut 1 day off the critical path from any one of the following activities for the costs listed in Table 23.4.4.

The best choice for 1 day would clearly be activity 3-4, drill well, at \$1,000. At that point, both the well and tank paths are critical. Expediting along the tank path would cost as shown in Table 23.4.5.



**TABLE 23.4.2 Normal vs. Crash Times**

Activity	Normal ES	Crash ES	Crash LF	Normal LF	Normal float, days	Crash float, days
0-1	0	0	2	3	0	0
1-2	3	2	3	5	0	0
2-3	5	3	4	7	0	0
3-4	7	4	16	22	0	4
3-6	7	4	7	12	1	0
3-9	7	4	17	21	4	7
3-10	7	4	16	21	13	11
3-12	7	4	22	29	16	14
4-5	22	12	17	24	0	4
5-8	24	13	23	32	0	4
6-7	11	7	15	22	1	0
7-8	21	15	23	32	1	0
8-13	32	23	24	34	0	0
9-11	17	10	20	26	4	7
10-11	8	5	20	26	13	11
11-12	22	13	22	29	4	7
12-13	25	15	24	34	4	7

If the path is to be shortened by another day between events 3 and 8, the well driller continues to be a bargain. Activity 3-6, water tank foundations, is the next best buy, since activity 6-7, erect tank, and 7-8, tank piping, are very expensive at both normal and crash costs.

**TABLE 23.4.3 Normal vs. Crash Costs**

<i>i-j</i>	Normal costs, \$	Description	Source of extra costs	Crash costs, \$
0-1	28,000	Clear	Overtime	34,000
1-2	2,500	Survey	Second crew, overtime	5,000
2-3	10,000	Rough grade	Second crew, overtime	15,000
3-4	10,000	Drill well	Double shifts	27,000
3-6	5,000	Water tank foundations	Crew, overtime	8,000
3-9	21,500	Excavate sewer	Equipment, overtime	32,000
3-10	1,000	Excavate manhole		1,500
3-12	30,000	Pole line	Equipment, overtime	40,000
4-5	11,250	Well pump	Crew, overtime	14,000
5-8	18,000	Underground pipe	Crew, overtime	27,000
6-7	225,000	Erect tank	Overtime	275,000
7-8	40,000	Tank piping	Crew, overtime	60,000
8-13	2,000	Connect piping	Overtime	4,000
9-11	65,000	Sewer	Crew, overtime	90,000
10-11	6,500	Electrical manhole	Crew, overtime	7,500
11-12	7,500	Duct bank	Overtime	10,000
12-13	6,000	Power feeder	Third shift	10,000
Total	489,250			650,000

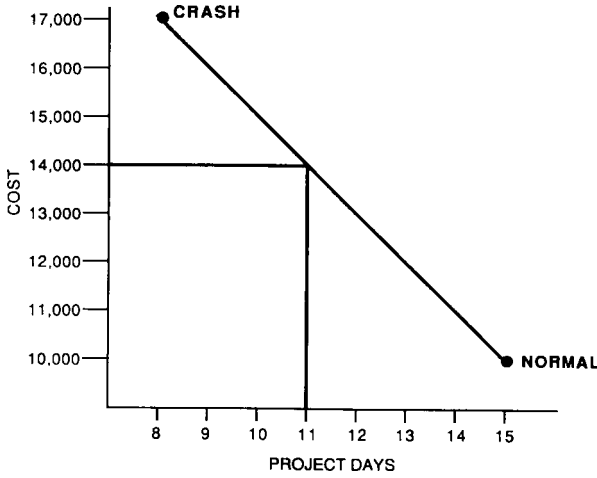

Figure 23.4.2 Cost-time relationship for activity 3-4, drill well.

TABLE 23.4.4 Choice of Activities to Crash by 1 Day

Critical path activity	Difference between crash and normal costs, \$	Normal duration, days	Crash duration, days	Difference between crash and normal duration, days	Extra costs per day, \$
0-1	6,000	3	2	1	6,000
1-2	2,500	2	1	1	2,500
3-4	7,000	15	8	7	1,000
4-5	2,750	2	1	1	2,750
5-8	9,000	8	6	2	4,500
8-13	2,000	2	1	1	2,000

TABLE 23.4.5 Expediting Along the Tank Paths

Activity	Difference between crash and normal costs, \$	Normal duration, days	Crash duration, days	Difference between crash and normal duration, days	Extra costs per day, \$
3-6	3,000	4	3	1	3,000
6-7	50,000	10	8	2	25,000
7-8	20,000	10	8	2	10,000

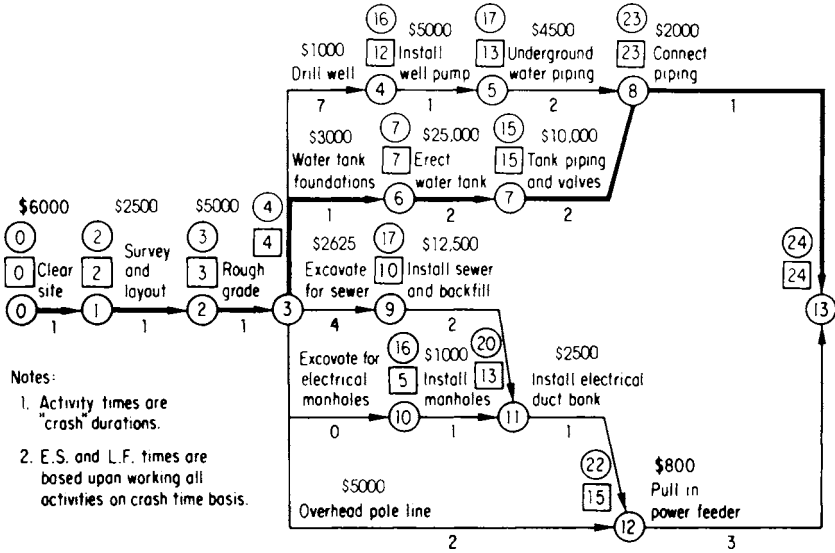

- Notes:
1. Activity times are "crash" durations.
  2. E.S. and L.F. times are based upon working all activities on crash time basis.

**Figure 23.4.3** Cost-time cash planning factors for John Doe project shown as costs per day per activity.

The minimum cost to cut 2 days off between events 3 and 8 involves activity 3-6, water tank foundations (\$3,000), plus 3-4, drill well (\$1,000), for a total of \$4,000.

Figure 23.4.3 shows the John Doe site network with the potential acceleration per activity and the costs per day to accelerate those activities. Using that information, the optimum expediting for the initial 3 days would be as shown in Table 23.4.6.

Thus, 3 days of a possible 10 can be expedited by using the logic and information at hand. The results are impressive: a 30% gain in time at an average cost of \$1,833 per day versus maximum projected crash costs of \$16,076, for a 9:1 advantage.

Candidates for expediting the 4th through the 7th days would be those shown in Table 23.4.7. Taking activity 3-4, drill well, and 3-6, water tank foundations, together, day 4 can be expedited for \$4,000. Days 5 and 6, taking activity 0-1, clear, and 2-3, rough grade, will cost an average of \$5,500 each to expedite, or more than three times the average cost of expediting the first 3 days.

**TABLE 23.4.6** Optimum Activities to Crash by 3 Days

Day 1	Drill well (3-4)	\$1,000
Day 2	Connect piping (8-13)	\$2,000
Day 3	Survey (1-2)	\$2,500

**TABLE 23.4.7 Candidates for Crashing Day 4 Through 7**

Clear (0-1)		\$6,000
Rough grade (2-3)		\$5,000
Drill well (3-4)	\$1,000	\$4,000
Water tank foundations (3-6)	\$3,000	\$25,000
Erect tank (6-7)		

**TABLE 23.4.8 Crashing by 7 Days**

<i>i-j</i>	Description	Normal time, days	Crash time, days	$\Delta T$ , days	$\Delta \$$	Costs/day to expedite, \$
0-1	Clear	3	2	1	6,000	6,000
1-2	Survey	2	1	1	2,500	2,500
2-3	Rough grade	2	1	1	5,000	5,000
3-4	Drill well	15	8	7	7,000	1,000
3-6	Water tank foundations	4	3	1	3,000	3,000
3-9	Excavate sewer	10	6	4	10,500	2,625
3-10	Excavate manhole	1	1	—	—	—
3-12	Pole line	6	4	2	10,000	5,000
4-5	Well pump	2	1	1	2,750	2,750
5-8	Underground pipe	8	6	2	9,000	4,500
6-7	Erect tank	10	8	2	50,000	25,000
7-8	Tank piping	10	8	2	20,000	10,000
8-13	Connect piping	2	1	1	2,000	2,000
9-11	Sewer	5	3	2	25,000	12,500
10-11	Electrical manhole	5	4	1	1,000	1,000
11-12	Duct bank	3	2	1	2,500	2,500
12-13	Power feeder	5	2	3	4,000	1,333

Expedited day	Activities expedited	Costs, \$	Original path 3-4-5-8	Float used path 3-9-11-12
1.	Drill well	1,000	1	1
2.	Connect piping	1,000	0	1
3.	Survey	2,500	0	0
4.	Drill well/water tank foundations	4,000	—	1
5.	Rough grade	5,000	0	0
6.	Clear	6,000	0	0
7.	Tank piping/drill well	11,000		1
8.	Same activities as for day 7 plus 3-6, excavate sewer	13,625		
9.	Erect tank/drill well/excavate sewer	28,625		
10.	Same activities as for day 9	<u>28,625</u>		
	Total	101,375		

And day 7, taking activity 7–8, tank piping, and again 3–4, can be expedited for \$11,000. Expediting beyond this requires consideration of the paths through the sewer, duct bank, and pole line, because the normal float of 4 days following event 3 will have been used up. See Table 23.4.8 for a summary.

Note that this selective approach to expediting the project costs \$45,000, or only 54 percent of the costs resulting from the total-crash approach (\$83,350).

To get maximum 10-day acceleration, if planned by CPM, the cost is 63 percent (\$101,375) of maximum 100 percent crash (\$160,750). Further, if 80 percent of the maximum acceleration (i.e., 8 days) is acceptable, the acceleration is only 27 percent of full crash. That is, the first 8 days of acceleration averages \$5,516 versus \$10,938 averages for a 10-day maximum acceleration.

### 23.5. Minimum Cost Expediting

Why is the owner building? Obviously, to use the facility. In the case of a hotel, a hospital, a manufacturing facility, or a restaurant, the owner can realize a definite cash payoff for every day gained in the completion of the project, or basically a linear payoff. Considerable losses can result in the same fashion. For instance, a school gains nothing (except considerable peace of mind) by opening early. However, if the school opens late, the cash costs can be calculated for extra buses, rented quarters, etc.

Combining the direct cost curve with a straight-line indirect cost curve creates a third curve, the total cost curve. This combination is shown in Figure 23.5.1. Note that, at some time between crash and normal, the total cost curve dips to a minimum point. In any project, it is worth some cash outlay  $\Delta\$$  to expedite the project. That will save time ( $\Delta T$ ) and money ( $\Delta\$$ ). In the John Doe site network, assigning values to the indirect costs:

Contractor’s supervision: Two persons, total \$4,000 per week

Equipment: Shacks, power, telephone, and so on, \$2,500 per week

Owner: Project engineer, \$2,500 per week

Production advantage: \$2,000 per day

The combined indirect costs and savings per day are

$$\frac{\$2,500 + \$2,500 + \$4,000}{5} + \$2,000 = \$3800$$

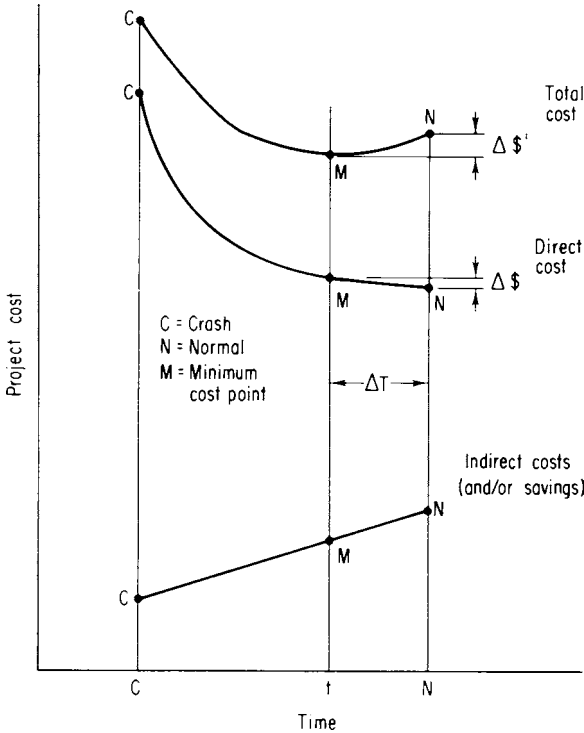

Figure 23.5.1 Combination of direct and indirect cost curves.

In Figure 23.5.2, the direct and indirect costs are shown combined. Table 23.5.1 is a summary of the costs for expediting, combined with indirect cost savings. This approach is realistic, but it has not been used widely for four reasons: First, since it is CPM-based, only a company already using CPM can consider it. Second, it requires the assignment of two costs to activities and there is a psychological barrier to the assignment of even one cost. Third, in most construction projects, it is not practical to put just certain crafts on overtime. If you do, the other trades will usually make their objections felt in a number of ways. Fourth, only one computer program has been available for the calculation. That one, by James E. Kelley, Jr. for the GE 225 computers, is now obsolete.

The first barrier (CPM usage) is rapidly falling away. The second (cost assignment) will crumble as other CPM cost systems are adopted. It is easy to assign crash costs and times at the same time as normal costs and times (adding perhaps 10 to 20 percent to the normal effort

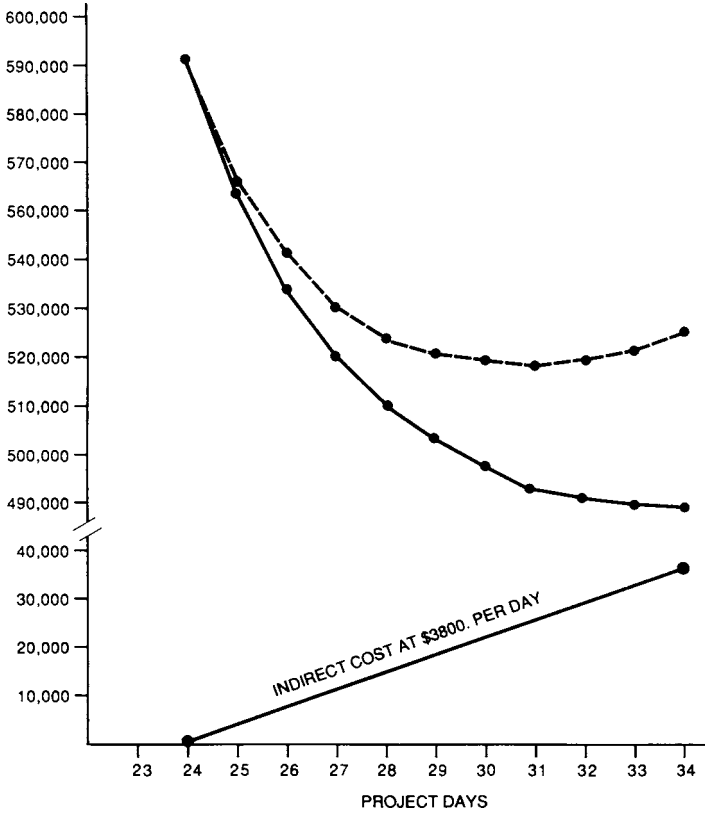

Figure 23.5.2 Combined direct and indirect cost curves for John Doe project.

TABLE 23.5.1 Summary of Crashing up to 10 Days

Expedited day	Expedited activities	Construction costs, \$
	Normal time	489,250
1.	Drill well	490,250
2.	Connect piping	491,250
3.	Survey	493,750
4.	Drill well/water tank foundations	497,750
5.	Rough grade	502,750
6.	Clear	508,750
7.	Erect tank/drill well	519,750
8.	Same activities as for day 7 plus excavate sewer	533,375
9.	Tank piping/drill well/excavate sewer	562,000
10.	Same activities as for day 9	590,625

required to make the assignments). The third problem (not being able to put a project on partial overtime) cannot be completely overcome. However, when there is a choice, expedite in early activities, such as surveying and clearing, when the number of people involved in the project is lower. Usually, the lower costs of expediting those areas will direct the computer solution to the same areas anyway. However, the fourth barrier (the lack of a program for a currently viable computer) is significant, and it will remain so until solved. The calculation is not suitable for the manual mode.

Inventory planning, as calculated by industrial engineers, offers an inspiration in regard to an expedited approach. For a given category of material, equipment, or spares there is a minimum amount of each item which must be kept in stock. There is also some larger amount which can be purchased at a lower price. When the costs for the items in a category (such as pump impellers) are summarized, a curve similar to the direct cost curve is achieved, which indicates that it costs more per unit to purchase fewer units at a time. Now the indirect costs of handling one item can be added in. It will be a linear relation of capital costs, including the costs for the warehouse staff, utilities, accounting, inventories, and so on. When the indirect costs are combined with the direct cost curve, a minimum cost point can be estimated for the category and eventually, by extension, for the entire inventory. This is demonstrated in Figure 23.5.3.

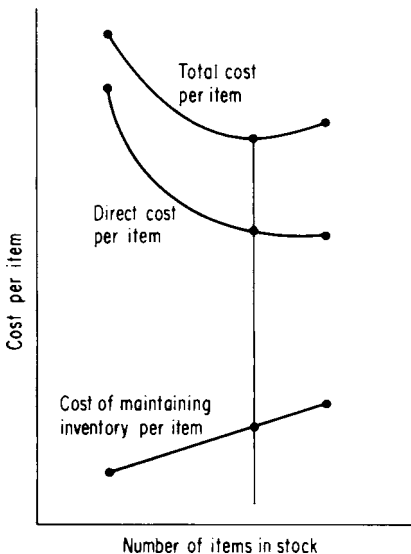

**Figure 23.5.3** Example of inventory optimization.



### 23.6. Summary

A cost breakdown of the CPM network is best done by activity and best carried out immediately after the award of the contract. The cost breakdown should be within the framework of the bid, and it must be realistic. An important use of the activity cost breakdown is making progress payments.

Cash requirements of the project can be forecast on a time basis by computer with the use of the CPM cost estimates. The forecasts can guide owners in investing the construction funds to realize the highest yield and contractors in determining their financial needs and methods.

The cost of expediting a project can be accurately estimated by using a CPM-based cost system. There are even cases in which a project can be completed early at a lower cost through carefully directed expediting.

The promise of cost expediting has not been fully realized, principally because existing cost collection and accounting systems do not relate directly to construction activities.

*This page intentionally left blank*

---

Part

# 5

## The Practice of CPM Scheduling

*This page intentionally left blank*

## Let's Look Under the Hood at the Engine

Primavera Systems former flagship Primavera Project Planner or P3, until the time it was supplanted by Primavera's P3e/c product, was retailing at \$4000 while both Primavera's SureTrak and Microsoft's Project 98 were retailing at \$400. Despite the variance in cost, the additional features of P3 are mostly related to multiproject applications and large company or remote site interconnectability. The screen configurations, formats, and even click or keystrokes, are much the same for SureTrak as for the more expensive P3 software, and most if not all of the screen-based tabular and graphic reporting features are offered in the lower-priced package.

Therefore, comparisons between Primavera Project Planner P3 and Microsoft Project are not "apples to oranges" or "high cost to low cost" alternatives, but could be made equally between the similar cost SureTrak and Microsoft Project. Similarly, since the primary focus of this text is on the "engine" that performs calculations with only a secondary consideration of graphic capabilities and tertiary concern for database compatibility with "the accounting department," all of the products reviewed may be considered on an equal basis. Thus, this "tutorial" in navigating through screens for the P3 and P3e/c products should be viewed as the general manner in which such programs are organized, with the understanding that competing products or even next year's release of this software may have small differences.

### 24.1. Primavera Project Planner P3

Upon initiating Primavera, the user is given the choice to start a New project or Open an existing project. Following Windows' standards, users may also choose from a list of most recently accessed projects. The default

number of recently opened projects is four, but this may be changed by modifying the P3.INI file in the main \WINDOWS subdirectory. However, this modification process is not automated and erroneous modification may cause serious problems (Figures 24.1.1 through 24.1.3).

Opening an existing project by the Open command presents a list of all projects on the default PROJECTS subdirectory for point and click choosing. Most users do not go further than the default subdirectory. For those who may wish to store their projects elsewhere, perhaps in a separate subdirectory for each project (along with other project specific files), the user may choose to change subdirectories or even drives. However, summarization across projects is limited to projects stored in a common subdirectory.

A limitation is that each project (or saved variant or update thereof) must be represented by a 4-character abbreviation or code. A usage tip is to use only three of these characters to identify the project, reserving the last for variants and updates. Thus for the John Doe Project, the baseline or initial schedule is DOE0, with updates being saved as DOE1, DOE2, . . . , DOE9, DOEA, DOEB, . . . , DOEZ. If more than 36 updates are required, it is probable that some of the earlier updates may be deleted from disk or saved (in compressed format) to another area of the disk. The “retired” suffix numbers may then be reused.

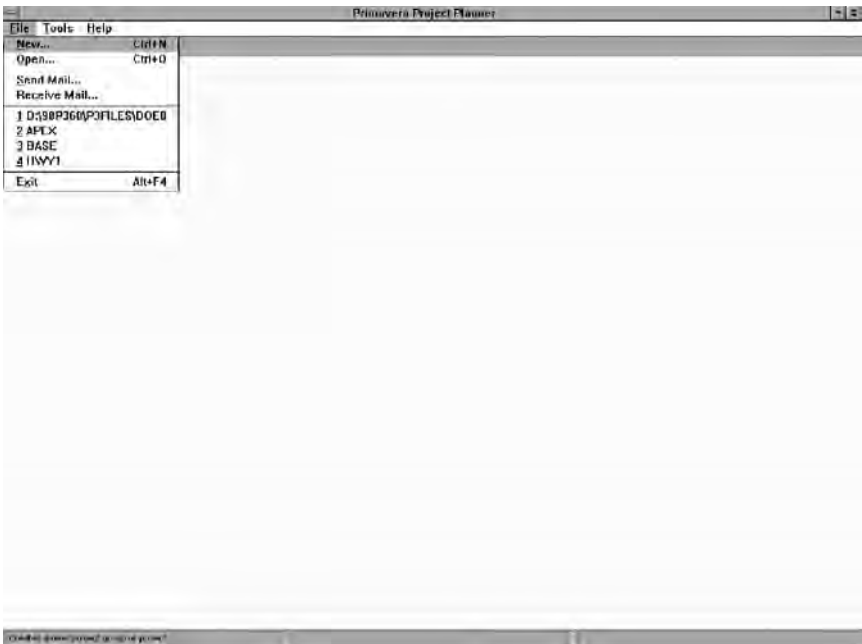

Figure 24.1.1 Primavera opening screen.

**Add a New Project**

Current directory: c:\p3win\projects

Project name:

Number/Version:

Project title:

Company name:

---

Planning unit:   Project start:

Workdays/week:   Project must finish by:

Week starts on:   Decimal places:

---

Add this new project to a project group

Project group:   Project ID:

Figure 24.1.2 Primavera add a new project screen.

Primavera Project Planner - [DOE0]

File Edit View Insert Format Tools Data Window Help

17 OCT 98 Sat

	Total	Float
0	0	0
1	0	0
2	0	0
3	0	0
4	0	0
5	0	0
6	0	0
7	0	0
8	0	0
9	0	0
10	0	0
11	0	0
12	0	0
13	0	0
14	0	0
15	0	0
16	0	0
17	0	0
18	0	0
19	0	0
20	0	0
21	0	0
22	0	0
23	0	0
24	0	0
25	0	0
26	0	0
27	0	0
28	0	0
29	0	0
30	0	0
31	0	0
32	0	0
33	0	0
34	0	0
35	0	0
36	0	0
37	0	0
38	0	0
39	0	0
40	0	0
41	0	0
42	0	0
43	0	0
44	0	0
45	0	0
46	0	0
47	0	0
48	0	0
49	0	0
50	0	0
51	0	0
52	0	0
53	0	0
54	0	0
55	0	0
56	0	0
57	0	0
58	0	0
59	0	0
60	0	0
61	0	0
62	0	0
63	0	0
64	0	0
65	0	0
66	0	0
67	0	0
68	0	0
69	0	0
70	0	0
71	0	0
72	0	0
73	0	0
74	0	0
75	0	0
76	0	0
77	0	0
78	0	0
79	0	0
80	0	0
81	0	0
82	0	0
83	0	0
84	0	0
85	0	0
86	0	0
87	0	0
88	0	0
89	0	0
90	0	0
91	0	0
92	0	0
93	0	0
94	0	0
95	0	0
96	0	0
97	0	0
98	0	0
99	0	0
100	0	0

Open this project 11 days left in critical No float/critical

Figure 24.1.3 Primavera quick open an existing project screen.

As noted in Chapter 9 Primavera Project Planner software allows two means to designate a mandated completion date (FNLТ) for a project. Entering such a deadline in this opening screen, or in the Overview screen, will impose such date for float calculations and, if the date is greater than that calculated for the early completion of the project, the software may calculate a positive total float for activities on the critical path. If the FNLТ field in the OVERVIEW screen is left blank, but the same FNLТ constraint is entered for the ending activity in the network, the software will calculate a total float of zero for activities on the critical path (Figures 24.1.4 and 24.1.5).

After highlighting a specific project, the user may choose to view an Overview of the project, which details more complete data on the project name, mandated project start and finish dates, number of activities, and other project information. This screen is similar to that used to initiate a new project. The Open dialog box also allows the user to set restrictions on Access so that other project members may be permitted to view but are restricted from changing the schedule. Although multiple users may view the network simultaneously and even make changes to their respective sections simultaneously, the limitations of the database utilized requires that only one user have access if the unique

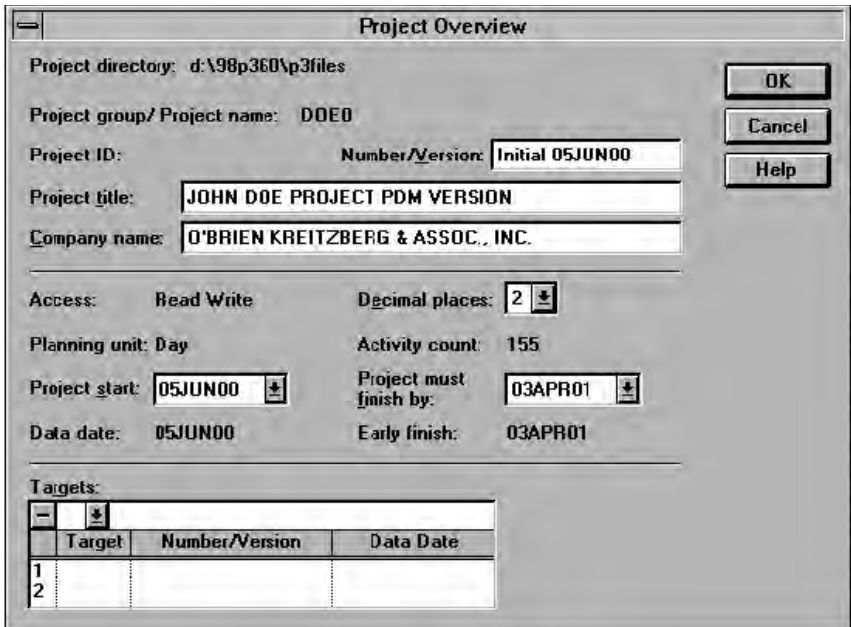

**Figure 24.1.4** Setting a project finish date will cause a project completing earlier to show a positive, non-zero total float for the critical path.



Constraints	
<input type="checkbox"/> <b>E</b> arly constraint <input type="radio"/> <b>S</b> tart <input type="radio"/> <b>F</b> inish	<input checked="" type="checkbox"/> <b>L</b> ate constraint <input type="radio"/> <b>S</b> tart <input checked="" type="radio"/> <b>F</b> inish <input type="text" value="03APR01"/>
<input type="checkbox"/> <b>S</b> tart <b>o</b> n	<input type="checkbox"/> <b>M</b> andatory <input type="radio"/> <b>S</b> tart <input type="radio"/> <b>F</b> inish
<input type="checkbox"/> <b>E</b> xpected <b>f</b> inish	
<input type="checkbox"/> <b>F</b> loat <b>c</b> onstraint <input type="radio"/> <b>Z</b> ero total float <input type="radio"/> <b>Z</b> ero free float	<b>Leveling:</b> <input type="text" value="Normal"/>

**Figure 24.1.5** Setting a FNLT constraint upon the last activity will cause a project completing earlier to show a zero total float critical path.

activity number for a specified activity is to be changed. If the user desires this capability, he or she must click the **E**xclusive box in the dialog box. This **E**xclusive checkoff box also may be chosen within the Project Overview screen (Figure 24.1.6).

The default opening screen for a new project is a combination tabular entry sheet (or spreadsheet) and bar chart template meant to display activities as entered. This is somewhat unfortunate insofar as this is not the easiest format for entering new data. However, the user may then choose the screen format (or **V**iew **L**ayout) of his or her choice, which may be customized to the user's desires.

When opening an existing project, the opening screen is in the format of the layout in effect when the project was last accessed. (Primavera provides the option of not saving the layout when exiting. In this case, the last layout saved will be the new opening screen.)

The default opening screen is shown in Figure 24.1.7. Following Microsoft standards, the top line, or **T**ITLE **B**AR, reflects the software in use (Primavera Project Planner) and the 4-character project code. The second line, or **M**ENU **B**AR, includes the main menu headings, which may be accessed either by point and click or by <ALT> plus the underlined letter

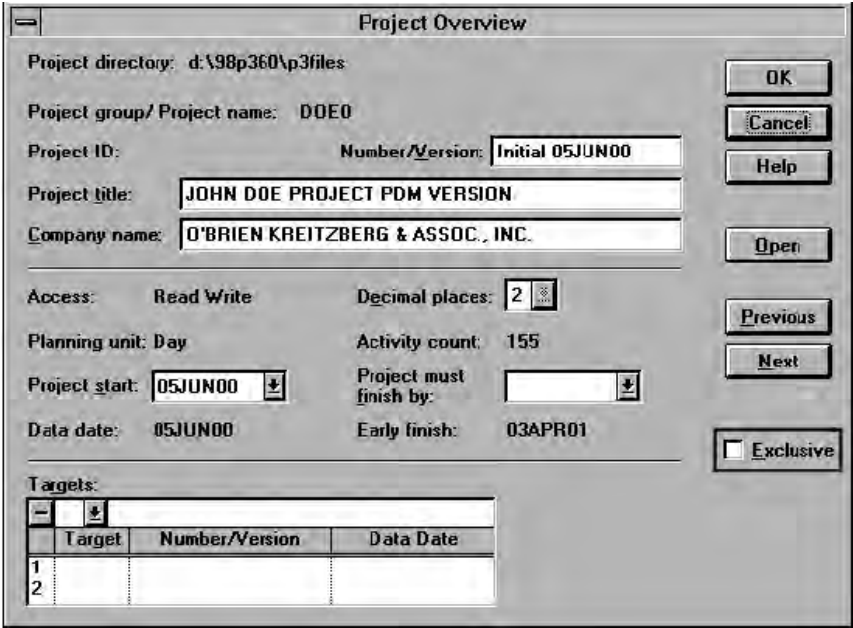

Figure 24.1.6 Checking the exclusive box permits changing Activity IDs.

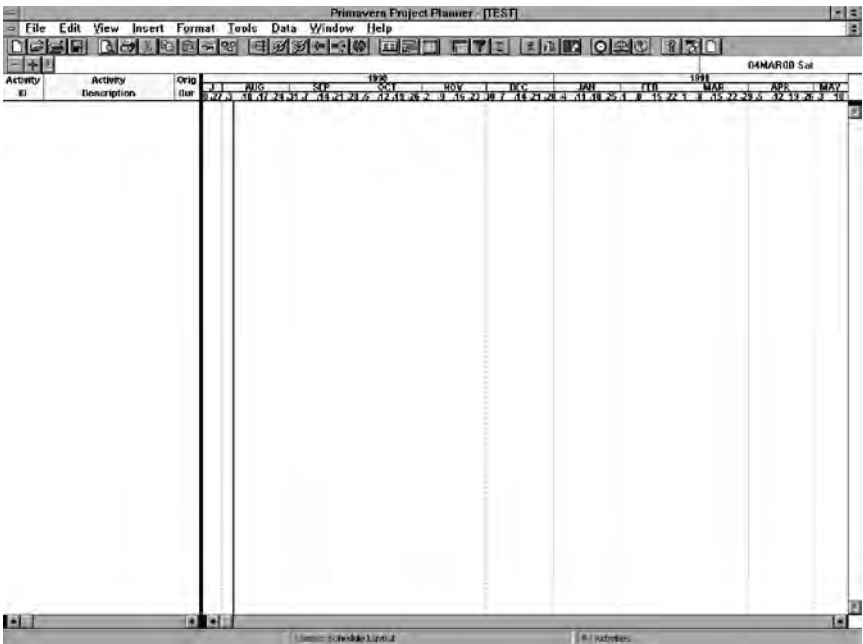

Figure 24.1.7 Opening screen for a new project.

of the menu. In addition, for many of those menu selections, which may only be located by moving down multiple menus, Primavera provides a third means of access, a <CONTROL> plus designated hot key. Several of the hot keys are also assigned to the FUNCTION keys. Unfortunately, the assignment of hot keys does not appear to be intuitive and may require frequent use to be remembered (Figure 24.1.8).

The third line, again following Microsoft standards, is the toolbar. This toolbar may be customized by the user. As with other Microsoft and Microsoft compliant software, the icons of the tools are often difficult to recognize, much less understand. However, resting the mouse pointer over any icon for a moment will generate a small description below that icon. One failing of Primavera is that the “?” icon, usually reserved for context sensitive help, instead brings up Primavera’s standard help screen.

Below this third line is then presented a choice of the combination tabular and bar chart layout noted above or a pure logic format (improperly using the acronym PERT) for review of activity data and relationships.

Finally, at the bottom is a status line, split into three segments, which notes what the computer is doing, the name of the layout being used, and the name of the filter (or selection criteria) being used.

Primavera programmers spent a great deal of effort adding features to the bar chart view. Additional columns of data may be added to the

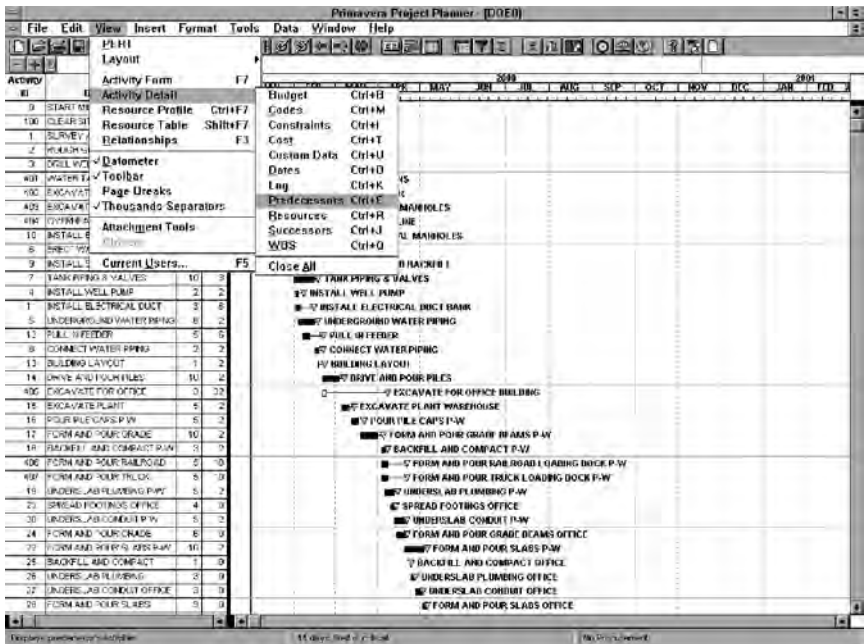

Figure 24.1.8 Point and Click versus <ALT> keys versus <CTRL> hot keys.

spreadsheet half, adjusting the portion reserved for the bar chart accordingly. Individual columns may be customized for type of data, width of column and size, and font of the text. The scale of the bar chart may be modified and two separate periods may be shown at once by splitting the bar chart portion in two. Similarly, if a large number of activities are in the project, the layout may be split vertically in two to permit showing two portions of the list of activities simultaneously. The size and font of the text may be modified and the color, size, and shape of bars and end points may be modified by the user (Figures 24.1.9 and 24.1.10).

The user controls these several options by use of the **Format** menu selections, **C**olumns, **B**ars, **S**ummary Bars, **T**imescale, **S**ight Lines, **R**ow Height, and **S**creen Colors.

The pure logic (or PERT) view also has several customizable options. These include the size and data to be included in the Activity Boxes, and color and type of line for showing relationships. A special feature is the Trace Logic view. This feature, accessible through the **V**iew menu, allows showing any activity and its immediate predecessors and successors in a family tree format through one or more “generations.” Unfortunately, this feature is not available in the bar chart view in Version 2.0 but is available in the 3.0 and P3e versions released in 1999 (Figure 24.1.11).

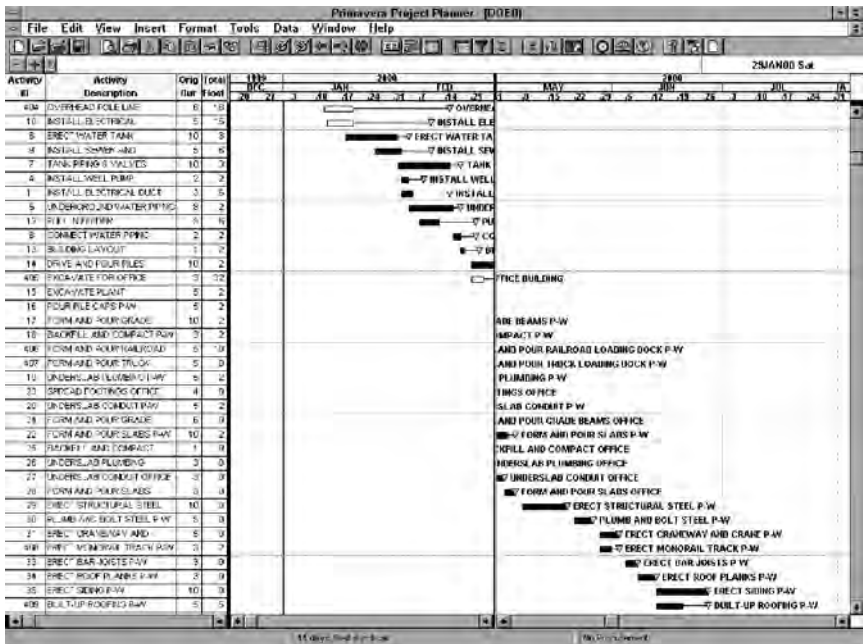

Figure 24.1.9 Bar chart portion of screen split vertically.

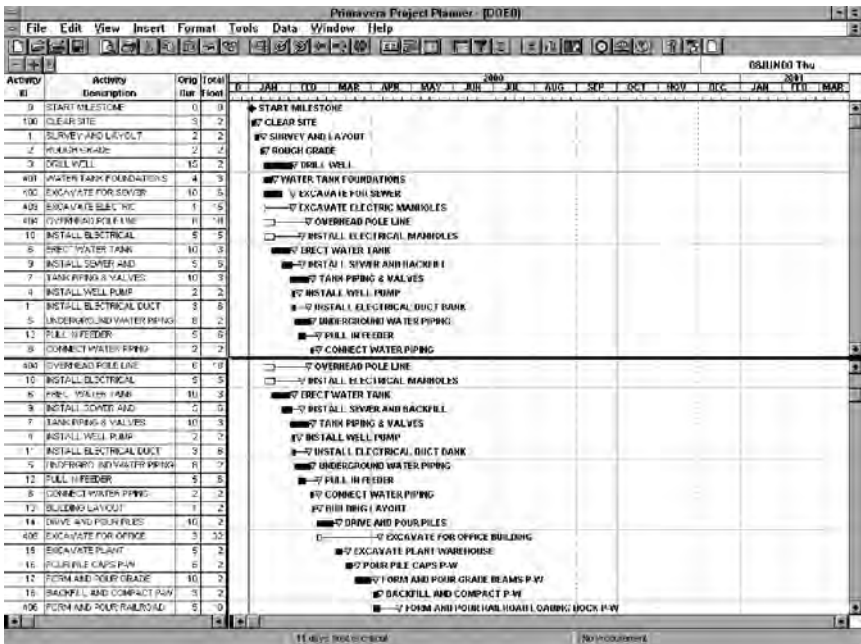

Figure 24.1.10 Bar chart portion of screen split horizontally.

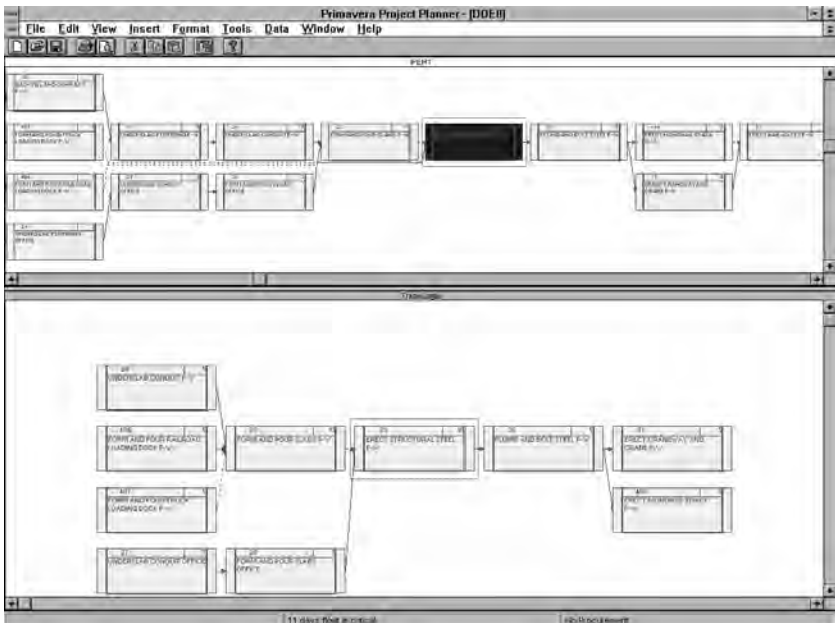

Figure 24.1.11 Pure logic or “PERT” view of network with Primavera’s trace logic highlighted, with two generations shown.

## 24.2. Project and Activity Codes for Organizing Project Data

One of the strongest features of Primavera Project Planner is its capability of organizing, summarizing, and depicting project data in a myriad of ways. Version 2.0 permits 64 characters for unrestricted coding, plus it permits the use of the activity identifier (an additional 10 characters) for additional coding. Common codes fields assigned are for responsibility, area of the project, and type of work to be performed. Other codes used by this author include subcontractor, nominal crew size and composition or type, and the drawing number of the engineer's plans that most clearly depicts the work included in this activity.

These code fields are extremely useful for sorting, filtering, and further explaining the scope of the activity. A common error by many new users of this software is to reduce the number of usable codes by failure to properly abbreviate the coded information. Thus, for Responsibility, one user may use "Owner," "Civil," and "Electrical." Another may properly use "O," "C," and "E," while defining such codes in the activity code dictionary. In the first case, 10 characters of the 64 available are used to define responsibility, in the second, only 1.

As noted in Chapter 9, choosing the coding structure is extremely important. In the event that the users' organization desires to summarize details over several projects (for example, concrete pours) a common company-wide coding structure must be in place. A shortcoming of Primavera is that the program looks to the position and not the title of the code field when summarizing across projects. Thus the user should place common codes, such as subcontractor, near the top of the activity code list, while codes customized by the individual project manager, such as area of the site, should be near the end of the list. If a company wishes a report on all work by a specific subcontractor, the software selects on, for example, positions 2 and 3 in the 64 character code field rather than codes fields titled "SUBC."

Although both Primavera personnel and practitioners extol the importance of determining the code fields prior to entering data, Primavera Project Planner defaults to entry of activity data upon specifying a new project. After escaping from the activity data entry field, access to creating the new project activity code structure and dictionary may be had through the Data menu, choosing Activity Codes.

Other important data to be entered at this time includes Calendars, WBS coding, Resources, and Custom Data Items. Custom Data Items allows up to eight additional coding fields (either in character, numeric, or date formats) for display, but limited sorting and no summarization capability.

A common error of new or infrequent practitioners is to over rely upon coding placed into the activity identifier (ID). The primary purpose of

the activity ID, it should always be remembered, is to designate a unique activity. Subsequent referral of the activity in the field will often be by this activity ID, and data entry for updates will require keying such ID. If the ID is too long or complicated (mixing letters and numbers, for example), errors in transcription or a disinclination for use by field forces may result. This author typically uses numeric IDs only, reserving the first one or two digits for the sheet number of multiple-sheet, hand-drafted pure logic network diagrams. The “0” or “00” or blank sheet number is reserved for submittals and procurement activities.

A further practical restriction on the use of coding within the activity ID, is Primavera’s reservation of two of the ten character spaces for designating subprojects. These two characters are automatically placed at the front of the activity ID and a code field “SUBP” is created in the activity ID code dictionary. (As “SUBP” is thus a reserved code name by Primavera, the user should not use the same code name elsewhere even if not using subprojects.)

While most practitioners do not have the need to break their projects into subprojects, the use of more than eight of the ten characters available for the activity identifier should be discouraged. A second use for these two reserved spaces may be for merging of multiple projects. Accessible through the Tools, Project Utilities, Merge menu selection, this option creates a new “superproject,” which may include as many of the user’s projects as desired. This is accomplished without affecting the original individual projects and is useful for “rolling-up” resource usage across projects.

To assure uniqueness of activity identifiers during the merging process, Primavera must add a “project identifier” to the existing activity ID. These additional characters may be placed at the front or end of the remaining characters available for unique activity designation. Reserving one character for this purpose effectively limits the organization to 26 projects, while reserving two should suffice for all but the largest organizations.

### 24.3. Entering Data

Primavera has three internal methods of entering activity data and also accepts data imported from a separate spreadsheet or database program. The first method, called by Primavera the Barchart method, uses the combination tabular entry sheet (or spreadsheet) and bar chart template. After entering the first activity identifier and establishing a desired coding structure, the user should format a desired entry layout by clicking or keying Format, Columns or keying the function F11 key and creating a tabular layout desired. Data columns that may be desirable include Activity ID, Activity Description, Original Duration, user

defined codes, user defined custom data items, and (up to one) resource and cost field. A useful feature is that the user-assigned column width need not be sufficient to display the entire data item, so that multiple log entries (each formatted to display only 10 characters) may fit on one line or row. Unfortunately, inclusion of even one successor activity ID is not an option using this method.

After determining the data columns desired, move the split line between the tabular and bar chart portions of the layout to display as many columns as desired. Data may then be entered directly in a spreadsheet-style method with some minor caveats. The first is that, by default, in moving the cursor to a new row, Primavera will automatically create a new activity ID, sequenced a user defined increment, and move the cursor to the second column of the layout. This “assistance” can be shut off by clicking or keying Tools, Options, Activity Inserting and then clicking off the Automatically Number Activities box. The second is that once an activity ID has been entered, it cannot be changed unless the user has checked the Exclusive box in the Open New Project or Overview dialog box as described earlier in this chapter.

As noted previously, this method does not include assigning relationship links between the various activities. To accomplish this, the user must either click or key View, Activity Detail, Successor (and Predecessor) or key <Control> plus J (and <Control> plus E) to bring up the Successor and Predecessor detail entry boxes. These can be moved on the screen to appropriate locations. Data entry will now require flipping between the main screen and the Successor detail entry box. Another means of relationship link entry is via the bar chart half of the layout screen, where the user may click and link the activities shown on the screen. However, other than for the smallest of networks, this can become tedious.

This problem can be partially alleviated by use of Primavera’s Autolink function. By choosing this function, via clicking or keying Insert, Autolink, or keying <Control> plus L (toggling on/off), each new activity is linked with a finish to start relationship from the last entered activity. Where this creates an improper relationship, or where multiple links are required, such may be addressed using the Predecessor and Successor data entry boxes.

The second method, called by Primavera the PERT method, uses the pure logic network diagram format of Primavera. Here the user clicks a location for a new activity after clicking or keying Insert, Activity or keying <INS> and move the new activity box to a location desired, or merely double click at the desired location for the new activity. This then brings up Primavera’s Activity Form, which via a combination of point and click and typing, may be filled in for the activity ID (remembering to deactivate automatic numbering), activity description, and codes.



Additional data entry boxes, for successors, resources, costs, custom data items, constraints, logs, and so forth, may be called from this Activity Form and be moved around the screen to accommodate data entry. Relationship links may be made by using the Autolink function, Predecessor and Successor data entry boxes, or by point and click dragging logic connection lines between boxes.

The third method, called by Primavera the Activity Form method, similarly enters data using the Activity Form from the combination tabular/bar chart layout. Here the user must first click or key Tools, Options, Activity Inserting, and “Use activity form when inserting an activity.” Then for each new activity, key the {down arrow} key, add the new activity in the Activity Form box and click OK, or key <ENTER>.

#### **24.4. Debugging and Diagnostic Tools: Improving the Logic Network**

To err is human, and errors in data entry are a fact of life in any data-intensive system. Primavera, as well as its competitors, is fairly good at providing context sensitive error trapping. If a user attempts to enter an activity ID as its own successor or predecessor, Primavera will refuse to accept such input. If a user attempts to enter an activity ID that does not currently exist as a successor or predecessor, Primavera will notify the user and prompt the user for a title or activity definition for such new activity. However, if a logic link is incorrectly made to a legitimate activity ID, or if a desired link is missing, such an error will not be caught by the software. To address these types of errors, Primavera has various diagnostic reports, which are some of its most sterling features.

One such diagnostic report is generated each time the user schedules the project. A word must be noted here related to the process of scheduling a project. Primavera does not schedule on the fly. In other words, if a user changes a duration or constraint, the individual bar representing the activity may be elongated, shortened, or moved, but other activities impacted by that activity will remain unaffected until the user specifies a desire to reschedule the project. Many other software products do reschedule on the fly, including Primavera's Suretrak software. However, as Primavera Project Planner or P3 projects are typically larger, the delays for recalculation required for each change may be significant, even with the most powerful hardware. Thus the user may make several changes (for example during an update process) and then reschedule once.

A downside of this discretionary rescheduling process is that parties receiving printed Primavera reports may find it necessary to rerun such reports as a check. If a project is scheduled, showing an acceptable end date, then the user changes the durations of activities, but does not

reschedule, printed reports will report the new durations alongside the previously calculated dates. On the other hand, this feature has an upside when merging multiple projects which may have been updated on differing dates. Although Primavera will prompt the user to reschedule before printing “roll-up” reports, such need not be done, giving greater flexibility to the individual project managers as to update frequency while permitting company-wide “roll-ups.”

Returning to the Primavera diagnostic report, such a report is generated each time the project is scheduled. A project may be scheduled by one of three actions, clicking the “clock” icon, clicking or keying Tools, Schedule, or by keying the function F9 key. In the first two cases, the report will be either printed or sent to the screen, in the third case, it is still generated but is by default saved to file c:\p3win\p3out\p3.out. The diagnostic report starts by noting the name of the registered user of the software currently being used, its serial number (required to obtain technical help from Primavera), and the 4-character project designation.

The second section lists artificial constraints. As these may override the calculated logic, they should be carefully reviewed by all users and recipients of the CPM. Also listed here are any activities designated as milestones, flags, or hammock activities.

The third section lists open ends. As noted previously, a project usually should have but one starting activity and one ending activity. If more than one of each is listed, these should be checked to determine if a data entry error has occurred.

The fourth section becomes useful after the project is underway and being updated. It lists activities that have been started or completed “out-of-sequence” or before their predecessors have been completed. When an activity is reported being performed “out-of-sequence,” the reason for such should be investigated. Either the original logic was wrong, or field conditions permitted an informal change to the logic, or more seriously, the work reported not complete in the predecessor or reported started in the noted activity is not part of the intended definition of the predecessor or activity. Finally, the predecessor activity may be complete but such was missed during the update process.

The fifth section lists the various options used for calculation, such as how floats are calculated, whether “out-of-sequence” work is handled by “retained logic” or is totally cut from the logic with “progress override,” whether activities must be continuous or may be interrupted by finish-to-finish restraints, and other calculation options.

The sixth and final section lists statistics on the network including the number of activities, number of critical activities, the number of activities started and/or completed, percent complete, the number of logic restraints in the network, the start date, data date for the most recent update, and the latest calculated early finish.

In the event a loop is detected (“activity A follows activity B which follows activity A”), the second section is a loop report, which is sent to the screen. In such a case other sections are not generated until the loop is corrected and the project rescheduled.

Other useful diagnostic tools include the standard Schedule Report including Predecessors and Successors. (By default, such is generated by keying Tools, Tabular Reports, Schedule, choosing SR-06, and keying Run.) This report lists each activity as well as its predecessors and successors and can be modified by the user to include constraints and resource information.

## 24.5. Viewing Output

This author has always advocated that the most important aspect of project controls is the preparation of the pure logic network of the CPM. If at that point no further calculations were performed and the entire CPM and all notes for its creation were destroyed, the project personnel who participated in its development would still have acquired 90 percent of the value that the CPM can provide. But now that the effort has been expended, how can that additional 10 percent of value be achieved?

The extra value of preparing a CPM, that portion which is best assisted by today's modern personal computers, is conveying the information within the CPM to various members of the project team in a variety of views tailored to highlight all aspects and inferences of the information collected. The ability to display the information in various levels of detail with summarization in an almost unlimited number of viewpoints is a hallmark of Primavera's software.

## 24.6. On-screen Formats

The combination tabular and bar chart layout, which is the default opening screen of Primavera, is highly useful for various levels of the management team who wish to acquire information about the project. By choosing appropriate data fields suited to the needs of the viewer for the tabular half of the screen, and careful tailoring of information to be conveyed by the bar chart half, the user can convey a great deal of knowledge without having such lost in irrelevant (to the particular end user) data. For example, at the beginning of the project, remaining durations (RD) will equal original durations (OD) and percent completes (PCT) will be uniformly zero. If some degree of crew leveling has been included in the initial schedule, late dates (*LS* and *LF*) will be irrelevant, although the reviewer may wish to know the amount of total float (*TF*) to afford the degree of importance of meeting individual activity target dates. Once the grand logic has been reviewed and approved,

users of the CPM will care to focus upon activities for which they are responsible, or which may have an immediate impact upon them. Finally, the end user may wish to focus upon those activities that are coming up in the near future as opposed to those several months away. A sample report prepared for such a user may be produced on screen (and then may be printed directly from screen for further distribution), as shown in Figures 24.6.1 and 24.6.2.

To obtain such a report, the user need only key or click a few instructions. First, click or key **F**ormat, **C**olumns or key the **F11** key. Using the John Doe project located on the enclosed CD (file “JDOE”) or a project of the user’s choosing, click or key to Column information. Click “Remaining duration” and then the “-” box or key <DEL>. The highlighter will automatically move to the next field, “Percent complete” and the user may again click the “-” box or key <DEL>. Click the field “Resource” and the “+” box, then the “{down arrow}” box and scroll to and click “Total Float” then repeat for “Free Float.” Click OK.

Click on the bar between the tabular and bar chart halves, and move the bar to the right to display all relevant columns. Next, right click (using the right button on the mouse) on the calendar bar on the bar

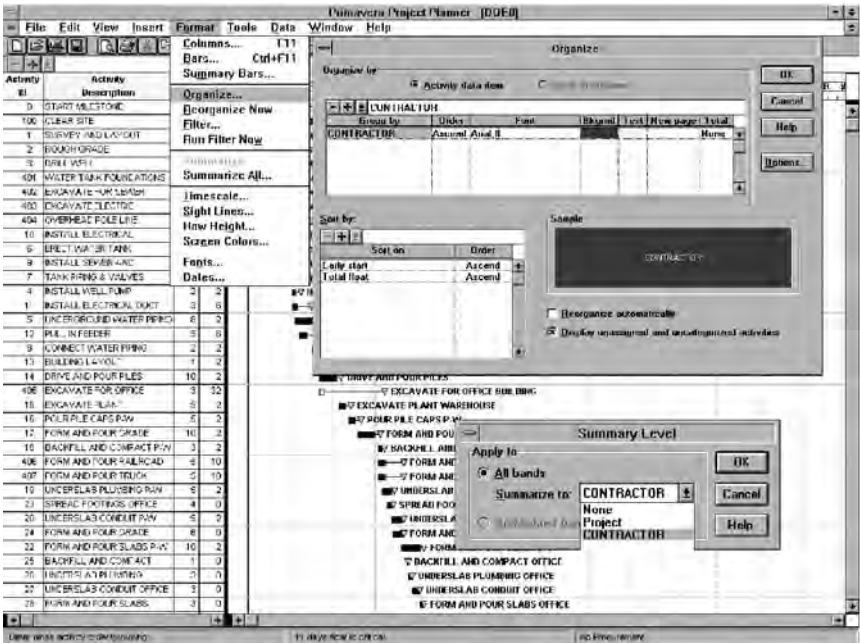

Figure 24.6.1 Sample mixed summary and detail screen from point and click exercise, setup.

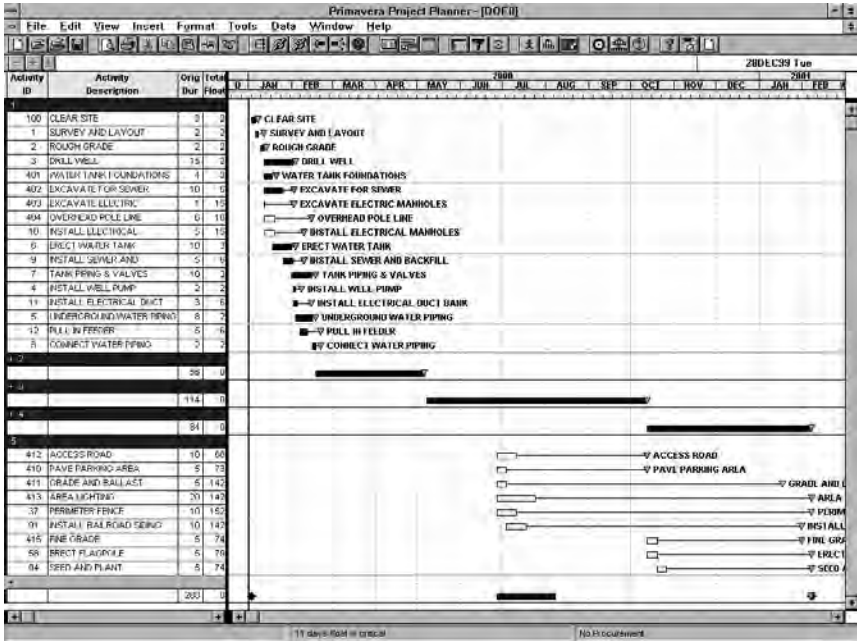

Figure 24.6.2 Sample mixed summary and detail screen from point and click exercise, results.

chart half. Left click on the Density button and slide to the left until September of 2001 is visible. Click OK. In this case, the entire John Doe project is now viewable by scrolling down the screen. Finally, to reduce screen clutter, key Format, Bars or key <Control> F11, and click off the box calling for the “Float Bar” to be “Visible.” Click “Close.”

Next, assuming we are interested in only contractor number 5. Click or key Format, Filter, Add, “OK,” then the “+” button, the {down key underlined} box, scroll to “CONTRACTOR” and click, click the “Is” column and key “EQ,” click the “Low Value” column and key “5” (space then “5”) and again click “OK,” then click “OK” yet again, and then click “Yes.” The user now has a detail schedule for the paving and landscape subcontractor.

Next, to show the general relation of all subcontractors, key Format, Filter, “All,” “OK,” “Yes,” then key Format, Organize, the “+” button in the “Organize by” section, the {down key underlined} box, scroll to “CONTRACTOR” and click, and click “OK.” Each contractor may now view his individual tasks. Click or key View, Relationships, or the function F3 key or click the pitchfork icon to show the relationships

between activities. Note that critical relationships are highlighted with red lines, non-critical but driving relationships with solid black lines, and non-driving relationships with dashed black lines.

Next click or key Format, Summarize All, Summarize To, the {down key underlined} box, scroll to “CONTRACTOR” and click, and “OK.” Double clicking on any of the summary bars will now toggle showing detail for that one contractor. The power of CPM is in the preparation of the logic. The power of software is in the variety of presentation options it may provide.

### 24.7. Viewing Output: Tabular Formats

Primavera provides a number of standard reports for review of the initial schedule and for subsequent project monitoring. These are accessed through Tools, Tabular Reports, and then from a list including Schedule, Resource, Cost, and various custom report styles. A standard report that should be reviewed at the start of each project is Primavera’s default report SR-06 listing each activity, its predecessors and its successors (Figures 24.7.1 and 24.7.2).

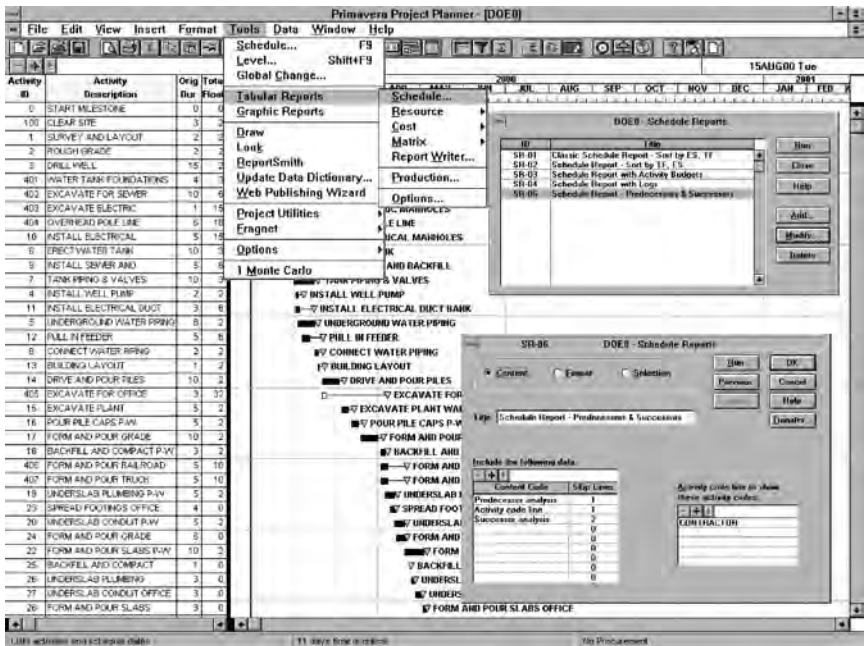

Figure 24.7.1 Standard report SR-06 setup screens.

Primavera Look - (Untitled-Sheet 1 of 17)

File Edit View Window Help

O'ELLEN KREITBERG & ASSOC., INC. PRIMavera PROJECT PLANNER 300M DOS PROJECT P1M VERSION

REPORT DATE: 7AUG99 RUN NO. 8 CPM IN CONSTRUCTION MANAGEMENT - 5TH EDITION START DATE 17AUG99 FIN DATE 7FEB01

Schedule Report - Parameters & Successors DATA DATE 17AUG99 PAGE NO 13

ACTIVITY ID	ORG	SWS	S	CODE	ACTIVITY DESCRIPTION	EARLY START	EARLY FINISH	LATE START	LATE FINISH	TOTAL FLOAT
		P.L.D.F.,*		40.FE	0. 10. 33,	41.FE	0. 5. 43			
		P.L.D.F.,*		395.FE	0. 9. 70,					
47	4	S	0	0	LEGAT ODS NUMBER AND TEST	27AUG99	28AUG99	06CT00	12OCT00	31
		S.L.D.F.,*		50.FE	0. 5. 79,	39.FE	0. 5. 43			
		S.L.D.F.,*		415.FE	0. 5. 74,					
		P.L.D.F.,*		46.FE	0. 25. 13,					
52	15	1F	0	7	INSULATE HEATING AND VENTILATING SYSTEM P-W	58E900	253E00	223E00	15OCT00	11
		S.L.D.F.,*		50.FE	0. 5. 79,	39.FE	0. 5. 43			
		S.L.D.F.,*		415.FE	0. 5. 74,					
		S.L.D.F.,*		53.FE	0. 10. 18,					
57	10	10	0	3	INSTALL FURNISHINGS P-W	58E900	183E00	293E00	12OCT00	16
		S.L.D.F.,*		58.FE	0. 5. 79,	39.FE	0. 5. 43			
		S.L.D.F.,*		415.FE	0. 5. 74,					
		S.L.D.F.,*		49.FE	0. 15. 0,					
60	5	E	0	3	INSTALL PANEL INTERNALS P-W	72E900	1A3E00	7A3E00	13A3E00	0
		S.L.D.F.,*		54.FE	0. 10. 0,					
		P.L.D.F.,*		50.FE	0. 5. 0,					
64	10	10	0	3	TERMINATE WIRE P-W	149E900	272E900	149E900	272E900	0

Lang: C, Cui: 1

Figure 24.7.2 Sample page from standard report SR-06.

## 24.8. Viewing Output: Graphical Formats

Primavera also provides a number of standard graphical formats, customizable by the user. A series of bar chart formats largely duplicates the WYSIWYG tabular and bar chart layout, which is the default opening screen. However, as the computer code for these bar chart views were written prior to Primavera's migration to a Windows platform, there are differences. One report worth reviewing is the summary bar chart with detail provided (Figures 24.8.1 through 24.8.3).

Various resource and cost reports in graphical format are also largely duplicative of the newer Windows screen reports. The main set of graphics not otherwise available is of the Timescale logic (Figures 24.8.4 and 24.8.5).

One important caveat in preparing any of the graphic reports in Primavera is to set the printing or plotting device prior to preparing the graphic. This is accomplished by File, Print Setup, Specific Printer. Failure to do this before preparing the graphic will limit the smallest text font on the graphic to that which is readable on the screen or on a 8 1/2 x 11 sheet of paper.

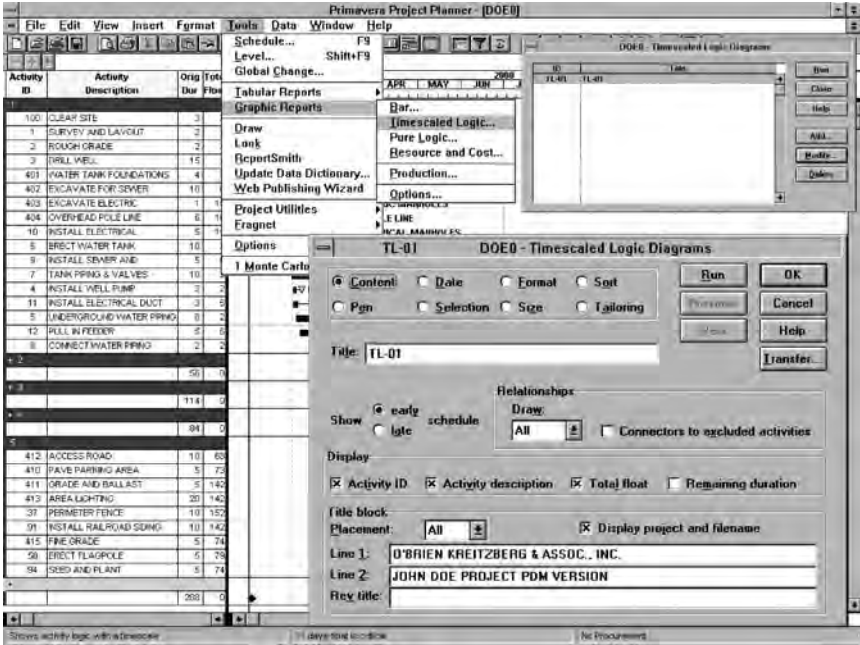

Figure 24.8.1 Summary bar chart with detail provided, setup and dialog boxes.

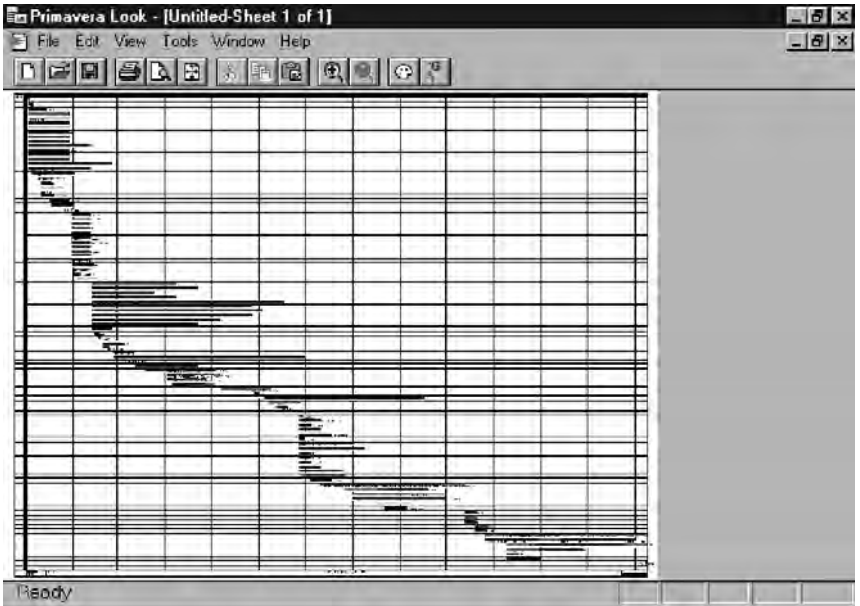

Figure 24.8.2 Summary bar chart with detail provided.



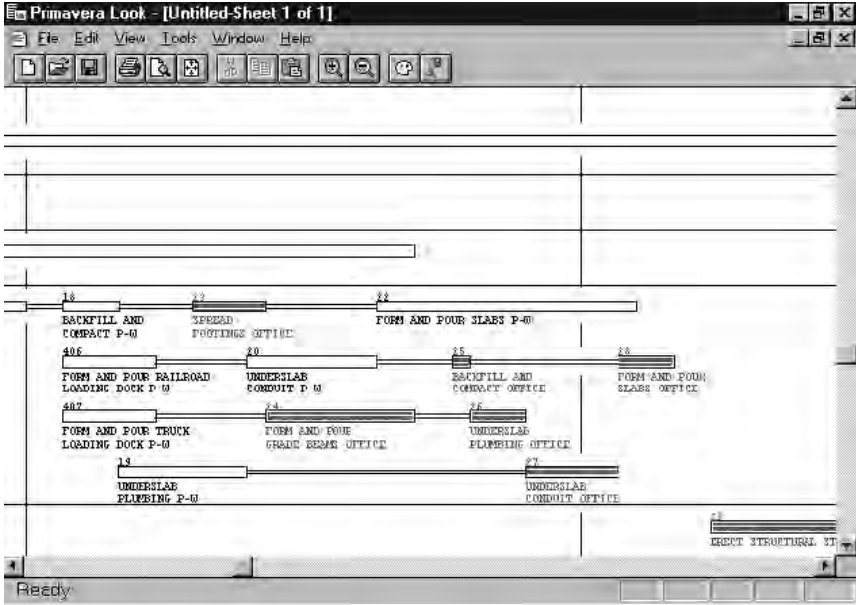

Figure 24.8.3 Blowup of section of summary bar chart with detail provided.

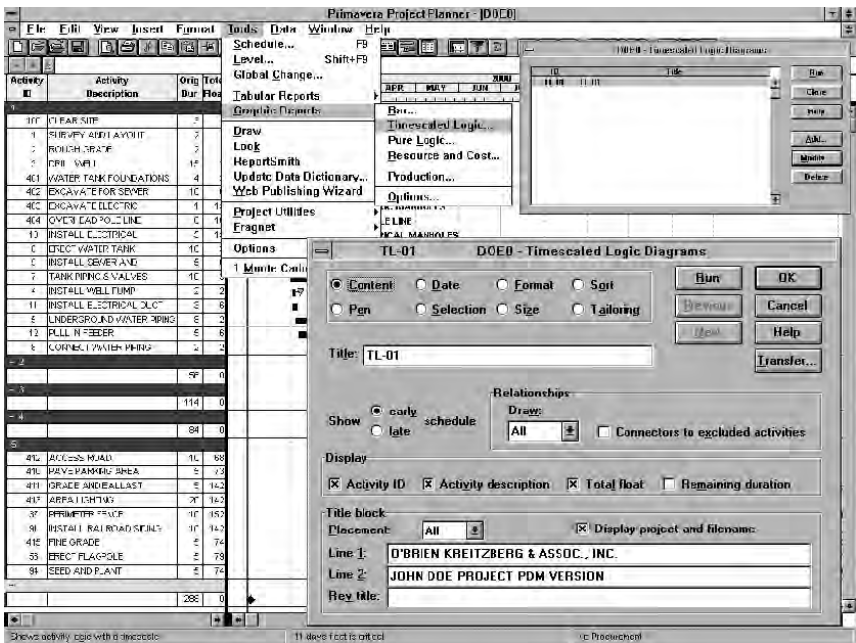

Figure 24.8.4 Timescale logic graphic report, setup.

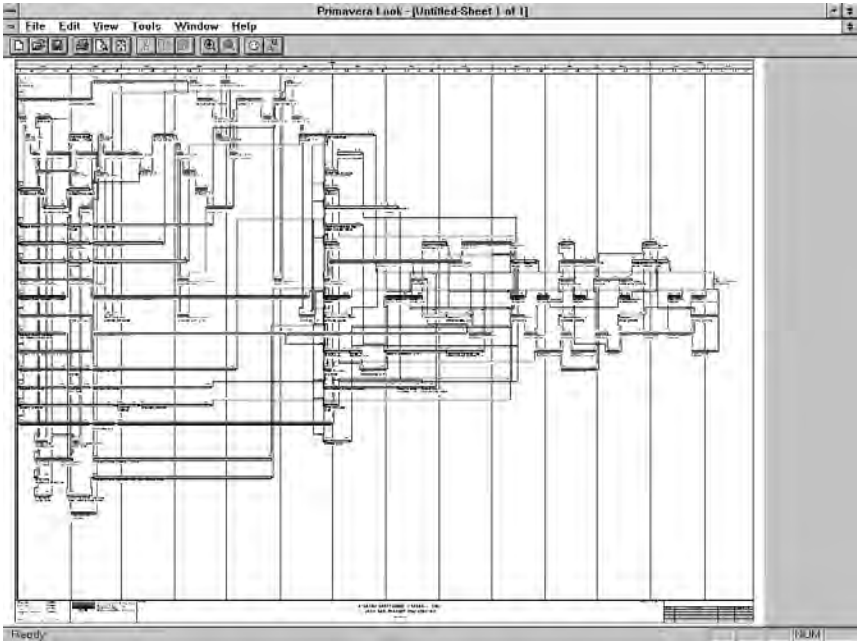

Figure 24.8.5 Timescale logic graphic report, results.

## 24.9. Entering Update Data

Primavera is forgiving in most of its demands upon users to follow proper procedure in preparing or updating a schedule. Failure to properly tie all activities to designated ending activities will not preclude calculation. (Such a condition will be reported in the diagnostics, however.) But Primavera insists that activities that started are given an actual start date and activities that are complete must be given an actual finish date. Failure to provide an actual finish date will result in activities that are reported 100 percent complete and have zero remaining duration to be displayed as having an incomplete portion thereof remaining to be performed on the data date.

In most cases, this creates merely a problem of display. However, if two activities are connected by a relationship with a lag, a more serious problem can occur. In the case of a start-to-start relationship with a lag, the default algorithm is to decrementing the lag from the reported actual start date. If no date is given, the entire lag will be included in schedule calculations even if 90 percent of the activity is reported complete. If neither an actual start nor actual finish date are given for an activity reported 100 percent complete with zero remaining duration, the software will still require the entire lag duration from the data date of

the update until the activity restrained by that relationship may begin. Therefore, the project manager who desires a quick update, with actual dates to be provided later, is required to manually reduce each lag when attempting such a “quick” update.

This problem is exacerbated in SureTrak, which does not make allowances for activities started but not completed, even if an actual start date is given. If an activity is reported as complete (with actual start and actual finish dates), the lag will zero out. Otherwise, activities in progress require manual updating of the remaining lag of each relationship as well as the remaining duration of the activity. If the activity has been started out-of-sequence, the problem is made even worse, with the start of the entire lag deferred until the calculated early start of the remaining portion of the work. To provide compatibility between systems, Primavera permits use of the SureTrak algorithm, by keying Tools, Schedule, Options, and Early Start to the dialog question “Calculate Start-to-Start lags from.”

#### 24.10. Primavera Project Manager: P3e/c

This tour through the P3/SureTrak class of software has been meant to be illustrative rather than a tutorial. In 2004, Primavera Software Systems retired these two products that are still supported (for the 350,000 licensed users worldwide) but are no longer sold. However, the general class of instructions, screens, menus and architecture of these products are indicative of how other software products by Primavera and its competitors are designed. The release of P3e/c 5.0, coincident with the publication of this Sixth Edition, includes features not previously available and modifications to the screens and menus of prior releases. Indubitably, next year there will be a release 5.1 that has further changes and within the next few years there will be another major change to a release 6.0 or even to another brand new flagship product. Similar to the experience of the past, it may be expected to go through several new generations before there is the need to again update this text to a Seventh Edition. Therefore, having provided a tour of general steps for one class of software (as well as a working copy on the enclosed CD for purposes of familiarization and practice exercises,) we leave to the practitioner to read the user manual and utilize the tutorial of the software product *de jour*.

However, before leaving this chapter, the administrative steps required of the Primavera’s new flagship P3e/c (and thus of other software vendors that do have a tendency to copy each other) should be addressed. The old model was based upon the primacy of a project manager (using Primavera Project Manager P3) who was to work independently upon a personal computer. The new model is based upon the

hierarchy of projects within an organization, sharing organizational resources amongst many project managers who report to a program manager. The allocation of these scarce resources, as well as real time tracking of production, are under the oversight of this program manager as all team members (using Primavera Program Manager P3e/c) work together on laptops and desktop computers tied via the internet to the main organization database in the home office.

We have learned that before launching a new project logic network, it is important to determine all the players involved with a project and to set up the code fields necessary for the systematic collection of information on each activity so that we can provide the necessary filters, grouping and sorting of output information for these many audiences. As we go to organizational reporting – considering the needs of the managers of the asphalt batch plant and heavy equipment yard as well as the manager of each individual project, there is a little more setting-up exercises required before we start drafting out the pure logic network. These are best illustrated by the new opening screens for the starting of a new project under P3e/c.

The first step in designing the codes data that will be collected while planning a project mimics the process of opening a new project in the software. The first step is to choose an organization, the program manager of which will be overlooking the project manager for this project (Figure 24.10.1). In the real world, this means it is a good idea to determine to whom the project manager will report before choosing a coding structure to meet this person's preferred style of report. (Of course, in the construction world, there are usually two EPS's to consider – that of the owner and that of the contractor.)

If the new project will be supervised by other than one of the existing programs, it will be necessary to add a new program to the Enterprise Project Structure before adding the new project. This will be added initially below the last project already in the system, but may



Figure 24.10.1 Opening P3e/c screen to add a new project.



Figure 24.10.2 Adding and placing a new Enterprise.

then be moved to a location of choice upon the menu of programs and projects as well as elevating or decrementing the level in the hierarchy as shown in Figure 24.10.2.

At this point the user can finally name the project and assign a project ID – fortunately with more than four characters since, with one common database rather than separate subdirectories for each project, each project manager cannot name his baseline schedule “BASE (Figure 24.10.3).” Unfortunately, this may require some level of organization-wide coordination, if for example, PennDOT has two highway projects on I-80 at different ends of the state under separate district engineers but all under one Secretary of Transportation. The two projects cannot both be named “I80 Baseline,” nor can that name be reused in a few years for the next section unless the first project has been totally purged from the database.

Six screens later, after assigning end dates, the responsible manager, resource rate types and choosing whether to use a Wizard to plan the whole project “on the fly,” the user now has added a new project to the project directory and may then add activities to the new project. At this point, after opening the program manager and choosing “Projects,” the user can scroll down to open the desired project. (See Figure 24.10.4)

Having expended the effort just to add a new project does have a payback. While the older P3 software had a limit of 20 activity codes sharing a maximum of 64 characters, the newer P3e/c allows up to 500 codes (of an unlimited number of characters) for each project and an unlimited number of codes shared between projects at the global level. In addition, it is now possible to sort or select within a code, for example for a code running from 0 to 99 choosing all the activities coded in the 20s.



Figure 24.10.3 Process of adding a new project to the database.



Figure 24.10.4 Opening the Program Manager and choosing a project.

The difference between global and project level codes is important to recognize. Many projects may share resources such as heavy equipment and other support facilities. Many projects may share a stable of subcontractors. Many projects may use a common specification coding structure. These are therefore candidates for global codes.

However, locations are usually specific to one project. In preparing the code dictionary for a highway project, station numbers may be used for locations, for a building the coding may be by floor. The drop-down menu for choice of location on a highway project should not normally include "5th floor." With all of this additional power does come the requirement to properly set up the codes and code dictionaries. (See Figures 24.10.5 and 24.10.6.)

The concept of global codes for standardization amongst projects can be very useful so long as all projects within the group have some commonality. P3e/c version 5.0 recognizes this issue and has therefore added an intermediate "global" coding capability for projects sharing the same EPS code. (See Figure 24.10.7) This intermediate level of "global" coding is essential for any consultant or other user who may have multiple clients, each of whom may have their own "global" codes.

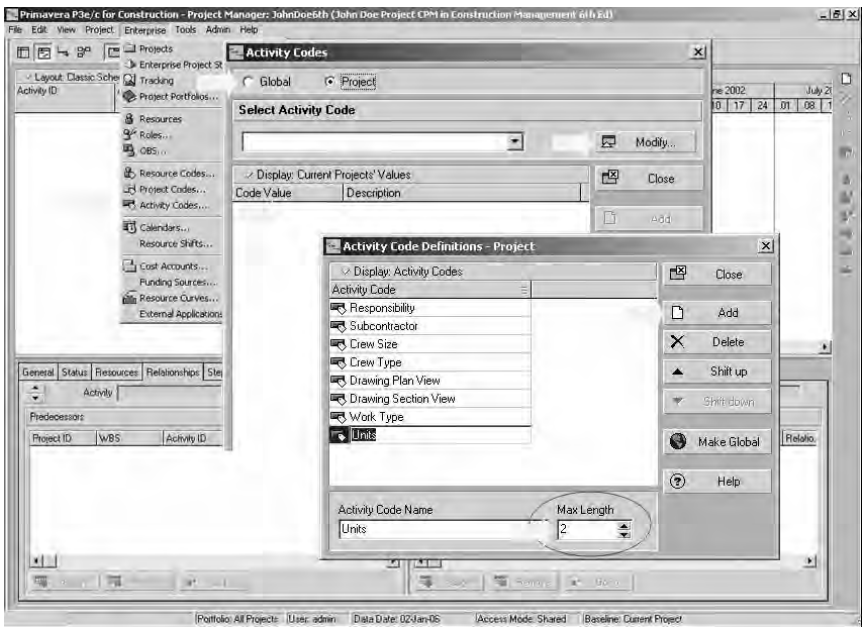

Figure 24.10.5 Selecting global or project level codes.

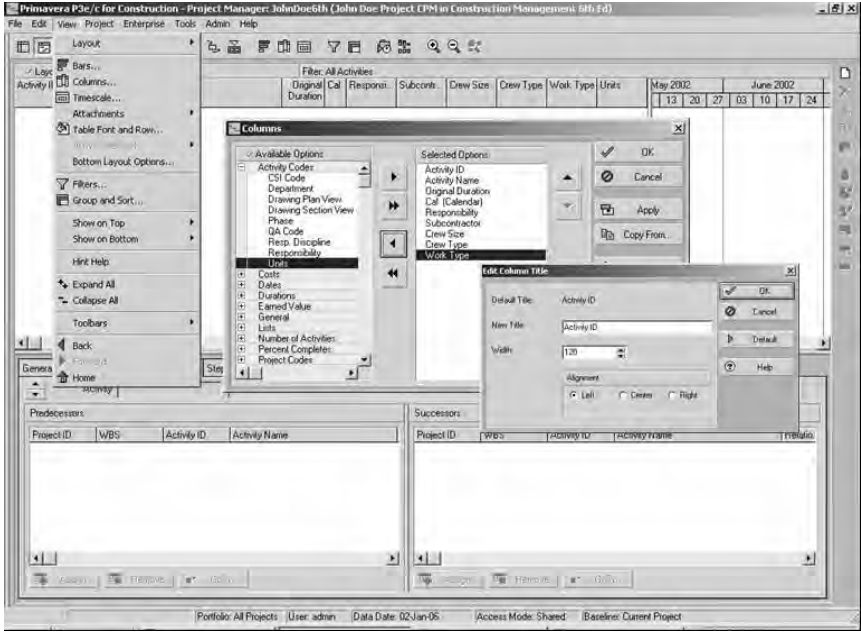

Figure 24.10.6 Including codes in the tabular layout.

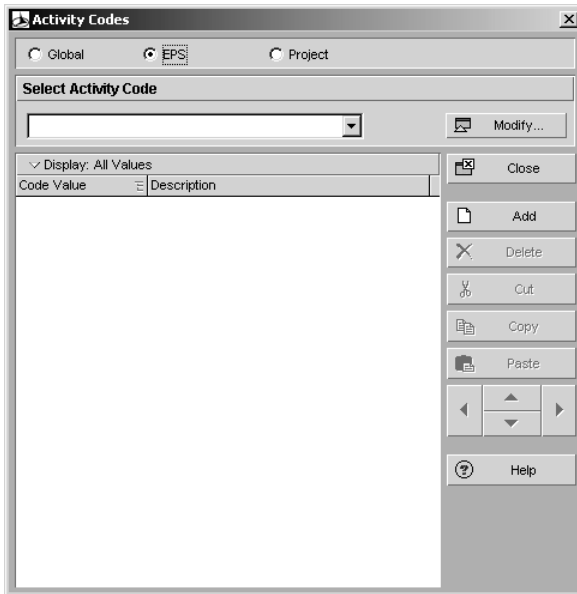

Figure 24.10.7 Three levels of codes.



### 24.11. Summary

As can be seen from this cursory review of only one software product, the implementation of various options with regard to each of the extensions of the traditional, simple ADM model are fraught with the danger of accidental or intentional misuse. The marketplace has demanded of high-end systems a level of power that requires study, care, and integrity in its use. Conversely, the marketplace requires simplicity in application of powerful and often only partly understood tools. The software products available today, struggle to provide that which is desired by the marketplace, often of a higher complexity than understood by the user.

*This page intentionally left blank*

## Converting the Team Plan to the Calculated Schedule

The project team has met and a pure logic network model of the contractor's "plan of execution" has been prepared. This process may have been spread over several (preferably contiguous) days and may have involved anywhere from 3 days (24 contact hours) for a complex \$10 million wastewater treatment plant to 5 days (40 contact hours) for a relatively repetitive \$100 million highway project. Now the Scheduler is left with getting the plan information into the computer, getting the first rough draft of the schedule out of the computer, meeting with the project team for one more day to resolve any issues, and then preparing reports that will help the project manager and the entire team get the project out on time and under budget.

### 25.1. Data Entry Made Easy

The first step is to open a new project and define the activity codes that have been recorded during the interview process. As previously discussed, it is generally recommended to not enter a "project must finish by" date in the opening screen, but rather to assign a FNLT constraint to the activity or milestone representing substantial completion of the work. Figures 25.1.1 and 25.1.2 depict the screen shots for adding a new project and establishing activity codes in P3.

Next, set the columns for easy entry of the activity and code information collected. If the little extra time is taken to populate acceptable values for each code, entry can possibly be made easier. This spreadsheet style of entry may be far easier than entering only the activity ID, description, and duration, and then having to go back to enter code information on a detail screen for each activity.

**Add a New Project**

Current folder: d:\00p396 Browse...

---

Project name: CCM6

Number/Version: Data Entry

Project title: CPM in Construction Management 6th

Company name: O'Brien & Plotnick

---

Planning unit: Day Project start: 02JAN06

Workdays/week: 5 Project must finish by:

Week starts on: Monday Decimal places: 2

---

Add this new project to a project group

Project group: Project ID:

Add Cancel Help

**Figure 25.1.1** Opening a new project in P3.

Entry of relationships is a little more difficult and may require use of the mouse as well as the keyboard to navigate between the main screen and predecessor or successor dialog boxes. In P3, there is a handy feature to create a finish-to-start restraint (without lag) for each newly entered activity from the last activity entered. Keying the Autolink option of the Insert menu, as shown in Figure 25.1.3, sets this feature. In the event that a different relationship is desired, such may be accomplished by editing within the appropriate dialog box. A similar layout may be created in P3e/c, as shown in Figure 25.1.4.

## 25.2. Check and Set Schedule Algorithm Options

At this point, the plan has been recorded and transposed to the software for calculation. One last step is required, setting the proper algorithm for the software. In SureTrak, the number of options are few, that is, the choice of retained logic or progress override and whether open ends are critical or not. Since the initial schedule will not include progress, the choice of retained logic or progress override is irrelevant. However, it is a good idea to make this decision now, prior to submitting the CPM and running updates. The choice regarding open ends is more important since making such not critical is in effect revising the logic that was

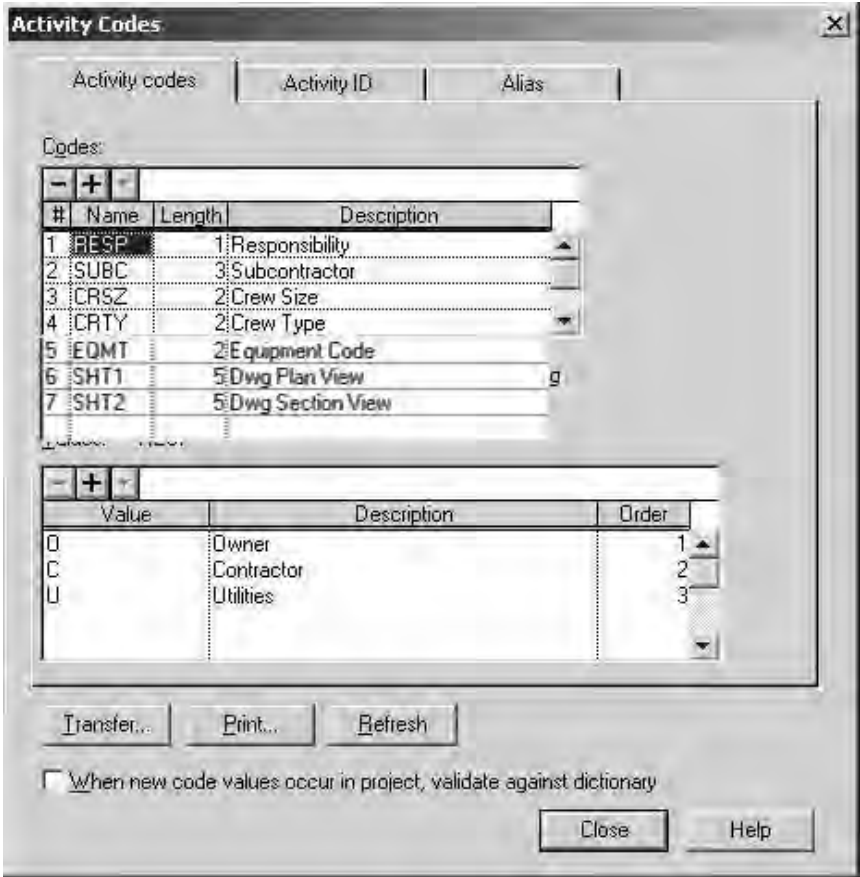

Figure 25.1.2 Adding activity codes in P3.

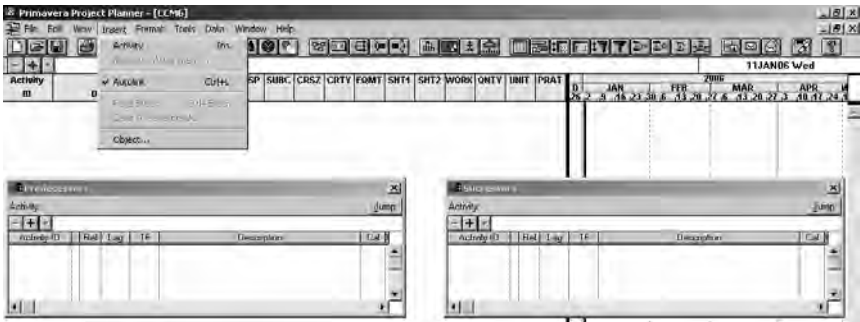

Figure 25.1.3 Autolink.

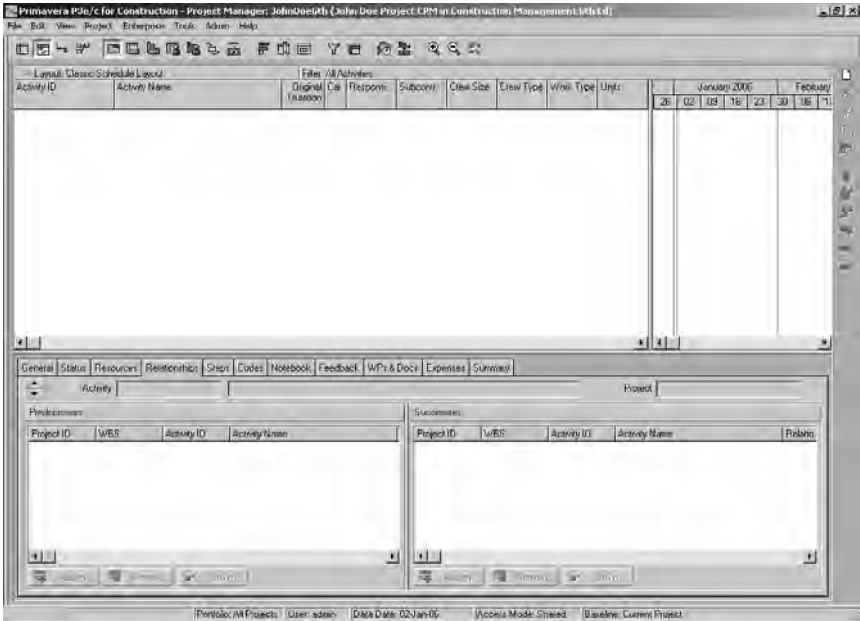

Figure 25.1.4 P3e/c Predecessor and Successor detail.

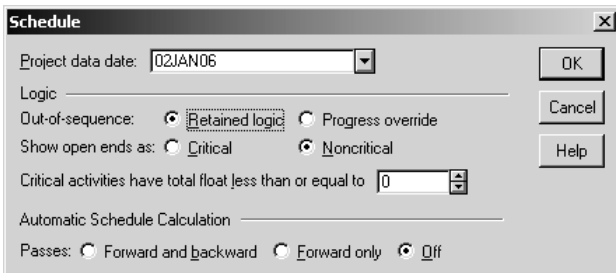

Figure 25.2.1 Setting scheduling options in Suretrak.

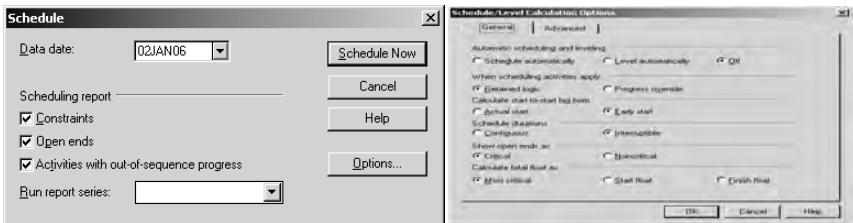

Figure 25.2.2 Setting scheduling options in P3.

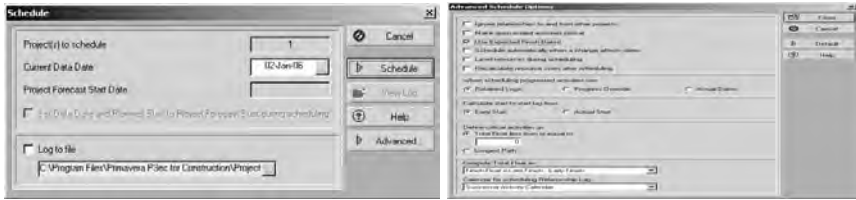

Figure 25.2.3 Setting schedule options in P3e/c.

entered. Finally, setting the float to be declared critical only impacts the graphic output, that is, whether an activity bar on the Gantt chart is red or some other color. (See Figure 25.2.1.)

In P3, the choices are increased to also include the algorithm for calculating lag when an activity has been started, determining if scheduling durations are contiguous or interruptible and determining what will be reported as the total float for each activity. As noted previously, the initial schedule does not have progress, thus the choice of actual or early start for calculating lag is irrelevant, but it is still a good idea to make this decision before submitting the CPM to the owner. The choice of contiguous or interruptible will impact the early start date of an activity whenever it is driven by a finish-to-finish restraint. The choice to report total float as either  $LF - EF$  or  $LS - ES$  or the more critical of the two calculations will also have to be made at this time. (See Figure 25.2.2.)

In P3e/c, the options are different. Added options include the choice whether to include or not include relationships to other projects in the calculation, whether to use or ignore expected finish constraints in determining remaining durations of affected activities, and choosing which calendar will be used for lag durations between activities. The choice of interruptible duration is not supported, probably as this schedule concern conflicts with P3e/c's strong linkage between schedules, resources, and costs. (see Figure 25.2.3.)

### 25.3. First Run and De-bugging the Logic

Regardless of the care taken in data acquisition and entry, the first attempt to run the schedule may result in the uncovering of various errors. Perhaps these will be of a technical nature, such as a logical loop. Or they may be of a situational nature, such as performance of seasonal work out-of-season.

A logical loop may be due to an entry error, and solvable by the Scheduler. Or there may truly be a misunderstanding or dispute amongst the project team members. It is even possible that the loop originates with the contract documents, as in the example in Chapter 4.

```

Primavera Scheduling and Leveling Calculations -- Scheduling Report Page: 1
This Primavera software is registered to EnProMaC.
Start of schedule for project TEST.
Serial number...16660017
User name FRED .

Loop report -- Scheduling Report Page: 3
Loop # Activity Description
-----
1 A1000 first activity
  A1010 second activity
  A1020 third activity
  A1000
    
```

Figure 25.4.1 P3 diagnostic report of a loop.

### 25.4. Loop Detection and Correction

Most software systems have some form of loop detection and reporting. In P3, an attempt to schedule a project containing a loop will result in an error message with details of the loop included in the diagnostic report, as shown in Figure 25.4.1. This is viewed using the view program included with Primavera P3.

P3e/c includes its loop report with the error message, saving the user the trouble of switching to a separate program to read the diagnostic. Often there may be several loops contained within each other and it may require some time to unravel the error. Having the hand-drafted pure logic drawing can be of great assistance in determining how and where to cut the loop and retie the logic. It is important to do this first on the hand-drafted diagram so as to understand the full consequences of such manipulations and not to end up with a network that runs, but provides incorrect information (Figure 25.4.2).

**Erroneous loop detection and work-around.** It was noted in Chapter 11 that many, if not most, software products will report an erroneous report of a loop where a short activity is straddled by a larger activity,

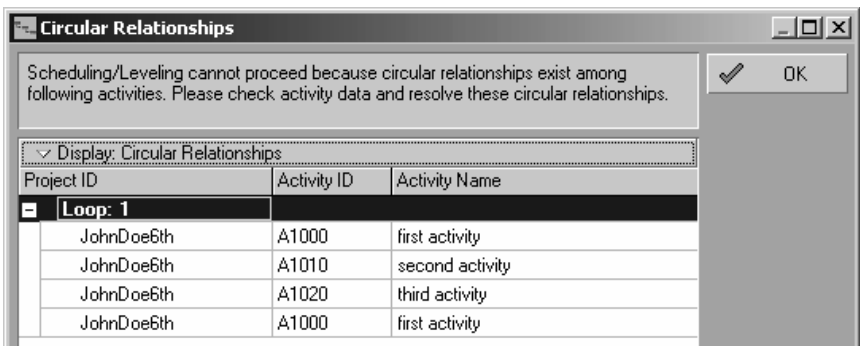
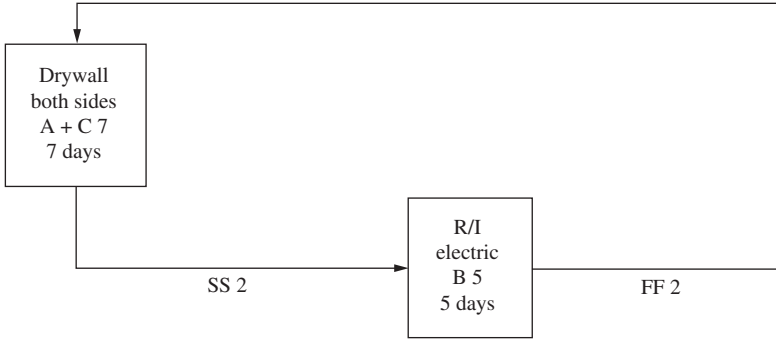

Figure 25.4.2 P3e/c loop error report.





**Figure 25.4.3** Erroneous loop report.

such as in Figure 25.4.3. As previously noted, this type of situation should properly be addressed by combining the short and longer activity into one activity, under the supervision of the drywall foreman, who then directs the electrical foreman where and when to work. The one activity can have both resources assigned to it, and possibly a special code field may be required to alert the electrical superintendent or subcontractor that it is to perform ancillary work around the drywall work. In P3e/c, the use of a “Step,” with its own associated codes, may be of particular use in this situation. Depicting the two tasks as two concurrent activities is not technically correct, but is sometimes the “fudge” used, especially if in-artfully crafted specifications require separate coding or “complete” summary rollups for each craft.

### 25.5. Technical Review: The Primavera Diagnostic Report

The diagnostic provided by Primavera’s P3 software is unsurpassed in the industry. Although the newer flagship P3e/c diagnostic is not quite as good, the newer software has other features that make up for any difference. However, it is hoped that this “oldie but goodie” may be resurrected in a future release of P3e/c.

The P3 diagnostic is made up of seven sections. Each addresses a different concern for the contractor reviewing its first run of the schedule and eventually for the engineer reviewing the final submission of the initial CPM.

**Section 1: honesty.** It is not the intent of the authors of this text to push for the sales of software, nor is it the intention to act as an auxiliary police force for the benefit of the creators and vendors of such software. However, if the software printout notes the serial number and owner of the software license assigned to the copy of the software being used, it

is strongly suggested that any practitioner of project controls verify that a legitimate and properly licensed copy of the software is being used. As has been noted, the Scheduler is in the unique position to truly ascertain the truth of how a project is progressing with respect to time, much like a CPA is in a position to determine the financial status of a project. And with the power that has been provided in modern software programs to override the traditional algorithms and calculations of CPM for special or odd situations, comes the responsibility to use such features truthfully. Most casual users of CPM software are aware that it is possible for a misguided user to “cook the books.” Thus, to a large extent, the weight given to the reports generated by the software is going to be based upon the reputation of the Scheduler who prepared such reports.

```
Primavera Scheduling and Leveling Calculations—Scheduling Report Page: 1
This Primavera software is registered to EnProMaC.
Start of schedule for project 1234.
Serial number...16660017
```

```
User name FRED.
```

**Section 2: constraints.** The use of constraints is shorthand for the proper use of restraints. Thus, for most valid uses of a constraint, it is possible to say the same thing by means of one or more restraints. For example, rather than using a SNET constraint, one may use a restraint with lag from the start of the logic network to the activity to be constrained. Obviously, the chore of counting the number of days for the original duration of this restraint for the initial network and for the remaining duration for each update is something that all parties would want to avoid. Other types of constraint override the mathematics of CPM to some lesser or greater extent and may have a use in special situations where the mathematics of CPM are incapable of modeling the real world. Therefore, the use of constraints should be viewed with some level of skepticism and the user should be prepared to show how a restraint could be used instead or why there is a need to override the mathematics of CPM.

```
Constraint listing -- Scheduling Report Page: 2
Activity   Date           Constraint
-----
99999 30AUG05 Late Finish Constraint
```

**Section 3: open ends.** Classically, each logic network had to start from one node or event and end at one node or event. Many of the earlier computer programs also required that the first node feed only one START activity and the last node be fed from one END activity. However, the real world does call for situations where multiple starting and ending activities are desirable. On the other hand, unless a specific activity is desired to be a starting or ending activity, the inclusion of such open ends announces an error. As activities are added to a network and logic ties

are added and deleted, it is all too possible for such an error to occur. This section of the diagnostic notes all of the open ends for an ADM network or a PDM network restricted to finish-to-start relationships.

The diagnostic does not note open ends of activities succeeded only by start-to-start or preceded only by finish-to-finish activities as noted in Chapter 11. Perhaps this section of the software was written before PDM became popular. Thus there is a need to check for these additional open ends using other tools.

Finally, the equivalent diagnostic from P3e/c (Click Tools Check Project Integrity item numbers 36 and 37) lists activities that do not have a predecessor or successor, but does not include in these lists those activities that have connections to other projects but do not connect to the end of the project in which they reside. Thus, the diagnostic for the advanced software does not catch the type of error that the diagnostic for the older P3 software was designed to report.

```
Open end listing -- Scheduling Report Page: 3
-----
Activity      10 has no predecessors
Activity 76550 has no predecessors
Activity 76590 has no predecessors
Activity 76570 has no successors
Activity 99999 has no successors
```

**Section 4: progress and actual dates.** Section 4 of the diagnostic should be blank for the initial schedule. This section normally notes work that has been completed out-of-sequence and other irregularities relating to reporting data to an update. Since the initial schedule should be based on matters prior to beginning work, no progress should have been reported. Occasionally, a Scheduler may improperly enter the actual date for the start of the project or other actual progress that has occurred prior to completing the initial CPM. Since the initial CPM data date will be start of the project, this type of error is often reported in this section. Remember also when updating that the data date should be at least one day after the latest actual date reported.

**Section 5: choice of algorithm.** Since there may be more than one possible algorithm to calculate the schedule, and each algorithm may calculate a different answer, it is important to document what options have been chosen. It is also useful to note when the calculation was performed.

```
Scheduling Statistics for Project 1234:
Schedule calculation mode - Retained logic
Schedule calculation mode - Interruptible activities
Schedule calculation mode - Make open ends critical
Float calculation mode   - Use more critical float from start
                           or finish dates
SS relationships         - Use early start of predecessor
Schedule run on Mon Aug 01 12:47:26 2005
Run Number 232.
```

**Section 6: statistics.** Section 6 provides a number of statistics on the network and calculated schedule. These include total number of activities and number of activities on the critical path. Obviously, if the percent of critical activities begins to push or exceed the limit set by the Corps of Engineers guideline, there should be some level of concern and perhaps this should be addressed in the narrative. Also, as a general guide to the health of a schedule is the comparison of number of relationships to number of activities. This is generally around 1.6 in a healthy network.

Number of activities.....	873
Number of activities in longest path..	12
Started activities.....	843
Completed activities.....	822
Number of relationships.....	1236
Percent complete.....	97.6
Number of expected finish activities...	2
Number of late constraints.....	1

Obviously, for an initial schedule, there should not be any activities started nor finished. Although constraints have already been addressed in Section 2, the use of such should raise such concern that the diagnostic again notes their inclusion here.

**Section 7: dates.** Finally, in Section 7, we get the “beef,” that is, when is the project expected to be finished based upon a specific start, and how does this compare to the date required by the contract.

Data date.....	01AUG05
Start date.....	01NOV04
Imposed finish date.....	31AUG05
Latest calculated early finish.....	30AUG05

**25.6. Beyond the Primavera Diagnostic**

This text started by noting that planning and scheduling is a field of engineering. The problem of orphaned open ends to the logic network, undetected by even the top diagnostics of P3, does not mean the problem should be ignored. Either the professional must review each activity’s relationships to be assured that each is preceded by a something-to-start restraint and is succeeded by a finish-to-something restraint, or the professional must obtain or write the necessary software to have a computer perform this rote task.

Figure 25.6.1 illustrates the program used for many years by EnProMaC to supplement the P3 diagnostic report. A copy of this program is included also on the diskette accompanying this text. The program is written in dBase programming language, leaving to the student the option to rewrite for use by Microsoft Access or other relational database software.

```
*P3orphan - to locate PDM orphaned activity logic
*prior to running - export activities to actlist.dbf, relationships to pplist.dbf
*file pplist0 is modified with fields atitle and stitle, maybe more
*file actlist0 is extended format "ACT2, pcount..., scount..."
use pplist
copy to temp1
use pplist0
copy stru to pplist
use pplist
appe from temp1
repl all act2 with act
index to pplist on act2
sele 2
use actlist
copy to temp2
copy to temp1 structure extended
use temp1
appe from actlist0
*goto 1
*n=field_type
*m=field_len
*loca for field_name ='ACT2'
*repl field_type with n
*repl field_len with m
use
create actlist from temp1
appe from temp2
repl all act2 with act
index to actlist on act2
sele 1
set rela to act into b
repl all atitle with b->title, aod with b->od && more
set rela to
set index to
repl all act2 with suc
index to pplist on act2
*sele 2
*actlist already indexed on act2
*sele 1
set rela to act2 into b
repl all stitle with b->title, sod with b->od && more
close all
*file pplist is now has all activity data added
*
*
set talk off
*count number of succs for each activity
clear all
use actlist
```

**Figure 25.6.1** P3orphan extended diagnostic software code. This code is available in computer readable form on the CD provided with this book.

```

sele 2
use plist
sele 1
r1=1
do while .not. eof()
  r1=recno()
  nact=act2
  sele 2
    count to ncountSS for act=nact .and. rel='SS'
    count to ncountFS for act=nact .and. rel='FS'
    count to ncountFF for act=nact .and. rel='FF'
    count to ncountSF for act=nact .and. rel='SF'
    count to ncount for act=nact
  sele 1
    goto r1
    repl scountss with ncountss,scountfs with ncountfs,;
      scountff with ncountff,scountsf with ncountsf,scount with ncount
  skip
  if substr(str(recno()),5),5,1)='0'
    disp recno()
  endif
enddo
*
*count number of preds for each activity
1
r1=1
do while .not. eof()
  r1=recno()
  nact=act2
  sele 2
    count to ncountSS for suc=nact .and. rel='SS'
    count to ncountFS for suc=nact .and. rel='FS'
    count to ncountFF for suc=nact .and. rel='FF'
    count to ncountSF for suc=nact .and. rel='SF'
    count to ncount for suc=nact
  sele 1
    goto r1
    repl pcountss with ncountss,pcountfs with ncountfs,;
      pcountff with ncountff,pcountsf with ncountsf,pcount with ncount
  skip
  if substr(str(recno()),5),5,1)='0'
    disp recno()
  endif
enddo
*
set talk on
return

```

Figure 25.6.1 (Continued)

The program combines the information from the activity file and relationship file that may be exported by P3 (or, with modifications, other CPM software) to create an expanded activity file and relationship file. The expanded activity file includes the total number of predecessors (pcount) as well as number of each type of predecessor (*SS*, *FS*, *FF*, and *SF*) and the total number of successors (scount) as well as number of each type of successor. The expanded relationship file includes the title of each predecessor/successor pair and the duration of each. (Figure 25.6.2)

The two files are then linked to prepare an expanded diagnostic report via a second program (diaglist.prg) provided in Figure 25.6.3 The resulting report provides a listing by exception of suspect activity durations and relationships for further review by the Scheduler, or later by the engineer.

This starts with an expanded “open end” report highlighting “open ends” orphaned by misuse of PDM, continues by listing activities with duration greater than 22 days (long durations) and equal to zero days (often signifying a typographical error or missed entry), update reporting errors of showing progress without providing an actual start date or showing completion without providing an actual finish date, and concludes with a listing of relationships where the lag duration between activities exceeds the duration of the predecessor or successor. (Figure 25.6.4)

The diligent student may note that the programs discussed in this subchapter would not catch the open end created by the use of a finish-to-start

Structure for database: actlist.dbf				Structure for database: actlist0.dbf				
Field	Field Name	Type	Width	Field	Field Name	Type	Width	
1	ACT	Character	10	1	FIELD_NAME	Character	10	
2	TITLE	Character	48	2	FIELD_TYPE	Character	1	
3	RESP	Character	1	3	FIELD_LEN	Numeric	3	
4	SUBC	Character	3	4	FIELD_DEC	Numeric	3	
5	CRSZ	Character	2	** Total **			18	
6	CRTY	Character	2					
7	other codes							
20	OD	Numeric	5	Display content of database: actlist0.dbf				
21	RD	Numeric	5	Record#	FIELD_NAME	FIELD_TYPE	FIELD_LEN	FIELD_DEC
22	CAL	Character	3	1	ACT2	C	10	0
23	ES	Date	8	2	PCOUNT	N	2	0
24	ESA	Character	1	3	PCOUNTSS	N	2	0
25	EF	Date	8	4	PCOUNTFS	N	2	0
26	EFA	Character	1	5	PCOUNTFF	N	2	0
27	TF	Numeric	5	6	PCOUNTSF	N	2	0
28	ECON	Character	2	7	SCOUNT	N	2	0
29	ECOND	Date	8	8	SCOUNTSS	N	2	0
30	LCON	Character	2	9	SCOUNTFS	N	2	0
31	LCOND	Date	8	10	SCOUNTFF	N	2	0
32	CON	Character	2	11	SCOUNTSF	N	2	0
33	COND	Date	8					
34	LOG1	Character	48					
35	LOG2	Character	48					
	other logs			Structure for database: plist.dbf				
39	ACT2	Character	10	Structure for database: plist0.dbf				
40	PCOUNT	Numeric	2	Field	Field Name	Type	Width	
41	PCOUNTSS	Numeric	2	1	ACT	Character	10	
42	PCOUNTFS	Numeric	2	2	SUC	Character	10	
43	PCOUNTFF	Numeric	2	3	LAG	Numeric	4	
44	PCOUNTSF	Numeric	2	4	REL	Character	2	
45	SCOUNT	Numeric	2	5	ATITLE	Character	48	
46	SCOUNTSS	Numeric	2	6	AOD	Numeric	5	
47	SCOUNTFS	Numeric	2	7	STITLE	Character	48	
48	SCOUNTFF	Numeric	2	8	SOD	Numeric	5	
49	SCOUNTSF	Numeric	2	9	ACT2	Character	10	
** Total **			472	** Total **			143	

Figure 25.6.2 File structure for relational databases for extended diagnostic software.

```
*diaglist.prg
*program to list all orphaned activities and other suspect activities and relationships
set alte to diaglist
set alte on
use actlist
list off act,title,od,cal,'has no predecessor'          for pcount=0
count for pcount=0
list off act,title,od,cal,'has no START predecessor'    for pcountss+pcountfs=0 .and. pcount#0
count for pcountss+pcountfs=0 .and. pcount#0
list off act,title,od,cal,'has no successor'          for scount=0
count for scount=0
list off act,title,od,cal,'has no FINISH successor'    for scountff+scountfs=0 .and. scount#0
count for scountff+scountfs=0 .and. scount#0
list off act,title,od,cal,'has duration > 22 days'     for OD>22
count for OD>22
list off act,title,od,cal,'has duration = 0 days'     for OD=0
count for OD=0
list off act,title,od,cal,'has RD > OD'                for RD>OD
count for RD>OD
list off act,title,od,cal,'has RD=0 but no AF' for OD#0 .and. RD=0 .and. EFA=' '
count for OD#0 .and. RD=0 .and. EFA=' '
use pslist
list off act,atitle,aod,suc,stitle,sod,rel,lag,'uses SF relationship' for rel='SF'
count for rel='SF'
list off act,atitle,aod,suc,stitle,sod,rel,lag,'LAG > activity duration' for lag>aod
count for lag>aod
list off act,atitle,aod,suc,stitle,sod,rel,lag,'LAG > successor duration' for lag>sod
count for lag>sod
set alte to
return
```

Figure 25.6.3 Diaglist extended diagnostic software code.

```
act      title                                     od cal 'has no predecessor'
100      Notice to Proceed                          0 1 D has no predecessor
13061    Fab & Deliver Str St1                      110 1 D has no predecessor
      2 records

act      title                                     od cal 'has no START predecessor'
53353    Construct Retaining Walls                 45 1 D has no START predecessor
28925    Term Signal Wiring&Cable                  45 1 D has no START predecessor
      2 records

act      title                                     od cal 'has no successor'
99999    Project Completion Date                   0 1 D has no successor
1100     Submit Community Relations Plan           60 2 D has no successor
1200     Submit Utility,Municipal,Other Notif.     30 2 D has no successor
1520     Submit Final Test Plan                    45 2 D has no successor
      4 records

act      title                                     od cal 'has no FINISH successor'
75661    Cut&Fill Sta1363+19-1368+18              1 1 D has no FINISH successor
86310    Build Retn/Grav/Crash Walls               50 1 D has no FINISH successor
28575    Instl Stormwater Systems                  30 1 D has no FINISH successor
      3 records

act      title                                     od cal 'has duration > 22 days'
11001    Grade Sta 252-142                          86 1 D has duration > 22 days
11005    Grade/Fill Sta 58-142                       35 1 D has duration > 22 days
13061    Fab & Deliver Str St1                       110 1 D has duration > 22 days
53353    Construct Retaining Walls                 45 1 D has duration > 22 days
28925    Term Signal Wiring&Cable                  45 1 D has duration > 22 days
86310    Build Retn/Grav/Crash Walls               50 1 D has duration > 22 days
28575    Instl Stormwater Systems                  30 1 D has duration > 22 days
      7 records

act      title                                     od cal 'has duration = 0 days'
100      Notice to Proceed                          0 1 D has duration = 0 days
99999    Project Completion Date                   0 1 D has duration = 0 days
      2 records

act      title                                     od cal 'has RD > OD'
No records

act      title                                     od cal 'has RD=0 but no AF'
No records

...Etcetera... Suspect Lag Report Not Shown Due to Width Limitations...
```

Figure 25.6.4 Extended diagnostic report.



with negative lag, as pointed out in Chapter 11. It is left as an exercise for that student to modify the programs accordingly.

### **25.7. First Review of Calculated Output: Reality Check #1**

Often a contractor or engineer will foolishly skip the technical review and go directly to the graphical bar chart to determine if the activity placement on the schedule *appears* to be correct. It is important to perform the technical review first and correct any technical errors discovered as such may have a significant impact upon the schedule. But finally, we must look at the activities and their scheduled dates in the context of actually utilizing the CPM.

Up to this point the data acquisition, entry, and technical review may be performed by a young engineer, fresh out of school. It is at this point that a proper review requires some element of experience in the field of work for which the CPM is being produced. Even here, however, the Scheduler can assist project personnel by providing appropriate views of the multitude of activities and other data and reducing the task of review from that of all activities to significant samplings.

### **25.8. Detail Views of Output of Schedule Calculations**

Having walked through the entire project not once but twice during the data acquisition process, it may not be realistic to expect the project manager or superintendent to review 100 percent of the scheduled dates of activities to determine reasonableness. After all, the time of these individuals is also limited and it is far better utilized in preparing the plan than reviewing the schedule. Thus, the job of the Scheduler is to highlight those areas in the schedule that most need this review.

Obviously, the critical path or paths is the first area that should be scrutinized. Our previous discussions on what constitutes “critical” now come into play. The Scheduler must determine whether to review only zero float activities or those having 5, 10, or 15 days of float. A serious issue here is to unravel multiple paths of float rather than merely present a list of activities that may be on one of several “critical” and “near-critical” paths. As noted, the advent of multiple calendars further exacerbates this issue as a sort by total float may not include all activities of a near-critical path.

For purposes of demonstration, assume Activity 236 of the John Doe project will require 140 calendar days rather than 90 work days for fabrication, thus creating concurrent critical paths through the plant and office structures. A standard screen shot, such as Figure 25.8.1, will

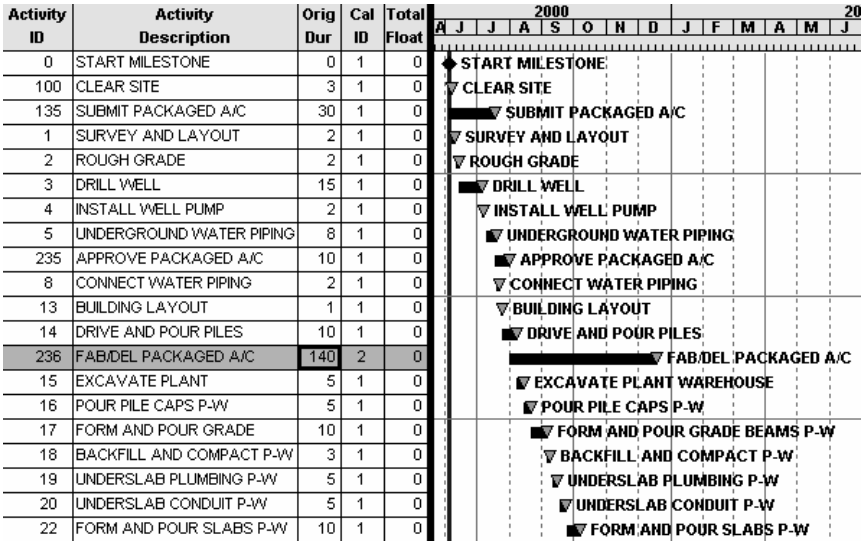

Figure 25.8.1 Two concurrent critical paths cannot be distinguished in a simple early start printout.

show all activities having zero float but no means to easily trace the two concurrent paths.

To provide usable information to the project manager, superintendent, and other construction specialists, the Scheduler must prepare a proper report. First, it is necessary to add a new code value for segregating the various paths. In Figure 25.8.2, this code is named PLOT as it may be reused for other graphics in the future. After filtering for “No Activities,” Find (by keying Control F) Activity #80, the last activity in the John Doe network. Add to the screen the Predecessor dialog box (by keying Control E) and notice those activity relationships that “drive” this last activity, Activities 72, 78, and 94, highlighted by an asterisk in the column between the Activity ID and Relationship.

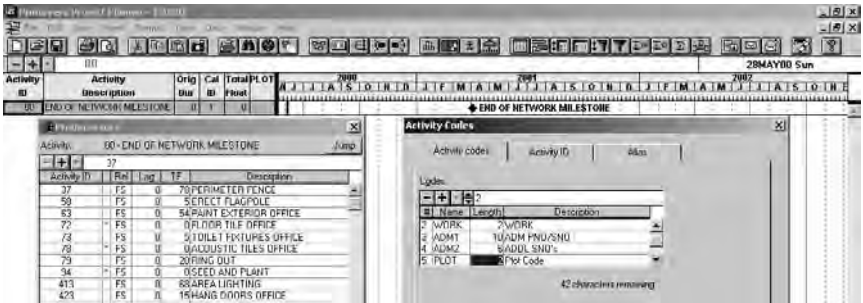

Figure 25.8.2 Use of PLOT code.

Also note that two activities, 58 and 73, are within the project manager’s “envelope of criticality.” Click activity 72 and then click the Jump button. Continue to click the Jump button until reaching the start of the network, making a note whenever there is more than one driving relationship or other activities having float less than the threshold set for being near-critical. (Figure 25.8.3.)

Assign a code of 1 (or first critical path to be plotted) to these activities. Now go back to activity 80, click the next driving relationship, and click Jump until jumping to an activity already previously chosen, coding the second path to 2. Repeat until all such paths are traced and coded. Your notes taken during this exercise will include that activity 67 had two driving relationships and thus starting from 67 and clicking first 65 then Jump will trace a fourth path.

This process may be repeated for near-critical paths by going to activity 80 and clicking 58 then Jump, and then, importantly, clicking the driving relationship to 58 then Jump. Repeating this process will track additional near-critical paths, including the importance of fabrication of the plant electrical package. (Figure 25.8.4.)

The last step to preparing this graphic for the project team is to reorganize the bar chart in ascending rather than descending order. Clicking Format Organize brings up the organize dialog box. Add Group by Plot Code and Sort by Early Start, as shown in Figure 25.8.5, to complete the graphic, Figure 25.8.6.

Another area of concern to a project manager would be work performed out-of-season, such as pouring concrete during the winter in the northern US or during the summer in Panama. One of the codes for which information was carefully collected and keyed to the system for the John Doe project was the type of work. Thus, it is easy to create a filter requesting all concrete work between December 1 and April 1, such as in Figure 25.8.7. In the John Doe project, this resulted in no “hits” so the filter was expanded to include all concrete work, as shown in Figure 25.8.8. Note that the late finish of activity 28 extends past

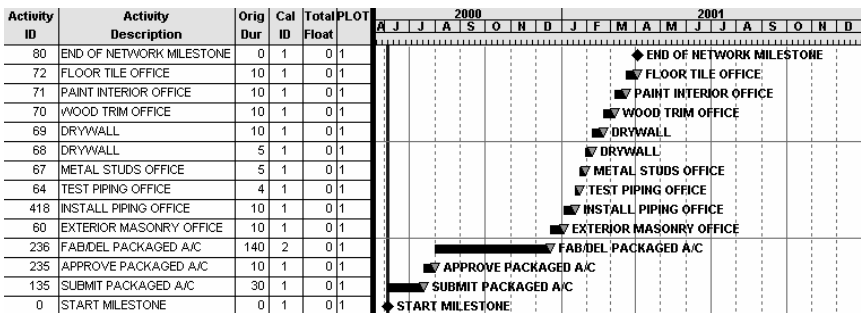

Figure 25.8.3 Backward pass of one critical path.



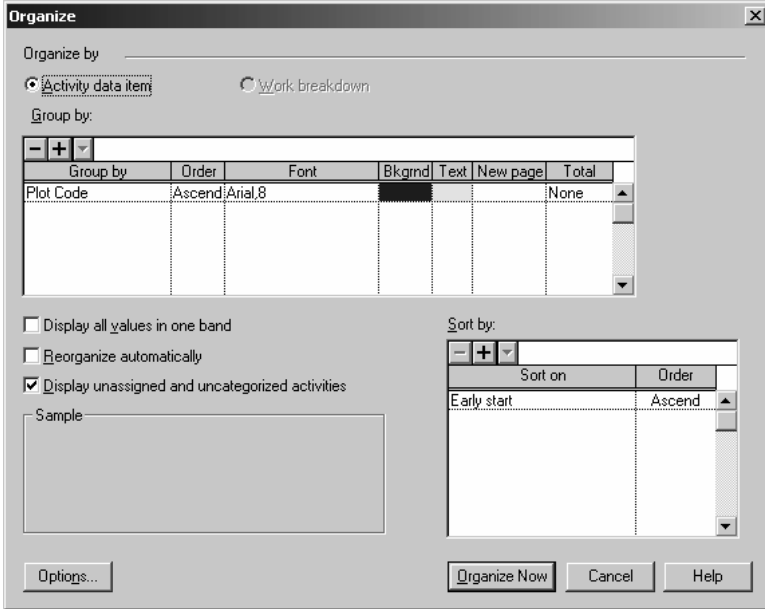

Figure 25.8.5 Grouping by PLOT code.

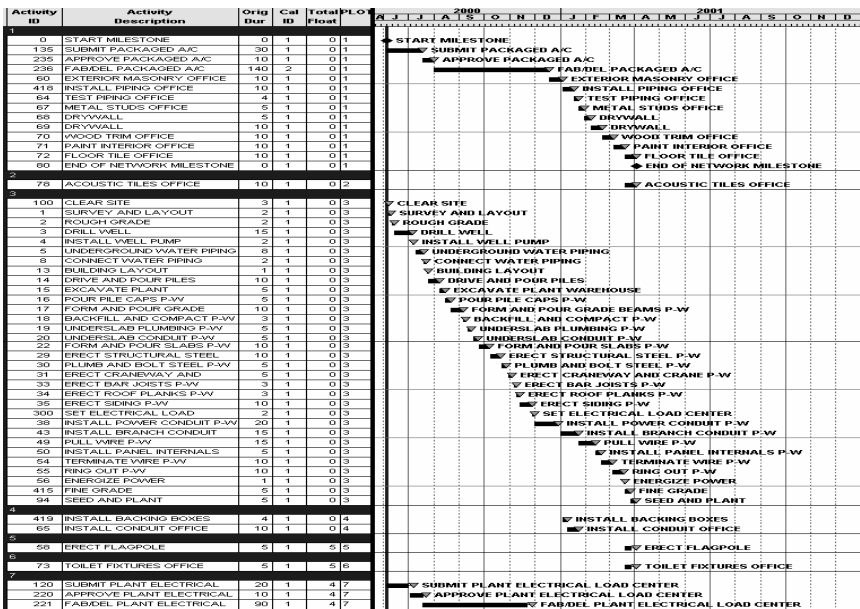

Figure 25.8.6 Intelligent report of multiple critical paths.



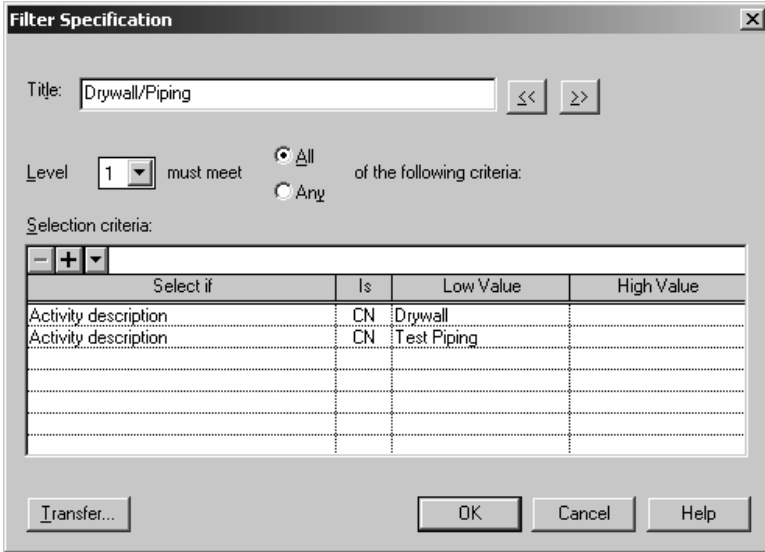

Figure 25.8.9 Filter.

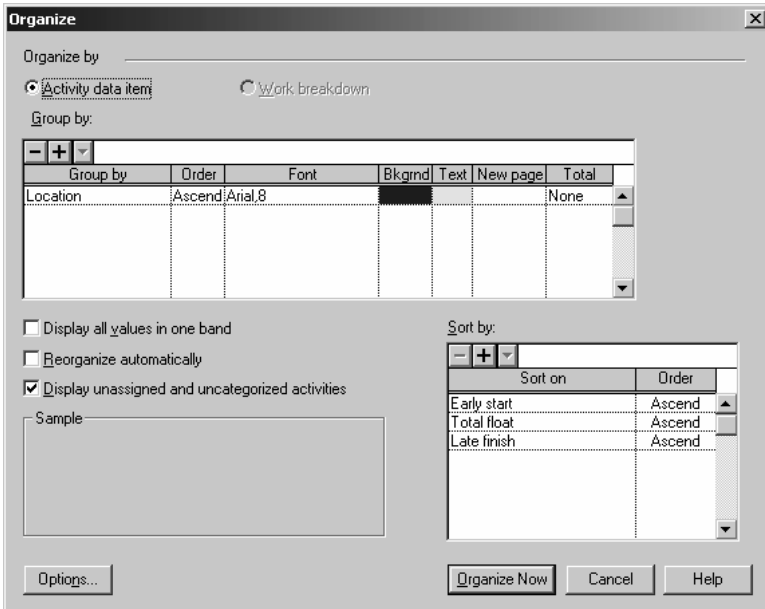

Figure 25.8.10 Organization.

Another test for seasonal weather is to bump the start date of the CPM by 3 months and recalculate. The results may highlight those activities that could be adversely affected and for which the use of a weather calendar may be useful.

## 25.9. Time Scaled Logic Diagram

For a good general overview, a properly prepared time scaled logic diagram (as provided in Figure 24.8.5) may be useful. Since this diagram can show so much, it is important to moderate the amount of information on the plot to that which can be easily viewed and understood. Even for an “E” size drawing, trying to cram in more than 200 activities may be self-defeating.

Care should be taken once again to set the appropriate envelope of criticality so as to highlight those activities having less than a set limit of total float. Assuming that proper activity codes have been utilized, different color bars may represent differing crafts, subcontractors, or responsible parties. For the initial plot, keep in mind that the remaining duration is the same as the original duration and there is no need to show both, but that the bars are plotted in early date format so it is desired to display the total float. (Figures 25.9.1 and 25.9.2.)

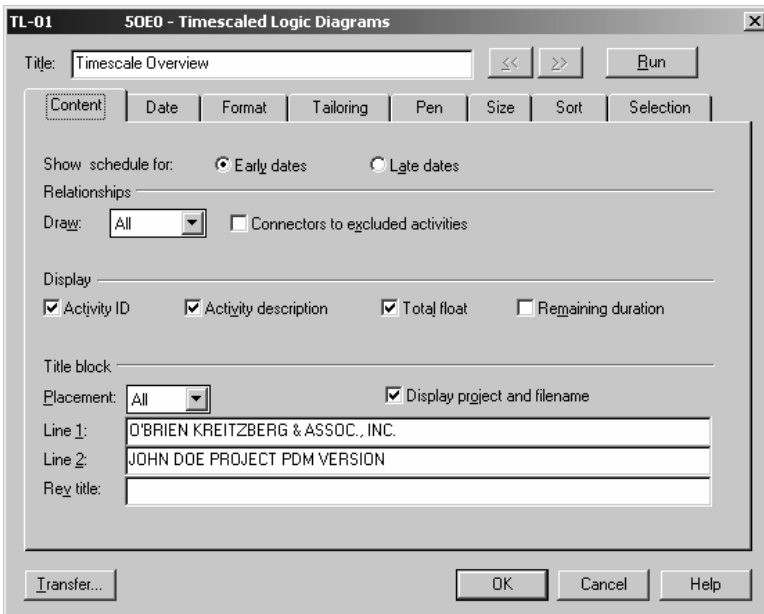

Figure 25.9.1 Timescale overview content.



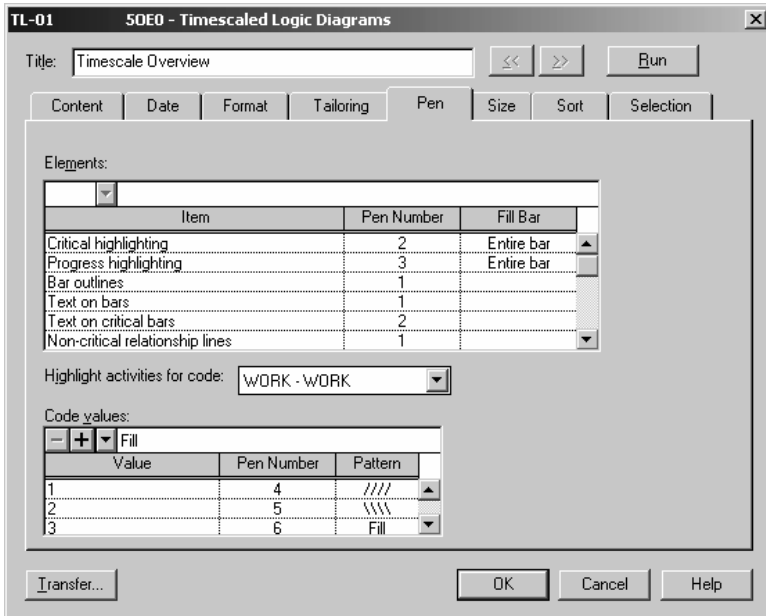

Figure 25.9.2 Timescale overview pen.

If detail about a specific craft or interaction between two crafts in a specific location is desired, this is best displayed on a separate plot. A time scaled logic diagram is a graphic written paragraph. Choose a paragraph topic and keep the “writing” simple and readable.

### 25.10. Tailoring Initial Output to the Chosen Audiences

The reviews are complete. The plan and schedule are done. It is time to prepare the formal reports to all of the audiences that the CPM should serve. The Scheduler has put on yet another hat—that of the Great Communicator.

### 25.11. Whatever Owner Wants, Owner Gets

The provision of funding by the owner, like the charms of Lola in *Damn Yankees*, assures the maxim that the owner, whose specification must be met by the contractor, will get the reports that he or she wants. What the specification may require may not always be useful to the owner. A professional Scheduler may point this out to the owner’s representative or engineer, but the advice is not always accepted. In such an instance,

document the exchange and provide exactly what is called for if such is possible. When the owner or engineer declares such unreadable or unusable, the contractor should charge an appropriate fee for providing a more useful submittal.

In one case involving the authors, the specification called for a computer drafted time scaled logic diagram including all activities, that is, construction, submittals, approvals, fabrication, and deliveries. When it was suggested that such a diagram might be unreadable, the Engineer insisted that if such a plot were not impossible that the contractor must follow the specification without deviation. The final plot, stringently following the specification and with all sheets pasted together, was over 8-feet tall and 6-feet wide. Following the logic lines from one activity to another was almost impossible. The ensuing fracas involved extensive litigation over a period of years and even involvement of a state engineering disciplinary board.

Where a specification calls for an improper product, such as dictating the contractor “prosecute the work diligently,” complete by a stipulated date, and yet submit a CPM *showing* that it intends to use all contract time without a proper contingency at the end, the contractor may point out the absurdity of such a combination of demands, but if all else fails, he or she will be required to provide such a submittal. An attempt may be made to include a “contingency” activity near the end of the network, or a long duration activity for punchlist, or some other “fudge” to comply with all three of the demands noted. But, the engineer may reject these efforts and require the contractor to overstate durations along the critical path to force the answer desired. In such case, the submittal or accompanying narrative should be appended with the note:

“This CPM submittal does not represent the Contractor’s intent and deliberately misstates the Contractor’s intent per direction of the Engineer.”

The contractor should be pleased to remove such a note if requested to do so *in writing*.

### **25.12. “You Can’t Always Get What You Want, But . . . You Get What You Need”**

A specification may require testing of safety equipment on the first day of each month. The contractor’s insurance policy may require it test its safety equipment every Monday morning. A good contractor may not like the extra expense but will comply with both requirements, even if the first of a specific month starts on a Tuesday.

A specification for one project may require use of a special timesheet or cost recording system *for the benefit of the owner* and quite different than that typically used by the contractor. Except for the smallest “Mom and Pop” contractor, and often even there, the contractor will comply by having his personnel fill out two timesheets, one for the owner and one for his own accounting department. Similarly, a good contractor will implement a proper CPM for each of its projects whether such is required by the specification or not.

The contractor’s CPM, prepared for the purpose of assisting his performance on the project, may include codes not required by the specification. The contractor may choose to update weekly (this being the recommendation of the authors) to best mimic how the superintendent and foremen would schedule a project without a CPM. And the CPM specified by the owner may include requirements that reduce or eliminate the ability of that CPM to be a tool to assist the contractor’s performance. In which case, the contractor should properly submit the “CPM” reports required in full compliance with the specification while concurrently using his own CPM to run the project, similar to the usage of duplicate timesheets noted previously.

This is not a radical idea. The reality is that many projects with a CPM schedule unsuitable for “running the job” will have a duplicate scheduling system based upon 3-week look-ahead bar charts prepared by the foremen. In some instances the engineer will request such a duplicate system suggesting “the CPM is for recording purposes only.” In some instances the specification will even require the duplicate systems. As discussed in the next section, the update process should include a computer generated 3-week look-ahead. Maintaining a second system for such a purpose may even be less costly, not to mention the superior product and other benefits of a proper CPM.

### **25.13. Reports and Views for the Foreman Performing the Work**

The foremen on the project may desire to have a quick overview of the forest, but for day-to-day operations must focus upon individual branches of specific trees. In general, a foreman will want a view of activities within the next 3 to 6 weeks at a maximum, and only those within the location on the project where the foreman will be working. In addition, the foreman already has too much paper and paperwork. Anything that reduces or at least does not add to this burden will be welcome.

Without a CPM, foremen will typically prepare short-term bar charts of upcoming work. The purpose of the CPM is to assist the natural abilities of the foremen and not to replace them with an unfamiliar system. Thus a combination tabular and bar chart report, similar to that which

is the default of every CPM software vendor, is a good starting point. However, since in construction the foremen rarely have immediate access to a PC screen, the Scheduler must choose the minimum information that will convey the maximum information useful to the foreman on a one or two (or as few as possible number of) pages.

A suggested template for a turn-around document is that provided in Figure 25.13.1. Having the information organized (with page breaks) by a responsible party, then subcontractor, then either location or foreman and then the other will allow easy dissemination of the proper information to the proper foreman. Limiting the activities shown to those that either have already started or may start within the next 3 weeks sets a realistic limit to the forward planning required of the foreman. Providing a bar chart view of the next 4 to 6 weeks also allows the foreman to see the near-term substance of this limited activity set. An RDM system might be able to include on this report information regarding not yet started or incomplete activities by others that immediately precede the foreman's activities.

Tabular information that may be of use to the foreman and should be displayed includes:

- the activity number or identifier,
- the activity title or description,
- the original duration,
- the remaining duration at the start of each periodic update period,
- the calendar upon which the durations are based,

Activity ID	Activity Description	Orig Dur	Rem Dur	Cal #	Crew Size	Crew Type	SH11	Early Start	Early Finish	Total Float	Actual Start	Rem Dur	% Comp	Cost % Comp	Actual Finish	2005					
																JUL	AUG	SEP	OCT	NOV	DEC
Ramp ASB&AB																7/24	7/25	7/26	7/27	7/28	7/29
3306	Ramp A, B & AB - Subbase	2	1	1	6	PV	C127	09AUG05	10AUG05	0		2	0			7/24	7/25	7/26	7/27	7/28	7/29
3305	Ramp A, B & AB - U-Drain	2	2	1	8	PV	C127	11AUG05	12AUG05	0		2	0			7/24	7/25	7/26	7/27	7/28	7/29
3314	Ramp A, B & AB - Shoulders	2	2	1	6	PV	C127	33AUG05	33AUG05	0		2	0			7/24	7/25	7/26	7/27	7/28	7/29
Paving Stage 1C 2nd Loop																					
6105	Construct SR222 - Subbase 316A-316B MED	3	3	6	6	PV	C134	23AUG05	25AUG05	117		2	0			8/10	8/11	8/12	8/13	8/14	8/15
6103	Construct SR222 - U-Drain 316A-316B MED	2	2	5	8	PV	C134	26AUG05	28AUG05	117		2	0			8/10	8/11	8/12	8/13	8/14	8/15
6114	Construct SR222 - Shoulders 316A-316B MED	2	2	5	6	PV	C134	07SEP05	08SEP05	117		2	0			8/10	8/11	8/12	8/13	8/14	8/15
Paving Stage 1C Median																					
6120	Construct SR222 - Subbase 316A-316B MED	2	2	0	6	PV	C136	30AUG05	30AUG05	120		2	0			8/10	8/11	8/12	8/13	8/14	8/15
6126	Construct SR222 - U-Drain 316A-316B MED	2	2	5	6	PV	C134	30AUG05	31AUG05	120		2	0			8/10	8/11	8/12	8/13	8/14	8/15
Paving Stage 1C Temporary																					
6141	Construct SR222 Bypass 316A-316B	5	5	4	8	PV		01AUG05	05AUG05	211		5	0			8/10	8/11	8/12	8/13	8/14	8/15

Figure 25.13.1 Foreman's turn-around document.

- the referenced engineering drawings for this activity,
- the crew size and composition,
- other code data as appropriate and as may fit,
- the early start and finish for the activity,
- the total float for the activity, and
- the junior float for the activity (if calculation of such attribute is available.)

In addition, this same form may be used to collect information for the next update and therefore tabular columns should be reserved for the following items.

- Actual start date if started,
- Remaining duration at the end of the periodic update period if started but not finished,
- optionally the percent complete for progress reporting of longer duration activities,
- an alternate cost percent complete if the CPM is cost loaded or the inspector wants to “hold money” for an activity otherwise complete, and
- Actual finish date if finished.

For purposes of simplicity and providing to the foreman only the information necessary to assist the crew’s efforts, it is suggested that only one bar be displayed, indicating the current early dates of the activity. Alternately, a dotted line or other symbol may be displayed to graphically display the available float for an activity.

The printout shown in Figure 25.13.1 provides the paving foreman with most of the scheduling information needed for the next 6 weeks. The activity 6144 may begin this week, but has over 200 days of float. Work on Ramps A, B, and AB is near-critical, having only 9 days of float. The foreman knows to check on drawing “C127” for details on this work. The foreman may choose to check on activities 3304 and 3305 (whatever that might be), which is noted to the top left of the bar for 3306 as being the activities that must be completed during the coming week if this subbase activity is to be performed next week. The asterisk on 3305\* indicates this is the driving activity.

The key to transforming this computer printout to the scheduling tool of choice of the foreman is to emphasize that the bars only represent those activities that are anticipated to be available for performance and do not represent the short-term schedule of the superintendent or foreman. The early dates represent when it is anticipated the activity *may* first

be performed. The tabular or graphic float entry represents when the CPM calculates the activity must be finished if the project is to complete on time without expensive overtime or other fixes. The actual placement on the short-term schedule is still a decision to be made by the project team using all data known when the decision is made.

For this, the superintendent and foremen should still meet each Monday morning or Friday afternoon or time of choice, and mark the turn-around document with a Sharpie pen or other highlighter. The superintendent now knows what activities are scheduled for the next weeks and can schedule resources accordingly. The foremen should now again review the contract drawings for work scheduled in the coming weeks to ascertain any last minute RFIs or determine any changes in condition.

At the end of the week or other reporting period, the foreman can fill out the actual date and remaining duration information for computer calculation and printing of the next week's turn-around document. Any special problems may be noted next to the bar representing the affected activity, and the Scheduler can have such entered as a log entry or "Note" or memo and printed on subsequent turn-around documents until the activity is completed. (Figure 27.15.1)

#### **25.14. Reports and Views for the Contractor's Superintendent**

The job of the project manager or superintendent, or for that matter any other line manager, is to see that those who will be producing have all the tools, materials, and instructions necessary to *produce*. This key person must have at all times both a view of the forest and the trees. To oversee the total project, a good graphic report may be the time scaled logic diagram used for the final review, limited (per 3-foot width) to the 200 or so most critical activities plus significant milestones whether or not near-critical. For a project of significant size or duration, an additional 3-foot panel may be required, but the goal is still to produce a chart that can be easily used by the superintendent rather than one encompassing all "important" information. The skill of preparing graphics that meet these all-too-often exclusive requirements is part of the art of being a Scheduler.

The turn-around document prepared for the superintendent should be similar to that prepared for the foremen with a few significant differences. Unless the superintendent will be personally doing a walk-through of the project for each update to collect information, there is no need for the actual information columns. (On the other hand, if the super will collect this information, there is no need to clutter the forms used by the foremen with these columns.)

Additional tabular information that should be on the superintendent's printout includes the variance between the early finish of the last update and the current schedule. Additional graphical information that should be on the superintendent's printout includes an additional bar to reference the following:

- baseline or initial schedule,
- most recent revision to the baseline (if applicable) and
- last most recent update

The turn-around document for the superintendent has more information on it than the one for the foreman (Figure 25.14.1). Instead of only one, there are now three bars: the baseline schedule, the last update, and the current schedule. Legend or memo notes remind the superintendent that there is a stop work order on activity 3302 while investigating a Native American artifact, but that this work is now near-critical. As a result of this stoppage, three subcontractors, the bulk excavator, underground pipe installer, and electrician, have had their work disrupted. The superintendent should be placing the owner on notice of a claim for an extra while reminding the subcontractors to record their costs of demobilization and remobilization in this area. Another note indicates the inspector insists on holding 10 percent for a damaged inlet, but that this can be repaired or replaced at a later time and will not delay work in this area.

Although not available in popular commercial software, if in-house or third-party software provides forecasting capabilities to adjust future original durations based upon past performance for similar work, the superintendent's report should also include the current forecast of the

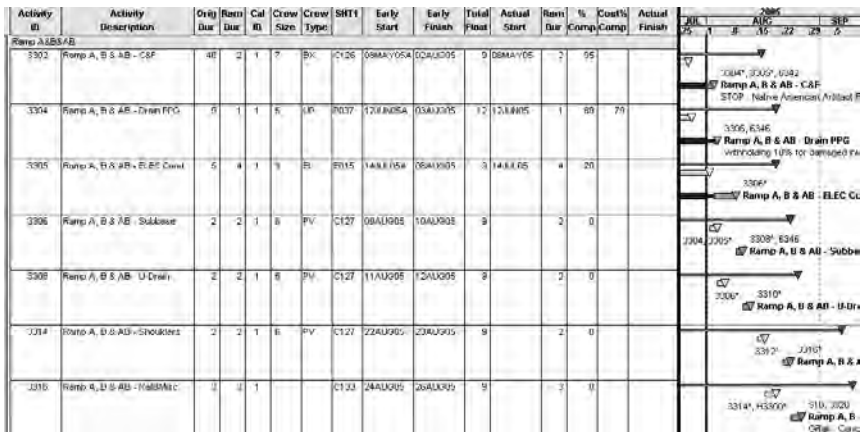

Figure 25.14.1 Superintendent's turn-around document.

adjusted original duration and an additional bar to reference the most recent forecast.

### 25.15. Reports and Views for the Contractor’s Upper Management

The job of upper management is to see that the superintendents, or other line managers, have the management tools necessary to best perform their function and are otherwise “in good running order.” A part of this is to measure the health or performance of the project and to provide additional assistance even if not requested, (including if required, changes in line management). This does not suggest knowing every detail of the workings of the superintendents nor that of the foremen. Modern physics tells us that when we measure something, we impact that something and tend to slow it down. A project where every action is carefully measured may be expected to slow to a standstill.

The Scheduler must strike a balance between the stated desires of upper management to be informed of “everything” and to not be bothered with “inconsequential details.” The careful choice of coding structure at the beginning of the preparation of the CPM interview process is the key to providing this balance. For the highway project example, choosing to summarize by subcontractor or crew can provide one view of the health of the project, while summarizing by area can provide another. In Figure 25.15.1, the one week lapse between the second and third bar for each subcontract indicates that *something* has stalled the entire project. The note appended to the printout in Figure 25.15.2 gives one possible reason for the problem.

How did that note get there? It was added by being “pasted” in place by the Scheduler using the various graphic tools available to one extent or another in all of the commercial software on the market. In many cases this is the best that can be done. While P3 has its log fields for an individual activity and P3e/c has notes that can attach objects (such as

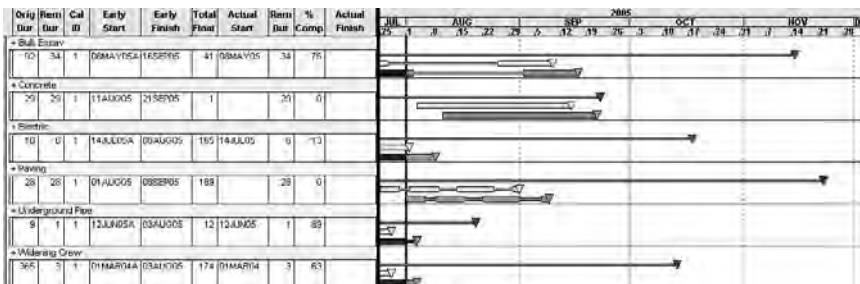

Figure 25.15.1 Summarized by subcontract.



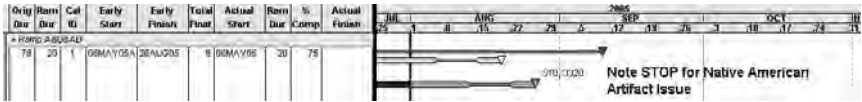

Figure 25.15.2 Summarized by area.

a photograph) to an individual activity, neither has the ability to attach information to the summary of selected groups of activities. But if this is what is needed to provide the proper information to the selected audience, this must be part of the work of the Scheduler in preparing such presentations.

### 25.16. The Narrative Report for Each Audience

After providing informative tabular reports and after creating killer graphics to illustrate exceptions and areas requiring further attention, the Scheduler typically must write a narrative to describe, in terms understandable to a nonscheduler, the contractor’s plan of execution and how the CPM has been implemented to assist the project team achieve it.

“How to write” could be the topic for an entirely separate textbook; and there are many excellent texts that do discuss the writing of a technical report. For purposes of this subsection, there is no universal format and each Scheduler should work out his or her own style. The Scheduler should keep in mind for whom the narrative is being written, and provide separate narratives if necessary for multiple audiences. If the CPM submittal is to be made to another Scheduler, the use of scheduling jargon and the absence of long explanations may be appropriate. In general, the engineer reviewing the CPM submittal is not a scheduler and must have even simple concepts repeated, such as that the early dates represent only when the activity may possibly be performed and do not guarantee, promise, or even suggest that the contractor has any intent of performing on such dates unless the activities are critical or near-critical or the schedule has been resource leveled.

A narrative provided for the engineer should highlight all items in the submittal that should raise issues or call for higher scrutiny. Thus, a separate listing of those activities utilizing non-traditional relationships, noting the reason why such will make administration of the CPM easier during the course of the project and with at least a sample of how one might be traditionally portrayed, even if such is not required by the specification, can go a long way towards building a rapport with the engineer. If an internal effort was made to verify durations, for example via a calculated productivity rate by work type, this should be mentioned.

Any special abbreviations or idioms used by the staff of the contractor, such as “conduit, cable and connections” or “pipe, pull and terminate,” should be explained.

Next, the narrative should talk out the critical path and various near-critical paths. If a critical or near-critical path begins at other than the start of the project, such as at a constraint, highlight this and explain why. Note the anticipated number of concurrent operations and resources to be fielded as the project builds momentum through to punchlist. Make a special effort to highlight any actions by the owner (or the engineer) or third parties that are reasonably anticipated and the importance to the schedule of such performance.

A separate narrative to upper management of the contractor may highlight the usage of scarce resources of the company (such as cranes) and any special support needs that the schedule assumes. A narrative to a department of the owner not involved in construction, be it operations, public relations, and so forth, should highlight what impact the construction will have on such “third parties.”

### **25.17. Summary**

Going from the step of data acquisition for a logic network to the publication of the contractor’s schedule involves a number of steps, from data entry to validation of the plan to validation of the schedule to preparation of reports tailored to the intended audience. An important point to keep in mind is that the quality of the product must be kept in the forefront and not be subject to dilution by the desires of the project manager, the owner’s engineer, or third parties.

## Engineer's Review of the Submitted Initial CPM

The law states that having power and authority imply an equal obligation of proper use. The specification gives the engineer the right and duty to review and approve or reject the CPM submittal. An improper acceptance or rejection of a proper submittal for an initial CPM or update or revision, may place the owner at risk of extras and may even negate the obligation of the contractor to complete the project on time.

The foregoing statement is not meant to be limited solely to submittals of a CPM, but merely reiterates the general rule of liability whenever one party to a contract is required to provide a shop drawing or other submittal to the other. If an engineer were to reject a shop drawing for a beam because “it looks too thin” but be unable to fault the calculations to show that it meets both the specification and industry code, there is little doubt that the loss of time and cost caused may be recovered by the contractor from the owner. This is not to fault the engineer's skepticism; the “feeling” that it is “too thin” should trigger an additional and perhaps intensive investigation of the matter by the engineer. However, acceptance or rejection must be based upon the results of such investigation and not mere “gut” feelings.

In the case of a CPM, the submittal is merely another shop drawing; nothing more nor less. The submission of shop drawings are often detailed in a contract specification in section 01300 organized in the CSI format. Section 01305 details the provision of a log of shop drawings. Section 01310 details the CPM, the contractor's proposed sequence of construction.

The purpose of any required submittal should be to provide additional assurance that the contractor can comply with the substantive (or physical work) obligations of the plans and specifications, to provide early

notice of the contractor's interpretation of the plans and specifications, and to provide the engineer with additional means of monitoring compliance with the plans and specifications. Implicit in the *planning* stage of preparing the CPM is the need for the contractor to take a second look at the plans and specifications, this time, by the team that will be performing the work and separate from that previously performed to bid the job, to ascertain "exactly how are we going to build this thing." Requiring the contractor to take such a "second look" has several advantages for the engineer.

The first two of these advantages may be of more assistance to the contractor than to the engineer or the client, but the contractor's success is of benefit to the owner also. The detailed "second look" will often cause the discovery of errors in the contractor's bid. Since the method of "take off" is by activity (discrete instruction sets to foremen) rather than by quantity, the effect is much like the practice of checking a land survey by transiting back on a different path from that initially taken. If errors are discovered (and every bid has some errors), the contractor has the maximum amount of time to mitigate the impact thereof. The "take off" by activity also provides a constructability review that will hopefully detect any issues of "it don't fit" that may be determined from such a detailed review of the drawings. This determination of errors of the plans and specifications (and every set of bid documents have some errors) provides the engineer the maximum amount of time to mitigate the impact for the client.

The submitted CPM will provide the "plan of execution" established by the contractor at the time of the bid (updated perhaps by correction of bid errors noted) and nails down this roadmap to its intended means and methods to be used on the project. This should include the contractor's proposed allocation of resources. If the engineer later requires changes, the contractor cannot say that they prevented performance as planned, unless the initial CPM submittal shows such a plan.

Perhaps the most important of the three reasons is eliciting the contractor's interpretation of the contract plans and specifications. This requires the contractor to "tell me what you think you heard me say" before going off to perform such instructions. While the contract documents are not usually overridden by the accidental acceptance of a non-conforming submittal (although many engineers try to protect their clients and themselves from this spurious threat by inserting generally ineffective exculpatory clauses in the contract, specification, and upon their "accepted but not approved" stamp), should a court be convinced that the contract plans and specifications contain an ambiguity that may be reasonably interpreted by the contractor differently than what was intended by the engineer, the contractor's interpretation may prevail.

The submitted CPM will also provide to the engineer what the contractor believes are the obligations of other parties outside of his control. These include those obligations alleged to be that of the engineer, the

client, third parties that are within the control of that party (or for whom such party accepts responsibility), and third parties outside the control of the contractor, the engineer or the owner. If the contract documents clearly state otherwise, such characterization should not modify the contract. If the contract is vague or ambiguous, the failure to reply to such notice of interpretation may be taken for acquiescence. Assuming that all parties agree on the scope of and responsibility for such obligations, the CPM allows the engineer to see how the contractor proposes to coordinate the efforts of these multiple parties for the mutual benefit of the project.

### 26.1. Legal Aspects of a Review

The flip side of having the authority to review a submittal is the obligation to do so properly. Obviously, the owner has a contractual right to a proper review and in certain circumstances, if the review falls below an applicable standard of care, may have rights against the engineer notwithstanding contractual limits of liability. Similarly, although the contractor would not normally have a contract with the engineer, he/she may have pass-through rights (via the owner) to a proper review. Depending upon the state or other jurisdiction, this right may supersede contract language excusing or indemnifying the engineer. It is but a small step to suggesting that subcontractors may have pass-through contractual rights to a proper review and from there, to noting that third parties (utilities and other locally impacted individuals) may have tort rights to a proper review (including provision for consequential and punitive damages).

Thus, the authority to review the CPM submittal does not empower the owner or engineer but rather creates an additional obligation to assist the contractor to perform the scope of work of the contract. It is important to remember that the acceptance or rejection of the CPM by the engineer does not change the viability of a schedule. If the submission is accepted in error, this does not create an automatic "gotcha" for the contractor, but will merely acquiesce to the contractor's reasonable interpretation of claimed ambiguities. However, if a submission is rejected in error, the contractor may later "submit" to a real judge, with real consequences! These may include a change order to the contractor for additional CPM preparation, a change order for changed "means and methods," and a loss of credibility of engineer as objective arbiter.

What are the limits for which "acceptance" should be made? An acceptance should cover the following.

1. The format, as per specification, e.g., maximum durations, limits to logic types
2. Owner-controlled activities, including between multiple prime contractors

The engineer's acceptance should reserve rights relating to the following.

1. The contractor's "means and methods"
2. Requiring reasonable additional resources for any change order extra work
3. Requiring reasonable additional resources for recovery from any delay
4. Inclusion of constraints that may unduly reduce the owner's or engineer's float in responding to submittals, RFIs, or changed conditions (such as to field measurement of renovation work)

When may rejection come back to "bite" the engineer? If the engineer rejects a format that technically meets the specification, such as demanding code fields or graphics not in the specification, the contractor may claim a change order as well as loss of efficiency due to lack of an approved CPM. If the engineer rejects a duration, specified to be contractor's best guess, the contractor may claim a change order. However, the engineer may require supporting information for the duration and demand a general consistency between durations, resources, and costs.

If the engineer rejects inclusion of or demands addition of a logic restraint, there may again be a question of dictating the contractor's "means and methods." However, the engineer may demand a written explanation of questionable physical logic and may reserve rights relating to a contractor's attempt to level or smooth resources. On the other hand, the engineer may and should demand exclusion of "place marker" logic that cannot be adequately explained.

The important issue is that the engineer may not reject calculated output while neither finding fault with the input nor the calculation algorithm. The sole questions for the engineer when reviewing the CPM submittal are whether it meets the requirements of the contract specification, as construed against the party that wrote the specification and as may be modified by the exercise of reasonable engineering discretion.

## **26.2. Reviewing the Plan**

The seminal question in reviewing the CPM plan is whether what is submitted is a CPM or merely a bar chart by CPM software. To review the plan, first we must look at the activity descriptions. Activity descriptions must be for a proper level of detail, not too broad (e.g., ALL EQUIPMENT or ALL ELECTRICAL) and not too narrow (e.g., FLIP SWITCH). Each description should be unique and used only once. And, each description should be understood without additional references (Figure 26.2.1).

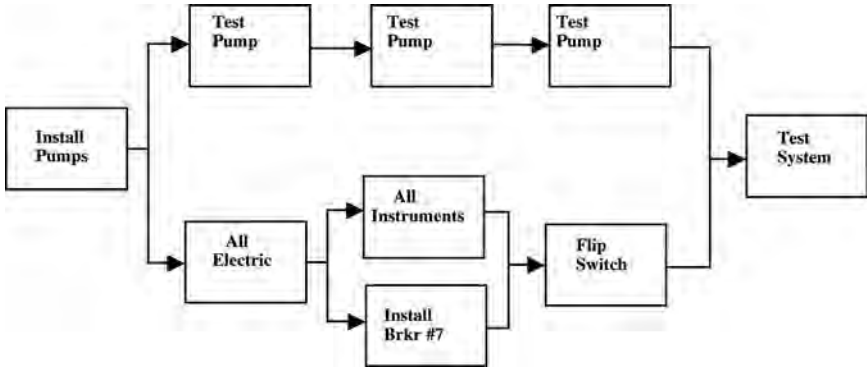

Figure 26.2.1 Activity descriptions must not be too broad or too narrow.

### 26.3. Technical Review

In addition to the educated review of the initial CPM submittal by a seasoned engineer, a technical review may be performed by a perhaps less seasoned engineer trained in the theory of CPM and familiar with one or more of the software packages used for turning the plan into a schedule. It is suggested that since the “testing” of the CPM may be “destructive,” a copy of the electronic file or files submitted be saved and renamed prior to the review.

### 26.4. Reschedule and Review the Diagnostic Report

Some software programs recalculate the schedule each time a change is made to the input. The down side of this practice is that calculation takes a perceptible time and can slow data entry significantly. Other programs will allow the user to enter data and recalculate the impact of such changes only upon command (Figure 26.4.1). P3 allows the user to change both input data (such as durations) and output data (such as overriding a calculated early start date). Of course, upon clicking the Schedule button, the output fields will be corrected back to the calculated date. However, if the submitted CPM report is printed after adjustments and before rescheduling, the output can say anything desired by the contractor and have no correlation with the logic network.

As a result, it is incumbent upon the engineer to have a copy of the software used by the contractor and to not rely solely upon the printed reports submitted by the contractor. After assuring that the file name will not conflict with other files on its computer, the engineer should copy the files provided by the contractor and reschedule the project from the data date. (Initially, this is the notice to proceed.)

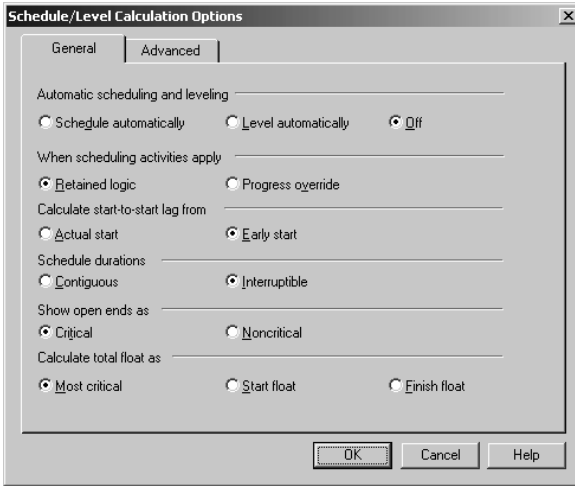

Figure 26.4.1 Choice of algorithm.

**Section 1: honesty.** The myriad of special features in modern software programs for overriding the traditional calculations of CPM, combined with the ability with many systems to directly access and manipulate the database where the output from these programs is stored, and the ability to “cut and paste” to official-looking reports, means that no matter how carefully the submittal is reviewed, there is the possibility of skull-duggery. Thus, the first line of defense may be to know the reputation of whoever has prepared the reports that you will be reviewing. If the specification requires the submission to include a copy of Primavera P3’s diagnostic report, a quick glance at the top notifies you of the serial number and licensed owner of the software being used. If this information is missing, and is not supplied if subsequently requested, what other corners is the contractor cutting?

Similarly, as the engineer reschedules the CPM to be assured that the output is related to the input, this report should be printed, and may be used to illustrate corrections requested of the contractor to its submittal. What type of statement will the engineer make if it does not display a valid license in the analysis?

**Section 2: constraints.** The use of a constraint in most cases is a shortcut for the depiction of the proper logic restraints required to plan or schedule an activity and should be viewed with skepticism. However, in many cases, the use of a constraint is beneficial in that it will make the use of the schedule easier, especially during updating. In some special instances, a constraint may even be used that could not be duplicated by the use of restraints.



**Section 3: open ends.** In most cases, a proper logic network should have only one start and one end. In the event that the contract contains intermediate milestones involving tangible and discrete scopes of work, there may be more than one ending activity. Similarly, if the contract provides that access to a portion of the site will be delayed, there may be more than one NTP or other starting activity. Other open ends not required by the engineer's specification should be viewed with suspicion and should be a reason for rejection if not properly and adequately explained.

However, it is important that the engineer go beyond the printouts, pure logic diagram, or diagnostic in checking for open ends. The Scheduler, for the engineer must either perform a manual review of each activity connected to others by non-traditional relationships or perform some automated form of review using a software tools as discussed in Chapter 25 to check for these types of errors.

**Section 4: progress and actual dates.** The initial schedule should not indicate progress and no activity should be assigned an actual date. Either transgression is a cause for rejection of the submitted CPM.

**Section 5: choice of algorithm.** The choices of algorithm affecting the initial schedule are limited and, in any case, the choice of the contractor, unless otherwise provided in the specification. Although the engineer may desire the choice of interruptible schedule duration, show open ends as critical, and calculate total float as most critical, the choice of contiguous schedule durations and printing of a start float or finish float do convey information that may be useful to the contractor. There should not be extra open ends in any case (Figure 26.4.1).

Similarly, the choice of retained logic or progress override should be addressed in the specification, but if not, it is important to note that each is an exaggeration of the situation when work is performed out-of-sequence. The choice of whether to calculate start-to-start lag from the actual start or early start may have more to do with the contractor's use of SureTrak in the field trailer than a conscious choice of which method makes the task of updating the schedule easier.

If the contractor and engineer are using P3e/c or Primavera Construction, it is important that the specification require careful coordination before including relationships to other projects. Similarly, if the specification does not mandate the calendar convention to be used for lag durations between activities, the engineer will need to use care when reviewing contractor submissions.

**Section 6: statistics.** The number of activities in the CPM should bear some relationship to the size and complexity of the project. One "rule of thumb" is a minimum of one activity for each \$10,000 of contract value.

Another more complex rule might factor out the value of purchased plant equipment and other large capital expenditures, determine the average hourly cost of labor, average crew size, and average activity duration somewhere between the minimum and maximum durations to be used, and calculate a suggested minimum number of activities.

Number of activities.....	873
Number of activities in longest path..	12
Started activities.....	843
Completed activities.....	822
Number of relationships.....	1236
Percent complete.....	97.6
Number of expected finish activities...	2
Number of late constraints.....	1

A healthy network, on the average, should have approximately 1.6 relationships per activity. If the number of critical activities (on the longest path) is near or exceeds 25 percent, additional scrutiny may be called for, but the number of near-critical activities (having perhaps 5 to 10 days of float) should also be reviewed. Obviously, these are all guidelines and require the use of appropriate engineering discretion rather than be cited as hard and fast rules.

For the initial submittal, there should be no progress: nothing started, nothing finished, and zero percent complete. The concern over the misuse of constraints cannot be over emphasized; each one must be checked as to why it is there and if it is truly necessary.

**Section 7: dates.** Obviously, the calculated completion date must be reviewed. Keep in mind that due to the limitations of the mathematics, exacerbated in complex networks due to the influence of merge bias, the probability that the project will actually finish by the calculated completion date is well under 100 percent. The larger the durations of the activities in the network, and the more complex the network, the lower the probability that the project will complete by this date. Thus, based upon the level of detail of the network, the engineer must “feel” whether an appropriate contingency has been included, or subject the CPM to further analysis by a Monte Carlo or PertMaster type of software.

**26.5. But Is the Logic Realistic? The Smell Test**

But is the logic realistic? The engineer should walk through the critical and near-critical paths of the *logic network* without looking at the calculated dates to see if the logic makes sense. Does each activity have a predecessor reflecting a physical dependency? Do resource-based relationships tend to assist or confuse the logic? Do logic connections exist that appear to have no rationale? Do the durations used appear reasonable,

and if not, do they at least appear to be internally consistent? If questions arise at this level of the review, it may be best to discuss them with the contractor rather than blindly issuing a rejection. Once the logic and durations appear reasonable, then, and only then, the engineer should walk through the bar chart printout of these same activities to see if the timing makes sense. If something seems out of order, a more intensive review may be called for, possibly including an inquiry to the contractor. Of course, this mere intuition of the engineer cannot be a valid basis for rejection of a submittal.

## 26.6. Project Calendar or Calendars

Because the project calendar or calendars are not easily viewed (none of the popular software products providing a proper screen view of the entire project calendar), it is important for the engineer to review these carefully. If multiple calendars are used, the need is much greater since few casual users of the software truly understand how these operate. Unfortunately, the only means of review is to open the software files and drill down through several menus to the non-work days for the global calendar and then to the basis, non-work days, and exceptions to the global non-work days of each calendar.

Understanding the interplay of global and individual calendars is important, as are the rules of the software product for observing holidays that fall on weekends and non-work days that fall on holidays. Also important is to guard against adding contingency to contingency, either through the calendars or activity durations already padded for anticipated weather conditions. Finally, if multiple calendars are used, it is important to educate all who may read the calculated float attribute of its modified meaning under these circumstances.

## 26.7. Summary

The engineer cannot and should not attempt to verify that the contractor can perform the contract work according to the “plan of execution” provided by the initial CPM submittal. However, the engineer can and should verify that the submittal is technically correct and that the logic and durations of the submittal appear “reasonable.” Finally, the engineer should “walk through the CPM” and determine if everything “smells right,” possibly leading to additional scrutiny. But the review of the initial submittal of the CPM must be handled in as professional a manner as any other submittal to the engineer.

*This page intentionally left blank*

## Updating the Schedule

How do you stay on a CPM schedule? In early CPM applications, the CPM network was left to its own devices once the project was in progress. The planners, confident that they had planned the project more carefully than ever before, did not follow up on their careful efforts. The result was similar to buying an automobile and then letting it break down because the oil was not changed.

In the sections following, updating the schedule by the contactor team is described. Traditionally, the project manager or superintendent would meet with all foremen late each Friday afternoon or early each Monday morning or at some other convenient time to tweak the short term schedule based upon performance of the past week and observations of other conditions that may affect the plan for the coming week. Since the use of the CPM is meant to support the traditional methods, rather than merely adding another chore for the project team, a weekly review or update of the CPM is recommended. Unfortunately, this is not typically done as many specifications are geared to monthly reporting to meet the needs of upper management rather than the project, and many contractors provide only what is required rather than what is in the interests of their own project teams.

Another reason why specification often requires only monthly updates is that despite the mantra that “On a project, time is king,” the reality is that issues of schedule are often an afterthought after issues of money. (Rarely will a Proposed Change Order from the owner start with “How might this impact the schedule – and by the way how much will this cost?”) Thus, usually on a monthly basis, a mutually agreed upon (between CM/Engineer Team and the Contractor Team) progress update is performed and is the basis for the monthly progress payment.

### 27.1. Why Update the Schedule?

How do you determine the status of the schedule? The CPM network can be used as the basis for monitoring project progress. On the job, the network can be posted on an office wall and progress marked right on it. The ever-popular colored marker pens are the best way. The field usually cooperates because plotting progress seems to strike a responsive chord in most of us. Not only does it result in a current status report for the project, but the process of keeping the network up-to-date familiarizes the field office with the logic diagram.

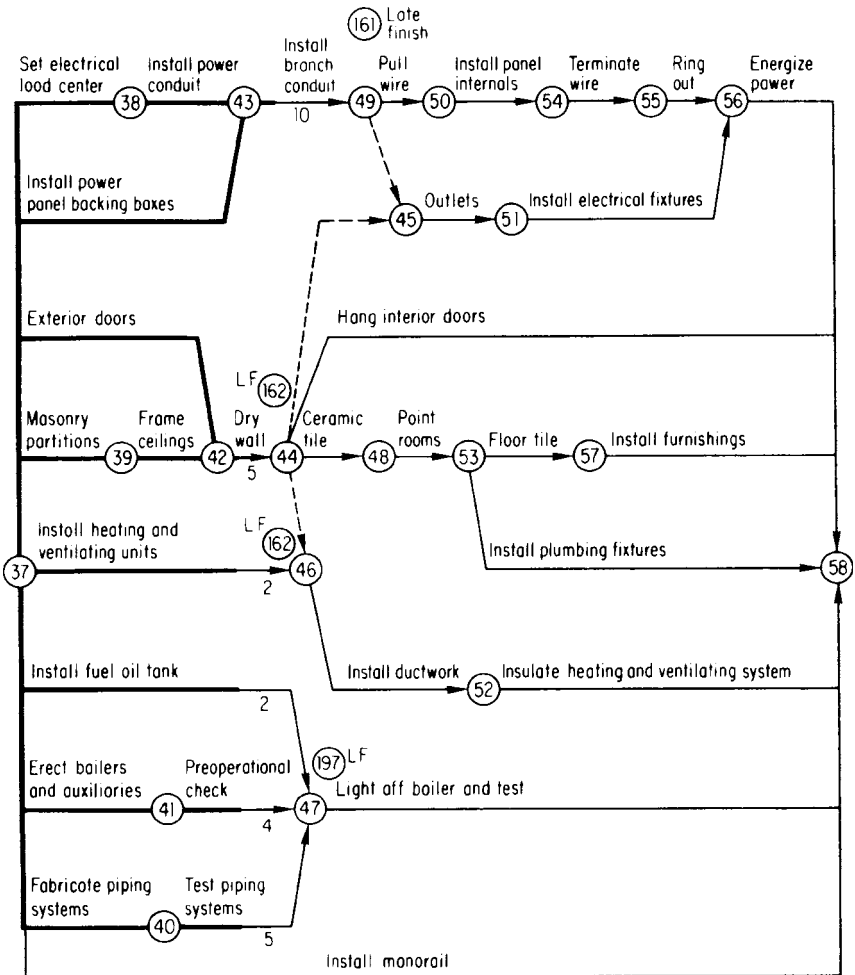

Figure 27.1.1 Plot of progress: project day 150.

**TABLE 27.1.1 Activities in Progress Having Float**

<i>i-j</i>	Description	Time remaining (days)	New float (days)	Original float, (days)
42-44	Drywall	5	7	13
37-46	Heating and ventilation units	2	10	23
37-47	Fuel tank	2	45	70
41-47	Boiler check	4	43	43
40-47	Test piping	5	42	33

An electrical contractor raised a very practical problem in regard to posting the diagram on the job site. If craftspeople review the networks, however casually, some will notice the time estimates for activities on which they are to work. If the estimates are too long, there will be the tendency for the crew to take too long on the activities. If the times are too short, the CPM schedule will be seen as unrealistic. This problem, if anything, bears out the need to use a frank and realistic approach to CPM planning. The diagrams will have a big impact on field people, and some excellent comments about scheduling have been known to originate from this level.

Figure 27.1.1 is the John Doe network with progress shown by dark lines. The event times for the activities in progress are shown. The first path to check is, of course, the critical path. This status is as of project day 150; a check along the critical path shows that activity 43-49, install branch conduit, has 10 days to go and is 1 day ahead of schedule. The activities in progress with float have the status shown in Table 27.1.1

All the float items are within the allowable CPM range. The drywall and heating and ventilating units should be pushed so that ductwork installation can start. Figure 27.1.2 is another representation of the same project status. This format could be used to submit a quick weekly status report.

## 27.2. Acquiring the Data for an Update

In this section, updating is described from the Contractor's point of view, where the Contractor has the responsibility to perform the update. However, especially when the update is part of the progress payment process, the Owner's Representative (CM, Engineer or both) will either be part of the update process or will have approval of the process.

In either case, a representative of the contractor must physically walk the job and eyeball the work in progress. Even in the case of non-construction projects, this process of personal inspection, rather than





basis and the project manager may have other pressing business on the specific day that this walkthrough should occur. Thus the extra care taken in preparing the initial CPM with the level of detail, descriptions and durations geared for easy updating will be rewarded at this time. Note again that the foremen and others will be much more able to provide the information needed if collected weekly rather than monthly and that the time wasted in looking up dates of work performed weeks ago may exceed the extra effort of weekly walkthroughs.

For those activities that are not amenable to visual review, such as the progress of procurement, an equivalent process of placing a phone call or email to each vendor asking about progress or problems of the past week is in order. Even if the procurement item is in a queue and awaiting its turn (such as often the case with special fabrication of steel,) the phone call can confirm that a special order (perhaps with military priority) has not bumped this procurement item within the last update period.

### **27.3. Distinguishing Updates from Revisions**

One major purpose of an update is to gauge the progress made during the past time period against that anticipated or estimated in the initial schedule. Based upon the information gained by this exercise, the project team may choose to make mid-course corrections to the plan for the work remaining in the future. But it is important that all parties see this as a process and not to cover up past poor performance with unrealistic changes to future performance. For this reason, it is important to distinguish between an update, measuring past performance, from a revision, a refining of the plan for future action.

An update should measure and record only those facts that have occurred. These will include whether a specified activity has started during the past reporting period, and if started whether it has been completed or is still in-progress as of the date that the update information is collected.

### **27.4. Purpose of an Update**

The purpose of an update is to record past performance and to determine the impact of past performance upon expectations for the future. If we could do five activities last week, and we did do three of them, how will this impact our projections for timely completion of the project and for what activities may be performed in the coming weeks? An important aspect of the update is to gauge whether progress on the project is meeting expectations, exceeds expectations, or is slipping behind.

### **27.5. The Purpose of a Revision**

The purpose of a revision is to insert deliberate changes to the existing “plan of execution,” either to account for changes to the project or to improve upon the previously “means and methods” chosen. Thus, a revision should only consider that which may be performed in the future. Changes in the project may include additional or modified scope, changes in anticipated conditions, or correction of errors previously made in interpreting the project plans and specifications. A revision to the logic is neither required nor desired for a casual deviation from the previously stated “plan of execution” so long as the contractor’s general intentions are to continue with that plan. In a majority of cases where a contractor deviates from a previously published plan, the decision to do so is involuntary and represents a course of conduct that is more costly than the original plan.

### **27.6. Who Should Collect Data for an Update**

If the initial CPM is properly prepared, utilizing information from the people most knowledgeable about the project but organized by a Scheduler, personnel of lesser experience may collect the data necessary to update the schedule. As has been noted previously in this text, it is this skill that distinguishes a Scheduler from a “screen jockey” who merely runs the software. If the definition of tasks is clearly understandable and the junior person collecting data is given some general guidelines, any errors in data collection will be less than the window of tolerance surrounding the original duration provided.

### **27.7. Who Should Prepare Data for a Revision**

On the other hand, the level of attention given to a revision requires the original team (or current personnel fulfilling the functions of the original team) to adequately plan and then schedule the remainder of work to be performed. Even as a small change requires that all subcontractors sign off on the cost impact thereof, the time impact must also similarly be addressed. Let us assume a small change involving minor relocating and resizing of an HVAC duct. If the prime contractor receives the cost estimate from the HVAC subcontractor and simply adds its OH&P (overhead and profit) markups before forwarding to the owner, the prime contractor may be in for swallowing some serious collateral costs. It is important that other trades that will have to relocate their systems around the new configuration also provide cost information. It is also important that the coordination of these multiple subcontractors

be revisited in the CPM plan, a revision plan be prepared, a schedule calculated, and the impact in terms of time and incidental or disruption costs (if any) be noted.

### **27.8. Information Required for Schedule Control: AS, RD, AF**

The information required for an update of the schedule includes only:

- a determination if the activity has started, and date started if applicable,
- a remaining duration in work days (comparable to that of the original duration) if started but not yet finished, and
- a determination if the activity has finished, and date finished if applicable.

### **27.9. Determination of Actual Start and Actual Finish Dates**

In determining whether the activity has started, it is well to look beyond the 24–36–48–64 characters of the description and establish whether the predecessors are finished and whether the resources assigned to this activity are in play. Similarly, in determining whether the activity is finished, it is important to note whether the activities successors have started and whether the primary resources assigned to this activity have moved on to other work.

### **27.10. Determination of Remaining Duration of Activities: Repeat the Steps of the Master**

If the activity has started but has not yet finished, it is necessary to independently determine the remaining duration. The determination will obviously be with knowledge of the original estimate of duration, but to the extent possible should “repeat the steps of the master” rather than blindly accepting the original duration. Thus, if visual inspection of a 10-day activity appears “50 percent complete,” a starting point for remaining duration may be 5 days, but also may be more or less depending upon how actual productivity compares to that estimated.

A quick review of the assumptions surrounding the original estimate of duration will include confirming the physical scope of the activity from the 48-character description and referenced contract drawings, reviewing the various other codes assigned to the activity, reviewing the resources assigned to the activity, and reviewing the estimated productivity compared to that experienced to date.

If all the assumptions appear unchanged, the visual percent complete may be a good approximation of remaining duration. If, however, the reality requires reassessment of the assumptions behind the original duration, a new estimate of duration may be required for the remaining scope. Keeping in mind that this new estimate is likely to be performed by an individual with less experience than the one who prepared for the initial schedule, the error of the estimate of remaining duration may be larger than that of the original duration. However, the larger percent of error will be for a smaller number.

It was for this reason that a guideline was set for maximum activity durations. Notwithstanding the safe harbor thus created, it is still good practice for the junior scheduler to estimate a remaining duration rather than a percent complete for most activities. The opposite is true for those (hopefully) few activities of a bulk or repetitive nature involving a known large quantity of work, a known productivity, and a resultant large duration, such as a large bulk excavation. Here, the junior scheduler should enter the percent complete calculated from the measured quantity complete. The junior scheduler, however, should be aware if the productivity realized differs significantly from that assumed in setting the original large duration, and call for assistance in reevaluating the remaining duration by the project manager or appropriate area superintendent.

### **27.11. Expected Completion and Renewing Promises**

Similarly, for those activities that are subject to an expected finish constraint and where remaining duration is automatically calculated, a healthy level of skepticism is called for. It is not uncommon that vendors providing products with long lead durations include a “no damage for delay” clause in their contracts along with their salesperson’s personal promise of timely delivery. As part of the process of an update, the Scheduler should call that salesperson, or other responsible party, and inquire if everything is still “on schedule” or if any “glitches” have occurred or are anticipated. In the event that there are any problems, the project manager then has the opportunity to get involved in rectification of the issue, or to explore other avenues of mitigating the impact of a late delivery.

This continual reminder to the vendor of the contractor’s reliance upon the promise can, depending upon State law, supersede the “no damage for delay” language if it is found that vendor deliberately, or even negligently, misrepresented the current status of an open order. For mission critical deliveries, the contractor may choose to avail itself of the Uniform Commercial Code UCC 2-609 Right to Adequate Assurance of

Performance by demanding such status updates. This will not protect the contractor from “last minute glitches” at the vendor, but will certainly reinforce the importance to the vendor of this particular delivery.

### **27.12. Automatic Updates**

Several of the CPM software vendors tout a feature that will automatically update the schedule. Phrased simply, the user enters the new data date and the software converts prior early start dates to actual starts, early finish dates to actual finishes, and calculates remaining durations for those activities with performances that straddle the data date. The help screen for this feature then suggests that the user go back and manually correct the “few” instances where reality did not perfectly mimic the early start schedule.

In the years that the authors have been involved in scheduling, we have rarely, if ever, seen projects where even one quarter of the activities actually start and finish exactly on their baseline early dates. More importantly, this process negates the main purpose of an update, that is, to carefully and methodically check the status of each activity that may or has started. It is the rigor of this process that makes the update a tool for the contractor’s ability to best perform rather than merely a tool for printing a report read by none.

### **27.13. The Forgotten Step: Determination of Remaining Duration Between Activities**

Many contractors believe that the advent of PDM made preparing the initial CPM logic network and resultant schedule easier. However, the added but sometimes hidden power of PDM can make updating the schedule much more difficult. The reason for this is that while the statusing of the remaining duration of activities is visible and understood by the contractor, the statusing of remaining durations between activities is usually left to a default, which is both hidden and not clearly understood.

The first area of misunderstanding is to determine what the lag meant in the initial network. Although this has been addressed earlier in this text, the difference between various interpretations was largely academic for purposes of the initial schedule. The bars land in the right spot regardless of meaning. Now that the contractor is using the CPM to manage the project, the definitions used are more important.

In again reviewing the start-to-start relationship in Figure 27.13.1, it is important to note whether the 7-day lag should measure number of days from the reported actual start or measure when the original duration is reduced to a remaining duration of 3 days. In a perfect

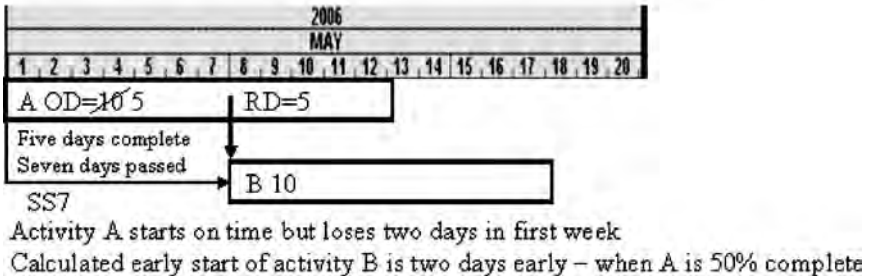
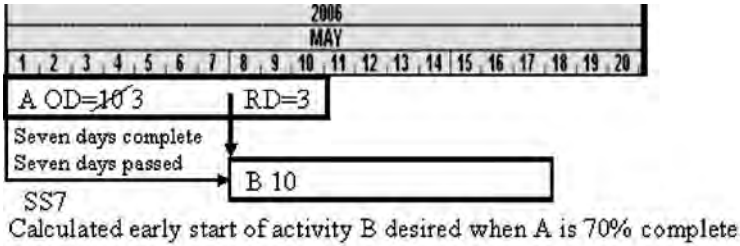
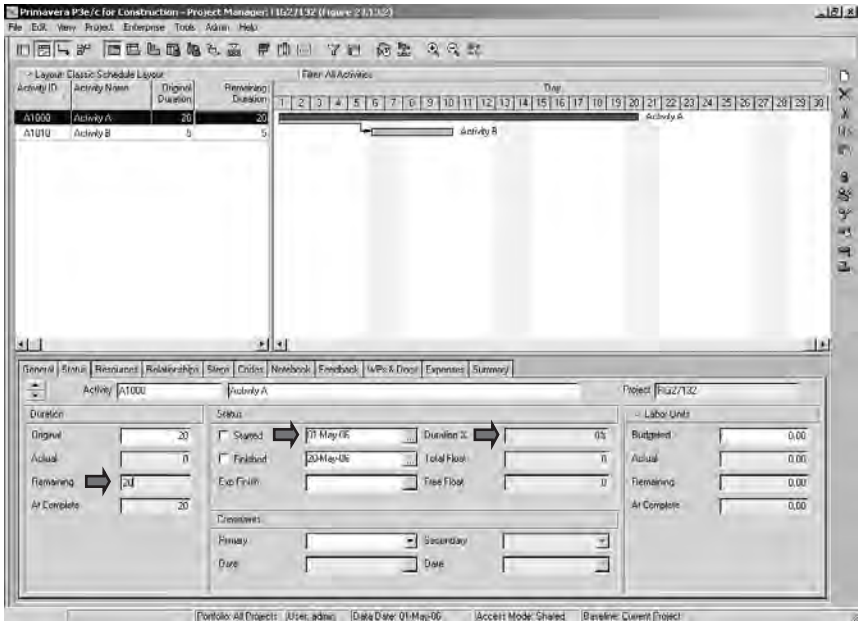

Figure 27.13.1 Problems in Updating PDM durations between activities.

world these two measurements may be the same, but such is rarely the case in the real world. Compounding this issue is that most popular software offerings do not support the second choice, even though it is the one more commonly meant by the project manager providing the original information. Therefore, it is now required that the Scheduler tailor the input for each update to work around the inaccuracies caused by this problem.

The general consensus on reporting an actual start date may be that this is merely historical datum, and can be left blank or “fudged” and corrected later. However, as noted previously, the actual date is now part of the calculation for reducing the lag. If an activity is reported started by entry of a percent complete or a remaining duration but an actual start date is not entered, the lag duration will not be reduced. If the activity is reported as 99 percent complete but an actual start date is not entered, the lag duration will not be reduced. In some software systems, if the activity is reported as 100 percent complete with zero remaining duration but an actual start date is not entered, the lag will not be reduced. Other software systems are written to catch this obvious “error” but then treat 99 percent and 100 percent complete activities in entirely different manners.

P3e/c addresses this problem by locking the entry of a remaining duration or percent complete until after the user has entered a start date. In the real world, this is more likely to elicit entry of a bogus date



**Figure 27.13.2** P3e/c does not allow user to status a reduced remaining duration until an actual start date is entered.

(which is then not highlighted as “to be correctly entered later”) than stopping the update process to research a correct date (Figure 27.13.2).

Thus, to truly update a PDM logic network, it is necessary to print out or view each relationship where a lag is present and to manually review and update such lag duration. Here again, the orphaned status of “durations between activities” is shown as popular software systems do record and distinguish between original and remaining duration of activities, but can record only one duration between activities (Figure 27.13.3).

## 27.14. Save and Rename: Naming Strategies

Update information should never be applied directly to the file for the initial project or prior update. In each case, it is important to copy and rename the file, updating only the new file. And it may be important, if litigation results from a project, to save each and every one of these files. Every software product has its problems with this process. P3 is limited to only four characters for the name of the file, effectively limiting the number of updates based upon the how many of these four characters are to be reserved for noting the project, and how many to distinguish

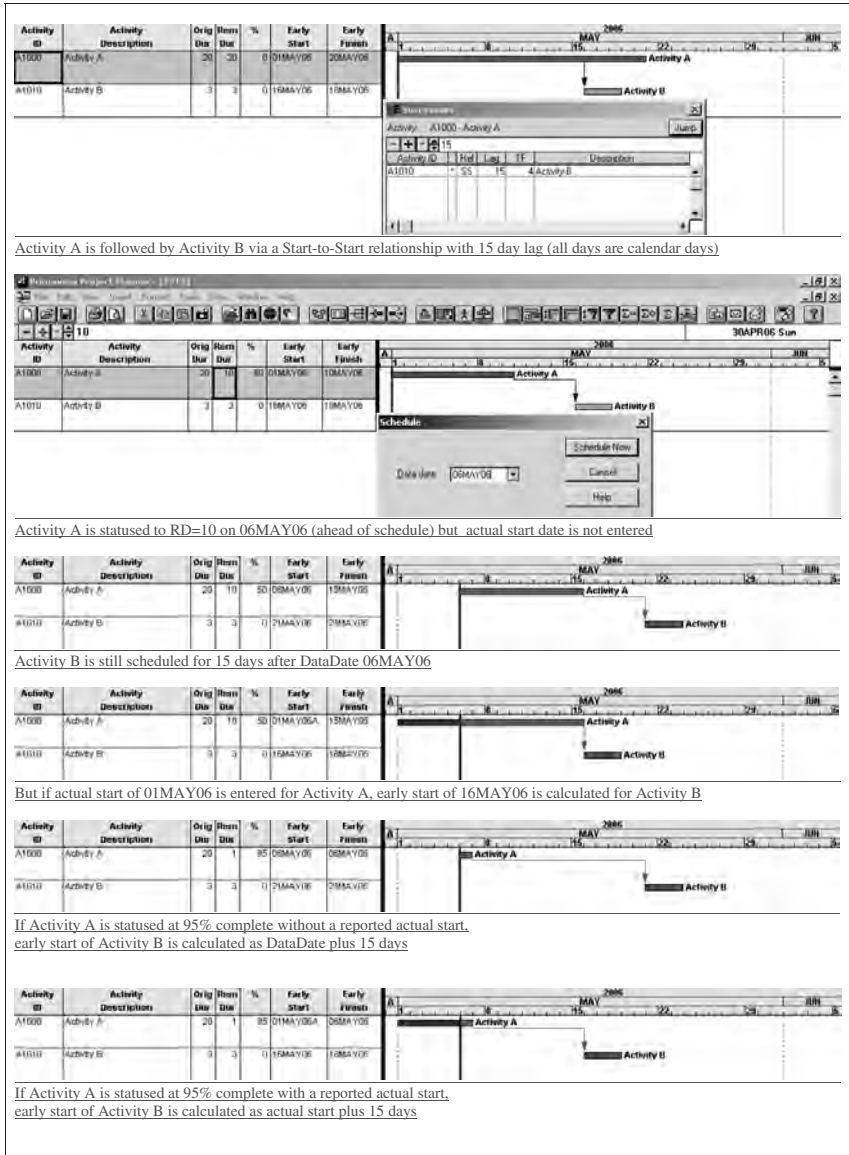

**Figure 27.13.3** Problems with reporting status for durations of activities and durations between activities.

which update or revision to that project. For example, JDOE may represent the John Doe project. If we know we are going to have less than ten updates, perhaps we can name updates JDO1, JDO2, etc. If we expect more than ten but less than 100 updates (not uncommon for multiyear



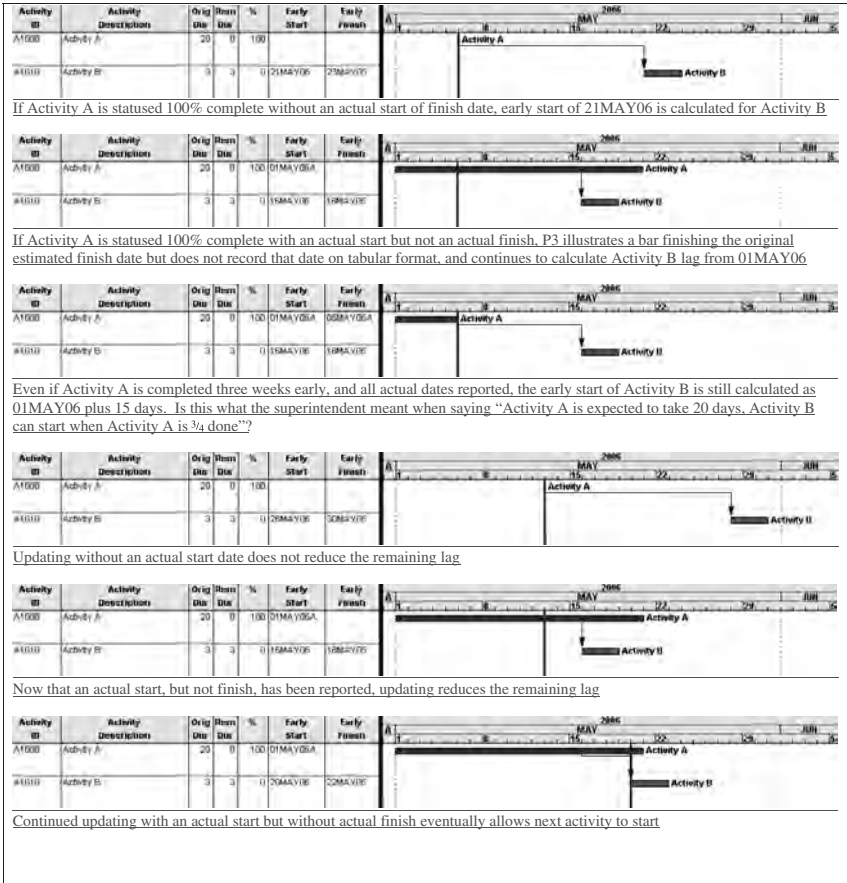

Figure 27.13.3 (Continued).

projects with weekly or biweekly updates), we can name update files JD01, JD02, etc. If the John Doe project experiences a major change order or other mid-course correction, we can remember that JD34 is a revision and not an update, or name the revision JE34, effectively removing the "JE" prefix for other projects in the same subdirectory.

However, in P3, individual projects may be stored in individual subdirectories. Thus naming conventions such as JDOE (for the initial schedule.), U721 (for the update of 2007, February, first update of month.), R752 (for revision of 2007, May, after the second update of the month.), U7d2 (for update of 2007, December, second of month), etc. may be used. Care must be exercised to not mix up the several files named U721 for different projects, but these will be stored in separate subdirectories.



can continue so it is 100% complete for schedule purposes. This and other turnaround forms from other foremen may be collected, faxed to the home office of the contractor and utilized to prepare the next turnaround document.

### **27.16. Electronic Tools to Assist Acquiring Data for an Update**

Third-party hardware and software is also available to allow updating by project control walking the project, including the ability to download the current schedule to a Palm Pilot or other handheld device for updating on the go. The updated information can then be directly uploaded to the scheduling software without the need for rekeying of information.

### **27.17. Choosing the Correct Algorithm for Updates**

At this point, the choices in algorithm made back in Chapter 17 between retained logic and progress override and between calculate start-to-start lag from actual start or early start will become important. The first choice relates to the type of logic used to schedule activities that are in progress. If choosing retained logic, the remaining duration of a progressed activity is not scheduled until all predecessors are complete. If choosing progress override, network logic is ignored and the activity can progress without delay. If choosing the new option provided in P3e/c and Primavera Construction, actual dates, backward and forward passes are scheduled using the users guesses as to future “actual” dates. Note that the actual dates option can cause negative total float if the schedule has work being performed out-of-sequence and “actual” dates before the data date.

Progress override may show better progress, but may also provide a false sense of security. Retained logic may cause an uninformed resident engineer to become nervous, but the authors suggest honesty and education. The use of actual start may make data entry easier for the Scheduler since there will be less adjustments required to the lags of activities started but not yet complete with this option.

### **27.18. Scheduling the Update: Interpreting the Results**

At this point, it is time to run the update, always remembering to reset the data date to the end of the past period and start of the new period. A careful review of the calculated results can assist the entire project team focus upon the real problems every project has, rather than the ones that have generated the most yelling and screaming.

### 27.19. Technical Review: the Primavera Diagnostic Report

Once again, the first step of review is to go to the diagnostics. Third-party diagnostics, such as Claims Digger, may be used to compare the new file to the old file (before or after calculation) to list differences. P3e/c and Primavera Construction have incorporated this third-party program. Any changes between the files, down to correction of spelling errors in an activity description, will be listed. Hopefully, the Scheduler for the contractor will not run into any surprises and will merely verify that substantive changes include only the provision of actual start and finish dates for activities completed, and actual start and remaining durations for activities started and still in progress.

**Sections 1, 2, 3, and 5.** The first three sections of the diagnostic report should remain the same. If a consultant prepared the initial CPM but updates are processed from the field, a different user name and license number should be noted. There should be no additional constraints as part of an update and there should be no additional open ends. During updating of P3, it is possible to accidentally add a blank new activity. If this has occurred, the open end report will note this issue. There should be no changes to the algorithm chosen from the initial schedule submission.

**Section 4.** Section 4 of the diagnostic is the most important section for an update. This section will list some types of data entry errors, such as the accidental entry of a future date as an actual, but most importantly it provides a look at whether the contractor is having difficulty performing to its “plan of execution.” The work performed out-of-sequence report is an indication of either reporting progress to the wrong activities or a warning of disruption.

Chapter 36 describes the issue of disruption and how this report may be augmented to record such issues and quantify the time and cost impact of them. However, from the viewpoint of proactively managing the project, the Scheduler should discuss with the project manager each instance of such work performed out-of-sequence to determine if it merely represents a temporary assignment of resources to work that is available, or a more serious reassignment of resources because planned work is being blocked by some factor.

**Section 6.** The statistics of number of activities started and completed and the rough assessment of percent complete are useful for reports to upper management, but provide little of the detail required by the project manager. However, if the number of started activities begins to

markedly increase above those complete, this may be a sign of either reporting or real trouble.

**Section 7.** Obviously the key date to watch is the calculated completion date. If this improves or remains the same, all is well. If it begins to slip, additional review is necessary to determine why and to correct such before a small problem becomes a large problem.

## **27.20. What to Look for when Reviewing the Update**

In construction heaven, the update will match the initially calculated schedule. In such a venue, the use of the automatic update features of various software vendors may be useful. However, here on Earth, very little goes according to plan. It is the job of the Scheduler to note where variances occur and to direct attention to these areas by the project manager.

The key focus must always be upon the critical and near-critical paths. If there is any delay or disruption of work on the current or near-term activities on these paths, all audiences should be notified of the need to address such issues. If new critical or near-critical paths are being identified as float is expended on previously non-critical activities, this may be a sign of minor problems now becoming major problems. One important metric that should be measured is the number of critical and near-critical activities compared to the number of activities not yet complete. If this number is rising over several update periods, it may be a sign that the available resources are being spread too thin.

As noted from the previous subsection, a rising number of activities started but not finished may also indicate trouble. The listing of work being performed out-of-sequence should also be closely monitored. If items on the list continue to remain incomplete for more than one update period, there may be a question of inaccurate reporting or of a more serious issue. Remember that the definition of an activity in CPM presumes that if a successor can start, that activity must be finished. Ancillary work associated with the activity but not required for its successors is included elsewhere in the logic network in the activity called punchlist.

On the other hand, if the activity truly is not complete, but the successor has been able to start through the use of falsework or other means of mitigation, the disruption necessitating such should be documented for either a change order to the owner, a back charge to a subcontractor or vendor, or for review by the upper management of the contractor. The bottom line is that if the plan was carefully prepared, any work performed out-of-sequence is going to be at a higher cost than anticipated.

**27.21. Tailoring Update Output to the Chosen Audiences**

As noted in Chapter 25, output should be tailored for each audience. The field personnel will probably best be served by quickly being provided with an updated turnaround document. The project manager will also require a copy of the turnaround document, perhaps grouped by area or location rather than by crew or subcontractor. The project manager also should be provided with a report detailing issues of work being performed out-of-sequence with a view toward both corrective action and documentation for purposes of cost recovery.

One project manager client prefers a copy of the pure logic diagram pasted across the walls of the field office, with work completed marked over the logic with a sharpie pen. Primavera’s pure logic view (misnamed its PERT view) does this by default with a single diagonal line across the activity box for work started and in progress and an “X” across the box when complete. Another project manager prefers a time scaled logic diagram (limited to near-critical and other “high profile” coded activities) to hang on his wall. Across the top, he places a thumbtack holding a string weighted by a small plumb-bob, the thumbtack moving 1 week rightward each week. Activities are marked with a

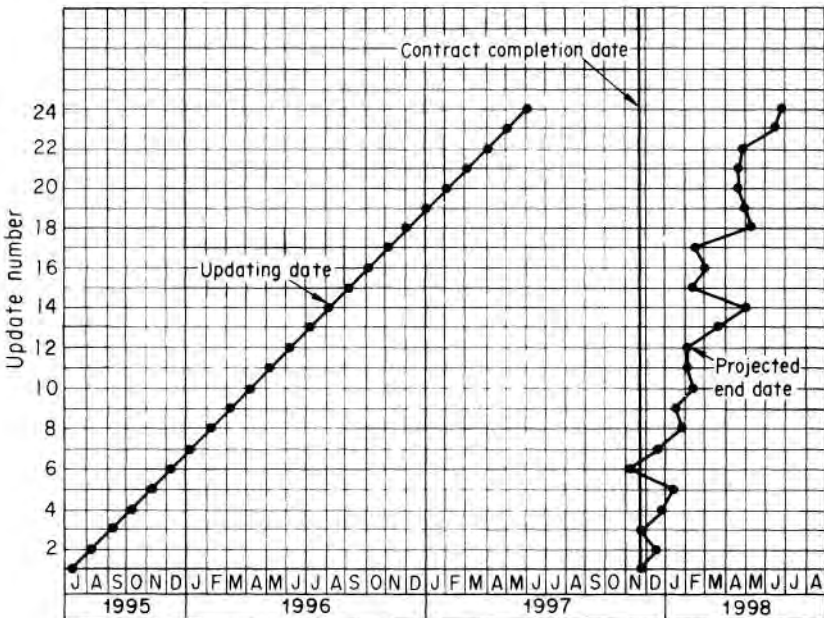

Figure 27.21.1 End date projections by update.

sharpie pen as they are completed as a visual of those not complete to the left of the line indicates falling behind schedule.

Another useful graphic report is the use of a rate chart, such as is shown in Figure 27.21.1. In the illustration, the 45-degree line represents the track along which the monthly update falls. Relative to that track, the end date projections of the updates are plotted. If the plot of the end date is vertical or leans to the left, the project is on or ahead of schedule; if it leans to the right, then little or no progress has been made.

Occasionally a contractor may be faced with an engineer who demands a submission of an update or revision differing from what the contractor believes is factual. The owner and owner's representative, the engineer, must be provided with what is required in the specification. However, providing additional information (clearly marked FYI only) relating to problems encountered may help to bring the engineer into the process of mitigation and correction. If the owner, rather, chooses to consider this adversarial, then the additional reports provide abundant notice of the problem.

The maintenance of the schedule in two configurations (e.g., the approved schedule and the contractor's version of the schedule) at the same time is recommended in such situations and is supported by several court decisions. (See Appeal of Blackhawk Heating & Plumbing 76-1 BCA (CCH), *E.C. Ernst Inc. vs. Koppers* 530F.Supp 830 (1981) and Titian Pacific Construction Corp. ASBCA 87-1.)

## 27.22. The Narrative Report for Each Audience

The narrative reports that should accompany tabular and graphical output should also follow this pattern. The report to the owner or engineer should note the current critical and near-critical paths and any changes or additions (Figure 27.22.1). The report of a stable percent of near-critical to total remaining activities should suffice for discussing non-critical activities; but if the percent is rising, a discussion of the reasons why and corrective measures planned is in order. The work performed out-of-sequence diagnostic should be discussed specifically noting any disruptions caused by factors outside of the contractor's control and related associated costs.

The narrative for the contractor's upper management should also focus on other issues of disruption, such as problems caused by subcontractors or vendors or by downtime caused by equipment or personnel issues. The narrative for the owner's clients (either the upper management of the owner or third-party "clients" to the owner) should focus upon the general trends and general types of problems that may cause or have caused schedule slippage.

## JOHN DOE PROJECT

*Progress Report #8**Next job meeting: March 7*

**ABSTRACT** The project is on schedule. No unusual problems were noted. No major changes in logic or time estimates were noted.

**CRITICAL PATH** The critical path did not shift. It goes through events 49-50-54-55-56 and 58

**MILESTONES** Before next report. Boiler test—complete branch conduit—complete dry wall

**DISCUSSION**

1. The status information (see Figure 12.2) was collected at job site.
2. Electrical work is on schedule. However, a slight crew increase is recommended as the work spreads out.
3. Dry wall (42-44) should be pushed so that ductwork installation can begin. The prefabricated ductwork is scheduled for shipment from the shop this week.
4. The heating system will be operational in one or two weeks.

*Attachments*

1. Computer listing, *i-j* sort
2. Critical path listing from computer run.

**Figure 27.22.1** Narrative report for update.

## 27.23. Summary

The creation of a process of updating the schedule from the initial plan was the initial impetus of the Kelley-Walker group at DuPont in developing CPM. It is still the major difference from static processes, such as a Gantt chart. The effort and care by the top members of the project team in preparing the initial CPM plan will be rewarded by allowing lesser experienced personnel collect update data.

It is important to distinguish between an update and a revision. An update will only add the date an activity actually started and finished, or if not finished, will add a new assessment of the remaining duration of an activity. An update will never modify logic nor allow changes to the original duration of activities not yet started.

In updating activities connected to others by non-traditional relationships, it is important to manually review the lag durations between such activities. Update information should never be applied to an existing file; the file should be saved and copied to another file to which the update data may be applied.

Review of the update should focus upon the critical and near-critical paths and upon variance from the initial “plan of execution,” as may be determined by review of the work performed out-of-sequence diagnostic. Tabular, graphic and narrative reports should be prepared with a consideration of their intended audiences.



---

Chapter  
**28**

## **Engineer's Review of the Submitted Update**

The engineer's review of the submitted CPM update should mimic, to a large extent, the review by the contractor's Scheduler. The purpose of the review is twofold. First, the engineer must be assured that the submittal is accurate and technically correct and provides a true assessment of the status of the project. Second, the engineer should be reviewing the update to determine how the owner can assist the contractor in getting the project completed on time and what the owner must do to minimize the extra costs that are always associated with a project.

### **28.1. Is This an Update or a Revision?**

The first step of review is to determine whether the purported update improperly includes changes to the activities, durations or logic that more properly belong as part of a revision. Unfortunately, popular micro-computer based software accepts keyed data on an item by item basis and does not mimic the old mainframe concept of batch processing. Thus, it is difficult to determine that only the information as agreed between the contractor and engineer has been entered. If a document, such as the turnaround document noted in previous chapters, is used, a copy can be consulted. If updates are performed on a PDA during a walkthrough of the project, even that separate recording of the intended input is lost.

Third party programs, such as Claims Digger, can list all differences between two files. It is, then, left to the engineer to perform the tedious task of checking that each change matches that on the turnaround

document or contemporaneous notes (or memory) of the project walk-through. P3e/c and Primavera Construction include Claims Digger and seamlessly provide its comparison reports.

Although technically any changes other than *AS*, *AF*, and *RD* (or percent complete) represent a revision, minor corrections of spelling and other “housekeeping” changes may be permitted as part of an update, after review by the engineer that they are not creating substantive changes to the network. Similarly, if a minor change to a duration or logic of a non-critical activity will not substantively change the plan or schedule, acceptance of such is within the engineer’s discretion.

## **28.2. The Technical Review**

Since Primavera permits the user to modify the output fields of early and late dates after calculation and without notice that the now recorded dates are not the same as those calculated, the engineer should require an electronic copy of the file and run it on his/her computer. The engineer should then spot check the calculated results against the tabular printouts provided with the submission. Keep in mind, however, that slight variances are to be expected if, for example, the contractor is using SureTrak and the engineer is using P3 or P3e/c.

The engineer should next review the diagnostics, similar to the review performed by the contractor’s Scheduler. There should not be additional or modified constraints. There should not be additional open ends. The options and algorithms chosen should not be different from that in the submission of the initial CPM or prior updates.

Section 4 of the diagnostic should not list activities given actual dates beyond the DataDate. The number of activities being performed out-of-sequence and details thereof should be reviewed very carefully because each one represents some additional and unplanned cost to the contractor for which the contractor is going to be looking for additional compensation. Or this could simply be a sign of bad reporting, for example, failing to report an activity finished because one shovel full of back-fill is still to be placed, or reporting a false start because one shovel full of excavation has been taken from an area scheduled to be worked at a later time.

The engineer should similarly be concerned if the number of activities started but not finished is rising. This again points to either bad reporting or a pattern of interference by some party that is impacting the contractor’s ability to complete its work. Keep in mind that for a proper network, where no activity has a duration greater than twice the update period, the theoretic limit of activities-in-progress cannot exceed the number of new activities started this past update.

### 28.3. The Critical Path

The engineer should focus review upon the work on the critical and near-critical path activities that are expected to be worked upon during the upcoming update period. This should be a relatively small number of activities. The purpose of the review of this subset of activities is to double check that the contractor has provided all necessary submittals to perform this work, the design department has reviewed them, and that any other preparations that involve the engineer or the owner have been made.

The engineer should also compute the number of critical and near-critical activities and divide by the number of activities not yet complete. Here, the engineer may use a personal definition or comfort zone of criticality, be it 2 days, 5 days, 10 days, or more of float. If this percent of near-critical activities is rising, then the engineer should investigate whether the contractor is properly manning the project or has other resource-based bottlenecks.

The engineer should also be calculating the actual durations of activities as a comparison to the original durations and tracking actual resource usage versus planned. If it appears that the contractor is losing money, there may be strong odds that a claim is brewing, whether justified or not. And if the engineer can assist the contractor to mitigate losses without spending the owner's money or increasing his liabilities, this will be to the owner's benefit.

### 28.4. What to Accept and What to Reject

Acceptance or rejection of the submittal of a CPM update is really not going to change the validity of the submission. The engineer should be accepting or rejecting the input data (the actual start and finish dates) based upon the CPM definitions of the activities. The engineer should accept a remaining duration as being the opinion of the contractor, requiring some form of backup verification only if it appears to be seriously in error. When a large duration for quantifiable activity has been accepted, such as for bulk excavation, the engineer should verify that the reported percent complete is accurate.

Improper mixing of update and revision information should be summarily rejected. The update is not the place where the contractor should be adding change orders or making other logic changes. A strict adherence to restricting actual dates to those prior to the DataDate should be enforced. In reality, the acceptance of the update should be a relatively simple matter. The information was properly collected from the field, entered to the computer, and the software properly calculated the impact of this data.

So far as comments in the narrative that may be considered editorial, the engineer should simply note that such are accepted as the opinion of the contractor and that the review of the submittal is not the appropriate forum for agreement, disagreement or rebuttal. Furthermore, since the CPM update submittal is merely another shop drawing of the current conditions and calculated projections based thereon, the review is also not the proper forum to discuss concerns over under-manning or other perceived ills of the contractor. These deserve a separate letter by the chief resident engineer.

### **28.5. Summary**

The submitted update of the CPM allows the engineer to determine if the project is continuing on course or is falling behind. It also may be used to determine if the contractor is having difficulties that may result in a proper or improper claim against the owner.

The first check by the engineer should be to be assured that the submittal is strictly for an update and does not improperly mix an update with a revision. Next, the engineer should verify that the input to the update (the actual start and finish dates and remaining durations for work-in-progress) is correct and matches what exists in the field. The engineer should run the update file on his/her own computer to remove the temptation of cheating from the contractor.

The engineer should carefully review the diagnostics to determine if and where the contractor is deviating from its “plan of execution” and determine the reasons why. The engineer should review the near-term for the critical and near-critical paths to be assured that the engineer will be ready to assist so that this work is performed in a timely manner. The engineer should also check for signs of under-manning or lack of progress on non-critical but soon-to-be-critical work.

The engineer’s acceptance of the update should be limited to agreement to the input and to the form of submittal. Opinions of the contractor as to the cause for delay or disruption should be noted as heard, reserving the right to respond to a more proper forum. Nonetheless, the engineer should be watching for contractor problems before they are brought as claims.

## Revising the Logic Network

Murphy's law states that if anything can go wrong, it will; and even "the best laid plans" often go awry. One of the most salient features of the promotion of CPM at DuPont was that design changes requiring a 40 percent change in the plan recorded in CPM format required only 10 percent of the effort required by a traditional scheduling team to implement. Thus, if major changes are required in a project under way, the project team should be able to prepare a revised logic in a reasonable amount of time.

But for the more common small changes, the revision process is even more powerful. The contractor and owner may explore the impact of one or multiple proposed changes. The impact of a CIC (change in condition) or unresolved RFI (request for information) can quickly be ascertained. And the impact of a catastrophe or mere misfortune by the contractor (such as equipment failure) similarly can be calculated.

### 29.1. "What If" versus Committed Changes

The contractor is often asked to price an estimate or prepare a quote on various proposed change order work. The difference between the estimate and the quote is that the first is merely an intelligent opinion. The second case constitutes a legal offer to perform at the stated price. If the scope of the change is complex and possibly unclear, the contractor may add a disproportionate contingency premium to the price, or may refuse to provide a quote at all, demanding that such work be done at its actual time and material cost.

Similarly, the contractor is often asked to provide a time impact analysis for a proposed change. In the same manner as for the cost proposal, this may either be advisory and thus the risk of error falls upon the owner, or guaranteed, in which case, the contractor should certainly

provide a contingency commensurate with the risk involved. In either case, the cost of preparing the estimate of cost or time impact usually cannot be directly recovered unless the owner goes forward with the proposed change, and thus the contractor has an incentive to keep the costs of the estimating effort low and the contingencies high. If the rare owner agrees to pay for this estimating work on his/her behalf, more accurate estimates and lower contingencies may be received.

The first step in these “what if” analyses, is to copy the electronic files for the most recent update and rename the new file (Figure 29.1.1). The original file should be set as a target of the “what if” file (Figure 29.1.2). Placing two bars, one for the last update and the second for the revision, side by side allows a graphic means to assess the impact of the revision.

Additional activities representing the new scope of the proposed change should be inserted into the logic network, starting at a point where the physical infrastructure required on which to place the new work is to be performed, and ending at an activity that cannot start until the new work is complete. The durations of the new activities (or modified durations of existing activities) should be supported by the same

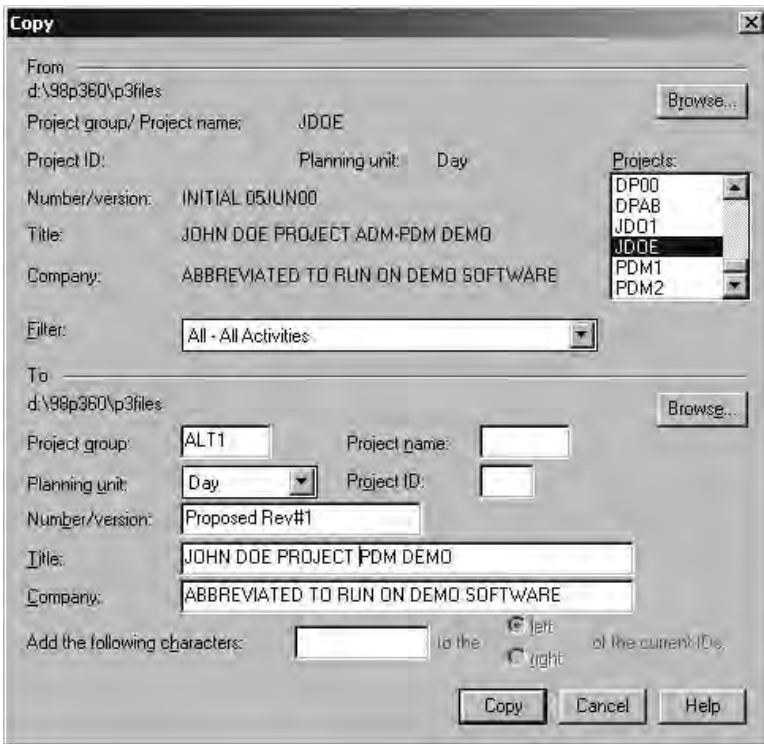

Figure 29.1.1 Copy files command.

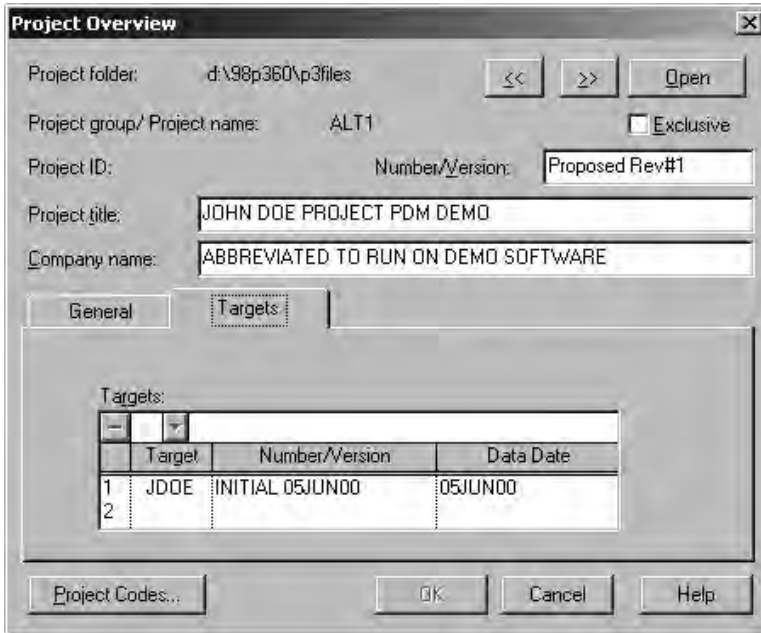

Figure 29.1.2 Project overview—rename version.

backup data provided in the initial CPM, that is, crew size and type, equipment to be used, and so forth.

Next, the contractor must determine from where the resources to perform this additional scope will come. There is a non-trivial cost to bringing in an additional crew or an additional crane to the site. If the contractor chooses, or is directed to divert resources from non-critical work, there are still the costs of disruption. If the contractor is directed to divert resources from critical or near-critical path activities, there will be both a cost and time impact, even if the proposed extra work would not be on a “critical path.” If multiple proposed changes are being considered to be performed during the same time frame, the contractor can only assume the worst case scenario that extra work on non-critical paths will divert resources from critical path work.

## 29.2. Changes: Approved, Constructive and at Contractor’s Cost

Before a change order should be added as a revision to the CPM, it should be added to the contract. Until the change order is “signed,” or may be deemed by law to be constructively “signed,” or the contractor receives a written proceed order, the change should not be incorporated

into a submitted revision. A constructive change order is one where the “signature” will be provided by a Court, even if the parties have not formally agreed. For example, if you walk up to a hotdog vendor in New York City and request one “with sauerkraut,” and it is supplied, there is no question that you have a contract to pay for that hotdog even if the words on compensation were never spoken.

There is also the change to the “plan of execution” that is due solely to the contractor’s failure to include such base bid scope in the initial CPM. Unless there was some ambiguity that such work was to be performed by the contractor, the acceptance of the initial CPM by the owner or its engineer will not relieve the contractor from performance. However, once the bid estimate or CPM preparation error is discovered, it will modify the contractor’s “plan of execution” and must be incorporated into the logic network the same as any other change. The only difference is that this change will be chargeable to the contractor and not to the owner. A crane failure or other catastrophe should similarly be added to a revision to the last update prior to the incident.

### **29.3. Revised Baseline**

In some instances, the quality or quantity of changes, from the side of either the owner or contractor, require a complete re-think of the “plan of execution” for the remainder of the project. A similar situation might be caused by the default or termination of a contractor. In either case, the project team should be planning an entirely new project based upon the scope remaining. In such an instance, it is appropriate to first determine the delay (if any) to the project as of the date of the re-think and then plan a new project from that point in time.

The completion date for this new project may be set at the original contract completion if the engineer believes that a Court will determine the causes of delay to be solely that of the contractor (and for which the owner will pay acceleration costs if the engineer’s belief is unfounded) or at the delayed date, to which the engineer believes a Court would find that the contractor is entitled to an extension of time, or to any date in between. The mechanics of preparing the revised baseline are to bring all work performed to date to one new milestone activity, and from this new starting point, begin the planning of all remaining work. In many cases the project leader if not the entire project team may have changed, and although it may be easier to reshuffle the existing activities with new logic, this should not be a requirement. The bottom line is the desire for a new network from this point forward that demonstrates the ability to complete the project by the newly agreed or dictated completion date.



#### **29.4. Update then Revise**

If various factors call for a revision during the course of an update period, the proper order of analyses is to first prepare the update and determine how the project performed during the past period, and then to apply the revisions to the new update. Maintaining this order is good practice, even if it calls for preparing an extra update between the updates required by a specification. To recap, updates measure the impact of the reality of the past, revisions measure the impact of the forecast of the future.

#### **29.5. Summary**

Revisions to the network are required whenever the assumptions of the original “plan of execution” are no longer accurate. The first step of a revision is to copy the last update to a new file. Additional activities must be placed based upon “physical” logic restraints—leading from work that must be complete before the new activity may start, and leading to work that cannot start until the new activity is complete. Serious consideration must be given to the provision of resources to perform the extra work and from where such resources may be diverted. It is important to always update before revising a network.

*This page intentionally left blank*

## Engineer's Review of the Submitted Revision

Review of a submitted revision of the CPM logic network should be handled similarly to that of the initial CPM submittal with two important caveats. The first is that the engineer must be particularly on guard for the risk that the contractor may use this opportunity to “cook the books” in preparation of a claim for additional time and perhaps money. The second is that management of the owner may desire the engineer to improperly use his/her authority to pressure the contractor to “cook the books” on the owner’s behalf.

One of the first questions should be to determine the type of revision submitted. The revision may be simply the adding of various unanticipated events and other causative factors with the purpose of illustrating the impact of them upon the existing “plan of execution.” This, in turn, may be the basis for the granting of additional compensation to pay for the costs of demonstrated disruption or an extension of time for a verified delay. Alternatively this may be the basis for a request (or demand) for a recovery schedule involving either a minor revision (such as selective overtime on the current critical path) or a major revision (involving a total rethink of the “plan of execution” for the remaining scope of the project).

### 30.1. Minor Revision

The first step in reviewing a revision to the CPM logic network is to verify that the narrative of the submitted revisions matches the changes to the computer file. This can be accomplished by use of Claims Digger software product (included in P3e/c and Primavera Construction) or by other means.

The second step is to review the content of each change to the current approved baseline CPM schedule. If the change is merely to the scope of an existing activity, increasing or decreasing the duration of it, the parties may agree on the change in duration or it may be treated as a proceed order or directive, leaving the determination of the impact until after the work is performed.

If the change involves new work requiring a new activity, the activity should be placed into the logic after the completion of the physical infrastructure required to perform the new work, but also subject to a constraint based upon the date when the contractor was authorized to perform the additional work. (Authorization in this context usually requires a signed change order for an agreed price or a proceed order to perform such work on a time and material basis.) Based upon whether or not the parties have agreed from where the resources to perform the additional work will be provided, changes to logic relating to such resources (craftspeople, equipment, or forms) may be appropriate. A change order not addressing such concerns or reserving rights related thereto implies the contractor expects to bring in fresh resources or utilize some portion of the float of non-critical activities.

If the change involves a stoppage of work due to an unanticipated condition, the impacted activity may be broken into two portions. Although theoretically, it may be possible to record a suspend date when the work was stopped and utilize a start-to-start relationship to the causative event followed by a finish-to-finish relationship to the remaining portion of work (for which a resume date will be recorded at the appropriate time), the erroneous loop detection issue previously discussed prevents this more elegant solution.

In many cases the liability for a change to the logic network is disputed. For this reason, the activity descriptions should reflect what is the issue rather than who is responsible. For example, the contractor may be required to redo work that he/she claims is correct but the engineer claims is defective. A responsibility neutral description of this new scope may read, "Demolish and Re-Pour Column 27N claimed defective." The engineer's review and acceptance of the revision to the CPM may certainly reserve rights relating to characterizations of responsibility for claimed changes.

But what if the engineer believes that the changes are part of the original scope of the project? The same logic applies. Certainly the work discussed is not already in the schedule and may also not be in the contractor's bid. The question of whether the work is in the contract plans is irrelevant to the scheduling question. In either case, the work still must be performed.

### 30.2. Major Revision

In some instances, the contractor will desire to make a major revision to the plan. This may be due to the loss or acquisition of major equipment, such as replacing two small cranes with one large crane. The entire sequence of construction, or "plan of execution," will be impacted by this change. The contractor will also expect other parties, including both his own subcontractors and agents of the owner, to modify their plans to mesh with the new master plan.

A major revision may also be required to a major change order that significantly disrupts the original "plan of execution." In either case, the most important step to be taken by the engineer in review of such a revision is to properly update the current CPM and otherwise document the status of the project and its schedule prior to the abandonment of the current plan. The new plan should then be reviewed on its own merits with a view that revisions are for future while updates record the past.

### 30.3. Recovery Schedule

A special type of major revision is a recovery schedule. The purpose of the recovery schedule is to modify the current plan because the schedule slipped for whatever reason, with the goal of regaining whatever time was lost. This may merely involve reduction of selected durations by means of overtime, larger or multiple crews, or larger equipment. A slightly more serious revision will require deletion of at least some resource logic with the intent of working two areas concurrently (with two crews and two sets of forms), which was planned to be performed sequentially. The original notation of physical versus resource restraints previously suggested becomes very useful for this type of exercise.

If the project encountered serious delays, the current plan may need to be scrapped and the remainder of the work replanned, almost as a new project. (And if the contractor defaults or is terminated, this is exactly what will be done.) However, as noted previously, the reason for the recovery schedule should be responsibility neutral. A great deal of discord is often raised on projects when the engineer demands a recovery schedule and the contractor provides an acceleration schedule. As long as each side makes its position known, the submitted and approved plan is not going to be judged by a Court based solely upon what it is called.

### 30.4. Summary

The engineer's review of a submitted revision to the CPM requires care in preventing the contractor from "cooking the books" while professionally avoiding pressure by the owner to do the same for it. The first

step of any revision is to have a full and complete update of the status of the project prior to modifying the approved baseline plan. Minor revisions involving adding various changes and unanticipated events to the last update to determine their impact should be done on a contemporaneous basis. Major revisions to the contractor's "plan of execution" should be preceded by a full audit and documentation of the current status of the project. A recovery schedule or acceleration schedule should be reviewed with responsibility neutral bias.

---

Chapter  
**31**

## Case Histories

After 40 years of experience with CPM, thousands of case histories can be recounted. Many are unavailable for publication because of their proprietary information. The increase in construction litigation in the past two decades has dampened any enthusiasm for releasing scheduling data, further limiting the availability of case histories.

Some case histories memorialize early network applications and were used like foundation stones in building the credibility of the approach. In one application, the Bureau of Labor used networks to plan the publication of annual statistical results. The first computation of the plan showed a critical path of 420 days, which was 50 percent longer than the target schedule. A study of the critical path indicated that more than 25 percent of the time was absorbed by the interdepartmental mail system. Through revisions in planning, and by upgrading the internal mail delivery system, a 269-day work schedule was achieved.

What follows are case histories that reveal the importance of CPM in construction projects when properly planned and applied.

### **31.1. Chicago Courthouse**

Paschen Contractors, Inc. used network planning to build a \$32 million courthouse and federal office building in Chicago. The company worked with 17 major subcontractors to develop the basic network for the courthouse. The immediate benefit of which was a better understanding on the part of the subcontractors about their responsibilities.

An example of the effectiveness of the planning and subsequent analysis of the network involved the elevators and the power transformers they required. The electrical company had planned to use the elevators to hoist the power transformers to the roof, however, the elevator

company was depending on the same transformers being already installed to operate the elevators. It also became apparent that, although steel erection was on the critical path, pouring the concrete floors was only 2 weeks behind that activity on a near-critical path. Accordingly, any time gained in steel erection had to be carefully compared with the progress in floor pouring. The planning group made up a detailed network for carrying out structural work on the basement and 9 of the 30 floors in the building, which was sufficient to provide detailed plans for the remaining 22 floors.

### **31.2. Times Tower**

The total renovation of the historic New York Times building for use by the Allied Chemical Corporation was performed with a detailed CPM plan consisting of 1200 separate activities. Allied decided to remodel the 60-year-old building rather than build a new one because, under the New York City building and zoning regulations, a new building on the site would have been limited to 12 stories rather than the existing 23.

The total renovation consisted of stripping down the basic steel framework and then rebuilding, retaining many of the features of the famous landmark. The contractor, Crow Construction Company, made direct use of CPM planning. Construction equipment, workers, materials, and all work vehicle flow had to operate without interrupting the steady flow of pedestrians and city traffic at one of the busiest intersections in the world. CPM was a crucial factor in the timely completion of the project.

### **31.3. Airport Construction**

Highway and pipeline projects depend on the effective use of resources for timely completion. Building projects, on the other hand, rely more on the sequence of work activities within the confined areas of the building(s) being constructed. Airports offer problems in both areas, and CPM has been used very successfully to solve these problems. During the early 1970s, many major airport construction programs used network analysis and control in one form or another, including both the Philadelphia and Pittsburgh International Airports.

Another successful application of CPM was the expansion of a runway for the Allegheny County Airport in Pennsylvania. The 2-year project was completed in 18 months, not only because CPM identified opportunities for saving time but also because of the contributions made by the balanced team of owner, contractor, and project manager.

The project consisted of a 1000-foot extension to the main runway, which was complicated by a four-lane highway, three railroad tracks, and



a ravine more than 100-feet-deep in the path of the extension. A rigid-frame, precast concrete underpass, 144 feet wide  $\times$  828 feet long, was constructed to house the highway and the railroad tracks. Approximately 1 million yd<sup>3</sup> of embankment was used to fill in the ravine. The general contractor, W. P. Dickerson, actively cooperated in the CPM planning and the implementation of the CPM plan-cooperation that was most important to the success of the operation.

CPM established a target completion date of December 9 for the underpass, and actual completion occurred on December 23. That completion was a key activity, ensuring that work on the project could continue through the winter.

The second most critical activity was the relocation of four phases of the Union Railroad track, which was completed five days ahead of the CPM target date. With the aid of CPM, the CM and the contractor were able to coordinate the manufacture and delivery of precast, prestressed concrete beams after an initial analysis indicated that construction would be delayed without the beams. The contractor studied his precast plant facilities and offered to expand them if the county would pay for the inventory of the beams. The county agreed that having the beams available to meet the schedule was important and, therefore, underwrote the inventory costs so the supplier was able to meet the construction schedule.

CPM was also used to evaluate the effects on meeting the schedule of a number of other considerations, including relocating a graveyard, securing additional foundation material, substituting foundation materials, and a strike. In some cases, the CPM analysis indicated how measures to expedite could be undertaken; in others, it pointed out that a longer timing than originally hoped for would have to be accepted.

The major vertical structural members of the tunnel had to be braced during curing and prior to pouring the tunnel's roof. CPM was used to plan the entire forming, pouring, and stripping sequence of activities and to evaluate special bracing equipment to expedite the entire operation and ensure its timely completion. The information on bracing that CPM provided required the contractor to order additional braces, which permitted pouring the tunnel's roof to proceed as originally scheduled. In the end, the contract was completed six months early.

### **31.4. High-Rise Construction**

High-rise contractors have used CPM both to study the activities required on a single typical floor and to correlate the activities in summary fashion for work on all of the floors. In constructing the Chicago Marina City Towers, the James McHugh Construction Company used CPM to plan two 60-story towers, including 20 commercial and parking floors.

Initially, a detailed critical path diagram was developed for a typical floor, which was then used to study what the rest of the project would require. It was decided to complete the first few floors at the rate of one per week and later accelerate to two and a half floors per week in the east tower and two per week in the west. The complete activity range was regenerated in detail for all of the project, resulting in a network of 9600 activities that was used successfully.

In the construction of a high-rise building in the Bronx, the superstructure was on the critical path, which is a usual situation. Through intensive coordination, the contractor was able to achieve a 3-day pouring cycle per floor. As the project progressed, the cycle was cut to an almost unbelievable 2 days. However, in concentrating the supervision of the reduction of time spent on the superstructure work, the plumbing riser work that followed became critical. CPM highlighted the need to accelerate the riser work, and if that had not been noted, the 2-day cycle achieved for superstructure work would have had little effect on the completion date because the riser cycle was still at 3 days.

In Phoenix, Arizona, the Mardian Construction Company used CPM scheduling for all its projects and for apartment buildings in particular. One of the projects was a 22-story Executive Towers apartment building in which concrete framing was completed in less than 88 days. The superintendent attributed much of the success to CPM planning.

The prime factor was the development of a feasible forming system and the choice of a tower crane as a result of early CPM planning. One floor was scheduled in great detail, and then the information was recycled for the rest of the high-rise. Close monitoring of the project resulted in a reduction of the basic floor cycle from 4 to 3 days, but the CPM plan demonstrated that the shoring required to continue the phase was uneconomical, so the 4-day schedule was reinstated.

In Philadelphia, the Arthur A. Kober Company, a developer-builder, collaborated with OKA to develop a CPM schedule for its \$35 million Academy House Condominium. This 37-story high-rise, including three subsurface levels for parking, was built on a congested urban site. The structure was of reinforced concrete with a brick exterior. The foundation work was complicated by the need to underpin and brace adjoining structures, including the historic Academy of Music.

The upper 30 floors were residences, and apartment color and material selections were coordinated with the construction schedule. The public areas, except for the condominium service portion, were shelled, and the work leapfrogged up the structure into the living units. Every tenth floor housed temporary shops, and two cranes were used.

### 31.5. NASA

Network analysis was used in all of the major contracts awarded for work on and at the Apollo launch complex at Cape Canaveral and for similar space project contracts awarded earlier and later. The level of detail used in the network systems varied, as did the forms of the networks. One of the major applications was under the direction of the Corps of Engineers, Canaveral District, and it included the review of independent contractors' networks and the correlation of this information into a master analysis network for the vertical assembly building (VAB) and related facilities used for the Saturn program.

The approach was to require both systems and construction contractors to provide network schedules. In turn, both NASA and the Canaveral District Corps of Engineers (under Major General W. L. Starnes) used network-based PMIS systems to monitor and evaluate the network input from the contractors.

In the Saturn program, an unused launch complex control room was turned into a war room (later dubbed the "moon room") displaying the many contractors' networks at various levels of detail. Today, the use of networks to plan and control space programs has become routine procedure for most projects, including the space shuttle.

### 31.6. Housing

The Rouse Company used CPM to plan the engineering and site development phases in constructing the new town of Columbia, Maryland. Activities related to grading, sewers, water, electrical service lines, and paving were coordinated so that entirely developed areas were ready for housing construction. CPM was also used to plan the building of the town center, an engineered lake, and the sewer and water utility connections to service the first completed part of the town.

CPM was credited with the on-time delivery of 300 duplex housing units for a Navy housing project at the naval station in Rota, Spain. The CPM program analyzed more than 3100 required operations, including not only the prefabrication of the housing units, but the distribution of available workforce and equipment resources, as well as activities relating to site preparation, utilities, roads, and foundations.

The plan included a sewage station and distribution system, and it was used to determine the basic field crew size needed to erect prefab units most efficiently. The crew size decided on was 12 workers, including a superintendent, a crane operator, a rigger, an electrician, and a plumber.

The study also helped in the selection of such equipment as air-powered hammers (the need for which was determined after it was

pointed out that 5000 nails per duplex would be used). Stateside fabrication speeded up operations by premanufacturing 80 percent of the buildings.

### **31.7. Manufacturing Facilities**

Butler Manufacturing used network techniques for planning the construction of a 95,000-ft<sup>2</sup> plant in Knoxville, Tennessee, which had to be completed within 20 weeks. Preplanning by the owner indicated that deliveries from a sole source would materially shorten the implementation period. This information was used as the basis for justifying the sole source purchase of the Butler building. Complete sections of the building were prefabricated and organized as units and zone-delivered to the site. The design development identified the need for 26 cranes, and the cranes were added without a delay of even a day.

Another major systems facility delivered for partial occupancy within 6 months was a 300,000-ft<sup>2</sup> building in Georgia developed for use by Lockheed in constructing its C5A transport plane. The design was carried out by the Atlanta-based firm of Heery and Heery, which had previously used CPM to complete the Atlanta Braves stadium on time.

In this case, a different form of preplanning was used. The architect-engineers drew on the preplanned Inland Steel modular systems' design, which was developed as part of the School Construction System Development (SCSD) in California. The system was based on a pre-designed 4 ft<sup>2</sup> horizontal module, including structural and ceiling lighting systems.

CBS Records was proceeding with design of a plant at a new site to manufacture and distribute records and tapes. Because of the close integration needed between the manufacturing/processing and storage equipment to be used at the facility with the plant's construction requirements, CBS Facilities Engineering decided to develop a CPM network for the various equipment development, design, and procurement lead times and decision points. A detailed CPM network illustrated the various actions required and their interfaces with the design process for constructing the facility by the outside designer.

General Electric's Aerospace Division in Valley Forge, Pennsylvania, used CPM plans to monitor the performance of developers and contractors in the delivery of more than 20 facilities at the height of its aerospace programs. In addition to requiring contractor networks, facility manager John D. Orr had in-house training seminars for his facilities engineering staff. (Organizations such as Corning Glass and Celanese have used the in-house seminar approach to either introduce or revitalize CPM planning for facilities.)

### 31.8. SEPTA RailWorks

When Southeastern Pennsylvania Transportation Authority (SEPTA) assumed operation of the former Pennsylvania and Reading rail lines in 1983, it inherited a network of bridges, track, and overhead power lines (catenary equipment) that had already been in service for many years. Decades of deferred maintenance and virtually no dedicated capital funding had resulted in a useable but deteriorating rail system.

The commuter tunnel, completed in October 1984, connected the once-separate rail lines; it allowed all regional rail lines to access the three center-city rail stations: Market East, Suburban, and 30th Street. Several months after the tunnel's completion, an engineering inspection study found that many of the system's bridges, some of which have stood for nearly 100 years, were in critical condition.

The four-mile stretch of track between Wayne Junction rail station and 9th and Brown Streets in North Philadelphia was listed as a renovation property. The stretch consists of track and catenary system and 25 rail bridges—a total of 16 track miles—forming part of the main line, or throat, of the old Reading line. Six SEPTA regional rail lines feed into this central corridor.

The completed project cost approximately \$300 million, secured mostly from UMTA (now FTA) grants. The project, named SEPTA RailWorks, entailed major infrastructure rehabilitation of this regional rail corridor. The major components of the work included renovating five bridges, replacing 20 bridges, replacing all of the track, adding new power lines (the catenary system), and replacing related equipment, including switches and signals.

All of the bridges, except one that crosses a stretch of Conrail track at Wayne Junction, span active highway crossings in a congested urban area. RailWorks also resulted in two brand new rail stations: the Temple Station and the Fern Rock Transportation Center. Fern Rock Transportation Center provided a new, permanent connection to the Broad Street subway line. During the two summer shutdown periods, R2, R3, and R5 riders used this line as a temporary transfer point to the subway, allowing continued access to center city.

RailWorks entailed a 3.5-year construction period, which began in August 1990. The track shutdown periods were scheduled from April 1992 to October 1992 and May 1993 to September 1993.

#### Scheduling

Primavera was the base scheduling system used both by the contractors for project scheduling and at a higher level for program integration by the CM (OKA).

A preliminary and final schedule was required to be submitted by each contractor, and after approval by the CM and SEPTA, cost was loaded and the resulting document (known as the “value line”) was used for payment purposes. Monthly schedule updates were used as the basis for contractor payment requests in a conventional manner.

In addition to SEPTA’s normal scheduling requirement, the RailWorks program also required the contractor to prepare and use a detailed “window schedule” for managing the work during the construction windows. This also was a Primavera schedule, but it was prepared in much more detail, was resource-loaded, and was updated weekly. It was not, however, used for payment purposes.

A program master schedule was prepared and maintained by OKA, and the contractors provided 2-week look-ahead schedules. The contractors also provided a schedule of any track outages they required and a detailed schedule of operations during outages.

The emphasis on preplanning paid off on the first shutdown window. Everyone, particularly the contractors, were focused on the liquidated damages. These were set at \$70,000 per calendar day. Not surprising, the first shutdown completed 3 days early. The second shutdown was a shorter window, but the contractors had gained confidence in the first shutdown. The second shutdown completed 1 to 2 weeks ahead of the system restart date.

### **31.9. New Jersey Turnpike Authority 1990–1995 Widening Program**

The New Jersey Turnpike Authority (NJTA) had a program to widen the New Jersey Turnpike between exits 11, New Brunswick, and 14, the Newark Airport. This stretch of the turnpike is made up of four roadways, each three-lanes wide. The two inner roadways are used for northbound and southbound passenger vehicle traffic. The outer roadways are used as truck and bus lanes. Passenger vehicles are allowed in the outer roadways. The project widened the outer roadways to four-lanes wide from exit 11 through exit 14. The construction value of this project was approximately \$250 million.

The NJTA developed a team approach for the management of the project, with three levels of management between the NJTA and the 27 contractors that actually did the construction. The top level was the program manager (Hill International), whose most important role was reporting the program status to the NJTA. The program manager got most of its information from another part of the team, the construction manager (Howard, Needles, Tammin & Bergendorff). The construction manager had the task of providing continuity among the various design engineers and oversight engineers.

The program was divided into five sections from south to north. Each section was assigned to one of five section engineers (one of which was OKA). The section engineer was responsible for the actual construction oversight. Responsibilities included monitoring the progress schedules and progress payments and the inspection of the work itself. Twenty-seven separate construction contracts were spread across the five sections.

In order to standardize the numerous project schedules, all contractors were required to prepare project schedules using Primavera Project Planner. Using a standard scheduling specification ensured that each of the 27 project schedules would be compatible with all of the others.

Each project schedule was the responsibility of the respective contractor. The first review of baseline submissions, as well as monthly updates, were provided by the section engineer. In addition, the construction manager reviewed each project schedule for the interrelations between adjacent contracts. To improve its programwide perspective of each individual project schedule, the construction manager, through the efforts of a scheduling consultant, prepared a composite schedule by merging all of the individual schedules.

### **31.10. JFK Redevelopment**

The JFK 2000 program was started in 1987 for 2000 completion. It was the first major upgrade to the airport since the 1960s. The upgrade was planned from 1987 to the groundbreaking in 1989. The Port Authority of New York and New Jersey (PA) selected OKA as the program manager (PM) and Bechtel/Tishman as the construction manager (CM). The program, funded at \$1.66 billion, included:

- Airport traffic control tower (tallest in North America)
- Roadways, including high-occupancy vehicle system (HOV)
- Airport utilities
- Early action/preliminary phasing: building 14 (former PanAm hangar) and preliminary construction phasing
- Terminals: East Garage and expansion of IAB federal inspection services (FIS)
- Passenger distribution system

Private projects included hotel development and co-generation. Work plans and schedules were revised in 1992, especially for projects planned for the later years of the capital plan, such as the passenger distribution system and International Arrival Building and Federal Inspection Service expansion.

The design and construction of the automated, on-airport passenger distribution system (people mover) was delayed until the conceptual design and financial issues for the system were coordinated with the design of an off-airport, transit connection with city and state transportation agencies. During the first quarter of 1991:

- Contract negotiations and architectural/engineering design development for a new \$250 million co-generation plant made significant progress.
- Construction under roadways contract package 1 continued ahead of schedule, and roadways contract package 2 went out for bid. Planning and programming of terminal frontage roadways continued.
- Concrete for the airport traffic control tower shaft was completed at a height of 291 feet.

A new program budget was established at \$1.66 billion. It included the \$275 million spent as of January 1, 1991; \$985 million spent between 1991 and 1995, and \$400 million to be spent in 1996 and beyond. The second phase of the program will incorporate an automated, on-airport people-mover, or passenger distribution system (PDS).

The PM used ARTEMIS to produce schedule network drawings and network reports validating logic computer reports submitted by the CM. The CM used Primavera software to produce schedule network drawings and network reports validating the logic computer reports submitted by the contractors. To ensure that schedule data were transferred from the CM's Primavera scheduling software to the PM's ARTEMIS software, the CM prepared a computer disk file for each activity within the network.

The CM reviewed, approved, and monitored the contractor's detailed construction schedules. The CM also developed and maintained preliminary, baseline, preconstruction, construction, and as-built schedules at the subproject summary level by using Primavera scheduling software. The CM developed work-around scenarios with the contractors to ensure final on-time completion.

The PM developed and maintained summary schedules at the program, subprogram, and project levels through all program phases, based on designer and construction manager input, by using ARTEMIS. The PM also audited the construction manager's and designer's project summary schedules and subsequently provided the management reports evaluating the subprojects, projects, and overall program.

As the JFK Redevelopment plan continued, the need for an entirely new International Arrival Building (IAB) was identified. Phase II focus shifted to this project, valued at more than \$800 million.

The ARTEMIS system required full-time programming support. OKA shifted to its own PM/CS (Project Management/Cost System).



OK-PM/CS consists of off-the-shelf computer programs customized to respond to the special requirements of large programs. The system is capable of operating on stand-alone or networked personal computers. All computer program components of OK-PM/CS are based on a commercially available relational database management system. The nucleus is a database cost program integrated with Primavera Project Planner for schedule management and our proprietary software, OK-TRACK, for contract administration. Many other specialized utility computer programs are available, if required, to further enhance the system.

The use of a relational database gives the program management team the capability to create a global information system. Data within the OK-PM/CS are stored and manipulated within a standard environment, providing an efficient solution to the problem of integrating data from different applications. Data is readily available to applications within the system as well as to outside applications. The use of a relational database within a microcomputer has the following benefits:

- The user can substitute and integrate new software products as they become available.
- The cost of implementation is low. The system has the ability to grow incrementally, as program or agency needs increase.
- The user can build on proven software and hardware.
- The need for specialized programmers and management information system (MIS) staff is minimal.

PCs provide the flexibility required to integrate a large and diverse number of users and resources of data. The configuration can also include bridges to other computers as well as gateways to remote users.

Key features of the OK-PM/CS system architecture include data gathering, system installation/expansion, system integration, external interfaces, and relationship to the owner's financial system.

**Data gathering.** At the data level, OK-PM/CS uses coding structures such as a Work Breakdown Structure (WBS) to allow precise definition of program data elements. Using common codes for data elements provides the ability to capture, link, and report data in unison. Each user provides and maintains a portion of the data but benefits from the data and information provided by others. The user can generate specialized reports by using industry-standard inexpensive report-writer programs, such as R&R Report Writer.

**System installation/expansion.** At the computer program level, OK-PM/CS uses an industry standard relational database system that allow data to be exchanged, combined, and modified by any of a multitude of products. Integration is easily accomplished through a PC's local area network

(PC-LAN). The network will also serve as the bridge to existing owner mainframe or mini-systems and a gateway to remote locations.

OK-PMICS can be installed and expanded in an incremental, cost-effective manner. Initial investments in a PC-LAN network for the basic server and software are small compared to minicomputer hardware and software investments. For small projects or programs in the initial stages of development, OK-PM/CS can be installed and operated on stand-alone PCs with little or no computer integration. These programs can be transferred easily to the LAN when the number of users expands. The programs can also be installed on preexisting PC-LANs in an organization. Workstations can be added for a small marginal cost as the project proceeds throughout the engineering and construction phases. Connections to field offices and other computer networks in the owner's organization can also be made.

**System integration.** OK-PM/CS provides integration of various component applications to achieve a unified, comprehensive reporting system. This ensures the consistency of information reported and minimizes the repetitive input of control data. Benefits of integration include:

- *Schedule-Cost Control:* Merging of CPM progress updates with cost control module information can provide up-to-date cash flow forecasts and performance monitoring reports at various levels of detail.
- *Contract Administration-Cost Control:* Current information on pending changes or potential claim items can be incorporated from the forecast costs to completion in the cost control database.
- *Estimating-Cost Control:* Detailed quantity takeoff and pricing information for project elements or specific change orders from the estimating subsystem can be summarized and transferred to the budgeting and forecast fields of the cost control database.
- *Engineering Management Cost Control:* Actual costs incurred from work packages can be gathered from the owner's financial systems or engineering management subsystems to update the cost control database.
- *Document Control-Cost and Schedule Modules:* All correspondence concerning a proposed scope change can be related to the specific CPM activities or contract pay items affected.

### 31.11. Toronto Transit's "Let's Move" Program

OKA developed its Executive Information System (EIS) for the Toronto Transit Commission's \$7 billion "Let's Move Program." The following sections highlight the key features and benefits of the EIS. Screen samples (Figures 31.11.1 through 31.11.4) are from an application

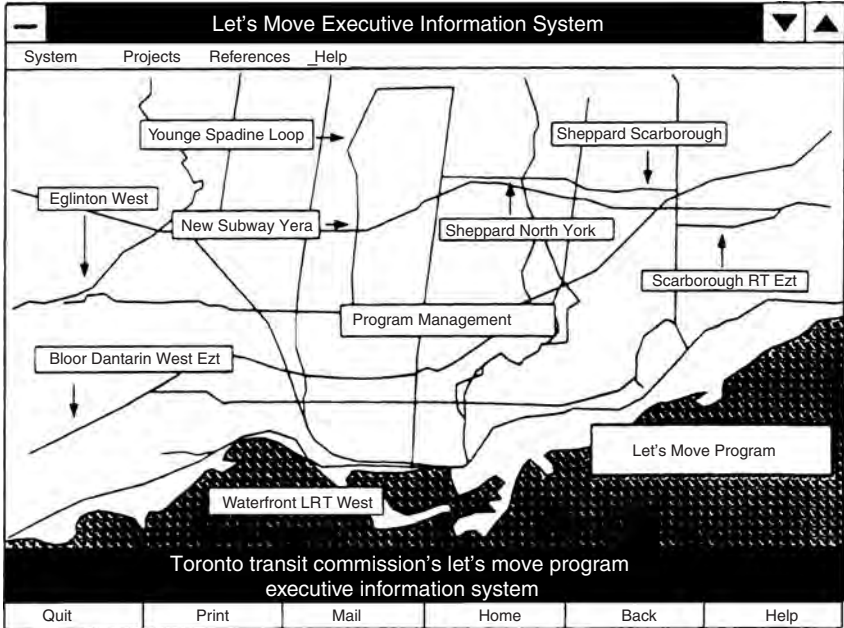

Figure 31.11.1 Opening screen.

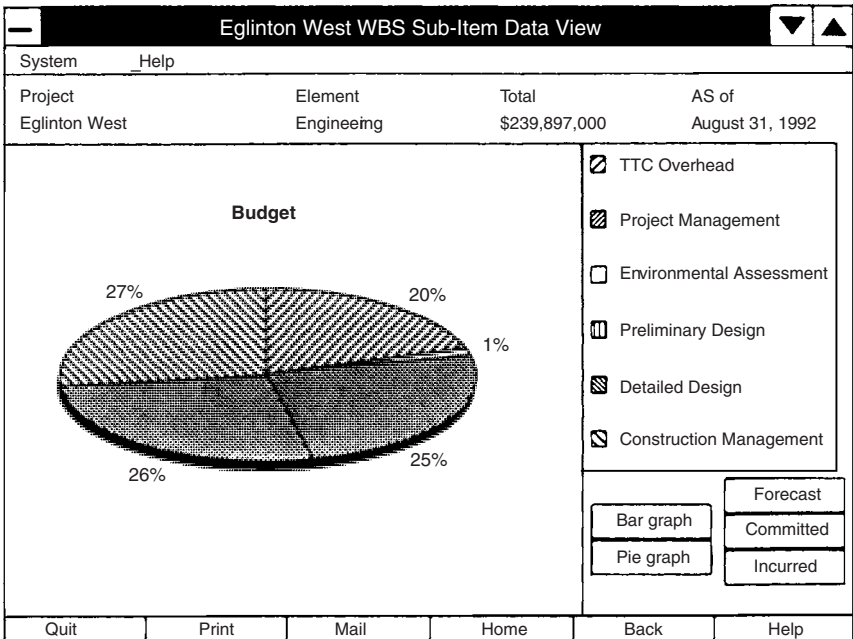

Figure 31.11.2 Cost graphic.

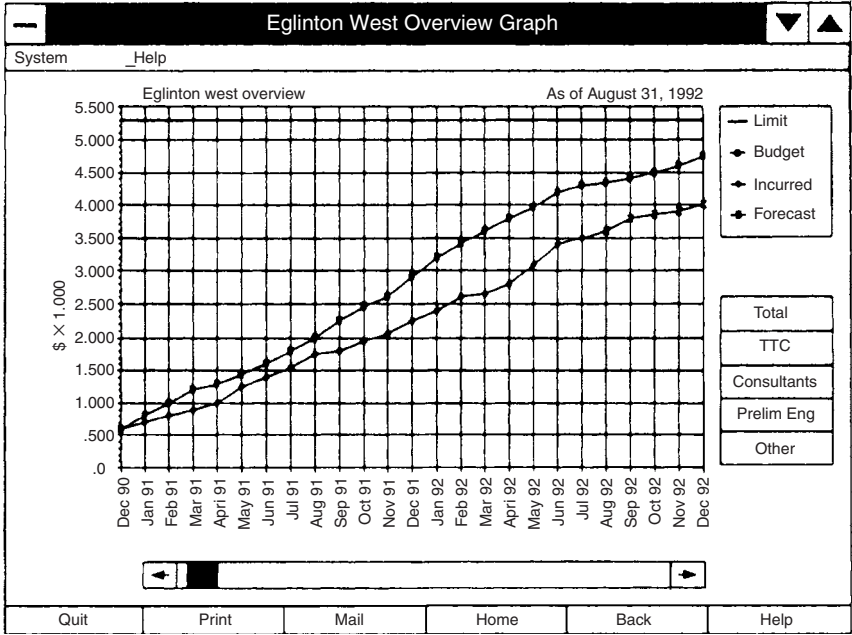

Figure 31.11.3 Time-scaled cost graphic.

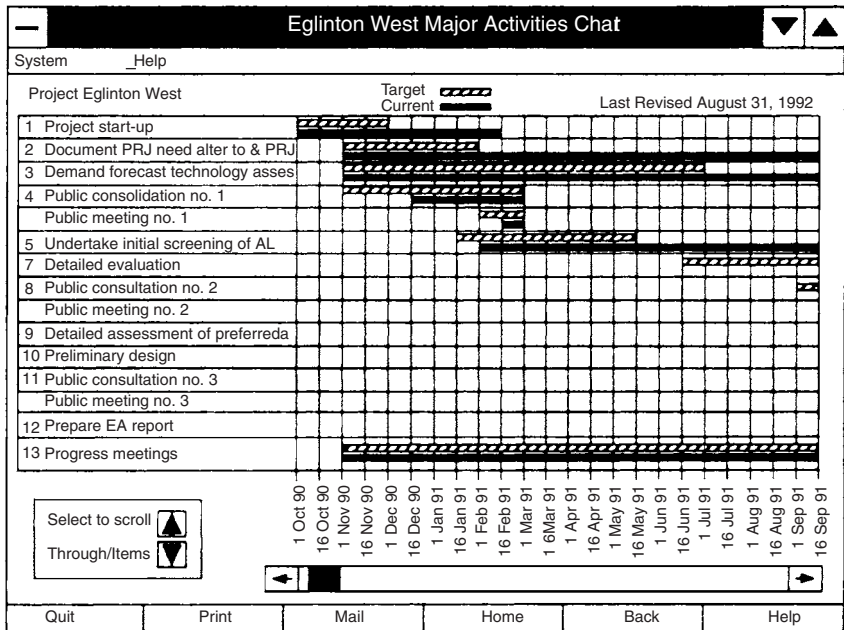

Figure 31.11.4 Time-scaled schedule graphic.

developed and installed by an O'Brien Kreitzberg project controls team.

**Ease of use.** The EIS was designed to be used directly by management without the assistance of intermediaries. The system is Microsoft Windows-based and most functions can be accessed by pressing large, easy-to-use buttons. From the opening screen shown in Figure 31.11.1, users can select one of the many projects that make up the Toronto Transit Commission's "Let's Move Program." Additional programwide screens can be accessed by selecting the "Let's Move Program" button. Common functions such as accessing help, quitting the application, going back to the previous screen, and printing are all accessed by clicking buttons that appear at the bottom of every screen.

**Graphical presentation.** EIS's extensive use of graphics to summarize and highlight information often brings out information that might remain buried in a standard report. Each screen provides the user with graphical options suitable for the data being displayed. The Cost Graphic screen shown in Figure 31.11.2 contains options to change the graph type from a pie chart to a bar chart and shows the subitems of the engineering budget as a percentage of the total. Figures 33.11.3 and 31.11.4 show time-scaled Cost and Schedule Data screens. The powerful graphics allow the manager to adjust the time scale on these screens in a matter of seconds.

### 31.12. Phoenixville-Mont Claire Bridge

The Phoenixville-Mont Claire Bridge project in Montgomery County, Pennsylvania is an example of a planned acceleration and use of CPM to complete a project ahead of schedule. The Pennsylvania Department of Transportation (PennDOT) had specified a \$30,000 per day incentive/disincentive for meeting the specified completion date of September 17, 1987. (This date included a 16-day acceleration from PennDOT's mandated completion date, agreed by the contractor as submitted with its bid.)

The project had two concurrent operations. First, to demolish an existing bridge between the two communities and rebuild it. Second, to renovate and replace the utilities under the main state highway, which ran through the communities over the bridge.

Meeting the schedule, much less beating the schedule, was deemed a challenge for both portions of the job. Improving the schedule for the highway portion was done in traditional schedulers' fashion, splitting the work so that two crews could work concurrently instead of sequentially.

Improving on the bridge was a bit more difficult. The demolition sequence, involving blasting, did not offer much room for improvement. The sequence of steel erection was mandated to run from one end of the bridge

# TRADITIONAL SEQUENCE

MANDATED CONCRETE POUR SEQUENCE

1	4	2	5	3	5	2	4	1	FORM & POUR DECK
1	2	3	4	5	REBAR				
1	2	3	4	5	SHEAR CONNECTOR				
1	2	3	4	5	OVERHANG FORMWORK				
1	2	3	4	5	STAY IN PLACE METAL FORMS				
1	2	3	4	5	R/I UTIL & DRAINAGE				
1	2	3	4	5	ERECT STRUC STEEL				

MANDATED STEEL ERECTION SEQUENCE

Figure 31.12.1 The traditional sequence.

to the other. On the other hand, once the steel was set, followed by the utilities, stay-in-place metal forms, overhang form work, shear connectors, and rebar, then concrete had to be placed in a pattern of nine, noncontiguous sections to equalize the weight on the structure. See Figure 31.12.1.

The problem was that, although the first concrete pour could be performed immediately after the completion of the rebar at the end of the bridge where the steel was started, the second pour required 100 percent of all preparatory work to be completed for the entire span of the bridge. Improvement was accomplished by precessing the work between steel erection and pouring of the deck so that the concrete could be poured as soon as the rebar was complete for each of the nine segments. Figure 31.12.2.

A graphic of this improvement won the Best Time-scaled Diagram Award at Primavera’s 1997 Annual Convention. [See Figure 31.12.3].

# MODIFIED SEQUENCE

MANDATED CONCRETE POUR SEQUENCE

1a	4a	2a	5a	3	5b	2b	4b	1b	FORM & POUR DECK
1	3	5	4	2	REBAR				
1	2	5	4	3	SHEAR CONNECTOR				
1	2	4	5	3	OVERHANG FORMWORK				
1	2	3	5	4	STAY IN PLACE METAL FORMS				
1	2	3	4	5	R/I UTIL & DRAINAGE				
1	2	3	4	5	ERECT STRUC STEEL				

MANDATED STEEL ERECTION SEQUENCE

Figure 31.12.2 The modified sequence.

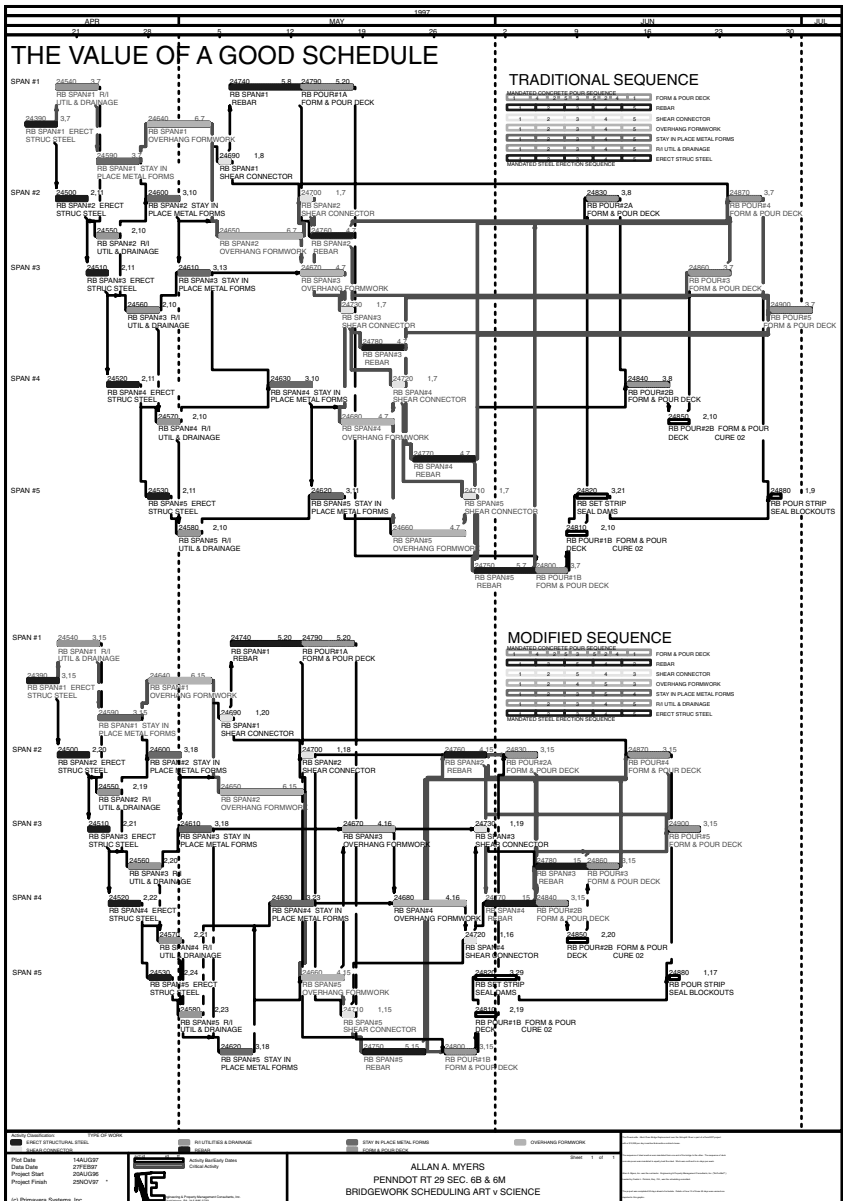

Figure 31.12.3 Impact of the modified sequence upon the traditional approach.

This example project reminds us that proper use of CPM is not just mastering a specific software package and that planning remains as much an art as it is a science.

### 31.13. Graduate Hospital Diagnostic Building

The phone call was received on Friday, December 22, 1989. “We have a contract to complete [this project] by December 31st.” After a few laughs it was determined that the contractor had now estimated a new completion target of March 1, 1990, but the owner wanted an independent confirmation of the achievability of that date.

The structure was already in place and most of the work remaining related to mechanical systems and interior finishes. And yet with 20-some subcontractors, some in revolt and walking off the project due to a claimed “lack of coordination,” this was no small scheduling task. Even the simple task of installing a door required coordination of several subcontractors – carpenter, glazer, painter, mechanical opener and electrical connections for the opener.

After three days of effort, and a new CPM network relating only to interior work of some 3503 activities and 4510 relationships, the verdict was returned – there was no chance of completion by March 1st without significant overtime, but April 9th was an achievable goal. The owner set a deadline of April 1, 1990.

Then the real work began – getting the 22 subcontractors into the same room at the same time and getting them all to agree to follow the schedule. The two keys to this step were to impress upon all the need to work as a team and a careful tailoring of reports. Only the scheduler had the full report (other than file copies for the contractor and owner) as shown for room 551 in Figure 31.13.1.

Each subcontractor was given a detail report of only their activities including the calculated free float indicating the slippage that could occur before the next subcontractor would be impacted. The schedule

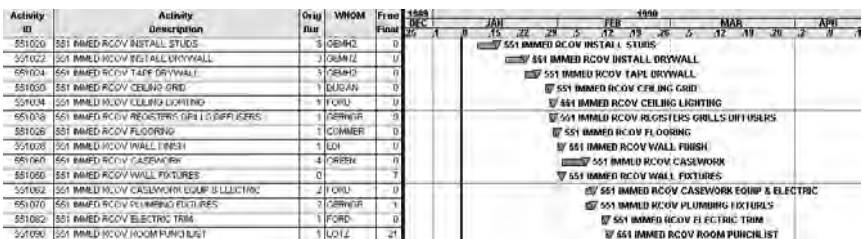

Figure 31.13.1 Sequence of work in Room 551.



included both the physical logic of studs, drywall, tape and so forth, and tracking each crew of each subcontractor through the 5 floors of the building. The goal was to have at least one day's work for each crew available at all times, so that if a crew finished work in one room early, the crew knew what room they could next move to without waiting for the next day. (See Figure 31.13.2.) Since several of the more important subcontractors would be visiting each room more than once, each knew “what goes ‘round, comes ‘round” and that the impact to another subcontractor would soon leave them with a crew requiring reassignment.

All of the subcontractors bought into the plan. Each Friday, the scheduler would walk the entire project with a clipboard, poke his nose into each room, and checkoff work performed in that room. On one occasion, the scheduler asked the prime contractor if the electrical subcontractor had experienced a problem. Amazed, the superintendent noted that the subcontractor had pulled all crews off the project for two days for some “emergency” at another job, and asked how the scheduler knew. “It’s not rocket science – he’s only done three-fifths of the work this week compared to each week the past month.” After minor adjustment of the logic, everyone was back on schedule.

The owner was given a E-size summary barchart of 58 “activities” as depicted in Figure 31.13.3 that was updated each Monday. Although minor punchlist work continued through June, the first procedure was performed in the new diagnostic building on April 9, 1990.

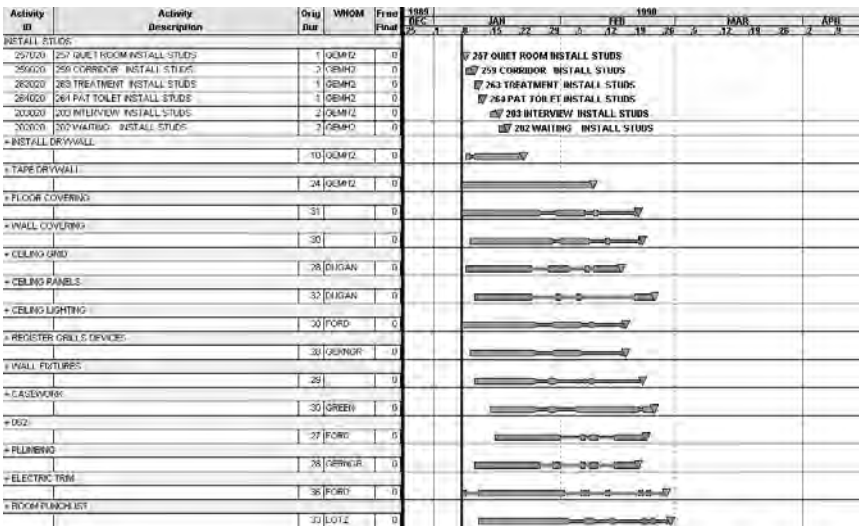

Figure 31.13.2 Summary of work on 2nd floor with partial detail shown.

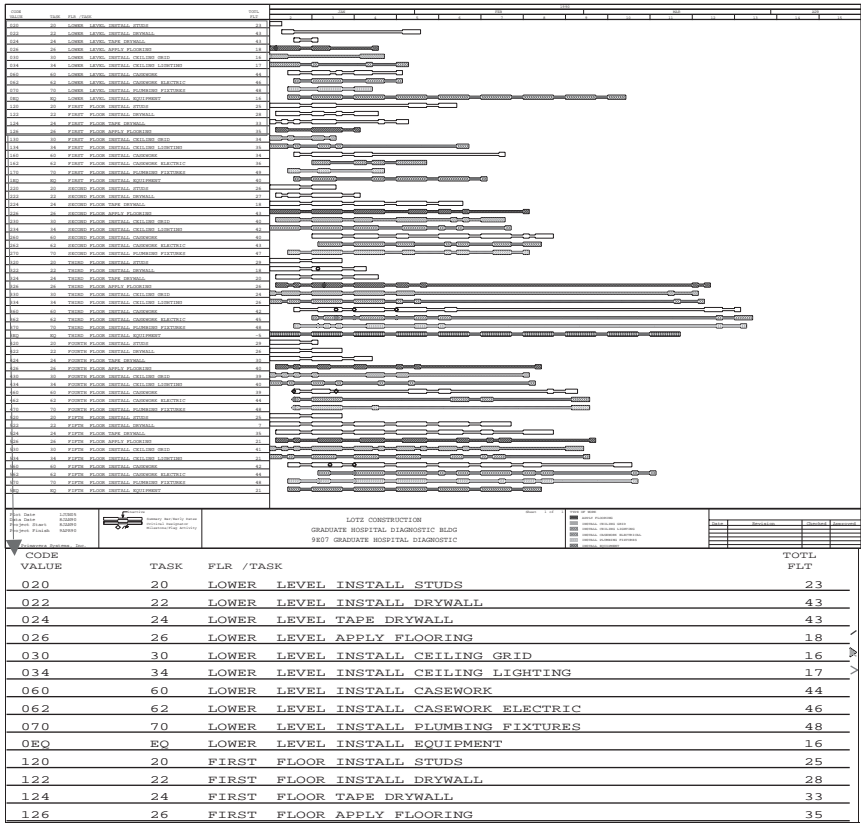

Figure 31.13.3 The network has 3503 detail activities, but the owner sees only 58 summary activities.

### 31.14. Interstate 76, 202 & 422 Interchange

American Infrastructure (“AI”) is an ENR top-400 heavy/highway and water/wastewater construction company with offices in Pennsylvania, Maryland and Virginia. Back in the 1980s, AI’s Pennsylvania arm and founding entity which continues to be known as Allan A. Myers Inc. (“AAM,”) began using CPM for large public projects being awarded, quickly determined that CPM was an investment rather than a cost and made a corporate decision to require a CPM on all major projects (and eventually on all of its work down to subdivision development.)

To prepare the CPM schedules for its works, AAM hired several consultants providing a majority of work to one, but maintaining a working relationship with backups. AAM also hired its prime consultant to provide classes in CPM and P3 software, eventually working out a deal with Drexel University to provide college credits for such instruction.

Very quickly, AAM began to handle the updates for its projects, utilizing the consultant only for the initial setup and presentation of the schedule to the owner and its engineer at pre-construction meetings.

As part of AI's standard hiring practice, new engineers move through a training program in several departments including estimating and projects. As part of one six month module of the program, new engineers were assigned to work on CPM schedules and updates in collaboration with the consultant. In addition, AAM requested the consultant to design a master project resource roll-up scheduling system that anticipated the functionality of P3e/c (and AAM later became one of the first companies to migrate from P3 to P3e/c.) Implementation of the system required matching P3 with the relational database capability of Microsoft Access but was standardized to be maintained entirely by the existing employees and new engineers going through the training program.

The decision to move from outside consultant to an in-house scheduling team was made and AAM chose to attack the problem not by starting small but on a "give it all you have" basis. The project, eventually growing to four separate phases of a Pennsylvania Department of Transportation project totaling more than \$200 million between 2001 through 2003, was the reconstruction of Routes 76, 202 and 422 located in suburban Philadelphia. The project also faced several major scheduling constraints including the relocation of an Amtrak bridge over the Schuylkill Expressway (I76) and the maintenance of traffic in one of the most heavily congested areas in the Philadelphia region. The newly formed scheduling team was given the challenge and began the preparation of the detail CPM required for this endeavor.

Each Friday, the consultant was asked to come in and look over the work prepared during the past week. Constructive criticism was accepted and ideas exchanged on how to proceed. And then, after several weeks the CPM was done, presented to and accepted by PennDOT and the AAM scheduling team was off and running. The project encountered challenges including persistent problems with sinkholes, but with the partnership of the owner, engineer, AAM and its subcontractors eventually went on to complete the project successfully and profitably and to win several awards, including a Pennsylvania Governor's Award of Excellence.

And the scheduling team continued to plan and schedule other highway work as it was awarded. Over the next couple of years, the consultant would be called in to review major changes to the 76/202/422 project, other highway projects as they were won by AAM and for other questions (including over the conversion to P3e/c) while the consultant continued to assist project managers on water and wastewater facilities.

Finally, the AAM scheduling team felt comfortable with going beyond highway work and took over the more complex scheduling effort for

these more complex projects. The consultant continues to provide training (through Drexel) every few years as another AI “class” takes the scheduling module but otherwise no longer constitutes an expense. And American Infrastructure continues to grow and move up the ranks of the ENR 400.

### 31.15. CPM Preparation Time

Experience in time versus size of networks cannot be considered a definitive guide to how long it might take to prepare a network. Nor does quantity ensure quality. However, the following case histories are useful as a reference:

#### Case A: NASA missile launch site utility system

*Cost:* \$20 million

*Construction time:* 6 months

*Client:* Contractor (pre-bid) who was concerned about the short construction period and the high liquidated damages (\$5,000 per day)

*Planning approach:* Executive (contractors, estimator, project engineer, and CPM consultant)

*Results:* A network of 900 arrows. The preparation for the computation phase took about 70 hours of team time. However, this particular network was deliberately condensed in portions so that workforce studies could be applied. In perhaps 80 hours, a 1600-activity network could have been developed.

#### Case B: construction of a new hospital and demolition of the old hospital

*Cost:* \$15 million

*Construction time:* 24 months

*Client:* General contractor who wanted a good construction schedule to ensure on-time completion.

*Planning approach:* Executive (contractors, superintendent, project engineer, and CPM consultant)

*Results:* About 104 team hours were used in preparing a 1200-arrow network.

#### Case C: high-rise apartment (40 stories)

*Cost:* \$30 million

*Construction time:* 14 months

*Client:* Owner-builder

*Planning approach:* Executive (owner's assistant, superintendent, and CPM consultant)

*Results:* 1500-arrow diagram was completed in 5 weeks. The diagram for the 40 similar floors was based on a detailed study of a typical floor. This typical floor had 150 activities and connections. Multiplied by 40 floors, this could easily have been converted into a 6000-arrow network.

#### **Case D: high school**

*Cost:* \$15 million

*Construction time:* 16 months

*Client:* School board

*Planning approach:* Executive (CPM consultant worked directly with the major contractors' superintendents to prepare networks)

*Results:* The 1200-arrow diagram was prepared in 4 weeks.

#### **Case E: oil refinery turnaround**

*Cost:* \$2 million

*Downtime:* 7 weeks

*Client:* Refinery

*Planning approach:* Conference (group of about 10 people when discussing boiler overhaul; the group was reduced to 6 when discussing more routine overhaul work)

*Results:* The 1200-arrow diagram took about 3 team-weeks to prepare. The careful planning resulted in less equipment downtime.

#### **Case F: unique process facility**

*Cost:* \$2 Billion plus

*Owner:* Department of Energy

*Contractor:* Design-Construct-Operate

*Results:* Project is approaching the end of design. A state-of-the art Primavera based schedule including all planning, engineering, architectural, governmental, and construction activities is at 22,000 activities. Activities presently assigned to construction on a summary basis are 4000 activities. As between 25 and 45 contracts will bid on this program, the anticipated number of activities added to this network will approach 30,000 activities.

Even though P3e/c can handle this scope, at some point after the bidding, it will be appropriate to record, and split off the preceding historical block of about 15,000 activities, and establish a new, principally construction and startup window.

**Case G: Port Authority of NY and NJ**

The Port Authority has encouraged the use of network based schedules since the 1960s. (See underground JFK fuel system and also JFK redevelopment earlier in this chapter.) In 2004, it was announced that the Port Authority of NY and NJ won the Primavera Excellence Award (2003) for its implementation of Primavera's P3 System to support the Port's 5-year \$9 Billion Capital Program. Pradip M Mehta, Project Controls Manager for the PA Engineering Department headed by Frank Lombardi (who had been part of the JFK Redevelopment Project Management System), lead the implementation of the new Primavera based management system for the Engineering Department. Two recent projects completed by the PA after the 9/11 cleanup: opening the PATH Station at the WTC Site, and the JFK Air Train connecting to JFK Airport.

**Case H: Maricopa County Prison Project**

*Cost:* \$500 million

*Owner:* Maricopa County, AZ

*Program Manager:* Hunt-Jacobs JV

Using Primavera and demanding rigid adherence to the scheduling specifications developed with ENPROMAC provided Maricopa County the tools needed to design, contract for, and build over 500 million dollars in their Jail Expansion Program. The specifications required a detailed, cost-loaded CPM within 30 days of notice to proceed. The schedule was the tool used for both the pay application process, schedule progressing process and delay claims analysis.

The result of adherence to the specification was virtually no "end of project" delay claims. Contractors were able to obtain schedule extensions when they were due. The owner wrote change orders, including schedule extensions, at a minimum of once a month. The county was able to accurately forecast the overall program schedule and program cost and completed the Jail Expansion Program on time and under budget.

Key elements to schedule success and claims avoidance were: Contractors following the delay notice provisions, the owner requiring recovery and mitigation plans, and the project teams quantifying and analyzing potential delays at the time of their occurrence. By early identification of potential delays, the team was able to mitigate delay and make decisions based upon the current schedule.

By both the owner and the contractors adhering to the contract schedule specifications, although the County attorneys were looking for claims, there were very few to be had on this Jail Expansion Program.

### 31.16. Summary

The size of a useful network is almost unlimited. Network analysis is usually a must in projects valued over \$5 million, but it can also be used in less expensive projects. CPM often exposes undefined planning factors. The trend is to apply CPM after the award of contract, but this is not a hard and fast rule. Network analysis done prior to award of contract can provide better construction schedule requirements, and CPM can also be applied profitably after construction work has started.

Phase 1 of the network preparation is collecting information and the concurrent preparation of a rough diagram. The information collection can be made by any of four approaches: conference, executive, consultant, or staff planning. The second phase of the network preparation is the rearrangement and redrawing of the rough version into a smooth form.

In any approach, it is vital that the plan reflect the real plans of the contractor. Subcontractors perform many critical work functions. Their information must also be incorporated in the network.

It is difficult to set definite time requirements for the preparation of a network. Familiar projects can be diagrammed more quickly than unfamiliar ones and noncomplex projects more quickly than complex ones.

CPM seems to require more time than traditional planning but only because, with CPM techniques, planning is done in more depth.

*This page intentionally left blank*



## Additional Exercises for Students of Project Controls

### 32.1. Sample Problems

**1** Draft the following network in ADM format:

1. B & C follow A
2. D & E follow C
3. F follows B & D
4. G follows E & F

**2** Draft the following network in ADM format:

1. B & C follow A
2. D follows B
3. E & F follow C
4. G follows D & E & F

**3** Draft the following network in ADM format:

1. B & C follow A
2. D & E follow B
3. E follows C
4. F follows D & E

**4** Draft the following network in ADM format:

1. M & R follow T
2. N & B & F follow R
3. A follows N
4. E follows B
5. F precedes G
6. C follows A & M & E
7. D follows A & G
8. E precedes L

**516 The Practice of CPM Scheduling**

- 9. H & J follow C & D
- 10. K follows H & J & L

**5 Solve by the Matrix Method**

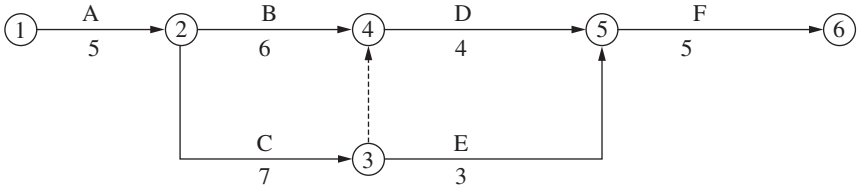

<i>i/j</i>	1	2	3	4	5	6	TE <sub>i</sub>	max(TE <sub>i</sub> + D <sub>ij</sub> )	<i>i-j</i>	dur	ES	EF	LS	LF	TF
1	—														
2	—	—													
3	—	—	—												
4	—	—	—	—											
5	—	—	—	—	—										
6	—	—	—	—	—	—									
TL <sub>j</sub>															
min(TL <sub>j</sub> - D <sub>ij</sub> )											TE <sub>i</sub>				TL <sub>j</sub>

**6 Solve by the Intuitive Method**

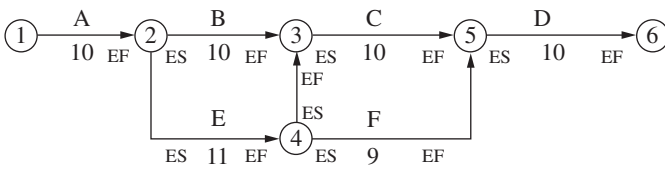

**7 Solve by the Computer Simulated Method**

act	<i>i</i>	<i>j</i>	dur	ES	EF	LS	LF	TF
A	1	2	5					
B	2	3	6					
C	2	4	5					
D	3	5	4					
E	4	5	3					
F	5	6	5					

## 32.2. Navigating the Enclosed CD-ROM

Enclosed at the back of this text, you will find a CD-ROM disk which has been specially prepared by Primavera Software Systems at the request of the authors. This CD includes demonstration versions of three software products, files for the John Doe project example used throughout the text, a PDF file of the various screen shot figures from this text in full color, a PDF file of the source code for expanded P3 diagnostics discussed in Chapter 25, and the two sample CPM specifications discussed in Chapter 33. The three software products are:

- the classic P3 Primavera Project Planner,
- the latest flagship for small contractors, Primavera Construction and
- MCA Monte Carlo Analyzer—the just-being-released small version of Pertmaster risk software designed for use with P3e/c and Primavera Construction.

The three programs are for demonstration purposes only and each has some limits. The P3 software is limited to 60 activities. Thus, if you desire to read the John Doe project files, you will be limited to the JDOE file which has been reduced to only 49 activities (leaving room for the student to add activities while learning the software.) Should you desire to review the full 181 activities of the DP00 As-Plan file, or DPAB As-Built file, both (along with the JDOE file) in “mock-ADM” format, you will need to use a fully licensed copy of P3 or SureTrak, or you will need to load and use the Primavera Construction software on the CD. You may practice with the P3 demonstration software as long as you desire, and even use it for very small projects, up to a practical limit of \$500,000.

The Primavera Construction software is the same that can be purchased from Primavera and can handle up to 750 activities. Once you are comfortable using the classic P3 demonstration software, you should consider moving up to this product. You can use this to run real projects of significant size; the authors suggest a practical project limit of \$7 million due to the 750 activity limit. However, this demonstration software will only work for 90 days. At that time you will have to decide if you wish to purchase the software. Details on purchase of a license to convert the 90-day demo to the full product are supplied on the CD.

The MCA or Monte Carlo Analyzer by Pertmaster demonstration software is meant as a learning tool rather than for practical use, and is limited to approximately 25 activities. It is not limited by time. The MCA software is specifically designed to work with Primavera Construction

and may be used to further explore the concepts of risk discussed in Chapter 38.

To load onto your computer any one of the three software products, insert the CD to your computer, Browse or Explore to your choice of P3, Primavera Construction or MCA and click the icon for setup.exe. This will lead you through copying the appropriate program to your computer. (Figure 32.2.1.)

To view the John Doe project files, after loading the software, use the P3 Tools Restore command to explode the condensed file to their 23 component files for each project, as shown in Figure 32.2.2. Remember, you can open only the JDOE file with the demonstration copy of P3. Once the condensed John Doe files have been exploded, they can be imported to the Primavera Construction software.

The four John Doe project files are:

- JDOE – 49 activity subset of the project, in “mock-ADM” for teaching purposes
- DP00 – 181 activity network, in “mock-ADM,” mimicking the CPM as created in chapter 18
- DPAB – 181 activity network, in “mock-ADM,” showing progress to project completion
- DOE0 – 155 activity network, in true PDM format, to illustrate the conversion of ADM to PDM and subsequent reduction in activities as “dummy activities” used as logic restraints are removed.

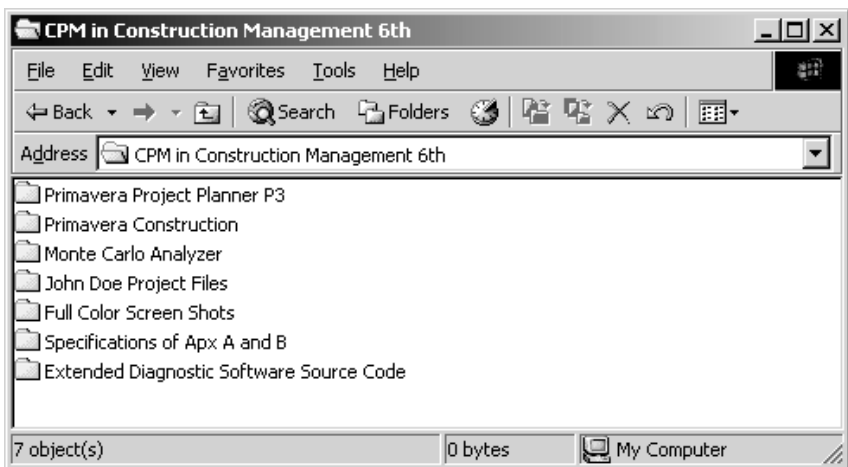
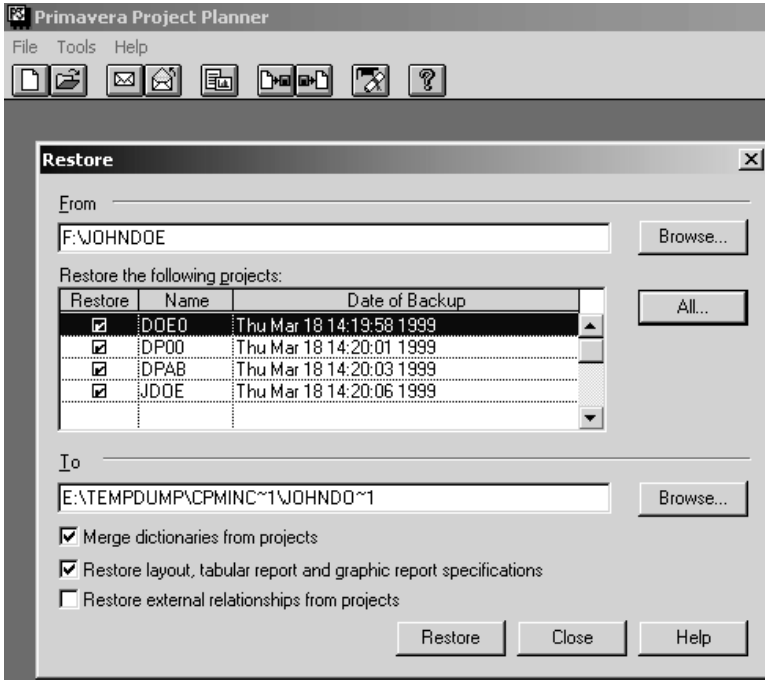

Figure 32.2.1 Browsing the CD.



**Figure 32.2.2** Restoring the John Doe project files from the CD.

A common complaint of the previous edition was that computer screen shots that are reduced to fit the printed page are difficult to read and that the loss of color to the black, white and grey of the printed page further reduced the usefulness of such figures. Therefore, all figures involving computer screen shots have been saved to a file, Edition6Figures.pdf and saved to the CD. To view, Browse to “Full Color Screen Shots” and click the PDF.

Finally, to save readers the trouble of rekeying material meant to be copied, three additional files are stored as PDF files. These include the sample specifications of Appendix A and Appendix B, and the extended diagnostic software source code.

32.3. Answers to Sample Problems

1 Draft the following network in ADM format:

1. B & C follow A
2. D & E follow C
3. F follows B & D
4. G follows E & F

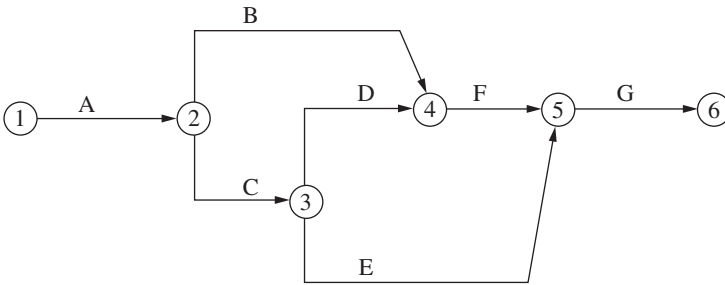

- A is 1-2
- B is 2-4
- C is 2-3
- D is 3-4
- E is 3-5
- F is 4-5
- G is 5-6

2 Draft the following network in ADM format:

1. B & C follow A
2. D follows B
3. E & F follow C
4. G follows D & E & F

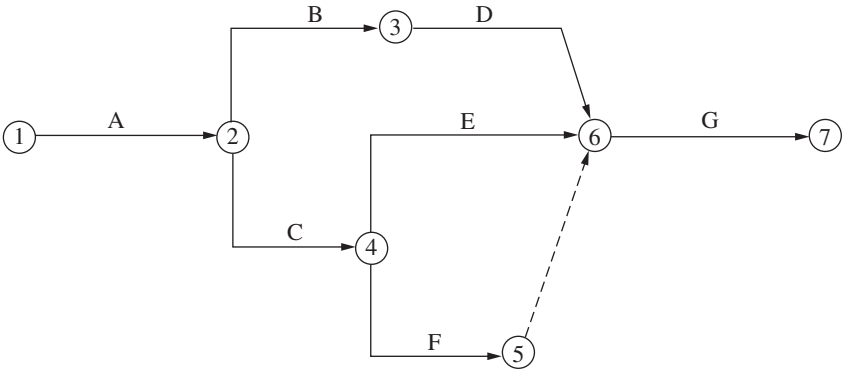

3 Draft the following network in ADM format:

1. B & C follow A
2. D & E follow B
3. E follows C
4. F follows D & E

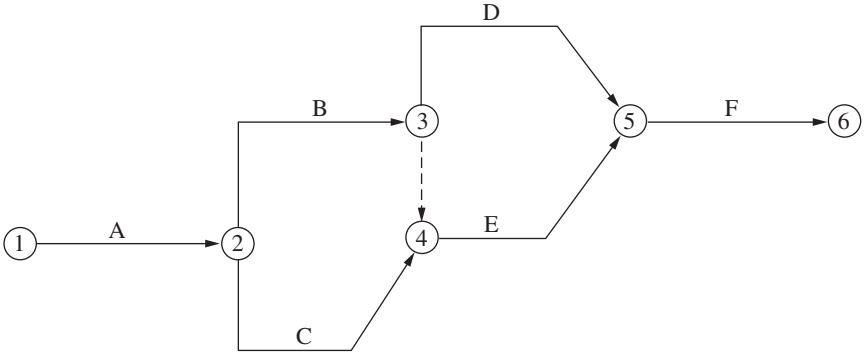

4 Draft the following network in ADM format:

1. M & R follow T
2. N & B & F follow R
3. A follows N
4. E follows B
5. F precedes G
6. C follows A & M & E
7. D follows A & G
8. E precedes L
9. H & J follow C & D
10. K follows H & J & L

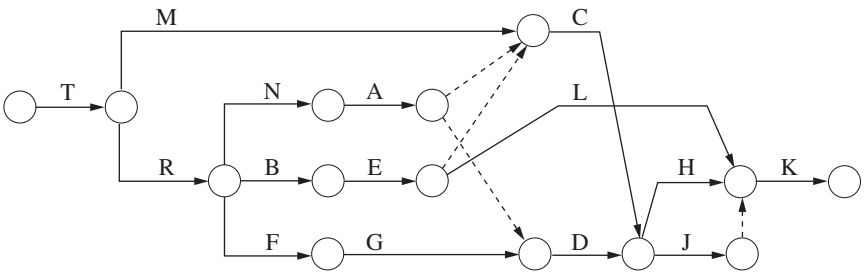

5 Solve by the Matrix Method

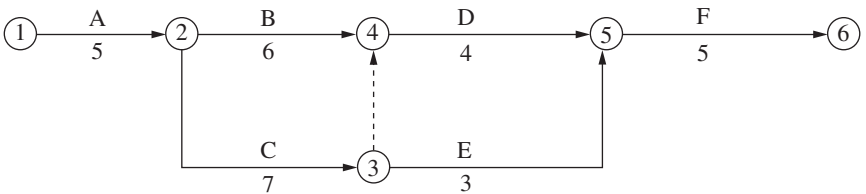

522 The Practice of CPM Scheduling

$i/j$	1	2	3	4	5	6	$TE_i$	$\max(TE_i + D_{ij})$	$i-j$	dur	ES	EF	LS	LF	TF
1	—	5					0	defined as 0	1-2	5	0	5	0	5	0
2	—	—	7	6			5	$0 + 5$	2-4	6	5	11	6	12	1
3	—	—	—	0	3		12	$5 + 7$	2-3	7	5	12	5	12	0
4	—	—	—	—	4		12	$5 + 6$ or $12 + 0$	3-4	0	12	12	12	12	0
5	—	—	—	—	—	5	16	$12 + 3$ or $12 + 4$	3-5	3	12	15	15	16	1
6	—	—	—	—	—	—	21	$16 + 5$	4-5	4	12	16	12	16	0
$TL_j$	0	5	12	12	16	21			5-6	5	16	21	16	21	0
$\min(TL_j - D_{ij})$		5-5	12-6 or 12-7	16-3 or 12-0	16-4	21-5	Defined as $TE_i$				$TE_i$	$ES + \text{dur}$	$LF - \text{dur}$	$TL_j$	$LF - EF$ or $LS - ES$

6 Solve by the Intuitive Method

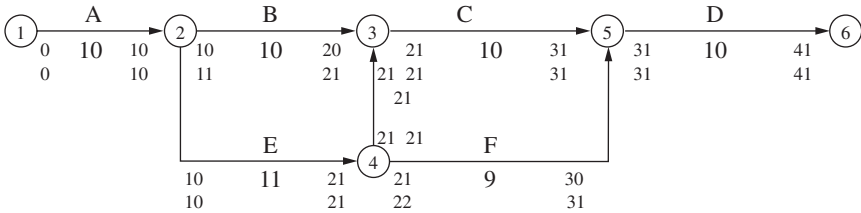

7 Solve by the Computer Simulated Method

act	$i$	$j$	dur	ES	EF	LS	LF	TF
A	1	2	5	0	5	0	5	0
B	2	3	6	5	11	5	11	0
C	2	4	5	5	10	7	12	2
D	3	5	4	11	15	11	15	0
E	4	5	3	10	13	12	15	2
F	5	6	5	15	20	15	20	0



---

Part

# 6

## Advanced Topics

*This page intentionally left blank*

---

Chapter  
**33**

## Specifying CPM

Specification of a process such as CPM is usually the owner's responsibility, usually delegated to either the design professional or the construction manager. If CPM is not a contract requirement, but a contractor elects to use it, selection/specification of the CPM approach is the contractor's option. Many contractors have selected the option of having CPM consulting assistance. In that event, they need a means to describe the scope of the services required (*ie* a specification.)

The specifying of the ADM process produced predictable results. Today, the response is, "we are using Primavera and WYSIWYG applies" (*ie* What You See Is What You Get.) This chapter explores optimum ways to specify the PDM scheduling process. More importantly, it explains why specific language should be used since it is paramount that the engineer should understand the specification and not merely enforce terms copied from a guideline specification.

### **33.1. Attorney's Viewpoint to Writing a CPM Specification**

From an owner's viewpoint, two objectives should be accomplished in a specification requiring a submission. The first is that the submission assists the contractor to accomplish the end product desired by the owner. The second, as important, is that the submission be made in a format which may be readily reviewed by the owner.

The traditional ADM system accomplished both objectives. It forced the contractor to logically address the planning needs of a project and thus to schedule the work in a fashion most likely to achieve completion on time. The simplicity of the system made the job of the reviewer easy. Logic was easily followed in pure logic drawings, in barcharts, in logic notated

barcharts and in time scaled logic diagrams. Logic was also easily followed in tabular printouts as the logic is encoded in I-J activity notation.

However, the PDM system has the advantage that, if used properly, relationships difficult to depict in ADM, and difficult to update during the course of the project, may be better depicted using the powerful non-traditional lead/lag relationships available. The PDM system may assist the contractor to make a model closer to reality than may be made with ADM. And this means that, used properly, the schedule calculated is even more likely to assist the contractor to achieve timely completion.

The downsides are that the additional power can be misused by the contractor to avoid the need to logically address the planning needs of a project. The contractor may choose to merely guess when various activities should be performed, line such up in a barchart format and link such together with any type of logic restraint relationships that holds the barchart together for the initial submission printout.

And the initial submission looks like a million dollars. In multicolor graphic format or tabular format it is definitely the output of a sophisticated computer program – and must be correct. But the reviewer must beware because the schedule submittal may be a charade. Logic relationships are often not shown. If logic connectors are shown, they do not readily indicate the type of relationship or existence of lags, and are often placed so closely together as to make visual review impossible. Additional powerful features in both ADM and PDM systems, such as the ability to assign artificial constraints to an activity without clear notation on the output, further reduces the need of the contractor to sit down and clearly think through the logic of the project.

Therefore, the job of the specifier is to permit the contractor to utilize the more powerful features of PDM and modern software programs to better model the real world, but at the same time continue to force the contractor to perform the basic planning required for the preparation of a CPM using the older ADM system.

### **33.2. Pure Logic Drawing**

The first step in preparation of such a specification is to require the pure logic diagram which is the hallmark of proper planning, and which has been discussed throughout this text. While it is desired that the pure logic drawing be prepared prior to entry into the computer, such may be difficult to enforce. A requirement that the pure logic diagram be hand drawn is an easy fix, but it is the function and not the form that counts. Logic relationship lines should be clearly and easily followed, possibly of a minimum length and separation from other lines, and notated if other than the traditional Finish-to-Start with no lag. A further suggestion is to require

notation if the purpose of the logic relationship is to allocate resources (“crew logic”) as opposed to a physical requirement. (see Figure 22.6.2)

The size of the diagram should be chosen to allow for easy review by the owner or its engineer. Since it is desired that this drawing be prepared as a planning tool, calculated schedule information (e.g. early and late dates) should not appear thereon. For such information, this drawing may be augmented by a separate barchart or time scaled logic diagram.

To permit proper use but minimize abuse of the powerful features of PDM, non-traditional relationships should be required to be highlighted and the need therefore, on an individual basis, explained in an attached narrative. Hand drawn (or similar) fragnets expressing the detail summarized by the non-traditional relationships should be required as part of these narratives. Similarly, artificial constraints should be explained on an individual basis. If multiple calendars are used, they should be clearly marked and a copy of the features of each calendar attached along with an explanation of its features and need therefore. Many specifications require a copy of the calendar – page upon page – when what is really desired is a tabulation of the basis (such as M-Tu-W-Th-F) and exceptions (holidays and other non-work days, and special weekends on which work is to be performed.) The algorithm of the software chosen by the contractor should be explained. This requirement may be skipped if the owner specifies the software to be used, but where options within the software exist (such as continuous or interruptible activities,) the options taken should be noted and explained.

In summary, if the CPM is to be a tool which is to assist the entire project team run the project in the most expeditious fashion, limits on the contractor’s use of the most modern technology should not be mandated. However, the rigors required by the old ADM system should not be relaxed and each extension from that system should be explained.

### 33.3. Content of the Logic Network

So much for the technical issues of the CPM submittal. The content of the CPM submittal must also be considered. It has already been noted as useful and is here again suggested that each activity be keyed to at least one contract drawing or specification number that best illustrates the scope of the activity. If the engineer or owner desires to be able to summarize the status of work by location or function, it is important to specify such a code be assigned to each activity—but at the same time remembering that such coding requirements be subordinate to the axiom that each activity be a “set of instructions . . . to one responsible foreman . . .” Thus if a wall that would be poured monolithically runs between two area codes, it should still be reported as one activity—the

accuracy of the coding structure and not the activity content must be degraded as necessary.

A good specification should also require that all assumptions relating to durations of activities and between activities be recorded. This may require duplicate recording of resources – once at the nominal tolerance for supporting the duration and once at the close tolerance for cost engineering and estimating purposes. (And a third record at an exact tolerance if the system is to be used for accounting purposes.) Recording the assumptions behind lags is difficult in most commercial software systems as code, note and log fields are by activity and not by restraint. However, a specification can and should require a separate listing, perhaps as an Excel spreadsheet file, providing this information.

Equally important is what the specification should not include. The CPM specification is a requirement for a shop drawing. It does not, and is not meant to specify how the contractor is to perform its scope of work or even how to schedule its work. The Spearin doctrine (*United States v. Spearin* (1918), 248 US 132, 63 L Ed 166, 39 S Ct 59) provides that if an owner tells a contractor how to perform its scope of work, and the contractor carefully follows those instructions, that the owner will be responsible for any failures without regard to any other language in the contract that says otherwise. Thus, if a contractor was by contract to guarantee that a basement wall be watertight, and then by that same contract erect the wall, apply waterproofing and carefully backfill the wall all in accordance with detailed instructions by the specification, stringently enforced by an inspector, the owner will have no recourse under the guarantee if the wall should leak (*MacKnight Flintic Stone Company v. Mayor, Alderman and Commonalty of the City of New York* (1899), 160 N.Y. 73, 54 N.E. 661.) The engineer must be similarly careful with coordinating the CPM specification with what is desired of the contractor.

For example, some specifications in current use require that the contractor's CPM show that the contractor intends to complete the project exactly upon and not earlier than the stipulated project completion date. This is very much akin to a specification requiring epoxy coated rebar, but also requiring the contractor to submit shop drawings showing stainless steel will be used. The specification does not require the contractor to actually remain on the site after all work is complete, and it is doubtful that any judge or factfinder would believe that the owner understood this to be the contract's or contractor's intent. As noted in Chapter 22, adherence to such a specification may greatly increase the probability that the project will be late as the foremen, subcontractors, vendors and inspectors all work towards published schedule dates that are later than the prudent contractor would plan and each uses some of the contingency reserved for extraordinary events. When these events occur late in the project, it is too late to recover.

Another example where a CPM submittal may be misused is where an engineer prohibits the contractor from starting work on an activity prior to its published early start date per the CPM. The mathematics of CPM actually indicate that the activity merely has a probability (usually less than 50%) of starting on or before the date printed as the early start and not that the contractor should not attempt to beat this date. Other than the normal requirements of notice to the engineer (so that necessary inspection staff can be allocated,) the contractor should be permitted to work wherever he pleases. The engineer should, however, document and place the contractor on notice if resources are being diverted away from critical path work to work off of the critical path.

### 33.4. Updates and Revisions

Many specifications get confused when discussing updates and revisions. Instead of discussing the technical and content aspects of the CPM Update or CPM Revision submittal, the specification attempts to duplicate or override the contract provisions dealing with payment and claims. In many cases the result is a hodge-podge of partially concurring and partially conflicting instructions on these two important areas of the contract.

If progress payments require the submittal of a CPM update, as well as several other submittals of documentation, such fact belongs in the Progress Payment section of the contract documents. The format and content of the CPM update submittal are the only subjects that should be discussed in the specification section for the CPM. Similarly, if the process by which a contractor should submit a claim requires a CPM analysis, as well as several other submittals of documentation, such fact belongs in the Disputes section of the contract documents with the specification on CPM merely noting the required format and content of such analysis.

However, a word of warning is called for here. Should a contract clause state that resolution of a contractor's claim will be based upon the reading of "the entrails of a goat" or other obtuse "analysis" favoring the owner, a court may honor such clause, or it may choose to ignore the clause or it may choose to punish the party promoting the clause.

The specification should require that updates and revisions be kept separate. The inclusion of Claims Digger in the latest Primavera software, or similar software, makes for easy enforcement of such a restriction. Updates should only include information on progress during the past reporting period and the specification should require special notation where work completed several reporting periods ago is suddenly discovered and is being reported with this update. Where the contractor is required to or desires to submit a revision, such should be for the same DataDate as the last update, and a new update should first be performed *before* the revision if necessary.

A revision should be required if the contractor chooses to perform the scope of the project to a significantly different “plan of execution” than originally envisioned. However, the mere fact that the contractor is performing work out-of-sequence is not, of itself, indicative of a decision to alter the “plan of execution.” In many, if not most such cases, the contractor may claim the alternate plan was forced upon it due to events outside of its control, including those claimed caused by the engineer or owner. Thus, as part of the narrative to a revision, it is important to require the contractor to elucidate the reasons for such a change to its “plan of execution.” Neither the engineer nor owner has to agree with the given reason, but it is important to get such stated at the time of the event.

It is not too much to demand, as part of the CPM specification, that if the lead project manager or superintendent is replaced for any reason, the replacement be required to certify in writing completion of a full review and revision as deemed desired of the remainder of the As-Planned logic network and schedule (or most recent revision thereof) of a minimum of eight, sixteen or even twenty-four contact hours depending upon the size and complexity of the project. There may be other major events within the responsibility of the contractor that similarly call for a revision. However, in all likelihood, the submission of a revision will be concurrent with claims by the contractor to a change order.

A revision should be required if the contractor claims that a change in condition or change order will significantly impact its “plan of execution.” If responsibility for the change is arguably that of the owner, the change order section of the contract documents should require the proposed revision be submitted with the change order request for payment. The cost of preparing the revision is part of the cost of the change order and should be chargeable as such. (Clauses stating otherwise may be deemed inequitable and subject to being deemed unenforceable by a court.)

The preparation of a full revision will also assist the contractor to determine the incidental and consequential impact of a change order upon all of its subcontractors, and allow for a complete price tag to be assigned the change. While the owner may not wish to remind the contractor to add yet more costs to the change order, this process is more likely to lead to complete closure of the issue. Obviously, if there are multiple proposed change orders for the same time period pending, this process may be compromised and call for yet more professionalism by the Engineer.

### **33.5. Standard References**

The easiest way to specify the use of CPM would be to invoke a standard reference, such as one authored by the American National Standards Institute (ANSI). However, ANSI has not issued a CPM standard as of the



date of this publication. Over a period of many years, two ANSI sub committees addressed the question of a CPM standard and some draft material was released. The British counterpart of ANSI has published a standard on networks. The usefulness of this published material is limited as a reference for a specification because it is so even handed that all options are left open.

One book traditionally used to describe or specify CPM used by general contractors was published by the Associated General Contractors of America (AGC) as *CPM in Construction: A Manual for General Contractors*. This book, first published in 1965, was written by Glenn L. White. It provides a clear description of CPM theory and technique but stops short of describing methods and philosophies of application of the technique. However, the advent of PDM and the specifying of CPM by owners desiring an owner oriented, rather than AGC oriented viewpoint, has led to the supplanting of the book by newer specifications tailored to the needs of such owners.

A standard which has evolved over the past 40 years is the U.S. Army Corps of Engineers reference regulation ER-1-1-11, "Network Analysis System," which was used into the late 1990s as the Corps reference standard when it specified the use of network scheduling. ER-1-1-11 describes network theory and technique; it leaves the method of application to the particular project specification.

Another standard which has evolved over the years is the Network Analysis Schedules (NAS) section of the General Conditions prepared by the U.S. Navy Naval Facilities Command (NAVFAC.) The first joint effort of the authors of this text was in the total rewrite of this specification in 1987. Harkening back to an era where sole source specifications were discouraged, a good portion of the specification was devoted to having the contractor submit its files in a format readable by Primavera without requiring the contractor to use that one vendor. (Figures 33.5.1 and 2)

2.1.4 Software: It is intended that the information submitted in computer readable form may, but need not, be used by the Government to verify Contractor submissions. The Government intends, but is not committed, to use PRIMAVERA PROJECT MANAGEMENT AND CONTROL software to implement this review, if performed, and said software may be used to prepare all reports (hard copy and computer readable.) However, other software systems may also have this capability, and if desired, Contractor may use other software packages, or perform the mathematical analysis required by hand calculation, provided that the submissions are made in the format required by this specification.

**Figure 33.5.1** Excerpt from 1987 specification.

```

FILENAME: PROJ02
ALL RECORDS or LINES
COL 1- 5: key "ACTVA"
COL 12-15: key Activity Number of activity 0001 to 9999
COL 16: key "O" (letter "O")
COL 17-20: key number of work days duration of activity (right justified, integers only)
COL 25-71: key description of activity
COL 72-73: imposed constraint code
COL 74-80: imposed constraint date

```

**Figure 33.5.2** Excerpt from 1987 specification for format of submitted ASCII files in lieu of Primavera.

This standard, too, has evolved over the years and is now a standard used by several governmental entities and known as the “Unified Facilities Guide Specification” which can be customized by the user. The base document is 27 pages long and is included as Appendix B.

### 33.6. Sanctions

The discussion of specifications is a proper place to identify the actions that will be taken if the CPM schedule and methods are not properly applied. The most common sanction is a refusal to make progress payments unless the CPM schedule has been submitted and approved or to limit progress payments to the first 3 months or some other reasonable time frame.

An example taken from the Dade County specifications for its metro system spelled out the following sanctions:

**FAILURE TO SUBMIT NETWORK ANALYSIS:** Failure of the Contractor to submit the network analysis or any required revisions thereto within the time limits stated, shall be sufficient cause for certification that the Contractor is not performing the Work required by this Section, or that the Contractor’s personnel directly responsible for planning, scheduling, and maintaining progress of the Work are not performing their work in a proper and skillful manner, or both. The Engineer may withhold approval of the Contractor’s invoices for progress payment until such delinquent submittal is made.

Dade County in its general contracts has one of the strongest sections on sanctions used to date by anyone or any organization:

A. The Contractor shall prosecute the Work in accordance with the latest approved network analysis. In the event that the progress of items along the critical path is delayed, the Contractor shall revise his planning to include additional forces, equipment, shifts or hours as necessary to meet

the time or times of completion specified in this Contract. Additional costs resulting therefrom will be borne by the Contractor. The Contractor shall make such changes when his progress at any check period does not meet at least one of the following two tests:

1. The percentage of dollar value of completed work with respect to the total amount of the Contract is within ten percentage points of the percentage of the contract time elapsed, or

2. The percentage of dollar value of completed work is within ten percentage points of the dollar value which should have been performed according to the Contractor's own network analysis previously approved by the Engineer.

- B. Failure of the Contractor to comply with the requirements under this provision will be grounds for determination that the Contractor is not prosecuting the work with such diligence as will ensure completion within the time of completion specified in this Contract. Upon such determination, MDC may terminate the Contractor's right to proceed with the Work, or any separate part thereof . . .

Of course, the provision of onerous sanctions does not mean that such can or will be used. In one instance when performing work for the U.S. Navy on a project, the contractor simply refused to provide a CPM submittal in accordance with the contract documents. The commanding officer complained that the contractor made it known that if payment was stopped, work would stop, and all understood the urgent need for the project was such that there was little real threat of termination. What was recommended by the consultant was increasing the retainage from 10 percent to 20 percent until such time as the CPM was properly submitted and employing and back charging for a third-party consultant to warn of potential delay issues. A nuclear bomb is not always effective; sometimes you just have to send in the Marines.

### **33.7. Sample CPM Specification**

A sample CPM specification is provided in Appendix A for the purposes of assisting the engineer in preparation of the specification for the next project. As with any canned guide specification, it is necessary to carefully review the contents and modify the contents to fit the specific project and mesh with other provisions of the contract documents. For example, for a highway project, the language at Sections 1.3.3.1 and 2.1.13.8, relating to building system and codes for floor, are certainly out of place. Similarly, the provisions relating to cost loading are designed to mesh with specific language in a separate section of progress payments. Finally, the laws of the jurisdiction where the specification may be enforced must be reviewed.

### **33.8. Summary**

CPM as a theory needs a specification to bring it into contractual reality. The availability of an acceptable reference standard can make this easier. Currently, there are no ANSI or ASTM standard references to fill this role. The 1965 AGC book can fill the role evenhandedly, but the 1976 AGC effort does so less evenhandedly.

The balance of the chapter provides examples of various modes of scheduling specifications that could be used with minimal changes to a project.

## CPM in Claims and Litigation

### 34.1. Introduction

An important function of scheduling in the construction industry, for both the owner and those doing the construction, is to evaluate claims based on failure to meet schedules. CPM can affect claims in two ways.

1. It establishes a realistic schedule through CPM planning, which can furnish a legal basis for the enforcement of damages.
2. Perhaps even more important, it can be used to evaluate actual claims through the reconstruction of a project's history or the use of an existing CPM plan to indicate the effects of changes on the original schedule.

In one instance, a contractor, a consortium, was asked by a bridge authority to show why it should not be pressed for \$550,000 in liquidated damages. The authority believed that the contractor had done a good job, but because of the public trust involved, it felt that it needed tangible proof of good performance.

In response, the contractor used a construction as-built CPM plan to demonstrate the effects of three different unforeseen circumstances: unusually bad weather, loss of special equipment by fire, and time lost in doing work claimed as extra. The presentation demonstrated the combined effect of the three causes (which was less than the serial effect) and the effects of any one or two of them alone and together. Thus, if any one or two of the factors had been deemed non-excusable, the effect of the remaining factor or factors was still quantified. On the basis of the finite presentation, the bridge commission did not press for the liquidated damages.

In a complex multimillion dollar suit and counter-suit the owner, an airport authority, used a detailed as-built CPM to realistically evaluate the overall effects of the changes that both the owner and the contractor had imposed on the project. The network, set up on a historical basis, could be run to consider the combined effect of the changes as well as the separate effects of individual changes.

Information from daily, weekly, and monthly field reports was used to prepare the historical CPM network. The calculated results were invaluable to the owner's engineer for preparing a factual testimony. The pretrial and trial periods extended over a number of years, and without the historical network, factual testimony would have become almost impossible.

In negotiating extra work, contractors often neglect the effects a change order will have on working time, so they either request no time extension or an extension equaling the total period they estimate the additional work will require. However, extra work on a project usually affects float areas, and any time extension granted should be less than the total incremental time needed to complete the additional work.

At Cape Canaveral, the combined emphasis on time and public pressure to complete projects reversed this situation. Contractors recognized more clearly the time-money relations and usually made substantial requests for additional time as well as for extra money to implement changes. The Corps of Engineers and NASA required network analysis for the basic work on most of the major projects undertaken. Thus, most of the contractors prepared network-oriented fragnets to demonstrate the effects that additional work would have on scheduling. There were abuses, but in the long run, CPM was used fairly by both parties to evaluate requests for time extensions, and many claims were settled without the drudgery of formal suits.

Also at Cape Canaveral, a new type of claim evolved: a claim for acceleration charges. Contractors would often accept extra work items and agree to perform them in the originally allotted time span. To balance the obvious inequity of additional work but no time extensions, a fee for work acceleration would be charged to compensate for the costs of overtime and other problems that arose, such as inefficiencies generated by overstaffing particular areas of work.

The type of contract originally signed impacts whether there is a potential for easy resolution or settlement of claims should they arise. Construction management and negotiated contract claims in the private sector can often be resolved by an objective report based on schedules and other factual information. Objective evaluation is important not only in regard to the legalities of the settlement proceedings, but as documentation for proving to both plaintiff and defendant that a proper settlement has been reached. Claims in the public sector are usually not

so easily settled, however, and an increasing number of disputes are running the full course of litigation.

### 34.2. Evidentiary Use of CPM

During the 1960s, CPM schedulers, technicians, and engineers anticipated that the critical path method would be used as a tool in construction claims and litigation at some time. In fact, as early as 1963–1964, consultants to the litigants on both sides of a case involving the Atomic Energy Commission used CPM to prepare their positions, although a case citation is not available, and no wide exposition of the results was made.

In the 1970s, 1980s, and 1990s, CPM techniques were often used in presenting and defending delay claims cases. In no case in which OKA was involved was the use of CPM questioned by opposing counsel or the court. Some of the cases include the following (dates are approximate):

- *IBM vs. Henry Beck Construction*, Federal Court, Florida, 1973.
- *Somers Construction vs. H.H. Robertson*, arbitration, Philadelphia, 1973.
- *E.C. Ernst vs. City of Philadelphia*, Eastern Federal District Court, Philadelphia, 1976.
- *Arundel vs. Philadelphia Port Corp.*, Commonwealth court, Pennsylvania, 1979.
- *Buckley vs. New York City*, New York State Court, 1982.
- *Kidde-Briscoe vs. University of Connecticut*, Connecticut State Court, 1980–1982.
- *Keating vs. City of Philadelphia*, Eastern District Court, Philadelphia, 1981.
- *Glasgow vs. Commonwealth of Pennsylvania*, Commonwealth Board of Claims, 1982–1983.
- *PT & L Construction vs. NJDOT*, New Jersey State Court, 1983.
- *I. DuPont Hospital vs. Gilbane, et al.*, mini-trial, Delaware, 1985.
- *White Oak Construction vs. Connecticut*, arbitration, Hartford, 1987.
- *G.E. Environmental Systems vs. Chevron*, arbitration, Philadelphia, 1988.
- *Santa Fe Construction vs. U.S. Navy*, Armed Services Board of Claim, Alexandria, Virginia 1989.
- *Shoemaker-Driscoll vs. Smith Kline Beckman*, mini-trial, Philadelphia, 1989.

- *Mergentime vs. Washington Metropolitan Area Transit Authority*, U.S. District Court, Washington, DC, 1992, Retrieved 2001.
- *Cris Tech vs. Joint Meeting* (EUC), arbitration, Somerset, New Jersey, 1993.
- *Brooks Construction vs. British Petroleum*, Commonwealth Court, Philadelphia, 1995
- *Newmont Gold Co. vs Lurgie, et al.*, Arbitration under International rules, NYC, NY, 1998

In many more OKA cases entered and en route to trial, CPM was a factor in settlement. In the early 1970s, several lawyers researched the question of CPM as an evidentiary tool. A series of articles and presentations followed, a number of which used the same thread, starting with the article, "The Use of Critical Path Method Techniques in Contract Claims," by Jon M. Wickwire and Richard F. Smith, in the *Public Contract Law Journal* of October 1974. Extracts from that article follow:

Judicial acceptance of CPM analyses as persuasive evidence of delay and disruption has been slow to develop, primarily due to technical errors in the analysis submitted or a failure of a presentation to realistically portray the work as actually done. In spite of the early reluctance to accept CPM presentations, the current state of the law is that use of CPM schedules to prove construction contract claims has become the standard, rather than the exception. Scheduling techniques which cannot display activity interrelationships are not favorably regarded as evidence of delay and disruption.

In *Minmar Builders, Inc.*, GSBGA, 3430, 72-2 BCA ¶ 9599 (1972) the General Services Administration Board of Contract Appeals commented upon Minmar Builder's construction schedules (bar charts) which were offered to show project completion delay due to government's failure to timely issue ceiling change instructions:

Although two of Appellant's construction schedules were introduced in evidence, one which had been approved by the government and one which had not, neither was anything more than a bar chart showing the duration and projected calendar dates for the performance of the various contractual tasks. Since no interrelationship was shown as between the tasks the charts cannot show what project activities were dependent on the prior performance of the plaster and ceiling work, much less whether overall project completion was thereby affected. In short, the schedules were not prepared by the Critical Path Method (CPM) and hence are not probative as to whether any particular activity or group of activities was on the critical path or constituted the pacing element for the project.

The greatest difficulty encountered by contractors using CPM techniques in claim presentation is the requirement for the presentation to be thoroughly grounded in the project records. The failure of contractors to properly document CPM studies has been held controlling in many board decisions . . .



Guidelines for the use of CPM presentations were set forth in the General Services Administration Board of Contract Appeals decision in *Joseph E. Bennett Co.* (GSBCA 2362, 72-1 BCA ¶ 9364 (1972)) which . . . affirms the need to properly update a CPM and support the study with accurate records. The contractor's claim in this appeal was founded on a letter from the contracting officer ordering completion of the work by the contract completion date. The contractor argued this requirement was an acceleration order, which was denied by the contracting officer because of a lack of meaningful evidence. The contracting officer rejected the accuracy of the contractor's critical path method construction plan on the basis of errors in the interrelationships of activities.

At the board, the appellant presented a computer analysis of the CPM used on the project to isolate the delays caused by government activities. The board held that the usefulness of this analysis was dependent upon three things: 1) the extent to which the individual delays are established by substantial evidence—this requirement is concerned with the project records and evidence available for the appellant to show the underlying causes of delay; 2) the soundness of the CPM system itself—this requires the contractor to demonstrate the logic of the CPM and show that its theoretical and scheduling analyses are sound; and 3) the nature of and reason for any changes to the CPM schedule in the process of reducing it to a computer program—this relates to the exactness and accuracy with which the appellant has reduced the CPM network to a computer analysis and how effectively this analysis can be used in a claim presentation.

As expected, the appellant in *Bennett* argued that the CPM was the proper basis for any analysis of the project since the plan was submitted by the appellant and approved by the government.

However, the board rejected the appellant's CPM analysis because it: 1) contained numerous mathematical errors; 2) failed to consider foreseeable weather conditions; 3) changed the critical path and float times without reason; and 4) was prepared without the benefit of any site investigation and after the project was already completed . . . .

The gradual acceptance of CPM presentations when properly documented is demonstrated in the case of *Continental Consolidated Corp.* ENG BCA 2743, 2766, 67-2 BCA ¶ 6624 (1967) . . . .

In this case a claim was submitted for extra costs due to suspension of work and subsequent acceleration directed by the government. The appellant alleged it was entitled to time extensions due to government delay in approving shop drawings. The government's failure to grant time extensions for these delays made the work appear to be behind schedule as of certain dates when in fact, if proper time extensions had been granted, the appellant would have been on schedule. As a result, government directives to work overtime and/or extra shifts would have been unnecessary . . . .

The contract set completion dates for various elements of the work which in effect required a critical path for each element within an overall work plan. With the use of the appellant's CPM analysis, the board was able to separate out the delay costs due appellant and the additional costs incurred due to a compensable acceleration order. This evidentiary tool allowed the

board to identify the periods of delay and actual progress on the job and thereby determine when an acceleration order was properly issued from that point in time when such an order was compensable because the contractor was back on schedule.

Thus the boards have recognized the value of a CPM developed contemporaneously with the work or subsequent to the work so long as it is based upon the relevant records available. The records may include daily logs, time sheets, payroll records, diaries, purchase orders. While the boards have accepted the CPM as an evidentiary tool, this tool cannot rise above the basic assumptions and records upon which it is founded. The board can accept the theoretical value of a CPM presentation, but reject its conclusion for failure to base the analysis on the actual project records. (See *C. H. Leavell & Co.*, GSBGA 2901, 70-2 BCA ¶ 8437 (1970); 70-2 BCA ¶ 8528 (1970) [on reconsideration] where the contractor failed to establish the accuracy of the input data for its computer analysis of delays due to design deficiencies.)

Where the board has received persuasive evidence that the CPM network is either logically or factually inaccurate, incomplete or prepared specifically for the claim, the board will discount its evidentiary value. A CPM must be linked to the job records, as a CPM analysis is primarily concerned with visually portraying the job records to establish the cause of delay or disruption.

The extent to which a CPM presentation may be used to document a claim can be seen in *Canon Construction Co.* (ASBCA 16142, 72-1 BCA ¶ 9404 1972) where the contractor gained total acceptance of its CPM schedule to establish a delay claim. In this opinion, the board recognized the underlying logic and evidence presented in the appellant's original CPM schedule and the value of CPM techniques to prove extended overhead costs.

In *Canon*, the contractor was awarded his overhead costs determined by the difference between the actual date of completion and the date the contractor would have completed the work absent government fault and performance of changed work. But the recovery of extended overhead costs was held to be limited by either the extended period of performance time or the aggregate net extent of delays caused by government fault or change work, whichever was the lesser. Using this formula the board recognized that the contractor was not entitled to recovery for the group of excusable but non-compensable delays including weather delays, reasonable suspensions of work, etc. . . .

The *Canon* decision is extremely important since it shows that a properly prepared and presented CPM schedule will be accepted by the board as the basis for computing project delays. In this regard it is noted that the board clearly indicated that it was "relying principally on the CPM chart and only using the witness' testimony to ascribe an aspect of reasonableness to the chart."

The *Canon* decision is also significant since it provided further guidance as to the application of CPM principles to claims. For example, the board acknowledged that delays incurred off the critical path would not delay

ultimate performance. Further, the board found that where the sequence established by the network was violated, costly start and stop operations would result and implied that the contractor's planned network operations need not be the only way to accomplish the work shown, but must be shown to be economical in both cost and time. (Reference: Stagg Construction Co., GSBCA, 2644, 69-2 BCA ¶ 8241 (1970) [on reconsideration]).

In 1975, coauthors Paul J. Walstad, Jon M. Wickwire, Thomas Asselin, and Joseph H. Kasimer wrote a book titled *Project Scheduling and Construction Claims, a Practical Handbook*, which is published by A. James Waldron Enterprises. On page 14-1, the authors note:

There was reluctance at first to accept the use of CPM analysis as evidence of delays and disruption. Of paramount concern were possible technical errors in the system or a failure of the system or analysis to realistically portray the work as actually done. See e.g., A. Teichert & Sons, Inc., ASBCA No. 10265, 68-2 BCA ¶ 7151 (1968) . . . .

This concern no doubt stemmed from early presentations which based CPM analysis to a great extent on speculation, inferences, or innuendo rather than hard, documented facts. Thus, even though the CPM has become recognized as a competent source of evidence . . . its usefulness in providing a claim has been held dependent upon at least four factors:

1. The soundness of the CPM schedule itself . . . This requires proof of the reasonableness and feasibility of the schedule so as to show that on a theoretical basis the scheduling was sound;
2. The extent to which any individual delays can be established by substantial evidence. This goes to the basic records and evidence available to the claimant to show the underlying causes of delay and disruption;
3. The nature of any changes to the CPM schedule made during the claim analysis process. This relates to the exactness and accuracy with which the claimant has analyzed the project scheduling in making his presentation;
4. Proof that the work sequence shown was the only possible or reasonable sequence by which the work could be completed on time.

In the late 1970s and early 1980s, *Engineering News-Record* presented a series of professional seminars on claims and litigation. Paul J. Walstad, Esq., has been a leader in the formulation and presentation of a number of these. The comments on evidentiary value of CPM continue as previously described. By 1980, Walstad had added the following in this regard:\*

In Blackhawk Heating & Plumbing Co., Inc., GSBCA No. 2432, 75-1 BCA, the contractor claimed 403 days as a result of ductwork design deficiencies. The Board found the deficiencies were the fault of the Government. However, the Board indicated the main question was whether the ductwork

delay had extended contract completion; the Government contended a delay involving electrical fixtures was the critical item.

In support of its position, the Government produced its own CPM analysis, which had been prepared after the delays had occurred. The Government CPM showed the ductwork design problems were not on the critical path; the activities which the contractor had contended were delayed actually had “float” time remaining even after the delay was considered, and the critical path ran through the electrical fixture approval, delivery and installation cycle.

The Board carefully analyzed the Government’s CPM, and found it . . . established a sound network diagram and computer run showing just how the project was actually constructed up to the date of substantial completion on December 7, 1970 . . . .

After reviewing the delay analysis set forth in the Government CPM, the Board further concluded it had provided “a sound basis upon which to evaluate various project delays.” Based upon the finding the electrical fixture delay was the factor which delayed ultimate completion, the Board then proceeded to allocate responsibility for the fixture delays. Upon reconsideration, the Board refused to modify its original decision, indicating the as-built CPM was the best evidence of delay.

The use of CPM as an evidentiary tool in claims and court proceedings is not confined to administrative boards. In the *Brooks Towers Corporation vs. Hunkin-Conkey Construction Company*, 454 F. 2d 1203 (10th Cir. 1972), the owner claimed delay damages from the contractor. The Tenth Circuit Court of Appeals affirmed an award in favor of the contractor, and in so doing placed great weight on the CPM analysis provided by an expert witness:

“The testimony of Richard N. Green, a Construction Consultant, is corroborative of Ratner’s grant of some 185 days extensions and significant in relation to the ‘clockwork’ scheduling of work components required to accomplish the original contract completion schedules. Green’s study took into consideration the plans and specifications, the computerized Critical Path Scheduling program, all Bulletins, formal Change Orders, related correspondence, Daily Progress Report and Monthly Pay Requests. He computed some 394 days involving requests for extensions. He eliminated those of an ‘overlapping’ nature and those which were not critical. He did not consider delays resulting from labor disputes or severe weather conditions. He arrived at a total of 180 days extension of time to which the Contractor was entitled.”

In its decision of July 18, 1983, the General Services Administration Board of Contract Appeals (GSA BCA) complained about the misuse of CPM schedules in a claim by Welch Construction, Inc. Welch filed a claim for damages as a result of owner delay in the modification of a geological survey center. When presenting its claim, Welch used CPM diagrams that purported to present as-planned and as-built schedules. In its opinion, GSA BCA, denying the claim, stated:

Candor compels us to admit that we may not have figured out what it was that Appellant thought its exhibits would show. If so, Appellant has only itself to blame . . . [One] of the surest ways of losing a case for lack of

proof is submitting complex exhibits to a trier of facts with no attempt to explain what they show or how they relate to the other evidence in the record. The Board believed that the schedules used in presenting the claim ignored both contractual and actual completion dates.

Courtesy of the *Public Contract Law Journal*.

Used with permission. Courtesy of A. James Waldron.

Engineering News-Record, “*Advanced Course on Construction Claims*,” p. 269, May 1 and 2, 1980. Used with permission, McGraw-Hill: New York, and Construction Education Management Corporation.

*This page intentionally left blank*

## Delay Analysis

The principal dimension measured by schedules is delay. In the past, delays in construction used to be a mutually accepted condition. Courts, on occasion, even recognized that delay was a normal situation in the construction process. Today, however, delay is a very problematic area, because owners have tighter budgets and contractors staying on a job longer than planned incur real costs.

When delays occur during construction, the parties involved attempt to shift the costs that result onto each other. If litigation results after negotiations fail, the lawsuits are between two or more losers, all of whom are attempting to mitigate their losses. There are no winners in delay.

To the private owner, delay can mean a loss of revenues through the resulting lack of production facilities and rentable space, as well as through a continuing dependence on present facilities. To the public owner, it can mean that a building or facility is not available for use at the proper time. The service revenues lost through delay can never be recovered.

To the contractor, delay means higher overhead costs resulting from the longer construction period, higher prices for materials because of inflation, and escalation costs due to labor cost increases. Further, working capital and bonding capacity are so tied up that other projects cannot be undertaken.

### 35.1. Delay versus Disruption

Another reason why courts traditionally did not recognize delays is the confusion over terminology, distinguishing delay from disruption. During the course of the project, not every delay to a specific task is going to result in a delay to the project. In fact, the majority of delays to specific tasks will not delay the project as a whole.

A court facing competing claims of major delays to electrical installation due to alleged under manning and millwork installation due to owner indecision might well throw up its hands. Thus, parties to a dispute may paper the file with numerous claims of such instances for the very purpose of confusing the court.

The introduction of the CPM process, distinguishing those activities that are “critical” from those having “float,” has provided the courts with a new means to segregate the complaints into those causing delay from those merely causing a disruption to the flow of work. As noted previously, courts have recognized that a certain level of disruption is to be expected in the construction process, but also understand that unreasonable levels of disruption can have their own cost and even contribute to responsibility for a delay to the project by diverting resources from critical activities.

### **35.2. Responsibility / Types / Force Majeure**

The assignment of responsibility for delay after the fact is often difficult, and courts have often remarked that delay should be anticipated in any construction project. Traditionally, the courts have protected owners more than contractors. In recent years, no-damage-for-delay clauses have often been enforced in many states, with contractors receiving only time extensions when delays occurred. However, granting time extensions evades another owner-oriented remedy for problems connected with delay: liquidated damages. Even when courts are inclined to consider recovery of damages for owner-caused delays, the burden is on the contractor to prove active interference on the part of the owner to receive a favorable decision.

There are four general categories of responsibility:

1. Owner (or owner’s agents) is responsible.
2. Contractor or subcontractors are responsible.
3. Neither contractual party is responsible.
4. Both contractual parties are responsible.

When the owner or owner’s agents has caused the delay, the courts may find that the language of the contract, in the form of the typical no-damage-for-delay clause, protects the owner from having to pay damages but requires a compensatory time extension to protect the contractor from having to pay liquidated damages. If the owner can be proved guilty of interfering with the contractor’s progress on the project or has committed a breach of contract, however, the contractor can probably recover damages from the owner.

If the contractor or subcontractors cause the delay, the contract language does not generally offer the protection against litigation on the



part of the owner to recover damages. If the delay is caused by forces beyond the control of either party to the contract, the finding generally is that each party must bear the brunt of its own damages. If both parties to the contract contribute to the delay or cause concurrent delays, the usual finding is that the delays offset one another. An exception would be instances in which the damages can be clearly and distinctly separated.

There are three basic types of delay: classic, concurrent, and serial. Classic delay occurs when a period of idleness and/or uselessness is imposed on the contracted-for work. In *Grand Investment Co. vs. United States*, 102 Ct. Cl. U.S. 40 (1944), the government issued a stop order by telegraph to the contractor that resulted in a work stoppage of 109 days. The contractor sued for damages caused by the delay, basing the suit on a claim of breach of contract.

The court allowed, among other things, damage due to the loss of utilization of equipment on the job site, finding inability to use equipment on the job site, and stating:

When the government in breach of its contract, in effect, condemned a contractor's valuable and useful machines for a period of idleness and uselessness . . . it should make compensation comparable to what would be required if it took the machines for use for a temporary period.

*Johnson vs. Fenestra*, 305 F. 2d 179, 181 (3d Cir. 1962), also involved a classic delay: Workers were idled by the failure of the general contractor to supply materials. That type of delay, to be legally recognized as such, must be substantial, involve an essential segment of the work to be done, and remain a problem for an unreasonable amount of time.

Generally, if two parties claim concurrent delays, the court will not try to unravel the factors involved and will disallow the claims by both parties. In *United States vs. Citizens and Southern National Bank*, 367 F. 2d 473 (1966), a subcontractor was able to show delay damages caused by the general contractor. However, the general contractor, in turn, was able to demonstrate that portions of the damages were caused by factors for which he was not responsible. In the absence of clear evidence separating the two claims, the court rejected both claims, stating:

As the evidence does not provide any reasonable basis for allocating the additional costs among those contributing factors, we conclude that the entire claim should have been rejected.

Similarly, in *Lichter vs. Mellon-Stuart*, 305 F. 216 (3d Cir. 1962), the court found that the facts supported evidence of delay imposed on a subcontractor by a general contractor. It also found that the work had been delayed by a number of other factors including change orders, delays caused by other trades, and strikes.

The subcontractor had based its claim for damages solely on the delay imposed by the general contractor, and both the trial court and the appeals court rejected the claim on the basis that:

Even if one could find from the evidence that one or more of the interfering contingencies was a wrongful act on the part of the defendant, no basis appears for even an educated guess as to the increased costs . . . due to that particular breach . . . as distinguished from those causes from which defendant is contractually exempt.

It should be noted that in recent decisions, the courts increasingly have demonstrated a willingness to allocate responsibility for concurrent delays.

Serial delay is a linkage of delays (or sometimes of different causes of a delay). Thus, the effects of one delay might be amplified by a later delay. For instance, if an owner's representative delays reviewing shop drawings and the resulting delay causes the project to drift into a strike or a period of severe weather resulting in further delays, a court might find the owner liable for the total serial delay resulting from the initial incremental delay.

Force Majeure causes include what are known as "acts of God." The general contract usually provides a list of such events: fires, strikes, earthquakes, tornadoes, floods, and so on. Should such an event occur, the contract provides for a mutual relief from demands for damages that are due to delay, and the owner is obligated to provide a reasonable (usually a day-for-day) time extension.

In the case of weather-related delays, usually only the occurrences shown to be beyond the average weather conditions expected for the area based on past records can be considered as a reason for time extensions. That can, however, vary with contract language. A number of states and cities allow a day-for-day time extension (noncompensable) for all bad weather.

Many contracts have clauses stating the time extensions for delay caused by acts of God shall be granted only to the portions of the projects that are specifically affected by such events. Thus, a severe downpour after a site has been graded and drained and the building closed in may cause no actual delay, so that claims for time extensions because of it would not be accepted even though it would qualify under other methods of evaluation as a Force Majeure act.

### **35.3. As-Planned Logic Network**

The first step in preparing an analysis to determine responsibility for delay to a project is to locate or otherwise acquire the as-planned logic network. This may be, but often is not, the submitted and approved baseline schedule. The key factor in determining if a "baseline" is the

proper starting point is whether it includes information known after the start of the project. A proper as-planned logic network will not include any information known after the start of the project, although there may be some leniency relating to the period of time between submission of the bid and NTP.

The rationale for this rule is based upon the concept of contract. In the rush to bid a project, a contractor rarely has sufficient time to carefully plan all the details of how it will perform the work and often does not have the input from all members of the project team that will supervise such work. However, the contractor does anticipate that once a bid is won, the project team will carefully review the project drawings and specifications and choose one of many possible “plans of execution” to effectuate performance in what it deems the most expedient and cost-efficient manner. This thought pattern, however expressed and recorded, is the basis of the *as-planned logic network*.

The CPM as initially submitted may be rejected for real or imagined flaws. If technical flaws are in the submitted CPM, they must be corrected, and it is not uncommon for there to be several submittals and rejections over a period of months until a proper CPM may be approved. However, during this period it is important that neither party use the approval process to modify the initial “plan of execution” to account for later unanticipated events. From the viewpoint of a proper analysis, the maneuvering of the parties over acceptance of the CPM submittal should be ignored. Thus, an acceptance too hastily made should not bind the owner and an improper resubmittal required by an owner should not bind the contractor.

In *Edwin J. Dobson, Jr. Inc. vs. Rutgers* (157 N.J. Super. 357, 384A. 2d 1121 [1978]), the Court found that the schedule was not complete enough to use to measure delay until the third update. In *Dobson vs. Rutgers*, the Court also held that the schedule does not have to be formally accepted by the owner or agent to be accepted as the basis for delay analysis.

Once a proper as-planned logic network has been chosen, the CPM can be useful in establishing the facts and also the intentions of the parties to a contract. The network can be used by the owner to demonstrate areas of failure on the part of the contractor, and it can be used by the contractor to demonstrate points of interference on the part of the owner or owner’s agents.

A project involving regular (usually monthly) reviews or updates of the CPM plan should provide a good basis, through the CPM reports, for evaluating the progress of the work done on it. Unfortunately, many such projects have only a collection of CPM diagrams and computer runs to show for the reviews. The CPM reports are far more valuable if each update is accompanied by a comprehensive narrative. The narratives, which should be normal portions of the project documentation, are

prepared in the normal order of business and, therefore, can be accepted later at face value, with due weight given to their origins.

#### **35.4. As-Should-Have-Been CPM Network**

While it is best to start with an as-planned logic network, there are situations where a good as-planned network did not exist or the one used was flawed or inadequate. In this case, an as-should-have-been network can be produced. Obviously, what is desired here is to recreate the “plan of execution” envisioned by the project team at the time the work was starting and not to utilize “Monday morning quarterbacking” to create a CPM of how the work should have been planned. If the matter is in dispute, the urge for one party to submit a plan that exaggerates the impact of faults of the other party and sidesteps its own faults may be large. Obviously, it is here that the question of the credibility of the Scheduler will come into play, thus, it is also important to document the sources of information used to recreate the as-should-have-been to become the as-planned CPM.

Thus the terminology means “as-should-have-been-submitted” and not “as-should-have-been-planned.” In the event that the contractor’s CPM is missing some portion of the scope of work (such as installation of a pipe below a foundation), this is to be treated similarly as when the engineer’s drawings are missing an existing condition (such as a buried pipe) or necessary scope of work requiring a change order. In either case, the work additional to the contractor’s original plan will be added to the as-impacted network as described in section 35.9

In some cases, the preparer of the as-should-have-been network has a bar graph to utilize as a guideline. In other cases other contemporaneous documents must be used as primary source material, or to bolster and validate interviews with key staff members on how they planned to perform the project. In one major project, the new Library of Congress building (James Madison Memorial Library), it was recognized by both the owner, the Architect of the Capitol, and the contractor, Bateson Construction Co., that there would be delay claims as a result of certain delay problems in the project. It was mutually agreed that it would be advantageous to convert the contractual as-planned bar graph into a CPM network, which would prove more useful in evaluating the effects of delay impacts.

The contractor’s scheduling consultant, A. James Waldron, converted the network into a CPM diagram and printout. This was reviewed for the Architect of the Capitol by O’Brien-Kreitzberg & Associates (OKA) and, after some adjustments, a mutually agreed upon baseline was stipulated. The network was useful to both sides in determining the responsibility

for delays and the resulting costs. Often, an as-should-have-been network is more of an uphill situation. If both parties do not agree to a previously approved as-planned network, whoever produces the as-should-have-been network must be able to provide a foundation for it and to justify its use.

In one such application, the New Jersey Department of Transportation specification had an elaborate narrative description of the sequencing required for implementing a project. At that time, the state did not use CPM planning, and the contractor, a major heavy construction contractor, submitted a totally inadequate bar graph that used fewer than 25 activities to describe the work to be accomplished. The contractor also worked in such a fashion that he produced a large amount of excavation soil, which was to be used on and/or sold to other projects. The economic plan made sense, but the logic did not. OKA used experienced highway engineers to develop an in-depth, as-should-have-been network, which resulted in being 24 sheets long in its logic and made up of more than 4000 activities. The computer run demonstrated the impropriety of the contractor's initial actions and illustrated a lack of planning in regard to the project.

### **35.5. As-Planned Schedule**

Emphasis in the prior section has been placed on calling the CPM the as-planned logic network to distinguish such from the as-planned schedule. The reason for this emphasis on terminology is to stress that it is the logic that will be the basis for further steps of the analysis and that, at this point of the analysis, schedule dates are mostly irrelevant. A quick calculation of the schedule from the as-planned logic network may allow the team to determine if some of the logic is missing or incorrect. A schedule showing pouring of concrete in northern latitudes during the winter may indicate some adjustment is necessary. But the flip side is not necessarily true, that is, an otherwise good logic network may neglect to include many of the assumptions therein. Bumping the start date of the CPM by 3 months, rescheduling and reviewing the output may point out some of this missing logic. So it remains the careful and detail review of the as-planned logic network to provide assurance that each activity is preceded by a physical restraint to some physical object, and is also preceded by a resource restraint for each necessary resource (crew, equipment, forms, etc.) that will be necessary for a proper analysis. An as-planned schedule may exclude assumptions that may be ignored so long as the project is going smoothly. An as-planned logic network for analysis of delay requires that these assumptions be stated within the logic.

If the contractor manipulates the as planned schedule, it can be disregarded as the basis for comparison with the as-built. In *Hensel Phelps v. U.S.* (ASBCA No. 49,270, 99-2), Hensel Phelps, the general contractor, prepared the CPM. Their mechanical subcontractor estimated 8 work weeks each for the duct line work for 12 process exhaust fans for a total of 96 weeks. In the CPM schedule, Hensel Phelps reduced the estimate to 3 weeks each for a total of 36 weeks. The subcontractor was not given a copy of the completed CPM as-planned schedule. The as-planned CPM was rejected as the basis for a delay claim because the general contractor had manipulated the as-planned schedule duration estimates.

### **35.6. As-Built Schedule**

When the activities on the as-planned network have been identified, work can start on an as-built schedule. A copy should be made of the As-Planned Logic Network and renamed as the As-Built Schedule. The second schedule should include the same activities as the first, for comparison purposes, but be based on actual performance dates. Those dates are researched from the updates of the original CPM plan, the progress reports, and any other documentation available. Sparse or faulty project documentation may make development of an accurate as-built schedule difficult.

For that reason, CPM updates should plug in actual dates for all activities as they start and as they are completed. However, it is often the case that erroneous dates are entered when two activity descriptions are similar or when the contractor has performed general condition work not on the CPM and yet desired to record progress to *something*. In such cases it may be necessary to research other contemporaneous project records, such as daily diaries or job photos, to determine a correct actual start and finish date. It is important to note where such changes have been made and to footnote the source of replacement data in such cases.

For a quick review, the as-planned and as-built schedules can be plotted side-by-side to the same time scale for a rough comparison. This review can assist in highlighting where the two schedules diverge and to help determine where further research is desired, but it is certainly not sufficient in itself to document a claim as neither the causes for variances nor the criticality of activities before and after impact are yet determined.

The work involved in preparing the two schedules will vary with the input information available, its organization, and the information on the levels of the work provided by the client and/or the client's attorney. Two to five people will be needed to work on them over a period of several months. The work should be under the direction of a CPM scheduling professional who is qualified to testify in regard to the final products.

From *Preston-Brady Co. v. U.S.* (VABCA Nos. 1892, 1991, 2555 87-1), “a general statement that disruption or impact occurred, absent any showing through use of updated CPM schedules, Logs or credible and specific data or testimony, will not suffice to meet that burden.....of proving the extent of any delay which it claims...This is particularly so where, as here, the Logs, when contrasted to the as-planned CPM schedule, show minimal delay to the very trades most directly involved in the change order at issue.”

### 35.7. As-Built Logic Network

Emphasis in the previous section was placed on preparing an as-built schedule and not an as-built logic network. In this phase of the analysis, it is the actual dates of performance that are important and not the actual reason why one activity is performed before another. Thus, if work was performed out-of-sequence from the as-planned logic, it is entirely possible that the as-built schedule will show an activity starting or even finishing before its predecessor.

An as-built logic network would record the actual logic—the “*why*” each activity was performed before the next. It may be possible to trace the actual logic for select portions of the project, but to do so for an entire project is usually difficult or impossible. Contemporaneous project records will rarely provide sufficient detail for such an endeavor. An example of the detail necessary to prepare a proper as-built logic network might include, as shown in Figure 35.7.1:

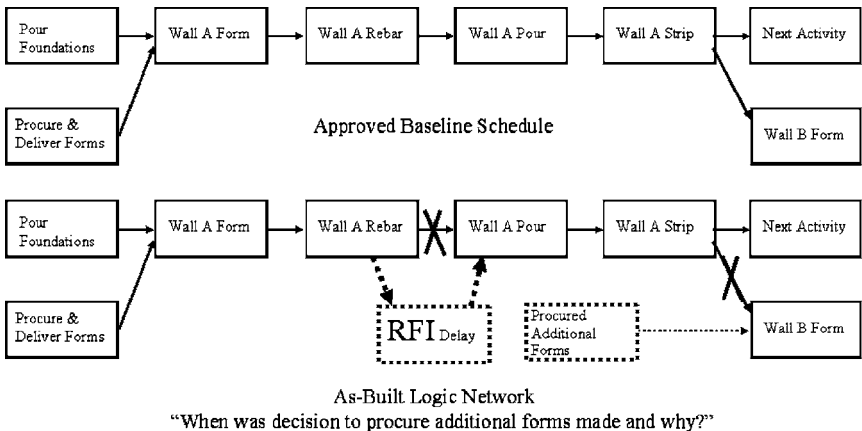

Figure 35.7.1 As-Built Logic Network.

- As-planned called for forms used for Wall “A” to be used for Wall “B”
- An RFI is issued relating to a rebar conflict, delaying completion of Wall “A”
- Additional forms rented and delivered to site
- Wall “B” constructed prior to completion of Wall “A”

Since the cause for deviation from plan is often not so straightforward and the reasons, therefore, rarely are recorded contemporaneously, the preparation of an as-built logic network for the entire project usually will involve a large degree of conjecture and subjectivity on the part of the preparer.

### **35.8. Causative Factors**

Once the as-planned logic network and as-built schedule are completed, a uniform format for evaluating the causative factors in the delay is now available. (Even before the completion of the network and schedule, a separate group under the direction of the scheduling professional can begin the evaluation.) The identity of most of the causative factors should be readily apparent, but the specific impact of different factors may not be obvious.

One of the first areas to be identified is Force Majeure. The most common being strikes and bad weather. Strikes should be documented in terms of their length, the remobilization time once they are over, and the trades and areas of work affected by them. Most contracts provide for time extensions because of strikes but not for compensation. In the case of a contractor making a claim, it would be important to be able to demonstrate that a strike had little or no impact on the critical path of a project, so that other compensable factors could be shown to be the cause of the damages being claimed. Conversely, an owner defending against claims would try to demonstrate that strikes did indeed cause the delays and other problems were, at worst, concurrent.

Other causative factors include:

1. RFIs, or request for information: claimed by the contractor to the owner
2. CICs, or change in condition: claimed by the contractor to the owner
3. CORs, or change order requests: presented by the contractor to the owner
4. PCOs, or proposed change orders: presented by the owner to the contractor
5. COs, or change orders: signed by the contractor and then the owner



6. PROs, or proceed orders: presented by the owner to the contractor
7. CCOs, or constructive change orders: claimed by the contractor to the owner
8. SWOs, or stop work orders: presented by the owner to the contractor
9. CQCs, or contractor quality control deficiencies noted: presented by the contractor to the owner
10. ODNs, or owner deficiency notices: claimed by the owner to the contractor
11. REJs, or rejection of submitted shop drawings: claimed by the owner to the contractor
12. REWs, or rework: reported by the contractor to distinguish from baseline productivity

The acronyms may differ from jurisdiction to jurisdiction and the list could go on to include other causative factors.

Causative factors are evaluated in terms of the specific impact that they have on the progress of a project. This is done in two ways. First, a determination is made at what point in the network a particular causative factor impacted the fieldwork. In addition, when dealing with changing or modifying the scope of work to be performed, activities that were preparatory for implementing the change work are identified. Examples are change order proposals, ordering material, mobilization, and any other pre-implementation factors. Other examples include demolition of defective work, reordering of material, and remobilization.

A separate evaluation is done for every causative factor in the project. In addition to identifying the basic impact each has had on the plan, the analysis must also identify the times of issue of the individual causative factor and reason therefore. While a change order issued in the eleventh month may be tied to the notice-to-proceed when all contract scope should be known and thus override contractor delays perhaps caused by under-manning, in an individual case, it may merely be tied to an activity preceding the one impacted when a visual inspection suggested the change to the owner. In such a case, the delay caused by the change would not override and be considered partially concurrent with the previous delays but merely add new delay time to the delays already encountered.

It is important to try to include all causative factors that may have impacted the project. During this phase responsibility for the various causative factors is not assigned. Not only is it important to air what is initially thought to be your own "dirty laundry," because the other side certainly will if you do not, but also in many cases, there may be some question as to who is the responsible party. For example, a rejected

shop drawing is typically charged to the contractor who is responsible for all of its subcontractors and vendors. However, if the engineer's rejection is later deemed improper, the delays for resubmittal, review, and all consequential delays, would be shifted to the owner. Similarly, poor productivity is usually charged to the contractor, unless such is the serial effect of shifting work from one season to the next due to causative factors chargeable to the owner.

Also keep in mind that most causative factors are not going to impact activities upon the critical path and will not actually cause delay to the project. However, it will be important to defuse the claims of "but he was doing that" when presenting the results of the delay analysis.

### **35.9. As-Impacted Logic Network**

Once all of the causative factors have been determined, they should be applied to another copy of the as-planned logic network. The rules of network development should again be rigorously adhered to, such as not permitting open ends or entering of actual dates. Where it is known that a causative event did not occur until a specific date, such may be entered via a SNET constraint.

The courts are firm that causation must be specifically connected to the resulting delay: In *Titan Mountain States Construction Corp. v. U.S.* (ASBCA Nos.22, 617, 22, 930, 23, 095, 23, 188, 85-1 the Board found: "A contractor was not entitled to time extensions for delay and impact allegedly resulting from modifications because his critical path analysis did not establish a causal relationship between the modifications and the alleged delays attributable to them."

In *Hoffman Construction Co. of Oregon v. U.S.* (40 Fed Cl.184 [1998]): "proof that the government was the 'sole proximate cause' of the delay entails proof 'that no concurrent cause would have equally delayed the contract regardless of the government's action or inaction' [*Mega Constr. Co., Inc. v. United states*, 29 Fed. Cl. 396, 424 (1993)]. . ."

In *Fru-Con Construction Corp. v. U.S.* 44 Fed.Cl. (1999) two burdens of the claimant contractor were described in the decision: (1) "Unless the Government retains control over the evidence, plaintiff bears the burden of establishing an excusable delay by a preponderance of the evidence" and (2) "It is not sufficient to establish that some work was prevented; the work prevented must be work that will delay the overall completion of the job."

In *PCL Construction Services v. U.S.* (47 Fed. Cl. 745 [2000]), the court held that the claim must meet three tests: "(1) the extent of the delay with a reasonable degree of accuracy; (2) that the delay proximately was caused solely by the government's actions; and (3) that the delay caused specific, quantifiable injury to the contractor."

### 35.10. As-Impacted Schedule

At this time, the as-impacted logic network should be saved to a secure file name and then (and only then) the scheduling routine applied. The purpose of this step is to be able to demonstrate that a true evaluation was performed rather than merely going through the motions to back into a desired result. At this point, the Scheduler has all of the information needed in a format suited to perform an analysis of delay.

### 35.11. Time Impact Evaluations

When all the causative factors have been identified, a time impact evaluation (TIE) is prepared for each factor. The information is assembled as previously described, and it is prepared in a format so that the impact of each factor on the as-planned network can be determined and applied to it.

When the impacts of all the causative factors have been correctly determined and applied, the result should be an approximation of the as-built schedule. The as-impacted schedule is then compared with the as-built one, and any major disparities between them examined to identify whether or not the TIEs were incorrectly applied or there were additional causative factors not identified.

The theoretical effects of the impacting factors on the as-planned network must be explainable in terms of the as-built network, otherwise the proposed analysis is probably incorrect. Some professionals take a different position, however. One well-known scheduling consultant expounds the theory of the 500 bolts: If an owner is to provide 500 bolts and has delivered only 499, in the consultant's opinion, the activity involved will be impacted until that last bolt has been delivered. But it appears more logical to examine the function of the last bolt. For instance, if the bolt is a spare or there is a readily acceptable substitute that permits construction to proceed, then it is not, theoretically, proper to claim that the as-planned network has been impacted by its absence.

Another position often taken by Schedulers who conduct impact analyses on as-planned networks for contractor evaluations, is that all float belongs to the contractor. This has been a continuing argument in the profession. In fact, some recent owner's specifications, in order to counteract such claims, state, "All float belongs to the owner." Neither position is tenable, however.

Float is a shared commodity. Like a natural resource, it must be used with common sense. The owner should be permitted to use float for order changes, shop drawing reviews, and other owner-responsible areas. On the other hand, it is obvious that owners should not use float to the point that the entire project becomes totally critical. This would

be an overreach on the part of owners. Conversely, contractors should be expected to use float only to balance their work forces and to work efficiently, to complete projects on time and at optimum budgets.

Once all of the TIE information has been imposed on the as-planned network, a standard CPM calculation is made. The calculation should correlate, as discussed previously, with the as-built network.

### **35.12. Zeroing Out**

If there are only a few causative factors impacting the as-planned logic network, it is suggested that the TIEs be selectively zeroed out by category. For instance, the Force Majeure changes are zeroed out and a run is made to determine the overall impact of their absence on the network. Similarly, contractor-related TIEs are zeroed out, and whatever further improvement their absence makes in the schedule is noted. Then, the owner-related TIEs, involving changes and any hold orders, and so on, are zeroed out, and the final result should bring the network back to its as-planned status.

Because each category of change is zeroed out step-by-step, the effects of concurrency can be observed from the results of the three separate runs. This can provide an arbitrator or a court with the means to allocate delay damages and impacts caused by the various parties. One of the first applications of this approach was to a major airport project. The airport authority had contracted for the installation of a \$15 million underground fueling system. The contractor for the work, who was the low bidder by several million dollars, prepared a construction CPM plan that was never accepted by the owner, and all of the milestone dates were completely missed. The airport authority took under advisement whether to enter suit for delay damages that were due to losses in interest on money and in airport operating efficiency, as well as for other direct delay damages.

When the contractor filed a \$6 million delay suit against the authority, the authority promptly filed a counterclaim and litigation ensued. In the absence of a mutually acceptable as-planned CPM, the owner directed that an as-built CPM be prepared to evaluate the real causes of the delays. The daily, weekly, and monthly reports, as well as personal observations by the owner's field team and the CPM consultant, were used to develop the comprehensive plan. It contained milestone points reflecting actual dates of accomplishment for various activities. Between the milestone points, the estimates for the time that the work should have taken were inserted, and the CPM team then divided the delay proportionally by its causes. The causes were either by contractor, owner, combined, or neither.

The first computer run of the network showed the actual dates for all the events. The next computation established the amount of delay

due to the contractor alone. The third established the amount of delay due to the owner alone. The fourth identified the amount of delay due to both. But the total actual delay was less than the combined total when the amounts caused by the owner alone and the contractor alone were added together.

Using this very specific information, the managing engineer for the owner was able to facilitate an out-of-court settlement that took more than a year to negotiate. (Part of the owner's management team's willingness to negotiate was because they recognized the very real delays they caused by a slow shop drawing review. Many of the delays were due to the high workload of the owner's engineering department, but many were caused by the engineers trying to redesign the shop drawing submissions, a common mistake made in the course of reviews.)

### 35.13. Zeroing to a Collapsed As-Impacted Logic Network

If there are many causative factors or if the determinations of responsibility for such are unclear, zeroing out by category may not be practical and an alternate means will be required to determine the impact (if any) of each causative factor. To effectuate this portion of the analysis, it is necessary to prepare a separate spreadsheet or provide additional activity codes for each activity representing a causative factor. The additional columns or code fields include:

1. order in which this causative factor is zeroed out,
2. the project completion date prior to this causative factor being zeroed out,
3. the number of days difference between the project completion date before and after zeroing out, and
4. the number of days between the activity impacted and project completion.

The process of zeroing out of causative factors one by one again begins with scheduling the as-impacted logic network. Next, starting at the last activity, or project completion, the analyst works backward, tracing the driving relationships until reaching either a causative factor or the start of the network. This will constitute the critical path of the TIE. Often there will be more than one such path either converging to one causative factor or more than one. Code the one or several causative factors as "001," note the finish date for project completion and start date for each causative factor, calculating and recording the number of days from the causative factor to project completion.

Then delete all successors to the one or several causative factors deemed the roots of the critical path(s.) Next, reschedule the network and trace the critical paths back to the next root causative factor(s.) Code as “002,” record the new project completion date, calculate the number of days between the last recorded completion date and the new one, note the start date for causative factor(s) and calculate and record the number of days from the causative factor(s) to project completion.

This process is repeated until reaching the start of the network rather than a causative factor. This final result should again bring the network back to its as-planned status. You may note that many of the causative factors still remain. This matches the reality that a majority of even the most “serious” causative factors encountered on a project are not the cause of delay. However inclusion of such in the analysis proves such an assertion and may defuse quite a bit of argument related thereto.

Where a project has intermediate milestone deadlines that are subject to actual or liquidated damages, the same approach may be used to determine time extension entitlement toward individual milestones. Starting from the milestone and working backward through the driving relationships leading thereto, the individual root causative factors can be ascertained until again reaching the starting point of the logic network. This should ideally be done with a fresh copy of the as-impacted schedule for each milestone as an individual causative factor may have a separate impact on various milestones and project completion.

At this point, two more columns may be added to the spreadsheet: one for the party alleged to be responsible for the causative factor, and the other to note whether that causative factor was the sole cause for the incremental impact to project completion, or was concurrent with one or more other causative factors.

### **35.14. Limitations of the TIE Methodology**

Either via grouping by categories or by the more tedious method of zeroing out causative factors one by one, the TIE method may be used to determine entitlement for relief from liability for damages caused by the delay. The fact that the project completion date of the as-impacted schedule may be later than the actual completion date is irrelevant so long as the impact to activities immediately successor to causative factors roughly matches the as-built. In fact, it is more likely than not that the project completion date of the as-impacted schedule will be later than the actual completion date since most contractors will make some attempt to mitigate the impact of various causative factors.

However, these efforts by the contractor to mitigate cannot be used to reduce the contractor’s entitlement. To some unquantified extent (at least

at this point of the analysis), the difference between the calculated project completion date of the as-impacted schedule and actual project completion date of the as-built schedule represents the cost of the efforts of the parties to accelerate work and mitigate the delays incurred by the project.

On the other hand, the contractor should not be entitled to monetary compensation for damages that have been avoided by such mitigation. Thus, while the TIE methodology is conclusive in determining entitlement to avoid the payment of actual or liquidated damages for late completion of the project or stipulated milestones thereto, it may tend to overstate entitlement to compensatory damages. To determine the appropriate number of days for which a contractor may be entitled to compensatory damages for field and home office overheads associated with an extended project timeframe, it is necessary to also factor in the impact of such mitigation. This is discussed in the section on the windows analysis methodology that follows.

### 35.15. TIE Example of John Doe Project

Take the 34-day CPM plan for the initial portion of the John Doe project as a schedule and use it to measure delays or impacts. If, for instance, the well pump required a 6-week delivery time, the equivalent number of work days would be 30. The impact area is measured by adding an activity starting at 0 and going to event 4. The activity would be titled “late delivery of well pump,” and adding it would produce the result shown in Figure 35.15.1, the time scale version of the initial part of the John Doe project. Because the well work was on the critical path, the delay would force the late start of activity 4–5, install well pump, to await the delivery of the well pump. In this example, 30 minus 22, or a delay of 8 working days.

Of course, it is necessary to view the entire contractual universe. For instance, if there was a 2-week delay in the notice to proceed for reasons other than the pump delivery, then the pump delivery delay would be better represented by disconnecting the initial, or *i* end, of the delay arrow from the 0 event and bringing it into the network as a new starting point with a specified date. Thus, if a 2-week Force Majeure delay were imposed on the start of the site work, the additional time needed for delivery of the well pump would become a concurrent delay.

Figure 35.15.2 shows a TIE form describing the delay in the delivery of the well pump.

Review of the TIE points out a number of additional issues. The evaluation does not note the original duration for this “stock delivery” item was 10 days, but does note that the responsibility for the delay

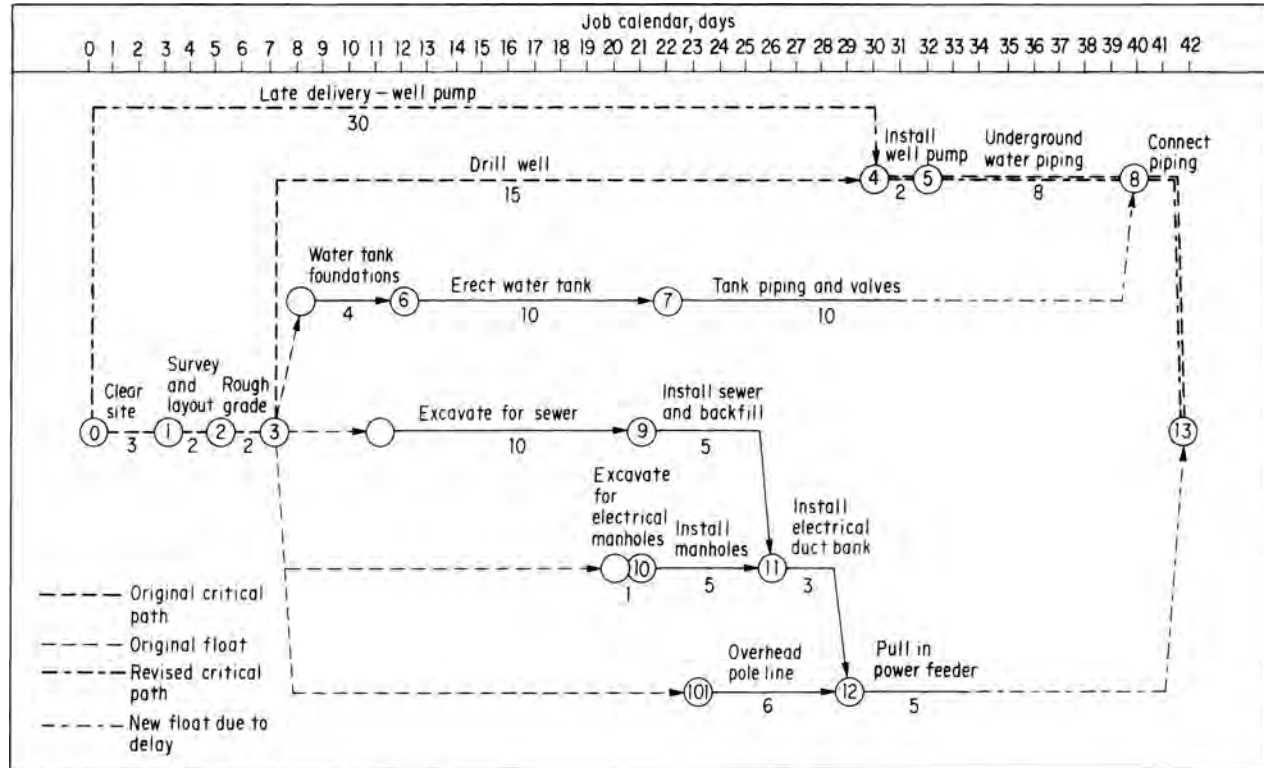

Figure 35.15.1 Time scale network showing late delivery of well pump delay.



TIME IMPACT EVALUATION

PROJECT: JOHN DOE TIE #: 1  
 PREPARED BY: J. J. O'BRIEN DATE: 9/15/95

DESCRIPTION: *LATE WELL PUMP DELIVERY - DELIVERY WAS SIX WEEKS AFTER CONTRACTOR NOTICE TO PROCEED. CONTRACTOR WAS READY FOR PUMP AT DAY 22.*

ACTIVITIES AFFECTED:  
*4-5 "INSTALL WELL PUMP"*

TYPE OF IMPACT:  
 INCREASED DURATION: \_\_\_\_\_ AMOUNT: \_\_\_\_\_  
DELAYED DATE/SUSPENSION OF WORK: *DELIVERED @ DAY 30*

FRAGNET:

```

    graph LR
      0((0)) -- "30 DELIVER WELL PUMP" --> 4((4))
      4 -- "22" --- 4
      4 -- "22" --- 4
      4 -- "2 INSTALL WELL PUMP" --> 5((5))
      5 -- "30" --- 5
      5 -- "22" --- 5
      style 5 stroke-dasharray: 5 5
  
```

EVALUATION/RESPONSIBILITY:  
*L.S. OF 4-5 WAS 22; ACTUAL START 30, THEREFORE 8 WORK DAYS DELAY ON CRITICAL PATH*  
*RESPONSIBILITY: A-E (FAILED TO DELIVER SPECIFICATIONS)*

Figure 35.15.2 Time impact evaluation (TIE) describing delay of well pump.

belongs to the A/E for failure to deliver the specification for the pump. Thus, after leaving a minimum of 5 days for contractor procurement, this activity would initially have had 7 days of float. The TIE does not provide when the A/E finally provided the specification (that presumably should have been provided no later than the notice to proceed) and

thus this must be presumed to have been on day 15 to provide the following sequence:

15 days to provide spec + 5 days to shop among 3 local vendors  
+ 10 days to prep and deliver to site = 30 days total

But what if the A/E had taken 22 days to provide the specification but the contractor had mitigated by ordering the same day the spec was received with a vendor preselected to expedite the delivery in return for a slightly higher price? If the TIE had been prepared on that day 22, the contractor would be entitled to a delay of  $8 + 7 = 15$  days. Should the contractor's entitlement be reduced due to his/her own initiative and additional expense? What if the A/E had provided the specification within the 15 days of this example, but the contractor chose to extensively shop for the least expensive vendor, taking 7 days to order the pump (and prep/delivery taking the normal 10 days)? The delay to the project would then be 10 days rather than the 8 calculated by the TIE. Keeping in mind that the contractor initially expected to need 5 days for shopping, and had an additional 7 days float, will this delay be charged totally to the owner (who is responsible for the A/E) or split with the contractor?

Similarly, the TIE notes that the contractor was ready for the pump on day 22. If the 15 day activity of drilling the well was interrupted by rain on one day, was it really necessary for the contractor to make up the lost day by working a Saturday when he/she knew the pump would be delayed until day 30? The TIE process does not look at these questions of who knew what when, but rather only at the day the impact is expected to or did occur.

A second delay, a 2-month delay to delivery of structural steel, further illustrates this issue, starting with the TIE form in Figure 35.15.3. The design change was also noted at the commencement of the project as a result of an RFI generated by the contractor's efforts to prepare a CPM. The vendor, in pricing the change, agreed that it would deliver the steel no later than day 118, but ran into its own production problems and was not able to provide delivery until day 123.

When the two problems are imposed on the overall network, the critical path goes through procurement of the structural steel, as shown in Figure 35.15.4. The owner, knowing he/she would be held responsible for the delay to the steel, had no reason to rush out the specifications on the pump. The contractor had no reason to rush the procurement process, other than to mitigate the disruption to operations. The well pump was delivered late to the project; however, there is no impact on the overall project because the late steel delivery takes precedence.

TIME IMPACT EVALUATION

PROJECT: JOHN DOE TIE #: 2  
 PREPARED BY: J.J. O'BRIEN DATE: 1/31/95

DESCRIPTION: *STRUCTURAL STEEL DELIVERED IN 123 WORK DAYS RATHER THAN SCHEDULED 80*

ACTIVITIES AFFECTED:  
*29-30 "ERECT STRUCTURAL STEEL"*

TYPE OF IMPACT:  
 INCREASED DURATION: 43 AMOUNT: \_\_\_\_\_  
DELAYED DATE/SUSPENSION OF WORK: *DELIVERED @ DAY 123*

FRAGNET:

EVALUATION/RESPONSIBILITY:

*STEEL DELIVERY HAD 8 DAYS FLOAT.  
 THEREFORE DELAY IS  $(123 - 88) = 35$*

*OWNER REQUIRED CHANGES. RESPONSIBILITY AS FOLLOWS:*

<i>DESIGN CHANGES</i>	<i>15 DAYS</i>
<i>FABRICATION CHANGES</i>	<i>15 "</i>
<i>OWNER</i>	<i>30</i>
<i>FABRICATOR</i>	<i>5</i>

Figure 35.15.3 TIE for 2-month delay in delivery of structural steel.

As may be seen from this example, the TIE methodology alone may provide some difficulty in sorting out responsibility for multiple delays and in making adjustments for acceleration by the injured party to mitigate the impact of such delays. However, the use of the TIE is definitive in determining the total potential impact of any delaying causative

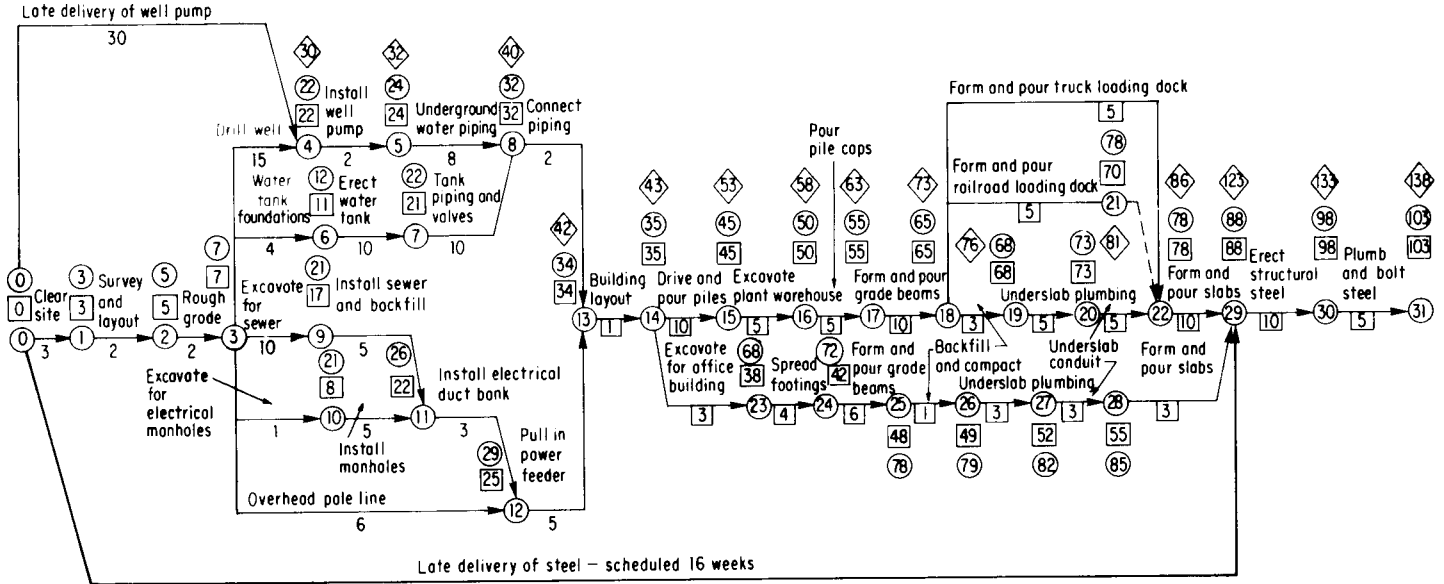

Late delivery of steel - scheduled 16 weeks

123

◇ Critical event times due to delays

— New critical path

Figure 35.15.4 Time scale network showing steel delay.

event and calculating the time extension to which the injured party is entitled. Thus, to determine the cumulative effect of all delays, all TIEs should be developed and impacted against the network simultaneously.

### 35.16. Windows Analysis

Just as the use of CPM allows project personnel to better understand a project by breaking large scopes of work down into small activities, the Windows analysis allows a better understanding of large and overlapping delays. The purpose of this analysis is to measure the actual impact of various causative factors upon the progress of the work, as opposed to measuring the theoretical impact to the as-planned logic network and “plan of execution” by which the contractor was entitled to not only a lack of impediment, but an express obligation of assistance under the general precepts of contract law.

The period of the windows run from the start of the project to the first significant causative factor, and then from that point to the next significant causative factor and on to project completion. It may be possible to run a window to each causative factor, however, the resultant analysis may become a day-by-day account of the project if each claimed RFI, CIC, SWO, or other claimed causative event are included in the analysis. Thus, just as a Scheduler needs to use some judgment in splitting, combining, and otherwise defining the scope of individual activities, so must some judgment be used in setting the timeframe of individual windows.

In applying this judgment, the Scheduler may look to the likelihood that a specific causative event will have an impact upon the schedule. This task is greatly simplified if the TIE analysis has been subjected to a zeroing out analysis with the commencement of the various root causative factors being the start and end of each window. Further latitude may be provided if a string of short duration windows all appear to be caused by factors chargeable to one party. A more detailed breakdown may be necessary if causative factors of differing or questioned responsibility overlap. In a complex delay claim situation, however, with dozens or hundreds of causative factors, it may be necessary to simply pick a standard timeframe, such as 1 week or 1 month. Although careful tailoring of the window periods will be more accurate, a question of diminishing returns for the effort required must also be considered.

At this point yet another copy must be made of the as-planned logic network. If the scheduling software permits, it may be useful to import to a custom code field the actual dates recorded in the as-built schedule. To this copy should be added only those causative factors that start within the first window. However, the durations of the causative factors will have to be reviewed since in this forward-looking analysis, only the anticipated duration, rather than the actual duration, should be used.

The activities of the window are then statused to the end of the window using the actual start and finish dates from the as-built schedule. A special problem exists for activities started but not finished during this update in determining the remaining duration as of the new data date.

If the window conveniently ends on or about the same date as one of the project updates, it may be possible to extract the remaining duration reported in that contemporaneously recorded document. However, often the two data dates will differ or misreporting during the progress update may make such information less than accurate. (For example, a contractor forgets to report progress on some activities and report completion of such in a following update.)

The solution that best alleviates this issue is to set the remaining duration as the lesser of the actual finish minus the data date or original duration. Although this computed remaining duration may not be precisely what the field personnel may have anticipated on the data date, it will be a close approximation. Obviously, if either contemporaneous documentation or common sense dictates that reasonable field personnel would anticipate a larger duration (up to or even greater than the actual duration experienced), that estimate of remaining duration should be used, although it should be footnoted appropriately.

An important technical point in entering causative factors is the duration that will be assigned to such. For purposes of the TIE performed “after the fact,” the entire and known duration of the causative event may be added. In many cases, rather than tediously calculating these durations, they may be entered by means of the expected finish constraint, allowing the computer to calculate the number of days from the known start to finish. If a causative factor, such as a stop work order pending resolution of a request for information, lingered from week to week for several months, this is the same as being told “replacement steel will be delivered in 12 weeks.”

However, when performing a windows-based analysis, the “what was known and when” issues come into play. In the first case, the duration should be 1 week since resolution is always expected by next week. In the second case, the duration should be the full 12 weeks. This may cause the causative factor of a 1-month window (to match an update cycle) to calculate an impact greater than the duration of the window.

At this point, the window file should be rescheduled with the new data date being the end of the window. The impact, if any, from the causative factors added and from the performance of work upon the baseline network logic, will be calculated. This incremental delay to project completion should be recorded. Working backward via driving relationships from project completion will determine if one (or more) of the causative factors added is the root cause for this incremental delay, or if it is attributed solely to poor production during this timeframe.

### 35.17. Zeroing Out within the Windows Analysis

If there are numerous causative factors in a specific window of an analysis and there is the possibility that differing parties may be responsible for overlapping delays, either smaller windows may be utilized for this timeframe or a zeroing out analysis, as described, may be used.

### 35.18. Windows Example of John Doe Project

To illustrate an example of the windows methodology, let us modify our previous example. Instead of the steel problem being determined around the time of the notice-to-proceed, it was not discovered until day 43 when the building layout was underway and the steel was already partially fabricated. Again, the fabricator agreed as part of the change order price adjustment to deliver the revised steel by day 118, but did not make actual delivery until day 123.

The two delays to the project are now distinct, as may be seen in Figure 35.18.1. The earlier delay of the well pump added the first 8 days to the project. This will be properly charged to the owner. Delivery of the pump marks the end of the first window. The second window begins when the steel issue is discovered on day 43. Since all work during this period went according to schedule, no additional time is added to the project or charged to either party.

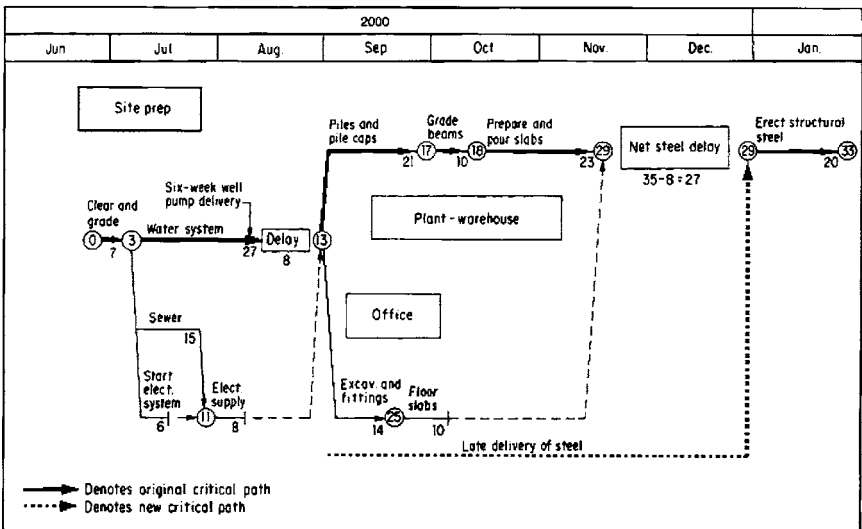

Figure 35.18.1 Overview of relative float created in site work because of late deliveries.

The third window begins with discovery of the steel issue and continues until the steel is delivered. The steel design issue adds only an additional 27 days and not the full 35 days calculated by the TIE since the first 8 days are now attributed solely to the well pump issue. Responsibility for this delay is further split to 22 days chargeable to the owner (and the A/E) and 5 days to the contractor (and the fabricator).

### **35.19. Summary**

The use of CPM in claims and legal cases increased dramatically in the last three decades as parties to construction contracts have come to increasingly rely on litigation to settle disputes. The as-planned network, preferably approved by the owner, the contracting officer, or the construction manager, is key in the claim evaluation process. The best approach to such evaluation is the time impact evaluation (TIE), which applies all the delay factors to the as-planned schedule to determine how they impacted it. If there was no as-planned network or it was inadequate, an as-should-have-been network can be substituted based upon what may be ascertained as the contractor's original "plan of execution."

A detailed, as-built network, compressed rather than impacted, can be used to evaluate a situation if a good as-planned network is not available, but this approach is highly subjective and subject to challenge. The as-built network can also be compared with the impacted, as-planned network, or the impacted, as-should-have-been network, to validate the evaluation of what impacts the delay factors had. Examples of the impact approach were given. The John Doe network updates are shown as the basis for a contractor's claim and an owner's defense.

The principal reference document for most of the case references in this chapter is the omnibus work "Construction Scheduling: Preparation, Liability, and Claims," second edition, authors Jon M. Wickwire, Thomas J. Driscoll, Stephen B. Hurlbut, and Scott B. Hillman, 1103 pages published in 2003 by Aspen Publishers and its 271 page supplement published in 2005.



## Disruption Analyses

We emphasized that the term “delay” has a special meaning to a Scheduler. Activities are not subject to “delay” but rather to “disruption.” If the disruption is to an activity that is on the current critical path of the project at the time the disruption occurs, then the project is subjected to a delay. However, project correspondence and conversation among field personnel do not normally make such a distinction; even a Scheduler may say “the concrete pour was delayed by inclement weather.”

The fact is that most of the “delays” on a project, even the ones most subject to dispute, do not delay the project. Some of the disruptions directly impact an activity that is currently upon the critical path. Some disruptions have an indirect impact, such as an emergency extra work order that diverts resources from an activity on the critical path. The vast majority of disruptions do not directly or indirectly cause delay. However, they do have a cost to the project.

We noted that the plan of the as-planned logic network must be that of person (or persons) directing the work to be performed. We noted that this plan may be one of many possible plans but it is the one chosen, based upon both the assumptions recorded and unreported by the Scheduler, to be the most efficient in terms of time and cost. The project manager may choose to work the project from the north to the south or vice versa. It may be presumed that the choice was not random and a disruption forcing a reversal will have some cost, even if only 15¢.

### 36.1. Traditional Methodologies

Traditional methodologies for measuring the cost impact of disruptions were much like those for measurement of delay prior to the advent of CPM. Often, a blunderbuss of alleged causative factors (deemed the

responsibility of the “other” side) leading to disruptions was fired against a chart indicating planned versus actual costs. The defense was often the firing of a similar blunderbuss filled with the alleged causative factors deemed the responsibility of the initial claimant. Substitute an as-plan versus as-built bar chart for the cost curves and we have a pre-CPM delay analysis.

A more refined methodology is to measure the difference between planned and actual productivity and costs during a period of calm (called the “measured mile”) and compare it to the same difference during a period of disruption. Obviously, the circumstantial evidence of this analysis is greater, but still lacks a firm cause and effect relationship.

### **36.2. CPM Out-of-Sequence Methodology**

Use of the as-planned logic network adds a great deal of objectivity and reproducibility to the disruption analysis. Obviously, project records of actual costs are never complete enough for the lawyers and forensic consultants, and even if they were, there is always the question of the accuracy of the initial estimates (cost and time) for the activities disrupted. However, like the value of CPM in breaking down large “ballpark” estimates of time into estimates of discrete activities—some high, some low—that cumulatively are more accurate, a similar value is imparted by the CPM relating to the estimated costs of discrete activities and the costs of disruption.

If masonry on the upper level of a two-story structure is stopped while the owner determines if he/she desires a larger or smaller window opening, it is clear that there will be some additional cost in remobilization and ramping up to speed after a restart; and if the scaffolding is left standing, there will be costs associated with the rental of the scaffold. If the scaffolding is removed to permit other trades to have access to the interior of the building (thus working out-of-sequence from the as-planned logic), there will be the additional costs of removal and re-erection. There may also be additional costs of less-than-complete access by the other trades working around stacks of block, which is, hopefully (but is not guaranteed), less than the double handling of the mason completely clearing the area. Although the quantifying of such costs may still be an estimate, the use of the measured mile approach at the activity or task level is less subject to variation and dispute than for entire areas or time periods of the project.

A project manager who is involved in the preparation of the original as-planned logic network will truly attempt to meet that schedule. One of the finest compliments given to a Scheduler is when, after all the work of preparing the CPM is completed, the project manager says “that is exactly the way I intend to build the project. What did I need you for?”

If a project manager encounters a disruption that can freeze the project in its tracks, he/she may attempt to work around it. However, the project manager is certainly hoping to minimize the distortion to the “most efficient plan” and intends to return to the plan as soon as practicable. Only on the worst of projects, where the project manager is constantly running into roadblocks to the plan and even to the workarounds put in place, may the plan be abandoned and resources assigned wherever there appears to be a task to perform without interruption.

Thus, it is possible to track the disruptions to the project by analysis of progress of work performed out-of-sequence from time period to time period. Building upon the Windows methodology discussed previously, the Scheduler should note the instances of new and continuing work performed out-of-sequence for each statusing or update. As noted in the Windows methodology, the DataDates for such updates may be a function of major causative factors or may be periodic if the number of causative factors makes such an exercise unwieldy.

Primavera’s P3 Project Planner software’s schedule diagnostic is an excellent tool for such an analysis. Each time an activity is started or finished out-of-sequence, it is reported. P3’s diagnostic distinguishes between eight types of work being performed out-of-sequence (Figure 36.2.1).

The diagnostic allows the Scheduler to distinguish between work performed out-of-sequence that may either indicate a crew getting a head start on the next activity or the start of a disruption (“Activity started, predecessor has not finished”) from that more clearly indicating a lingering obstruction (“Activity finished, predecessor has not finished”). Not included in the Primavera diagnostic but of potential use might be a code

1. “Activity started before its predecessor finished.” – used to note actual dates reported this period may indicate problem within this period
2. “Activity started, predecessor has not finished.” – used for FS and FF relationships, with or without lag
3. “Activity started before its predecessor’s lag would allow.” – used for FS and SS relationships with lag
4. “Activity started, predecessor has not started.” – used for SS relationships, with or without lag
5. “Activity finished, predecessor has not finished.” – used for FF relationships, with or without lag
6. “Activity finished before its predecessor’s lag would allow.” – used for FF relationships with lag
7. “Activity started too early to allow it to finish on or after its predecessor’s finish.” – used for FF relationships without lag
8. “Activity started too early to allow it to finish after the expiration of its predecessor’s lag.” – used for FF relationships with lag

**Figure 36.2.1** Types of work being performed out-of-sequence.

for “Activity finished, predecessor not started” to distinguish between disruptions that skip to the next activity when progress on a started activity is obstructed from those when an activity in a planned sequence is skipped over entirely. Similarly, the code “Activity finished, predecessor has not finished” is not issued by the P3 diagnostic for breaching a *FS* relationship, although it might be useful for this application.

At this point, the reason for each instance of out-of-sequence performance may now be noted. Reasons can range from “superintendent’s choice” or “equipment failure” to “change in condition discovered” or “stop work order issued” to “unresolved RFI” or “C.O. pending” to “too much mud, sent crew elsewhere.” Determining the party responsible for each cause would be next. If a log record (of the reason why a planned activity was not started or was started and was then stopped) was not kept, a detail review of the daily diaries of the project may be required to determine the cause of the disruption. This process is greatly aided if the previously prepared list of causative factors includes all and not only the most noteworthy incidents that have occurred.

Having determined a disruption and its impact to a specific activity or flow of activities, a cost can be assigned to the specific disruption. This may involve some level of subjectivity, but the level of disagreements should be small if each side renders an opinion in good faith for these small amounts. After all, remobilization of a drill rig for one piling initially skipped because of the discovery of an undocumented pipe is unlikely to cost either \$100,000 or zero. In fact, if there are but a few such disruptions, a contractor can expect to be laughed out of court as some reasonable level of disruption is expected in any endeavor. However, if the level of disruption tips that of reasonableness, the total of the impact of “1000 bee stings” begins to look like real money. Where the totals of the disruption analysis are similar to that of traditional methodologies, a very strong case can be made for compensation.

### **36.3. Summary**

The as-planned logic represents the project manager’s “plan of execution” and, presumably, the most expedient and cost effective means to perform the scope of work of the project. When the project manager is hindered from performing work according to this plan, then additional costs can be expected, even if the disruptions incurred do not impact the current critical path of the project. Review of selected updates to determine which activities were performed out-of-sequence and why can be used to prepare or defend a claim of disruption.

## Advanced Topics: Resource Leveling and Smoothing

Another extension of the basic CPM methodology is scheduling based upon resource availability rather than strictly on estimates of durations of individual activities and specified logic between activities. To determine the optimal time when each activity should be performed requires the assignment of resources to each activity and knowledge of the availability of such resources during each time period of the project.

### 37.1. Resource Leveling and Smoothing

#### Activity and resource types

Resource-based scheduling encompasses a large field of possible algorithms yielding a variety of results. In one scenario, durations are not estimated by the project manager or the scheduler, but the units of resources required (labor hours) and availability (craftsmen). This is the default system used by Microsoft Project. Obviously, this mimics the manual process of determining duration in many cases but is not acceptable in others.

One example of inaccuracy is the old scheduler's analogy that if one woman bears a child in 9 months, can 9 women collaborate to bear a child in 1 month? Other examples involving a possible division of a large task into smaller portions that can be performed concurrently recognize the need to add additional resources for the subtasks of splitting and recombining the various parts. A traditional scheduler's trick for utility work is to split a long utility line into two, making a final connection

at the middle. Recognized is that there is always an extra cost for the custom connecting piece and effort of installing.

A less intrusive consideration of resources is to use the project manager's determination of duration but to recognize that an additional logic restraint to the start of any activity is the availability of resources. Thus, an "improved" algorithm could determine availability before scheduling the activity. However, if two or more activities could start on a specific date, and only sufficient resources are available for one, which one will start and which will be deferred? Choice of "who goes first" is neither intuitive nor subject to mathematical solution.

### **37.2. Limitations of Algorithms**

Nondeterministic, Polynomial-Time-Complete, or NP Complete problems, mathematically have no known optimal solution. However, numerous "leveling" routines are available that can provide a workable, if not optimal, solution. The danger lies in allocating the scarce resource to the wrong activity, resulting in a longer duration than absolutely necessary for the project. While the misassignment of one resource unit among several activities may have a limited impact, misassignment of multiple resource units among several activities can result in resource leveling algorithms that stretch a project duration to double the optimal solution. Thus, a scheduler using such a leveling routine should always make several runs using differing rules for prioritization of activities to level.

A subspecies of resource leveling is resource smoothing, or setting limitations on deployment of resources. The objective is not to delay activities because of a limit in the number of resources, but rather to defer work (hopefully, on activities having sufficient float) so that fluctuations in resource use (hiring and firing of crafts) can be minimized.

Most project managers and schedulers would agree that a desirable resource use curve is a slow build-up of crafts, a steady number working during the majority of the project, and a tapering off at the end until only a punchlist crew remains. Correcting fluctuations creating peaks and troughs in resource usage can be accomplished manually by the scheduling team by use of various constraints and "crew logic" restraints or by smoothing software routines. Again, discretionary decisions as to which activities should be deferred for smoothing, should be carefully reviewed by the project manager. After all, it is he or she who is being paid to make these decisions.

### **37.3. Driving Resources**

A number of considerations must be evaluated in choosing a schedule where activity durations are driven by resource, logic is augmented by desired or maximum levels of resource availability, or logic

is augmented by the desire to smooth the fluctuation of resource usage. The first question is determining what resources are to be considered driving.

A driving resource is one that determines the duration of the activity. If two units of a driving resource can complete a task in six days, then three can complete in four days. The relationship may be linear, as in this example, or nonlinear as discussed below. Categories include craftsmen (total or by union craft), equipment, supervisory limitations, access, and any other physical restriction on performance.

Determining desired and maximum levels of availability must next be made. For example, on a project where both high steel rigging and work below the rigging could be performed concurrently except for safety considerations, a “safety access” resource could be assigned each activity. In this case, a total of one unit “available” can be used to permit a software leveling routine to determine which should “go first.”

The next question is how such resources might impact the performance of an activity. If an activity requires multiple limited resources, the most limited of such will usually determine the duration. However, if two or more resources are required for an activity, but only one is required at any one time, each portion of the activity being performed independently of the other, a different algorithm is required to determine the activity duration.

An example is the activity “Write Software,” where two individuals are responsible for different sections. The vacation schedules and other responsibilities of each individual would not impact the other from completing his or her portion of the work. Obviously, this type of “activity” should, in fact, be broken into two concurrent activities with a possible third “coordination” activity at the end. However, for reporting purposes, managers often prefer activities involving concurrent responsibility, and successful software vendors will accommodate such practices regardless of correctness.

### 37.4. Resource Calendars

The next question is specifying the limits of resource availability. A simplistic approach is to specify a set limit for the number of resource units available even though availability may vary over time. More student interns may be available in the summer than in the winter. Without the need for formal multi-project scheduling, the expected completion of one project might release resources for another.

Taking this to a higher level of detail, resources can have their own calendar of availability. Thus, an activity that may be required to be performed on weekdays, but require one resource be available only the first 10 days of the month and another resource never available on Fridays.

When multiple calendars are invoked, the question becomes how to reconcile or combine them. Microsoft Project combines various calendars excluding all nonwork periods for both the activity and the resource. Primavera's resource calendar overrides the activity calendar. Thus, an activity requiring the independent use of multiple resources could have one of the resources working on Saturdays, whereas the others may be limited to the standard five-day workweek. (A better solution from a theory viewpoint would be to split the activity into two or more concurrent tasks, each having its own activity calendar, converging to a "coordination" activity or milestone at the end.)

A problem with this approach is that the resource calendar, being derived from an activity calendar, is limited to use on activities with that activity calendar. Thus, a resource calendar for the resource previously theorized as being available only on the first 10 days of the month could not be applied to two activities; one on a 5-day workweek and the other on a 6-day workweek.

After determining resource availability, resource usage must be addressed. One area of divergence may be the assumption of linear, or constant, usage of a resource versus an expectation of ramp-up, production, and taper-off usage. Various software's treatment of resource usage curves could cause additional divergence in calculated results.

### **37.5. Practical Solutions**

Finally, great care must be exercised in setting the standards of prioritization. Given the choice of "which one goes first," a project manager will use a number of factors, including intuition, or other factors that he cannot express. One project manager client would use three competing factors, none of which is normally encoded in the network. For rigging process plant equipment onto a previously prepared pad, he would: (1) rig first the equipment that required the longest reach of the crane, (2) rig first the equipment that was the heaviest, and (3) rig first the equipment that had platforms or other equipment rigged above. If there was a conflict among these directives, he would use his intuition. However, he was directing the operation of only one or two crane crews at a time.

If a contractor must choose between 5 of 20 possible "which ones go first," or if the project includes hundreds of such decisions, the methodology must be determined early in the scheduling process so that the necessary coding fields can be included and information acquired and input. In the example just given, despite the use of three conflicting sets of rules, the scheduler rarely had to inquire of the project manager's "intuition."

Other technical rules may also be used to determine prioritization. It would seem obvious that activities having the least amount of total



float should go first. However, this can occasionally backfire. Primavera's default requires that the network first be scheduled using traditional means, then level on the next available activity with the earliest late start, then total float, then the activity number. Other activity attributes that can result in an earlier completion of a leveled project include prioritizing free float and independent float and those activities that use the scarcest resources.

However, as noted previously, no matter how carefully a project manager or scheduler chooses the order of priority, there is always the chance that a better solution could be found. (One example is a small, 10-activity network that takes longer when leveled with three crews than when leveled with two crews.) The practical solution would be to merge leveling routines with generalized evaluation review technique (GERT) software.

After running a large network with many activities competing for multiple resources of 500 or 1000 iterations, a software routine could choose a prioritization that results in the shortest project duration. However, you must realize that the 1001st iteration could have determined a better solution and that as actual progress is made on the project, the optimal solution changes.

### **37.6. Summary of Resource Leveling**

The impact of limited resources and limitations on the deployment of resources are inherent in every schedule a project manager prepares. As projects become larger, automation of the structuring of these impacts is often desired. Software solutions should be used with care, however, because they can yield unintended results. Also, theoretical limitations of such algorithms can result in project durations much larger than an optimal solution. The final caveat is to the reviewer of tabular or graphic output: Basic CPM calculations that have been modified by such algorithms might not necessarily be noted or apparent.

*This page intentionally left blank*

---

Chapter  
**38**

## **Advanced Topics: PERT, SPERT, and GERT**

As previously noted, the quality of a CPM network and schedule derived depend on the care taken in choosing appropriate restraints (or predecessors and successors) and in estimating the duration of individual tasks. Typically, the level of detail for individual activities is such that the project manager or scheduler is comfortable estimating a duration with some degree of accuracy. Sometimes, however, the scope of work to be performed for the individual task is fuzzy or outside factors do not permit a reasonable degree of comfort in specifying a set duration.

If the researchers were very lucky, they might locate the right alloy in an optimistic period of time. If they were unlucky, they might take a pessimistic period of time. Based on the law of averages and the experience of the research team, they could specify a most likely period of time required.

These three estimates, the Optimistic, Most-Likely, and Pessimistic durations, created the basis for statistically determining the range of durations that could be experienced. Unfortunately, in 1958, computers were not fast enough nor had sufficient memory to perform the true statistical analysis that represented the mathematical model for which these estimates were collected. Instead, a rough average was made using the formula

$$\frac{O + 4M + P}{6}$$

to reduce the information to a level similar to that used for CPM analysis and subsequent calculations. As computers became more powerful, various programs were developed, mostly in academia, for demonstrating the

power of full implementation of a *Statistical* or multiple *Simulation PERT* under various acronyms, such as *SPERT*.

### 38.1. PERT

For example, a research and development (R&D) project, the Navy's development of the Polaris missile, contained a parallel development to the critical path method of schedule analysis—the Navy's Performance Evaluation and Review Technique, or PERT. Unlike the CPM system in which the scope of individual activities could be reasonably quantified leading to an estimate in labor hours and finally in working days, the Polaris program had much wider guesstimates. Considering time constraints, the researchers could not test all possible alloys for a rocket nozzle, but must continue testing until a suitable (if not optimal) alloy and configuration could be found.

### 38.2. SPERT

Here, allowing the duration to vary among *Optimistic*, *Most-Likely*, and *Pessimistic* via a random number generator and running the resultant network for a requisite number of times (such as 100 iterations), the reviewer could be confident of the estimated duration of the project, notwithstanding the large variances estimated for the individual activities.

The original “fudge” of using the formula

$$\frac{O + 4M + P}{6}$$

led many practitioners to a serious misunderstanding of the mathematics behind PERT. One such example might be the use of statistical analyses used to quantify the risk inherent in a bid estimate for the purpose of quantifying the risk of meeting a schedule.

Suppose, similar to PERT, an optimistic, most likely, and pessimistic estimated cost is assigned to each element of a bid estimate. The average of these three estimates would be

$$\frac{O + M + P}{3}$$

while the mean would be

$$\frac{O + 4M + P}{6}$$

If the optimistic and pessimistic costs were truly the highest and lowest that might ever be experienced, the variance would be

$$\frac{P - O}{6}$$

while if such estimates were assumed to be at the 5 percent and 95 percent probabilities of best/worst cases, it is suggested the formula would be

$$\frac{P - O}{3.2}$$

(See J.J. Moder and E.G. Rodgers, "Judgement estimates of the moments of PERT type distributions, *Management Science*, Vol. 15, No. 2, October 1968.) The sum of all line item mean costs becomes the most likely total cost for the project. Calculating the square root of the sum of the variances for each line item on the bid estimate would then yield the standard deviation from that most likely cost.

Any text on statistics will include a table of the cumulative normal distribution function, which will provide a correlation of the number of standard deviations from the mean, known as the  $Z$  value, to the probability of such occurrence. For example, the  $Z$  value relating to a 90 percent chance that the actual cost of the project will be below a certain amount is 1.3, while the  $Z$  value for an 80 percent chance is only 0.8. The chances for the project to complete at or below the total estimated cost is 50 percent, correlating to a  $Z$  value of 0.0.

If one adds to the total most likely cost this  $Z$  value times the standard deviation for total cost, the result is the maximum cost of the project for the probability stated. Thus, if the total estimated cost is \$100,000 and the standard deviation is \$20,000, there is a 90 percent chance that the actual cost for the project will be less than:

$$\begin{aligned} \text{Cost}_{\text{Estimated}} + \sigma \text{Cost}_{\text{Estimated}} \times Z &= \text{Cost}_{\text{Actual}} = \$100000 + \$20000 \times 1.3 \\ &= \$126000 \end{aligned}$$

Likewise, the probability that the project will come in for under \$90,000 is determined by flipping the equation:

$$C_A - C_E / \sigma_{CE} = Z = (\$90000 - \$100000) / \$20000 = -0.5$$

which correlates to a 31 percent probability.

While this is all quite fascinating and possibly very useful to an estimating department, it works only because accounting and estimating line items can be totaled in a hierarchical manner. Unfortunately, this is not true in logic network theory. The existence of the merge bias, as

noted in Chapter 22, means that the probability of meeting any date will be lower than calculated in this fashion.

However, because the early practitioners of PERT and CPM/PERT allowed the “fudge” of using the formula, others tried to build on this false analogy. Many respected textbooks attempt to use this *Z* value method to determine the probability that a project will finish within 1 week, or 1 month, from the date calculated by the CPM algorithm. The first inkling that this method may not work in this situation is that the *Z* value for 50 percent probability is zero. Thus, the assumption is made that all projects have a 50 percent chance of finishing exactly on time, just as there is a 50 percent chance that a properly made estimate will be neither high nor low. The reality is much more bleak.

The use of a Monte Carlo type of analysis, requiring hundreds or thousands of iterations, will generate a much better estimate of the probability of completion by any specified date or, conversely, calculate the date by which there is a specified probability of completion. Thus, if the owner truly desires the project to be complete by a certain date, the specification could provide that a Monte Carlo analysis of the network will provide an 80 percent or even 90 percent probability of completion by the stipulated date (Figures 38.2.1 through 38.2.4). Or the engineer can use

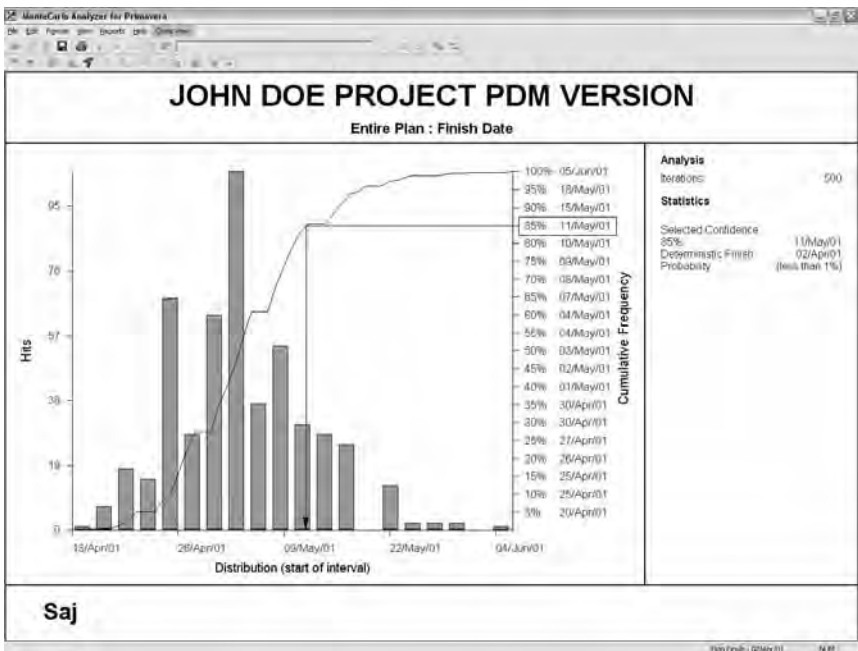

Figure 38.2.1 CPM calculates completion on 02APR01, MCA SPERT calculates 85% chance of completion by 11MAY01

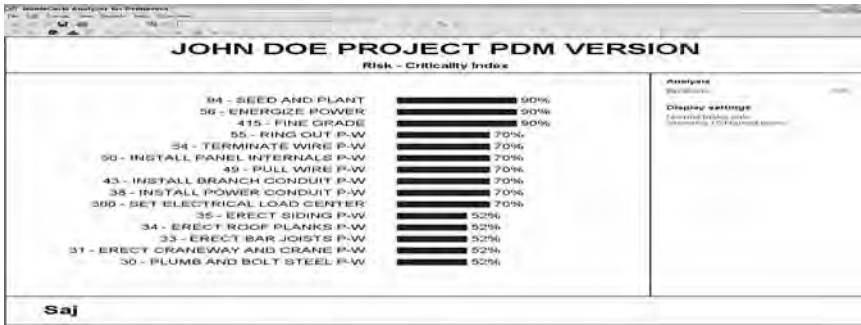

Figure 38.2.2 PERTmaster’s MCA software calculates the Activity #30 has only a 52% chance of being critical.

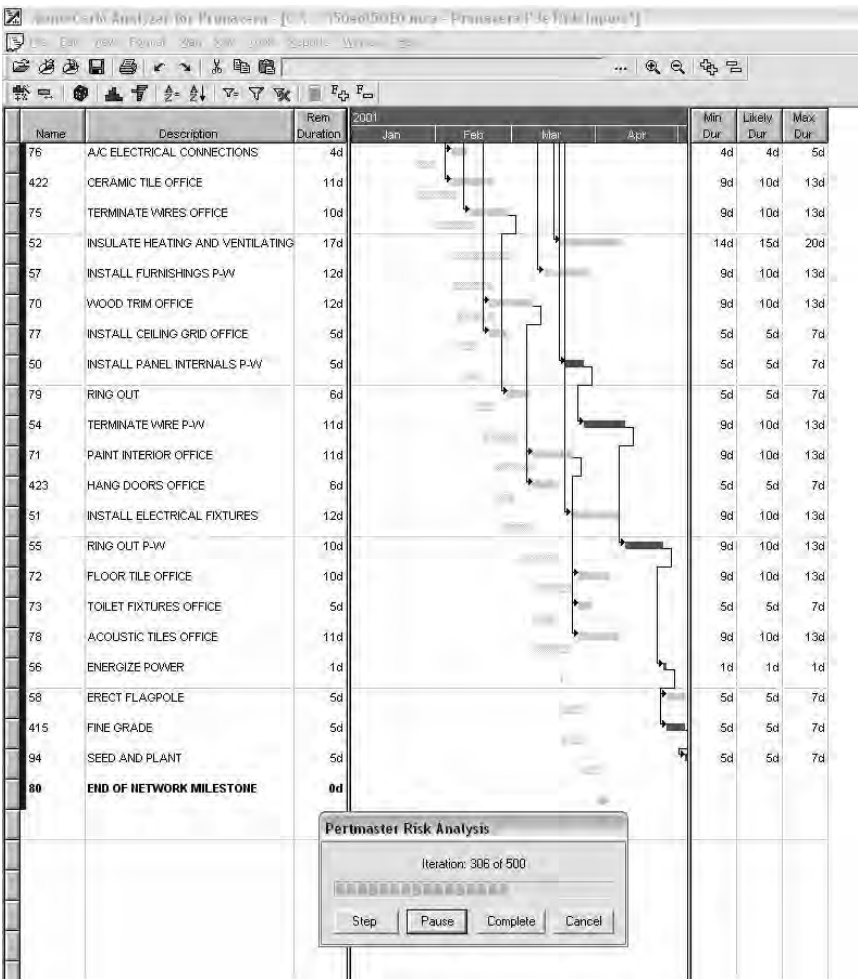

Figure 38.2.3 Comparison of CPM calculation (second bar) to that of SPERT (first bar) – default distribution.

### Pertmaster Report - Criticality Distribution Profile

Title	Path
JOHN DOE PROJECT PDM VERSION	C:\Documents and Settings\sajid\Desktop\50e0\50E0.mca
<b>Number of Tasks (Normal Only)</b>	154
<b>Number of Critical Tasks</b>	63
<b>Percentage of Tasks Critical</b>	41%

Criticality Range	Number of Tasks	Relative Percentage
Never	91	59%
1 to 10	10	6%
11 to 20	18	12%
21 to 30	3	2%
31 to 40	0	0%
41 to 50	3	2%
51 to 60	19	12%
61 to 70	7	5%
71 to 80	0	0%
81 to 90	3	2%
91 to 100	0	0%
<b>TOTAL</b>	<b>154</b>	<b>100%</b>

**Figure 38.2.4** Pertmaster calculates 91 of 154 activities of John Doe project will never become critical, 19 activities have a 51% to 60% chance of becoming critical, only 3 have a 81% to 90% of becoming critical, none are guaranteed to be critical.

the old rule of thumb, that for a project that needs to be finished in 12 months, the CPM should show completion in 11 months.

### 38.3. GERT

At the same time that SPERT studies were being performed on variations in estimating activity durations, other researchers were studying alternate forms of logic connection prohibited in the CPM model. For example, if an activity had two possible successors but only one could be performed at a time, there was no proper means to convey this in a CPM model. (One possible work-around to this is to assign the two activities a common “access” resource, limit such resource to one unit, and resource level.)

Another problem is that an activity, such as a submittal or a field test, is not always approved or passed. When such is rejected, additional work must be performed and then it must be resubmitted or retested. This type of loop is not permitted in CPM. However, it was recognized that this type of problem was a more generalized version of the special type of problem solved by the CPM or PERT algorithm. Thus, programs to handle the *generalized* version became known as *GERT* programs.



### 38.4. Computers Add Power

In the past decade, computers have increased in power, both in speed and memory, to an astonishing degree. Problems previously not attempted because they required too much time or memory can now be easily solved. Extensions of SPERT and GERT, implicit in the original mathematical concepts of CPM and PERT, can now be performed at little cost as add-on products to existing CPM software. It is predicted that within the next few years, CPM products will include such extensions as a matter of course.

One such product is Primavera's Monte Carlo software. This program includes the capability to provide ranges for estimated durations and decision points which randomly choose a subsequent path, some of which may even loop back to the decision point. This software can be used to validate traditionally prepared network or to expand a traditional network to include indeterminate duration activities (such as excavate extra rock, duration between 0 and 60 days) to major expansions that include GERT-style loops for resubmittals and retesting.

An example of the validation function is determining the fluctuation of completion dates of a project based on a reasonable variation of individual activity durations. Because each activity duration is, in fact, an estimate, they are subject to variation. Monte Carlo, as a default, assumes that each activity duration estimate can be as much as 15% overstated or 20% understated. Thus, a 10-day activity could be complete in as little as 8.5 days or take as long as 12 days. The user can override such defaults for the entire project or for individual activities.

Using a random number generator, the program sets the duration of each activity within the  $-15\%/+20\%$  window and computes the CPM analysis. The results are stored, the random numbers reassigned, and the CPM recalculated. After the user-set number of iterations (500 iterations are suggested), the results are tallied and displayed in both tabular and graphical format.

The default graphical format depicts the range of completion dates and their likelihood. Typically, the likelihood of completing by the completion date calculated by simple CPM analysis is less than 50%. More important is the degree of delay or overrun that might be encountered at the 95% confidence level. Restated, assuming that individual activity durations are overstated as much as 15% or understated as much as 20%, what is the latest date the project will finish 95% of the time? What is the likelihood that the project will be complete a month late? Or a month early?

The tabular format provides the ability to determine what factors are most likely to impact the project. Using traditional CPM analysis, we focus upon the critical path. However, if actual durations of activities are expected to vary from the estimates given in the CPM, what additional activities should we be concerned with?

The default tabular report indicates how the critical path can shift based on the stated variation or possible error in the estimated duration of individual activities. Often, it is determined that an activity not on the initial critical path becomes critical for a significant percent of the simulations.

This often occurs in a construction project CPM where activity durations are small but procurement and fabrication durations are large. The relatively large number of small duration activities tend to have their fluctuation cancel each other. The small number of large duration activities in a procurement chain (submit, approve, fabricate, and deliver) tend not to have their variations cancel. Thus, such procurement activities, although showing a comfortable amount of float in the CPM print-out, often become critical in actual experience.

Knowing which of these procurement activities have a higher likelihood of becoming problems alerts the project team to be extra vigilant in tracking such. An expanded critical activities list may be prepared to display all activities on the critical path, or likely to become critical.

### **38.5. Summary**

Just as the introduction of the first computers led to the introduction of CPM modeling and analysis, the more powerful computers of today will permit the more powerful schedule analysis tools of SPERT and GERT to augment the basic strength of CPM.

---

Chapter  
**39**

## Conclusion

The Gantt chart or barchart method of scheduling, involving a “graphical interface” or depiction of work, improved upon prior methods such as todo lists with specified deadlines. Undoubtedly it was considered complex by its first users. The barchart’s most onerous requirement was to demand the user to explain how he may meet the various interim deadlines of a todo list. Similarly, the Critical Path Method system of scheduling was derided for many years by project managers used to using barcharts. To many, CPM merely added a burden—the burden of explaining how the various bars on the barchart, or tasks on the todo list, interrelated with each other.

The stark simplicity of the ADM or traditional variant of CPM required this detail to be provided with exacting specificity. Sometimes the level of detail required would get in the way of practical usage, such as ease of updating. Sometimes the level of detail, though desired by upper management of the project team, would be more than desired in management level reports. Therefore, various means of summarization, hammocking, filtering and sorting were added to the simple CPM. With review by non-schedulers came the need for dates to be correct and not approximate (although the input is still based on early estimates) and so multiple calendars were added.

Many of the new tools also had a downside—they could be used to circumvent the rigor required by the ADM system in preparing a network. The lead/lag capabilities of PDM are chief amongst these new tools. They provide a great deal of additional power in modeling the real world. However they must be used with care if they are not to provide an unattainable fantasy world.

The full power and implications of CPM and PERT have always been constrained by the limits of the mathematics, software and hardware. Only

recently have these limitations been overcome and programs which can solve the full set of theorized problems been made commercially available. Undoubtedly these new tools will be considered complex by new users. Undoubtedly SPERT and GERT systems, such as Primavera's Monte Carlo and Pertmaster's Project Risk and MCA product will be derided for many years by project managers used to using basic CPM. Undoubtedly these new tools will be misused, intentionally in some cases, by some who do not care to expend the additional effort these tools require.

The tools of CPM, whether by ADM, PERT, PDM or RDCPM<sup>TM</sup>, and extensions of SPERT and GERT are powerful tools, but they are only tools. Like your power saw, if these tools are used without the proper knowledge and respect, they can cause more harm than good. A Master Carpenter knows how to use a hand saw, but also knows how to properly use a power saw to accomplish feats the average handyman could not envision. It is the purpose of this text to advance and promote the proper use of the tools of project controls into the 21st Century.

The closing words of the 5th Edition, copyright 1999, were that "in ten years, a CPM without GERT extensions and a SPERT style review will be considered as naive as a project managed by a todo list prepared on the back of an envelope by the project manager." Some readers of the text suggested the authors lived in an ivory tower and that the real world was not ready for statistical risk analysis and higher mathematics. Yet already in 2005, Primavera has teamed up with Pertmaster to provide a more powerful SPERT/GERT product than its own Monte Carlo software. OpenPlan incorporates a SPERT system as part of its basic CPM product. Even Microsoft Project incorporates the ability to enter the Optimistic, Most Likely and Pessimistic durations necessary for such an exercise. Perhaps we are not quite as far progressed as envisioned in 1999, but we are on our way.

# A

## Sample CPM Specification as a Guideline for Preparing your own Specification

### SECTION 01310 CPM SCHEDULES AND REPORTS

#### PART 1. GENERAL

##### 1.1. RELATED DOCUMENTS

1.1.1. Drawings and General Provisions of Contract, including General and Supplementary Conditions and other Division-1 Specification Sections, apply to this Section.

##### 1.2. SUMMARY

###### 1.2.1. General

1.2.1.1. This Section specifies administrative and procedural requirements for preparation and reporting of Contractor's preferred sequence of construction of the Work and other possible sequences of construction of the Work, for monitoring and reporting of actual performance of the Work, for incorporation of changes and unexpected events for determination of possible impact to the timely completion of the Work and for determination of means and method necessary for time completion of performance of the Work.

##### 1.3. PROJECT SCHEDULE

###### 1.3.1. Detailed Construction Schedule

1.3.1.1. The General Contractor shall develop and maintain the overall Detailed Construction Schedule, (referred to hereafter as Schedule or Construction

Schedule). The Schedule shall be computer generated in precedence format using the Critical Path Method (CPM). The Contractor shall perform its obligations generally in accordance with the sequence and time frame provided by the Schedule. The Contractor shall update the Schedule and shall modify and change the Schedule as may be required as provided by this Section. The Contractor shall not modify, change, or update the Construction Schedule or any activities therein without the prior written approval of the Program Manager.

### **1.3.2. Purpose of the Schedule**

**1.3.2.1.** Provide additional assurance by the Contractor of its adequate planning, scheduling, and reporting during the execution of the construction and related activities so they may be prosecuted in an orderly and expeditious manner, within the Contract time and the milestones stipulated herein.

**1.3.2.2.** Provide additional assurance by the Contractor of the coordination of the work of the Contractor and the various Subcontractors and suppliers at all tiers.

**1.3.2.3.** Assist the Program Manager in monitoring the progress of the work.

**1.3.2.4.** Assist the Program Manager in evaluation of the Contractor's monthly progress payments requests.

**1.3.2.5.** Assist the Program Manager in evaluating the potential impact of proposed changes to the Contract.

**1.3.2.6.** Assist and be utilized by the Contractor in the coordination of its forces, subcontractors, and vendors.

**1.3.2.7.** Assist in detecting problems for the purpose of taking timely corrective action and to provide a mechanism or tool for determining and monitoring such corrective actions.

### **1.3.3. General Requirements of Submitted Schedules**

**1.3.3.1.** The Work shall proceed at a rate as will meet the specified Milestone Dates, Substantial Completion (if applicable), and Final Completion dates within the Contract Time. By execution of the Contract, the Contractor represents that he has analyzed the Work, the materials, and methods involved, the systems of the building, availability of qualified mechanics and labor, restrictions of the site, constraints imposed, their own work load and capacity to perform the Work, and agrees that the specified times are reasonable considering the existing conditions prevailing in the locality of the Work, including weather conditions, and other factors, with reasonable allowance for variations from average or ideal conditions.

**1.3.3.2.** The Schedule shall clearly identify the activities illustrating accomplishment of the time(s) for completion of the Project set forth in the Contract. If the Schedule indicates earlier completion time(s) than that set forth in Contract, the float between the Schedule and the Contract dates shall be considered to be part of the total float available.

**1.3.3.3.** In developing the Schedule, the Contractor shall be responsible for assuring that Subcontractor work at all tiers, as well as Contractor's own work, is included in the Schedule.

**1.3.3.4.** The Schedule as developed shall show the sequence and interdependence of activities required for complete performance of the work. The Contractor shall be responsible for assuring all work sequences are logical and the Schedule shows a coordinated plan of the work.

**1.3.3.5.** Failure by the Contractor to include any element of work required for performance of the Contract or failure to properly sequence the work shall not excuse the Contractor from completing all work within the Contract Time.

#### **1.3.4. Use of Float and Reasonable Limitations Upon Resources**

**1.3.4.1.** Float time is not for the exclusive use or benefit of either the Contractor or the Owner. The Contractor shall limit its use of logic restraints based upon use of a resource such that it equally reserves float for the limited resources of the Program Manager, the Owner, other entities under the Owner's control, and other entities beyond the control of either the Contractor or Owner, and that the Contractor reserves float for the various types of unexpected events which may be anticipated on a construction project of this magnitude.

**1.3.4.2.** The Contractor acknowledges and agrees that actual delays to specific activities that do not exceed available total float time of such activities will not have any effect upon Contract completion times and Contractor will take all actions necessary to maintain the overall schedule.

#### **1.3.5. Requirement for Additional Resources**

**1.3.5.1.** The Contractor shall provide adequate resources, including but not limited to manpower and construction equipment, to perform its obligations in a timely manner. The Contractor shall be required to provide additional resources for additional work or events which may be anticipated on a construction project of this magnitude.

**1.3.5.2.** If the Contractor and Program Manager agree to a Change Order, such agreement shall be construed as stating that the Contractor is capable of supplying additional resources as may be required to effectuate such Change Order without the need to reduce the resources available for other work on the project, without disruption of other work on the project and without additional cost for provision of additional resources other than as may be included in the agreed Change Order.

#### **1.3.6. Entitlement to Extension of Time and Acceleration**

**1.3.6.1.** Entitlement to extensions of time for performance as described in the Contract Documents will be granted only to the extent that time adjustments for the activity or activities affected by any condition or event which entitles the Contractor to a time extension exceed the total float along the current critical path of activities affected.

**1.3.6.2.** If the Program Manager does not provide an extension of time at the request of the Contractor, the Contractor shall in a timely manner provide a

Recovery Schedule and itemized estimate of costs to effectuate such or shall be deemed to waive its claim for additional compensation therefore.

## **PART 2. PRODUCTS**

### **2.1. TECHNICAL REQUIREMENTS OF SUBMITTED SCHEDULES**

**2.1.1.** Contractor shall plan, schedule, execute, and report on the Work using the Critical Path Method (CPM). The principles used herein shall be as set forth in the text *CPM in Construction Management*, 6th edition, McGraw Hill, except that in case of conflict, the provisions of these Contract Documents shall govern.

**2.1.2.** The Contractor shall employ the services of at least one fully qualified scheduler for the duration of the Contract. Said scheduler(s) shall have a minimum of 3 years experience in CPM scheduling on projects of similar size and scope. Said scheduler(s) shall cooperate with the Program Manager and shall be on the project site full time for the purpose of continuously monitoring, modifying, or updating the Contractor's detailed construction schedule.

**2.1.3.** The Schedule shall be developed utilizing the Precedence Diagramming Method. Contractor shall use Primavera P3 scheduling software, Version 3.1 for Windows. Contractor shall use such software with scheduling options set for retained logic, calculate start-to-start lag from actual start, schedule durations as interruptible, show open ends as critical, and calculate the total float as the most critical.

### **2.2. RESTRICTIONS SUBJECT TO DISCRETION OF ENGINEER**

**2.2.4.** Milestone Dates, including Notice to Proceed, Substantial Completion, and Final Completion must be adhered to and shall be clearly identified on the Schedule. Milestone Dates may not be changed without the written consent of the Program Manager. Final Completion shall be a mandatory finish constrained date.

**2.2.5.** The Schedule shall be developed utilizing activities of specified duration of whole days between one (1) and fifteen (15) working days. Working days are defined as on a five day per week calendar, less recognized holidays as provided by the Program Manager. Milestones or other zero duration activities shall not be permitted except to indicate milestones set forth in this Specification. Submissions including use of Expected Finish constraints to calculate durations shall not be permitted.

**2.2.6.** Logic relationships between activities shall be limited to finish to start type relationships. The use of durations between activities, or lags, shall not be permitted.

**2.2.7.** Exceptions to the requirements above for the purpose of improving the Program Manager's ability to monitor the Schedule and permitting the use of durations larger than fifteen (15) working days, multiple calendars, milestones or other zero duration activity, calculated durations, logic relationships other than finish to start or durations between activities (lags) may be permitted on a case by case basis at the sole discretion of the Program Manager.



## 2.3. REQUIRED LEVEL OF DETAIL AND DURATIONS

**2.3.1.** The level of detail of the Schedule shall be a function of the complexity of the work involved. The level of detail and total number of activities shall be subject to approval by the Program Manager. No construction activity shall have duration of longer than fifteen (15) work days without prior acceptance of the Program Manager. Non-construction activities (such as procurement and fabrication) may have duration in excess of fifteen (15) work days.

**2.3.2.** Normal weather conditions shall be considered and included in the planning and scheduling of all work influenced by high or low ambient temperatures and/or precipitation to ensure completion of all work within the Contract Time. Normal weather conditions shall be determined by an assessment of average historical climatic conditions based upon the preceding ten (10) year records published for the locality by the National Ocean and Atmospheric Administration (NOAA).

**2.3.3.** Activity descriptions shall be clear and concise. The beginning and end of each activity shall be readily verifiable. All activity starts and finishes, with the exception of Milestones, must be tied into the schedule by logical restraints.

**2.3.4.** Proposed duration assigned to each activity shall be the Contractor's best estimate of time required to complete the activity considering the scope and resources planned for the activity.

**2.3.5.** Responsibility for each activity shall be identified with a single performing organization.

**2.3.6.** For all major equipment and materials fabricated or supplied for this project, the Schedule shall show a sequence of activities including:

**2.3.6.1.** Preparation of shop drawings and sample submissions.

**2.3.6.2.** Review of shop drawings and samples.

**2.3.6.3.** Shop fabrication and delivery.

**2.3.6.4.** Erection or installation.

**2.3.6.5.** Testing of equipment and materials.

## 2.4. REQUIRED MINIMUM CODING OF ACTIVITIES, RESOURCES AND COSTS

**2.4.1.** Each activity shall be identified with codes including as a minimum:

**2.4.1.1.** The party responsible for performance of the Work,

**2.4.1.2.** Where work is to be subcontracted, the subcontractor to be responsible for the Work,

**2.4.1.3.** The size, craft and composition of the labor crew performing the Work,

**2.4.1.4.** The total man-hours estimated for performing the Work,

**2.4.1.5.** The major equipment to be used for performance of the Work,

**2.4.1.6.** The number of hours in a work day for this activity including all shifts,

**2.4.1.7.** The contract drawing number or specification section where the Work is best portrayed,

**2.4.1.8.** Building, Floor and Location of the Work, and

**2.4.1.9.** The primary Schedule of Values and CSI classification associated with the Work.

**2.4.2.** Contractor shall assign resource loading, including but not limited to manpower and major construction equipment, for each activity of the Schedule.

**2.4.2.1.** Manpower and major construction equipment resources must be listed in the Resource Library of the Primavera software. The Contractor shall set the Normal level of resource usage as not less than that required to perform the project in a timely manner. The Contractor shall set the Maximum level of resource usage as not less than 150% of the Normal level of resource usage.

**2.4.2.2.** The cumulative assigned labor man-hours for each activity must equal the total man-hours assigned in the activity code tabulation.

**2.4.3.** Each activity shall be cost-loaded and the assigned dollar value (cost-loading) of each activity shall cumulatively equal the Total Contract Amount. Separate activities shall be included and cost loaded for costs associated with mobilization, demobilization, bond and insurance. The cost for demobilization shall be at least seventy-five percent (75%) of that for mobilization. Costs for General Conditions, overhead, and profit shall be prorated throughout all activities other than those for mobilization, demobilization, bond, and insurance.

**2.4.3.1.** The assigned dollar value (cost-loading) of each activity shall be coded against one or more cost category and cost account number. Cost account numbers shall be the same as line items in the Schedule of Values. Cost categories shall include Labor, Equipment, Materials and Subcontracted. The assigned dollar value (cost-loading) for each cost account for each activity shall cumulatively equal the Total Contract Amount assigned for each respective line item in the Schedule of Values.

**2.4.3.2.** The assigned dollar value (cost-loading) for the labor category shall cumulatively approximate the total labor man-hours times the average cost per man-hour plus a reasonable percent for overhead and profit.

**2.4.3.3.** The assigned dollar value (cost-loading) for the equipment shall cumulatively approximate the total reasonable rental value for such equipment plus a reasonable percent for overhead and profit.

**2.4.3.4.** The assigned dollar value (cost-loading) for the material category shall cumulatively approximate the total reasonable cost for materials plus a reasonable percent for overhead and profit.

**2.4.3.5.** The assigned dollar value (cost-loading) for the subcontracted category shall cumulatively approximate the total labor manhours for subcontracted work times the average cost per man-hour plus a reasonable percent for overhead and profit. If requested by the Program Manager, the Contractor shall furnish either the total subcontracted cost of selected subcontractor(s) or a breakdown by such subcontractor(s) of labor, equipment, and material cost.

## **2.5. REQUIRED NARRATIVE**

**2.5.1.** Contractor shall prepare and provide a written narrative to further explain the plan as set forth in its CPM logic network and schedule. The narrative shall include a general summary of the Contractor's proposed plan to execute the

works of the project. The narrative shall include an explanation of the format of activity descriptions including standard abbreviations used. The narrative shall include a general summary of the Contractor's plan for manning of the project including anticipated total manpower per month for direct hire and for subcontractor forces. The narrative shall include a list of the major items of construction equipment intended for use on this Contract's operations including types, number of units, unit capacities, and the proposed time each piece of equipment will be on the job, keyed to the activities on which the equipment will be used.

**2.5.2.** If requested by the Program Manager, the Contractor shall include in its written narrative the Contractor's determination of duration for critical, near-critical and other specified activities. Such explanation shall include the number of crews, crew composition, number of shifts per day, number of hours in a shift and the number of work days per week.

## **PART 3. EXECUTION**

### **3.1 CONTRACTOR'S REPRESENTATIVE DESIGNATION**

**3.1.1.** Within (3) working days after date of Notice to Proceed, Contractor shall designate its authorized project scheduler ("Scheduler").

**3.1.2.** Contractor's scheduler shall have complete authority to act on behalf of the Contractor in fulfilling the Construction Schedule requirements of the Contract and such authority shall not be interrupted throughout the duration of the Contract unless approved in writing by the Program Manager.

### **3.2 INITIAL SCHEDULE CONFERENCE**

**3.2.1.** The Program Manager will schedule and conduct an initial schedule conference within five (5) working days of Notice to Proceed shall be prepared to review and discuss the schedule and sequence of operations including cost, manpower, and equipment loading methodology. The conference shall be attended by:

**3.2.1.1.** Contractor's Project Manager, Superintendent, and Scheduler

**3.2.1.2.** Other Contractor key personnel, defined as any individual reporting to the Contractor's Project Manager or Superintendent, and being in responsible charge of more than 20% of field efforts as defined by cost.

**3.2.1.3.** The Project Manager, Superintendent or person in responsible charge of each Subcontractor expected to perform more than 10% of field efforts as defined by cost.

**3.2.1.4.** A representative in responsible charge of the fabrication and delivery of materials for this project for each major supplier including each supplier of more than 10% of the total contract value as defined by cost.

**3.2.1.5.** [intentionally blank or for known specialty subcontractor or supplier]

**3.2.1.6.** [intentionally blank or for third party (e.g. utility, owner's operations manager, etc.) but either 1) placing obtaining as contractor's obligation or 2) relieving Owner if such individual cannot or will not attend]

3.2.1.7. Program Manager or its representative(s).

3.2.2. Procedures will be reviewed by the Program Manager for the following:

3.2.2.1. Development of preliminary Schedule by Contractor.

3.2.2.2. Procedures for updating and revisions.

3.2.2.3. Cost and resource loading of activities. Format and use of schedule of values.

3.2.2.4. Method of generating earned value reports, establishing target schedules, and evaluating cost, resource, and schedule performance.

3.2.2.5. Data exchange and Communications.

3.2.2.6. Procedures for assessing schedule impacts, schedule delays, and time extensions.

3.2.2.7. Development of recovery schedules.

### 3.3. PRELIMINARY SCHEDULE

3.3.1. Within ten (10) days after Notice to Proceed, the Contractor shall submit for the Program Manager's review and acceptance a Preliminary Schedule.

3.3.2. The Preliminary Schedule shall cover the following project phases and activities:

3.3.2.1. Proposed Procurement Activities to be accomplished during the first ninety (90) days of the Contract. Procurement activities shall include mobilization, key shop drawing and sample submittals, reviews, and the fabrication and delivery of key and long-lead procurement elements. Indicate planned submittal dates and delivery dates for fabrication and delivery activities.

3.3.2.2. Proposed Construction Activities to be accomplished during the first ninety (90) days of the Contract

3.3.2.3. Summary Activities not included above which are necessary to properly indicate the approach to scheduling the remaining work areas or phases of the work. The work for each phase or area must be represented by at least one summary activity such that they cumulatively indicate the entire Construction Schedule. Summary Activities may exceed the duration limitations listed above and may be connected by Start-to-Start and Finish-to-Finish logic relationships as well as Finish-to-Start logic relationships and such logic relationships may include durations between activities (lag).

3.3.2.4. The Preliminary Schedule shall otherwise conform with the requirements outlined in the "Technical Requirements for Contractor-submitted Schedules" in this specification section.

3.3.2.5. Contractor shall assign an approximate cost to the Proposed Construction Activities and to Summary Activities. If requested by the Program Manager, the Contractor shall furnish a written narrative supporting such approximate costs.

3.3.3. The submission shall consist of:

3.3.3.1. A Primavera Backup Disk.

**3.3.3.2.** A pure logic diagram of the entire Preliminary Schedule, which may be either hand or machine drawn. If machine drawn, activities shall be separated by a minimum of one inch horizontally and one half inch vertically. The diagram shall be drawn or plotted on D or E size media.

**3.3.3.3.** Machine plotted time scaled logic diagrams of:

**3.3.3.3.1.** The entire Preliminary Schedule.

**3.3.3.3.2.** The first 90 days of the Preliminary Schedule.

**3.3.3.3.3.** Time scaled diagrams shall be plotted on D or E sized media.

**3.3.3.4.** Tabular listings of:

**3.3.3.4.1.** All Procurement Activities grouped by Submissions, Review and Fabrications, then sorted by Early Start, then Total Float.

**3.3.3.4.2.** All Construction Activities to be performed in the first ninety (90) days, sorted by Early Start, then Total Float.

**3.3.3.4.3.** All Summary Activities sorted by Early Start, then Total Float.

**3.3.3.4.4.** Tabulations shall include Activity ID, Description, Original Duration, Remaining Duration, Percent Complete, Cost Percent Complete, Activity Codes, Early Dates, Late Dates, Total Float, Predecessors, Successors, and Total Assigned Cost.

**3.3.3.5.** A hand drafted or machine plotted diagram of anticipated manpower, including subcontracted manpower versus time.

**3.3.3.6.** Five (5) copies of all diagrams and tabulations shall be required.

**3.3.4.** Within seven (7) working days after receipt by the Program Manager of the Preliminary Schedule or changes thereto, the Program Manager will notify the Contractor of any concerns the Program Manager may have in regard to the Preliminary Schedule.

**3.3.5.** The Contractor shall provide a response to the concerns of the Program Manager, to the satisfaction of the Program Manager, within five (5) working days for the first response and three (3) working days for subsequent responses as may be required.

**3.3.6.** If the Preliminary Schedule is not approved within thirty (30) working days after Notice to Proceed, the Program Manager may assess the Contractor for liquidated damages in the amount of \$#,### per day to reimburse the Owner for the additional risk of late completion and the increased monitoring and administration associated with attempts to control and mitigate such risk.

**3.3.7.** The Preliminary Schedule shall be updated on a monthly basis while the Baseline Schedule is being developed. The monthly updating of the Preliminary Schedule shall be consistent with the procedures and requirements described in the "Schedule Updating" section of this specification section.

### **3.4. BASELINE SCHEDULE**

**3.4.1.** Within thirty (30) working days following Notice to Proceed, Contractor shall submit to the Program Manager a detailed Baseline Schedule in precedence format for the Contractor's construction work scope.

**3.4.2.** The Baseline Schedule shall conform with the requirements outlined in the “Technical Requirements for Contractor-submitted Schedules” in this specification section.

**3.4.3.** The Baseline Schedule shall be prepared in accordance with the comments and concerns raised by the Program Manager relating to the Preliminary Schedule. If such concerns have not been fully addressed for the Preliminary Schedule prior to the deadline of section 3.4.1 above, the Contractor shall nevertheless submit its work in progress as of that date.

**3.4.4.** The submission shall consist of:

**3.4.4.1.** A Primavera Backup Disk.

**3.4.4.2.** A pure logic diagram of the entire Baseline Schedule, which may be either hand or machine drawn. If machine drawn, activities shall be separated by a minimum of one inch horizontally and one half inch vertically. Diagrams shall be drafted or plotted on D or E size media.

**3.4.4.3.** Machine plotted time scaled logic diagrams of:

**3.4.4.3.1.** The entire Baseline Schedule.

**3.4.4.3.2.** Activities on the critical path and those having ten (10) days or less float relative to the critical path.

**3.4.4.3.3.** Diagrams shall have the critical path highlighted and activities for which responsibility is other than the Contractor highlighted in a different color and pattern.

**3.4.4.3.4.** Diagrams shall be plotted on D or E size media.

**3.4.4.4.** Tabular listings of:

**3.4.4.4.1.** All Procurement Activities organized by Submissions, Review and Fabrications, then sorted by Early Start, then Total Float.

**3.4.4.4.2.** All Construction Activities sorted by Early Start, then Total Float.

**3.4.4.4.3.** Tabulations above shall include Activity ID, Description, Original Duration, Remaining Duration, Percent Complete, Cost Percent Complete, Activity Codes, Early Dates, Late Dates, Total Float, Predecessors, Successors, and Assigned Cost. The column for Assigned Cost shall be totaled.

**3.4.4.4.4.** All activities in activity identification number order, listing the activity identification number, activity title, successor identification number, successor title, logic relationship type, lag, activity calendar number and reason for the logic relationship. The reason for the logic relationship shall be given as “Physical,” “Resource,” or “Other.” If the reason given is “Resource” an additional column shall list what resource. If the reason given is “Other” such shall be supported by a separate narrative. This tabulation shall be provided in both print and on diskette in an Excel or compatible format.

**3.4.4.5.** A machine plotted diagram of manpower versus time for:

**3.4.4.5.1.** Total manpower on the project.

**3.4.4.5.2.** Manpower for each subcontractor performing ten percent (10%) or more of the total labor on the project.

**3.4.4.5.3.** Manpower for each craft directly employed by the Contractor.

**3.4.5.** The Baseline Schedule shall be reviewed in the following manner:

**3.4.5.1.** Within fifteen (15) working days after receipt by the Program Manager of the Baseline Schedule or seven (7) working days after receipt by the Program Manager of changes thereto, the Program Manager shall notify the Contractor of any concerns the Program Manager may have in regard to the Baseline Schedule.

**3.4.5.2.** The Contractor shall provide a response to the concerns of the Program Manager, to the satisfaction of the Program Manager, within five (5) working days for the first response and three (3) working days for subsequent responses as may be required.

**3.4.5.3.** If requested by the Program Manager after receipt of the Contractor's response, the Contractor shall meet within three (3) working days of such request for a joint review, correction, or adjustment of the Contractor's proposed Baseline Schedule. Within three (3) working days after such joint review between the Contractor and Program Manager, the Contractor shall revise the Baseline Schedule in accordance with agreements reached during the joint review and re-submit it to the Program Manager.

**3.4.5.4.** If the Baseline Schedule is not approved within sixty (60) working days after Notice to Proceed, the Program Manager may assess the Contractor for liquidated damages in the amount of \$#,### per day to reimburse the Owner for the additional risk of late completion and the increased monitoring and administration associated with attempts to control and mitigate such risk. This assessment of liquidated damages shall be in addition to that provided in section 3.3.6 if applicable.

**3.4.6.** Acceptance of Contractor's Baseline Schedule:

**3.4.6.1.** Upon the submittal by the Contractor and review and approval by the Program Manager of the Baseline Schedule, the Contractor shall submit a copy of the Approved Baseline Schedule ("ABS") signed on the face by the Contractor and by each Subcontractor performing greater than 10% by cost of scope of the project, indicating the Contractor's (and Subcontractor's) acceptance and approval of the Baseline Schedule.

**3.4.6.2.** The Primavera files for Accepted Baseline Schedule shall be saved as Project ID Number/Version "BASELINE" and not further modified. A copy of this file shall be renamed as Project ID Number/Version "UPDATE <date>" and used for subsequent updates and shall reference this file as its target. A copy of the "UPDATE" file shall be renamed as Project ID Number/Version "INTERIM <date>" and shall reference the most recent "UPDATE" file.

**3.4.6.3.** Acceptance by the Program Manager of the Contractor's accepted Baseline Schedule shall be a condition precedent to the making of any progress payments under the Contract after the first seventy-five (75) working days of the Contract at the discretion of the Program Manager. In such event, the Program Manager, in its sole discretion, may also choose to make partial progress payments requiring additional retainage or may choose to make partial progress payments based solely upon certified payrolls and vendor invoices.

**3.4.6.4.** Upon acceptance of the Baseline Schedule by the Program Manager, the cost-loaded values of the Baseline Schedule shall be used as a basis for

determining progress payments. Monthly progress payments shall be based upon information developed at the monthly Schedule Update.

**3.4.6.5.** Acceptance by the Program Manager of the Contractor's Construction Schedule does not relieve the Contractor of any of Contractor's responsibility whatsoever for the accuracy or feasibility of the Construction Schedule, or of the Contractor's ability to meet the Contract completion date or Milestone Dates, nor does such acceptance acknowledge or admit the reasonableness of the activities, logic, duration, manpower, cost, or equipment loading of the Contractor's Construction Schedule.

**3.4.6.6.** In the event the Contractor fails to define any element of work, activity, or logic and the Program Manager review does not detect this omission or error, such omission or error, when discovered by the Contractor or Program Manager, shall be corrected by the Contractor at the next monthly Schedule Update (discussed hereinafter) and shall not affect the Contract Time

### **3.5. USE OF SCHEDULE FOR PROJECT COORDINATION**

#### **3.5.1. Weekly Progress Meetings**

**3.5.1.1.** Once each week at the progress meeting, the progress achieved by the Contractor during previous work week will be assessed. The Contractor shall update the most recent "INTERIM" Schedule with the Actual Start date of activities started in the past week, the Remaining Duration of those activities in progress and the Actual Finish date of activities completed during the past week. The Contractor shall submit a progress schedule in Primavera's tabular/bar-chart format indicating the information used to perform this update for the previous week and the activities scheduled for the succeeding three (3) weeks. A bar chart directly derived from the most recent "INTERIM" Schedule shall be used to generate the four (4) week window. All activities shown in this short interval schedule will be identified by the same activity numbers and descriptions as shown in the Construction Schedule.

**3.5.1.2.** The Contractor shall mark on this computer generated bar-chart schedule the choice and timing of those activities it intends to actually perform during the upcoming three weeks. The Contractor may add further details to monitor this short interval Schedule.

**3.5.1.3.** A copy of this short interval schedule shall be submitted to the Program Manager.

#### **3.5.2. Minor Revisions to the Schedule for Unanticipated Events**

**3.5.2.1.** If the Contractor and Program Manager agree to a Change Order ("CO"), such agreement shall include an Impact Analysis and agreement on the acceptance for such impact (in part or whole by each party) and costs for mitigation thereof. In the event that such agreement is not part of the agreement for the price of the Change Order, the Contractor shall treat such Change Order as a directive for purposes of the schedule.

**3.5.2.2.** If the Contractor believes that a submitted Request For Information ("RFI"), claimed Change In Conditions ("CIC"), request to delay or defer work



pending a Proposed Change Order (“PCO”), directive to perform a Change Order (“CO”) or claimed Constructive Change Order (“CCO”) may impact its work, the Contractor shall perform an Impact Analysis upon a copy of the most recent “UPDATE” file and submit such to the Program Manager as soon as practicable after determination of such belief. The failure to so promptly notify the Program Manager shall be deemed a waiver of any compensation or extension of time due to such cause. Where the parties are in disagreement over the responsibility of the delaying event, the Contractor shall use a description for such which is responsibility neutral.

**3.5.2.3.** As part of its Impact Analysis, the Contractor shall suggest means of mitigation including but limited to use of greater resources, modification or deletion from the logic network of selected restraints and selective overtime. If the Contractor believes that its efforts to mitigate such impact will entitle it to additional compensation, the Contractor shall submit an estimate of the unmitigated and mitigated impact and cost consequences of each. The failure to provide such a submittal in a timely manner shall be deemed a waiver of any additional compensation.

### **3.5.3. Monthly Schedule Update Meetings**

**3.5.3.1.** On a monthly basis, the Contractor shall meet with the Program Manager for the purpose of updating the Schedule. The Contractor shall submit its assessment of the Actual Start date of activities started since the last update, Remaining Duration of those activities in progress, Actual Finish date of activities completed and Cost Percent Complete of activities in progress or complete. The Program Manager will either assent to the Contractor’s assessments or direct the Contractor to use other dates or Cost Percent Complete. The Program Manager may request the Contractor to provide additional assurance of a Remaining Duration of work in progress. If the Contractor does not agree to the direction of the Program Manager, it shall note such in the log field of the activity and in comments to the Minutes of the meeting.

**3.5.3.2.** The information shall be entered to a copy of the most recent “UPDATE” file which will then be saved and not further modified.

**3.5.3.3.** Monthly Update Reports submission shall consist of:

**3.5.3.3.1.** A Primavera Backup Disk.

**3.5.3.3.2.** [Intentionally blank.]

**3.5.3.3.3.** Machine plotted time scaled logic diagrams of:

**3.5.3.3.3.1.** The entire Baseline Schedule including indication of progress to date.

**3.5.3.3.3.2.** Activities not yet completed on the critical path and those having ten (10) days or less float relative to the critical path.

**3.5.3.3.3.3.** Diagrams shall have the critical path highlighted and activities for which responsibility is other than the Contractor highlighted in a different color and pattern.

**3.5.3.3.3.4.** Diagrams shall be plotted on D or E size media.

**3.5.3.3.4.** Tabular listings of:

**3.5.3.3.4.1.** All Procurement Activities organized by Submissions, Review, and Fabrications, then sorted by Early Start, then Total Float.

**3.5.3.3.4.2.** All Construction Activities sorted by Early Start, then Total Float.

**3.5.3.3.4.3.** Tabulations above shall include Activity ID, Description, Original Duration, Remaining Duration, Percent Complete, Cost Percent Complete, Activity Codes, Early Dates or Actual Dates, Late Dates (if applicable), Total Float, Predecessors, Successors, Assigned Cost, and Earned Cost. The columns for Assigned Cost and Earned Cost shall be totaled.

**3.5.3.3.5.** A machine plotted diagram of manpower versus time for work on the remainder of the project including:

**3.5.3.3.5.1.** Total manpower on the project.

**3.5.3.3.5.2.** Manpower for each subcontractor performing ten percent (10%) or more of the total labor on the project.

**3.5.3.3.5.3.** Manpower for each craft directly employed by the Contractor.

**3.5.3.4.** If there have been any Minor Revisions to the Schedule for Unanticipated Events during the past reporting period, such shall be incorporated into a copy of most recent "UPDATE" file and rescheduled. This file will be renamed as Project ID Number/Version "REVISED <date>". The file will then be saved as the new "UPDATE" file and not further modified.

**3.5.3.5.** Minor Revision Reports submission shall consist of:

**3.5.3.5.1.** All reports required for an Update.

**3.5.3.5.2.** Those portions of the pure logic diagram required for the Baseline Schedule submission which have been modified with the modifications highlighted.

**3.5.3.6.** After updating and (if required) revising the schedule, it shall be copied to the next "UPDATE" file and to a new "INTERIM" file.

### **3.6. MAJOR REVISIONS TO THE SCHEDULE**

**3.6.1.** In the event that, pursuant to a Change Order, a Revised Baseline Schedule is adopted for the work remaining on the project, such revised baseline Schedule shall be used as the target for further update to the project.

### **3.7. RECOVERY SCHEDULE**

**3.7.1.** In the event that the Contractor determines that it can no longer perform according to the schedule, the Contractor shall prepare and submit a Recovery Schedule.

**3.7.2.** In the event that the Most Recent Update indicates that the project is more than twenty (20) days behind schedule, or that a major subcontractor performing more than ten percent (10%) of the labor on the site leaves for any reason without completion of its work, or that a specialty subcontractor employing proprietary means and methods leaves the site for any reason without completion of its work, or the Contractor becomes aware of an anticipated delay of specially ordered materials or equipment calculated to delay the project more than twenty (20) days behind schedule or the Contractor anticipates for any reason that the

project is likely to be delayed more than twenty (20) days behind schedule, and upon notice of such to and subsequent request of the Program Manager, the Contractor shall prepare and submit a Recovery Schedule.

**3.7.3.** The Recovery Schedule submittal may include, without limitation:

**3.7.3.1.** Revisions to the Original Durations of Activities not yet started, which are to individually be supported with a narrative of the actual productivity to date or increased resources or hours per day to effectuate such.

**3.7.3.2.** Revisions to the Calendar, including indicating work on Saturdays, Sundays or holidays, subject to approval by the Program Manager.

**3.7.3.3.** Splitting of activities to indicate more precise coordination, which are to be individually supported with a narrative of how a portion of the previously indicated activity may now suffice for a successor activity.

**3.7.3.4.** Revisions to Logic Relationships, deleting restraints based upon limited resources, which are to individually be supported with a narrative indicating the ability and willingness to engage additional resources.

**3.7.4.** The Recovery Schedule shall be prepared to indicate, where practicable, recovery within one month or within ten percent (10%) of the remaining duration until the mandated deadlines threatened.

**3.7.5.** Recovery Schedule Reports submission shall consist of:

**3.7.5.1.** All reports required for an Update.

**3.7.5.2.** The pure logic diagram required for the Baseline Schedule submission, highlighted, where practicable, to indicate where the Recovery Schedule differs from the Baseline Schedule.

**3.7.6.** Where the Recovery Schedule has been ordered by the Program Manager, it shall be submitted within five (5) working days. The Contractor and all parties under its control called to the Initial Schedule Conference shall be prepared to attend, upon fortyeight (48) hours notice, a Recovery Schedule Meeting which may be called by the Program Manager within the next three (3) to seven (7) working days. The Program Manager may also request the Contractor's Surety to attend the Recovery Schedule Meeting.

**3.7.6.1.** If a Recovery Schedule Meeting is called, the parties attending shall provide additional assurances to, or revise the proposed Recovery Schedule to the satisfaction of the Program Manager.

**3.7.6.2.** Once approved by the Program Manager, the Recovery Schedule shall be treated as a Minor Revision to the Schedule or a Major Revision to the Schedule as may be directed by the program Manager.

**3.7.6.3.** Once approved by the Program Manager, failure by the Contractor to strictly follow the Recovery Schedule until back on schedule shall be deemed a Material Breach of the Contract

*This page intentionally left blank*

# B

## Unified Facilities Guide Specification

SECTION TABLE OF CONTENTS  
DIVISION 01—GENERAL REQUIREMENTS  
SECTION 01321N  
NETWORK ANALYSIS SCHEDULES (NAS)  
04/02

**PART 1. GENERAL**

**1.1. DESCRIPTION**

**1.2. SUBMITTALS**

**1.3. SCHEDULE ACCEPTANCE**

1.3.1. Schedule Acceptance Prior to Start of Work

1.3.2. Acceptance

**1.4. SOFTWARE**

1.4.1. Computer Hardware

1.4.2. Software Training

**1.5. QUALIFICATIONS**

**1.6. NETWORK SYSTEM FORMAT**

1.6.1. Diagrams

1.6.2. Quantity and Numbering of Activities

1.6.2.1. HVAC TAB Activities

1.6.2.2. Procurement Activities

1.6.2.3. Government Activities

1.6.2.4. Construction Activities

1.6.2.5. Anticipated Weather Delays

1.6.2.6. Activity Properties

1.6.3. Mathematical Analysis

1.6.4. Additional Requirements

1.6.5. Required Reports

1.7. SUBMISSION AND ACCEPTANCE

1.7.1. Preliminary Meeting

1.7.2. Schedule Development Session:

1.7.3. Preliminary Network Analysis Schedule

1.7.4. Network Analysis Schedule

1.7.5. Review and Evaluation

1.7.6. Accepted Network Analysis Schedule

1.7.7. Monthly Network Analysis Updates

1.7.8. Summary Network

1.7.9. As-Built Schedule

1.8. CONTRACT MODIFICATION

1.8.1. Time Impact Analysis:

1.8.2. No Reservation-Of-Rights

1.9. CHANGES TO THE NETWORK ANALYSIS SCHEDULE

1.10. FLOAT

1.10.1. Definitions of Float or Slack

1.10.2. Ownership of Float

1.10.3. Negative Float

1.11. TIME EXTENSIONS

1.12. MONTHLY COORDINATION MEETING

1.13. BIWEEKLY WORK SCHEDULE

1.14. WEEKLY COORDINATION MEETING

1.15. CORRESPONDENCE AND TEST REPORTS

PART 2. PRODUCTS

PART 3. EXECUTION

**SECTION 01321N**  
**NETWORK ANALYSIS SCHEDULES (NAS)**  
**04/02**

**Note:** This guide specification covers the preparation and use of a contractor prepared Network Analysis Schedules. This section will be used on most projects in lieu of Section 01320, "Construction Progress Documentation." Section 01320 shall be used only when a hand-drawn bar chart is required for management and oversight of a project. As prescribed in FAR 36.515, the Contracting Officer may insert the clause "Schedules for Construction Contracts" (FAR 52.236-15) in solicitations and contracts when a fixed-price construction contract is contemplated, the contract amount is expected to exceed the simplified acquisition threshold, and the period of actual work performance exceeds 60 days. This clause may be inserted in such contracts when work performance is expected to last less than 60 days and an unusual situation exists that warrants impositions of the requirements. This clause should not be used in the same contract with clauses covering other management approaches for ensuring that a contractor makes adequate progress.

Coordination is required with other Division 1 specifications when Network Analysis Schedules is not specified.

Comments and suggestion on this specification are welcome and should be directed to the technical proponent of the specification. A listing of the *technical proponents*, including their organization designation and telephone number, is on the Internet.

Recommended changes to a UFGS should be submitted as a *Criteria Change Request (CCR)*.

Use of electronic communication is encouraged.

Brackets are used in the text to indicate designer choices or locations where text must be supplied by the designer.

**Note:** This guide specification requires project costs to be loaded into the schedule and assigned to activities. When using this section, delete the requirement for “Schedule of Prices” in Section 01200 “Price and Payment Procedures.”

## PART 1. GENERAL

### 1.1. DESCRIPTION

Prepare a progress chart pursuant to the clause entitled “FAR 52.236-15, Schedules for Construction Contracts” of the Contract Clauses that shall consist of a network analysis system. The network analysis system shall consist of the network analysis schedule (diagram), mathematical analysis, and associated reports. The scheduling of construction shall be the responsibility of the Contractor. Submission of progress and revision data will be used to measure work progress, aid to evaluate time extensions, and provide basis of all progress payments. The Critical Path Method (CPM) of network calculation shall be used to generate the project schedule and will utilize the Precedence Diagram technique to satisfy both time and cost applications. All progress payment amounts will be derived from and tied to the cost-loaded schedule activities.

### 1.2. SUBMITTALS

**Note:** The “G” in submittal tags following each submittal item indicates Government acceptance and should be retained. Add “G” in submittal tags following any added submittals that are determined to require Government acceptance. Submittal items not designated with a “G” will be approved by the QC organization.

Submit the following in accordance with Section 01330, “Submittal Procedures.”

SD-01 Preconstruction Submittals

[Qualifications; G]

Standard Activity Coding Dictionary

[Schedule Development Session scheduler/planner; G]

[Preliminary Network Analysis Schedule; G]  
Network Analysis Schedule; G  
Accepted Network Analysis Schedule; G  
Summary Network  
As-Built Schedule  
SD-07 Certificates  
Monthly Network Analysis Updates; G  
SD-11 Closeout Submittals

### 1.3. SCHEDULE ACCEPTANCE

Review comments made by the Government on the Contractor's construction schedule will not relieve the Contractor from compliance with requirements of the Contract Documents. The Contractor is responsible for scheduling, sequencing, and prosecuting the Work to comply with the requirements of the Contract Documents. Government acceptance extends only to the activities of the contractor's schedule that the Government has been assigned responsibility for and agrees it is responsible. The Government will also review for contract imposed schedule constraints and conformance, and cost loading of the CPM activities. Comments offered on other parts of the schedule which the Contractor is assigned responsibility are offered as a courtesy and are not conditions of government acceptance; but are for the general conformance with established industry schedule concepts.

#### 1.3.1. Schedule Acceptance Prior to Start of Work

**Note:** Prior to including or editing this paragraph, contact the ROICC Field Office to determine if the contractor will be allowed to start work prior to acceptance of the project schedule.

The Accepted Network described in the paragraph entitled "Accepted Network Analysis Schedule" must be submitted and accepted by the government before the contractor will be allowed to start work.

#### 1.3.2. Acceptance

- a. When the Accepted Network Analysis Schedule is submitted and accepted by the Contracting Officer, it will be considered the "Baseline CPM Schedule." The Baseline CPM Schedule will then be used by the Contractor for planning, organizing, and directing the work; reporting progress; and requesting payment for work accomplished. The schedule will be updated monthly by the Contractor and submitted monthly with the progress pay request to reflect the current status of the work. [For payment requests made after the period covered by the Preliminary Schedule.] The submittal and acceptance of the Accepted Network Analysis Schedule and accurate updated schedules accompanying the pay requests are both conditions precedent to processing pay requests. Only bonds will be paid prior to acceptance of the Accepted Network Analysis Schedule.



- b. Submittal of the Network, and subsequent schedule updates, will be understood to be the Contractor's representation that the submitted schedule meets all of the requirements of the Contract Documents, accurately reflects the work accomplished, and that Work will be executed in the sequence indicated on the submitted schedule.

#### 1.4. SOFTWARE

**Note:** Check with the ROICC Field Office for local personal computer (PC) equipment capacity and edit as appropriate. The Contractor's software may require more computer capacity than the ROICC Field Office has available, in which case, subject to the written approval of the Contracting Officer, the contract may include the requirement for the contractor to provide hardware and software necessary to allow the government to monitor work progress and process payments. At the end of the contract term, this equipment software may be specified to remain the property of the contractor or become government property as determined to be most cost effective by the Contracting Officer. Should this equipment be specified to become government property, all property control regulations must be followed.

**Note:** Include the bracketed sentences requiring Primavera software for LANTDIV, PACDIV and SOUTHDIV projects. Consult with the EFD/EFA 05 and/or Field Office to determine which software will be used. As a general guide; for projects less than \$5 Mil use SureTrak and for projects \$5 Mil and greater use P3.

[The scheduling software that will be utilized by the government on this project is [SureTrak by Primavera Systems, Inc.] [Primavera Project Planner (P3) by Primavera Systems, Inc. If the contractor chooses to use an equally capable program, the contractor shall convert all data into Primavera Machine Readable Format (Lotus, D-Base, Excel, etc.) prior to submission of all schedule inputs, included but not limited to the initial schedule, monthly updates, and changes to the schedule. It is the responsibility of the Contractor to ensure all data elements and logic required by this specification are kept intact during the conversion to Primavera. If scheduling software other than Primavera is being used, provide]] [Provide] a licensed copy of the Contractor's scheduling software and data. The software will be the most current version available and will be compatible with all MS-Windows operating systems (e.g., Win NT, Win 95, etc.). The scheduling software package shall contain all user manuals normally provided by the software distributor. If the Contractor upgrades their software during the course of the contract, the upgrade shall also be provided to the Contracting Officer. The software will remain the property of the government.

##### 1.4.1. Computer Hardware

[The network analysis software shall be capable of running on a [Government owned] [Contractor provided] personal computer.] [Provide and maintain a [\_\_\_\_\_] personal computer (PC) capable of running the network analysis software specified herein.] All necessary software and hardware will be provided to

make the system a complete and useable package.] [Provide a [\_\_\_\_\_] [printer] [plotter] with necessary cables. The contractor PC will remain the property of the [Contractor] [Government].

#### 1.4.2. Software Training

**Note:** Select and edit this paragraph when training is needed. Coordinate with the ROICC Field Office.

[If software other than Primavera is used by the Contractor, provide] [Provide] schedule software training for [two] [\_\_\_\_\_] Government personnel. A firm accredited by the scheduling software manufacturer, as their authorized trainer shall conduct the training. The training shall last a minimum of 24 hours per individual. Provide course material the training firm normally distributes at their software classes. Provide all necessary materials and equipment to conduct the training. The Contractor shall provide training within 10 working days after notification to the Contractor, by the Contracting Officer. Unless agreed to by the Contracting Officer, the training site shall be at the Contracting Office.

#### 1.5. QUALIFICATIONS

**Note:** Before editing the following paragraph, coordinate with the ROICC Field Office.

The Contractor shall designate a [full time] [part time] Scheduler that will be responsible for the development, preparation, and maintenance of an accurate, computerized Network Analysis Schedule. [Part time is defined as the scheduler performing on-site coordination, attending project meetings, and updates for [\_\_\_\_\_] hours per work week.] The Scheduler shall have previously developed, created and maintained at least [2] [\_\_\_\_\_] previous computerized schedules of similar size and complexity of this contract. A resume outlining the qualifications of the scheduler shall be submitted for acceptance to the Contracting Officer. If at a later date, the Contracting Officer considers the Contractor's Scheduler to be incompetent or objectionable, the Contractor will propose a new Scheduler, meeting the qualification requirements. Payments will not be processed until an acceptable Scheduler is provided.

#### 1.6. NETWORK SYSTEM FORMAT

The system shall consist of time scaled logic diagrams accompanying mathematical analyses and specified reports.

##### 1.6.1. Diagrams

Show the order and interdependence of activities and the sequence in which the work is to be accomplished as planned. The basic concept of a network analysis diagram will be followed to show how the start of a given activity is dependent on the completion of preceding activities and how its completion restricts or restrains the start of following activities. Diagrams shall be [organized by [Work Phase] [Area Code] and] sorted by Early Start Date and will show a continuous flow from left to right with no logic (relationship lines) from right to left. With the

exception of the Project Start and Project Completion milestone activities, no activities will be open-ended, each activity will have predecessor and successor ties. The diagram shall clearly show the activities of the critical path. No onsite construction activity shall have duration in excess of 20 working days. Once an activity exists on the schedule it may not be deleted and must remain in the logic. No more than [20] [\_\_\_\_\_] percent of the activities may be critical or near critical. Critical will be defined as having zero days of Total Float. "Near critical" will be defined as having Total Float in the range of [1 to 14] [[\_\_\_\_\_] to [\_\_\_\_\_] days. Show the following information on the diagrams for each activity:

- a. Activity/Event Number
- b. Activity Description
- c. Original Duration in work days
- d. Actual Duration in Work Days
- e. Early Start Date
- f. Early Finish Date
- g. Total Float [or Slack]
- h. Responsibility Code

Provide network diagrams on ANSI E sheets. Updated diagrams shall show the date of the latest revision.

**1.6.2. Quantity and Numbering of Activities**

**Note:** A good knowledge of construction is required when determining the numbers of activities for a network analysis. Factors such as the nature of the work, geographical location, completion time, complexity ("the complexity of a project is related to the number of specification sections, the number of buildings, special phasing requirements and special quality control requirements"), cost of maintaining each activity throughout the life of the contract and level of use by field management personnel must be considered. As a general rule, use the following guidance:

Project Construction Cost	Number of Construction Activities Recommended
Up to \$1,000,000	150 ± activities
\$1,000,000 to \$2,000,000	150 to 200 activities
\$2,000,000 to \$5,000,000	200 to 1000 activities
\$5,000,000 to \$10,000,000	1000 to 2000 activities
Over \$10,000,000	2500 ± activities

\*Important

- When selecting the number of activities, please keep in mind the cost added to the contract. An activity needs to be maintained throughout the life of the contract and the use of too many activities will unnecessarily increase the total contract cost.

- The guidance provided above is meant as GUIDANCE. Use your best judgement for selecting number of activities. Some contracts may require less number of activities than recommended amounts. (Ex: A contract to stripe a 500-mile stretch of highway may have a project cost of \$6,000,000 but it should not require between 1000 to 2000 activities).

Numbering shall be assigned so that, in general, predecessor activity numbers are smaller numerically than the successor activity numbers. Skip numbering shall be used on the network to allow insertion of additional activities for contract modifications and logic changes. The minimum number of construction activities in the final network diagram shall be [\_\_\_\_]. Types of activities included in the schedule are specified below.

#### 1.6.2.1. HVAC TAB Activities

**Note:** This paragraph will be used only when HVAC Testing, Adjusting and Balancing work is specified in the contract specifications.

Requirements for the activities related to HVAC TAB work, Section entitled, “HVAC Testing/Adjusting/Balancing,” are specified in Section entitled, “Price and Payment Procedures.”

#### 1.6.2.2. Procurement Activities

Tasks related to the procurement of material or equipment shall be included as separate activities in the project schedule. Examples of procurement activities include, but are not limited to: Material/equipment submittal preparation, submittal and approval of material/equipment; delivery of O&M manuals; material/equipment fabrication and delivery, delivery of extra parts, extra stock, special tools, notification of Government Furnished Material/Equipment delivery requirement, etc. As a minimum, separate procurement activities will be provided for every specification section. If the Contractor intends on using Just-In-Time (JIT) delivery methods, the schedule will show each JIT delivery with relationship tie to the Construction Activity specifically for the JIT delivery. Material and equipment for which payment will be requested in advance of installation shall be cost-loaded with the procurement costs. All activities within a procurement process/cycle will have a unique identifier in the activity code to show their relationships and will extend to the related construction activities (i.e., Work Category).

If the Government’s action on any submittal is “Disapproved” or “Revise and Resubmit,” a new series of Procurement Activities will be inserted into the schedule. Predecessor for the new submittal preparation activity will be the original approval activity and the successor of the new approval activity will be the fabrication/deliver activity for the equipment or material.

#### 1.6.2.3. Government Activities

Government and other agency activities that could impact progress shall be clearly identified. Government activities include, but are not limited to; Government approved submittal reviews, Government conducted inspec-

tions/tests, utility outages, Notice(s) to Proceed and delivery of Government Furnished Material/Equipment. Show activities indicating Government furnished materials and equipment utilizing delivery dates indicated in “FAR 52.245-2, Government Property (Fixed-Price Contracts).” Government activities will be driven by calendars that reflect Saturdays, Sundays and all Federal Holidays as non-work days.

#### 1.6.2.4. Construction Activities

Construction activities shall include, but are not limited to: Tasks related to mobilization/demobilization; the installation of temporary or permanent work by tradesmen; testing and inspections of installed work by technicians, inspectors or engineers; start-up and testing of equipment; commissioning of building and related systems; scheduling of specified manufacture’s representatives; final clean-up; training to be provided; and administrative tasks necessary to start, proceed with, accomplish or finalize the contract. Contractor activities will be driven by calendars that reflect Saturdays, Sundays and all Federal Holidays as non-work days.

#### 1.6.2.5. Anticipated Weather Delays

Schedule activity duration(s) shall be formulated with allowance for normal adverse weather conditions. Any activity duration which could be impacted by normally anticipated adverse weather (precipitation, high or low temperature, wind, etc.), due to the time period which the Contractor has scheduled the work, shall include an adjustment to include the anticipated weather delay. The Contractor shall anticipate delay by comparing the contractually imposed environmental restrictions in the Contract Documents to the National Oceanic and Atmospheric Association’s (NOAA) historical monthly averages for the NOAA location [at (*Enter NOAA Station here*)] [closest to the project site]. The number of anticipated adverse weather delays allocated to an activity will be reflected in the activity’s calendar. A lost workday, due to weather conditions, is defined as a day in which the contractor’s workforce cannot work 50 percent or more of the day. The Contractor shall immediately notify the Contracting Officer when a lost day has occurred due to weather and will record on the Daily Reports, the occurrence of adverse weather and resultant impact to the normally scheduled work. If the number of actual adverse weather delay days exceeds the number of days anticipated, the Contracting Officer will convert any qualifying delays to calendar days, giving full consideration for equivalent fair weather work days and issue a modification in accordance with the contract clauses.

#### 1.6.2.6. Activity Properties

Schedule activities will have the following properties:

- a. *Standard Activity Coding Dictionary*: The Contractor shall submit a coding scheme for Schedule Activity Numbers that shall be used throughout the project. The coding scheme submitted shall list the values for each activity code category and translate those values into project specific designations. Code length shall not exceed [10] [\_\_\_\_\_] characters. Once accepted, the coding scheme will be used for the duration of the project.

- b. *Activity Description:* Each activity shall have a narrative description consisting of a Verb or work function (e.g.; form, pour, excavate), an Object (e.g.; slab, footing, underfloor plumbing), and Area (e.g., 3rd floor, northeast quadrant, basement).

**Note:** Include the following paragraph when the project includes the requirement for Phased Construction.

- c. *Work Phase:* If phasing is specified in the contract, all activities shall be identified in the project schedule by the phase of work in which the activity occurs. Activities shall not be contained in more than one Work Phase.]
- d. *Work Category:* All Activities shall be identified in the project schedule according to the work category which best describes the activity. Examples of work categories are procurement, government, and construction activities that are all related to a single Definable Feature of Work. Activities shall not be contained in more than one Work Category.
- e. *Area Code:* All activities shall be identified in the project schedule by the Area Code in which the activity occurs. Activities shall not be contained in more than one Area Code. Area is defined as a distinct separation in construction, such as a story of construction, separate structure, usage or function difference, utility distribution systems, etc.
- f. *Responsibility Code:* All activities in the project schedule shall be identified with the party responsible to perform the task. Responsibility includes, but is not limited to; the prime contractor, subcontracting firm, or Government agency performing a given task. Activities shall not belong to more than one responsible party. The responsible party for each activity shall be identified by a responsibility code. For example, a responsibility code value, "ELEC", may be identified as "Electrical Subcontractor."
- g. *CSI Code:* All activities in the project schedule shall be identified with its respective 5-digit Specification Section number. Activities shall not belong to more than one Section number. If an activity does not have an applicable CSI Code, [such as "Mobilize"], the code will be "00000."
- h. *Drawing Code:* All activities in the project schedule shall be identified with its respective project drawing code. The drawing code is the Sheet Number on the primary project drawing which indicates the work to be performed. Activities shall not belong to more than one Drawing Code. Examples of Drawing Codes are "C-10," "C.10" or "C10." The code system will allow organizing all activities by drawing code in alpha and numeric order. If an activity does not have an applicable Drawing code, (such as "Mobilize"), the code will be "00000."
- i. *Modification Code:* The Modification Code shall identify activities that are modified or added by contract modification. Activities shall not belong to more than one Modification Code. The Government will assign the modification number, which will be shown on the SF 30. Use a shortened version of the modification number for the code (e.g.; A00010 = 010).
- j. *Request for Equitable Adjustment (REA) or Claim Code:* Activities that are modified or added, as a result of a Contractor's REA or Claim shall be

identified by a code generated by the Contractor. Activities shall not belong to more than one REA or Claim Code.

- k. *The Three Phases of Control (Preparatory, Initial, and Follow-up)*: For each Definable Feature of Work identified in the Contractor's Quality Control Plan, include an activity for the Preparatory Phase. The Initial Phase and Follow-up Phase will be represented by the Construction Activities in the schedule.
- l. *Project Milestone Dates*: Dates shall be shown on the diagram for the start of the project, any contract required interim start and completion dates, contract completion date and other significant milestones.
- m. *Scheduled Project Duration*: The schedule duration shall extend from notice-to-proceed to the contract completion date.
- n. *Project Start Date Milestones*: The schedule shall start no earlier than the contract award date and the project duration (Day 1) will start on the Notice-to-Proceed (NTP) date. The Contractor shall include as the first activity in the schedule, an activity named "Contract Award" and another activity on the NTP date named "Start Project." Both activities will be zero duration, with constrained start dates equal to the contract award and NTP dates.
- o. *Constraint of Last Activity Milestone*: The Contractor shall include as the last activity in the project schedule, an activity named "End Project." The "End Project" activity shall be zero duration with a mandatory finish constraint equal to the contract completion date for the project. Calculation of project updates shall be such that if the finish of the last activity falls after the contract completion date, then the float calculation shall reflect negative float on the critical path.
- p. *Early Project Completion*: In the event the Contractor's project schedule shows completion of the project prior to the contract completion date, the Contractor shall include an activity named "Contractor Early Completion." The activity shall be a zero duration milestone with an unconstrained date representing the Contractor's Early Completion date.
- q. *Substantial Completion*: If the contractor elects to include an activity for Substantial Completion, then it is agreed that Substantial Completion will be the point in time that the Government considers the project is complete and ready for its intended use. The activity will be named "Substantial Completion." The activity shall be a zero duration milestone with an unconstrained date representing the Contractor's Substantial Completion date.

**Note:** Include the following three paragraphs when the project includes the requirement for Phased Construction.

- r. *Phase Start Milestone*: The Contractor shall include as the first activity for a project phase, an activity named "Start Phase X," where "X" identifies the phase of work. The "Start Phase X" activity shall be zero duration with an unconstrained start date equal to the date of the Phase NTP. This unconstrained start date is not a release from contractually required start

dates, but is left unconstrained to allow the schedule logic to calculate without hindrance.

- s. *End Phase Milestone:* The Contractor shall include as the last activity in a project phase, an activity named “End Phase X” where “X” identifies the phase of work. The “End Phase X” activity shall be zero duration with an unconstrained late finish date equal to the contract phase completion date. This unconstrained completion date is not a release from contractually required finish dates, but is left unconstrained to allow the schedule logic to calculate without hindrance.
- t. *Early Phase Completion:* If the contractor expects to finish prior to the contract phase completion date, the milestone will show an early finish date equal to the Contractor’s early finish date. The name of the activity will be “Early Phase Completion” and will be zero duration with an unconstrained date representing the contractor’s early phase completion date.]

**Note:** Include Summary Activities if Summary Networks will be requested or if repetitive groups of activities will be used in a project (e.g. similar housing units being built several times over). Also include if Summaries will assist in keeping Customer or Higher Management appraised of progress.

- u. *Summary (a.k.a., Banding or Hammock) Activities:* The Contractor shall include special activities that are a summary of a chain of activities. The start of the activity will be the start date of the first activity in the chain and the finish date will be the finish date of the last activity in the chain. Generalized work sequences, Categories of Work and all Phase of Work activity chains will be summarized.]
- v. *Activity/Event Constraints:* Date/time constraint(s), other than those required by the contract, will not be allowed unless accepted by the Contracting Officer.
- w. *Leads and Lags:* Leads or lags will not be used when the creation of an activity will perform the same function (e.g., concrete cure time). Lag durations contained in the project schedule shall not have a negative value. The use of any lead or lag will be explained in the Narrative Report.
- x. *Default Progress Data Disallowed:* Actual Start and Finish dates shall not be automatically updated by default mechanisms that may be included in the CPM scheduling software system. Actual Start and Actual Finish dates on the CPM schedule shall match the dates provided from Contractor Quality Control and Production Reports. These reports will be the sole basis for updating the schedule. Work activities will be updated by actual work progression rather than being cash flow driven. The updating of the percent complete and the remaining duration of any activity shall be independent functions; program features that calculate one of these parameters from the other shall be disabled. Out-of-Sequence progress (if applicable) shall be handled through Retained Logic, not the Default Option of Progress Override. Actual labor and equipment hours used on activities will be derived from the daily reports.

### 1.6.3. Mathematical Analysis



The network diagram mathematical analysis shall include a tabulation of each activity shown on the detailed network diagrams. Provide the following information as a minimum for each activity:

- a. Activity/Event number
- b. Activity/Event description
- c. Estimated duration of activities (by work days)
- d. Earliest start date (by calendar date)
- e. Earliest finish date (by calendar date)
- f. Actual start date (by calendar date)
- g. Actual finish date (by calendar date)
- h. Latest start date (by calendar date)
- i. Latest finish date (by calendar date)
- j. Total float or slack
- k. Material/Equipment costs will be assigned to their respective Procurement Activities (i.e., the delivery activity). Costs for installation of the material/equipment (labor, construction equipment, and temporary materials) will be assigned to their respective Construction Activities. The value of inspection/testing activities will not be less than [10] [\_\_\_\_\_] percent of the total costs for Procurement and Construction Activities. Evenly disperse overhead and profit to each activity over the duration of the project.
- l. Responsibility code (including prime contractor, subcontractors, suppliers, Government, or other party responsible for accomplishment of an activity.)
- m. Area Code
- n. Manpower required (crew size)
- o. Percentage of activity duration completed
- p. Contractor's earnings based on accepted work-in-place.

The program or means used in making the mathematical computation shall be capable of compiling the total value of completed and partially completed activities. The program shall also be capable of accepting revised completion dates as modified by approved time extensions and recompilation of tabulation dates/costs and float accordingly. The total of all cost loaded activities; including costs for material and equipment delivered for installation on the project, and manpower and construction equipment loaded construction activities, shall total to 100 percent of the value of the contract.

#### 1.6.4. Additional Requirements

**Note:** The information required by the following paragraphs are optional and typically not needed for routine work. Include on projects with critical completion dates. Manpower and equipment loading schedules are of primary

importance to the Contractor in deciding the most efficient use of personnel resources and optimizing equipment usage and is the basis of activity duration estimates. Since these decisions are the responsibility of the Contractor's management process, the information value to the Contracting Officer is in assuring that the planned manpower and equipment are being supplied throughout the course of the project.

In addition to the tabulation of activities, in the Paragraph entitled "Mathematical Analysis," include the following data:

- a. *On-site manpower loading schedule:* Each construction activity shall have an estimate of the number of workers per day by trade, man-hours per day by trade and total expected hours used by trade during the execution of the activity. If no workers are required for an activity, then the activity shall be identified as using zero workers per day.
- b. *Equipment loading schedule:* Each construction activity shall have an estimate of the equipment used per day, number of units per day and total expected hours for each piece of equipment used during the duration of the activity. Include a description of the major items of construction equipment planned for each construction activity on the project. The description shall include the year, make, model, and capacity. If no equipment is required for an activity, then the activity shall be identified as using zero equipment per day.

#### 1.6.5. Required Reports

**Note:** Consult with the ROICC Field Office to identify which of the following reports are preferred. Always include Earned Value Report and Log Report.

The following reports will be made available in the schedule submittals and in each updated schedule submission provided on disk by the Contractor:

- a. By the preceding event number from lowest to highest and then in the order of the following activity number (Activity Identification Report) showing the current status of all activities.
- b. By the amount of total float, from lowest to highest and then in order of [activity number] [early start date] (Total Float or Slack Report) showing all incomplete activities.
- c. By latest allowable start dates and then in order of activity numbers (Late Start Report).
- d. Earned Value Report listing all activities having a budget amount and cost. A compilation of total earnings on the project from the notice to proceed to the most recent monthly progress payment request and the difference between the previous request amount and the current payment request amount. Sort report first by resource and then by activity.

- e. By earliest allowable start dates and then in order of activity number (Early Start Report).
- f. By tasks scheduled to start and finish by the end of the next pay period (30-Day Look Ahead).
- g. With each updated schedule submission, provide a computer generated Log Report using a recognized schedule comparison software listing all changes made between the previous schedule and current updated schedule. Identify the name of the previous schedule and name of the current schedule being compared. This report will as a minimum show changes for: Added & Deleted Activities, Original Durations, Remaining Durations, Activity Percent Complete, Total Float (or Slack), Free Float, Calendars, Descriptions, Constraints (added, deleted or changed), Actual Starts/Finishes, Added/ Deleted Resources, Resource Quantities, Costs, Resource Percents, Added/Deleted Relations, Changed Relation Lags, Changed Driving Relations, and Changed Critical Status.
- h. By the activity number from lowest to highest, showing preceding and succeeding activity numbers for each activity (Predecessor/Successor Report), and showing the current status of each activity.

**Note:** Include the following two paragraphs if the requirements of the paragraph entitled “Additional Requirements” are specified.

- i. *Manpower staffing report and histogram:* With each update schedule, a planned early and planned late versus actual labor resource histogram will be provided. This histogram shall be based upon and shall be in agreement with, the number of shifts and crew sizes by craft, in the Accepted Network Analysis Schedule (planned) and the Monthly Network Update (actual). Included in the report will be a tabular report that will list each trade to the activities that were worked on during the construction period.
- j. *Equipment usage report and histogram:* With each update schedule, a planned early and planned late versus actual equipment resource histogram will be provided. This histogram shall be based upon and shall be in agreement with the equipment allocation accepted on the Accepted Network Analysis Schedule (planned) and the Monthly Network Update (actual). Included in the report will be a tabular report that will list equipment (by make and model) to the activities that were worked on during the construction period.]

## 1.7. SUBMISSION AND ACCEPTANCE

### 1.7.1. Preliminary Meeting

At the Pre-Construction Conference, the Contracting Officer, Contractor and major subcontractors shall participate in a preliminary meeting to discuss the proposed schedule and requirements of this section prior to submission of the network. The definition of a “major subcontractor” is one that exceeds [5] [\_\_\_\_\_] percent of the contract value.

### 1.7.2. Schedule Development Session:

**Note:** Contact the ROICC Field Office before including this paragraph in the specifications. If included, editing of the paragraph will be coordinated with the Representative. This paragraph will typically be used only on large, complex or schedule sensitive projects.

Upon completion of the 90 day (Preliminary) Network Analysis Schedule, and] Prior to the submission of the Network Analysis Schedule, the Contractor shall conduct a Schedule Development Session. The Schedule Development Session shall include procurement of on site services of an expert scheduler/planner for not less than a [5] [\_\_\_\_] day period. The Contractor's choice of Schedule Development Session scheduler/planner is subject to the acceptance of the Contracting Officer. The scheduler/planner shall facilitate the session on site [and shall be fluent in the English language]. The scheduler/planner shall have at least [10] [\_\_\_\_] years experience developing construction project schedules with scheduling software programs that the contractor intends to use. Unless agreed to by the Contracting Officer, the session shall be conducted at the Office of the Contracting Officer. The Contractor is responsible for providing the necessary equipment for the session which, as a minimum, includes a personal computer (PC), a computer display projector to facilitate group viewing, and a printing device. During the session the facilitator [shall provide all necessary training to participants and] shall lead the development of the project's schedule. As a minimum, the scheduler/planner shall facilitate development of activity coding and work breakdown structures; establishment of procurement, government, and construction activities; activity relationship; resourcing; budgeted costs; and reports to be used during the project. Members of the Contracting Officer's staff will attend the session as well as [members of the designer of record,] [customer who will occupy the facility,] [major subcontractors (those which exceed [5] [\_\_\_\_] percent of the contract value), and] the Contractor's home and field project management staff. [Past experience has revealed that these services do not exist in [Indicate project location] which has resulted in the Contractor forming agreements with Scheduling Firms [in the United States] to meet the terms of the specification requirement.] All costs associated with the Schedule Development Session are to be borne by the Construction Contractor.]

### 1.7.3. Preliminary Network Analysis Schedule

**Note:** This paragraph should only be used on complex contracts. Do not use this paragraph on contracts that require an Accepted Network Analysis Schedule to be submitted and accepted by the Government prior to beginning work.

Submit a preliminary network defining the planned operations during the first [90] [\_\_\_\_] calendar days after contract award within [20] [\_\_\_\_] days after contract award. The general approach for the balance of the project shall be indicated. Cost of activities expected to be completed or partially completed before submission and acceptance of the Accepted Network Analysis Schedule should be included. Submit three copies of both the preliminary network diagrams and required reports listed in paragraph entitled "Required Reports." In accordance

with paragraph entitled “Monthly Reports,” the preliminary network may be used for requesting progress payments for a period not to exceed 90 calendar days after receipt of “Contract Award.” Submittal and acceptance of the Preliminary Network is condition precedent to the processing of the Contractor’s pay requests on this schedule. Payment requests after the first [90] [\_\_\_\_] calendar day period shall be based upon the Accepted Network Analysis Schedule. The activities and relationships of the preliminary schedule shall coincide and mesh with the activities of the Network Analysis Schedule. As part of this submittal, provide the Project Name format (and Project Group Name if used) that will be used by the Contractor to identify initial schedule submittals, updates, fragnets, changes, etc. Include [1] [\_\_\_\_] copy of the Preliminary Network Analysis Schedule on 3.5” disk(s).

#### 1.7.4. Network Analysis Schedule

**Note:** In the first sentence, remove the language in the brackets if the schedule is to be submitted prior to allowing the contractor to commence work. If a Preliminary Schedule is required remove the language for Project Name format.

Submit the complete network system, consisting of the network mathematical analysis and network diagrams [, within 40 [\_\_\_\_] calendar days after contract award]. Submit [three] [\_\_\_\_] copies of the diagrams described in the paragraph entitled “Diagrams,” the required reports listed in the paragraph entitled “Required Reports,” [and] the analysis described in the paragraph entitled “Mathematical Analysis” [and information required by the paragraph entitled “Additional Requirements”]. [As part of this submittal, provide the Project Name format (and Project Group Name if used) that will be used by the Contractor to identify initial schedule submittals, updates, fragnets, changes, etc.] Include [1 copy] [\_\_\_\_ copies] of the Network Analysis Schedule on 3.5” disk(s) formatted to hold 1.44 MB of data.

#### 1.7.5. Review and Evaluation

After the Government’s review, the Contractor shall meet with the Contracting Officer to discuss the review and evaluation of the NAS submittal. Revisions necessary as a result of this review shall be resubmitted for acceptance within 10 calendar days after the meeting.

#### 1.7.6. Accepted Network Analysis Schedule

Once review comments are resolved and the network has been accepted by the Contracting Officer, the Contractor shall within 5 calendar days furnish:

- a. [Two] [\_\_\_\_] copies of the network diagrams
- b. [Two] [\_\_\_\_] copies of the required reports listed in paragraph entitled “Required Reports”
- c. [Two] [\_\_\_\_] copies of the “Mathematical Analysis.”
- d. [Two] [\_\_\_\_] copies of the Cash Flow Report indicating the cash flow based upon both the early and late start schedules.

- e. [Two] [ ] copies of each major subcontractor's statement certifying their concurrence with the Contractor's Accepted Network Analysis Schedule. Each certifying statement will be made on the subcontractor's letterhead.
- f. [Two] [ ] sets of data disks containing the project schedule shall be provided for the initial submission and every periodic project update. Data shall be submitted on 3.5: disk(s), formatted to hold 1.44 MB of data. A permanent exterior label shall be affixed to each disk submitted. The label shall indicate the type of schedule (Preliminary, NAS Submittal, Accepted, Update, Recovery, or Change), full contract number, Project Name used to identify project in scheduling software, contract name & location, data status date, diskette number with total number of diskettes in set, software name and version used to run the schedule, and the name and telephone number of person responsible for the schedule.

For major revisions, updates or changes to the network diagrams, once accepted by the Contracting Officer, the Contractor shall submit these same diagrams and reports.

#### **1.7.7. Monthly Network Analysis Updates**

At monthly intervals the Contractor, Government representatives and major subcontractors will meet to jointly update the project schedule and agree on percentage of payment for each activity progressed during the update period. The purpose of the meeting is to determine progress payment amounts for each activity, allow all parties to evaluate project status at the data date, provide a complete and accurate update of procurement and construction progress, create an historical record of the project and establish prediction of completion date(s) based upon current status. The Contractor is responsible to gather all supporting documentation, propose the update data for the schedule and record the meeting minutes. All progress payment amounts will be derived from and tied to the cost-loaded schedule activities. Submit at monthly intervals a report of the actual construction progress by updating the required reports, the time scaled logic diagram, and mathematical analysis. Meeting to update the schedule and the submission of an error free, acceptable updated schedule to the Government is a condition precedent to the processing of the Contractor's pay request. As a minimum, the following actions will be accomplished during the meeting:

- a. Identify activities started and completed during the previous period and enter the Actual Start and Actual Finish dates.
- b. Show estimated duration (in workdays) to complete each activity started but not completed (remaining duration).
- c. Indicate percentage of cost payable for each activity.
- d. Reflect changes in the network diagram. All changes (i.e., duration changes, logic changes, new logic, conformed change orders, new activities, changes due to Conformed Modifications, changes in work sequence, etc.) shall be recorded and a note added to the activity log field. The log shall include as a minimum, the date and reason for the change, and description of the change.

- e. Submit [two] [\_\_\_\_\_] copies of a Narrative Report describing: 1) Progress made in each area of the project; 2) Changes in the following; activities, original durations, logic interdependencies, milestones, planned sequence of operations, critical path, and resource and loading; 3) Pending items and status thereof, including permits, change orders, and time extensions; 4) Status of Contract Completion Date and interim milestones; 5) Current and anticipated delays (describe cause of the delay and corrective action(s)); and 6) Description of current and future schedule problem areas. Each entry in the narrative report will cite the respective Activity ID and Activity Description.
- f. Submit [two] [\_\_\_\_\_] copies of the required reports listed in paragraph entitled "Required Reports."
- g. Submit [two] [\_\_\_\_\_] copies of the Update Meeting minutes.

### 1.7.8. Summary Network

**Note:** Before specifying Summary Networks, verify with the ROICC Field Office that the Summary will be useful on the project being designed. Choose type of summary to be provided.

A summary network shall have the same network form as the Accepted Network Analysis Schedule. The summary network will contain a minimal number of activities that represent the general approach of work sequence. The Summary will be a time-scaled logical sequence of [Work Phases] [Work Category] [Area Code]. The Contractor shall submit a summary network diagram immediately after acceptance of the Accepted Network Analysis Schedule. A summary network update shall be submitted every [6] [\_\_\_\_\_] months during the contract duration and immediately following acceptance of each major schedule change. Submit the following:

- a. [Two] [\_\_\_\_\_] copies of the summary network diagram.
- b. [Two] [\_\_\_\_\_] copies of the Activity Identification Report.
- c. [Two] [\_\_\_\_\_] copies of the Total Float (or slack) Report.
- d. [Two] [\_\_\_\_\_] copies of the Earned Value Report indicating the actual cash flow for the current updated (not summary) network based upon both the early and late start schedules.

### 1.7.9. As-Built Schedule

**Note:** Before specifying As-Built Schedules, verify with the ROICC Field Office that the schedule will be required.

As a condition precedent to the release of retention, the last update of the schedule submitted shall be identified by the Contractor as the "As-Built Schedule." The As Built shall reflect the exact manner in which the project was actually constructed (including actual start and finish dates, activities, sequences, and logic) and shall be certified by the Contractor's Project Manager and Construction Scheduler as being a true reflection of the way the project was actu-

ally constructed. If more than one person filled the position(s) during the course of the project, each person will provide certification for the period of time they were responsible.

### **1.8. CONTRACT MODIFICATION**

When a contract modification to the work is required, submit proposed revisions to the network with a fragnet and a cost proposal for each proposed change. All modifications shall be incorporated into the network analysis system as separately identifiable activities broken down and inserted appropriately on the first update following issuance of a directive to proceed with the change. Submit [one copy] [\_\_\_\_ copies] of the Total Float Report, Log Report and a copy of the proposed Time Impact Analysis on disk, with the cost proposal. Unless the Contracting Officer requests otherwise, only conformed contract modification fragnets will be added into the subsequent monthly updates. All revisions to the current baseline schedule activities that are necessary to further refine the schedule so that the changed work activities can be logically tied to the schedule shall be made. Financial data shall not be incorporated into the schedule until the contract modification is signed by the Contracting Officer.

#### **1.8.1. Time Impact Analysis:**

Time Impact Analysis shall be used by the Contracting Officer in determining if a time extension or reduction to the contract milestone date(s) is justified. The Contractor shall provide a Time Impact Analysis to the Contracting Officer for any proposed contract change or as support for a Value Engineering Proposal, Claim or Request for Equitable Adjustment by the Contractor.

- a. The Contractor shall submit a Time Impact Analysis (TIA) illustrating the influence of each change or delay on the Contract Completion Date or milestones. Unless the Contracting Officer requests an interim update to the schedule, the current monthly updated schedule accepted by the government shall be used to display the impacts of the change. Unless requested by the Contracting Officer, no other non-conformed changes will be incorporated into the schedule being used to justify the change impact.
- b. Each TIA shall include a Fragmentary Network (fragnet) demonstrating how the Contractor proposes to incorporate the impact into the Project Schedule. A fragnet is defined as the sequence of new activities and/or activity revisions, logic relationships and resource changes that are proposed to be added to the existing schedule to demonstrate the influence of impacts to the schedule. The fragnet shall identify the predecessors to the new activities and demonstrate the impacts to successor activities. Include a narrative report describing the effects of new activities and relationships to interim and contract completion dates, with each TIA.
- c. Following the Contractor's receipt of a contract modification on a Standard Form 30 signed by the Government; all changes in the fragnet used to determine impacts, shall be incorporated into the schedule. Changes will occur during the next monthly schedule update meeting.

#### **1.8.2. No Reservation-Of-Rights**



All direct costs, indirect costs, and time extensions will be negotiated and made full, equitable and final at the time of modification issuance.

### **1.9. CHANGES TO THE NETWORK ANALYSIS SCHEDULE**

If changes in the method of operating and scheduling are desired, the Contracting Officer shall be notified in writing stating the reasons for the change. If the Contracting Officer considers these changes to be of a major nature, the Contractor may be required to revise and submit for acceptance, without additional cost to the Government, the network diagrams and required sorts. A change may be considered of a major nature if the estimated time required or actually used for an activity or the network logic is varied from the original plan to a degree that there is a reasonable doubt as to the effect on the contract completion date(s) [or phase completion dates]. Changes that affect activities with adequate float time shall be considered a major change when their cumulative effect could extend the contract completion date.

### **1.10. FLOAT**

Use of float suppression techniques, such as; preferential sequencing (arranging critical path through activities more susceptible to government caused delay), special lead/lag logic restraints, zero total or free float constraints, extended activity times, or imposing constraint dates other than as required by the contract, shall be cause for rejection of the project schedule or its updates. The use of Resource Leveling (or similar software features) used for the purpose of artificially adjusting activity durations to consume float and influence the critical path is expressly prohibited.

#### **1.10.1. Definitions of Float or Slack**

Free Float is the length of time the start of an activity can be delayed without delaying the start of a successor activity. Total Float is the length of time along a given network path that the actual start and finish of activity(s) can be delayed without delaying the project completion date. Project Float is the length of time between the Contractor's Early Completion (or Substantial Completion) and the Contract Completion Date.

#### **1.10.2. Ownership of Float**

Float available in the schedule, at any time shall not be considered for the exclusive use of either the Government or the Contractor. During the course of contract execution, any float generated due to the efficiencies of either party is not for the sole use of the party generating the float; rather it is a shared commodity to be reasonably used by either party. Efficiencies gained as a result of favorable weather within a calendar month, where the number of days of normally anticipated weather is less than expected, will also contribute to the reserve of float. A schedule showing work completing in less time than the Contract time, and accepted by the Government, will be considered to have Project Float. Project Float will be a resource available to both the Government and the Contractor. No time extensions will be granted nor delay damages paid unless a delay occurs which impacts the Project's critical path, consumes all

available float or contingency time, and extends the work beyond the Contract Completion Date.

### 1.10.3. Negative Float

Negative float will not be a basis for requesting time extensions. Any extension of time will be addressed in accordance with the Paragraph “Time Extensions.” Scheduled completion date(s) that extend beyond the contract [or phase] completion date(s) (evidenced by negative float) may be used in computations for assessment of payment withholdings. The use of this computation is not to be construed as a means of acceleration.

## 1.11. TIME EXTENSIONS

Extension of time for performance required under the clauses entitled “Changes,” “Differing Site Conditions,” “Default (Fixed-Price Construction)” or “Suspension of Work” will be granted only to the extent that equitable time adjustments for the activity or activities affected exceed the total float or slack along the network paths involved at the time Notice to Proceed was issued for the change. The Contractor acknowledges and agrees that delays in activities which, according to the network analysis schedule, does not in fact actually affect any milestone completion dates or the contract completion date shown on the CPM network at the time of delay, will not be a basis for a contract extension. Submit time extension requests with a Time Impact Analysis and three copies of the Total Float (or Slack) Report, Narrative Report and Log Report.

## 1.12. MONTHLY COORDINATION MEETING

**Note:** Consult with the local ROICC Field Office on whether to use this paragraph. Include this paragraph for larger or more complex projects.

In conjunction with receipt of the Monthly Network Update submission, a coordination meeting will be held each month [on site] [in the Contracting Officer’s conference room] to discuss the report. The Contractor shall make a presentation of the previously submitted and current Monthly Network Update to the Contracting Officer so as to provide an overview of the project’s schedule and provide an opportunity to discuss items of coordination.

## 1.13. BIWEEKLY WORK SCHEDULE

**Note:** Consult with the local ROICC Field Office on whether to use this paragraph. Include this paragraph for larger or more complex projects.

To provide a more detailed day-to-day planning of upcoming work, the Contractor shall prepare and issue detailed work plans that coordinate with and supplement the above defined network analysis. The work plans shall be keyed to the CPM activity numbers and shall be submitted each week and shall show the projects activities that will occur during the following two-week interval.

Additionally, the critical path activities are to be identified on the Biweekly Work Plan. The detail work plans are to be bar chart type schedules prepared by the Contractor in sufficient detail to define the work to be accomplished, the crews, construction tools and equipment to be used during the current and next two-week interval. The bar charts shall be formatted to allow reproduction on 8 1/2 by 11 sheets. Three copies of the bar chart schedules shall be delivered to the Contracting Officer not less than 3 work hours prior to the start of the weekly coordination meeting.

#### 1.14. WEEKLY COORDINATION MEETING

**Note:** Consult with the local ROICC Field Office on whether to use this paragraph. Include this paragraph for larger or more complex projects.

In conjunction with the receipt of the Bi-Weekly Work Schedule, a coordination meeting will be held each week [on site] [in the Contracting Officer's conference room] to discuss the work schedule. The Contractor shall make a presentation of the previously submitted and current Bi-Weekly Work Schedule to the Contracting Officer so as to provide an overview of the project's schedule and provide an opportunity to discuss items of coordination. Consideration of materials, crews, and equipment shall be addressed to ascertain their respective availability. The meeting shall identify actions necessary to provide adherence to the Bi-Weekly Work Schedule and the overall network for the project defined above. The Contractor will take meeting minutes. All meeting minute entries will be keyed to the schedule activity number(s) being addressed. Within one day of the meeting, the Contractor will provide a draft copy of the meeting minutes to the Contracting Officer for review and comment. Final copies of the minutes containing the comments provided by the Contracting Officer, will be issued within 3 days of the meeting.

#### 1.15. CORRESPONDENCE AND TEST REPORTS

All correspondence (e.g., letters, Requests for Information (RFIs), e-mails, meeting minutes, Production and QC Daily Reports, material delivery tickets, photographs, etc.) shall reference the Schedule Activity Number(s) that are being addressed. All test reports (e.g., concrete, soil compaction, weld, pressure, etc.) shall reference the Schedule Activity Number (s) that are being addressed.

*This page intentionally left blank*

## Notation for RDCPM

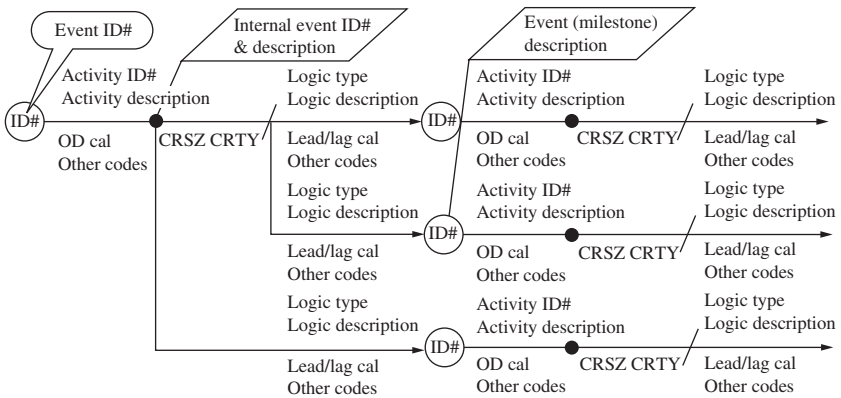
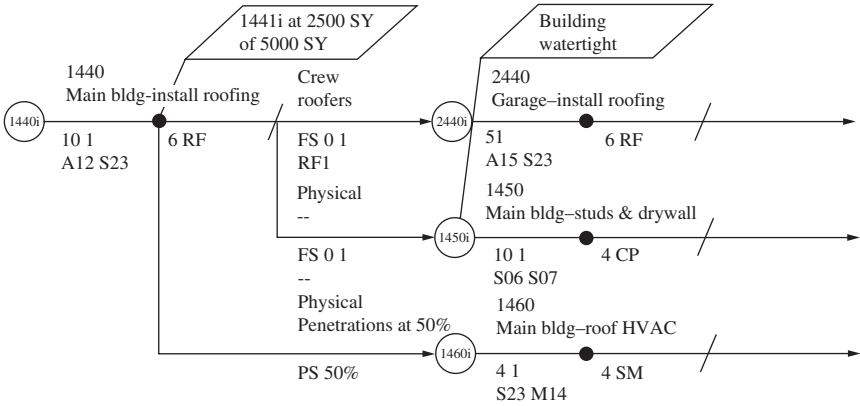
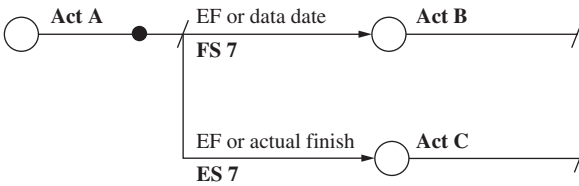

Figure C.1 Elements of a RDCPM Logic Network.



**Figure C.2** Segment of a RDCPM Logic Network. Activity 1440, starting after event 1440i, uses 6 roofers to install the roof on the main building, as shown on contract drawings A12 and S23, and has three successors. Activity 2440, starting after event 2440i, is the next activity to use the roofing crew for the garage roof, as shown on drawings A15 and S23. Activity 1430, after event 1430i which represents the milestone of “building watertight,” uses 4 carpenters to install studs and drywall, as shown on drawings S06 and S07. Event 1441i, in the middle of activity 1440, represents 50% of performance by area, allowing the start of activity 1460, HVAC penetrations, as shown on drawings S23 and M14, by a four person sheet metal crew.



**Figure C.3** Two variations of Finish-to-Start in RDCPM. Activity B may start 7 days after Activity A duration reduced to zero. Activity C may start 7 days after Activity A has reported end date.

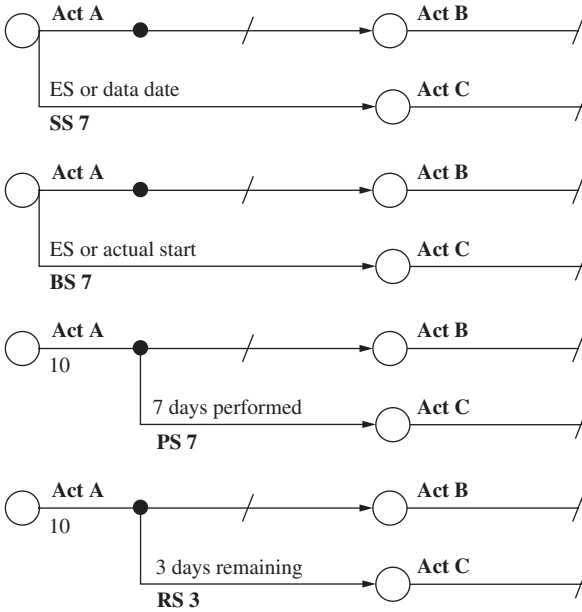

Figure C.4 Four variations of Start-to-Start in RDCPM.

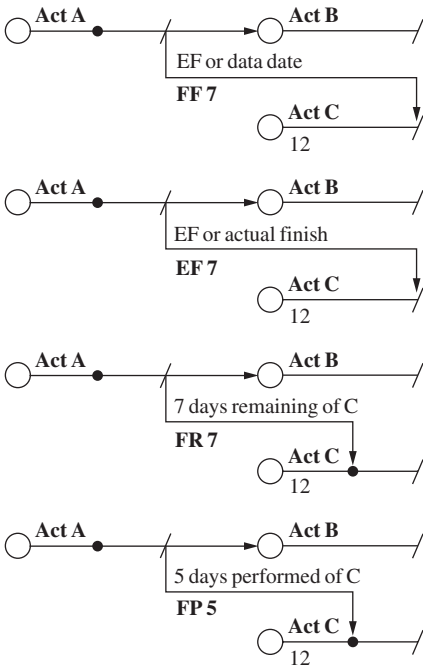

Figure C.5 Four variations of Finish-to-Finish in RDCPM.

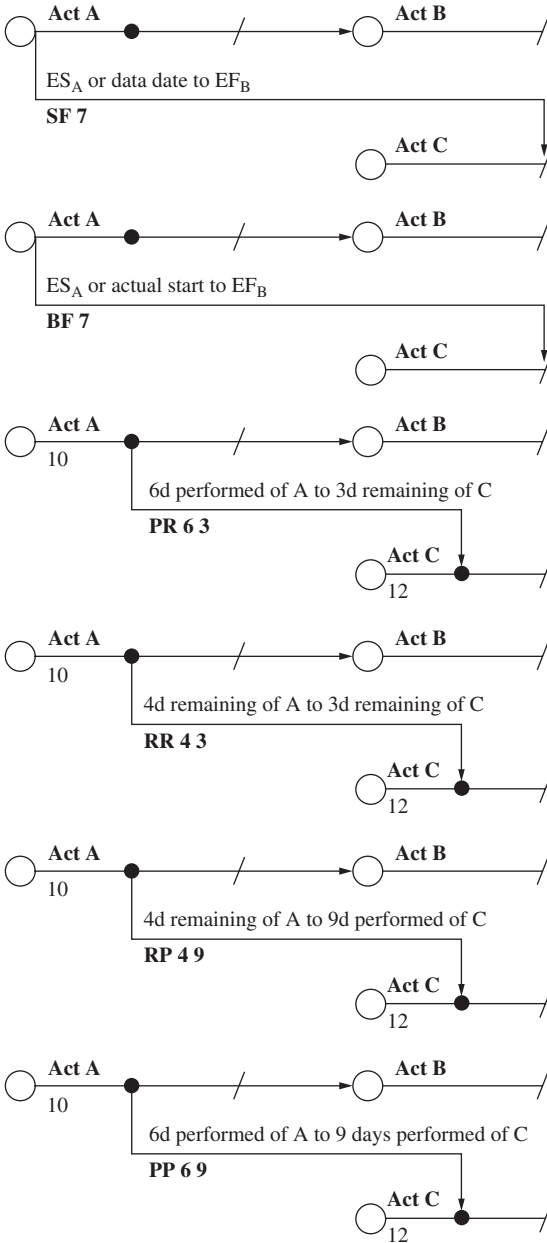

Figure C.6 Six variations of Start-to-Finish in RDCPM.



---

# Glossary

**activity** The work item that is the basic component of the project schedule.

**activity code** Alpha or numeric code added to the activity description to facilitate sorting by specific categories.

**activity list** A tabulation of the project activities sorted by activity time and/or code.

**activity number** In the ADM variant of CPM, this is a unique two-alphanumeric pair, known as *i-j* number, assigned to identify the activity and its logic to the computer. In the PDM variant of CPM, this is a unique one-alphanumeric identifier assigned to identify the activity but not its logic to the computer.

**activity-on-arrow (AOA)** *See* arrow diagramming method (ADM)

**activity-on-node (AON)** *See* precedence diagramming method (PDM)

**activity times** Time information generated through the CPM calculation that identifies the start and finish times for each activity in the network.

**arrow** The graphical representation of an activity in the CPM network. One arrow represents one activity. The arrow is not a vector quantity and is not necessarily drawn to scale.

**arrow diagram** CPM network. *See* also network and arrow diagramming method.

**arrow diagramming method (ADM)** A network in which the scheduled sequence of activities is represented by arrows where the tail of the arrow represents the start of the activity and the head represents the finish of the activity.

**backward pass** The calculation of late finish and late start times working backward from the last activity finish time.

**bar chart** Chart with activities plotted to time scale. Also called Gantt chart.

**baseline schedule** The approved project schedule.

**calendar** Assigned calendar (typically 5-day, 6-day, or 7-day) used to convert CPM calculated times to calendar dates.

**constraint** An artificial limitation based upon information not recorded in the logic network that affects when an activity can be scheduled.

**cost** The monetary price of an activity.

**crashing** The technique of reducing overall schedule time frame by either re-sequencing activities and/or reducing activity times by expenditures such as overtime.

- critical activity** An activity on the critical path.
- critical path** The longest connected route through the CPM network.
- critical path method (CPM)** An approach to developing a schedule that starts with a project plan sequenced from beginning to end, followed by time driven forward and backward passes to establish (1) the critical path and (2) float or scheduling flexibility on all other paths.
- data date** Starting calendar date for a network calculation.
- dummy activity** Colloquial term to describe a logic restraint. In ADM, a zero-duration activity used to achieve unique numbering (*ij*) for an activity, or to record complex logic between activities. In PDM, a zero-duration activity used to achieve a hammock.
- duration** The number of work days (periods) to complete the activity.
- early event time** The earliest time an event can be started.
- early finish** The earliest time an activity can be completed.
- early start** The earliest time an activity can be started (equal to early event time).
- edit** A computer sort by *i-j*, total float, code, or early or late dates.
- event** A point in time representing the intersection of two or more arrows. The event has no time duration. It can be a milestone. Junction between two or more activities in a logical network.
- event number** Unique random number assigned to an event in an ADM network. Its purpose is to identify the event to the computer. *See i-j number.*
- event times** Time information generated through CPM calculation that identifies the start and finish times for each event in a network.
- expected time** The mean activity duration for a PERT activity.
- fast track** A project where implementation starts before design is finalized.
- finish-to-finish** In PDM, predecessor activity must finish before the successor can complete.
- finish-to-start** In PDM, the predecessor must complete before the successor can begin.
- float** The flexibility that an activity has vs. the critical path. *See total float and slack.*
- forward pass** The calculation of the early start and early finish dates for all network activities.
- fragnet** A part or fragment of a network. *See subnetwork.*
- free float** Activity float that identifies the scheduling flexibility that will not delay the early start of any succeeding activities if used.
- hammock activity** A summary activity representing a continuous segment of a logic network.

- horizontal event numbering** Assigning event numbers in horizontal order.
- imposed date** A fixed date, usually in the form of a “start no earlier than” (SNET) date, or “finish no later than” (FNLT) date.
- independent float** Activity float that identifies the scheduling flexibility that will neither reduce the total float (delay the early start) of any succeeding activities if used nor reduce the total float (push back the late finish) of any preceding activities if planned to be used.
- input** The data that must be introduced into the computer before a computation is started.
- lag** Duration between activities traditionally imposed on following or successor activities.
- late event time** The latest time an event can be reached without lengthening the project.
- late finish time** The latest time an activity can be completed without lengthening the project.
- late start time** The latest time an activity can start without lengthening the project.
- lead** An acceleration of the successor activity allowing it to start before completion of its predecessor activity.
- logic diagram** *See* network.
- logic loop** A circular connection of illogical arrows that cannot be computed.
- logical relationship** Dependency between two schedule activities; four possible types are finish-to-start, finish-to-finish, start-to-start, and start-to-finish.
- logic restraint** A connection used as a logical connector that does not represent actual work items. Usually represented by a dashed line. Sometimes called a “dummy,” because it does not represent work; it is an indispensable part of a CPM network.
- master schedule** The merging of several distinct project schedules sharing a common site, resources, or program with additional logic between such projects that may be optionally considered when scheduling an individual project.
- matrix** Grid system used in the graphical solution of mathematical problems. Once used in manual CPM solution but outmoded by later techniques.
- milestone** Significant event in the project.
- milestone schedule** A summary level project schedule that includes milestone events.
- Monte Carlo analysis** Analytical approach that computes the project schedule on an iterative basis to predict the probability meeting a range of completion dates.
- most likely time** Activity duration estimate (PERT terminology). Same as expected duration.

**near-critical activity** An activity (or network path) that has low total float.

**network** Connected sequence of arrows representing the project. This is the basis of CPM and PERT. The network must have one start point and one terminal point. *See also* arrow diagramming method.

**network path** A continuous series of logically connected activities in a network.

**node** A junction point connecting two or more activities. Same as an event in ADM.

**open end** A schedule activity either without any predecessor activities or without any successor activities.

**optimistic time** In PERT, the fastest time an activity can reasonably be expected to be completed.

**original duration** The duration initially assigned to a baseline schedule activity.

**output** Usually refers to the result of the CPM computer calculation.

**path convergence** Two or more network paths merging into the same event or node.

**path divergence** Two or more network paths emerging from an event or node.

**pessimistic time** In PERT, the slowest time an activity can be reasonably expected to be completed.

**PERT** Originally, program evaluation research task, now performance evaluation and review technique. Event oriented. Time or duration between events has three estimates: optimistic; pessimistic; and most likely.

**plan** The sequence in which a project is to be done. It is independent of the schedule.

**precedence diagramming method (PDM)** A variant of the CPM network in which the scheduled sequence of activities are represented by nodes, incorporating the scope and duration of the activities, separated by logic restraints that may also convey durations between activities.

**preconstruction CPM** Plan and schedule for the concept and design phase preceding the award of contract.

**preliminary CPM plan** CPM analysis of the construction phase made before the award of contract to determine a reasonable construction period.

**project** The overall work being planned. It must have one start point and one finish point.

**project management information systems (PMIS)** A system organizing, usually at the summary level, all projects for a major entity or governmental unit.

**project schedule** Planned dates for performing project schedule activities and meeting project schedule milestones usually derived from a project schedule network.

**project time** Time dimension in which the project is being planned. It must be consistent and is a net value (less holidays).

I	J	DUR- ATION			DESCRIPTION	START		FINISH		TOTAL FLOAT
						EAR	LAT	EAR	LAT	
61	63	5	4	17	ROOFING OFFICE	222	236	227	241	14
61	77	15	4	8	DUCTWORK OFFICE	222	256	237	271	34
61	68	5	4	25	GLAZE OFFICE	222	236	227	241	14
61	64	10	4	8	INSTALL PIPING OFFICE	222	222	232	232	0
61	65	4	4	4	INSTALL ELEC BACKING BOXES	222	222	226	226	0
62	63	0			RESTRAINT	227	241	227	241	14
63	68	0			RESTRAINT	227	241	227	241	14
63	80	5	4	22	PAINT OFFICE EXTERIOR	227	281	232	286	54
64	67	4	4	8	TEST PIPING OFFICE	232	232	236	236	0
65	66	10	4	4	INSTALL CONDUIT OFFICE	226	226	236	236	0
66	67	0			RESTRAINT	236	236	236	236	0
66	74	10	4	4	PULL WIRE OFFICE	236	256	246	266	20
67	68	5	4	19	PARTITIONS OFFICE	236	236	241	241	0
68	69	5	4	19	DRYWALL OFFICE	241	241	246	246	0
69	70	10	4	19	DRYWALL OFFICE	246	246	256	256	0
69	73	10	4	20	CERAMIC TILE OFFICE	246	271	256	281	25
70	77	0			RESTRAINT	256	271	256	271	15
70	71	10	4	26	WOOD TRIM OFFICE	256	256	266	266	0
71	72	10	4	22	PAINT INTERIOR OFFICE	266	266	276	276	0
71	80	5	4	21	HANG DOORS OFFICE	266	281	271	286	15
72	80	10	4	20	FLOOR TILE OFFICE	276	276	286	286	0
72	78	0			RESTRAINT	276	276	276	276	0
72	73	0			RESTRAINT	276	281	276	281	5
73	80	5	4	5	TOILET FIXTURES OFFICE	276	281	281	286	5
74	76	0			RESTRAINT	246	277	246	277	31
74	75	5	5	4	INSTALL PANEL INTERNALS OFFICE	246	266	251	271	20
75	79	10	4	4	TERMINATE WIRES OFFICE	251	271	261	281	20
76	79	4	4	4	AIR CONDITIONING ELEC CONNECT	246	277	250	281	31
77	78	5	4	18	INSTALL CEILING GRID OFFICE	256	271	261	276	15
78	80	10	4	18	ACOUSTIC TILE OFFICE	276	276	286	286	0
79	80	5	4	4	RINGOUT ELEC.	261	281	266	286	20
90	58	0			RESTRAINT	129	202	129	202	73
91	58	10	5	17	INSTALL RR SIDING	129	192	139	202	63
92	58	0			RESTRAINT	134	202	134	202	68
93	80	0			RESTRAINT	144	286	144	286	142
94	80	5	5	27	SEED + PLANT	207	281	212	286	74
					E N D					

*This page intentionally left blank*

---

# List of Acronyms and Symbols

<b>ADM</b>	arrow diagramming method
<b>AOA</b>	activity-on-arrow
<b>AON</b>	activity-on-node
<i>a</i>	optimistic PERT activity time
<i>b</i>	pessimistic PERT activity time
<b>CPM</b>	critical path method
<b>EET</b>	early event time
<b>EF</b>	early finish
<b>ES</b>	early start
<b>FF</b>	free float
<b>FF</b>	finish-to-finish
<b>FNET</b>	finish not earlier than constraint (forward pass)
<b>FNLT</b>	finish not later than constraint (backward pass)
<b>FS</b>	finish-to-start
<i>i</i>	starting event, typical activity
<b>IF</b>	independent float
<i>j</i>	finish event, typical activity
<b>JF</b>	junior float
<b>LET</b>	late event time
<b>LF</b>	late finish
<b>LS</b>	late start
<i>m</i>	most likely time, PERT
<i>o</i>	optimistic PERT activity time
<i>p</i>	pessimistic PERT activity time
<b>PERT</b>	performance evaluation and review technique
<b>PDM</b>	precedence diagramming method

<b>RDCPM</b>	Relationship Diagramming Method (Certified Standard)
<b>RDM</b>	Relationship Diagramming Method
<b>SF</b>	start-to-finish
<b>SS</b>	start-to-start
<b>SNET</b>	start not earlier than constraint (forward pass)
<b>SNLT</b>	start not later than constraint (backward pass)
$T_e$	early event time
$T_L$	late event time
$T_s$	scheduled event time



- Acceleration, 373, 375, 482, 487, 488, 503, 536, 539 (*See also* Recovery schedule)
- Activity calendar, 117, 118, 140, 144, 578
- Activity codes, 22, 70, 133, 207–216, 221, 223, 240, 392, 407, 413, 415, 434, 559
- Activity descriptions, 19, 22, 57, 63, 66, 93, 105, 113, 147, 210, 212, 220, 311, 348, 393, 418, 432, 448, 449, 470, 486, 552
- Activity duration, 67, 72, 166, 285, 369, 577, 586–588
- Activity list, 47, 254, 276
- Activity on arrow, 19, 75, 199 (*See also* ADM)
- Activity on node, 19 (*See also* PDM)
- Activity steps, 133, 216, 220, 463
- Activity title (*see* Activity description)
- Actual duration (AD), 169, 174, 477
- Actual finish (AF), 129, 130, 138, 166, 175, 238, 404, 405, 425, 426, 439, 461, 463, 467, 476, 568
- Actual start (AS), 111, 113, 129, 130, 138, 166–168, 175, 238, 241, 291, 404, 425, 439, 451, 461, 463–470, 476–478, 501, 552, 568
- ADM, 19–23, 27–31, 75, 81, 88, 111, 115, 131, 132, 143, 150, 153, 161, 163, 172–181, 200, 201, 231, 234–239, 254, 411, 421, 515, 517–521, 589, 590
- AF (*see* Actual finish)
- AGC (*see* Associated General Contractors of America)
- airport construction, 490
- Allegheny County Airport, 490
- American National Standards Institute (ANSI), 530, 531, 534
- American Society for Testing and Materials (ASTM), 534
- ANSI (*see* American National Standards Institute)
- AOA (*see* Activity on arrow)
- AON (*see* Activity on node)
- Apollo project, 17, 25, 493
- architectural planning, 5, 6, 8, 46, 69, 313, 322, 324, 325, 329, 357, 362
- Arrow diagramming method (*see* ADM)
- Artemis, 27
- AS (*see* Actual start)
- As-built CPM, 498, 517, 535, 542, 552–561, 567–572
- As-planned CPM, 349, 530, 542, 548–560, 567, 570–574
- As-should-have-been CPM, 550, 570
- Associated General Contractors of America (AGC), 531, 534
- ASTM (*see* American Society for Testing and Materials)
- Attributes of an activity, 21, 73–83, 86, 108, 111, 131, 184, 246
- actual duration (AD), 169, 174, 477
- actual finish (AF), 129, 130, 138, 166, 175, 238, 404, 405, 425, 426, 439, 461, 463, 467, 476, 568
- actual start (AS), 111, 113, 129, 130, 138, 166–168, 175, 238, 241, 291, 404, 425, 439, 451, 461, 463–470, 476–478, 501, 552, 568
- early finish (EF), 75–88, 94–110, 115, 116, 122, 129, 131, 142, 153, 166, 175, 180, 184, 192, 241, 246, 276, 309–311, 362, 396, 417, 422, 425, 441, 463, 516, 521

Attributes of an activity (*Cont.*):

- early start (ES), 75–88, 93–111,
  - 115–117, 122, 126, 129, 131, 142, 152,
  - 158, 166, 171, 180, 184, 192, 208,
  - 241, 246, 269, 276, 279, 280, 290,
  - 303, 307, 309–312, 351, 371, 405,
  - 417, 421, 425, 428, 432, 439, 449,
  - 451, 463, 466, 469, 516, 521, 529
- finish float, 175, 180
- free float (FF), 23, 75, 79, 80, 100, 102,
  - 109, 110, 123, 129, 131, 163, 166, 168,
  - 176–180, 236, 241, 303, 398, 419,
  - 424, 506, 573
- independent float (IF), 75, 79, 80, 100,
  - 102, 103
- junior float (JF), 23, 439
- late finish (LF), 75–88, 94–110, 115,
  - 120, 122, 125, 129, 131, 153, 175,
  - 180, 241, 246, 275, 309–312, 362,
  - 364, 371, 397, 417, 420, 429, 516,
  - 521, 522
- late start (LS), 75–88, 94–111, 115–117,
  - 120–123, 129–132, 153, 180, 184,
  - 241, 246, 276, 281, 290, 309, 310,
  - 318, 319, 351, 397, 417, 516, 521,
  - 522, 561
- multi-calendar float (MF), 23
- original duration (OD), 111–117, 124,
  - 139, 162, 166, 169, 199, 240, 393,
  - 397, 420, 425, 426, 434, 438, 441,
  - 460–462, 474, 477
- percent complete (PCT), 22, 66–68, 74,
  - 111–113, 130, 138, 162, 166, 168, 171,
  - 231, 235, 239, 243, 396, 397, 404,
  - 439, 452, 461, 464, 468, 470, 477
- remaining duration (RD), 22, 68,
  - 111–113, 120, 130, 162, 166, 169, 240,
  - 243, 397, 404, 417, 420, 425, 438,
  - 440, 461–470, 474, 476–478
- scheduled finish, 73
- scheduled start, 73, 77
- smoothed start, 77, 80
- start float, 180, 451
- total float (TF), 74, 75, 79–88, 97–108,
  - 117, 123, 126, 128, 180, 184, 241, 246,
  - 269, 303, 340, 347, 351, 386, 397,
  - 417, 425, 427, 430, 434, 439, 451, 469
- 205, 231, 253, 387, 389, 390, 393–403,
- 427, 429, 437, 438, 448, 453, 503, 538,
- 572 (*See also* Gantt chart)
- Baseline schedule, 26, 154, 349, 384, 407,
  - 441, 463, 482, 486, 488, 497, 498,
  - 548, 550, 555, 568
- Bridge construction, 503
- Broken arrow, 59
- Bus bar technique, 61
- Butler Manufacturing plant, 494
- Calendar, 115–118, 190, 207–209,
  - 227–229, 243, 274–276, 293, 337,
  - 342–345, 453
- multiple, 28, 63, 76, 102, 106, 111,
  - 117–120, 139, 141, 178–181, 208, 226,
  - 227, 346, 350, 453, 527, 576–579,
  - 582, 589
- resource, 117, 118, 139, 140, 144, 146,
  - 186, 188, 214, 219, 221, 223, 232,
  - 236, 287–305, 332, 349, 575–578
- weather, 208, 209, 226, 229, 258, 261,
  - 343, 344, 350, 353, 432, 434, 535
- Case histories, 489, 497, 510
  - airport construction, 490
  - Allegheny County Airport, 490
  - Apollo project, 17, 25, 493
  - bridge construction, 503
  - Butler Manufacturing plant, 494
  - Chicago Courthouse, 489
  - Chicago Marina City Tower, 491
  - high-rise construction, 272, 351,
  - 492, 510
  - highway construction, 407, 503, 508,
  - 509, 551
  - hospital construction, 45, 323, 337, 349,
  - 375, 510
  - housing, 493
  - Interstate 76, 202 & 422 Interchange,
  - 508
  - JFK Airport Program 2000, 497
  - manufacturing facilities, 494
  - Maricopa County Prison Project, 512
  - NASA, 16, 17, 18, 81, 292, 493,
  - 510, 536
  - New Jersey Turnpike Authority, 496
  - oil refinery, 511
  - Phoenixville-Mont Claire Bridge, 503
  - railroad construction, 252, 256, 261,
  - 351, 490, 491, 495, 496
  - Saturn program (NASA), 493
  - school construction, 511
  - SEPTA RailWorks, 495
- Backward arrow, 59
- Backward pass, 75, 78, 79, 86, 106, 108,
  - 123, 132, 153, 241
- Bar chart, 6–9, 26, 29, 30, 36, 73, 76–78,
  - 129, 131, 136, 146, 169, 176, 192, 199,

- Times Tower, 490
- Toronto Transit Let's Move Program, 500
- U.S. Navy housing, 493
- Cash flow, 137, 321, 500
- Categories for cost breakdown, 145, 213, 356, 445
- Chaining, 23, 55, 95, 97, 98, 100, 102, 104, 332, 344, 351, 588
- Change order, 139, 303, 344, 367, 447, 448, 455, 471, 477–482, 486, 487, 500, 512, 530, 536, 542, 547, 550, 553–555, 574
- Chicago Courthouse, 489
- Chicago Marina City Tower, 491
- Claims and litigation, 31, 537, 541 (*See also* Legal issues)
- Claims avoidance using CPM, 512
- Classic delay, 547
- Coded networks, 58
- Codes for activities (*see* Activity codes)
- Completion
  - percent complete, 22, 66–68, 74, 111–113, 130, 138, 162, 166, 168, 171, 231, 235, 239, 243, 396, 397, 404, 439, 452, 461, 464, 468, 470, 477
  - substantial, 18, 19, 226, 292, 294, 299, 321, 332, 342, 350, 413, 536, 539, 541, 542, 547
- Concurrent delay, 547, 561
- Connections (*see* Restraints)
- Constraint, 110, 112, 120–124, 142, 177, 226, 233, 386, 395, 413, 420, 444, 450, 462, 486, 532, 556, 568
  - finish-not-earlier-than (FNET) date, 78, 110, 120, 122, 123, 233
  - finish-not-later-than (FNLTL) date, 78, 110, 120–125, 233, 234, 386, 387, 413
  - mandatory finish date, 110, 122, 594, 617
  - mandatory start date, 110, 122, 123
  - start-not-earlier-than (SNET) date, 120–123, 233, 234, 420, 556
  - start-not-later-than (SNLTL) date, 120–123, 233
  - start-on date, 110
- Construction phase, 321, 322, 333
- Construction Specifications Institute (CSI), 145, 213, 356, 445
- Contingency, 67, 69, 209, 225, 229, 344, 348, 350, 353, 368, 436, 452, 453, 479, 480, 528
  - calculated, 344
  - experience, 344
  - weather, 208, 226, 229, 258, 261, 343, 350, 353, 432, 434, 453, 535, 539–542, 548, 554, 571
- Corps of Engineers, 16, 17, 97, 493, 531, 536
- Cost
  - cost codes, 137, 214, 215, 223, 357, 358
  - percent complete, 22, 66–68, 74, 111–113, 130, 138, 162, 166, 168, 171, 231, 235, 239, 243, 396, 397, 404, 439, 452, 461, 464, 468, 470, 477
  - report, 18, 214, 215, 401
  - vs. time, 368
  - cost percent complete, 138, 439
  - cost/schedule control system (C/SCS), 18
  - crashing, 17, 187, 369, 370, 371, 372, 373, 375, 376
  - Critical activities, 58, 95, 102, 104, 269, 283, 304, 305, 313, 339, 350, 396, 440, 452, 471, 473, 477, 546, 588
  - backward pass procedure, 78, 79, 86, 106, 108, 123, 132, 153
  - forward pass procedure, 77, 78, 83, 108, 120, 122, 123, 469
  - i-j list, 55
- Critical path, 16, 19, 26, 58, 95–102, 117–126, 132, 153, 180, 186, 193, 225, 269, 276, 279, 283, 290, 304, 309, 338, 346–348, 370, 386, 422, 427–431, 436, 444, 452, 457, 471, 473, 477–481, 485, 489–492, 529, 532, 537–542, 554, 556, 559–561, 564, 571, 574, 582, 587
- Critical path method
  - detail level required, 29, 37, 65, 448, 452, 459, 493, 577, 581, 589
  - history of, 3, 6, 535
- Critical Path Method (CPM), 3, 5, 9–11, 26, 37, 100, 146, 182, 537–539, 582, 589
- Criticality, 111, 117, 124, 126, 134, 192, 429, 434, 477, 552
- crossovers, 59
- CSI (*see* Construction Specifications Institute)
- Data acquisition, 197, 207, 417, 427, 444
- Delay, 5, 9, 21, 26, 28, 76, 100, 102, 120, 123, 130, 149, 159, 175, 209, 304, 307, 337, 341, 343, 349, 350, 358, 441, 448, 462, 469, 471, 478, 482, 485, 494, 512, 533, 537–542, 545–572, 576, 587

Delay (*Cont.*):

- change orders, 139, 344, 477, 500, 512, 530, 547, 554, 555
  - classic delay, 547
  - concurrent delay, 547, 561
  - force majeure, 546, 548, 554, 558, 561
  - negative float, 122, 124
  - responsibility for delay, 31, 546
  - serial delay, 548
  - strikes as cause for delay, 547, 548, 554
  - weather, 208, 209, 226, 229, 258, 261, 343, 344, 350, 353, 432, 434, 535
- Design phase, 321, 322, 324, 325, 327, 330, 332
- Diagnostic report (Primavera P3), 176, 181, 395, 396, 397, 418–426, 450, 470, 473, 476, 507, 519, 573, 574
- calculation options chosen, 396, 400, 411, 414, 416, 417, 421, 476, 503, 527, 531
- constraints, 395–397, 417, 420, 422, 448, 450, 452, 470, 476, 509, 526, 527, 576, 582
- extended, software for, 18, 35, 211, 220, 227, 303, 335, 346, 422, 423, 425, 426, 519, 536, 540, 542, 561
- loop error report, 181, 418
- open end, 241, 396, 414, 420, 421, 422, 425, 451, 470, 476, 556
- out-of-sequence performance, 396, 405, 421, 469, 470, 471, 472, 473, 474, 530, 553, 572–574
- Disruption, 31, 461, 470, 471, 473, 478, 481, 485, 538, 540, 541, 545, 546, 553, 564, 571–574
- Drawing a network, 41, 49–51, 55, 61, 63, 200, 210, 219, 223, 246, 262, 272, 297, 313, 350, 392, 418, 434, 439, 445, 478, 526–528, 556–559
- Drexel University, 31, 508, 510
- Driving resources, 577
- Du Pont, 9, 10, 11, 15, 17, 41, 355, 474, 479, 537
- Duration
- actual (AD), 169, 174, 477
  - forecast, 69, 137, 298, 305, 362–364, 366, 368, 379, 441, 442, 483, 500, 502, 512
  - original duration (OD), 111–117, 124, 139, 162, 166, 169, 199, 240, 393, 397, 420, 425, 426, 434, 438, 441, 460–462, 474, 477, 561

- remaining duration (RD), 22, 68, 111–113, 120, 130, 162, 166, 169, 240, 243, 397, 404, 417, 420, 425, 438, 440, 461–470, 474, 476–478, 568
- tracking, 68, 111, 171, 186, 406, 477, 507, 588
- trend, 22, 189, 298, 299, 513

- Early event time (TE), 74, 75, 77, 78, 79, 81, 83, 84, 85, 86, 87, 88, 89, 90, 91, 93, 95, 96, 98, 102, 131, 133
- Early finish (EF), 75–88, 94–110, 115, 116, 122, 129, 131, 142, 153, 166, 175, 180, 184, 192, 241, 246, 276, 309–311, 362, 396, 417, 422, 425, 441, 463, 516, 521
- Early start (ES), 75–88, 93–111, 115–117, 122, 126, 129, 131, 142, 152, 158, 166, 171, 180, 184, 192, 208, 241, 246, 269, 276, 279, 280, 290, 303, 307, 309–312, 351, 371, 405, 417, 421, 425, 428, 432, 439, 449, 451, 463, 466, 469, 516, 521, 529
- EBS (*see* Enterprise project structure)
- EF (*see* Early finish)
- End to end time, 148
- End to start time, 148
- EnProMaC, 63, 418, 420, 422
- Enterprise project structure (EPS), 144, 145, 214, 406, 409
- ES (*see* Early start)
- Event, 51–59, 62–64, 70, 74–81, 83, 86, 89–98, 100, 102, 104, 110, 131, 143–153, 172, 233, 259–263, 285, 292, 293, 309, 311, 317, 338, 340, 351, 370, 375, 392, 397, 414, 420, 451, 457, 462, 486, 525, 530, 532, 548, 550, 561, 567
- causative, 485, 554–560, 567–574
  - early time ( $T_E$ ), 74–98, 131, 133
  - late time ( $T_L$ ), 74, 78–81, 91, 94, 96, 98, 131
- Event numbers, 52–55, 64, 90, 153, 285
- Fast track scheduling, 341, 353
- FF (*see* Free float)
- Filters, 124, 136, 316, 406, 432
- Finish
- early finish (EF), 75–88, 94–110, 115, 116, 122, 129, 131, 142, 153, 166, 175, 180, 184, 192, 241, 246, 276, 309–311, 362, 396, 417, 422, 425, 441, 463, 516, 521

- late finish (LF), 75–88, 94–110, 115,  
120, 122, 125, 129, 131, 153, 175, 180,  
241, 246, 275, 309–312, 362, 364, 371,  
397, 417, 420, 429, 516, 521, 522  
scheduled, 73
- Finish float, 175, 180 (*See also* PDM)
- Finish-not-later-than (FNLTL) date, 78,  
110, 120–125, 233, 234, 386, 387, 413
- Finish-to-finish, 129, 163, 168, 170, 173,  
179, 181, 238, 240, 396, 417, 421, 486  
(*See also* PDM)
- Float  
finish, 175, 180  
free float (FF), 23, 75, 79, 80, 100, 102,  
109, 110, 123, 129, 131, 163, 166, 168,  
176–180, 236, 241, 303, 398, 419,  
424, 506, 573  
independent (IF), 75, 79, 80, 100, 103, 579  
junior (JF), 23, 439  
multi-calendar (MF), 23  
start, 180, 451  
total float (TF), 74, 75, 79–88, 97–108,  
117, 123, 126, 128, 180, 184, 241, 246,  
269, 303, 340, 347, 351, 386, 397,  
417, 425, 427, 430, 434, 439, 451,  
469, 516, 521
- FNET (*see* Finish-not-earlier-than)
- FNLTL (*see* Finish-not-later-than)
- Fondahl John W., 18, 147, 234, 302,  
303, 304
- Force Majeure, 546, 548, 554, 558, 561
- Forecasting  
cash flow, 137, 321, 500
- Forward pass, 77, 78, 83, 108, 120, 122,  
123, 469
- Fragnet, 292
- Free float (FF), 23, 75, 79, 80, 100, 102,  
109, 110, 123, 129, 131, 163, 166, 168,  
176–180, 236, 241, 303, 398, 419,  
424, 506, 573
- Gantt Henry L., 6, 171, 173, 243, 417,  
474, 589
- GERT, 18, 19, 20, 22, 31, 37, 112, 200,  
203, 579, 581, 583, 586–590
- Graphical user interface (GUI), 131,  
184, 189
- Grid paper, 49
- GUI (*see* Graphical user interface)
- H.B. Zachry Co., 18, 147
- Hammock, 132, 133, 142, 172, 173, 174,  
175, 181, 396
- Hierarchical systems, 145, 146, 213,  
214, 583
- High-rise construction, 272, 351,  
492, 510
- Highway construction, 150, 210, 212, 236,  
237, 290, 343, 407, 409, 413, 442,  
490, 495, 503, 508, 533, 551
- Hospital construction, 45, 323, 337, 349,  
375, 510
- Housing, 493
- IF (*see* Independent float)
- i-j  
list, 3, 6, 10, 30, 37, 39, 47, 53, 66, 73,  
81, 106, 107, 113, 115, 126, 127, 163,  
214, 216, 222, 223, 227, 228, 229,  
231, 243, 245, 253, 254, 269, 271,  
275, 285, 310, 313, 319, 342, 474  
numbering, 53, 54, 55, 56, 59, 81, 83,  
261, 356, 394  
sort, 22, 108, 127, 154, 158, 269, 270,  
272, 288, 307, 318, 365, 407, 427
- Independent float (IF), 75, 79, 80, 100,  
103, 579
- Interstate 76, 202 & 422 Interchange,  
508
- Intuitive manual computation, 88, 89,  
104, 106, 144, 152, 153, 181, 187,  
191, 198, 233, 269, 287, 305, 378,  
389, 405, 451, 575, 576
- JF (*see* Junior float)
- JFK Airport Program 2000, 497
- Junior float (JF), 23, 439
- Kelley James E. Jr., 9, 10, 15, 16, 17, 41,  
86, 170, 376, 474
- Kelley-Walker method, 10
- Key materials, 307
- Lag (*see* Lead/lag)
- Late event time (TL), 74, 75, 78, 79, 81,  
91, 93, 94, 95, 96, 98, 131
- Late finish (LF), 75–88, 94–110, 115, 120,  
122, 125, 129, 131, 153, 175, 180,  
241, 246, 275, 309–312, 362, 364,  
371, 397, 417, 420, 429, 516,  
521, 522
- Late start (LS), 75–88, 94–111, 115–117,  
120–123, 129–132, 153, 180, 184,  
241, 246, 276, 281, 290, 309, 310,  
318, 319, 351, 397, 417, 516, 521,  
522, 561

- Lead/lag, 18, 30, 43, 59, 68, 89, 149, 150, 153, 161, 170, 184, 197, 199, 293, 314, 347, 351, 462, 494, 512, 518, 526, 530, 589
- Legal cases cited, 6, 8, 18, 26, 60, 69, 70, 111, 112, 115, 126, 129, 130, 137, 138, 139, 140, 147, 167, 170, 171, 175, 176, 177, 178, 179, 180, 191, 198, 224, 225, 226, 288, 290, 342, 363, 364, 365, 370, 371, 373, 375, 389, 473, 477, 479, 487, 510, 528, 537, 538, 542, 545, 547, 549, 552, 553, 556, 572, 578
- Legal issues
- acceleration charges, 373, 375, 482, 487, 488, 503, 536, 539, 540, 565
  - as-built CPM, 498, 535, 536, 542, 552, 553, 554, 557, 558, 560, 561, 567, 568, 570, 572
  - as-planned CPM, 349, 542, 548, 549, 550, 551, 552, 553, 554, 556, 557, 558, 560, 567, 570, 571, 572, 574
  - as-should-have-been CPM, 550, 551, 570
  - causative factors, 485, 554, 555, 556, 557, 558, 559, 560, 567, 568, 569, 571, 573, 574
  - change orders, 139, 344, 477, 500, 512, 530, 547, 554, 555
  - claims avoidance using CPM, 512
  - classic delay, 547
  - concurrent delay, 547, 561
  - contracts, 8, 18, 276, 342, 462, 493, 497, 511, 532, 548, 554, 570
  - evidentiary use of CPM, 538, 539, 540, 541, 542
  - force majeure, 546, 548, 554, 558, 561
  - serial delay, 548
  - strikes as cause for delay, 547, 548, 554
  - time impact evaluation (TIE), 557–570
- Leveled finish, 76
- Leveled start, 76, 80
- LF (*see* Late finish)
- Log (Primavera P3), 211, 222, 225, 227, 234, 240, 394, 440, 442, 445, 528, 574
- Logic connection, 395, 452, 586
- Logic diagrams, 48, 215, 526
- Logic loop, 22, 212
- Logic loop detection, 418
- Logic loop erroneous detection, 419
- Logic resource codes, 219
- Logic restraint, 116, 120, 132, 193, 237, 396, 450, 483, 518, 526, 576
- Logic splitter, 45
- logic spreader, 45, 317, 340
- longest path, 100, 153, 422, 452
- loop, logical (*see* Logic loop)
- LS (*see* Late start)
- Main chain, 16, 95
- Management scheduling and control system (MSCS), 27, 163, 164, 168, 186, 227, 287
- Manipulating the schedule, 349, 450
- Maricopa County Prison Project, 512
- Matrix method
- backward pass, 78, 79, 86, 106, 108, 123, 132, 153
  - forward pass, 77, 78, 83, 108, 120, 122, 123, 469
- Mauchly Associates, 15, 17, 287
- Mauchly John W., 9, 15, 17, 287
- McAuto, 27, 287
- MF (*see* Multi-calendar float)
- Microsoft Project, 71, 72, 117, 186, 188, 189, 238, 383, 575, 578, 590
- Milestones, 21, 52, 74, 77, 83, 93, 112, 116, 131, 132, 143, 213, 233, 337, 349, 396, 432, 440, 451, 560, 561
- Moder J.J., 18, 147, 583
- Multi-calendar float (MF), 23
- Multiple calendars, 111, 117, 118, 178, 179, 181, 193, 208, 226, 427, 453, 527, 578, 589
- Multiple starting/ending activities, 118, 120, 420
- Multiproject scheduling, 25, 294, 296, 297, 305, 383
- Multisheet networks, 61
- Narrative summary report, 229, 336, 352, 422, 436, 443, 444, 473, 474, 478, 485, 527, 530, 549, 551
- NASA, 16, 17, 18, 81, 292, 493, 510, 536
- Negative float, 122, 124
- Negative lag, 170, 240, 427
- Network logic, 51, 67, 285, 469
- Network scheduling, 10, 17, 294, 304, 531
- New Jersey Turnpike Authority, 496
- Nonconstruction CPM project, 457
- Non-deterministic polynomial-time complete problem, 576
- O'Brien James J., preface
- O'Brien-Kreitzberg & Associates (OKA), 291, 492, 495, 496, 497, 498, 537, 538, 550, 551

- OD (*see* Original duration)
- Oil refinery, 511
- Open Plan, 189, 190, 191, 192, 193, 243
- Ordinal calendar, 266
- Organization breakdown structure (OBS),  
144, 145, 146, 214
- Original duration (OD), 111–117, 124,  
139, 162, 166, 169, 199, 240, 393,  
397, 420, 425, 426, 434, 438, 441,  
460–462, 474, 477, 561
- Overlapping activities, 36
- PDM (*see* Precedence diagramming  
method)
- finish float, 175, 180
- finish-to-finish, 129, 163, 168, 170, 173,  
179, 181, 238, 240, 396, 417, 421, 486
- start float, 180, 451
- start-to-finish, 170
- start-to-start, 153, 162, 163, 168, 170,  
175, 179, 181, 238, 404, 421, 451,  
463, 486
- Percent complete (PCT), 22, 66–68, 74,  
111–113, 130, 138, 162, 166, 168, 171,  
231, 235, 239, 243, 396, 397, 404,  
439, 452, 461, 464, 468, 470, 477
- cost percent complete, 138, 439
- Personal computer (PC), 27, 159, 183,  
397, 405, 438, 499, 500
- PERT, 11–22, 31, 37, 70–74, 80–88, 95,  
112, 131, 147, 159, 200, 224, 389, 390,  
391, 394, 472, 581, 582, 583, 584,  
586, 587, 589, 590
- PERT/Cost, 18
- Phoenixville-Mont Claire Bridge, 503
- Physical logic, 232, 448, 507
- Plot code, 428, 431
- Plotnick Fredric, preface, 30, 31
- Precedence diagramming method (PDM),  
18–23, 27, 28, 30, 31, 46, 66, 74, 108,  
112, 129, 131, 132, 143, 147–156, 159,  
161–181, 200, 202, 231, 235, 236,  
237, 239, 263, 264, 302, 348, 421,  
423, 425, 463, 464, 465, 518, 525,  
526, 527, 531, 589, 590
- finish-to-finish relationships, 129, 163,  
168, 170, 173, 179, 181, 238, 240,  
396, 417, 421, 486
- nontraditional relationships in, 166,  
167, 168
- overlapping activities, 36
- start and finish total float, 175,  
180, 451
- start-to-start relationships, 153, 162,  
163, 168, 170, 175, 179, 181, 238,  
404, 421, 451, 463, 486
- Precedence networks, 18, 19,  
147, 148
- Pre-construction phase, 322
- Preferential logic, 259, 297
- Preliminary schedule, 623
- Primavera Project Planner P3  
alias code, 216
- diagnostic tools/reports, 176, 181,  
395–397, 418–426, 450, 451,  
470–476, 507, 519, 573, 574
- hot keys, 389
- menus, 189, 389, 405, 453
- Primavera Project Planner P3e/c, 28, 30,  
31, 35, 36, 67, 70, 113, 114, 140, 144,  
181–187, 188, 191, 208, 209, 213,  
216, 221, 222, 227, 238, 242, 383,  
405–407, 409, 414–419, 421, 442,  
451, 464–470, 476, 485, 509,  
511, 517
- Primavera Suretrak Project Planner, 28,  
181–188, 216, 227, 241, 243, 383,  
395, 405, 414, 416, 451, 476, 517, 611
- Procurement, 311–320, 341, 346–348,  
393, 459, 494, 563, 564, 588
- free float, 23, 75, 79, 80, 100, 102, 103,  
123, 177, 303, 506, 579
- junior float, 23, 439
- Progress override, 22, 111, 180, 396, 414,  
451, 469
- Progress payments, 356, 358, 379, 497,  
529, 532, 533
- Project control system (PCS), 25, 26
- Project management system (PMS), 18,  
287
- PROJECT/2, 27, 287
- Railroad construction, 495
- RD (*see* Remaining duration)
- RDCPM standard, 20–23, 204, 205, 590,  
631–634
- RDM (*see* Relationship Diagramming  
Method)
- Recovery schedule, 487, 598 (*See also*  
Acceleration)
- Relationship Diagramming Method, 21,  
102, 164, 236, 237, 438
- Remaining duration (RD), 22, 68,  
111–113, 120, 130, 162, 166, 169, 240,  
243, 397, 404, 417, 420, 425, 438,  
440, 461–470, 474, 476–478, 568

- Resource allocation and labor planning (RAMPS), 17, 287
- Resource calendar, 117, 118, 144, 578
- Resource codes for restraints, 219
- Resource leveling, 140, 302, 576
- Resource planning, 17, 287, 292, 294, 298
  - algorithm limitations, 576
  - GERT, 18–20, 22, 31, 37, 112, 200, 203, 579, 581, 583, 586, 587, 588, 590
  - limited resources, 76, 117, 577, 579
  - manpower vs. resource usage, 136, 224, 246, 287, 288
  - materials, 11, 76, 102, 138, 145, 147, 232, 240, 307–311, 313, 314, 320, 344, 440, 490, 491, 545, 547
  - nondeterministic polynomial-time complete, 576
  - resource calendars, 117, 118, 144
  - resource leveling, 140, 302, 576
  - resource planning and control (RPC), 287
  - resource planning and scheduling method, 17
  - resource smoothing, 77, 103, 112, 140, 576
- Resource-driven scheduling, 577
- Restraints, 19–22, 28, 37, 43, 53, 57, 102, 108, 110, 116, 131, 140, 154, 161–163, 166, 168–181, 189, 231, 232–243, 257, 265, 292, 293, 342, 372, 394, 396, 404, 405, 414, 420, 425, 426, 429, 450, 451, 463, 465, 466, 486, 499, 508, 526, 527, 556, 572, 574, 576, 577, 581
  - bogus, 464
  - finish-to-finish, 129, 163, 168, 170, 173, 179, 181, 238, 240, 396, 417, 421, 486
  - finish-to-start, 170, 178, 200, 234, 235, 237, 238, 240, 265, 414, 421, 425
  - physical, 3, 4, 21, 22, 49, 69, 170, 200, 212, 219, 221, 223, 231, 232, 234, 236, 239, 240, 243, 262, 327, 332, 445, 448, 452, 461, 480, 483, 486, 487, 507, 527, 551, 577
  - resource, 232, 487, 551
  - start-to-finish, 170
  - start-to-start, 153, 162, 163, 168, 170, 175, 179, 181, 238, 404, 421, 451, 463, 486
- Retained logic, 22, 241, 396, 414, 451, 469
- S curve, 8, 9
- Saturn program (NASA), 493
- Scheduled finish, 73
- Scheduled start, 73, 77
- Scheduling
  - baseline, 26, 154, 349, 384, 407, 441, 463, 482, 486, 488, 497, 498, 548, 550, 555, 568
  - change orders, 139, 344, 477, 500, 512, 530, 547, 554, 555
  - contingency scheduling, 67, 69, 209, 225, 226, 229, 344, 348, 350, 353, 368, 436, 452, 453, 479, 480, 528
  - cost report, 18, 214, 215, 401
  - crash events expediting, 17, 187, 338, 369, 370, 371, 372, 373, 375, 376, 378, 379
  - delay, 5, 9, 21, 26, 28, 76, 100, 102, 120, 123, 130, 149, 159, 175, 209, 304, 307, 337, 341, 343, 349, 350, 358, 441, 448, 462, 469, 471, 478, 482, 485, 494, 512, 533, 537–542, 545–572, 576, 587
  - diagnostic report, 395, 396, 418, 422, 425, 426, 450, 470
  - frequency of updates, 68
  - lead time, 314
  - manipulating the schedule, 349, 450
  - materials procurement milestones, 11, 76, 102, 138, 145, 147, 232, 240, 307–314, 320, 344, 440, 490, 491, 545, 547
  - monitoring project progress, 456
  - monthly updates, 438, 455–474, 475–478, 482–483
  - preliminary schedule, 496, 498
  - rate charts, 473
  - resource planning, 17, 287, 292, 294, 298
  - resource-driven scheduling, 577
  - responsibility for meeting, 342, 530
- School construction, 511
- SEPTA RailWorks, 495
- Sequencing, 76, 140, 212, 340, 551
- Serial delay, 548
- Smoothed start, 77, 80
- Smyth Richard, 31
- SNET (*see* Start-not-earlier-than)
- SNLT (*see* Start-not-later-than)
- Specifying CPM, 349, 517, 528, 530, 533
  - sample CPM specification, 519, 533, 591
- Unified Facilities Guide Specification, 519, 532, 607



- SPERT, 18, 19, 22, 31, 37, 71, 112, 193,  
226, 349, 581, 582, 583, 584, 585,  
586, 587, 588, 590
- Splitter logic, 45
- Spreader logic, 45, 317, 340
- Start
- actual (AS), 111, 113, 129, 130, 138,  
166–168, 175, 238, 241, 291, 404,  
425, 439, 451, 461, 463–470,  
476–478, 501, 552, 568
  - early start (ES), 75–88, 93–111,  
115–117, 122, 126, 129, 131, 142, 152,  
158, 166, 171, 180, 184, 192, 208,  
241, 246, 269, 276, 279, 280, 290,  
303, 307, 309–312, 351, 371, 405,  
417, 421, 425, 428, 432, 439, 449,  
451, 463, 466, 469, 516, 521, 529
  - float, 180, 451
  - late (LS), 75–88, 94–111, 115–117,  
120–123, 129–132, 153, 180, 184,  
241, 246, 276, 281, 290, 309, 310,  
318, 319, 351, 397, 417, 516, 521,  
522, 561
  - leveled, 76, 80
  - scheduled, 73, 77
  - smoothed, 77, 80
- Start float, 180, 451 (*See also* PDM)
- Start-not-earlier-than (SNET) constraint,  
120–123, 233, 234, 420, 556
- Start-not-later-than (SNLT) constraint,  
120, 122, 123, 233
- Start-to-finish, 170
- Start-to-start, 153, 162, 163, 168, 170,  
175, 179, 181, 238, 404, 421, 451,  
463, 486 (*See also* PDM)
- Steps (*see* Activity steps)
- Subsurface conditions, 492
- Summary networks, 112, 293, 336
- Taylor Frederick W., 6
- $T_E$  (*see* Early event time)
- TF (*see* Total float)
- Time
- actual duration (AD), 13, 22, 169, 174,  
477, 567, 568, 587
  - activity time computations, 105, 106
  - actual finish (AF), 129, 130, 138, 166,  
175, 238, 404, 405, 425, 426, 439,  
461, 463, 467, 476, 568
  - actual start (AS), 111, 113, 129, 130,  
138, 166–168, 175, 238, 241, 291,  
404, 425, 439, 451, 461, 463–470,  
476–478, 501, 552, 568
  - calendar dates, 111, 276, 538
  - cost vs. time, 368
  - crashing/expediting, 17, 187, 369, 370,  
371, 372, 373, 375, 376
  - critical activities, 58, 95, 102, 104, 269,  
283, 304, 305, 313, 339, 350, 396,  
440, 452, 471, 473, 477, 546, 588
  - duration, 12, 72, 80, 139, 304, 552, 582,  
587, 588, 624
  - early event times (TE), 74–98, 102,  
131, 133
  - early finish (EF), 75–88, 94–110, 115,  
116, 122, 129, 131, 142, 153, 166, 175,  
180, 184, 192, 241, 246, 276, 309–311,  
362, 396, 417, 422, 425, 441, 463,  
516, 521
  - early start (ES), 75–88, 93–111,  
115–117, 122, 126, 129, 131, 142, 152,  
158, 166, 171, 180, 184, 192, 208,  
241, 246, 269, 276, 279, 280, 290,  
303, 307, 309–312, 351, 371, 405,  
417, 421, 425, 428, 432, 439, 449,  
451, 463, 466, 469, 516, 521, 529
  - end to end time, 148
  - end to start time, 148
  - late event times (TL), 74–81,  
91–98, 131
  - late finish (LF), 75–88, 94–110, 115,  
120, 122, 125, 129, 131, 153, 175, 180,  
241, 246, 275, 309–312, 362, 364, 371,  
397, 417, 420, 429, 516, 521, 522
  - late start (LS), 75–88, 94–111, 115–117,  
120–123, 129–132, 153, 180, 184,  
241, 246, 276, 281, 290, 309, 310,  
318, 319, 351, 397, 417, 516, 521,  
522, 561
  - multiple calendars, 111, 117, 118, 178,  
179, 181, 193, 208, 226, 427, 453,  
527, 578, 589, 594
  - percent complete, 22, 66, 67, 68, 74, 75,  
111, 112, 113, 130, 138, 139, 162, 166,  
168, 169, 231, 235, 239, 243, 396,  
397, 404, 439, 452, 461, 462, 464,  
468, 470, 477
  - project time, 95, 281, 294, 332, 339,  
343, 357, 362, 561
- Time estimates, 69, 81, 91, 335, 344,  
353, 457
- Time impact evaluation (TIE), 557, 558,  
559, 560, 561, 563, 564, 565, 567,  
568, 570
- Time scaled logic diagram, 434
- Times Tower, 490

- Time-scaled logic network, 176
- $T_L$  (see Late event time)
- To do list, 6
- Toronto Transit Let's Move Program, 500
  - Total float (TF), 74, 75, 79–88, 97–108, 117, 123, 126, 128, 180, 184, 241, 246, 269, 303, 340, 347, 351, 386, 397, 417, 425, 427, 430, 434, 439, 451, 469, 516, 521, 579
- Trend analysis, 69, 137, 298, 299, 305, 362, 363, 364, 366, 368, 379, 441, 442, 483, 500, 502, 512
- Trend duration (TD), 22
- Turnaround application, 11, 67, 210, 292, 297, 298, 299, 468, 469, 472, 475, 511
- U.S. Navy housing, 493
- UNIVAC computer, 9, 10
- Updating and reviewing
  - baseline schedule, 407, 441, 548
  - cost reports, 18, 214, 215, 401
  - diagnostic report, 395, 396, 418, 422, 425, 426, 450, 470
  - frequency of updates, 68, 365, 396
  - progress payments, 356, 358, 379, 455, 457, 497, 529, 532, 533
- Walker Morgan, 9, 10, 16, 17, 170, 474
- Walstad Paul J., 541
- WBS (see Work breakdown structure)
- Weather, 208, 209, 226, 229, 258, 261, 343, 344, 350, 353, 432, 434, 453, 535, 539, 540, 542, 548, 554, 571
  - calendar, 115–118, 190, 207, 208, 229, 243, 274–276, 293, 337, 343, 432, 434, 453
  - contingency, 69, 209, 229, 344, 353, 453
  - delay, 540
- White Glenn L., 531, 537
- Wickwire Jon M., 26, 538, 541, 570
- Windows methodology, 569
- Work breakdown structure (WBS), 142, 143, 144, 145, 146, 214, 392, 499, 501
- Working schedule, 297
- Zachry Co., H.B., 18, 147
- Zeroing out, 558–560, 567, 569