

sixth edition

# human learning



jeanne ellis  
ormrod

*This page intentionally left blank*

# HUMAN LEARNING

---

**Vice President and Editorial Director:** Jeffery W. Johnston  
**Vice President and Publisher:** Kevin Davis  
**Editorial Assistant:** Lauren Carlson  
**Vice President, Director of Marketing:** Margaret Waples  
**Marketing Manager:** Joanna Sabella  
**Senior Managing Editor:** Pamela D. Bennett  
**Senior Project Manager:** Mary M. Irvin  
**Senior Operations Supervisor:** Matt Ottenweller  
**Senior Art Director:** Diane Lorenzo

**Cover Designer:** Ali Mohrman  
**Cover Art:** Corbis  
**Permissions Administrator:** Rebecca Savage  
**Project Coordination and Composition:** TexTech International  
**Printer/Binder:** Courier/Westford  
**Cover Printer:** Lehigh-Phoenix Color Corp.  
**Text Font:** Berkley

Credits and acknowledgments for materials borrowed from other sources and reproduced, with permission, in this textbook appear on appropriate page within text.

Every effort has been made to provide accurate and current Internet information in this book. However, the Internet and information posted on it are constantly changing, so it is inevitable that some of the Internet addresses listed in this textbook will change.

---

Copyright © 2012, 2008, 2004, 1999, 1995 by **Pearson Education, Inc.** All rights reserved. Printed in the United States of America. This publication is protected by Copyright and permission should be obtained from the publisher prior to any prohibited reproduction, storage in a retrieval system, or transmission in any form or by any means, electronic, mechanical, photocopying, recording, or likewise. To obtain permission(s) to use material from this work, please submit a written request to Pearson Education, Inc., Permissions Department, One Lake Street, Upper Saddle River, New Jersey 07458 or you may fax your request to 201-236-3290.

**Library of Congress Cataloging-in-Publication Data**

Ormrod, Jeanne Ellis.  
Human learning / Jeanne Ellis Ormrod. — 6th ed.  
p. cm.

Includes bibliographical references and index.

ISBN-13: 978-0-13-259518-6 (alk. paper)

ISBN-10: 0-13-259518-4 (alk. paper)

1. Learning, Psychology of. 2. Behaviorism (Psychology) I. Title.

BF318.O76 2012

153.1'5—dc23

2011023921

10 9 8 7 6 5 4 3 2 1

**PEARSON**

ISBN 10: 0-13-259518-4

ISBN 13: 978-0-13-259518-6

# HUMAN LEARNING

---

SIXTH EDITION

Jeanne Ellis Ormrod

*University of Northern Colorado (Emerita)*

**PEARSON**

Boston Columbus Indianapolis New York San Francisco Upper Saddle River  
Amsterdam Cape Town Dubai London Madrid Milan Munich Paris Montreal Toronto  
Delhi Mexico City São Paulo Sydney Hong Kong Seoul Singapore Taipei Tokyo

*This page intentionally left blank*

---

# Preface

I always enjoy writing and updating my *Human Learning* book. Each passing year brings exciting new research findings about how human beings think and learn. As a result, each year also brings new strategies for helping learners of all ages acquire information and skills—and also beliefs, motives, and attitudes—that will be useful and productive both in and outside the classroom. As my readers explore the nature of human learning in the pages ahead, I hope that my fascination with the topic will be contagious.

I've written this book with particular readers in mind: readers who would like to learn about learning but don't necessarily have much background in psychology. Such readers may benefit from studying the historical roots of learning theories but prefer to focus their energies on studying contemporary perspectives and ideas. These readers might find learning theories fascinating but lose patience when they can't see the relevance of those theories to everyday practice. These readers are capable of reading a dry, terse textbook but probably learn more effectively from a book that shows how different concepts relate to one another, provides numerous examples, and, especially, emphasizes meaningful learning—true *understanding*—of the material it presents.

## New to This Edition

Users of the fifth edition will see numerous changes in this sixth edition. As I always do, I've updated the text in a great many spots to reflect current theoretical perspectives and research findings regarding cognition, learning, and instructional practices. I've also worked hard to tighten my prose, eliminating needless redundancies and clarifying spots that struck me as awkward or ambiguously worded.

A more noticeable change is some reorganization of the content. In response to feedback from reviewers, I've split the fifth edition's lengthy Chapter 7 into two chapters: "Introduction to Cognitivism" (Chapter 7) and "Basic Components of Memory" (Chapter 8). I've also split the fifth edition's Chapter 11 into two chapters: "Cognitive-Developmental Perspectives" (Chapter 12, which focuses on Piagetian and neo-Piagetian theory and research) and "Sociocultural Theory and Other Contextual Perspectives" (Chapter 13, which includes Vygotskian and more recently

advanced contextualist ideas). I've folded the content of the fifth edition's chapter on social processes and peer-interactive instructional strategies into the new Chapter 13.

Furthermore, consistent with our ever-evolving understanding of human learning, I've added or expanded on a number of topics. Examples include a discussion and graphic depiction of how learning theories have evolved over time (Chapter 1); the possible role of glial cells, especially astrocytes, in learning and memory (Chapter 2); the importance of learning how to fail (Chapter 5); positive behavioral support, both individual and schoolwide (Chapter 5); emotional state as a factor affecting self-efficacy (Chapter 6); self-reflection as an aspect of self-regulation (Chapter 6); modeling as an important factor promoting productive interpersonal behaviors (Chapter 6); inclusion of the central executive component in the figural depiction of the dual-store model (Chapter 8); individual differences in central executive abilities (Chapter 8); expanded discussion of procedural knowledge (Chapter 9); general overhaul of the section on forms of encoding, in part to reflect recent neurological research findings (Chapter 10); condensation and reorganization of the section on concept learning (Chapter 10); expanded discussion of strategies for promoting conceptual change (Chapter 10); retrieval-induced forgetting (Chapter 11); importance of critically evaluating information obtained on the Internet (Chapter 11); new figure showing the transitional and variable nature of Piaget's stages (Chapter 12); expanded discussion of Vygotsky's theory (Chapter 13); expanded discussion of other contextual views, such as the concept of embodiment (Chapter 13); service learning (Chapter 13); revised perspective on formal discipline (Chapter 15); new section on critical thinking (Chapter 15); self-conscious emotions (Chapter 16); and an updated TARGETS mnemonic (Chapter 17).

As has been the case for previous editions of this book, I've written many multiple-choice and essay questions for the *Test Bank* (ISBN: 0-13-276374-5) to focus on higher-level thinking skills.

## Acknowledgments

Although I'm listed as the sole author, I've certainly not written this book alone. Many people have helped me along the way:

- Frank Di Vesta, my adviser and mentor at Penn State, who taught me a great deal about learning and refused to let me graduate until I also learned a great deal about writing.
- Kevin Davis, my editor at Pearson Education, who continues to guide, support, and inspire me in my efforts to shed light on the many ways in which psychology can inform practice in educational and therapeutic settings, and Paul Smith, my former editor at Pearson Education, whose invaluable suggestions helped shape this sixth edition.
- The production folks at Pearson Education and TexTech International, who transformed my word-processed manuscript and rough sketches into the finished product you see before you. I'm especially grateful to Mary Irvin and Lynda Griffiths. Mary adeptly and congenially coordinated the book's production at the Pearson end of things. And Lynda Griffiths, while granting me some much-appreciated artistic license in my idiosyncratic formats and writing style, caught many small errors and doggedly waded through my gazillion citations in search of omissions in my reference list. Her patience, persistence, and good humor throughout the process—despite a badly broken ankle during most of it—were truly extraordinary.



- My colleagues across the nation who have read early drafts or editions most thoroughly and conscientiously and whose suggestions have greatly improved the final product: Joyce Alexander, Indiana University; Livingston Alexander, Western Kentucky University; Kay Allen, University of Central Florida; Martha B. Bronson, Boston College; Margaret W. Cohen, University of Missouri at St. Louis; Ralph F. Darr Jr., The University of Akron; Jean C. Faieta, Edinboro University of Pennsylvania; Sarah Huyvaert, Eastern Michigan University; Janina Jolley, Clarion University of Pennsylvania; Joseph Kersting, Western Illinois University; Mary Lou Koran, University of Florida; Gerald Larson, Kent State University; Mark Lewis, University of Texas at Tyler; Michael S. Meloth, University of Colorado; Karen Murphy, The Pennsylvania State University; John Newell, University of Florida at Gainesville; Jim O'Connor, California State University at Bakersfield; Nimisha Patel, Arizona State University; Sarah Peterson, Duquesne University; Jonathan Plucker, Indiana University; Steven Pulos, University of Northern Colorado; Daniel Robinson, University of Texas at Austin; Jack Snowman, Southern Illinois University; and Karen Zabrocky, Georgia State University.
- Colleagues who reviewed the fifth edition and offered many helpful suggestions for adding to and in other ways enhancing my discussions in the sixth edition: Brett Jones, Virginia Tech; Daniel Robinson, University of Texas at Austin; and Loretta Rudd, Texas Tech University.
- My husband, Richard, and my children, Christina, Alex, and Jeffrey, who have been eternally supportive of my writing endeavors and provided me with numerous examples of human learning in action.
- My parents, James and Nancy Ellis, who long ago taught me the value of higher education.
- My students, who urged me to write the book in the first place.
- Other students around the globe, who continue to give me feedback about how I can make the book better. (An easy way to reach me is at [jormrod@alumni.brown.edu](mailto:jormrod@alumni.brown.edu).)

Jeanne Ellis Ormrod

*This page intentionally left blank*

---

# Contents

## PART ONE

---

### INTRODUCTION TO HUMAN LEARNING

#### CHAPTER 1

---

Perspectives on Learning	1
The Importance of Learning	2
Defining Learning	4
Determining When Learning Has Occurred	4
Research, Principles, and Theories	5
<i>How Theories of Learning Have Evolved over Time</i>	6
<i>Advantages of Theories</i>	7
<i>Potential Drawbacks of Theories</i>	9
<i>A Perspective on Theories and Principles</i>	10
Applying Knowledge about Learning to Instructional Practice	10
Overview of the Book	11
SUMMARY	12

#### CHAPTER 2

---

Learning and the Brain	13
Basic Building Blocks of the Human Nervous System	14
<i>Neurons</i>	14
<i>Synapses</i>	16
<i>Glial Cells</i>	16
Brain Structures and Functions	16
<i>Methods in Brain Research</i>	17

<i>Parts of the Brain</i>	18
<i>The Left and Right Hemispheres</i>	20
<i>Interconnectedness of Brain Structures</i>	21
Development of the Brain	21
<i>Prenatal Development</i>	22
<i>Development in Infancy and Early Childhood</i>	22
<i>Development in Middle Childhood, Adolescence, and Adulthood</i>	23
<i>Factors Influencing Brain Development</i>	24
<i>To What Extent Are There Critical Periods in Brain Development?</i>	24
<i>To What Extent Is the Brain “Prewired” to Know or Learn Things?</i>	27
The Physiological Basis of Learning	28
Educational Implications of Brain Research	29
SUMMARY	31

## PART TWO

---

### BEHAVIORIST VIEWS OF LEARNING

#### CHAPTER 3

---

Behaviorism and Classical Conditioning	32
Basic Assumptions of Behaviorism	32
Classical Conditioning	34
<i>The Classical Conditioning Model</i>	35
<i>Classical Conditioning in Human Learning</i>	36
<i>Common Phenomena in Classical Conditioning</i>	38

*Cognition in Classical Conditioning* 41  
*Changing Undesirable Conditioned Responses* 42  
 Educational Implications of Behaviorist Assumptions and Classical Conditioning 44  
 SUMMARY 46

CHAPTER 4

---

**Instrumental Conditioning** 48  
 Thorndike's Early Research 49  
 Rewards and Reinforcement 50  
     *Skinner's Operant Conditioning* 50  
     *The Various Forms That Reinforcement Can Take* 53  
 Punishment 57  
     *Effective Forms of Punishment* 58  
     *Ineffective Forms of Punishment* 61  
 Common Phenomena in Instrumental Conditioning 63  
     *Superstitious Behavior* 63  
     *Shaping* 63  
     *Chaining* 64  
     *Extinction* 65  
     *Effects of Reinforcement Schedules* 66  
     *Avoidance Learning* 71  
 Effects of Antecedent Stimuli and Responses in Instrumental Conditioning 73  
     *Cueing* 73  
     *Setting Events* 74  
     *Generalization* 74  
     *Stimulus Discrimination* 74  
     *Behavioral Momentum* 75  
 Cognition and Motivation in Instrumental Conditioning 75  
 SUMMARY 77

CHAPTER 5

---

**Applications of Instrumental Conditioning** 78  
 Applying Behaviorist Principles to Classroom Management 78  
     *Concerns about Using Reinforcement and Punishment in the Classroom* 79

*Using Reinforcement to Increase Desirable Behaviors* 82  
*Strategies for Decreasing Undesirable Behaviors* 86  
 Applied Behavior Analysis 92  
     *Using Applied Behavior Analysis with Large Groups* 96  
     *Adding a Cognitive Component to ABA* 99  
 Instructional Objectives 99  
     *Behavioral Objectives* 99  
     *Current Perspectives on Instructional Objectives* 100  
     *Usefulness and Effectiveness of Objectives* 101  
     *Formulating Different Levels of Objectives* 103  
 Programmed Instruction and Computer-Assisted Instruction 104  
     *Effectiveness of PI and CAI* 106  
 Mastery Learning 106  
     *Keller's Personalized System of Instruction (PSI)* 107  
     *Effectiveness of Mastery Learning and PSI* 108  
 When Behaviorist Techniques Are Most Appropriate 109  
 SUMMARY 110

**PART THREE**

---

SOCIAL COGNITIVE THEORY

CHAPTER 6

---

**Social Cognitive Theory** 111  
 General Principles of Social Cognitive Theory 112  
 Environmental Factors in Social Learning: Revisiting Reinforcement and Punishment 113  
     *Problems with a Strict Behaviorist Analysis of Social Learning* 115  
 Cognitive Factors in Social Learning 116  
 Reciprocal Causation 118  
 Modeling 119  
     *How Modeling Affects Behavior* 120  
     *Characteristics of Effective Models* 120  
     *Behaviors That Can Be Learned through Modeling* 122

<i>Conditions Necessary for Effective Modeling to Occur</i>	124
Self-Efficacy	127
<i>How Self-Efficacy Affects Behavior and Cognition</i>	128
<i>Factors in the Development of Self-Efficacy</i>	129
Self-Regulation	131
<i>Elements of Self-Regulation</i>	132
<i>Promoting Self-Regulated Behavior</i>	133
<i>The Cognitive Side of Self-Regulation</i>	136
Educational Implications of Social Cognitive Theory	137
SUMMARY	140

## **PART FOUR**

---

### COGNITIVE VIEWS OF LEARNING

#### CHAPTER 7

---

Introduction to Cognitivism	141
Edward Tolman's Purposive Behaviorism	142
Gestalt Psychology	144
Verbal Learning Research	148
Introduction to Contemporary Cognitivism	152
<i>General Assumptions of Cognitive Theories</i>	152
<i>Information Processing Theory</i>	154
<i>Constructivism</i>	154
<i>Contextual Theories</i>	155
<i>Integrating Cognitive Perspectives</i>	156
General Educational Implications of Cognitive Theories	157
SUMMARY	157

#### CHAPTER 8

---

Basic Components of Memory	158
A Dual-Store Model of Memory	159
<i>Sensory Register</i>	161
<i>Moving Information to Working Memory: The Role of Attention</i>	163
<i>Working Memory</i>	167

<i>Moving Information to Long-Term Memory: Connecting New Information with Prior Knowledge</i>	173
<i>Long-Term Memory</i>	173
Challenges to the Dual-Store Model	175
<i>Are Working Memory and Long-Term Memory Really Different?</i>	175
<i>Is Conscious Thought Necessary for Long-Term Memory Storage?</i>	176
Alternative Views of Human Memory	177
<i>Levels of Processing</i>	177
<i>Activation</i>	179
Remembering That <i>The Map Is Not the Territory</i>	180
Generalizations about Memory and Their Educational Implications	181
SUMMARY	183

#### CHAPTER 9

---

Long-Term Memory I: Storage and Encoding	184
Construction in Storage	185
<i>Examples of Construction in Action</i>	185
Long-Term Memory Storage Processes	188
<i>Selection</i>	190
<i>Rehearsal</i>	191
<i>Meaningful Learning</i>	192
<i>Internal Organization</i>	194
<i>Elaboration</i>	195
<i>Visual Imagery</i>	196
<i>How Procedural Knowledge Is Acquired</i>	198
<i>Does New Knowledge Require a Consolidation Period?</i>	199
Factors Affecting Long-Term Memory Storage	200
<i>Working Memory</i>	200
<i>Prior Knowledge</i>	200
<i>Prior Misconceptions</i>	204
<i>Expectations</i>	205
<i>Verbalization</i>	207
<i>Enactment</i>	207
<i>Repetition and Review</i>	208
Promoting Effective Storage Processes	211

Some Final Remarks about Long-Term Memory Storage 218  
 SUMMARY 219

CHAPTER 10

---

Long-Term Memory II:  
 The Nature of Knowledge 221  
 The Various Kinds of Knowledge 222  
     *Declarative and Procedural Knowledge* 222  
     *Explicit and Implicit Knowledge* 223  
 How Knowledge Is Encoded in Long-Term Memory 224  
     *Encoding in Terms of Physical Characteristics* 224  
     *Encoding in Terms of Actions* 225  
     *Encoding in Terms of Symbols* 227  
     *Encoding in Terms of Meanings* 227  
     *Different Forms of Encoding Are Not Mutually Exclusive* 228  
 The Organization of Long-Term Memory 229  
     *Long-Term Memory as a Hierarchy* 229  
     *Long-Term Memory as a Network* 231  
     *Parallel Distributed Processing* 234  
 Concepts 235  
     *Theories of Concept Learning* 237  
     *Factors Facilitating Concept Learning* 241  
 Schemas and Scripts 243  
 Personal Theories 245  
     *Personal Theories versus Reality* 247  
     *Fostering Theory Development* 248  
 Worldviews 250  
 The Challenge of Conceptual Change 252  
     *Promoting Conceptual Change* 254  
 Development of Expertise 259  
 Generalizations about the Nature of Knowledge 260  
 SUMMARY 263

CHAPTER 11

---

Long-Term Memory III:  
 Retrieval and Forgetting 265  
 How Retrieval Works 266  
     *Retrieval Cues* 268

Construction in Retrieval 270  
     *The Power of Suggestion: Effects of Subsequently Presented Information* 271  
     *Constructing Entirely New “Memories”* 272  
     *Remembering Earlier Recollections* 273  
     *Self-Monitoring during Retrieval* 274  
     *Important Cautions in Probing People’s Memories* 275  
 Forgetting 275  
     *Decay* 276  
     *Interference and Inhibition* 276  
     *Repression* 277  
     *Failure to Retrieve* 278  
     *Construction Error* 279  
     *Failure to Store or Consolidate* 279  
     *The Case of Infantile Amnesia* 279  
 General Principles of Retrieval for Instructional Settings 280  
 SUMMARY 287

**PART FIVE**

---

DEVELOPMENTAL AND CONTEXTUAL PERSPECTIVES

CHAPTER 12

---

Cognitive-Developmental Perspectives 289  
 Piaget’s Theory of Cognitive Development 289  
     *Key Ideas in Piaget’s Theory* 290  
     *Piaget’s Stages of Cognitive Development* 293  
 Current Perspectives on Piaget’s Theory 300  
     *Capabilities of Different Age-Groups* 300  
     *Effects of Experience and Prior Knowledge* 301  
     *Effects of Culture* 302  
     *Views on Piaget’s Stages* 302  
 Neo-Piagetian Theories of Cognitive Development 302  
     *Case’s Theory* 304  
 Implications of Piagetian and Neo-Piagetian Theories 307  
 SUMMARY 311

## CHAPTER 13

---

Sociocultural Theory and Other Contextual Perspectives	313
Vygotsky's Theory of Cognitive Development	313
<i>Key Ideas in Vygotsky's Theory</i>	314
<i>Comparing Piaget's and Vygotsky's Theories</i>	318
Current Perspectives on Vygotsky's Theory	321
<i>Social Construction of Meaning</i>	321
<i>Scaffolding</i>	323
<i>Participation in Adult Activities</i>	324
<i>Apprenticeships</i>	324
<i>Acquisition of Teaching Skills</i>	326
<i>Dynamic Assessment</i>	326
Adding a Sociocultural Element to Information Processing Theory	327
<i>Intersubjectivity</i>	327
<i>Social Construction of Memory</i>	328
<i>Collaborative Use of Cognitive Strategies</i>	329
Expanding the Contextualist Framework	330
General Implications of Sociocultural and Other Contextualist Theories	332
Peer-Interactive Instructional Strategies	334
<i>Class Discussions</i>	336
<i>Reciprocal Teaching</i>	338
<i>Cooperative Learning</i>	340
<i>Peer Tutoring</i>	344
<i>Communities of Learners</i>	346
<i>Technology-Based Collaborative Learning</i>	348
SUMMARY	350

## PART SIX

## COMPLEX LEARNING AND COGNITION

## CHAPTER 14

---

Metacognition, Self-Regulated Learning, and Study Strategies	352
Metacognitive Knowledge and Skills	353
Self-Regulated Learning	356
<i>The Roots of Self-Regulated Learning</i>	357

Effective Learning and Study Strategies	358
<i>Meaningful Learning and Elaboration</i>	358
<i>Organization</i>	359
<i>Note Taking</i>	360
<i>Identifying Important Information</i>	363
<i>Summarizing</i>	364
<i>Comprehension Monitoring</i>	364
<i>Mnemonics</i>	366
Development of Metacognitive Knowledge and Skills	373
Epistemic Beliefs	375
<i>Developmental and Cultural Differences in Epistemic Beliefs</i>	377
<i>Effects of Epistemic Beliefs</i>	378
The Intentional Learner	380
Why Students Don't Always Use Effective Strategies	380
Promoting Effective Learning and Study Strategies	382
SUMMARY	387

## CHAPTER 15

---

Transfer, Problem Solving, and Critical Thinking	389
Transfer	389
<i>Types of Transfer</i>	390
<i>Theories of Transfer</i>	392
<i>Factors Affecting Transfer</i>	397
Problem Solving	399
<i>Theories of Problem Solving</i>	400
<i>Cognitive Factors in Problem Solving</i>	402
<i>Problem-Solving Strategies</i>	409
<i>Meaningless versus Meaningful Problem Solving</i>	413
Facilitating Transfer and Problem Solving in the Classroom	414
Critical Thinking	420
<i>Developmental, Individual, and Cultural Differences in Critical Thinking</i>	422
<i>Fostering Critical Thinking in the Classroom</i>	423
SUMMARY	424

**PART SEVEN**

---

MOTIVATION

CHAPTER 16

---

Motivation and Affect 426

General Effects of Motivation 427

*Extrinsic versus Intrinsic Motivation* 428

Basic Human Needs 429

*Drive Reduction* 429

*Arousal* 431

*Maslow's Hierarchy of Needs* 432

*Competence and Self-Worth* 434

*Self-Determination* 437

*Relatedness* 441

Individual Differences in Motivation 442

*Need for Affiliation* 442

*Need for Approval* 443

*Need for Achievement* 443

*Dispositions* 445

Affect and Its Effects 446

*How Affect Is Related to Motivation* 447

*How Affect Is Related to Learning and Cognition* 448

*Anxiety* 450

Creating a Motivating Classroom Environment 455

SUMMARY 461

CHAPTER 17

---

Cognitive Factors in Motivation 462

Interests 462

*Effects of Interest* 463

*Factors Promoting Interest* 464

Expectancies and Values 464

*Effects of Expectancies and Values* 465

*Factors Influencing Expectancies and Values* 465

Goals 466

*Achievement Goals* 467

*Work-Avoidance Goals* 473

*Social Goals* 473

*Career Goals* 474

*Coordinating Multiple Goals* 475

Attributions 475

*Effects of Attributions* 478

*Factors Influencing the Nature of Attributions* 480

*Explanatory Style: Mastery Orientation versus Learned Helplessness* 485

Motivation, Affect, and Self-Regulation 488

*How Motivation and Affect Influence Self-Regulation* 488

*How Self-Regulation Influences Motivation and Affect* 488

*Internalized Motivation* 489

Encouraging Motivating Cognitions 491

*A TARGETS Mnemonic for Motivational Strategies* 498

SUMMARY 500

REFERENCES R-1

NAME INDEX NI-1

SUBJECT INDEX SI-1



# CHAPTER 1

---

## PERSPECTIVES ON LEARNING

*The Importance of Learning*

*Defining Learning*

*Determining When Learning Has Occurred  
Research, Principles, and Theories*

*How Theories of Learning Have Evolved over Time*

*Advantages of Theories*

*Potential Drawbacks of Theories*

*A Perspective on Theories and Principles*

*Applying Knowledge about Learning to Instructional  
Practice*

*Overview of the Book*

*Summary*

When my son Alex was in kindergarten, his teacher asked me *please* to do something about his shoes. I had been sending Alex off to school every morning with his shoelaces carefully tied, yet by the time he arrived at his classroom door, the laces were untied and flopping every which way—a state to which they invariably returned within 10 minutes of his teacher’s retying them. Although I had given Alex numerous shoe-tying lessons, the step-by-step procedure I had taught him never seemed to “stick.” I then suggested that we double-knot the laces each morning, but Alex rejected this strategy as too babyish. As an alternative, I purchased a couple of pairs of shoes with Velcro straps instead of laces, but Alex gave the shoes such a workout that the Velcro quickly separated itself from the leather. By March, the teacher, justifiably irritated that she had to retie my son’s shoes so often, insisted that Alex learn to tie them himself. So I sat down with him and demonstrated, for the umpteenth time, how to put two laces together to make a presentable bow. This time, however, I accompanied my explanation with a magical statement: “Alex, when you learn to tie your shoes, I’ll give you a quarter.” His eyes lit up, and he had shoe-tying perfected in 5 minutes. After that, we didn’t have a single complaint from school—well, not about his shoes anyway.

When my daughter Tina was in fourth grade, she experienced considerable difficulty and frustration with a series of homework assignments in subtraction. She had never learned the basic subtraction facts, despite my continually nagging her to practice them, the result being that she couldn’t solve many two- and three-digit subtraction problems. One night, after her typical half-hour tantrum about “these stupid problems,” my husband explained to Tina that subtraction was nothing more than reversed addition and that her knowledge of addition facts could help her with subtraction. Something must have clicked in Tina’s head, because we weren’t subjected to any more tantrums about subtraction. Multiplication and division continued to be problematic for her—and don’t get me started about the fractions that came a bit later—but at least she had unraveled the mystery of subtraction.

Human learning takes many forms. Some instances of learning are readily observable, such as when a child learns to tie shoes. Other instances are apt to lie below the surface, such as when a child gains a better understanding of mathematical principles. And people learn for many reasons. Some learn for the external rewards their achievements bring—for example, for good grades, recognition, or money. But others learn for less obvious, more internal reasons—perhaps to gain a sense of accomplishment and satisfaction, or perhaps simply to make life easier.

## THE IMPORTANCE OF LEARNING

---

Many species have things easy compared to human beings, or at least so it would seem. Birds, for instance, are born with a wealth of knowledge that we humans must learn. They seem to be biologically hardwired with home-building skills; we either have to be taught something about framing, roofing, and dry walling or must hire someone else to do these things for us. Birds know, without being taught, exactly when to fly south and how to get there; we have to look at our calendars and road maps. Birds instinctively know how to care for their young; meanwhile, we attend prenatal classes, read child-care books, and watch other people demonstrate how to change diapers.

Yet we human beings—not birds—are the ones getting ahead in this world. We have learned to make increasingly sturdy and comfortable homes, have developed increasingly expedient modes of transportation, and are feeding and caring for our offspring so well that each generation grows taller, stronger, and healthier than the previous one. Birds, meanwhile, are living the same primitive lifestyles they've had for centuries.

The ability to acquire a large body of knowledge and a wide variety of behaviors allows the human race a greater degree of flexibility and adaptability than is true for any other species on the planet. Because so little of our behavior is instinctive and so much of it is learned, we're able to benefit from our experiences. We discover which actions are likely to lead to successful outcomes and which are not, and we modify our behaviors accordingly. And as we pass on to children the wisdom we've gained from our ancestors and from our own experiences, each generation becomes just that much more capable of behaving intelligently.

To be sure, many nonhuman species learn a great deal over the course of their lifetimes. My dog Tobey has learned that his dinner is usually served around 4 o'clock and that having a leash attached to his collar means a walk is imminent. My cat Geisha has learned that her litter box is in the laundry room and that a loud hiss can effectively dissuade a human from picking her up when she isn't in the mood for cuddling. When I planted blueberry bushes outside my office window one summer, the neighborhood birds quickly discovered that the bushes were an abundant source of food and that the aluminum pie plates I hung to scare them away weren't actually going to harm them.

The more I observe and read about nonhuman animals, the more I become convinced that we humans greatly underestimate their intelligence and ability to learn. As an example, look at the painting in Figure 1.1. I watched 15-year-old Somjai paint it when I visited the Maetaman Elephant Camp in Thailand in 2006. Somjai clearly knows how to paint an elephant. What is most remarkable about this fact is that Somjai is an elephant. In 2006, Somjai was painting only pictures very similar to the one I show you here, but when I returned to the camp in 2008, he had expanded his repertoire considerably and could now also paint an elephant grabbing a tree branch or shooting a basketball into a basket (elephant basketball was big at the camp). And the asking price for Somjai's work had skyrocketed from 20 dollars (the price I paid in 2006) to 100 dollars. As this book goes to press, Somjai's paintings (all of elephants) are selling online for 600 to 700 dollars. (For examples of Somjai's and other elephants' artistic skills, go to the website for the Asian Elephant Art and Conservation Project at [www.elephantart.com](http://www.elephantart.com).)

There are limits to what nonhuman species can learn, however. For example, as Somjai paints, his trainer stands beside him, continually applying paint to his brush and using various

**Figure 1.1**  
Fifteen-year-old Somjai's painting  
of an elephant

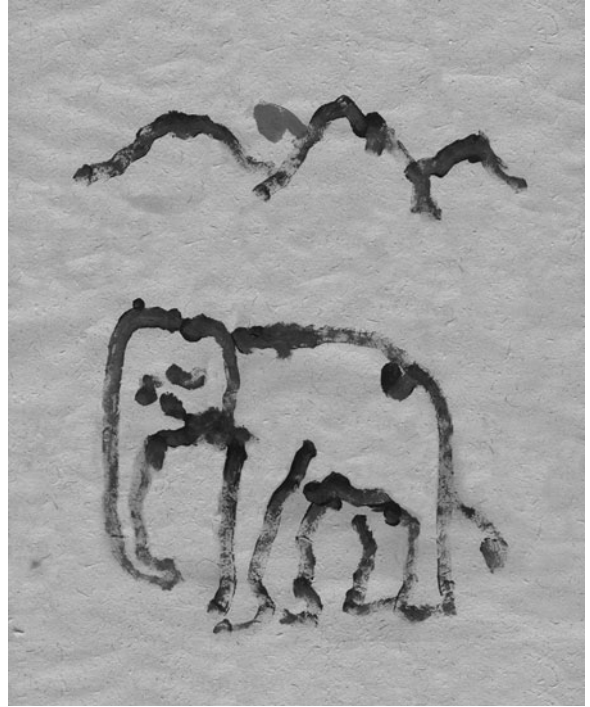

commands to guide his sequence of strokes. Furthermore, Somjai and one or two of his comrades paint only elephants (sometimes with a simple background, a tree, or a basketball hoop), and they typically depict the same side view of an elephant (e.g., Somjai always paints an elephant's left side). Several other elephants at the camp paint daisylike flowers, but they paint *only* daisylike flowers. A Google search for “elephant painting” on the Internet suggests to me that Somjai has a talent that's unusual in the elephant world. Many elephants apparently have little inclination for painting at all, and most of those that do can paint only random strokes on the canvas.

In contrast to Somjai and his peers at Maetaman, most human beings can paint not only elephants and flowers but an infinite number of other things as well, and by Somjai's age they can do so without anyone else's assistance. Painting is, for humans, not simply executing a specific sequence of brush strokes. Instead, people seem to be guided by internal “somethings”—perhaps a mental image of an elephant or flower, and probably some general strategies for representing physical entities on paper—and they can adapt those somethings at will to the task at hand.

Thus, we human beings seem to inherit an ability to think and learn in ways that nonhumans cannot. The particular environment in which we live has a huge impact on the knowledge and skills we do and don't acquire, of course, but our capacity to be versatile and to adapt to many *different* situations and environments far exceeds that of other species on the planet.

## DEFINING LEARNING

---

Alex's learning to tie his shoes and Tina's learning the addition–subtraction relationship are both examples of human learning. Consider these additional examples:

- The mother of an 8-year-old boy insists that her son take on some household chores, for which he earns a small weekly allowance. When saved for two or three weeks, the allowance enables the boy to purchase small toys of his own choosing. As a result, he develops an appreciation for the value of money.
- A college student from a small town is, for the first time, exposed to political viewpoints different from her own. After engaging in heated debates with classmates, she reflects on and gradually modifies her own political philosophy.
- A toddler is overly affectionate with a neighborhood dog, and the dog responds by biting the toddler's hand. After this incident, the child cries and runs quickly to his mother every time he sees a dog.

As you can see, learning is the means through which we acquire not only skills and knowledge, but also values, attitudes, and emotional reactions.

For purposes of our discussion, we'll define **learning** as a long-term change in mental representations or associations as a result of experience. Let's divide this definition into its three parts. First, learning is a *long-term change*: It isn't just a brief, transitory use of information—such as remembering a phone number long enough to call someone and then forgetting it—but it doesn't necessarily last forever. Second, learning involves *mental representations or associations* and so presumably has its basis in the brain. Third, learning is a change *as a result of experience*, rather than the result of physiological maturation, fatigue, use of alcohol or drugs, or onset of mental illness or dementia.

## DETERMINING WHEN LEARNING HAS OCCURRED

---

Many psychologists would agree with the definition of learning I've just presented. However, some would prefer that the focus be on changes in *behavior* rather than on changes in mental representations or associations (more on this point shortly). In fact, regardless of how we define learning, we know that it has occurred only when we actually see it reflected in a person's behavior. For example, we might see a learner:

- Performing a completely new behavior—perhaps tying shoes correctly for the first time
- Changing the frequency of an existing behavior—perhaps more regularly cooperating with (rather than acting aggressively toward or in some other way alienating) classmates
- Changing the speed of an existing behavior—perhaps recalling various subtraction facts more quickly than before
- Changing the intensity of an existing behavior—perhaps throwing increasingly outrageous temper tantrums as a way of obtaining desired objects
- Changing the complexity of an existing behavior—perhaps discussing a particular topic in greater depth and detail after receiving instruction about the topic
- Responding differently to a particular stimulus—perhaps crying and withdrawing at the sight of a dog after having previously been eager to interact with dogs

Throughout the book, we'll continue to see these and other approaches to assessing learning.

## RESEARCH, PRINCIPLES, AND THEORIES

---

Although psychologists may differ in their views of how best to define learning and determine when it has occurred, virtually all of them agree on one point: They can best understand the nature of learning by studying it objectively and systematically through research. The systematic study of behavior, including human and animal learning processes, has emerged only within the past century or so, making psychology a relative newcomer to scientific inquiry. But in a century's time, countless research studies have investigated how people and many other species learn.

Consistent patterns in research findings have led psychologists to make generalizations about learning processes through the formulation of both principles and theories of learning. **Principles** of learning identify certain factors that influence learning and describe the specific effects that these factors have. For example, consider this principle:

A behavior that is followed by a satisfying state of affairs (a reward) is more likely to increase in frequency than a behavior not followed by a reward.

In this principle, a particular factor (a reward that follows a behavior) is identified as having a particular effect (an increase in the behavior's frequency). The principle can be observed in many situations, including the following:

- A pigeon is given a small pellet of food every time it turns its body in a complete circle. It begins rotating in circles more and more frequently.
- Dolphins who are given fish for "speaking" in "dolphinsese" quickly become quite chatty.
- A boy who completes a perfect spelling paper and is praised for it by a favorite teacher works diligently for future success in spelling assignments.
- A textbook author who receives compliments when she wears her hair in a French braid styles her hair that way more and more often, especially when going to parties or other social events.

Principles are most useful when they can be applied to a wide variety of situations. The "reward" principle—many psychologists instead use the term *reinforcement*—is an example of such broad applicability: It applies to both humans and nonhuman animals and holds true for different types of learning and for a variety of rewards. When a principle such as this one is observed over and over again—when it stands the test of time—it is sometimes called a **law**.

**Theories** of learning provide explanations about the underlying mechanisms involved in learning. Whereas principles tell us *what* factors are important for learning, theories tell us *why* these factors are important. For example, consider one aspect of social cognitive theory (described in Chapter 6):

People learn what they pay attention to. A reward increases learning when it makes people pay attention to the information to be learned.

Here we have a possible explanation of why a reward affects learning: It increases attention, which in turn brings about learning.

Principles of learning tend to be fairly stable over time: Researchers observe many of the same factors affecting learning over and over again. In contrast, theories of learning continue to change as new research methods are devised, new research is conducted, and new research findings come to light.

## How Theories of Learning Have Evolved over Time

When psychologists first began to study learning in earnest in the late 1800s, the two dominant perspectives in psychology were *structuralism* (e.g., Wilhelm Wundt's work) and *functionalism* (e.g., John Dewey's writings). Although these two perspectives differed considerably in their underlying assumptions and topics of study, they shared a common weakness: They lacked a precise, carefully defined research methodology. The primary means of investigating learning and other psychological phenomena, especially for structuralists, was a method called *introspection*: People were asked to “look” inside their heads and describe what they were thinking.

In the early 1900s, some psychologists began to criticize the introspective approach for its subjectivity and lack of scientific rigor. Without more objective research methods, they argued, psychology as a discipline would never be considered a true science. They proposed that to study learning in an objective, scientific manner, theorists must focus on two things that can be observed and objectively measured: people's behaviors (*responses*) and the environmental events (*stimuli*) that precede and follow those responses. Since then, many psychologists have attempted to describe and understand learning and behavior primarily through an analysis of stimulus–response relationships. Such psychologists are called *behaviorists*, and their theories of learning are collectively known as **behaviorism**.

The behaviorist perspective has contributed immensely to our understanding of how people learn and how instructional and therapeutic environments might help them learn more effectively. Over the years, however, its limitations have become apparent. For example, early behaviorists believed that learning can occur only when learners actually behave in some way—perhaps when they make a response and experience the consequences of that response. But in the 1940s, some psychologists proposed that people can also learn a new behavior simply by watching and imitating what *other people* do (N. E. Miller & Dollard, 1941). This idea of *modeling* provided the impetus for an alternative perspective, **social learning theory**, that examined how people learn from observing those around them.

Behaviorism and social learning theory developed largely in North America. Meanwhile, many early-twentieth-century researchers in Europe took an entirely different tack, presenting situations and tasks that might reveal the nature of people's internal mental processes. For instance, beginning in the 1920s, Swiss researcher Jean Piaget documented numerous ways in which children's reasoning processes change as they grow older, and Russian psychologist Lev Vygotsky conducted studies about how children's social environment and culture can help them acquire more complex thinking skills. And in Germany, theorists known as **Gestalt** psychologists described a variety of intriguing findings related to such mental phenomena as human perception and problem solving.

Over time, as psychologists increasingly explored many different facets of human learning, it became clear that a study of behavior alone couldn't give us a complete picture of learning—that we had to take human thought processes, or *cognition*, into account as well. A very different perspective emerged—one known as **cognitive psychology** or, more simply, **cognitivism**—with objective, scientific methods for studying a wide variety of mental phenomena: perception, memory, problem solving, reading comprehension, and so on (e.g., Neisser, 1967). Social learning theorists, too, gradually incorporated cognitive processes into their explanations of learning, resulting in a perspective now more often referred to as **social cognitive theory**.

But even with a focus on cognition as well as behavior, we can't completely pinpoint the distinct advantage that we humans have over nonhuman animal species. Many nonhuman animals

are *thinking* creatures. For instance, several species (e.g., gorillas, chimpanzees, dolphins, elephants—remember Somjai?—and crows) can recognize themselves in a mirror, suggesting that they have a mental image of what they look like (S. T. Parker, Mitchell, & Boccia, 1994; Plotnik, de Waal, & Reiss, 2006; Prior, Schwarz, & Güntürkün, 2008). And crows are especially ingenious birds that can make rudimentary tools to get hard-to-reach food, and they plan ahead by stashing away what they don't immediately eat in locations that they can later remember (Emery & Clayton, 2004).

So how can we explain the human advantage in thinking and learning? For one thing, our physical “thinking” equipment—especially the upper part of the brain known as the cortex—is more complex than is true for other species. But in addition, thanks in part to our incredibly flexible language skills, we communicate and collaborate with one another to a much greater extent than other species do, and through the elaborate cultures we've created for ourselves and our communities, we consistently pass along what we've learned to successive generations (Tomasello & Herrmann, 2010). Building on Russian psychologist Lev Vygotsky's early ideas, in the past two or three decades some psychologists have developed theories about the critical roles that social interaction and culture play in human learning and cognitive development. Numerous labels have been applied to such interaction-and-culture-based perspectives; the most widely used label is **sociocultural theory**.

Figure 1.2 offers a graphic depiction of how various theories of learning have evolved over time. Be careful, however, that you don't interpret the boxes in the figure as depicting mutually exclusive entities. In contemporary psychology, many theorists draw from two or more theoretical perspectives—and sometimes draw from findings in neurology, anthropology, and other biological and social sciences as well—to better capture the complex nature of human thinking and learning (notice the two-way cross-communication arrows near the bottom of the figure). As we consider various aspects of human learning in the chapters ahead, we, too, will occasionally find it helpful to draw from two or more perspectives simultaneously.

## Advantages of Theories

Certainly the changeable nature of theories can be frustrating, in that we can never be confident that we have the ultimate truth—the real scoop—on how people learn. Yet it's precisely the dynamic nature of learning theories that enables us to gain an increasingly accurate understanding of a very complex, multifaceted phenomenon.

Theories have several advantages over principles. First, they allow us to summarize the results of many, many research studies and integrate numerous principles of learning. In that sense, theories are often quite concise (psychologists use the term *parsimonious*).

Second, theories provide starting points for conducting new research; they suggest research questions worthy of study. For example, if we theorize that rewards bring about learning because they increase a person's attention to whatever needs to be learned, we can make the following prediction:

When a particular situation or task draws an individual's attention to the information to be learned, learning occurs even in the absence of a reward.

In fact, this prediction has frequently been supported by research (e.g., Cermak & Craik, 1979; Faust & Anderson, 1967; T. S. Hyde & Jenkins, 1969).

Third, theories help us make sense of and explain research findings. Research conducted outside the context of a particular theoretical perspective can yield results that are trivial and

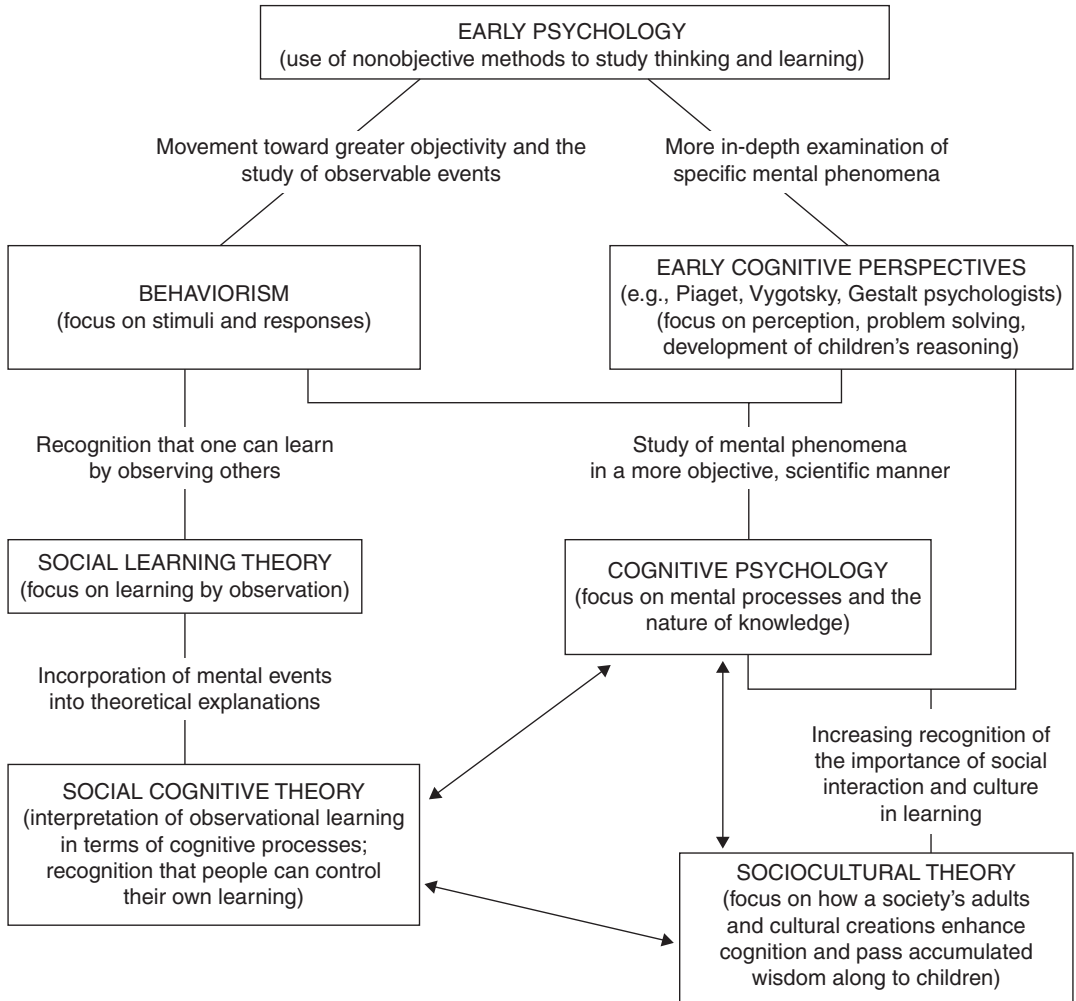

**Figure 1.2**  
Evolution of learning theories over time

nongeneralizable. Interpreted from a theoretical perspective, however, those same results can be quite meaningful. For example, consider an experiment by Seligman and Maier (1967). In this classic study, dogs were placed in individual cages and given a number of painful and unpredictable shocks. Some dogs were able to escape the shocks by pressing a panel in the cage, whereas others were unable to escape. The following day, the dogs were placed in different cages, and again shocks were administered. This time, however, each shock was preceded by a signal (a tone) that the shock was coming, and the dogs could avoid the shocks by jumping over a barrier as soon as they heard the tone. The dogs that had been able to escape the shocks on the preceding day learned to avoid the shocks altogether in this new situation, but the dogs that had been



unable to escape previously did *not* learn to avoid the shocks.<sup>1</sup> On the surface, this experiment, although interesting, might not seem especially relevant to human learning. Yet Seligman and his colleagues used this and other experiments to develop their theory of *learned helplessness*: People who learn that they have no control over unpleasant or painful events in one situation are unlikely, in later situations, to try to escape or avoid aversive events even when it's possible for them to do so. In Chapter 17, we'll look at learned helplessness more closely and incorporate it into a general theoretical framework known as *attribution theory*.

Theories have a fourth advantage as well: By giving us ideas about the mechanisms that underlie human learning and performance, they can ultimately help us design learning environments and instructional strategies that facilitate human learning to the greatest possible degree. For example, consider the teacher who is familiar with the theory that attention is an essential ingredient in the learning process. That teacher may identify and use a variety of approaches—perhaps providing interesting reading materials, presenting intriguing problems, and praising good performance—that are likely to increase students' attention to academic subject matter. In contrast, consider the teacher who is familiar only with the principle that rewarded behaviors are learned. That teacher may use certain rewards—perhaps small toys or trinkets—that are counterproductive because they draw students' attention to objects that are irrelevant to classroom learning tasks.

## Potential Drawbacks of Theories

Despite their advantages, theories also have two potential drawbacks. First, no single theory explains everything researchers have discovered about learning. Current theories of learning tend to focus on specific aspects of learning. For instance, behaviorist theories limit themselves primarily to learning that involves specific, observable responses; cognitive theories tend to focus on how individual learners interpret, integrate, and remember information; and sociocultural theories deal largely with how interpersonal processes and cultural legacies enter into the picture. Observed phenomena that don't fit comfortably within a particular theoretical perspective are apt to be excluded from that perspective.

Second, theories affect the new information that's published, thereby biasing the knowledge we have about learning. For example, imagine that several researchers propose a particular theory of learning and conduct a research study to support their ideas. They obtain results that are opposite to what they expected and thus cast doubt on their theory. If these researchers are fully committed to demonstrating that their theory is correct, they're unlikely to publish results that will indicate otherwise! In this way, theories may occasionally impede progress toward a truly accurate understanding of the learning process.

---

<sup>1</sup>If this “shocking” treatment of dogs upsets you—as it does me—be assured that researchers can no longer do whatever they wish to participants in their studies. They must now adhere to strict ethical guidelines regarding treatment of both humans and nonhuman animals in their research. Universities and other research institutions oversee research projects through Internal Review Boards (IRBs, for research with humans) and Institutional Animal Care and Use Committees (IACUCs, for research with nonhuman animal species).

## A Perspective on Theories and Principles

Most psychologists tend to align themselves with one perspective or another, and I, whose graduate training and research program have been rooted in cognitive traditions, am no exception. Yet I firmly believe that diverse theoretical perspectives all have important things to say about human learning and that all provide useful insights into how practitioners might help both adults and children learn effectively and behave productively. I hope that as you read this book, you'll take an equally open-minded approach. Keep in mind, too, that as research continues in the decades ahead, theories of learning will inevitably be revised to account for the new evidence that emerges, to the point where I must revise this book in significant ways every four or five years. In this sense, no single theory can be considered fact.

At the same time, you might think of learning principles as reflecting relatively enduring conclusions about cause-and-effect relationships in the learning process. The *reward* principle was introduced by Edward Thorndike in 1898 and has remained with us in one form or another ever since. Thorndike's original theory of *why* reward affects learning, however, has largely been replaced by other explanations.

Principles and theories alike help us predict the conditions under which successful learning is most likely to occur. To the extent that they're useful in this way, we're better off with them—imperfect and tentative as some of them may be—than without them.

## APPLYING KNOWLEDGE ABOUT LEARNING TO INSTRUCTIONAL PRACTICE

---

A great deal of learning takes place in a classroom context, and most of it is beneficial. For example, it's in the classroom that most students learn how to read and how to subtract one number from another. Unfortunately, students may also learn things at school that *aren't* in their best interests over the long run. For instance, although students may learn to read, they may also learn that the "best" way to remember what they read is to memorize it, word for word, without necessarily trying to understand it. And although students may learn their subtraction facts, they may also learn that mathematics is a boring or frustrating endeavor.

With human beings so dependent on their environment to acquire the knowledge and skills they'll need in order to become productive members of society, the learning that takes place in educational institutions—elementary schools, high schools, universities, and so on—cannot be left to chance. To maximize productive student learning, teachers must understand the factors that influence learning (principles) and the processes that underlie it (theories). They must also draw on research findings regarding the effectiveness of various instructional practices.

The principles, theories, and research I've included in the chapters ahead approach human learning from different, and occasionally seemingly contradictory, perspectives. Yet I hope you'll take an eclectic attitude as you read the book, resisting the temptation to choose one approach over others as being the "right" one. Different perspectives are applicable in different situations, depending on the environmental factors under consideration, the specific subject matter being learned, and the objectives of instruction. Furthermore, each perspective offers unique insights into how and why human beings learn and how instruction might be designed to enhance their learning. It's probably more helpful to think of theoretical perspectives in terms of their *usefulness* than in terms of their correctness.

As theories of learning continue to be revised and refined in the years to come, so, too, will instructional practices be revised and refined. In the meantime, we can use current theories to help people of all ages learn in increasingly effective and efficient ways.

## OVERVIEW OF THE BOOK

---

In our exploration of human learning, a good starting point is its physiological underpinnings, which we'll examine in Chapter 2. There we'll look at components of the human nervous system and consider where and how learning probably occurs in the brain. We'll also consider what brain research tells us—as well as what it *doesn't* tell us—about thinking, learning, and instruction in classroom settings.

In Part II of the book, we'll explore principles and theories of learning from the behaviorist perspective, focusing on relationships between environmental events (stimuli) and the behaviors (responses) that people acquire as a result of those events. We'll begin by examining the general assumptions of behaviorist theories (Chapter 3) and then explore in depth the two most prominent models of learning within the behaviorist perspective: classical conditioning (Chapter 3) and instrumental conditioning (Chapters 4 and 5).

In Part III (Chapter 6), social cognitive theory will help us make the transition from behaviorism to cognitivism. As you'll discover, social cognitive theory offers a nice blend of behaviorist and cognitive ideas regarding how and what people learn by observing others and also how, with the acquisition of self-regulation skills, most people increasingly gain control of their own behavior.

In Part IV, we'll turn to theories of learning that are almost entirely cognitive in nature. We'll look at several cognitive perspectives, both old and new, that have contributed to our understanding of how people think and learn (Chapter 7). We'll then examine in detail some of the mental processes involved in learning and memory (Chapters 8, 9, and 11) and the nature of the knowledge that such processes yield (Chapter 10).

In Part V, we'll examine learning and cognition from developmental, sociocultural, and contextual perspectives. There we'll look at the work of two groundbreaking developmental theorists—Swiss researcher Jean Piaget (Chapter 12) and Russian psychologist Lev Vygotsky (Chapter 13)—as well as at the work of contemporary researchers who have built on their ideas.

As we proceed to Part VI, we'll continue our exploration of cognitive theories by examining more complex aspects of human learning and cognition. Specifically, we'll look at how well people understand and regulate their own thinking processes—a phenomenon known as *metacognition*—and at how effectively people can apply what they've learned in one situation to new tasks and problems (Chapters 14 and 15).

Finally, in Part VII, we'll consider the role that motivation plays in learning. We'll look at motivation's effects on learning and behavior, consider some of the basic needs that human beings have, and consider how emotion (*affect*) is closely intertwined with both motivation and learning (Chapter 16). We'll also identify numerous cognitive factors that enter into and shape motivational processes (Chapter 17).

Throughout the book, we'll frequently identify educational implications of the principles and theories we are studying. I hope that once you've finished the final chapter, you'll be convinced, as I am, that psychology has a great deal to offer about how we can enhance teaching and learning both inside and outside the classroom.

## SUMMARY

Learning allows human beings a greater degree of flexibility and adaptability than is true for any other species. A definition that incorporates many psychologists' ideas about the nature of learning is this one: *a long-term change in mental representations or associations as a result of experience*. However, some psychologists prefer to define learning as a change in behavior rather than a mental change, and, in fact, we can be confident that learning has occurred only when we *do* see a behavior change of some kind.

An accurate, dependable understanding of the nature of human learning can emerge only by

studying learning through objective, systematic research. Consistent patterns in research findings have led psychologists to formulate both *principles* (descriptions of what factors affect learning) and *theories* (explanations of why those factors have the effects they do) about learning. Principles tend to be fairly stable over time, whereas theories continue to evolve as new research findings are reported. Effective teachers and other practitioners draw on a wide variety of research findings, principles, and theoretical perspectives as they design and implement instruction.

## CHAPTER 2

---

# LEARNING AND THE BRAIN

### *Basic Building Blocks of the Human Nervous System*

*Neurons*

*Synapses*

*Glial Cells*

### *Brain Structures and Functions*

*Methods in Brain Research*

*Parts of the Brain*

*The Left and Right Hemispheres*

*Interconnectedness of Brain Structures*

### *Development of the Brain*

*Prenatal Development*

*Development in Infancy and Early Childhood*

*Development in Middle Childhood, Adolescence,  
and Adulthood*

*Factors Influencing Brain Development*

*To What Extent Are There Critical Periods in  
Brain Development?*

*To What Extent Is the Brain “Prewired” to Know  
or Learn Things?*

*The Physiological Basis of Learning*

*Educational Implications of Brain Research*

*Summary*

Someone in my family has a broken brain; to protect his privacy, I'll simply call him Loved One. As a child, Loved One was in most respects quite normal: He did well in school, spent after-school hours playing typical “boy” games with his friends, and often traveled to places near and far with his parents and siblings. People who knew him described him as smart, sweet, and sensitive. But even then, there were, perhaps, little cracks in his brain. For one thing, he had trouble delaying gratification: He always wanted things now, now, now. And he made many poor choices in his daily decision making—for example, leaving a pet turtle unattended on his bed (leading to a fatal fall) and smashing unwanted toys on the back patio using a hammer that left huge smash marks on the patio itself.

When Loved One was 17 years old, something went seriously wrong. Despite curfews and significant consequences for ignoring them, he would stay out until the wee hours of the morning; sometimes he didn't return home until the middle of the next day. He became increasingly hostile and defiant, and his parents found him impossible to reason with. He often refused to get out of bed to go to school. His grades plummeted, and by December of his senior year it was clear that he wouldn't have enough credits to graduate with his high school class. In January, his out-of-control behavior landed him in a juvenile detention center. While awaiting trial, he became increasingly lethargic until eventually he could barely move: He wouldn't eat and didn't seem able to walk or talk. When, on the day of his trial, he was brought into the courtroom in a wheelchair—awake but unresponsive—the judge remanded him to the state mental hospital.

Loved One has been diagnosed as having *bipolar disorder*, a condition characterized by periods of elation and intense activity (mania) followed by periods of deep sadness and lethargy (depression). Particularly during the manic periods, Loved One has **psychosis**: His thinking is impaired to the point that he cannot function normally. He seems unable to reason, make appropriate decisions, or control his impulses. Furthermore, he often has auditory hallucinations, hearing voices that aren't there. Such psychotic symptoms are often seen in another serious mental illness, *schizophrenia*, as well.

Medication does wonders for Loved One: It calms him down, clears his thoughts, gives him back his impulse control, and helps him appropriately interpret and respond to events in his daily life. Medication has enabled him to acquire his graduate equivalency diploma (GED) and earn B's in occasional classes at a local community college. But like many people with mental illness, Loved One doesn't always stay on his medication. When he doesn't, his brain goes haywire and his behaviors land him in jail and, if he's lucky, back in the hospital. Loved One typically remembers very little of what he does or what happens to him when he's psychotic. Maybe that's just as well.

The human brain is an incredibly complex mechanism, and researchers have a long way to go in understanding how it works and why it doesn't always work as well as it should. Yet they've made considerable progress in the past few decades, and their knowledge about brain anatomy and physiology grows by leaps and bounds every year.

In this chapter, we'll look at the biological underpinnings of thinking and learning. We'll begin by putting the basic building blocks of the human nervous system under the microscope. We'll then examine various parts of the brain and the functions that each appears to have. Later, we'll trace the brain's development over time (at that point we'll speculate about why Loved One's brain broke down when it did) and look at theorists' beliefs about the physiological basis of learning. Finally, we'll consider what educational implications we can draw—as well as what implications we *cannot* draw—from current knowledge and research about the brain. As we address these topics, we'll discredit some common myths about the brain that currently run rampant in educational literature.

## BASIC BUILDING BLOCKS OF THE HUMAN NERVOUS SYSTEM \_\_\_\_\_

The human nervous system has two main components. The **central nervous system**, comprising the brain and spinal cord, is the coordination center: It connects what we sense (e.g., what we see, hear, smell, taste, and feel) with what we do (e.g., how we move our arms and legs). The **peripheral nervous system** is the messenger system: It carries information from *receptor cells*—cells specialized to detect particular kinds of stimulation from the environment (e.g., light, sound, chemicals, heat, pressure)—to the central nervous system, and it carries directions back to various body parts (muscles, organs, etc.) about how to respond to that stimulation.

Nerve cells, or **neurons**, provide the means through which the nervous system transmits and coordinates information. Curiously, however, neurons don't directly touch one another; they send chemical messages to their neighbors across tiny spaces known as **synapses**. Furthermore, neurons rely on other cells, known as **glial cells**, for structure and support. Let's briefly look at the nature of each of these key elements of the nervous system.

### Neurons

Neurons in the human body play one of three roles. **Sensory neurons** carry incoming information from receptor cells. They convey this information to **interneurons**, which integrate and interpret input from multiple locations. The resulting “decisions” are transmitted to **motor neurons**, which send messages about how to behave and respond to appropriate parts of the body.<sup>1</sup>

---

<sup>1</sup>You may sometimes see the terms *receptor neurons*, *adjuster neurons*, and *effector neurons* used for sensory neurons, interneurons, and motor neurons, respectively.

As you might guess, sensory neurons and motor neurons are located in the peripheral nervous system. The vast majority of interneurons—about *one hundred billion* of them—are found in the central nervous system, especially in the brain (C. S. Goodman & Tessier-Lavigne, 1997; D. J. Siegel, 1999). Because neurons are brownish-grayish in color, they are sometimes collectively known as *gray matter*.

Neurons vary in shape and size, but all of them have several features in common (see Figure 2.1). First, like all cells, they have a cell body, or **soma**, that contains the cell's nucleus and is responsible for the cell's health and well-being. In addition, they have a number of branchlike structures, known as **dendrites**, that receive messages from other neurons. They also have an **axon**, a long, armlike structure that transmits information to additional neurons (occasionally, a neuron has more than one axon). The end of the axon may branch out numerous times, and the ends of its tiny branches have **terminal buttons**, which contain certain chemical substances (more about these substances shortly). For some (but not all) neurons, much of the axon is covered with a white, fatty substance known as a **myelin sheath**.

When a neuron's dendrites are stimulated by other cells (either receptor cells or other neurons), the dendrites become electrically charged. In some instances, the charges are so small that the neuron “ignores” them. But when the charges reach a certain level (known as the **threshold of excitation**), the neuron fires, sending an electrical impulse along its axon to the terminal buttons. If the axon has a myelin sheath, the impulse travels quite rapidly: The electrical message jumps from one gap in the myelin to the next, almost as if it were playing leapfrog. If the axon doesn't have a myelin sheath, the impulse travels more slowly.

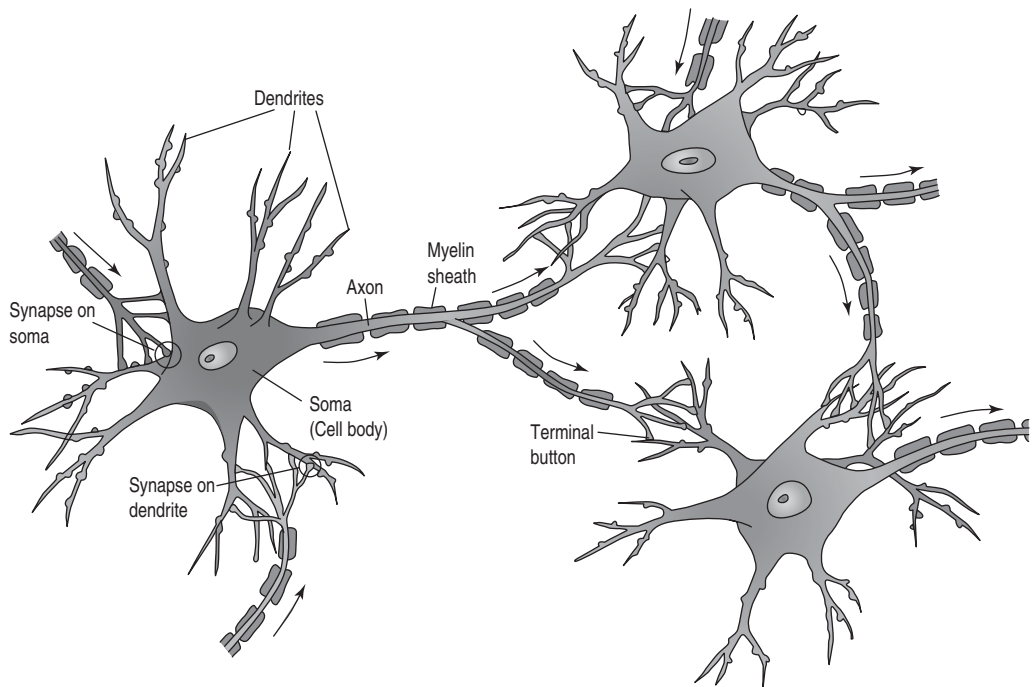

**Figure 2.1**  
The nature of neurons and their interconnections

## Synapses

The branching ends of a neuron's axon reach out to—but don't quite touch—the dendrites (in some cases, the somas) of other neurons. Whereas transmission of information within a neuron is electrical, transmission of information from one neuron to another is chemical. When an electrical impulse moves down a neuron's axon, it signals the terminal buttons to release chemicals known as **neurotransmitters**. These chemicals travel across the synapses and stimulate the dendrites or somas of neighboring neurons.

Different neurons specialize in different kinds of neurotransmitters. Perhaps in your readings about health, fitness, or related topics, you've seen references to dopamine, epinephrine, norepinephrine, serotonin, amino acids, or peptides. All of these are neurotransmitters, and each of them may play a unique role in the nervous system. For instance, dopamine is a key neurotransmitter in the frontal lobes of the cortex, which, as you'll discover shortly, are actively involved in consciousness, planning, and the inhibition of irrelevant behaviors and ideas (Goldman-Rakic, 1992; M. I. Posner & Rothbart, 2007). Some evidence indicates that schizophrenia and other serious psychiatric disorders are sometimes the result of abnormal dopamine levels (Barch, 2003; Clarke, Dalley, Crofts, Robbins, & Roberts, 2004; E. Walker, Shapiro, Esterberg, & Trotman, 2010). (Recall Loved One's difficulties with decision making and impulse control.)

Any single neuron may have synaptic connections with hundreds or thousands of other neurons (C. S. Goodman & Tessier-Lavigne, 1997; Lichtman, 2001; Mareschal et al., 2007). Some neurotransmitters increase the level of electrical activity in the neurons they stimulate, whereas others inhibit (i.e., decrease) the level of electrical activity. Whether a particular neuron fires, then, is the result of how much it is “encouraged” and “discouraged” by its many neighbors.

## Glial Cells

Only about 10% of the cells in the brain are neurons. Accompanying neurons are perhaps one to five trillion glial cells (also known as *neuroglia*), which are whitish in color and thus collectively known as *white matter*. All of that seemingly empty space between the neurons depicted in Figure 2.1 isn't empty at all; it's chock-full of glial cells of various shapes and sizes.

Glial cells appear to serve a variety of specialized functions (Koob, 2009; Oberheim et al., 2009). Some are “nutritionists” that control blood flow to neurons, “doctors” that tend to infections and injuries, or “clean-up crew” that clear away unwanted garbage in the brain. Others provide the myelin sheath of which I just spoke—that axon coating enhancing the efficiency of many neurons. And a great many of them appear to play a direct and critical role in learning and memory, as you'll discover later in the chapter.

In the human brain, these basic building blocks—neurons, synapses, and glial cells—make it possible for us to survive (e.g., by breathing and sleeping), to identify the stimuli we encounter (e.g., recognizing a friend or the family pet), to feel emotion (e.g., becoming afraid when we encounter danger), and to engage in the many conscious thought processes (e.g., reading, writing, solving mathematical problems) that are distinctly human.

## BRAIN STRUCTURES AND FUNCTIONS

---

In some instances, sensory neurons connect directly with motor neurons in the spinal cord, enabling an automatic response, or **reflex**, that involves no thought whatsoever. For example, if you touch something very hot, the sensory neurons traveling from your fingertips up your arm and into your



spinal cord tell the motor neurons traveling back to your arm and hand muscles to quickly pull your fingers away. Although your brain certainly perceives the heat you've encountered, your spinal cord enables you to remove yourself from danger before your brain deliberates on the situation at all.

For the most part, however, information from the outside world travels to the brain, which then decides whether and how to respond. Given the sheer number of cells in the brain—several trillion of them altogether—along with their microscopic size and innumerable interconnections, researchers have faced quite a challenge in figuring out how the brain works and what parts serve what functions. They've made considerable progress nevertheless.

## Methods in Brain Research

In their work, brain researchers have had several methodologies at their disposal:

- *Studies with animals.* Some researchers take liberties with animals (e.g., laboratory rats) that they would never take with human beings. For instance, they may remove a certain part of an animal's brain, insert a tiny needle into a certain location and electrically stimulate it, increase the levels of certain hormones, or inject chemicals that block certain neurotransmitters. They then observe changes in the animal's behavior and assume that these changes reflect the functions that particular brain structures, hormones, or neurotransmitters serve.
- *Postmortem studies.* Some people may, while living, agree to donate their brains for scientific study upon their deaths. Others may donate the brains of recently deceased family members for whom they are the legal next-of-kin. By examining the brains of children and adults of varying ages, researchers can determine typical human brain structures and how brain anatomy may change with development.
- *Case studies of people with brain injuries and other pathological conditions.* Researchers take detailed notes about what people with brain injuries or certain pathologies (e.g., schizophrenia, dyslexia) can and cannot do. After death, they examine the individuals' brains to identify areas of abnormality (e.g., specific sites of an injury, abnormal brain structures). If the absence of certain abilities is consistently associated with certain brain abnormalities, researchers reasonably conclude that the affected brain areas play a key role in those missing abilities.
- *Electrical recording.* Researchers place electrodes at strategic locations on a person's scalp and record patterns of electrical activity in the brain. The resulting record, known as an *electroencephalograph (EEG)*, tends to show different patterns of brain waves for different activities (e.g., for sleep versus wakefulness). Often researchers collect EEG data as people perform specific tasks, yielding *event-related potentials (ERPs)* that provide some indication of the nature of the brain activity occurring during those tasks.
- *Neuroimaging.* Using a variety of recent technological advances, researchers take pictures of blood flow or metabolism rates in various parts of the brain as people perform a particular task. Common techniques are positron emission tomography (PET), single-photon emission computerized tomography (SPECT), computerized axial tomography (CAT), magnetic resonance imaging (MRI), and functional magnetic resonance imaging (fMRI). Presumably, areas of greater blood flow or metabolism rates reflect areas of the brain that contribute in significant ways to the task in question.

None of these methods is perfect. Laboratory rats don't have many of the sophisticated cognitive abilities that humans do. Postmortem studies of normal human brains reveal an overall decline

in the number of synapses in middle childhood and adolescence (more about this point later), but they don't tell us to what degree children also form *new* synapses as they grow. Brain injuries may simultaneously affect multiple regions of the brain. Electroencephalographs don't tell us precisely where particular thought processes are occurring. And neuroimaging involves expensive diagnostic equipment with only limited availability for basic research. Nevertheless, taken together, research using these techniques is helping scientists identify and assemble some of the pieces of the puzzle about how the human brain works and develops.

## Parts of the Brain

The human brain includes a number of distinct structures that have somewhat different functions; structures especially pertinent to our discussion in this chapter are shown in Figure 2.2. Together these structures comprise three major components of the brain, which have emerged at different points along our evolutionary journey. The **hindbrain**, located in the lower part of the brain where the spinal cord enters the skull, appeared first in evolution and appears first in prenatal development. Made up of several smaller structures (e.g., the medulla, pons, and cerebellum), the hindbrain is involved in many basic physiological processes that keep us alive (breathing, swallowing, sleeping, regulating heart rate, etc.). The cerebellum, at the lower rear of the brain, is actively involved in balance and complex motor behaviors (e.g., walking, riding a bicycle, playing racquetball).

Next in both evolutionary and prenatal development is the **midbrain**, which plays supporting roles in vision and hearing (e.g., helping to control and coordinate eye movements). Probably the most essential part of the midbrain is the **reticular formation** (also called the *reticular activating system*, or RAS), which extends into the hindbrain as well. The reticular formation is a key player in attention and consciousness; for example, it alerts us to potentially important stimuli that the body's receptors are encountering.

Last to come along is the **forebrain**, located in the front and upper portions of the brain. The forebrain is where most complex mental activities take place in primate species, especially human beings. Resting on top, like a thick, lumpy toupee, is the **cerebral cortex**—often simply called the **cortex**—which is divided into two halves (**hemispheres**) that, on the surface, appear to be

**Figure 2.2**

Key parts of the brain: The figure shows a vertical slice of the middle of the brain; hence, the right and left sides of the cortex are missing.

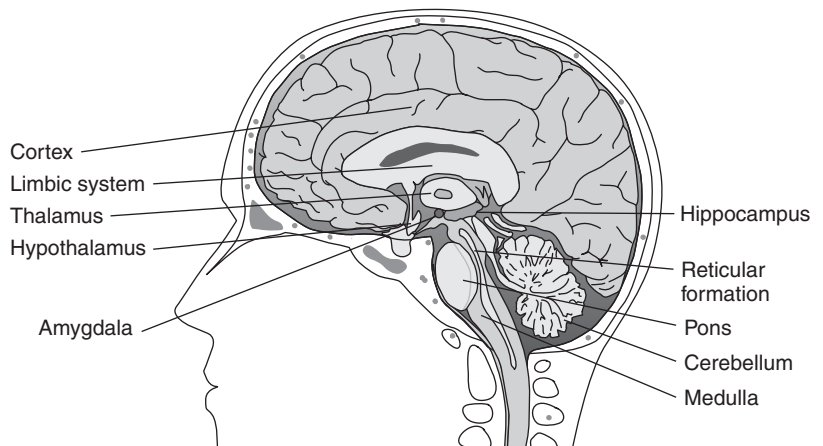

**Figure 2.3**  
Side view of the cortex

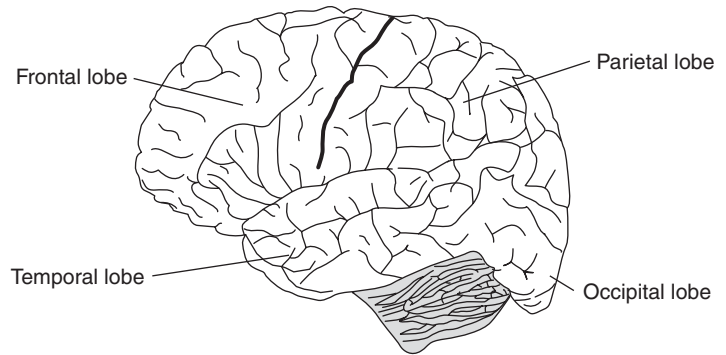

mirror images of each other. Neurologists conceptualize the hemispheres of the cortex as having four major parts, or *lobes*, named after the parts of the skull that cover them (see Figure 2.3):

- *Frontal lobes.* Located at the front and top of the cortex, the frontal lobes are where much of our conscious thinking seems to occur. The frontal lobes are largely responsible for a wide variety of complex human activities, including language, sustained attention, planning, reasoning, problem solving, self-regulation, deliberately controlled body movements, and interpretation of other people's behaviors. In addition, the frontal lobes are instrumental in inhibiting irrelevant and inappropriate thoughts and actions. The very front of the frontal lobes—a section known as the **prefrontal cortex**, located immediately behind the forehead—is especially important in conscious, controlled thinking. (I suspect that much of Loved One's illness involves malfunctioning of his prefrontal cortex.)
- *Parietal lobes.* Located in the upper back portion of the cortex, the parietal lobes receive and interpret somatosensory information—that is, information about temperature, pressure, texture, and pain. These lobes are also actively involved in paying attention, processing word sounds, and thinking about the spatial characteristics of objects and events.
- *Occipital lobes.* Located at the very back of the brain, the occipital lobes have major responsibility for interpreting and remembering visual information.
- *Temporal lobes.* At the sides, behind the ears, are the temporal lobes, which interpret and remember complex auditory information (e.g., speech, music). The temporal lobes also appear to be important in memory for information over the long run (something we'll later call *long-term memory*), especially for concepts and general world knowledge.

In some cases, researchers have pinned down fairly specific regions of the cortex in which certain kinds of processing seem to occur. But many areas of the cortex aren't so clearly specialized. These areas, known as *association areas*, appear to integrate information from various parts of the cortex, as well as from other parts of the brain, and thus are essential for complex thinking and behavior.

Inside and below the cortex are several other parts of the forebrain. Following are some especially noteworthy ones:

- *Limbic system.* Closely connected with the cortex is a cluster of structures, collectively known as the limbic system, that are essential to learning, memory, emotion, and motivation. A small structure known as the *hippocampus* (Greek for “seahorse,” which it loosely resembles) is intimately involved in attention and learning, especially for things that we

consciously (rather than unconsciously) learn and remember. Another structure, the *amygdala*, figures prominently in emotions (especially unpleasant ones such as fear, stress, anger, and depression) and in automatic emotional reactions (e.g., aggression). Furthermore, the amygdala enables us to associate particular emotions with particular stimuli or memories (Adolphs & Damasio, 2001; Cahill et al., 1996; Phelps & Sharot, 2008).<sup>2</sup>

- *Thalamus*. The thalamus, located in the very middle of the brain, serves as a “switchboard operator” that receives incoming information from various sensory neurons and sends it on to appropriate areas of the cortex. It also plays a role in arousal, attention, and fear.
- *Hypothalamus*. Located beneath the thalamus, the hypothalamus regulates many activities related to survival, such as breathing, regulating body temperature, feeling hunger and thirst, mating, fighting, and fleeing from harm.

## The Left and Right Hemispheres

To some degree, the left and right hemispheres have different specialties. Curiously, the left hemisphere is largely responsible for controlling the right side of the body, and vice versa. For most people, the left hemisphere seems to be in charge of language, with two particular areas, known as Broca’s area and Wernicke’s area, being major players in speech production and language comprehension, respectively. Reading and mathematical calculation skills also seem to be heavily dependent on the left hemisphere. In contrast, the right hemisphere is more dominant in visual and spatial processing, such as locating objects in space, perceiving shapes, estimating and comparing quantities, drawing and painting, mentally manipulating visual images, recognizing faces and facial expressions, and interpreting gestures. In general, the left side is more apt to handle details, whereas the right side is better suited for looking at and synthesizing an overall whole (Booth, 2007; Byrnes, 2001; R. Ornstein, 1997; D. J. Siegel, 1999; M. S. C. Thomas & Johnson, 2008).

Yet contrary to a popular myth, people rarely, if ever, think exclusively in one hemisphere; there’s no such thing as “left-brain” or “right-brain” thinking. The two hemispheres are joined together by a collection of neurons (the *corpus callosum*) that enable constant communication back and forth, and so the hemispheres typically collaborate in day-to-day tasks. Let’s take language comprehension as an example. The left hemisphere handles such basics as syntax and word meanings, but it seems to interpret what it hears and reads quite literally. The right hemisphere is better able to consider multiple meanings and take context into account; hence, it’s more likely to detect sarcasm, irony, metaphors, and puns (Beeman & Chiarello, 1998; Goel et al., 2007; R. Ornstein, 1997). Without your right hemisphere, you’d find no humor in the following joke, which I’ve seen in several variations on the Internet:

A woman gives birth to identical twin boys. Because she and her husband have very little money, they regretfully give up their babies for adoption. A Spanish couple adopts one baby and names him Juan. An Egyptian couple adopts the other and names him Amal. Several years later the Spanish couple sends the woman a picture of Juan.

“Ah,” the woman says wistfully, “I wish I had a picture of Amal as well.”

“But honey,” her husband responds, “they’re identical twins. If you’ve seen Juan, you’ve seen Amal.”

<sup>2</sup>Although Figure 2.2 shows only one hippocampus and one amygdala, the human brain has two of each, which are located on opposite sides of the brain.

The joke works only if you recognize that it's a twist of the common expression "If you've seen one, you've seen them all"—a connection you're most likely to make in your right hemisphere.

About 80% of human beings have left and right hemispheres that are specialized in the ways I've just described. For instance, the left hemisphere is the primary language hemisphere for more than 90% of right-handed individuals but for only about 60% of left-handed folks. People differ, too, in how hemispherically lopsided their thinking is: Whereas some often rely predominantly on one hemisphere or the other (depending on the circumstances), others regularly think in a fairly balanced, two-sided manner (R. Ornstein, 1997; D. J. Siegel, 1999).

As you can see, then, functions of some areas of the brain (especially in the cortex) are hardly set in stone. Occasionally, one area may take over a function that another area typically serves. For example, if, before age 1, children sustain damage to the left hemisphere or have part of their left hemisphere surgically removed (perhaps to address severe epileptic seizures), the right hemisphere steps in and enables the children to acquire normal language capabilities. Furthermore, different areas of the cortex may take on different roles as a result of what specific stimuli and tasks present themselves while a particular part of the cortex is actively changing and maturing (Beeman & Chiarello, 1998; Doidge, 2007; D. L. Mills & Sheehan, 2007; R. Ornstein, 1997; Stiles & Thal, 1993).

## Interconnectedness of Brain Structures

As you may have noticed in our earlier discussion of various brain structures, many aspects of daily functioning—for instance, attention, learning, memory, and motor skills—are handled in multiple places. And as you just discovered, the two hemispheres usually work together to understand and respond to the world. Remember, too, that any single neuron is apt to have hundreds of synapses (or more) with other neurons. As information travels through the brain, messages go every which way—not only from “lower down” in the processing system (i.e., at points where sensory information first reaches the brain) to “higher up” (i.e., at points where information is synthesized and interpreted or where behaviors are chosen and controlled) but also in the opposite direction and across areas that handle very different sensory modalities and motor functions. In essence, learning or thinking about virtually anything—even a single word—tends to be *distributed* across many parts of the brain (Bressler, 2002; M. I. Posner & Rothbart, 2007; Rayner, Foorman, Perfetti, Pesetsky, & Seidenberg, 2001; Thelen & Smith, 1998).

How does such a complex, interconnected mechanism—the human brain—come into being? Mother Nature's handiwork is quite a marvel. We look now at how the brain emerges and changes over the course of development.

## DEVELOPMENT OF THE BRAIN

---

A second widespread myth about the brain is that it fully matures within the first few years of life and that its development can best be nurtured by bombarding it with as much stimulation as possible—reading instruction, violin lessons, art classes, and so on—before its owner ever reaches kindergarten. Nothing could be further from the truth. Although much of the brain's development occurs before birth and the first few years after birth, the brain continues to develop throughout childhood, adolescence, and early adulthood. The early years are important, to be sure, but the kinds of experiences that nurture the brain's early development are fairly normal ones.

## Prenatal Development

About 25 days after conception, the brain first emerges as a tiny tube. The tube grows longer and begins to fold inward to make pockets (Rayport, 1992). Three chambers appear, and these eventually become the forebrain, midbrain, and hindbrain. Neurons quickly form and reproduce in the inner part of the tube; between the 5th and 20th weeks of prenatal development, they do so at the astonishing rate of 50,000 to 100,000 new cells per second (M. Diamond & Hopson, 1998). The vast majority of the neurons a person will ever have—but apparently not all of them—are formed at this time (Bruer, 1999; C. A. Nelson, Thomas, & de Haan, 2006; R. A. Thompson & Nelson, 2001).

In the second trimester of prenatal development, the neurons migrate to various locations, drawn by a variety of chemicals and supported in their journeys by glial cells. On their arrival, they send out dendrites and axons in an effort to connect with one another. Those that make contact survive and begin to take on particular functions, whereas those that don't (about half of them) tend to die off (M. Diamond & Hopson, 1998; Goldman-Rakic, 1986; Huttenlocher, 1993). Such deaths are not to be mourned, however. Programming human beings to overproduce neurons is apparently Mother Nature's way of ensuring that the brain will have a sufficient number with which to work. The excess ones are unnecessary and can quite reasonably be cast aside.

## Development in Infancy and Early Childhood

Between birth and age 3, the brain more than triples in size, with much of the increase being due to a rapid proliferation of glial cells (Koob, 2009; Lenroot & Giedd, 2007). The cerebral cortex is the least mature part of the brain at birth, and cortical changes that occur in infancy and early childhood probably account for many of the advancements we see in children's thinking, reasoning, and self-control (M. A. Bell, Wolfe, & Adkins, 2007; M. I. Posner & Rothbart, 2007; Quartz & Sejnowski, 1997).

Several significant processes characterize brain development in the early years: synaptogenesis, differentiation, synaptic pruning, and myelination.

### *Synaptogenesis*

Neurons begin to form synapses well before birth. But shortly after birth, the rate of synapse formation increases dramatically. Neurons sprout new dendrites that go every which way, and so they come into contact with a great many of their neighbors. Thanks to this process of **synaptogenesis**, young children have many more synapses than adults do. Eventually, the rapid proliferation of synapses comes to a halt. Exactly when it does so varies for different parts of the brain; for instance, synapses reach their peak in the auditory cortex (temporal lobes) at about 3 months, in the visual cortex (occipital lobes) at about 12 months, and in the frontal lobes at age 2 or 3 (Bauer, DeBoer, & Lukowski, 2007; Bruer, 1999; Byrnes, 2001; Huttenlocher, 1979, 1990).

### *Differentiation*

As neurons form synapses with one another, they also begin to take on particular functions (McCall & Plemons, 2001; Neville & Bruer, 2001). Through this process, known as **differentiation**, neurons become specialists, assuming some duties and steering clear of others.

### ***Synaptic Pruning***

As children encounter a wide variety of stimuli and experiences in their daily lives, some synapses come in quite handy and are used repeatedly. Other synapses are largely irrelevant and useless, and these gradually disintegrate—a process known as **synaptic pruning**. In fact, the system seems to be set up to *guarantee* that synaptic pruning occurs. Neurons require chemical substances known as *trophic factors* for their survival and well-being, and by transmitting messages to other neurons, they cause the recipients to secrete such chemicals. If neurons regularly receive trophic factors from the same sources, they form stable synapses with those sources. If they receive trophic factors from some neurons but not others, they pull their axons away from the “unsupportive” ones. And if neurons are so “unstimulating” that they rarely excite any of their neighbors, they may wither and die (Byrnes, 2001). In some areas of the brain, the period of intensive synaptic pruning occurs fairly early (e.g., in the preschool or early elementary years); in other areas, it begins later and continues until well into adolescence (Bauer et al., 2007; Bruer, 1999; Huttenlocher & Dabholkar, 1997).

Why do our brains create a great many synapses, only to eliminate a sizable proportion of them later on? In the case of synapses, more isn't necessarily better (Byrnes, 2001; C. A. Nelson et al., 2006). Theorists speculate that by generating more synapses than we'll ever need, we have the potential to adapt to a wide variety of conditions and circumstances. As we encounter certain regularities in our environment, we find that some synaptic connections are counterproductive because they aren't consistent with what we typically encounter in the world or with how we typically need to respond to it. In fact, effective learning and behaving require not only that we think and do certain things but also that we *not* think or do *other* things—in other words, that we inhibit certain thoughts and actions (Dempster, 1992; Haier, 2001). Synaptic pruning, then, may be Mother Nature's way of making our brains more efficient.

### ***Myelination***

As noted earlier, a neuron's axon is in some cases covered with a myelin sheath, which greatly speeds up the rate with which an electrical charge travels along the axon. When neurons first form, they have no myelin; this substance arrives a bit later, courtesy of glial cells. The process of coating neural axons, known as **myelination**, occurs gradually over time. Some myelination begins near the end of the prenatal period (e.g., this is true in certain areas necessary for basic survival), but much of it occurs in the first few years after birth, with different areas becoming myelinated in a predictable sequence (M. Diamond & Hopson, 1998). Without doubt, myelination enhances the brain's capacity to respond to the world quickly and efficiently.

## **Development in Middle Childhood, Adolescence, and Adulthood**

Especially in the cortex, synaptic pruning continues into the middle childhood and adolescent years, and myelination continues into the twenties or beyond (Bauer et al., 2007; Merzenich, 2001; Steinberg, 2009). Several parts of the brain—notably the frontal and temporal lobes, hippocampus, amygdala, and corpus callosum, all of which play key roles in thinking and learning—increase significantly in size from middle childhood until late adolescence or adulthood (Giedd et al., 1999a; Lenroot & Giedd, 2007; Sowell & Jernigan, 1998; E. F. Walker, 2002). The frontal lobes show evidence of considerable maturation during late adolescence and early adulthood, possibly enabling increasing facility in such areas as attention, planning,

and impulse control (Luna & Sweeney, 2004; Sowell, Thompson, Holmes, Jernigan, & Toga, 1999; Steinberg, 2009).

With puberty come changes in young people's hormone levels (e.g., estrogen, testosterone), and these hormones affect the continuing maturation of brain structures and possibly the production and effectiveness of neurotransmitters as well (Bauer et al., 2007; Kolb, Gibb, & Robinson, 2003; E. F. Walker, 2002). The levels of some neurotransmitters change at puberty; for instance, serotonin decreases and dopamine increases in some areas of the cortex (E. F. Walker, 2002). If a particular hormone or neurotransmitter is abnormally high or low at this point, something can go seriously awry in brain functioning.

Recall how Loved One's symptoms, which were minor in his early years, intensified in high school. In most cases, bipolar disorder and schizophrenia don't appear until adolescence or early adulthood. Such disorders seem to be caused, at least in part, by abnormal brain structures or neurotransmitter levels—abnormalities that don't emerge, or at least don't have much effect, until after puberty (Benes, 2007; N. R. Carlson, 1999; Giedd et al., 1999b; Jacobsen et al., 1997a, 1997b).

## Factors Influencing Brain Development

Heredity certainly plays a role in brain development, guiding such processes as cell migration, synaptogenesis, and myelination. For the most part, heredity ensures that things go right as the brain continues to grow and restructure itself. Occasionally, however, flawed genetic instructions can cause things to go wrong, leading to such disabilities as dyslexia, schizophrenia, and Down syndrome (Byrnes, 2001; H. M. Conklin & Iacono, 2002; Koo, Blaser, Harwood-Nash, Becker, & Murphy, 1992).

Environmental factors affect brain development as well. One important factor is nutrition both before and after birth, which can affect the production and myelination of neurons and the growth of glial cells (D. Benton, 2008; Byrnes 2001; Sigman & Whaley, 1998). High levels of environmental toxins—lead, mercury, pesticides, and so on—can also have a significant impact on brain development, especially during the prenatal period and in the first few years after birth (Hubbs-Tait, Nation, Krebs, & Bellinger, 2005; Koger, Schettler, & Weiss, 2005). And when future mothers consume large amounts of alcohol during pregnancy, their children often develop *fetal alcohol syndrome*, a condition characterized by distinctive facial features, poor motor coordination, delayed language, and intellectual disabilities (Dorris, 1989).

People's experiences, too, make a difference. For instance, the family environment in which children live—perhaps warm and nurturing, on the one hand, or harsh and abusive, on the other—affects the ways in which the brain structures itself (Ayoub & Rappolt-Schlichtmann, 2007; Repetti, Taylor, & Saxbe, 2007). Regular physical exercise seems to stimulate the growth of neurons (G. D. Cohen, 2005; Pereira et al., 2007). And opportunities to learn new skills—perhaps how to read, play a musical instrument, or juggle—result in noticeable differences in the size, organization, or functioning of relevant brain structures (Castro-Caldas et al., 1999; Draganski et al., 2004; Elbert, Pantev, Wienbruch, Rockstroh, & Taub, 1995; K. L. Hyde et al., 2009). To the extent that the brain adapts itself in such ways to different circumstances and experiences, we say that it has **plasticity**.

## To What Extent Are There Critical Periods in Brain Development?

Although the human brain is fairly adaptable to changing circumstances, it can't always bounce back when the environment offers too little stimulation or consistently presents the wrong kind of stimulation. In some cases, the *timing* of environmental stimulation (or lack thereof) makes a



considerable difference. In other words, there are **critical periods**<sup>3</sup> in certain aspects of brain development—limited age ranges in which particular kinds of environmental stimulation have their greatest and perhaps only impact. For example, consider this intriguing finding: When accomplished musicians play their musical instruments, those who began their musical training before age 10 show greater activation in a certain part of their brains than those who began their training at an older age (Elbert et al., 1995). One group doesn't necessarily play better than the other, but the later-trained musicians appear to have missed a window of opportunity for fully developing the brain area that the earlier-trained musicians are using.

Researchers have consistently found evidence for critical periods in the development of visual perception (Bruer, 1999; Hubel, Wiesel, & Levay, 1977; Levay, Wiesel, & Hubel, 1980). For example, when children are born with cataracts that prevent normal vision, early surgery is essential. If the cataracts are surgically removed at an early age—say, by age 2—children develop relatively normal vision, but if surgery is postponed until much later, children have reduced visual perception abilities and in some instances remain functionally blind (Bruer, 1999; Maurer, Lewis, Brent, & Levin, 1999; Ostrovsky, Andalman, & Sinha, 2006).

Researchers have found persuasive evidence that there may be critical periods in learning language as well. Children who have little or no exposure to language in the early years often have trouble acquiring language later on, even with intensive language instruction (Curtiss, 1977; Newport, 1990). Furthermore, in the first few days and weeks of life, infants can discriminate among speech sounds used in a wide variety of languages, but by the time they're 6 months old, they detect only those differences important in the language(s) spoken around them (P. K. Kuhl, Tsao, & Liu, 2003; P. K. Kuhl, Williams, & Lacerda, 1992). As an example, the English language treats "L" and "R" as two separate sounds, whereas Japanese clumps them together into a single sound; thus, children in English-speaking countries continue to hear the difference between them, whereas Japanese children quickly lose the ability to tell them apart. I think back with fondness to one of my apartment mates in graduate school, a young Japanese woman named Kikuko who didn't learn English until grade school. Kikuko often talked about taking her *umbrella* with her on rainy days and about counting *raps* she completed while running the track around the gym.

Additional evidence for critical periods in language development comes from people who learn a second language. Typically, people learn how to pronounce a second language flawlessly only if they study it before midadolescence or, even better, in the preschool or early elementary years (Bialystok, 1994a; Flege, Munro, & MacKay, 1995; M. S. C. Thomas & Johnson, 2008). Children may also have an easier time mastering complex aspects of a second language's syntax when they're immersed in the language within the first 5 to 10 years of life (Bialystok, 1994a, 1994b; Birdsong, 2006; Bortfeld & Whitehurst, 2001). The effects of age on language learning are especially noticeable when the second language is phonetically and syntactically very different from the first (Bialystok, 1994a; Doupe & Kuhl, 1999; Strozer, 1994).

However, most theorists doubt very much that there are critical periods for *all* skills and knowledge domains. Oftentimes people become quite proficient in topics or skills that they don't begin to tackle until they're teenagers or adults. For example, I didn't learn to drive until I was 16, didn't begin to study psychology until I reached college, and didn't begin to play racquetball

---

<sup>3</sup>Many developmentalists prefer the term *sensitive period*, which connotes a more open-ended, flexible window of opportunity. However, I've seen the term *critical period* more frequently in literature about brain development, hence my use of this term here.

until I was in graduate school, but with time and practice, I've acquired considerable mastery in each of these domains.

### ***Experience-Expectant versus Experience-Dependent Plasticity***

So when is early experience important, and when is it *not* important? Greenough, Black, and Wallace (1987) have made a distinction that can help us make sense of what appear to be conflicting data. Mother Nature, it seems, has helped our brains evolve in such a way that we can adapt to the specific physical and cultural environments in which we find ourselves, but she assumes that we'll have *some* stimulation early on to shape brain development. For skills that human beings have possessed for many millennia—visual perception, language, and so on—the brain is **experience-expectant**: It uses the experiences that human beings encounter in virtually any environment to fine-tune its powers. For instance, although the brain is initially capable of interpreting visual signals from both eyes, it will restructure itself to compensate for malfunctioning ones (Bavelier & Neville, 2002; T. V. Mitchell, 2007). And although it comes equipped with what it needs to discriminate among many different speech sounds, it quickly learns to ignore subtle differences that are irrelevant for making sense of its native language, paving the way for more efficient discriminations among sounds that *are* important for language comprehension. Quite possibly, the phenomena of synaptogenesis, differentiation, and synaptic pruning provide the mechanisms by which the brain initially sets itself up to accommodate a wide variety of environments and then begins to zero in on the particular environment in which it actually finds itself (Bruer & Greenough, 2001; P. K. Kuhl, Conboy, Padden, Nelson, & Pruitt, 2005; M. S. C. Thomas & Johnson, 2008). Although such zeroing-in obviously enhances the brain's ability to deal efficiently with common, everyday situations (e.g., understanding and speaking in one's native language), it may interfere with the brain's ability to override its usual ways of thinking in order to do something very different later on (e.g., learning a second language).

Many other content domains and skill areas—for instance, reading, driving a car, psychology, racquetball—are such recent additions to human culture (and none of these appears in *all* cultures) that Mother Nature has had neither the time nor inclination to make them part of our evolutionary heritage (Bruer, 1997, 1999; Byrnes, 2001). Domains and skills that are unique to particular cultures and social groups are **experience-dependent**: They emerge only when environmental conditions nurture them, and they can presumably emerge at almost any age. In fact, by strengthening weak synapses and forming new ones, human beings and other animals retain considerable experience-dependent plasticity throughout the lifespan (Greenough et al., 1987; Maguire et al., 2000; Merzenich, 2001; C. A. Nelson et al., 2006). For example, at age 85, my mother-in-law moved from Arizona to be near us in our present home in New Hampshire. She easily learned the knowledge and skills she needed to survive and thrive in her new community: how to get to the bank and grocery store, which neighbors had talents and interests similar to her own, what political issues were simmering in town and across the state, and so on.

So let's return to our earlier question: To what extent are there critical periods in brain development? It appears that critical periods exist for certain basic abilities such as visual perception and language. Even in these domains, however, the windows of opportunity remain open for different periods of time for different aspects of those abilities. For instance, there are different time frames for the development of color vision, motion perception, and depth perception, and different time frames for sound discrimination, pronunciation, and acquisition of syntactic structures (Bruer, 1999; Neville & Bruer, 2001; M. S. C. Thomas & Johnson, 2008). Furthermore, the windows of opportunity don't necessarily slam shut at particular ages. Rather, they close gradually

over a prolonged period and in some cases stay open at least a crack for a very long time, particularly if the right kinds of experiences are provided. And for complex, culture-specific acquisitions—including most of the topics and skills that we teach in schools and universities—the windows sometimes remain wide open throughout childhood and much of adulthood (Bavelier & Neville, 2002; McCall & Plemons, 2001; C. A. Nelson et al., 2006).

## To What Extent Is the Brain “Prewired” to Know or Learn Things?

Let’s look once again at language. Speaking and understanding language is a miraculous accomplishment indeed; children must master not only the subtle motor movements involved in producing various consonants and vowels but also tens of thousands of word meanings plus syntactical structures so numerous and multifaceted that even linguists have been hard-pressed to identify and catalog them all. How children master language as quickly as they do remains one of the big mysteries of child development. Many psychologists believe that although children obviously aren’t born knowing a particular language, they *are* born with some predispositions that assist them in acquiring whichever language they hear spoken around them. For instance, beginning at a very early age, infants can detect subtle differences among very similar speech sounds. They can divide a steady stream of sound into small segments (e.g., syllables) and identify common patterns in what they hear. They seem to have a few built-in concepts (e.g., colors such as red, pink, and yellow) that predispose them to categorize their experiences in certain ways. And possibly they also have a *Universal Grammar*, a set of parameters that predispose them to form certain kinds of grammatical structures but not others (Chomsky, 2006; Gopnik, 1997; Lightfoot, 1999; O’Grady, 1997; Pinker, 2007).

Some theorists have suggested that human beings may be prewired with respect to other domains as well. Consider these findings from research with infants:

- By 24 hours of age, infants have some ability to discriminate between objects that are close to them versus objects that are farther away (A. Slater, Mattock, & Brown, 1990). It’s as if they can judge distance long before they have much opportunity to *learn* about distance.
- Infants as young as 1 or 2 days old may imitate an adult’s facial expressions—perhaps pursing their lips, opening their mouths, or sticking out their tongues (T. F. Field, Woodson, Greenberg, & Cohen, 1982; Meltzoff & Moore, 1977; Reissland, 1988). It’s as if they already connect certain things they see other people do with certain things that they themselves can do. In fact, evidence is emerging that some primate species (possibly including human beings) have certain neurons that fire either when they perform a particular action themselves *or* when they watch *someone else* perform it (Iacoboni & Woods, 1999; Murata et al., 1997; Wicker et al., 2003). Such neurons, known as **mirror neurons**, might explain why infants can imitate others so early in life: Some of the same neurons are involved when they watch another person’s behavior and when they engage in the behavior themselves.
- By 3 or 4 months, infants show signs of surprise when one solid object passes directly through another one, when an object seems to be suspended in midair, or when an object appears to move immediately from one place to another without traveling across the intervening space to get there (Baillargeon, 1994; Spelke, 1994; Spelke, Breinlinger, Macomber, & Jacobson, 1992). It appears, then, that young infants know that objects are

substantive entities with definite boundaries, that objects will fall unless something holds them up, and that movements of objects across space are continuous and somewhat predictable.

Such findings suggest to some theorists (e.g., Baillargeon, 2004; M. Cole & Hatano, 2007; Spelke, 2000) that infants have some biologically built-in **core knowledge** about the physical world. Knowledge of this kind would have an evolutionary advantage, of course—it would give infants a head start in learning about their environment—and evidence for it has been observed in other species as well (Spelke, 2000).

Nevertheless, the extent to which the human brain is hardwired with certain knowledge—or perhaps with predispositions to acquire that knowledge—is an unresolved issue, and it will likely remain so for quite some time. Unless researchers can assess infants' knowledge at the very moment of birth, they can't rule out the possibility that experience and practice, rather than built-in knowledge, account for infants' early capabilities. Just imagine a couple of scientists in lab coats appearing in the hospital delivery room to ask if they can whisk the new baby away for a "research project." I doubt that they'd find many new parents willing to sign the necessary permission forms.

## THE PHYSIOLOGICAL BASIS OF LEARNING

---

So how and where, from a physiological standpoint, does learning occur? Many theorists believe that the basis for learning lies in changes in interconnections among neurons—in particular, in the strengthening or weakening of existing synapses or the formation of new ones (e.g., Lichtman, 2001; Merzenich, 2001; M. I. Posner & Rothbart, 2007; Trachtenberg et al., 2002). A second phenomenon may be involved as well. Until recently, it was common "knowledge" that all the neurons a person would ever own are produced in the first few weeks of the prenatal period. Some researchers have found, however, that **neurogenesis**—the formation of new neurons—continues throughout the lifespan in a particular part of the hippocampus and possibly also in certain regions of the frontal and parietal lobes. New learning experiences appear to enhance the survival rate and maturation of the young neurons; without such experiences, these neurons slowly die away (Gould, Beylin, Tanapat, Reeves, & Shors, 1999; Leuner et al., 2004; C. A. Nelson et al., 2006; Sapolsky, 1999).

Within the last few years, some researchers have begun to speculate that certain star-shaped glial cells known as **astrocytes** are just as important as neurons—possibly even more important—in learning and memory. In human beings, astrocytes far outnumber neurons, have innumerable chemically mediated connections with one another and with neurons, and appear to have considerable control over what neurons do and don't do and how much neurons communicate with one another. A normal brain produces many new astrocytes throughout the lifespan (Koob, 2009; Oberheim et al., 2009; Verkhratsky & Butt, 2007).

Physiologically, most newly acquired information and skills seem to need some time to "firm up" in the cortex—a process called **consolidation** (J. L. C. Lee, Everitt, & Thomas, 2004; J. D. Payne & Kensinger, 2010; Rasch & Born, 2008). For instance, a person who incurs a serious head injury (perhaps in an automobile accident) often can't recall things that happened several seconds, minutes, days, or months prior to the injury, whereas memories of long-past events remain largely intact. Such amnesia is especially common when the person is unconscious

for a short time following the injury, presumably because the individual is no longer able to think about events that have recently occurred (Barbizet, 1970; D. J. Siegel, 1999; Squire, 1987).

As for *where* learning occurs, the answer is: many places. The frontal lobes are active when we must pay attention to and think about new information and events, and all of the lobes of the cortex may be active to a greater or lesser extent in interpreting new input in light of previously acquired knowledge (Byrnes, 2001; Cacioppo et al., 2007; Huey, Krueger, & Grafman, 2006). The small, seahorse-shaped hippocampus also seems to be a central figure in the learning process, binding together information it receives from various parts of the brain to create and then consolidate new memories (Bauer, 2002; Bauer, Wiebe, Carver, Waters, & Nelson, 2003; Davachi & Dobbins, 2008; Squire & Alvarez, 1998). And the hippocampus's neighbor in the limbic system, the amygdala, is probably instrumental in the preverbal, emotional memories that very young children form (LeDoux, 1998; Nadel, 2005; Wisner Fries & Pollak, 2007).

Even as researchers pin down how and where learning occurs, we must remember that knowledge of brain anatomy and physiology doesn't begin to tell us everything we need to know about learning, let alone about how we can best foster and enhance it in educational settings. We now look now at what research about the brain does and doesn't tell us about appropriate and effective educational practice.

## EDUCATIONAL IMPLICATIONS OF BRAIN RESEARCH

---

Extolling recent advances in brain research, some well-intentioned but ill-informed individuals have drawn unwarranted inferences about its educational implications. For instance, you might hear people speaking of "building better brains," designing a "brain-based curriculum," or "teaching to the right brain." Such statements often reflect misconceptions about how the brain works. Although much of what researchers have learned about brain functioning is still somewhat tentative and controversial, following are several conclusions we can draw with confidence:

- ◆ *Some loss of synapses is both inevitable and desirable.* Apparently in an effort to preserve as many of those early synapses as possible, some writers have suggested that infants and young children be immersed in stimulation-rich environments that get them off to a strong start in academics, athletics, and the arts. Yet synaptic pruning is inevitable, because synapses must compete for a limited supply of the trophic factors that ensure their survival. Furthermore, pruning is often beneficial rather than detrimental, because it eliminates useless synapses and thereby enhances the brain's efficiency. The sequence of synaptogenesis and synaptic pruning is a primary means by which Mother Nature ensures plasticity and adaptability in human functioning. In fact, much learning and many advances in cognitive abilities occur after most synaptic pruning has already taken place (Bruer, 1999).

- ◆ *Many environments nurture normal brain development.* In domains where development depends on particular kinds of stimulation at particular ages (i.e., in domains characterized by critical periods), the necessary stimulation is found in experiences that children encounter in virtually any culture. For instance, to acquire normal binocular vision, children need regular and balanced visual input to both eyes, and to acquire normal facility with language, children need ongoing exposure to a language, either spoken or manually signed (Bruer, 1999; McCall & Plemons, 2001; Newport, 1990). Such experiences can be found not only in "enriching" child care and preschool environments but also in lower-income, inner-city neighborhoods and even in remote tribal groups in developing nations.

I must include one important caveat here, however: A very critical period is the prenatal period, especially the first few months after conception, when adequate nutrition and protection from environmental hazards (lead dust, mercury, alcohol, etc.) are essential if the brain is to get off to a good start. The adverse effects of poor nutrition and environmental insults during this time period appear to be irreversible.

♦ *The early years are important for learning, but so are the later years.* Although complex environments appear not to be essential for *neurological* development, children often make greater *cognitive* gains—for instance, they have more knowledge and skills, and they earn higher scores on intelligence tests—in enriching preschool programs than they make without such programs (NICHD Early Child Care Research Network, 2002; Nisbett, 2009; Schweinhart et al., 2005; Zigler, 2003). However, the gains made in the early years tend to diminish over time, and may disappear altogether, unless children continue to have stimulating experiences during the school years (Bronfenbrenner, 1999; Brooks-Gunn, 2003; Farran, 2001; Raudenbush, 2009). Educators and policy makers mustn't put all of their eggs in one age-specific basket; nurturance of learning and cognitive growth have to be a long-term enterprise.

♦ *There is no such thing as teaching to the “left brain” or to the “right brain.”* Some writers have suggested that many adults and children specialize in one hemisphere or the other, to the point of being largely “left-brain” or “right-brain” thinkers and learners, and so they urge educators to accommodate the hemispheric preferences of every student. But as we've seen, both hemispheres work in close collaboration in virtually all thinking and learning tasks. In the absence of performing surgical lobotomies (which I obviously don't recommend), attempts to train one side exclusively will be in vain.

♦ *In developmental domains characterized by critical periods, the windows of opportunity often remain at least a crack open.* The concept of *critical period* tells us the best time for a particular ability to be nurtured, but it doesn't necessarily tell us the *only* time. Sometimes, for a variety of reasons, children have little or no exposure to appropriate stimulation during the optimal time frame; for instance, children may not get needed cataract surgery until their families can afford it, and children who are congenitally deaf may not encounter a language they can actually perceive (e.g., American Sign Language) until they reach school age. Rather than fret over what should have happened but didn't, researchers and educators can better serve young people who have missed critical experiences by devising and implementing interventions that enable those individuals to make up at least some of the lost ground (Bruer, 1999).

♦ *Brain research can help us refine our theories of learning and cognition, but it can't tell us very much about what to teach or how best to teach it.* As researchers continue to learn more about the architecture and functioning of the brain, they sometimes find evidence that either supports or refutes various psychological explanations of how people learn and think (Byrnes, 2007; Varma, McCandliss, & Schwartz, 2008). And as psychologists, in turn, refine their theories of learning and cognition, they can gradually get a better handle on the kinds of instructional methods and therapeutic interventions that are most likely to foster effective learning and behavior.

Nevertheless, we can probably never boil down specific psychological phenomena—thoughts, knowledge, interpretations, and so on—into strictly physiological entities. Brain research is unlikely to tell us what information and skills are most important for people to have; such things are often culture specific, and decisions about how to prioritize them are value laden (L. Bloom & Tinker, 2001; Chalmers, 1996; H. Gardner, 2000). And up to this point, brain

research has yielded only a few vague clues about how we might best help learners acquire important information and skills (Bandura, 2006; D. Kuhn & Franklin, 2006; Varma et al., 2008). Fortunately, as you'll discover in the chapters that follow, psychological theories of learning—theories derived from studies of human behavior rather than from brain anatomy and physiology—have a great deal to offer as we work to identify effective instructional and therapeutic techniques.

---

## SUMMARY

Messages travel through the human nervous system by way of both (1) electrical transmissions that run through individual neurons and (2) chemical transmissions that traverse synapses between neurons. Synapses in the spinal cord are responsible for a few basic reflexes, but by and large the brain is the coordination and decision-making center for the body.

Using a growing arsenal of research methods, scientists have learned a great deal about how the brain works. In human beings, the largest and most recently evolved part of the brain—the *forebrain*—predominates in consciousness, thinking, learning, and the many distinctly human mental activities in which people engage. Even small, seemingly simple tasks (e.g., recognizing and understanding a particular word) typically involve many parts of the brain in both hemispheres working together.

The beginnings of the brain emerge late in the first month of prenatal development; by the second trimester, the great majority of neurons a person will ever possess have formed and are migrating to their final locations. Synapses among neurons begin to form before birth; shortly after birth, the rate of synapse formation increases dramatically, so much so that children have many more synapses than adults do. Over the course of childhood and adolescence, the brain cuts back (i.e., *prunes*) little-used synapses, apparently as a means of adapting to its environment and increasing its efficiency. Although most brain development occurs during the prenatal period and early childhood years, some changes in brain structures and neurotransmitters continue into adolescence and adulthood. Genetic instructions largely drive developmental changes in the brain, but nutrition, environmental toxins, physical activity,

and learning experiences influence brain development as well.

Researchers have found evidence for *critical periods* in the development of some basic, long-standing human abilities (e.g., visual perception and language). But many recent human achievements (e.g., literacy, mathematics) can probably be acquired at any age, and certainly the ability to acquire new knowledge and skills remains throughout life. Some theorists hypothesize that certain kinds of knowledge essential for people's basic survival (e.g., certain elements of language, basic knowledge about the physical world)—or at least predispositions to acquire these things quickly and easily—may be biologically built in.

Many theorists believe that learning primarily involves the modification of existing synapses and the formation of new ones, along with the occasional formation of new neurons. In recent years, however, some researchers have speculated that certain star-shaped glial cells (astrocytes) may also play a key role in learning and memory.

Occasionally educators have drawn unwarranted implications from brain research. The early years are important, but providing intensive, structured programs for infants and preschoolers is unlikely to prevent synaptic pruning, and any other potential benefits of such programs for neurological development have yet to be demonstrated. Furthermore, efforts to teach to the “left brain” or “right brain” are ultimately in vain because the two hemispheres collaborate in virtually every activity. Findings from brain research have been useful in helping psychologists refine their theoretical explanations of learning and cognition, but they haven't yet offered much guidance regarding effective instructional practices.

## CHAPTER 3

---

# BEHAVIORISM AND CLASSICAL CONDITIONING

*Basic Assumptions of Behaviorism*

*Classical Conditioning*

*The Classical Conditioning Model*

*Classical Conditioning in Human Learning*

*Common Phenomena in Classical Conditioning*

*Cognition in Classical Conditioning*

*Changing Undesirable Conditioned Responses*

*Educational Implications of Behaviorist Assumptions  
and Classical Conditioning*

*Summary*

**Y**ou might say I have a “thing” about bees. Whenever a bee flies near me, I scream, wave my arms frantically, and run around like a wild woman. Yes, yes, I know, I would be better off if I remained perfectly still, but somehow I just can’t control myself. My over-reaction to bees is probably a result of several painful bee stings I received as a small child.

One way to explain how people develop involuntary responses to particular stimuli, such as my fearful reaction to bees, is a theory of learning known as *classical conditioning*. Classical conditioning is an example of *behaviorism*, a perspective I introduced in Chapter 1. The first major theoretical perspective of learning to emerge in the twentieth century, behaviorism is the topic of Chapters 3 through 5. In this chapter, we’ll consider several basic assumptions of the behaviorist approach and then look at the nature and potential implications of classical conditioning. In the following two chapters, we’ll continue our discussion of behaviorism by examining principles and applications of *instrumental conditioning*.

## BASIC ASSUMPTIONS OF BEHAVIORISM

---

As I mentioned in Chapter 1, early research on learning relied heavily on *introspection*, a method in which people were asked to “look” inside their heads and describe what they were thinking. But in the early 1900s, some psychologists argued that such self-reflections were highly subjective and not necessarily accurate—a contention substantiated by later researchers (e.g., Nisbett & Wilson, 1977; Zuriff, 1985). Beginning with the efforts of the Russian physiologist Ivan Pavlov (to be described shortly) and the work of American psychologist Edward Thorndike (to be described in Chapter 4), a more objective approach to the study of learning emerged. These researchers looked primarily at *behavior*—something they could easily see and objectively describe and measure—and so the behaviorist movement was born.

Behaviorists haven’t always agreed on the specific processes that account for learning. Yet many of them have historically shared certain basic assumptions:

- ◆ *Principles of learning should apply equally to different behaviors and to a variety of animal species.* Behaviorists typically assume that human beings and other animals learn in similar ways—an assumption known as **equipotentiality**. As a result of this assumption, behaviorists frequently apply to human learning the principles they have derived primarily from research with such animals as rats and pigeons. In their discussions of learning, they often use the term **organism** to refer generically to a member of any species, human and nonhuman alike.

- ◆ *Learning processes can be studied most objectively when the focus of study is on stimuli and responses.* Behaviorists believe that psychologists must study learning through objective



scientific inquiry, in much the same way that chemists and physicists study phenomena in the physical world. By focusing on two things they can observe and measure—more specifically, by focusing on **stimuli** in the environment and **responses** that organisms make to those stimuli—psychologists can maintain this objectivity. Behaviorist principles of learning often describe a relationship between a stimulus (**S**) and a response (**R**); hence, behaviorism is sometimes called **S–R psychology**.

♦ *Internal processes are largely excluded from scientific study.* Many behaviorists believe that because we can't directly observe and measure internal mental processes (e.g., thoughts and motives), we should exclude these processes from research investigations, as well as from explanations of how learning occurs (e.g., Kimble, 2000; J. B. Watson, 1925). These behaviorists describe an organism as a *black box*, with stimuli impinging on the box and responses emerging from it but with the things going on inside it remaining a mystery.<sup>1</sup>

Not all behaviorists take a strict black-box perspective, however. Some insist that factors within the organism (**O**), such as motivation and the strength of stimulus–response associations, are also important in understanding learning and behavior (e.g., Hull, 1943, 1952). These **neobehaviorist** theorists are sometimes called **S–O–R** (stimulus–organism–response) theorists rather than **S–R** theorists. Especially in recent decades, some behaviorists have asserted that they can fully understand both human and animal behavior only when they consider cognitive processes as well as environmental events (e.g., R. M. Church, 1993; DeGrandpre, 2000; Rachlin, 1991; Wasserman, 1993).

♦ *Learning involves a behavior change.* In Chapter 1, I defined learning as involving a long-term change in mental representations or associations. In contrast, behaviorists have traditionally defined learning as a change in *behavior*. And after all, we can determine that learning has occurred only when we see it reflected in someone's actions.

As behaviorists have increasingly brought cognitive factors into the picture, many have backed off from this behavior-based definition of learning. Instead, they treat learning and behavior as separate, albeit related, entities. A number of psychologists have suggested that many behaviorist laws are more appropriately applied to an understanding of what influences the *performance* of learned behaviors, rather than what influences learning itself (e.g., R. Brown & Herrnstein, 1975; W. K. Estes, 1969; Herrnstein, 1977; B. Schwartz & Reisberg, 1991).

♦ *Organisms are born as blank slates.* Historically, many behaviorists have argued that, aside from certain species-specific instincts (e.g., nest-building in birds) and biologically based disabilities (e.g., mental illness in human beings), organisms aren't born with predispositions to behave in particular ways. Instead, they enter the world as a “blank slate” (or, in Latin, *tabula rasa*) on which environmental experiences gradually “write.” Because each organism has a unique set of environmental experiences, so, too, will it acquire its own unique set of behaviors.

♦ *Learning is largely the result of environmental events.* Rather than use the term *learning*, behaviorists often speak of **conditioning**: An organism is *conditioned* by environmental events. The passive form of this verb connotes many behaviorists' belief that because learning is the result of one's experiences, learning happens *to* an organism in a way that is often beyond the organism's control.

---

<sup>1</sup>This idea that the study of human behavior and learning should focus exclusively on stimuli and responses is sometimes called *radical behaviorism*.

Some early behaviorists, such as B. F. Skinner, were **determinists**: They proposed that if we were to have complete knowledge of an organism's past experiences and present environmental circumstances, as well as knowledge of any predispositions the organism might inherit to behave in certain ways, we would be able to predict the organism's next response with total accuracy. Many contemporary behaviorists don't think in such a deterministic manner: In their view, any organism's behavior reflects a certain degree of variability that stimulus–response associations and genetics alone can't explain (R. Epstein, 1991; Rachlin, 1991). Looking at how organisms have previously learned to respond to different stimuli can certainly help us understand why people and other animals currently behave as they do, but we'll never be able to predict their actions with 100% certainty.

♦ *The most useful theories tend to be parsimonious ones.* According to behaviorists, we should explain the learning of all behaviors, from the most simple to the most complex, by as few learning principles as possible. This assumption reflects a preference for **parsimony** (conciseness) in explaining learning and behavior. We'll see an example of such parsimony in the first behaviorist theory we explore: classical conditioning.

## CLASSICAL CONDITIONING

---

In the early 1900s, in an effort to better understand the nature of digestion, Russian physiologist Ivan Pavlov conducted a series of experiments related to salivation in dogs. His approach typically involved making a surgical incision in a dog's mouth (allowing collection of the dog's saliva in a small cup), strapping the dog into an immobile position, giving it some powdered meat, and then measuring the amount of saliva the dog produced. Pavlov noticed that after a few of these experiences, a dog would begin to salivate as soon as the lab assistant entered the room with meat, even though it hadn't yet had an opportunity to see or smell the meat. Apparently, the dog had learned that the lab assistant's entrance meant that food was on the way, and it responded accordingly. Pavlov devoted a good part of his later years to a systematic study of this learning process on which he had so inadvertently stumbled, and he eventually summarized his research in his book *Conditioned Reflexes* (Pavlov, 1927).

Pavlov's early studies went something like this:

1. He first observed whether a dog salivated in response to a particular stimulus—perhaps to a flash of light, the sound of a tuning fork, or the ringing of a bell. For simplicity's sake, we'll continue with our discussion using a bell as the stimulus in question. As you might imagine, the dog didn't find the ringing of a bell especially appetizing and therefore didn't salivate.
2. Pavlov rang the bell again, this time immediately following it with some powdered meat. The dog, of course, salivated. Pavlov rang the bell several more times, always presenting meat immediately afterward. The dog salivated on each occasion.
3. Pavlov then rang the bell *without* presenting any meat. Nevertheless, the dog salivated. The bell to which the dog had previously been unresponsive (in Step 1) now led to a salivation response. There had been a change in behavior as a result of experience; from the behaviorist perspective, then, *learning* had taken place.

The phenomenon Pavlov observed is now commonly known as **classical conditioning**.<sup>2</sup> Let's analyze the three steps in Pavlov's experiment in much the same way that Pavlov did:

1. A **neutral stimulus (NS)** is identified—a stimulus to which the organism doesn't respond in any noticeable way. In the case of Pavlov's dogs, the bell was originally a neutral stimulus that didn't elicit a salivation response.
2. The neutral stimulus is presented just before another stimulus, one that *does* lead to a response. This second stimulus is called an **unconditioned stimulus (UCS)**, and the response to it is called an **unconditioned response (UCR)**, because the organism responds to the stimulus unconditionally, without having had to learn to do so. For Pavlov's dogs, meat powder was an unconditioned stimulus to which they responded with the unconditioned response of salivation.
3. After being paired with an unconditioned stimulus, the previously neutral stimulus now elicits a response and thus is no longer "neutral." The NS has become a **conditioned stimulus (CS)** to which the organism has learned a **conditioned response (CR)**.<sup>3</sup> In Pavlov's experiment, after several pairings with meat, the bell became a conditioned stimulus that, on its own, elicited the conditioned response of salivation. The diagram in Figure 3.1 shows graphically what happened from a classical conditioning perspective.

Pavlov's studies of classical conditioning continued long after these initial experiments, and many of his findings have been replicated with other responses and in other species, including humans. Let's take a closer look at the process of classical conditioning and at some examples of how it might occur in human learning.

### The Classical Conditioning Model

Classical conditioning has been demonstrated in many species—for instance, in newborn human infants (Boiler, 1997; Lipsitt & Kaye, 1964; Reese & Lipsitt, 1970), human fetuses still in the womb (Macfarlane, 1978), laboratory rats (Cain, Blouin, & Barad, 2003), rainbow trout

**Figure 3.1**  
A classical conditioning analysis of how Pavlov's dogs learned

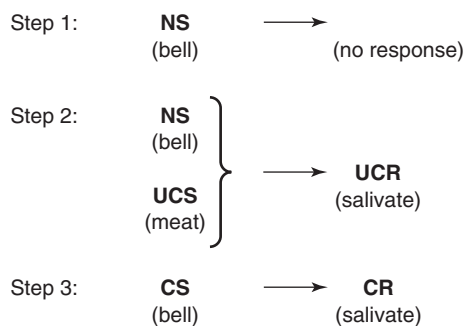

<sup>2</sup>Some psychologists instead use the term *respondent conditioning*, a label coined by B. F. Skinner to reflect its involuntary-response-to-a-stimulus nature.

<sup>3</sup>Pavlov's original terms were actually *unconditional* stimulus, *unconditional* response, *conditional* stimulus, and *conditional* response, but the mistranslations to "unconditioned" remain in most classical conditioning literature.

The conditioned stimulus may serve as a signal that the unconditioned stimulus is coming.

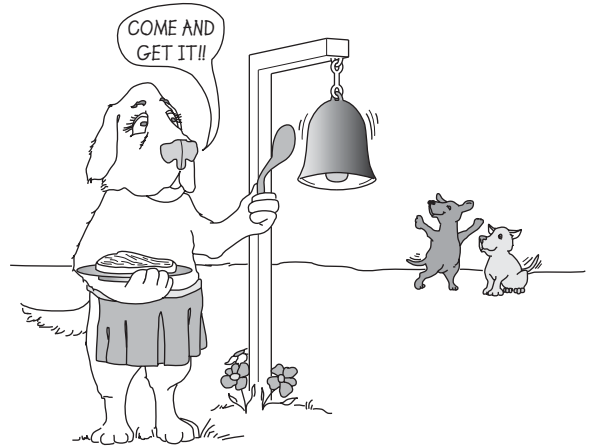

(Nordgreen, Janczak, Hovland, Ranheim, & Horsberg, 2010), and snails (Samarova et al., 2005). The applicability of classical conditioning clearly extends widely across the animal kingdom.

As Pavlov's experiments illustrated, classical conditioning typically occurs when two stimuli are presented at approximately the same time. One of these stimuli is an unconditioned stimulus: It has previously been shown to elicit an unconditioned response. The second stimulus, through its association with the unconditioned stimulus, begins to elicit a response as well: It becomes a conditioned stimulus that brings about a conditioned response. In many cases, conditioning occurs relatively quickly; it's not unusual for an organism to show a conditioned response after the two stimuli have been presented together only five or six times, and sometimes after only one pairing (Rescorla, 1988).

Classical conditioning is most likely to occur when the conditioned stimulus is presented just *before* (perhaps by half a second) the unconditioned stimulus. For this reason, some psychologists describe classical conditioning as a form of **signal learning**. By being presented first, the conditioned stimulus serves as a signal that the unconditioned stimulus is coming, much as Pavlov's dogs might have learned that the sound of a bell indicated that yummy meat powder was on its way.

Classical conditioning usually involves the learning of *involuntary* responses—responses over which the learner has no control. When we say that a stimulus **elicits** a response, we mean that the stimulus brings about a response automatically, without the learner having much influence over its occurrence. In most cases, the conditioned response is similar to the unconditioned response, with the two responses differing primarily in terms of which stimulus elicits the response and sometimes in terms of the strength of the response. Occasionally, however, the CR is quite different—perhaps even opposite to—the UCR (I'll give you an example in our discussion of drug addiction a bit later). But in one way or another, the conditioned response allows the organism to anticipate and prepare for the unconditioned stimulus that will soon follow.

## Classical Conditioning in Human Learning

We can use classical conditioning theory to help us understand how people learn a variety of involuntary responses, especially responses associated with physiological functioning or emotion. For example, people can develop aversions to particular foods as a result of associating

those foods with an upset stomach (Garb & Stunkard, 1974; Logue, 1979). To illustrate, after associating the taste of creamy cucumber salad dressing (CS) with the nausea I experienced during pregnancy (UCS), I developed an aversion (CR) to cucumber dressing that lasted for several years.

Classical conditioning is also a useful model for explaining some of the fears and phobias that people develop (Mineka & Zinbarg, 2006). For example, my bee phobia can probably be explained by the fact that bees (CS) were previously associated with a painful sting (UCS), such that I became increasingly fearful (CR) of the nasty insects. In a similar way, people who are bitten by a particular breed of dog sometimes become afraid of that breed, or even of all dogs.

Probably the best-known example of a classically conditioned fear of certain animals is the case of “Little Albert,” an infant who learned to fear white rats through a procedure used by John Watson and Rosalie Rayner (1920). Albert was an even-tempered, 11-month-old child who rarely cried or displayed fearful reactions. One day, Albert was shown a white rat. As he reached out and touched the rat, a large steel bar behind him was struck, producing a loud, unpleasant noise. Albert jumped, obviously very upset by the startling noise. Nevertheless, he reached forward to touch the rat with his other hand, and the steel bar was struck once again. After five more pairings of the rat (CS) and the loud noise (UCS), Albert was truly rat-phobic: Whenever he saw the rat he cried hysterically and crawled away as quickly as his hands and knees could move him. Watson and Rayner reported that Albert responded in a similarly fearful manner to a rabbit, a dog, a sealskin coat, cotton wool, and a Santa Claus mask with a fuzzy beard, although none of these had ever been paired with the startling noise. (Watson and Rayner never “undid” their conditioning of poor Albert. Fortunately, the ethical standards of the American Psychological Association now prohibit such negligence.)

Fear of failure is yet another example of a response that may be classically conditioned. In some cases, people who are unusually afraid of failing may have previously associated failure with unpleasant circumstances; perhaps they’ve associated it with painful punishment from an angry parent or ridicule by insensitive classmates. Yet occasional failure is a natural consequence of attempting new tasks, whether in school, at home, or elsewhere. Teachers and parents must be careful that failure doesn’t become such a strong conditioned stimulus that children resist new activities and challenging but potentially risky tasks.

Attitudes, too, can be partly the result of classical conditioning. In one study (Olson & Fazio, 2001), college students sat at a computer terminal to watch various unfamiliar cartoon characters from the Pokemon video game series. One character was consistently presented in conjunction with words and images that evoked pleasant feelings (e.g., “excellent,” “awesome,” pictures of puppies and a hot fudge sundae). A second character was consistently presented along with words and images that evoked unpleasant feelings (e.g., “terrible,” “awful,” pictures of a cockroach and a man with a knife). Other characters were paired with more neutral words and images. Afterward, when the students were asked to rate some of the cartoon characters and other images they had seen on a scale of  $-4$  (unpleasant) to  $+4$  (pleasant), they rated the character associated with pleasant stimuli far more favorably than the character associated with unpleasant stimuli. Curiously, a positive attitude toward an initially neutral stimulus doesn’t necessarily emerge only when people experience it in the company of other pleasant things. Simply experiencing it repeatedly in the *absence* of unpleasant things can be enough to engender a preference for it (Zajonc, 2001).

These examples of classical conditioning in action will, I hope, help you recognize a classically conditioned response when you see one. We now turn to several general phenomena associated with classical conditioning.

## Common Phenomena in Classical Conditioning

Pavlov and other behaviorists have described a number of phenomena related to classical conditioning. Here we'll examine several of them: associative bias, importance of contingency, extinction, spontaneous recovery, generalization, stimulus discrimination, higher-order conditioning, and sensory preconditioning.

### *Associative Bias*

Characteristics of the would-be conditioned stimulus affect the degree to which conditioning occurs. The more noticeable (*salient*) a neutral stimulus—the extent to which it is bright, loud, or otherwise intense—the more likely it is to become a conditioned stimulus when experienced in conjunction with an unconditioned stimulus (Rachlin, 1991; B. Schwartz & Reisberg, 1991). Furthermore, some stimuli are especially likely to become associated with certain unconditioned stimuli; for example, food is more likely to become a conditioned stimulus associated with nausea (a UCS) than, say, a flash of light or the sound of a tuning fork. In other words, associations between certain stimuli are more likely to be made than are associations between others—a phenomenon known as **associative bias** (J. Garcia & Koelling, 1966; Hollis, 1997; B. Schwartz & Reisberg, 1991). Quite possibly, evolution has been at work here: Our ancestors could better adapt to their environments when they were predisposed to make associations that reflected true cause-and-effect relationships, such as associating nausea with the new food that induced it (Öhman & Mineka, 2003; Timberlake & Lucas, 1989).

### *Importance of Contingency*

Pavlov proposed that classical conditioning occurs when the unconditioned stimulus and would-be conditioned stimulus are presented at approximately the same time; that is, there must be **contiguity** between the two stimuli. But contiguity alone seems to be insufficient. As noted earlier, classical conditioning is most likely to occur when the conditioned stimulus is presented just *before* the unconditioned stimulus. It's less likely to occur when the CS and UCS are presented at *exactly* the same time, and it rarely occurs when the CS is presented *after* the UCS (e.g., R. R. Miller & Barnet, 1993). And in some cases, people develop an aversion to certain foods (recall my aversion to creamy cucumber dressing) when the delay between the conditioned stimulus (food) and the unconditioned stimulus (nausea) is as much as 24 hours (Logue, 1979).

More recent theorists have suggested that **contingency** is the essential condition: The potential conditioned stimulus must occur when the unconditioned stimulus is likely to follow—in other words, when the CS serves as a signal that the UCS is probably on its way (recall my earlier reference to “signal learning”). When two stimuli that are usually encountered separately occur together a few times by coincidence, classical conditioning is unlikely to occur (e.g., Gallistel & Gibbon, 2001; Rescorla, 1988; Vansteenwegen, Crombez, Baeyens, Hermans, & Eelen, 2000).

### *Extinction*

Let's return for a moment to Pavlov's dogs. Recall that the dogs learned to salivate at the sound of a bell alone after the bell had rung in conjunction with meat powder on several occasions. But what would happen if the bell continued to ring over and over without the meat powder's ever again being presented along with it? Pavlov discovered that repeated presentations of the conditioned stimulus *without* the unconditioned stimulus led to successively weaker and weaker conditioned responses. Eventually, the dogs no longer salivated at the sound of the bell; in other words, the conditioned response disappeared. Pavlov called this phenomenon **extinction**.

Sometimes conditioned responses will extinguish, and sometimes they won't. The unpredictability of extinction is a source of frustration to anyone working with people who have acquired undesirable, yet involuntary, conditioned responses. Later in the chapter, I'll identify some reasons why extinction doesn't always occur.

### ***Spontaneous Recovery***

Even though Pavlov quickly extinguished his dogs' conditioned salivation responses by repeatedly presenting the bell in the absence of meat powder, when he entered his laboratory the following day he discovered that the bell once again elicited salivation, almost as if extinction had never taken place. This reappearance of the salivation response after it had previously been extinguished is something Pavlov called **spontaneous recovery**.

In more general terms, spontaneous recovery is a recurrence of a conditioned response when a period of extinction is followed by a rest period. For example, if I am near lots of bees for a period of time, I eventually settle down and regain my composure. Upon encountering a bee on some later occasion, however, my first response is to fly off the handle once again.

Pavlov found that when a conditioned response appears in spontaneous recovery, it's typically weaker than the original conditioned response and extinguishes more quickly. In situations in which several spontaneous recoveries are observed (each one occurring after a period of rest), the reappearing CR becomes progressively weaker and disappears increasingly rapidly.

### ***Generalization***

You may recall that after Little Albert was conditioned to fear a white rat, he also became afraid of a rabbit, a dog, a white fur coat, cotton wool, and a fuzzy-bearded Santa Claus mask. When learners respond to other stimuli in the same way that they respond to conditioned stimuli, **generalization** is occurring. The more similar a stimulus is to the conditioned stimulus, the greater the probability of generalization. Albert exhibited fear of all objects that were white and fuzzy like the rat, but he wasn't afraid of his nonwhite, nonfuzzy toy blocks. In a similar way, a child who fears an abusive father may generalize that fear to other men, but not to women.

Generalization of conditioned responses to new stimuli is a common phenomenon (Bouton, 1994; N. C. Huff & LaBar, 2010; McAllister & McAllister, 1965). In some cases, generalization of conditioned fear responses may actually increase over time; that is, as time goes on, an individual may become fearful of an increasing number of objects. Thus, dysfunctional conditioned responses that don't quickly extinguish may sometimes become more troublesome as the years go by.

### ***Stimulus Discrimination***

Pavlov observed that when he conditioned a dog to salivate in response to a high-pitched tone, the dog would generalize that conditioned response to a low-pitched tone. To teach the dog the difference between the two tones, Pavlov repeatedly presented the high tone in conjunction with meat powder and presented the low tone without meat. After several such presentations of the two tones, the dog eventually learned to salivate only at the high tone. In Pavlov's terminology, *differentiation* between the two tones had taken place. Psychologists today more frequently use the term **stimulus discrimination** for this phenomenon.

Stimulus discrimination occurs when one stimulus (the CS+) is presented in conjunction with an unconditioned stimulus, and another stimulus (the CS-) is presented in the absence of the UCS. The individual acquires a conditioned response to the CS+ but either doesn't initially generalize the response to the CS- or, through repeated experiences, learns that the CS- doesn't

warrant the same response (N. C. Huff & LaBar, 2010). For example, if a child who is abused by her father simultaneously has positive interactions with other adult men, she isn't as likely to generalize her fear of her father to those other individuals.

**Higher-Order Conditioning**

Conditioned stimulus–response associations sometimes piggyback on one another. For example, if Pavlov conditioned a dog to salivate at the sound of a bell and then later presented the bell in conjunction with another neutral stimulus—say, a flash of light that had never been associated with meat—that neutral stimulus would also begin to elicit a salivation response. This phenomenon is known as **second-order conditioning** or, more generally, **higher-order conditioning**.

Higher-order conditioning works like this: First, a neutral stimulus ( $NS_1$ ) becomes a conditioned stimulus ( $CS_1$ ) by being paired with an unconditioned stimulus (UCS), so that it soon elicits a conditioned response (CR). Next, a second neutral stimulus ( $NS_2$ ) is paired with  $CS_1$ , and it, too, begins to elicit a conditioned response; that second stimulus has also become a conditioned stimulus ( $CS_2$ ). This process is diagrammed in Figure 3.2. Steps 1 and 2 depict the original conditioning; Steps 3 and 4 depict higher-order conditioning.

Higher-order conditioning provides a possible explanation for some seemingly irrational fears (e.g., Klein, 1987; Wessa & Flor, 2007). For instance, imagine that on several occasions failure at academic tasks (initially a neutral stimulus) is associated with painful physical punishment (a UCS that elicits a UCR of fear), to the point that failure (now a CS) begins to elicit considerable anxiety. Then another stimulus situation—perhaps a test, an oral presentation, or the general school environment—is frequently associated with failure. In this way, a student might develop test anxiety, fear of public speaking, or even school phobia—fear of school itself.

Higher-order conditioning might also explain certain attitudes we acquire toward particular people or situations (e.g., Kanekar, 1976). For example, let's return to the experiment involving Pokemon characters that I described earlier (Olson & Fazio, 2001). People aren't born with particular feelings about the words *awesome* or *awful*, nor do they necessarily have built-in reactions to pictures of hot fudge sundaes or cockroaches. Rather, people probably acquire particular

**Figure 3.2**  
An example of higher-order conditioning

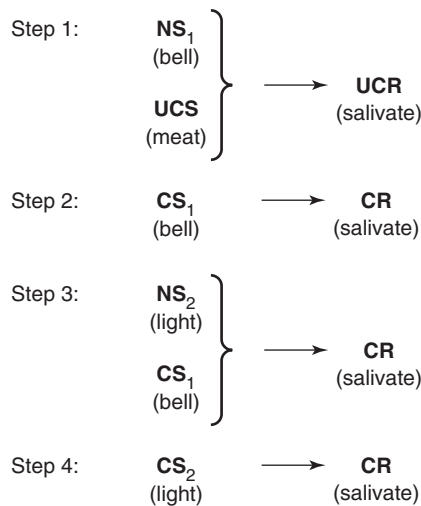



feelings about the words and images through their experiences over time, to the point where these stimuli can provide a starting point for further classical conditioning.

**Sensory Preconditioning**

**Sensory preconditioning** is similar to higher-order conditioning in that one stimulus–response association builds on another, but the steps occur in a different order. Let’s return one final time to Pavlov’s poor, overexploited dogs. Suppose that we first present the sound of a bell and a flash of light simultaneously. Then we pair the bell with meat powder. Not only do the dogs salivate in response to the sound of a bell but they also salivate in response to the flash of light.

In more general terms, sensory preconditioning occurs like this: First, two neutral stimuli (NS<sub>1</sub> and NS<sub>2</sub>) are presented simultaneously. Then one of these neutral stimuli (NS<sub>1</sub>) is associated with an unconditioned stimulus (UCS), thus becoming a conditioned stimulus (CS<sub>1</sub>) and eliciting a conditioned response (CR). In cases of sensory preconditioning, the second neutral stimulus (NS<sub>2</sub>) also elicits the conditioned response (i.e., NS<sub>2</sub> has become CS<sub>2</sub>) by virtue of its prior association with CS<sub>1</sub>.

Sensory preconditioning offers an alternative explanation for some cases of test anxiety (Klein, 1987). School (NS<sub>1</sub>) is first associated with tests (NS<sub>2</sub>). If school is later associated with some traumatic event (UCS), then not only will school become a conditioned stimulus (CS<sub>1</sub>) eliciting anxiety (CR) but tests may become a conditioned stimulus (CS<sub>2</sub>) as well. A diagram of how test anxiety might develop through sensory preconditioning is presented in Figure 3.3.

**Cognition in Classical Conditioning**

Many theorists now believe that classical conditioning often involves the formation of associations not between two stimuli but between internal *mental representations* of those stimuli (e.g., Bouton, 1994; Forsyth & Eifert, 1998; McDannald & Schoenbaum, 2009). Furthermore, the conditioned stimulus may enable an organism to *predict* (in a decidedly mental fashion) that the unconditioned stimulus is coming (Hollis, 1997; Jara, Vila, & Maldonado, 2006; Mineka & Zinbarg, 2006;

**Figure 3.3**  
An example of sensory preconditioning

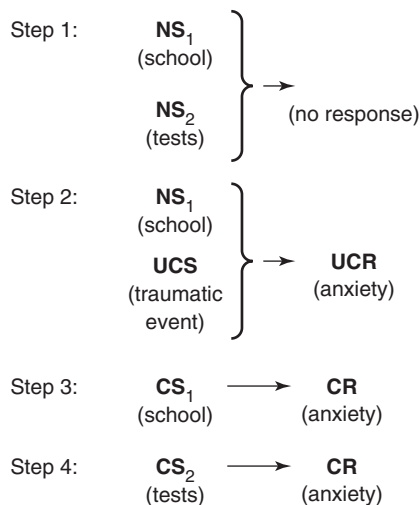

Rescorla, 1988). As you can see, then, behaviorists are now beginning to talk about the thinking processes that they so deliberately steered clear of in earlier years.

Classical conditioning doesn't *always* involve cognition, however. To be more precise, it doesn't necessarily involve conscious awareness (Baccus, Baldwin, & Packer, 2004; Campanella & Rovee-Collier, 2005; Papka, Ivry, & Woodruff-Pak, 1997).<sup>4</sup> For instance, when organisms receive certain drugs (e.g., morphine or insulin), the drugs, as unconditioned stimuli, naturally lead to certain physiological responses (e.g., reduced pain sensitivity or hypoglycemia). Curiously, stimuli presented prior to these drugs—perhaps a light, a tone, or the environmental context more generally—begin to elicit an *opposite* response (e.g., increased pain sensitivity or hyperglycemia), presumably to prepare for—in this case, to counteract—the pharmaceutical stimuli that will soon follow (e.g., Flaherty et al., 1980; S. Siegel, 1975, 1979).

Such physiological responses, which are almost certainly *not* consciously controlled by the recipients of the drugs, are one likely explanation for people's addictions to nicotine, alcohol, and street drugs. When habitual smokers and abusers of other substances return to environments in which they've previously used an addictive substance, their bodies respond in counteractive ways that make the substance even more desirable or seemingly necessary. Meanwhile, they develop greater tolerance to their substance of choice and need increasing quantities to gain the same "high" or other sought-after physiological state (C. A. Conklin, 2006; McDonald & Siegel, 2004; S. Siegel, 2005; S. Siegel, Baptista, Kim, McDonald, & Weise-Kelly, 2000).

## Changing Undesirable Conditioned Responses

Conditioned responses are often difficult to eliminate because they're involuntary: People have little or no control over them. Yet some classically conditioned responses (e.g., some irrational fears) can seriously impair everyday functioning. Two possible strategies for reducing counterproductive conditioned responses are extinction and counterconditioning.

### ***Extinguishing Undesirable Responses***

One obvious way to eliminate a conditioned response is through the process of extinction. If the conditioned stimulus is presented in the absence of the unconditioned stimulus frequently enough, the conditioned response should disappear. Often this is exactly what happens.

Unfortunately, however, extinction is notoriously undependable as a means of eliminating conditioned responses: It simply doesn't always work. There are several possible reasons why:

- The speed at which extinction occurs is unpredictable. If, during the conditioning process, the conditioned stimulus was sometimes presented in conjunction with the unconditioned stimulus but sometimes alone (i.e., the stimulus pairings were inconsistent), extinction is apt to be especially slow (Humphreys, 1939).
- People (and many other species as well) tend to avoid a stimulus they've learned to fear, thus reducing the chances that they might eventually encounter the conditioned stimulus in the absence of the unconditioned stimulus. (We'll look more closely at avoidance learning in Chapter 4.)

---

<sup>4</sup>Some theorists have suggested that the amygdala plays a key role in "thoughtless" forms of classical conditioning (Byrnes, 2001; LeDoux, 2003). As you may recall from Chapter 2, this structure within the limbic system is actively involved in connecting particular emotional reactions to particular stimuli.

- Through second-order conditioning, a wide variety of stimuli may have been associated with the original conditioned stimulus and thus have begun to elicit unproductive responses (e.g., extreme fear or anxiety). It can sometimes be quite difficult to extinguish all of these second-order conditioned responses—a problem that has been reported in people suffering from posttraumatic stress disorder (Wessa & Flor, 2007).
- Even when a response has been extinguished, it may reappear through spontaneous recovery. We can never be totally sure when a response will spontaneously recover and when it won't. Spontaneous recovery is especially likely to occur if extinction has occurred in only one context; the conditioned response is apt to reappear in contexts in which extinction hasn't taken place (Bouton, 1994).<sup>5</sup>

### ***Counterconditioning More Desirable Responses***

At its best, extinction merely eliminates a conditioned response, whereas **counterconditioning** replaces the response with a new, more productive one and, accordingly, tends to be more effective. Mary Cover Jones's (1924) classic work with "Little Peter" provides a good example. Peter was a 2-year-old boy who had somehow acquired a fear of rabbits. To rid Peter of his fear, Jones placed him in a high chair and gave him some candy. As he ate, she brought a rabbit into the far side of the same room. Under different circumstances the rabbit might have elicited anxiety; however, the pleasure Peter felt as he ate the candy was a stronger response and essentially overpowered any anxiety he might have felt about the rabbit's presence. Jones repeated the same procedure every day over a two-month period, each time putting Peter in a high chair with candy and bringing the rabbit slightly closer than she had on the preceding occasion, and Peter's anxiety about rabbits eventually disappeared. More recently, researchers have used a similar procedure in helping an 8-year-old boy lose his fear of electronically animated toys and holiday decorations (Ricciardi, Luiselli, & Camare, 2006).

In general, counterconditioning involves the following steps:

1. A new response that is **incompatible** with the existing conditioned response is chosen. Two responses are incompatible with each other when they cannot be performed at the same time. Because classically conditioned responses are often emotional in nature, an incompatible response is often some sort of opposite emotional reaction. For example, in the case of Little Peter, happiness was used as an incompatible response for fear. An alternative would be any response involving relaxation, because fear and anxiety involve bodily tension.
2. A stimulus that elicits the incompatible response must be identified; for example, candy elicited a "happy" response for Peter. If we want to help someone develop a happy response to a stimulus that has previously elicited displeasure, we need to find a stimulus that already elicits pleasure—perhaps a friend, a party, or a favorite food. If we want someone instead to acquire a relaxation response, we might ask that person to imagine lying in a cool, fragrant meadow or on a lounge chair by a swimming pool.

---

<sup>5</sup>Findings of one recent research study indicate that when a phobia is the result of a traumatic event, extinction can be quite effective if the extinction procedure is conducted within six hours after the event. Apparently such a rapid follow-up extinction procedure affects the brain's consolidation of the stimulus–response association (Schiller et al., 2010). (The role of consolidation in learning and memory is discussed in Chapters 2 and 9.)

3. The stimulus that elicits the new response is presented to the individual, and the conditioned stimulus eliciting the undesirable conditioned response is *gradually* introduced into the situation. In treating Peter's fear of rabbits, Jones first gave Peter some candy; she then presented the rabbit at some distance from Peter, only gradually bringing it closer and closer in successive sessions. The trick in counterconditioning is to ensure that the stimulus eliciting the desirable response always has a *stronger* effect than the stimulus eliciting the undesirable response; otherwise, the latter response might prevail.

A technique I recommend to many graduate students who dread their required statistics courses is essentially a self-administered version of counterconditioning. In particular, I suggest that math-phobic students find a math textbook that begins well below their own skill level—at the level of basic number facts, if necessary—so that the problems aren't anxiety arousing. As they work through the text, the students begin to associate mathematics with success rather than failure. Programmed instruction (described in Chapter 5) is another technique that can be useful in reducing anxiety about a given subject matter, because it allows a student to progress through potentially difficult material in small, easy steps.

Counterconditioning provides a means for decreasing or eliminating many conditioned anxiety responses. For instance, in **systematic desensitization**, people who are excessively anxious in the presence of certain stimuli are asked to relax while imagining themselves in increasingly stressful situations involving those stimuli; in doing so, they gradually replace anxiety with a relaxation response (Head & Gross, 2009; Wolpe, 1969; Wolpe & Plaud, 1997). Alternatively, people might virtually “experience” a series of stressful situations through the use of goggles and computer-generated images, all the while making a concerted effort to relax (P. Anderson, Rothbaum, & Hodges, 2003; Garcia-Palacios, Hoffman, Carlin, Furness, & Botella, 2002).

Systematic desensitization has been widely used as a means of treating such problems as test anxiety and fear of public speaking (Head & Gross, 2009; Hopf & Ayres, 1992; W. K. Silverman & Kearney, 1991). I should point out, however, that treating test anxiety alone, without remediating possible academic sources of a student's poor test performance as well, may reduce test anxiety without any concurrent improvement in test scores (Cassady, 2010b; Naveh-Benjamin, 1991; Tryon, 1980).

## EDUCATIONAL IMPLICATIONS OF BEHAVIORIST ASSUMPTIONS AND CLASSICAL CONDITIONING

---

From what we've learned so far about behaviorist ideas, we can derive several implications for instructional settings:

- ◆ *Practice is important.* From a behaviorist perspective, people are more likely to learn when they have a chance to *behave*—for instance, when they can talk, write, experiment, or demonstrate (e.g., Drevno et al., 1994; McDowell & Keenan, 2001; Warren et al., 2006). Ideally, then, students should be active respondents throughout the learning process, rather than simply passive recipients of whatever information or skill is being taught.

Many behaviorists have stressed the idea that repetition of stimulus–response associations strengthens those associations. If people need to learn responses to particular stimuli thoroughly, practice is essential. For example, students will learn basic addition and subtraction facts better

and recall them more quickly if they repeat those facts numerous times—perhaps through the use of flash cards or perhaps by applying those facts frequently in problem-solving tasks. In a similar way, many reading teachers believe that the best way for students to improve their reading level is simply to read, read, read.

◆ *Students should encounter academic subject matter in a positive climate and associate it with pleasant emotions.* The durability and generalizability of some classically conditioned responses point to the need for a positive classroom climate for students beginning on Day 1. Students should experience academic tasks in contexts that elicit pleasant emotions—feelings such as enjoyment, enthusiasm, and excitement—rather than in contexts that elicit anxiety, disappointment, or anger. When students associate academic subject matter with good feelings, they're more likely to pursue it of their own accord. For instance, when children's early experiences with books are enjoyable ones, they're more likely to read frequently and widely in later years (L. Baker, Scher, & Mackler, 1997).

In contrast, when schoolwork or a teacher is associated with punishment, humiliation, failure, or frustration, school and its curriculum can become sources of excessive anxiety. Some classroom activities—including tests, oral presentations, and difficult subject matter—are especially likely to be associated with unpleasant consequences such as failure or embarrassment, and students may soon become anxious when involved in them (Cassady, 2010a; Zeidner & Matthews, 2005).

Educators have often argued that school should be a place where a student encounters more success than failure, and classical conditioning provides a justification for their argument. To maximize such success, teachers should have students' existing knowledge, skills, and cognitive maturity in mind when they plan their curriculum, and they should provide the resources and assistance that students need to accomplish classroom tasks successfully. They should also take special precautions when asking students to perform difficult activities in front of others. For instance, when students must give oral presentations in class, their teacher might offer specific suggestions about what material to present and how to present it in such a way that classmates will react positively.

This is not to say, however, that students should *never* experience failure. As we'll discover in our discussion of Lev Vygotsky's theory in Chapter 13, challenging activities are more likely to promote cognitive growth than easy ones, and errors are inevitable when students must wrestle with difficult problems and tasks. But when students experience failure *too* frequently, either in their schoolwork or in their social relationships—for instance, when one or more peers regularly bully them—school can quickly become a conditioned stimulus that leads to such counterproductive conditioned responses as fear and anxiety. These responses, once conditioned, can be very resistant to extinction and thus can interfere with a student's ability to learn effectively for years to come.

◆ *To break a bad habit, a learner must replace one S–R connection with another.* You might think of a *bad habit* as an undesirable stimulus–response association. One early behaviorist (Guthrie, 1935) proposed three ingenious techniques specifically designed to break habits; the second and third reflect aspects of the *counterconditioning* approach described earlier:

- *Exhaustion method:* One way to break a stimulus–response habit is to continue to present the stimulus until the individual is too tired to respond in the habitual way. At that point, a new response will occur and a new S–R habit will form. For example, when breaking a bucking bronco, the persistent rider (the stimulus) stays on the horse's back until the

horse is too exhausted to buck any more, making way for a more desirable habit (e.g., a rider may now elicit standing-still behavior). Similarly, if a child is continually disrupting classroom activities with a certain behavior (e.g., cracking jokes, throwing objects across the room), a teacher might eliminate the behavior by having the child stay after school to continually repeat it until he or she is too tired to continue.

- *Threshold method*: Another way of breaking a habit is to begin by presenting the stimulus very faintly, so that the individual doesn't respond to it in the habitual manner. The intensity of the stimulus is then increased so gradually that the individual continues not to respond to it. For example, when a child has test anxiety—in other words, when a test stimulus leads to an anxiety response—a teacher might eliminate the child's anxiety by first presenting enjoyable tasks that only remotely resemble a test. Over time, the teacher can present a series of tasks that increasingly (but gradually) begin to take on testlike qualities.
- *Incompatibility method*: A third approach is to present the stimulus when the habitual response cannot occur and when an opposite, or *incompatible*, response will occur. For example, imagine a classroom of highly achievement-motivated students who are overly competitive with one another. To reduce their competitive spirit, the teacher might divide the class into small groups and assign each group an academic task that requires cooperation rather than competition (e.g., developing an argument for one side of an issue in a class debate). Assigning grades on the basis of group performance rather than individual performance should further increase the likelihood that students will cooperate rather than compete. Under such conditions, cooperative behavior should replace competitive behavior (C. Ames, 1984; D. W. Johnson & Johnson, 2009b).

◆ *Assessing learning involves looking for behavior changes*. Regardless of how effective a certain activity, lecture, or set of curriculum materials might potentially be, teachers should never assume that students are learning anything unless they actually observe students' behaviors changing as a result of instruction. Only behavior changes—for example, higher test scores, improved athletic performance, more appropriate social interaction skills, or better study habits—can ultimately confirm that learning has taken place.

## SUMMARY

Behaviorism encompasses a group of theories that share several common assumptions, including the generalizability of learning principles across species, the importance of focusing on observable events, and the largely blank-slate nature of organisms. Early behaviorists insisted that psychology could be a true science only if it defined learning as a behavior change, and they focused solely on stimulus–response relationships. Today, however, some behaviorists make a distinction between learning and behavior, and some believe that relationships between stimuli and responses can be better understood when cognitive factors are also considered.

One groundbreaking researcher in the behaviorist tradition was Ivan Pavlov, who proposed that many involuntary responses are acquired through a process of *classical conditioning*. Such conditioning occurs when two stimuli are presented close together in time. One is an *unconditioned stimulus (UCS)* that already elicits an *unconditioned response (UCR)*. The second stimulus, through its association with the unconditioned stimulus, begins to elicit a response as well: It becomes a *conditioned stimulus (CS)* that brings about a *conditioned response (CR)*. But if the conditioned stimulus is later presented numerous times in the absence of the unconditioned

stimulus, the conditioned response decreases and may eventually disappear (*extinction*). Nevertheless, it may reappear after a period of rest (*spontaneous recovery*).

Once an organism has learned to make a conditioned response in the presence of one conditioned stimulus, it may respond in the same way to a similar stimulus (*generalization*) unless the latter stimulus has repeatedly been experienced in the absence of the unconditioned stimulus (*stimulus discrimination*). Classically conditioned associations can build on one another through the processes of *higher-order conditioning* and *sensory preconditioning*; in both cases, a neutral stimulus may become a conditioned stimulus (eliciting a conditioned response), not directly by its association with the unconditioned stimulus, but indirectly by its association with another stimulus that either will be experienced or has previously been experienced in conjunction with the UCS.

Classical conditioning provides one possible explanation of how human beings acquire certain

physiological responses (e.g., increased sensitivity to pain), emotional responses (e.g., anxiety), and attitudes (e.g., like or dislike) toward particular stimuli. It also offers two strategies for eliminating such responses: extinction and *counterconditioning* (i.e., replacing unproductive S–R relationships with more productive ones).

Our discussion of behaviorism thus far has yielded several educational implications. First, active responding and practice are important ingredients in effective learning. Second, the classical conditioning paradigm underscores the importance of helping learners experience academic subject matter in contexts that elicit pleasant rather than unpleasant emotions. Third, eliminating undesirable behaviors (e.g., breaking a bad habit or avoiding growth-producing situations) must in one way or another involve replacing existing S–R connections with more productive ones. Finally, teachers can ultimately determine that learning has occurred *only* when they observe changes in students' behaviors.

## CHAPTER 4

---

# INSTRUMENTAL CONDITIONING

*Thorndike's Early Research*

*Rewards and Reinforcement*

*Skinner's Operant Conditioning*

*The Various Forms That Reinforcement Can Take*

*Punishment*

*Effective Forms of Punishment*

*Ineffective Forms of Punishment*

*Common Phenomena in Instrumental Conditioning*

*Superstitious Behavior*

*Shaping*

*Chaining*

*Extinction*

*Effects of Reinforcement Schedules*

*Avoidance Learning*

*Effects of Antecedent Stimuli and Responses in*

*Instrumental Conditioning*

*Cueing*

*Setting Events*

*Generalization*

*Stimulus Discrimination*

*Behavioral Momentum*

*Cognition and Motivation in Instrumental*

*Conditioning*

*Summary*

When my children were small, they often behaved in ways that they had learned would improve their circumstances. For example, when Alex needed money to buy something he desperately wanted, he engaged in behaviors he never did otherwise, such as mowing the lawn or scrubbing the bathtub. Jeff had less interest in money than his older brother, but he would readily clean up the disaster area he called his bedroom if doing so enabled him to have a friend spend the night.

My children also learned *not* to engage in behaviors that led to unpleasant consequences. For instance, soon after Tina reached adolescence, she discovered the thrill of sneaking out late at night to join friends at a local park or convenience store. Somehow she thought she would never be missed if she placed a doll's head on her pillow and stuffed a blanket under her bedspread to form the shape of a body. I can't say for sure how many times Tina tried this, but on two occasions I found the pseudo-Tina in bed and promptly locked the bedroom window Tina had intended to use on her return; given the chilly night air, Tina had no choice but to ring the doorbell to gain admittance to the house. After being grounded for two weeks for each infraction, Tina started taking her curfew more seriously.

The idea that consequences affect behavior has influenced psychologists' thinking for more than a century and has been especially prominent in behaviorist learning theories. In particular, behaviorists talk about **instrumental conditioning**: Humans and nonhuman animals alike tend to behave in ways that bring them desirable consequences or enable them to avoid unpleasant ones.

In this chapter, we'll examine the work of two early American behaviorists—Edward Thorndike and B. F. Skinner—who emphasized the importance of consequences in learning. We'll also look at research findings regarding the particular effects that rewards (more often called *reinforcers*) and punishments are likely to have on human behavior. As we go along, we'll occasionally derive strategies for classroom practice; however, we'll save preplanned, systematic applications of instrumental conditioning for Chapter 5, where we can give them our full attention.



## THORNDIKE'S EARLY RESEARCH

---

In 1898, Edward Thorndike introduced a theory of learning that emphasized the role of experience in the strengthening and weakening of stimulus–response connections; this perspective is sometimes referred to as **connectionism**<sup>1</sup> (Thorndike, 1898, 1911, 1913). In his doctoral dissertation, Thorndike placed a cat in a contraption he called a “puzzle box,” which had a door that opened when a certain device (e.g., a wire loop) was appropriately manipulated. Thorndike observed the cat engaging in numerous, apparently random behaviors in an effort to get out of the box; eventually, by chance, the cat triggered the mechanism that opened the door and allowed escape. When Thorndike put the cat in the box a second time, it again engaged in trial-and-error behaviors but managed to escape in less time than it had before. With subsequent returns to the box, the cat found its way out of the box within shorter and shorter time periods.

From his observations of cats in the puzzle box, Thorndike concluded that learning consists of trial-and-error behavior and a gradual “stamping in” of some behaviors and “stamping out” of others as a result of the consequences that various behaviors bring. We can sum up Thorndike’s *law of effect* as follows:

Responses to a situation that are followed by satisfaction are strengthened; responses that are followed by discomfort are weakened.

In other words, rewarded responses increase, and punished responses decrease and possibly disappear.

Thorndike’s original law of effect implied that reward and punishment have opposite but equal effects on behavior: One strengthens and the other weakens. But his later research (1932a, 1932b) indicated that punishment may not be terribly effective in weakening responses. In one experiment (Thorndike, 1932a), college students completed a multiple-choice Spanish vocabulary test in which they were to choose the correct English meanings of a variety of Spanish words. Each time a student chose the correct English meaning out of five alternatives, the experimenter said “Right!” (presumably rewarding the response); each time a student chose an incorrect alternative, the experimenter said “Wrong!” (presumably punishing the response). In responding to the same multiple-choice questions over a series of trials, the students increased the responses for which they had been rewarded but didn’t necessarily decrease those for which they had been punished. In his *revised law of effect*, Thorndike (1935) continued to maintain that rewards strengthen the behaviors they follow, but he deemphasized the role of punishment. Instead, he proposed that punishment has an *indirect* effect on learning: As a result of experiencing an annoying state of affairs, a learner may engage in certain other behaviors (e.g., crying or running away) that interfere with performance of the punished response.

Not all of Thorndike’s ideas have stood the test of time. His belief that satisfying consequences bring about changes in behavior—in other words, his belief that rewards promote learning—continues to be a key component of behaviorist perspectives today. His views on punishment have been more controversial. As you’ll see later in the chapter, many psychologists believe that under the right conditions, punishment can be quite effective in reducing behavior.

---

<sup>1</sup>Thorndike’s connectionism shouldn’t be confused with a more contemporary perspective, known as either *connectionism* or *parallel distributed processing*, that we’ll discuss in Chapter 10.

## REWARDS AND REINFORCEMENT

---

Partly as a result of Thorndike's early findings, research has focused more heavily on the effects of pleasant consequences than on the effects of unpleasant ones. In the upcoming pages, we'll look at Skinner's version of the "reward" part of Thorndike's law of effect; we'll then consider a variety of consequences that human beings might find rewarding (reinforcing).

### Skinner's Operant Conditioning

B. F. Skinner (1938, 1953, 1958, 1966b, 1971, 1989; Skinner & Epstein, 1982) is probably the best-known learning theorist in the behaviorist tradition. Like Thorndike, Skinner proposed that organisms acquire behaviors that are followed by certain consequences. In order to study the effects of consequences both objectively and precisely, Skinner developed a piece of equipment, now known as a *Skinner box*, that has gained widespread popularity in animal learning research. As shown in Figure 4.1, the Skinner box used in studying rat behavior includes a metal bar that, when pushed down, causes a food tray to swing into reach long enough for the rat to grab a food pellet. In the pigeon version of the box, instead of a metal bar, a lighted plastic disk is located on one wall; when the pigeon pecks the disk, the food tray swings into reach for a short time.

Skinner found that rats will learn to press metal bars and pigeons will learn to peck on plastic disks in order to get pellets of food. From his observations of rats and pigeons in their respective Skinner boxes under varying conditions, Skinner (1938) formulated a basic principle of **operant conditioning**, which can be paraphrased as follows:

A response that is followed by a reinforcer is strengthened and therefore more likely to occur again.

In other words, responses that are reinforced tend to increase in frequency, and this increase—a change in behavior—means that learning is taking place.

Skinner intentionally used the term *reinforcer* instead of *reward* to describe a consequence that increases the frequency of a behavior. The word *reward* implies that the stimulus or event following a behavior is somehow both pleasant and desirable, an implication Skinner wanted to

**Figure 4.1**

A prototypical Skinner box: The food tray swings into reach to provide reinforcement.



avoid for two reasons. First, some individuals will work for what others believe to be unpleasant consequences; for example, as a child my daughter Tina occasionally did something she knew would irritate me because she enjoyed watching me blow my stack. Second, like many behaviorists, Skinner preferred that psychological principles be restricted to the domain of objectively observable events. A reinforcer is defined not by allusion to “pleasantness” or “desirability”—both of which involve subjective judgments—but instead by its effect on behavior:

A **reinforcer** is a stimulus or event that increases the frequency of a response it follows. (The act of following a response with a reinforcer is called **reinforcement**.)

Notice how I have just defined a reinforcer totally in terms of observable phenomena, without reliance on any subjective judgment.

Now that I’ve given you definitions of both operant conditioning and a reinforcer, I need to point out a major problem: Taken together, the two definitions constitute circular reasoning. I’ve said that operant conditioning is an increase in a behavior when it’s followed by a reinforcer, but I can’t seem to define a reinforcer in any other way except to say that it increases behavior. I’m therefore using reinforcement to explain a behavior increase and a behavior increase to explain reinforcement! Fortunately, an article by Meehl (1950) has enabled learning theorists to get out of this circular mess by pointing out the **transituational generality** of a reinforcer: Any single reinforcer—whether it be food, money, a sleepover with a friend, or something else altogether—is likely to increase many different behaviors in many different situations.

Skinner’s principle of operant conditioning has proven to be a very useful and powerful explanation of why human beings often act as they do, and its applications to instructional and therapeutic situations are almost limitless. Virtually any behavior—academic, social, psychomotor—can be learned or modified through operant conditioning. Unfortunately, undesirable behaviors can be reinforced just as easily as desirable ones. Aggression and criminal activity often lead to successful outcomes: Crime usually *does* pay. And in school settings, disruptive behaviors can often get teachers’ and classmates’ attention when more productive behaviors don’t (Flood, Wilder, Flood, & Masuda, 2002; McGinnis, Houchins-Juárez, McDaniel, & Kennedy, 2010; J. C. Taylor & Romanczyk, 1994).

As a teacher, I keep reminding myself of what student behaviors I want to increase and try to follow those behaviors with positive consequences. For example, when typically quiet students raise their hands to answer a question or make a comment, I call on them and give them whatever positive feedback I can. I also try to make my classes not only informative but also lively, interesting, and humorous, so that students are reinforced for coming to class in the first place. Meanwhile, I try *not* to reinforce behaviors that aren’t in students’ long-term best interests. For instance, when a student comes to me at semester’s end pleading for a chance to complete an extra-credit project in order to improve a failing grade. I invariably turn the student down, for a simple reason: I want good grades to result from good study habits and high achievement throughout the semester, not from begging behavior at my office door. Teachers must be extremely careful about what they reinforce and what they don’t.

### ***Important Conditions for Operant Conditioning***

Three key conditions influence the likelihood that operant conditioning will occur:

- ◆ *The reinforcer must follow the response.* “Reinforcers” that precede a response rarely have an effect on the response. For example, many years ago, a couple of instructors at my university

were concerned that the practice of assigning course grades made students so anxious that they couldn't learn effectively. Thus, the instructors announced on the first day of class that all class members would receive a final course grade of A. Many students never attended class after that first day, so there was little learning with which any grade might interfere.

♦ *Ideally, the reinforcer should follow immediately.* A reinforcer tends to reinforce the response that immediately preceded it. As an example, consider Ethel, a pigeon I worked with when I was an undergraduate psychology major. My task was to teach Ethel to peck a plastic disk in a Skinner box, and she was making some progress in learning this behavior. But on one occasion I waited too long after her peck before reinforcing her, and in the meantime she had begun to turn around. After eating her food pellet, Ethel began to spin frantically in counterclockwise circles, and it was several minutes before I could get her back to the disk-pecking response.

Immediate reinforcement is especially important when working with young children and animals (e.g., Critchfield & Kollins, 2001; Green, Fry, & Myerson, 1994). Even many adolescents behave in ways that bring them immediate pleasure (e.g., partying on school nights) despite potentially adverse consequences of their behavior down the road (V. F. Reyna & Farley, 2006; Steinberg et al., 2009). Yet our schools are notorious for delayed reinforcement—for instance, in the form of end-of-semester grades rather than immediate feedback for a job well done.

♦ *The reinforcer must be contingent on the response.* Ideally, the reinforcer should be presented *only* when the desired response has occurred—that is, when the reinforcer is *contingent* on the response. For example, teachers often specify certain conditions that children must meet before going on a field trip: They must complete previous assignments, bring signed permission slips, and so on. When these teachers feel badly for children who haven't met the stated conditions and allow them to go on the field trip anyway, the reinforcement isn't contingent on the response, and the children aren't learning acceptable behavior. If anything, they're learning that rules can be broken.

### ***Contrasting Operant Conditioning with Classical Conditioning***

In both classical conditioning and operant conditioning, an organism shows an increase in a particular response. But operant conditioning differs from classical conditioning in three important ways (see Figure 4.2). As you learned in Chapter 3, classical conditioning results from the

	<b>Classical Conditioning</b>	<b>Operant Conditioning</b>
Occurs when	Two stimuli (UCS and CS) are paired	A response (R) is followed by a reinforcing stimulus ( $S_{Rf}$ )
Association acquired	CS $\longrightarrow$ CR	R $\longrightarrow$ $S_{Rf}$
Nature of response	Involuntary: elicited by a stimulus	Voluntary: emitted by the organism

**Figure 4.2**  
Differences between classical and operant conditioning

pairing of two stimuli: an unconditioned stimulus (UCS) and an initially neutral stimulus that becomes a conditioned stimulus (CS). The organism learns to make a new, conditioned response (CR) to the CS, thus acquiring a CS→CR association. The CR is automatic and involuntary, such that the organism has virtually no control over what it is doing. Behaviorists typically say that the CS *elicits* the CR.

In contrast, operant conditioning results when a response is followed by a reinforcing stimulus (we'll use the symbol  $S_{RF}$ ). Rather than acquiring an S→R association (as in classical conditioning), the organism comes to associate a response with a particular consequence, thus acquiring an R→ $S_{RF}$  association. The learned response is a voluntary one *emitted* by the organism, with the organism having complete control over whether the response occurs. Skinner coined the term *operant* to reflect the fact that the organism voluntarily *operates* on, and thereby has some effect on, the environment.

Some theorists have suggested that both classical and operant conditioning are based on the same underlying learning processes (G. H. Bower & Hilgard, 1981; Donahoe & Vegas, 2004). In most situations, however, the classical and operant conditioning models are differentially useful in explaining different learning phenomena, so many psychologists continue to treat them as distinct forms of learning.

## The Various Forms That Reinforcement Can Take

Behaviorists have identified a variety of stimuli and events that can reinforce and thereby increase learners' behaviors. They distinguish between two general categories of reinforcers: primary versus secondary. They also suggest that reinforcement can take either of two forms: positive or negative.

### *Primary versus Secondary Reinforcers*

A **primary reinforcer** satisfies a built-in, perhaps biology-based, need or desire. Some primary reinforcers are essential for physiological well-being; examples are food, water, oxygen, and warmth. Others enhance social cohesiveness and so indirectly enhance one's chances of survival; examples are physical affection and other people's smiles (Harlow & Zimmerman, 1959; Vollmer & Hackenberg, 2001). To some degree, there are individual differences regarding the extent to which certain consequences serve as primary reinforcers; for instance, sex is reinforcing for some individuals but not others, and a particular drug may be a primary reinforcer for a drug addict but not necessarily for a nonaddicted individual (e.g., Lejuez, Schaal, & O'Donnell, 1998).

A **secondary reinforcer**, also known as a *conditioned reinforcer*, is a previously neutral stimulus that has become reinforcing to a learner through repeated association with another reinforcer. Examples of secondary reinforcers, which don't satisfy any built-in biological or social needs, are praise, good grades, and money.<sup>2</sup>

How do secondary reinforcers take on reinforcing value? One early view involves classical conditioning: A previously neutral stimulus is paired with an existing reinforcer (UCS) that elicits a feeling of satisfaction (UCR) and begins to elicit that same sense of satisfaction (CR) (Bersh,

---

<sup>2</sup>One could argue that praise enhances social relationships and so might be a primary reinforcer. However, praise involves language—a learned behavior—and not all individuals find it reinforcing, hence its categorization as a secondary reinforcer (e.g., see Vollmer & Hackenberg, 2001).

1951; D'Amato, 1955). An alternative perspective is that secondary reinforcers provide information that a primary reinforcer might subsequently be coming (G. H. Bower, McLean, & Meachem, 1966; Fantino, Preston, & Dunn, 1993; Green & Rachlin, 1977; Mazur, 1993). The second explanation has a decidedly cognitive flavor to it: The learner is *seeking information* about the environment rather than simply responding to that environment in a “thoughtless” manner.

The relative influences of primary and secondary reinforcers in our lives probably depend a great deal on economic circumstances. When such biological necessities as food and warmth are scarce, these primary reinforcers, as well as secondary reinforcers closely associated with them (e.g., money), may be major factors in reinforcing behavior. But in times of economic well-being, when cupboards are full and houses are warm, such secondary reinforcers as praise and good grades are more likely to play major roles in the learning process.

### ***Positive Reinforcement***

When people think about stimuli and events that are reinforcing for them, they typically think about positive reinforcement. In particular, **positive reinforcement** involves the *presentation* of a stimulus after the response. Positive reinforcement can take a variety of forms: Some are **extrinsic reinforcers**, in that they're provided by the outside environment, whereas others come from within the learner.

**Material reinforcers** A **material reinforcer** (also known as a *tangible reinforcer*) is an actual object; food and toys are examples. Material reinforcers can be highly effective in changing behavior, especially for animals and young children. However, most psychologists recommend that at school, teachers use material reinforcers only as a last resort, when absolutely no other reinforcer works. Food, toys, trinkets, and similar items have a tendency to distract students from the things they should be doing in class and thus may be counterproductive over the long run.

**Social reinforcers** A **social reinforcer** is a gesture or sign (e.g., a smile, attention, or praise) that one person gives another, usually to communicate positive regard. In classroom settings, teacher attention, approval, and praise can be powerful reinforcers (P. Burnett, 2001; McKerchar & Thompson, 2004; N. M. Rodriguez, Thompson, & Baynham, 2010).<sup>3</sup> Attention or approval from peers can be highly reinforcing as well (F. E. Bowers, Woods, Carlyon, & Friman, 2000; Flood et al., 2002; Grauvogel-MacAleese & Wallace, 2010).

**Activity reinforcers** Speaking nonbehavioristically, an **activity reinforcer** is an opportunity to engage in a favorite activity. (Quick quiz: Which word is the nonbehaviorist part of my definition, and why?) David Premack (1959, 1963) discovered that people will often perform one activity if doing so enables them to perform another. His **Premack principle** for activity reinforcers is as follows:

When a normally high-frequency response follows a normally low-frequency response, the high-frequency response will increase the frequency of the low-frequency response.

A high-frequency response is, in essence, a response that a learner enjoys doing, whereas a low-frequency response is one that the learner doesn't enjoy. Another way of stating the Premack

---

<sup>3</sup>We should note here that praise has potential downsides, depending on the specific message it conveys and the context in which it's given; we'll examine its possible downsides in Chapters 16 and 17.

principle, then, is that learners will perform less-preferred tasks so that they can subsequently engage in more-preferred tasks.

To illustrate, I rarely do housework; I much prefer retreating to my home office to either read or write about human learning and behavior. I've found that I'm more likely to do household chores if I make a higher-frequency behavior, such as reading a mystery novel or hosting a party, contingent on doing the housework. In a similar way, appropriate classroom behavior can be improved through the Premack principle. For instance, young children can quickly be taught to sit quietly and pay attention if they're allowed to engage in high-frequency, high-activity behaviors (e.g., interacting with classmates) only after they've been quiet and attentive for a certain period of time (Azrin, Vinas, & Ehle, 2007; Homme, deBaca, Devine, Steinhorst, & Rickert, 1963).

**Positive feedback** In some instances, material and social reinforcers improve classroom behavior and lead to better learning of academic skills because they communicate a message that learners are performing well or making significant progress. Such **positive feedback** is clearly effective in bringing about desired behavior changes (Kladopoulos & McComas, 2001; S. Ryan, Ormond, Imwold, & Rotunda, 2002; Shute, 2008; R. E. Smith & Smoll, 1997).

I once spent a half hour each day for several weeks working with Michael, a 9-year-old boy with a learning disability who was having difficulty learning cursive letters. In our first few sessions together, neither Michael nor I could see any improvement, and we were both becoming increasingly frustrated. To give ourselves more concrete feedback, I constructed a chart on a sheet of graph paper and explained to Michael how we would track his progress by marking off the number of cursive letters he could remember each day. I also told him that as soon as he had reached a dotted line near the top of the page (a line indicating that he had written all 26 letters correctly) for three days in a row, he could have a special treat (his choice was a purple felt-tip pen). Michael's daily performance began to improve dramatically. Not only was he making noticeable progress but he also looked forward to charting his performance and seeing a higher mark each day. Within two weeks, Michael had met the criterion for his felt-tip pen: He had written all 26 cursive letters for three days in succession. As it turns out, the pen probably wasn't the key ingredient in our success: Michael didn't seem bothered by the fact that he lost it within 24 hours of earning it. Instead, I suspect that the concrete positive feedback about his own improvement was the true reinforcer that helped Michael learn.

Feedback is especially likely to be effective when it communicates what students have and haven't learned and when it gives them guidance about how they might improve their performance (Hattie & Timperley, 2007; Shute, 2008). Under such circumstances, even *negative* feedback can lead to enhanced performance. It's difficult to interpret this fact within a strictly behaviorist framework; it appears that students must be *thinking* about the information they receive and using it to modify their behavior and gain more favorable feedback later on.

**Intrinsic reinforcers** Oftentimes learners engage in certain behaviors not because of any external consequences but because of the internal good feelings—the **intrinsic reinforcers**—that such responses bring. Feeling successful after solving a difficult puzzle, feeling proud after returning a valuable item to its rightful owner, and feeling relieved after completing a difficult assignment are all examples of intrinsic reinforcers. People who continue to engage in responses for a long time without any obvious external reinforcers for their efforts are probably working for intrinsic sources of satisfaction.

The concept of intrinsic reinforcers doesn't fit comfortably within traditional behaviorism, which, as you should recall, focuses on external, observable events. Yet, for many students, the

true reinforcers for learning are probably the internal ones—the feelings of success, mastery, and pride—that their accomplishments bring. For such students, other reinforcers are more helpful if they provide feedback that academic tasks have been performed well. Grades may be reinforcing for the same reason: Good grades reflect high achievement—a reason to feel proud.

Positive feedback and the intrinsic reinforcement that such feedback brings are probably the most productive forms of reinforcement in the classroom. Yet teachers must remember that what is reinforcing for one student may not be reinforcing for another; reinforcement, like beauty, is in the eyes of the beholder. In fact, consistent positive feedback and resulting feelings of success and mastery can occur only when instruction has been carefully tailored to individual skill levels and abilities and only when students have learned to value academic achievement. When, for whatever reasons, students aren't initially interested in achieving academic success, then other reinforcers, such as social and activity reinforcers—even material ones if necessary—can be useful in helping students acquire the knowledge and skills that will serve them well in the outside world.

### ***Negative Reinforcement***

In contrast to positive reinforcement, **negative reinforcement** increases a response through the *removal* of a stimulus, usually an aversive or unpleasant one. Don't let the word *negative* lead you astray here. It's not a value judgment, nor does it mean that an undesirable behavior is involved; it simply refers to the fact that something is being *taken away* from the situation. For example, imagine a rat in a Skinner box that often gives the rat an unpleasant electric shock. When the rat discovers that pressing a bar terminates the shock, its bar-pressing behavior increases considerably. Similarly, some cars emit an annoying sound if the keys are still in the ignition when the driver's door is opened; removal of the keys from the ignition is negatively reinforced (and so will presumably increase in frequency) because the sound stops.

Removal of guilt or anxiety can be an extremely powerful negative reinforcer for human beings. A child may confess to a crime committed days or weeks earlier because she feels guilty about the transgression and wants to get it off her chest. Anxiety may drive one student to complete a term paper early, thereby removing an item from his things-to-do list. Another student confronted with the same term paper might procrastinate until the last minute, thereby removing anxiety—if only temporarily—about the more difficult aspects of researching for and writing the paper.

Negative reinforcement probably explains many of the *escape* behaviors that humans and nonhumans learn. For instance, rats that are given a series of electric shocks will quickly learn to turn a wheel that enables them to escape to a different, shock-free environment (N. E. Miller, 1948). Likewise, children and adolescents acquire various ways of escaping unpleasant tasks and situations in the classroom and elsewhere. Making excuses (“My dog ate my homework!”) and engaging in inappropriate classroom behaviors provide means of escaping tedious or frustrating academic assignments (Dolezal & Kurtz, 2010; A. W. Gardner, Wacker, & Boelter, 2009; McKerchar & Thompson, 2004; Romaniuk et al., 2002). Lying about one's own behaviors (“I didn't do it—he did!”) is potentially a way of escaping the playground supervisor's evil eye. Complaints about nonexistent stomachaches, chronic truancy, and dropping out of school are ways of escaping the school environment altogether. Some escape responses are productive ones, of course; for instance, many teenagers acquire tactful ways of rebuffing unwanted sexual advances or leaving a party where alcohol or drugs are in abundance.

Keep in mind that negative reinforcement can affect the behavior of teachers as well as the behavior of students. Teachers often behave in ways that get rid of aversive stimuli; for example,



Common escape responses



they may use classroom discipline strategies (responses such as yelling at students or promising less homework) that eliminate unpleasant stimuli (disorderly conduct) over the short run but are ineffective over the long run. As an illustration, if Ms. Jones yells at Marvin for talking too much, Marvin may temporarily stop talking, which negatively reinforces Ms. Jones's yelling behavior.<sup>4</sup> But if Marvin likes getting Ms. Jones's attention (a positive reinforcer for him), he will be chattering again before very long.

Let's return to the title of this chapter: "Instrumental Conditioning." Instrumental conditioning encompasses not only the behavior-increasing effect of reinforcement—an effect that Skinner called *operant conditioning*—but also the behavior-suppressing effect of punishment. We turn to punishment now.

## PUNISHMENT

Most behaviorists define **punishment** in terms of its effect on behavior: It decreases the frequency of the response it follows. Punishment can take either of two forms. **Punishment I** involves the *presentation* of a stimulus, typically an aversive one—perhaps a scolding or a failing grade. **Punishment II** involves the *removal* of a stimulus, usually a pleasant one; examples are monetary fines for misbehaviors (because money is being taken away) and loss of privileges. Figure 4.3 illustrates the differences among positive reinforcement, negative reinforcement, Punishment I, and Punishment II.

Stimulus is	Nature of Stimulus	
	Pleasant	Aversive
Presented after the response	Positive Reinforcement (response increases)	Punishment I (response decreases)
Removed after the response	Punishment II (response decreases)	Negative Reinforcement (response increases)

**Figure 4.3**  
Contrasting positive reinforcement, negative reinforcement, and punishment

<sup>4</sup>Although behaving in a disruptive fashion is a response that Marvin makes, in this situation it serves as a *stimulus* that Ms. Jones wants to eliminate.

**Figure 4.4**  
Negative reinforcement and Punishment I differ in terms of which occurs first—the aversive stimulus or the response.

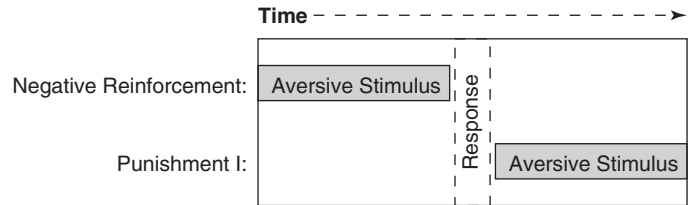

Many people mistakenly use the term *negative reinforcement* when they're really talking about punishment. Although both phenomena may involve aversive stimuli, they differ in two critical respects. First, as you've seen, they have opposite effects: Negative reinforcement *increases* the frequency of a response, whereas punishment *decreases* it. A second crucial difference concerns the order of events. With negative reinforcement, the aversive stimulus *stops* when the response is emitted. With Punishment I, however, the aversive stimulus *begins* when the response is emitted. Figure 4.4 illustrates this difference graphically. The termination of an aversive stimulus negatively reinforces a response; the initiation of an aversive stimulus punishes a response.

Early research by both Thorndike (1932a, 1932b) and Skinner (1938) indicated that punishment was unlikely to reduce the behavior it followed. For instance, Skinner (1938) found that when rats were punished for a response that had previously been reinforced, the response was temporarily suppressed but soon returned to its prepunishment frequency. But later research revealed that punishment *can* be effective in many situations. As a result, many behaviorists have revived the “punishment” part of Thorndike's original law of effect, asserting that responses followed by an unpleasant state of affairs are, in fact, weakened (e.g., Conyers et al., 2004; Lerman & Vorndran, 2002; G. C. Walters & Grusec, 1977).

Oftentimes punishment decreases behaviors very quickly. For example, in one study (R. V. Hall et al., 1971, Experiment 1), punishment virtually eliminated the aggressive behavior of 7-year-old Andrea, who was deaf. Initially, Andrea often pinched and bit both herself and anybody else with whom she came in contact; the frequency of such responses (an average of 72 per school day) was so high that normal academic instruction was impossible. Following a period of data collection without any intervention (a *baseline* period), punishment for each aggressive act began: Whenever Andrea pinched or bit, her teacher pointed at her sternly and shouted “No!” Figure 4.5 shows the changes in Andrea's behavior. (The brief *reversal* to a nonreinforcement baseline period on day 25 was used to minimize the likelihood that other factors were responsible for the behavior change.) Even though Andrea was deaf, the shouting and pointing virtually eliminated her aggressiveness.

## Effective Forms of Punishment

Several forms of punishment have been shown to be effective in reducing inappropriate behaviors in children and adolescents. Three of them—verbal reprimands, restitution, and overcorrection—involve imposing presumably unpleasant consequences and thus are examples of Punishment I. Three others—time-out, in-house suspension, and response cost—involve the withdrawal of reinforcers and thus are examples of Punishment II.

**Figure 4.5**

Number of bites and pinches by Andrea during the school day  
 Reprinted with permission from  
 “The Effective Use of Punishment to Modify Behavior in the Classroom” by R. V. Hall, S. Axelrod, M. Foundopoulos, J. Shellman, R. A. Campbell, & S. S. Cranston, 1972, in K. D. O’Leary & S. O’Leary (Eds.), *Classroom Management: The Successful Use of Behavior Modification*, p. 175. Copyright 1972 by Pergamon Press, Ltd.

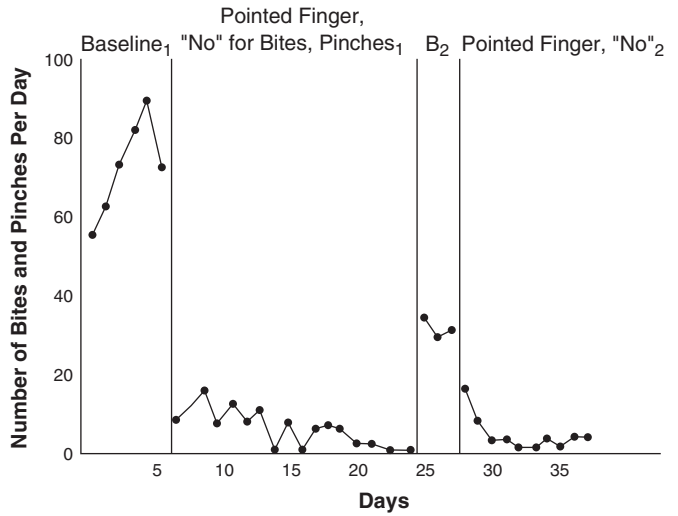

**Verbal reprimands** Although some students find teacher attention of any kind to be reinforcing, most students (like Andrea) regard a **verbal reprimand**—a scolding or admonishment—as punishment (Landrum & Kauffman, 2006; Pfiffner & O’Leary, 1987; Van Houten, Nau, MacKenzie-Keating, Sameoto, & Colavecchia, 1982). In general, reprimands are most effective when they’re immediate, brief, and unemotional. They also tend to work best when spoken quietly and in close proximity to the person being punished, perhaps because they’re less likely to draw the attention of peers. Ideally, too, a reprimand should communicate that the individual is capable of better behavior (Parsons, Kaczala, & Meece, 1982; Pintrich & Schunk, 2002).

**Restitution and overcorrection** Restitution and overcorrection involve requiring learners to take actions that correct the results of their misdeeds. In **restitution**, a misbehaving individual must return the environment to the same state of affairs that it was in before the misbehavior. As examples, a child who breaks a window must pay for a new one, and a child who makes a mess must clean it up. Restitution is a good example of a *logical consequence*, whereby the punishment fits the crime (Dreikurs, 1998; Landrum & Kauffman, 2006; Nucci, 2001).

In the case of **restitutional overcorrection**, the punished individual must make things *better* than they were before the inappropriate behavior (Foxy & Azrin, 1973; Foxy & Bechtel, 1983; Rusch & Close, 1976). For example, a student who throws food in the lunchroom might be asked to mop the entire lunchroom floor, or the student who offends a classmate might be asked to apologize to the entire class.

**Positive-practice overcorrection** involves having an individual repeat an action, but this time doing it correctly, perhaps in an exaggerated fashion. For instance, a student who runs dangerously down the school corridor might be asked to back up and then *walk* (perhaps at a normal pace, or perhaps very slowly) down the hall. Similarly, a student in a drivers’ education class who neglects to stop at a stop sign might be asked to drive around the block, return to the same intersection, and come to a complete stop (perhaps counting aloud to five) before proceeding.

Teachers have given mixed views regarding the value of restitutive overcorrection and positive-practice overcorrection as methods of bringing about behavior improvement in school settings. In some cases, these techniques can be overly time consuming and draw unnecessary attention to the punished behavior. When such approaches *are* used, they tend to be more effective if teachers portray them more as means for helping students acquire appropriate behavior than as punishment per se (Alberto & Troutman, 2009; R. G. Carey & Bucher, 1986; Schloss & Smith, 1994; Zirpoli & Melloy, 2001).

**Time-out** A **time-out** involves placing a misbehaving individual in a dull, boring (but not scary) situation—perhaps a separate room designed especially for time-outs, a little-used office, or a remote corner of a classroom. A person in time-out has no opportunity for social interaction and no opportunity to obtain reinforcement. A key to using time-out effectively is that the inappropriate behavior must *stop* before the person is released from the time-out situation; *release from time-out* (a negative reinforcer) is therefore contingent on appropriate behavior.

Time-out effectively reduces a variety of noncompliant, disruptive, and aggressive behaviors (e.g., Pfiffner, Barkley, & DuPaul, 2006; Rortvedt & Miltenberger, 1994; A. G. White & Bailey, 1990). In classrooms, short time-outs that don't allow students to escape assigned tasks and therefore don't interfere with students' academic learning are especially effective (Skiba & Raison, 1990).

**In-house suspension** At school, **in-house suspension** is similar to a time-out in that punished students are placed in a quiet, boring room within the school building. However, it typically lasts one or more days rather than only a few minutes, with students being continually monitored by a school staff member. Students bring their schoolwork to the suspension room and must work quietly on classroom assignments. Thus, they have little opportunity for the social interaction with peers that so many of them find reinforcing, and they can't escape from or fall behind in academic subjects they dislike.

Although in-house suspension hasn't been systematically investigated through controlled research studies, teachers and school administrators report that these programs are often effective in reducing chronic misbehaviors, especially when part of the suspension session is devoted to teaching appropriate behaviors and tutoring academic skills and when the supervising teacher acts as a supportive resource rather than as a punisher (Gootman, 1998; J. A. Huff, 1988; J. D. Nichols, Ludwin, & Iadicola, 1999; Pfiffner et al., 2006; J. S. Sullivan, 1989).

**Response cost** **Response cost** involves the withdrawal of a previously earned reinforcer. A ticket for speeding (resulting in the payment of a fine) and the loss of previously earned privileges are examples. Response cost has been shown to reduce such misbehaviors as aggression, inappropriate language, disruptiveness, hyperactivity, and tardiness (Conyers et al., 2004; Iwata & Bailey, 1974; Kazdin, 1972; Rapport, Murphy, & Bailey, 1982). It's especially effective when it's combined with reinforcement for appropriate behavior and when learners don't lose *everything* they've earned by making a few missteps within an overall pattern of desirable behavior (Landrum & Kauffman, 2006; E. L. Phillips, Phillips, Fixsen, & Wolf, 1971).

The forms of punishment just described are most likely to be effective when they alert learners to the seriousness of their misbehaviors and when the punisher communicates the message that "I care about you and want you to behave in ways that will help you be happy and productive over the long run." The punisher should also monitor the effects of the specific

consequence being administered. For example, some children—for instance, those who want to escape an unpleasant task or occasionally enjoy a little time to themselves—are apt to find time-outs to be reinforcing rather than punishing (Alberto & Troutman, 2009; McClowry, 1998; Solnick, Rincover, & Peterson, 1977), and so their “punished” behaviors will increase rather than decrease.

## Ineffective Forms of Punishment

Several forms of punishment typically *aren't* recommended: physical punishment, psychological punishment, extra classwork, and out-of-school suspension. A fifth—missing recess—gets mixed reviews.

**Physical punishment** Mild physical punishment (e.g., giving a slap on the wrist or a gentle spanking) may sometimes be the only means of keeping very young children from engaging in potentially harmful behaviors. For example, the toddler who takes delight in sticking metal objects into electrical outlets must be quickly informed in no uncertain terms that such behavior can't continue. However, most experts advise against physical punishment for school-age children; furthermore, its use in the classroom is *illegal* in many places. The use of physical punishment with older children can lead to such undesirable behaviors as resentment of the teacher, inattention to school tasks, lying, aggression, vandalism, avoidance of school tasks, and truancy (Doyle, 1990; Hyman et al., 2004; Landrum & Kauffman, 2006; Lansford et al., 2005). Physical punishment also provides a model of aggression, thus communicating the message that aggression is acceptable (Landrum & Kauffman, 2006). Occasional *mild* physical punishment doesn't appear to be correlated with behavior problems later on, although in some cases it can escalate into physical abuse (Baumrind, Larzelere, & Cowan, 2002; Gunnoe & Mariner, 1997; Kazdin & Benjet, 2003).

**Psychological punishment** Any consequence that seriously threatens a student's self-esteem or emotional well-being is **psychological punishment**, which isn't recommended (Brendgen, Wanner, Vitaro, Bukowski, & Tremblay, 2007; G. A. Davis & Thomas, 1989; Hyman et al., 2004; J. E. Walker & Shea, 1995). Embarrassing remarks and public humiliation can lead to some of the same side effects as physical punishment (e.g., resentment of the teacher, inattention to

Physical punishment models aggression.



school tasks, truancy from school) and have the potential to inflict long-term psychological harm. By deflating students' self-perceptions, psychological punishment can also lower their expectations for future performance and their motivation to learn and achieve (see the discussions of *self-efficacy* in Chapters 6 and 16).

**Extra classwork** Asking a student to complete makeup work for time missed at school is a reasonable and justifiable request. But assigning extra classwork or homework beyond that required for other students is inappropriate if it's assigned simply to punish a student's wrongdoing (H. Cooper, 1989; Corno, 1996). In this case there's a very different side effect: A teacher inadvertently communicates the message that schoolwork is unpleasant.

**Out-of-school suspension** Out-of-school suspension—in its most severe form this becomes permanent expulsion from school—is usually *not* an effective means of changing a student's behavior (American Psychological Association Zero Tolerance Task Force, 2008; Fenning & Bohanon, 2006; Gregory, Skiba, & Noguera, 2010). Many chronically misbehaving students are those who have difficulty with their academic work; for example, many high school troublemakers are students with poor reading skills. Suspending such students from school puts these students at an even greater disadvantage and decreases still further their chances for academic success. Additionally, when students find school to be an aversive situation, removal from that environment is negatively reinforcing rather than punishing. (Unfortunately, it's also negatively reinforcing to the school administrators who have gotten rid of their troublemakers.)

**Missing recess** In some situations missing recess may be a logical consequence for students who fail to complete their schoolwork during regular class time due to off-task behavior. Yet research indicates that, especially at the elementary level, students can more effectively concentrate on school tasks when they have occasional breaks from academic activities (Maxmell, Jarrett, & Dickerson, 1998; Pellegrini & Bohn, 2005; Pellegrini, Huberty, & Jones, 1995). Perhaps the best piece of advice is to withdraw recess privileges infrequently, if at all, and to monitor the effectiveness of such a consequence on students' classroom behavior over the long run.

Out-of-school suspension is not an effective punishment.

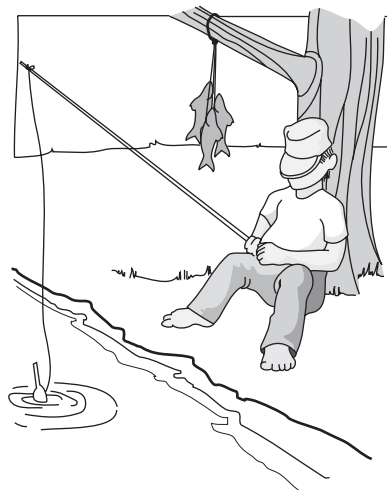

## COMMON PHENOMENA IN INSTRUMENTAL CONDITIONING \_\_\_\_\_

Researchers have observed a variety of phenomena related to instrumental conditioning. We now look at several common ones.

### Superstitious Behavior

Conditioning can sometimes occur even when events happen randomly and aren't contingent on anything the learner has done. For example, Skinner once left eight pigeons in their cages overnight with the food tray mechanism adjusted to give reinforcement at regular intervals, regardless of what responses the pigeons were making at the time. By morning, six of the pigeons were acting bizarrely. One repeatedly thrust its head into an upper corner of the cage, and two others were swinging their heads and bodies in rhythmic pendulum movements (B. F. Skinner, 1948).

Randomly administered reinforcement tends to reinforce whatever response has occurred immediately beforehand, and a learner will increase that response, thus displaying what Skinner called **superstitious behavior**. A nonbehaviorist way of describing the learning of a superstitious behavior is that the learner thinks that the response and reinforcement are related when in fact they aren't. For example, a student might wear a "lucky sweater" on exam days, and a star athlete might perform a certain ritual before every game.<sup>5</sup>

In the classroom, superstitious behavior can occur when students don't know which of their many responses are responsible for bringing about reinforcement. It behooves teachers to ensure that classroom reinforcers such as praise, attention, and grades are contingent on desired behaviors and that response–reinforcement contingencies are clearly specified.

### Shaping

In order to be reinforced for a response, a learner must, of course, first *make* the response. Sometimes, however, a learner lacks either the skill or the inclination to make a particular response. To handle such a situation, Skinner introduced a method called **shaping**. To shape a new behavior, we begin by reinforcing the first response that in any way approximates that behavior and then continue to reinforce it until the learner is emitting it fairly frequently. At that point, we reinforce only those responses that more closely resemble the desired behavior, then those that resemble it more closely still, until eventually only the desired behavior itself is being reinforced. In other words, shaping is a process of reinforcing successively closer and closer approximations to the desired behavior until that behavior is exhibited. Hence this procedure is sometimes called *successive approximations*.

To illustrate, when I taught my pigeon Ethel to peck a disk in her Skinner box, I began by reinforcing her every time she faced the wall on which the disk was located. Once this response was occurring frequently, I began to reinforce her only when she moved her beak near the wall, then only when she touched the wall with her beak, then only when she pecked within a 2-inch

---

<sup>5</sup>Such behaviors can actually improve performance by enhancing people's self-confidence regarding the activity at hand and thereby also increasing persistence in the activity (Damisch, Stoberock, & Mussweiler, 2010). This self-confidence is an example of *self-efficacy*—a cognitivist concept central to social cognitive theory (Chapter 6).

radius of the disk, and so on. Within an hour, I had Ethel happily pecking the disk and eating the food pellets that followed each correct peck.

Legend has it that a group of students once shaped a professor of mine a few days after he had given a lecture on shaping. Every time the professor stood on the side of the classroom near the door, the students appeared interested in what he was saying, sitting forward in their seats and feverishly taking notes. Every time he walked away from the door, they acted bored, slouching in their seats and looking anxiously at their watches. As the class went on, they reinforced the professor only as he moved closer and closer to the door until, by the end of class, he was lecturing from the hallway.<sup>6</sup>

In much the same way, teachers gradually shape a variety of academic skills and classroom behaviors as children move through the grade levels. In school, for example, children are first taught to print their letters on wide-lined paper, and they're praised for well-formed letters that fit appropriately within the lines. As the children progress through the primary grades, the spaces between the lines become smaller, and teachers are fussier about how well the letters are written. Eventually, many children begin to write consistently sized and carefully shaped letters with the benefit of only a lower line, and eventually with no line at all. Teachers also shape the sedentary behavior of their students: As students grow older, teachers expect them to sit quietly in their seats for longer and longer periods.

In a similar manner, teachers may inadvertently shape undesirable behavior. Let's say that a student named Molly frequently exhibits such disruptive responses as talking out of turn and physically annoying other students. Molly's teacher, Mr. Smith, realizes that because he's been reprimanding her for these responses, he's actually been giving her the attention that she craves and so in essence has been reinforcing her for her disruptiveness. Mr. Smith decides not to reinforce Molly's disruptive behavior anymore. Unfortunately, although Mr. Smith can easily ignore minor infractions, he finds himself unable to ignore more extreme disruptions and so reprimands Molly for them. Rather than discouraging Molly's disruptive behavior, then, Mr. Smith is actually shaping it: He's unintentionally insisting that Molly be *very* disruptive, rather than just a little disruptive, in order to get reinforcement.

## Chaining

Learners can also acquire a *sequence* of responses through shaping. For example, when visiting a tourist trap in South Dakota many years ago, I watched a chicken play a solitary version of "baseball" on a 3-foot baseball diamond. As soon as the chicken heard the appropriate signal (triggered by the quarter I deposited in the side of its cage), it hit a ball with a horizontal bar (a "bat") that swiveled at home plate and then ran the bases; once it returned to home plate, it found food in its feeding tray. The chicken's trainer had probably taught the chicken this complex sequence by first reinforcing only the final response (running to home plate), then reinforcing the last two responses (running to third base and then to home plate), then reinforcing the last three (running to second base, third base, and home plate), and so on, eventually reinforcing only the entire sequence.

---

<sup>6</sup>Other students have reported the same rumor about their own professors. I suspect that the story may be one of those urban legends that has little or no basis in fact. It does provide a vivid example, however, and so I've included it here.



This process of first reinforcing just one response, then reinforcing two responses in a row, then reinforcing a sequence of three, and so on is called **chaining**. Just as a chicken can learn to play baseball, so, too, can people learn lengthy, fairly complex behaviors through chaining. For example, students in a tennis class might learn to hold their rackets a certain way, then stand with their feet apart facing the net as they watch for the ball, then move toward an approaching ball and adjust their position appropriately, and then swing their rackets to meet the ball. Similarly, students in a first-grade classroom might learn to put their work materials away, sit quietly at their desks, and then line up single file at the classroom door before going to lunch. Such complex actions are often acquired more easily one step at a time—in other words, through chaining.

Let's return to Somjai, the elephant whose painting of an elephant appears in Chapter 1. Although the specific techniques that trainers use to teach elephants to create such paintings is a closely guarded secret, I suspect that their approach involves a combination of shaping and chaining. First, of course, Somjai's trainer would have needed to shape general painting behavior: Somjai had to learn to hold the brush with his trunk, point the brush toward the easel, apply an appropriate amount of pressure on the brush as it touched the canvas, move the brush across the canvas, and so on. Once Somjai had acquired basic painting skills, the trainer may have reinforced him for painting a horizontal-but-slightly-curved line (an elephant's "back") across the middle of the canvas, then for painting a back plus the top of a head, then for painting a back, head, and front-of-trunk, and so on. With time, practice, and persistence, Somjai learned a very lengthy chain of responses indeed.<sup>7</sup>

## Extinction

In classical conditioning, a conditioned response (CR) decreases and may eventually disappear—that is, the response undergoes extinction—when the conditioned stimulus (CS) is repeatedly presented in the absence of the unconditioned stimulus (UCS). In contrast, **extinction** in *instrumental conditioning* occurs when a response decreases in frequency because it no longer leads to reinforcement. For example, class clowns who find that people no longer laugh at their jokes are likely to decrease their joke telling. Students who are never called on when they raise their hands may stop trying to participate in class discussions. Students who continue to fail exams despite hours of studying may eventually stop studying.

In the initial stages of the extinction process, we may sometimes see a brief *increase* in the behavior being extinguished—a phenomenon known as an **extinction burst** (Lerman & Iwata, 1995; Lerman, Iwata, & Wallace, 1999; McGill, 1999). We may also see increased variability in the kinds of responses that are exhibited (Rachlin, 1991). For example, students who find themselves doing poorly on exams may try studying more or studying differently; if such efforts continue to meet with failure, however, their studying behavior will eventually decrease and perhaps disappear altogether.

---

<sup>7</sup>The procedure I describe for teaching a chicken to play baseball illustrates *backward chaining*, which begins with the final response in the sequence and then adds, one by one, the responses that need to precede it. The procedure I describe for teaching Somjai to paint an elephant illustrates *forward chaining*, reinforcing the first response in the sequence and then adding subsequent responses to the sequence that is reinforced. Research yields mixed results regarding the relative effectiveness of these two approaches with human beings (Zirpoli & Melloy, 2001).

Although teachers certainly want to extinguish undesirable behaviors (e.g., disruptive joke telling), they should make sure that *desirable* behaviors are reinforced frequently enough that they *don't* extinguish. For example, if a teacher sees one or more students failing at classroom assignments time after time despite their best efforts, the teacher should look for the root of the problem. If only one student is failing, perhaps that student needs help in developing more appropriate study techniques, more individualized instruction, or placement in a situation better matched to his or her current knowledge and skills. But if many students find the same assignments too difficult to accomplish, perhaps the assignments or related instructional practices require modification.

## Effects of Reinforcement Schedules

One important factor affecting the rates of both conditioning and extinction is the consistency of reinforcement (e.g., Pipkin & Vollmer, 2009; Staddon & Higa, 1991). To illustrate how consistency plays a role, consider this fantasy I have for the handful of students in my classes each semester who don't read the assigned textbook:

The student is locked in a small room. The textbook lies on a nearby table. Every time the student opens the book to one of the assigned pages and looks at the page, a small piece of delicious junk food falls from a hole in the ceiling.

Essentially, I would like to put unmotivated students into my own version of a Skinner box—the Ormrod box!

Now imagine 20 students in 20 Ormrod boxes. Ten of these students, randomly selected, are in Group A: They receive a piece of junk food every time they open the textbook and look at it. The other 10 are in Group B: They get junk food for some of their book-reading responses (perhaps one response out of every four) but receive nothing for their efforts the rest of the time. Group A is receiving **continuous reinforcement**: Every response is reinforced. Group B is receiving **intermittent reinforcement**: Some instances of the desired response are reinforced and some are not. Which group is going to increase its textbook-reading behavior faster? The answer, of course, is Group A, the group with continuous reinforcement. Continuously reinforced responses are acquired faster than intermittently reinforced responses.

Now suppose that after a few hours in their respective Ormrod boxes, all 20 students have begun to show a high frequency of textbook-reading responses, so I turn off the junk-food-dropping mechanisms. Which students are first going to notice that they are no longer being reinforced? The answer again is Group A. Students who have been reinforced for every single response will notice rather quickly that reinforcement has stopped, and their textbook reading should extinguish rapidly (unless, of course, they find such behavior intrinsically reinforcing). In contrast, Group B students have been receiving reinforcement for only 25% of their responses, so they're accustomed to nonreinforcement; these students will probably continue to read their textbooks for some time before they realize that reinforcement has ceased. Intermittently reinforced responses are extinguished more slowly than continuously reinforced responses.

Behaviorists usually recommend reinforcing a response continuously until it occurs in the desired form and at the desired frequency. After that, it should be maintained through intermittent reinforcement so that it doesn't extinguish. Intermittent reinforcement can follow a variety of **reinforcement schedules**, each of which has different effects on resistance to extinction and on the frequency and pattern of the response being reinforced. We now look at several schedules and the behavior patterns that result from each one.

### **Ratio Schedules: Reinforcing a Certain Number of Responses**

A **ratio schedule** is one in which reinforcement occurs after a certain number of responses have been emitted. That particular number can either be constant (a fixed-ratio schedule) or vary from one reinforcement to the next (a variable-ratio schedule).

**Fixed ratio (FR)** In a fixed-ratio schedule, a reinforcer is presented after a certain constant number of responses have occurred. For example, reinforcement might occur after every third response (a 1:3 ratio schedule) or after every 50th response (a 1:50 schedule). Such a reinforcement schedule can lead to a high and consistent response rate over an indefinite period of time; for example, pigeons whose pecking is maintained on a high-ratio schedule may peck as often as 10 times per second (Ferster & Skinner, 1957).

One strategy for preventing extinction is to use a series of ratio schedules that increasingly stretch out the reinforcement-to-response ratio (e.g., Luczynski & Hanley, 2010; Poling, 2010). This approach was once taken with a 6-year-old boy who had been unable to acquire basic reading skills (Whitlock, 1966). At first the boy was asked to read words presented to him on flash cards. Every time he read a word correctly, he received a plastic poker chip as a reinforcer, reflecting a continuous reinforcement schedule. He could trade jars of 36 poker chips for a variety of activities; for example, with two jars he could play a game, and with seven jars he could watch a cartoon. Once the boy was able to read from beginning reader storybooks, he was reinforced on a 1:2 fixed-ratio schedule; that is, he received one chip for every two words he read correctly. Eventually he was reinforced for every four words (a 1:4 schedule), then for every page (one reinforcer for every 10 to 25 words), then for every story (one reinforcer for every 50 to 70 words), and finally for every four stories. After 15 sessions of such individualized instruction, reinforcement was phased out altogether, and the boy was placed in his classroom's regular reading program; three months later, he was still reading at grade level. (One thing has always struck me about this study: Because so many poker chips were required to "purchase" an activity, the boy must actually have bought very few activities. I suspect that his increasing success in reading was the true reinforcer.)

When introduced through a series of successively higher ratios, ratio schedules even as high as 1:1000 have been found to maintain a response, at least in laboratory animals (Ferster & Skinner, 1957). In fact, high ratios typically lead to higher rates of responding than low ratios (Collier, Hirsh, & Hamlin, 1972; Stephens, Pear, Wray, & Jackson, 1975). However, learners operating under high-ratio schedules often exhibit a **postreinforcement pause**—a temporary decrease in responding, or "coffee break" of sorts—after each reinforced response (Ferster & Skinner, 1957; Rickard, Body, Zhang, Bradshaw, & Szabadi, 2009).

**Variable ratio (VR)** A variable-ratio schedule is one in which reinforcement is presented after a particular, yet *continually* changing, number of responses have been emitted. This kind of schedule is described by the average number of responses needed to obtain reinforcement. For example, in a 1:5 VR schedule, reinforcement might first take place after four responses, then after seven more, then after three, and so on, with five responses being the average. As you can see, the occurrence of reinforcement in a VR schedule is somewhat unpredictable. Thus, responses that are maintained on a VR schedule can be highly resistant to extinction—there's always a chance that the next response might pay off.

Playing a Las Vegas slot machine is an example of a response reinforced on a variable-ratio schedule. The more times you insert a quarter into the machine, the more times you'll be

Telemarketing is reinforced on a variable-ratio schedule.

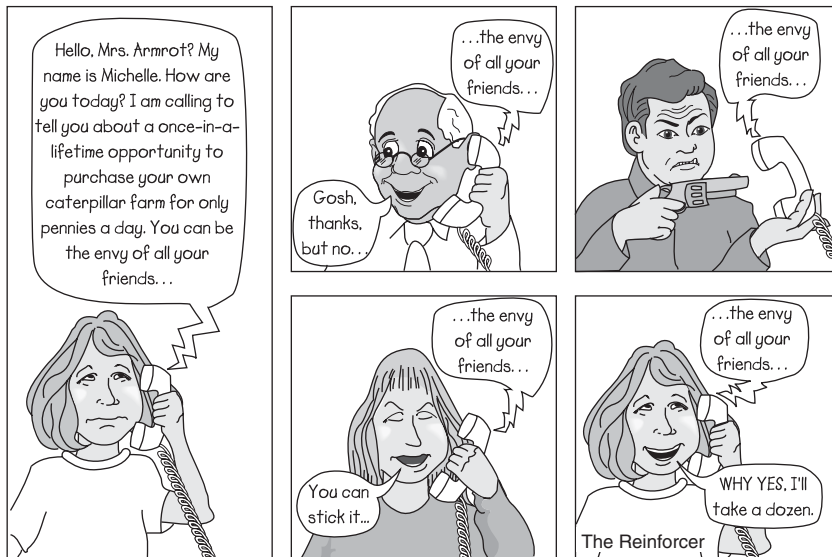

reinforced by having quarters come back out again, but those quarters don't come out after any predictable number of quarters have been inserted. In a similar way, telemarketing is reinforced on a VR schedule. The greater the number of calls made, the greater the number of sales, but the caller never knows just which call will lead to reinforcement.

When my daughter Tina was in elementary school, I often found myself frustrated with one of her friends, a girl whom I'll call "Margaret." Margaret was annoyingly persistent whenever she wanted something; she seldom took "no" for an answer. A possible source of her persistence became clear one evening when Tina and I had dinner at a restaurant with Margaret and her mother. The girls gobbled their food quickly and went off to explore the restaurant while we mothers sipped our coffee. Margaret quickly returned to the table with a request:

- "Mom, can I have a quarter for a video game?"
- "No."
- "Please, Mom?"
- "I said no, Margaret."
- "But Tina has one." (I look innocently into space.)
- "No."
- "I'll pay you back as soon as we get home."
- "No, Margaret."
- "*Pretty please?!?*" (Margaret puts on a desperate face.)
- "Oh, all right, here's a quarter."

Margaret's asking behaviors were probably on a variable-ratio reinforcement schedule: She had learned that persistently badgering her mother eventually paid off.

### ***Interval Schedules: Reinforcing the First Response after a Time Period***

An **interval schedule** is one in which reinforcement is contingent on the first response emitted after a certain time interval has elapsed. This interval can either be constant (a fixed-interval schedule) or vary from one reinforcement to the next (a variable-interval schedule).

**Fixed interval (FI)** With a fixed-interval schedule, reinforcement is contingent on the first response emitted after a particular, constant amount of time has gone by. For example, the learner may be reinforced for the first response emitted after 5 minutes, regardless of how many responses may or may not have been made during those 5 minutes. Following reinforcement, an additional 5 minutes must elapse before a response is reinforced.

We don't see a very high rate of responding with a FI schedule, nor do we see much resistance to extinction. Furthermore, a fixed-interval schedule produces a unique response pattern: Following reinforcement, the response rate tapers way off in a postreinforcement pause until the end of the time interval approaches, at which point responding picks up again (e.g., Jarmolowicz, Hayashi, & Pipkin, 2010; Ludvig & Staddon, 2004; Shimoff, Catania, & Matthews, 1981). To illustrate, when my daughter Tina was in fifth grade, she had a spelling test every Friday. She got the week's list of spelling words each Monday and therefore had four evenings in which to study the list. Occasionally she began on Wednesday, but more often she waited until Thursday night to study her spelling. If we were to graph Tina's studying behavior, it might look something like the graph in Figure 4.6. This "scallop" pattern is typical of behaviors reinforced on a fixed-interval schedule. For instance, in the U.S. Congress, bill-passing behavior increases considerably within the months preceding an election—when Congress members are seeking votes and campaign contributions—and drops off considerably after the election (Critchfield, Haley, Sabo, Colbert, & Macropolis, 2003).

**Variable interval (VI)** In a variable-interval schedule, reinforcement is contingent on the first response emitted after a certain time interval has elapsed, but the length of the interval changes from one occasion to the next. For example, the learner may be reinforced for the first response after 5 minutes, then the first response after 8 minutes, then the first response after 2 minutes, and so on, with the VI schedule being identified by the average time interval.

Checking email is an example of a response that, for many people, is reinforced on a variable-interval schedule. For example, perhaps you check your email three or four times a day to see if anything important has arrived in your in-box. Often you'll find only junk mail and phishing ("Hello, I'm [So-and-So], attorney representing a long-lost relative who has left you 8.5 million dollars; please send me your full name, bank account routing number, passport number . . ."), but occasionally you'll find one or more messages you actually want. An interval schedule rather than

**Figure 4.6**

Responses reinforced on a fixed-interval schedule show a "scallop" pattern.

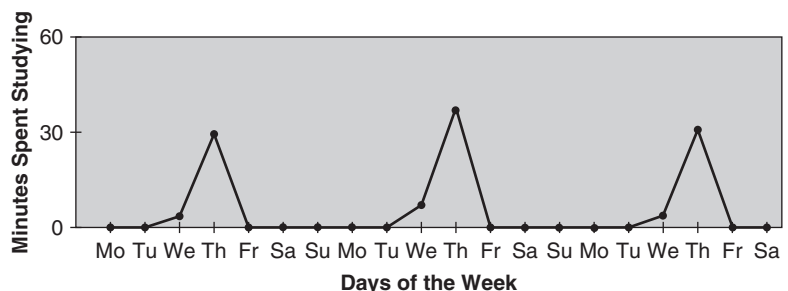

a ratio schedule is at work here: You occasionally need to check your in-box in order to get reinforcement (i.e., desired messages), but checking it a lot—say, every 5 to 10 minutes—won't *increase* the amount of email reinforcement you receive.

In a similar way, students who have been told that there's always the possibility of an unannounced ("pop") quiz in class are likely to study a little bit every night. They never know on exactly which day their studying will pay off. Your pattern of checking email and students' patterns of studying for pop quizzes are typical of the response pattern observed for variable-interval schedules: a slow, steady rate of responding. The longer the average time interval until reinforcement, the slower the response rate will be (e.g., Catania & Reynolds, 1968; Dack, McHugh, & Reed, 2009). (Please note that for other reasons, pop quizzes are generally not recommended. They may increase students' anxiety levels in the classroom, and, as you'll discover in Chapter 16, high levels of anxiety interfere with learning. Furthermore, pop quizzes don't allow for the fact that students' extracurricular activities and family obligations sometimes prevent completion of schoolwork the same day it's assigned.)

For both ratio and interval schedules, variable schedules lead to steadier response rates and greater resistance to extinction than fixed schedules do, probably because of the unpredictability of reinforcement: There's always the possibility that the next response will pay off. In most cases, a variable ratio is recommended for a high rate of responding, with a variable-interval schedule being better for a slow yet steady pace. Ideally, when continuous reinforcement is first replaced by intermittent reinforcement, the ratio should be small (e.g., 1:2 or 1:3) or the time interval short. The ratio or interval can then gradually be increased until the responses continue with very little reinforcement at all.

### ***Differential Schedules: Reinforcing Rates of Responding***

When a *particular rate* of responding is required, a **differential schedule of reinforcement** is appropriate: A specific number of responses occurring within a specific length of time leads to reinforcement. Researchers have investigated the effects of reinforcing both high and low rates of responding.

***Differential rate of high responding (DRH)*** A DRH schedule provides reinforcement only when a specific, *large* number of responses (or even more responses than that) have occurred within a particular time period. For example, consider Tina's friend Margaret, the girl who persistently asked her mother for money to play a video game. Margaret may actually have been on a DRH schedule rather than a variable-ratio schedule, in that she had to ask for a quarter several times *all at once* to get reinforcement. With a ratio schedule, the time it takes to emit the necessary number of responses is irrelevant, but with a DRH schedule, this time period is critical. Because a DRH schedule requires many responses in a short amount of time, a high response rate is typical.

Theoretically, studying for regularly scheduled exams is really on a DRH schedule: The more studying that occurs in a short time period, the greater the probability of reinforcement at exam time. Unfortunately, many students instead treat exams as fixed-interval schedules and so exhibit a goof-off-now-and-cram-later pattern of studying (Klein, 1987).

***Differential rate of low responding (DRL)*** A DRL schedule reinforces the first response after a certain length of time in which the learner has *not* made the response at all. This might sound like a fixed-interval schedule, but remember that in an FI schedule, responses during the

time interval, although not reinforced, are otherwise acceptable. One example of a response on a DRL schedule is trying to start a car with a flooded engine. In order to successfully start the engine, you must wait for a few minutes before trying again.

Students' requests for their teacher's assistance are an example of responses that might be most appropriately reinforced on a DRL schedule. Reinforcing students continuously when they ask for the teacher's help might lead to a high rate of such requests, resulting in overdependence on the teacher. In contrast, reinforcing students who ask for help only after they've been working independently for a while will teach them that independence with occasional questions is quite acceptable. It's important to note, however, that learning the appropriate response pattern for a DRL schedule can take a considerable amount of time, because it requires one *not* to perform a previously reinforced behavior (G. S. Reynolds, 1975).

## Avoidance Learning

Like most colleges and universities, my former university in Colorado had many faculty committees. When I first joined the faculty as an assistant professor, I eagerly agreed to serve on committees whenever I could, perceiving them to be a means of meeting other faculty members and having input into university decision making. But before long, I discovered that many faculty committees spend years chewing on the same issues without ever arriving at consensus or otherwise accomplishing very much. Having many other responsibilities on my plate (preparing for classes, grading papers, conducting research—not to mention raising three children), I was frustrated by the amount of time I was wasting in such unproductive activities. The unpleasant feelings I experienced during meetings were aversive stimuli—they were punishing my go-to-a-meeting behavior. I soon found myself inventing excuses to leave meetings early (“I’m so sorry, but I must take my son to the dentist”). In other words, I was acquiring escape behaviors that led to negative reinforcement. Eventually I stopped volunteering to join committees, enabling me to avoid these aversive events altogether.

In general, **avoidance learning** is the process of learning to stay away from an aversive stimulus—perhaps one that causes pain, anxiety, or frustration. For avoidance learning to occur, a learner must have some sort of **pre-aversive stimulus**, a cue signaling the advent of the aversive stimulus. For example, rats who hear a buzzer and are then given an electric shock quickly learn to jump a hurdle as soon as they hear the buzzer (a pre-aversive stimulus) and can thereby avoid the painful shock (Mowrer, 1938, 1939). Similarly, children quickly learn to pull a brass handle as soon as a light flashes so that they can avoid an unpleasantly loud noise (N. M. Robinson & Robinson, 1961). In my case, announcements of committee meetings and requests for new members were pre-aversive stimuli telling me that committee-avoiding behaviors were in order.

Avoidance learning can take either of two forms. In **active avoidance learning**, the learner must actively make a particular response to avoid an aversive event. Unfortunately, studying behavior is, for many folks, an instance of active avoidance learning. Ideally, studying should be an enjoyable activity in its own right (thereby providing intrinsic reinforcement), but many people don't enjoy it in the least. (I, for one, would much rather read a mystery novel or watch a television game show.) By studying fairly regularly, most students are able to avoid an aversive stimulus—a failing grade. Consider how rarely studying behavior occurs when there's no signal of possible impending doom (no pre-aversive stimulus), such as an assigned research report or an upcoming exam.

**Figure 4.7**  
Learning to fear a pre-aversive stimulus through classical conditioning

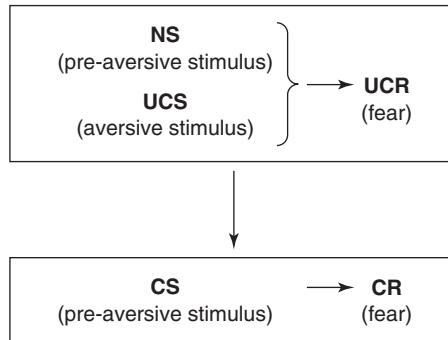

In **passive avoidance learning**, learners learn that *not* making a particular response allows them to avoid an aversive event. For example, people who feel awkward and uncomfortable in social situations tend not to go to parties or other social events. Likewise, students who have trouble working with numbers rarely sign up for advanced math or statistics classes if they can help it.

From a behaviorist perspective, avoidance learning may sometimes be a two-step process that involves both classical conditioning and instrumental conditioning (Eelen & Vervliet, 2006; Katagiri, 1987; Mowrer, 1956). In the first step, because the pre-aversive stimulus and the aversive stimulus are presented close together in time, the learner learns to fear the pre-aversive stimulus through a process of classical conditioning, as alluded to in Chapter 3 and illustrated in Figure 4.7. In the second step, an avoidance response leads to negative reinforcement (escape from the fear-inducing pre-aversive stimulus) and possibly also intrinsic positive reinforcement (feelings of relief about the escape).

Avoidance behaviors are difficult to extinguish: Even when a previously aversive situation has lost all sources of unpleasantness, people continue to avoid it and thus have no opportunity to learn that the situation is now a fairly comfortable one. For example, some students may regularly associate mathematics with frustration and failure and, through classical conditioning, acquire a fear of math. These students may avoid math classes indefinitely, even after they've developed the knowledge and skills they need for comprehending previously troublesome concepts. If they never again enroll in a math class, they'll never learn that they have nothing to fear!

Undoubtedly the best way to deal with avoidance behaviors in the classroom is to *prevent* them from being learned in the first place—something that can best be accomplished by minimizing aversive classroom events (see Chapter 3). Another alternative is to extinguish any classically conditioned fear responses to pre-aversive stimuli through systematic desensitization (again see Chapter 3). A third approach is less “warm and fuzzy”—that is, it may initially engender some hard feelings—but can sometimes work quite well. In particular, we simply prevent learners from *making* unproductive avoidance responses, thereby enabling them to discover that they have nothing to fear about a situation. For example, a school advisor or counselor might insist that a chronically math-anxious student enroll in a math class; once in class, the student might discover that mathematics can be a rewarding rather than frustrating experience. In some circumstances, students don't necessarily know what's best for them.



## EFFECTS OF ANTECEDENT STIMULI AND RESPONSES IN INSTRUMENTAL CONDITIONING

---

Up to this point I've portrayed instrumental conditioning as involving associations between responses and the consequences (reinforcements or punishments) that come immediately after those responses. Yet humans and nonhumans alike learn to make different responses in different contexts. For instance, in our discussion of avoidance learning, we discovered that avoidance behaviors occur only when there's a pre-aversive stimulus of some kind to signal an upcoming aversive situation. More generally, some stimuli and responses, known as **antecedent stimuli** and **antecedent responses**, set the stage for certain behaviors to follow and, perhaps, for other behaviors *not* to follow. Here we'll look at several concepts—cueing, setting events, generalization, and discrimination—that involve antecedent stimuli, as well as at one concept—behavioral momentum—that involves antecedent responses.

### Cueing

In his theory of operant conditioning, Skinner acknowledged that organisms often learn that a particular response leads to reinforcement only when a certain stimulus—something he called a **discriminative stimulus**—is present. This antecedent stimulus doesn't directly elicit the response as it does in classical conditioning. Rather, it increases the probability that the response will be followed by reinforcement; in Skinner's words, it "sets the occasion" for the response to be reinforced. We might diagram the relationship this way (we'll use the symbol S+ to represent the discriminative stimulus):

$$(S+) R \rightarrow S_{Rf}$$

When an organism is more likely to make certain responses in the presence of certain stimuli, behaviorists say that the organism is under **stimulus control**.

In the classroom, the discriminative stimuli that set the occasions for certain desired behaviors aren't always obvious ones; for example, the only naturally occurring stimulus that sets the occasion for cleaning up work materials and getting ready to go to lunch might be a clock on the wall that says 11:55. Under such circumstances, teachers can provide additional discriminative stimuli that let students know how to behave—a strategy often called **cueing** or **prompting**.

Sometimes cueing involves nonverbal signals that remind students about desired responses. For example, during a cooperative learning activity, a teacher might quickly flash the overhead light on and off a few times to remind students to talk quietly rather than loudly. In other situations, verbal cues are more helpful. For instance, an elementary teacher whose class is preparing to go to the lunchroom might cue students by saying "Walk quietly and in single file" and then allowing them to proceed only if they behave as instructed. A middle school science teacher who wants to give students a subtle reminder about the importance of completing an in-class reading assignment might say, "After you've all finished reading the section about great apes on pages 69 through 72, I'll tell you about tomorrow's field trip to the zoo."

Teachers can also use cueing to remind students about what responses are apt to lead to punishment. For example, a teacher could use body language (a scowl or furrowed brow), physical proximity (moving close to a student), or a brief verbal comment ("Lucy, put the magazine

away”) to discourage disruptive or off-task behaviors (Emmer, 1987; Northup et al., 1995; Woolfolk & Brooks, 1985).

Simple cues can be effective in nonclassroom settings as well. For instance, when people leave grocery stores, restaurants, or community centers, employees or signs that tell them to “buckle up” increase the likelihood that they’ll fasten their seat belts as they drive away (e.g., J. Austin, Alvero, & Olson, 1998; Clayton & Helms, 2009; M. G. Cox & Geller, 2010).

## Setting Events

Some behaviorists talk not about specific stimuli but instead about complex environmental conditions—**setting events**—under which certain behaviors are most likely to occur (e.g., M. Carter & Driscoll, 2007; C. A. Davis & Fox, 1999). For example, preschoolers are more likely to interact with their peers during free play time if they have a relatively small area in which to play and if available toys (balls, puppets, toy housekeeping materials) encourage group activity (W. H. Brown, Fox, & Brady, 1987; Frost, Shin, & Jacobs, 1998; S. S. Martin, Brady, & Williams, 1991). And chronically disruptive students are more likely to behave appropriately during independent seat-work when student desks are arranged in traditional rows that minimize face-to-face contact with classmates (Wannarka & Ruhl, 2008).

## Generalization

When a learner has learned to respond in a certain way in the presence of one stimulus (the S+), it may respond in the same way in the presence of other stimuli—a phenomenon called **generalization**.<sup>8</sup> Just as is true in classical conditioning, generalization in instrumental conditioning is most likely to occur when a new stimulus is similar to a previously learned antecedent stimulus. For example, students in a kindergarten classroom (the classroom being the S+) often learn such desired classroom behaviors as raising their hands and waiting to be called on before speaking. Such behaviors are more likely to generalize to a similar situation (such as a first-grade classroom) than to a dissimilar situation (such as the family dinner table). This tendency to generalize more readily as stimuli become more similar to the original discriminative stimulus is known as a **generalization gradient**.

## Stimulus Discrimination

In classical conditioning, stimulus discrimination occurs when one stimulus (the CS+) is presented in conjunction with an unconditioned stimulus, and another stimulus (the CS−) is presented in the absence of the UCS. A similar phenomenon happens in instrumental

---

<sup>8</sup>Behaviorists sometimes distinguish between *stimulus generalization*—that is, responding in the same, previously learned way to a similar stimulus—and *response generalization*—that is, making a response similar to one that has previously been acquired and reinforced. Our focus here is on stimulus generalization.

conditioning: A response may be reinforced in the presence of one stimulus (S+) but not in the presence of another stimulus (which we'll symbolize as S-):<sup>9</sup>

$$\begin{aligned}(S+) R &\rightarrow S_{Rf} \\(S-) R &\rightarrow \emptyset \text{ (no response)}\end{aligned}$$

Learning under what circumstances a response will and won't be reinforced is instrumental conditioning's form of **stimulus discrimination**. Stimulus discrimination is essentially a process of learning that a conditioned response made in the presence of S+ should not be generalized to S-.

As an example, in one research study, children in three elementary classrooms were having trouble determining appropriate times to request a teacher's assistance. Their teachers began to wear green and red leis at different times and told the children, "While I am wearing the green lei [the S+], I will be able to answer your questions. While I am wearing the red lei [the S-], I will not be able to answer your questions." This simple procedure minimized student requests at inopportune moments (Cammilleri, Tiger, & Hanley, 2008, p. 301).

## Behavioral Momentum

In many cases learners are more likely to make desired responses if they are already making similar responses—a phenomenon known as **behavioral momentum**. A study with low-achieving adolescents (Belfiore, Lee, Vargas, & Skinner, 1997) illustrates this phenomenon nicely. Two girls (Allison, age 14, and Roberta, age 15) had a history of refusing to do the academic tasks their teachers assigned. The researchers found that they could encourage the two students to work on difficult three-digit multiplication problems if they first gave the girls some simple one-digit problems. More generally, teachers can promote behavioral momentum by assigning easy or enjoyable tasks that lead naturally into more complex and potentially frustrating ones (Ardoin, Martens, & Wolfe, 1999; K. Lane, Falk, & Wehby, 2006; Mace et al., 1988; Nevin, Mandell, & Atak, 1983).

## COGNITION AND MOTIVATION IN INSTRUMENTAL CONDITIONING \_\_\_\_\_

Many behaviorists now propose that instrumental conditioning can best be understood when we consider nonobservable mental processes as well as observable stimuli and responses. For example, they talk about an organism forming *expectations* as to what reinforcer or punishment is likely to follow a particular response (e.g., Colwill, 1993; M. Gil, De Marco, & Menzel, 2007; Rachlin, 1991). They find that humans and nonhumans alike form mental *categories* of stimuli to which they respond; to illustrate, pigeons can be trained to respond differently to (and thus discriminate among) pictures of cats, flowers, cars, and chairs (Wasserman, 1993). And behaviorists are beginning to use such phrases as *paying attention* to discriminative stimuli, mentally *encoding* and finding *meaning* in response–reinforcement relationships, and *seeking information* about the environment—words and phrases with definite cognitive overtones.

---

<sup>9</sup>Skinner instead used the symbols S<sup>D</sup> (for discriminative stimulus) and S<sup>Δ</sup> ("S-delta," with the Δ being a commonly used symbol for representing change). In my discussion here, I've used S+ and S- to make the parallel to stimulus discrimination in classical conditioning more obvious.

Motivation, too, has increasingly come into the picture. In general, the larger and more appealing a reinforcer, the faster a response will be learned and the more frequently it will be exhibited (J. W. Atkinson, 1958; S. Siegel & Andrews, 1962; K. Silverman, Preston, Stitzer, & Schuster, 1999; Trosclair-Lasserre, Lerman, Call, Addison, & Kodak, 2008). Even so, as noted at earlier points in the chapter, different learners are apt to find different consequences reinforcing and punishing. And in fact, a consequence that is reinforcing or punishing for a learner on one occasion may *not* be reinforcing or punishing on another. Learners' present circumstances and motivational states—whether they feel hungry or full, whether they crave attention or would rather be alone, and so on—are apt to affect their preferences for consequences at any particular time. For instance, a child is less likely to misbehave in order to gain an adult's attention if he is surrounded by enjoyable playthings than if he has little of interest to occupy his time (Ringdahl, Winborn, Andelman, & Kitsukawa, 2002). Attention-getting behavior is also less likely when a child is *already* receiving considerable adult attention regardless of what she does or doesn't do—that is, if attention isn't contingent on behaving in a particular way (Laraway, Snyckerski, Michael, & Poling, 2003).<sup>10</sup>

Motivation and cognition may both come into play in two phenomena collectively known as **contrast effects**. One contrast effect—an **elation effect**—occurs when the amount of reinforcement is increased: An organism's response rate becomes *faster* than it would be if the reinforcement had always been at that higher level. An opposite contrast effect—a **depression effect**—occurs when the amount of reinforcement is decreased: The result is that the response rate becomes *slower* than it would be if reinforcement had always been that low. For example, in a classic early study by Crespi (1942), rats ran a runway to reach a food reinforcer at the far end. When rats accustomed to a small quantity of food were suddenly reinforced with a greater amount, they ran faster than rats that had always received the larger amount. Meanwhile, rats accustomed to a large amount of reinforcement that then began receiving less food ran more slowly than rats that had always had the smaller amount.

Human beings show contrast effects as well. For instance, in one study (Mast, Fagen, Rovee-Collier, & Sullivan, 1984), 2- to 4-month-old infants were placed in cribs over which hung mobiles with 6 to 10 colorful objects. One end of a string was tied to each infant's ankle, and the other end was fastened to a mechanism that, when pulled, turned the infant's mobile. The infants quickly discovered that by kicking the appropriate leg, they could move the mobile and create a reinforcing visual display. Later on—for some babies as much as 24 hours later—the infants were placed in a similar arrangement, but this time with only a 2-object mobile to move. They showed obvious displeasure with the reduction in reinforcement, perhaps crying or perhaps looking elsewhere for other sources of amusement. Such findings suggest that the depression effect may be at least partly due to negative emotional reactions to the reduction in reinforcement (Flaherty, 1985). Memory for the higher-quality earlier reinforcement must also be involved here, leading learners to form expectations that they'll enjoy similar benefits on future occasions (Mast et al., 1984). It's almost as if learners are thinking, "Hey, what happened to the *good stuff*?!!"

As we turn our attention to other theoretical perspectives beginning in Chapter 6, we'll increasingly see the many ways in which cognition and motivation influence learning and performance. Yet even relatively "thoughtless" and "unmotivated" views of instrumental conditioning have many implications for classroom practices and therapeutic interventions, as we'll see in the next chapter.

---

<sup>10</sup>In recent years, behaviorists have used the terms *establishing operation* and *motivating operation* to refer to events that alter the reinforcing or punishing value of a particular stimulus.

---

## SUMMARY

While observing cats in a puzzle box, Edward Thorndike concluded that responses leading to satisfying consequences (rewards) are strengthened and responses leading to unpleasant consequences (punishment) are weakened. In later years, Thorndike revised this *law of effect*, suggesting that a reward strengthens a response but punishment doesn't necessarily weaken it. B. F. Skinner echoed Thorndike's view and in his studies of *operant conditioning* focused on the ways in which certain consequences increase the frequency of voluntary behaviors. Rather than use the term *reward*, however, Skinner introduced the term *reinforcement*—a term that avoids the implication that a behavior-increasing consequence necessarily involves a pleasant, desirable stimulus. For example, in the case of *negative reinforcement*, rather than gaining a pleasant stimulus, an organism *gets rid* of an unpleasant stimulus.

In the past few decades, many behaviorists have returned to Thorndike's original law of effect, acknowledging that both reinforcements and punishments can alter the frequency of the responses they follow. The term *instrumental conditioning* includes both the "encouraging" effects of reinforcement and the "discouraging" effects of punishment. Not all forms of reinforcement and punishment are equally effective, however. For example, some learners often work for the intrinsic satisfaction that their accomplishments bring, whereas others are primarily interested in more external consequences, such as concrete objects, special privileges, or attention from other people. And whereas some learners dislike

being placed in a quiet, boring context when they misbehave—that is, when they're given a *time-out*—others seem to appreciate the peace and quiet that a brief time-out provides.

Behaviorists have identified a variety of phenomena in which reinforcement plays a key role. For instance, a complex behavior can be taught by reinforcing successive approximations to the desired behavior (*shaping*) or by reinforcing an increasingly long sequence of responses (*chaining*). A response that has previously been reinforced but is no longer being reinforced at all decreases (*extinction*); however, reinforcing a response *intermittently* can maintain it indefinitely, with the particular pattern of responding depending on the *schedule of reinforcement* being used.

Antecedent stimuli and responses also affect the occurrence of a response. Certain kinds of antecedent events increase the frequency of particular behaviors; depending on the circumstances, these antecedents reflect phenomena known as *cueing*, *setting events*, and *behavioral momentum*. In general, learners tend to *generalize* newly acquired responses to similar situations, but they can also learn to *discriminate* between situations in which particular responses are and are not likely to be reinforced.

In recent decades, behaviorists have begun to incorporate elements of cognition and motivation into their views of human behavior. As a result, the distinction between behaviorism and cognitivism has become increasingly blurry.

## CHAPTER 5

---

# APPLICATIONS OF INSTRUMENTAL CONDITIONING

### *Applying Behaviorist Principles to Classroom Management*

*Concerns about Using Reinforcement and  
Punishment in the Classroom*

*Using Reinforcement to Increase Desirable  
Behaviors*

*Strategies for Decreasing Undesirable Behaviors*

### *Applied Behavior Analysis*

*Using Applied Behavior Analysis with Large  
Groups*

*Adding a Cognitive Component to ABA*

### *Instructional Objectives*

*Behavioral Objectives*

### *Current Perspectives on Instructional Objectives*

*Usefulness and Effectiveness of Objectives*

*Formulating Different Levels of Objectives*

*Programmed Instruction and Computer-Assisted  
Instruction*

*Effectiveness of PI and CAI*

*Mastery Learning*

*Keller's Personalized System of Instruction (PSI)*

*Effectiveness of Mastery Learning and PSI*

*When Behaviorist Techniques Are Most Appropriate*

*Summary*

In the past few decades, the psychological study of human learning has increasingly taken on a cognitivist bent. For example, if you were to browse through various psychology journals in the periodicals section of your university library, you would undoubtedly find mental terms (e.g., *cognitive process, memory*) far more common than behaviorist ones (e.g., *negative reinforcement, extinction*). Yet behaviorist ideas have stamped an indelible imprint on the nature of psychological inquiry and theory building. Even the most cognitivist theorists recognize that if they want to focus on the nature of human thinking, they must ultimately tie thought processes to behaviors they can objectively observe and measure. And they acknowledge that a learner's immediate context—the stimuli that precede behavior and the consequences that follow it—can have profound influences on what the learner does and doesn't learn and do. But perhaps most importantly, behaviorism remains with us today because, when properly applied, behaviorist principles *work* (Boyanton, 2010; Roediger, 2004).

In this chapter, we'll consider how both reinforcement and punishment can be effectively used in general classroom management and in a systematic approach to behavior change known as *applied behavior analysis*. We'll also look at the influence of behaviorist principles in several widely used instructional innovations: instructional goals and objectives, programmed instruction, computer-assisted instruction, and mastery learning.

## APPLYING BEHAVIORIST PRINCIPLES TO CLASSROOM MANAGEMENT \_\_\_\_\_

On average, beginning teachers mention classroom management as their Number One concern (Evertson & Weinstein, 2006; V. Jones, 1996; Veenman, 1984). Many students are easily distracted from academic tasks, and some consistently engage in disruptive behaviors that interfere with their own and others' learning.

B. F. Skinner wrote prolifically on why, from a behaviorist perspective, so many children and adolescents engage in nonproductive behaviors at school (e.g., B. F. Skinner, 1953, 1954, 1958, 1968, 1973). A problem inherent in traditional Western education, Skinner suggested, is that teachers must teach skills (e.g., persuasive writing, algebraic problem solving) that will be useful to students in the *future* rather than in the present; thus, these skills aren't likely to lead to the naturally positive consequences now that they might later on. To foster on-task behavior and academic achievement, then, teachers must resort to artificial reinforcers (e.g., praise, grades, stickers, free time)—reinforcers that aren't terribly effective because they're awarded inconsistently and long after desired behaviors have occurred. In such circumstances, Skinner said, teachers may also need to discourage *misbehaviors* with aversive consequences (e.g., criticism, ridicule, failing grades)—in other words, teachers must “induce students to learn by threatening them for not learning” (B. F. Skinner, 1968, p. 57). Frequent punishment for poor performance is apt to be distracting and unproductive; furthermore, it may encourage students to engage in behaviors that enable them to escape or avoid classroom tasks.

Behaviorists have offered a variety of recommendations for using both reinforcement and punishment effectively, and we'll look at their suggestions shortly. Before we do so, however, we need to be aware of and address potential drawbacks of reinforcement and punishment in classroom contexts.

## Concerns about Using Reinforcement and Punishment in the Classroom

Over the years people have voiced many criticisms about the use of reinforcement and punishment with school-age children. Some are ill founded, whereas others should be taken more seriously. We'll first examine common “bogus” complaints and then turn to more genuine concerns.

### ***Bogus Complaints***

Some criticisms directed toward the use of reinforcement and punishment in the classroom reflect either a misunderstanding of behaviorist principles or a lack of awareness of empirical findings:

- ◆ *Reinforcement is bribery.* The bribery argument is probably the most frequent complaint leveled against the use of reinforcement in the classroom. However, the word *bribery* implies that the behavior being reinforced is somehow illegal or unethical. On the contrary, the appropriate use of reinforcement in the classroom can facilitate the attainment of educational objectives, all of which involve academically and socially desirable behaviors.

- ◆ *Reinforcement leads to dependence on concrete, external rewards for appropriate behavior.* Some critics propose that students should engage in learning simply for learning's sake; by reinforcing learning, they argue, teachers foster the expectation that students will always receive rewards for their accomplishments. This argument can be countered in two ways. First, as you learned in Chapter 4, reinforcement doesn't necessarily involve material reinforcers. The sensible teacher will rely on social reinforcers, activities, feedback, and intrinsic reinforcers (e.g., feelings of success or accomplishment) instead of material reinforcers whenever possible.

Second, even when a teacher must use material reinforcers to change behavior, these reinforcers bring about desired changes that apparently *will not occur any other way*. Reinforcement is often

## Reinforcement as “bribery”



useful when more traditional methods of changing behavior have failed to increase important academic and social skills or to decrease counterproductive behaviors. If the choice comes down to teaching Johnny to read by reinforcing him for reading or else not teaching him to read at all, obviously Johnny should learn to read. We must remember, too, that whenever material reinforcers are used, pairing them with social events (e.g., praise) can create secondary (social) reinforcers that can then be used instead.

- ◆ *Reinforcing one student for being good teaches other students to be bad.* “Hmm,” Leslie thinks. “Linda has been such a loudmouth the past few weeks that the teacher is now giving her raisins so she’ll keep quiet. Maybe if I start shooting my mouth off, I’ll get raisins too.” If students are thinking along these lines, something is clearly wrong with how reinforcement is being administered. *All* students should be reinforced for appropriate behaviors—perhaps with praise, positive feedback, or the intrinsic reinforcers that success experiences often bring. If a material reinforcer such as raisins is the *only* reinforcer that will work with a particular student, it should be given discreetly and in private.

- ◆ *Punishment reduces self-esteem.* Certain forms of punishment, especially psychological punishment (e.g., public humiliation or ridicule), can indeed reduce self-esteem. But mild forms of punishment, such as brief time-outs or gentle reprimands, typically have little negative impact on students’ long-term emotional well-being. In fact, when punishment can help students gain more productive and socially productive behaviors, it can indirectly *enhance* their self-confidence over the long run.

- ◆ *Eliminating a problem behavior doesn’t eliminate the underlying cause of the behavior; thus, other behavioral manifestations of that underlying cause may appear.* This concern is sometimes a legitimate one, but on many occasions changing a person’s behavior indirectly addresses its underlying cause as well. For example, consider the girl who is inappropriately aggressive on the playground. This girl might truly want to interact effectively her peers, but aggression is the only way she knows of initiating social interaction. Teaching and reinforcing the girl for good social skills, combined with punishing aggressive behaviors, not only help her develop friendships but also address the underlying cause of her aggression: her desire for companionship.



### ***Genuine Concerns***

A few major criticisms of using reinforcement and punishment in instructional contexts should be taken more seriously:

◆ *Encouraging productive behaviors through reinforcement alone ignores cognitive factors that may be interfering with learning.* When students are capable of learning a new skill but aren't motivated to do so, consistent reinforcement may be all that's needed to bring about the desired behavior change. But when cognitive deficiencies interfere with the acquisition of a new skill (as insufficient background knowledge or undiagnosed learning disabilities might do), reinforcement alone may not be effective. In the latter situation, teachers may need to employ teaching techniques based more on cognitive learning theories—theories that we'll explore in later chapters.

◆ *Reinforcement of some behaviors may interfere with maximal learning and performance over the long run.* Reinforcement for accomplishing a certain task can focus students' attention and effort more on getting the task done quickly, perhaps at a minimally acceptable level or perhaps by cheating, rather than on *learning* from the task. Especially when teachers want their students to engage in complex thinking processes—for example, to think flexibly and creatively about academic subject matter—then extrinsic reinforcement simply for task accomplishment can be counterproductive (Brophy, 2004; McCaslin & Good, 1996; also see Chapter 16).

◆ *Extrinsic reinforcement of a personally enjoyable behavior can undermine the intrinsically reinforcing value of the behavior.* People often engage in activities because of the intrinsic rewards (e.g., feelings of pleasure or accomplishment) that the activities bring. A number of research studies have revealed that enjoyable behaviors can be increased with extrinsic reinforcers but will then *decrease* in frequency once the reinforcers are removed. For example, in one study, preschool children who were promised a fancy “Good Player Award” for drawing pictures were, later on, *less* likely to draw pictures in a free-play situation than either (1) children who were given a similar award but not told about it in advance or (2) children who weren't reinforced for drawing pictures (Lepper, Greene, & Nisbett, 1973). And in a study in which college students were asked to solve a series of puzzles, students who were given money for correct solutions—but *not* students who were given only positive feedback—were less likely to continue working on puzzles once reinforcement stopped (Deci, 1971).

Extrinsic reinforcers are most likely to undermine intrinsic motivation when (1) initial interest in an activity is high; (2) newly offered reinforcers are tangible (e.g., toys or money); (3) people know in advance that such reinforcers will be coming; and (4) simply doing the activity—rather than doing it *well*—is reinforced (Cameron, 2001; Deci, Koestner, & Ryan, 2001). Possibly the *depression effect* is at work to some extent: As you discovered in Chapter 4, human beings and nonhumans alike don't like having the quality or quantity of reinforcement reduced unexpectedly. We'll consider a second possible explanation of this extrinsic-undermining-intrinsic effect in our discussion of self-determination in Chapter 16.

◆ *Students ultimately need to learn not only how to succeed but also how to fail.* Even when reinforcement is intrinsic, it's possible to have too much of a good thing. If students rarely experience anything but success in their academic endeavors, they won't know how to handle the inevitable failures and frustrations that will eventually come their way in school and in the workplace. Furthermore, students often learn as much from their mistakes as from their successes (Bandura, 2008; Minsky, 2006).

♦ *A punished behavior isn't forgotten and may return.* Punishment suppresses a response: It makes the response less likely to occur. However, this suppression effect is often only temporary: The punished behavior may eventually reappear, perhaps when the punishment stops or when the punisher is absent (Appel & Peterson, 1965; Lerman & Vorndran, 2002; Pfiffner & O'Leary, 1987; B. F. Skinner, 1938).

♦ *Punishment can have negative side effects.* Obviously, severe physical punishment can lead to bodily injury, and harsh psychological punishment is apt to have a long-term negative impact on emotional well-being. Even less severe punishments involving aversive stimuli (those that constitute Punishment I rather than Punishment II) can lead to a variety of counterproductive emotional responses—anger, fear, anxiety, and so on. Anger may, in turn, lead to aggression, especially in people already predisposed to making aggressive responses (Berkowitz & LePage, 1967; Landrum & Kauffman, 2006; G. C. Walters & Grusec, 1977). Furthermore, the fear and anxiety that punishment elicits can, through classical conditioning, become associated with the context in which it occurs (Lerman & Vorndran, 2002; B. F. Skinner, 1938). For example, when a teacher punishes a student, that punishment (the UCS) may be associated with the teacher, the task, or the classroom, any of which can then become conditioned stimuli (CSs) that elicit fear and anxiety (CRs). In a similar manner, when an athletic coach continually yells at children for their poor performance during a game, negative attitudes toward the sport may result (Feltz, Chaase, Moritz, & Sullivan, 1999; R. E. Smith & Smoll, 1997).

We must remember, too, that any stimulus that has become fear- and anxiety-inducing because of its association with punishment may lead to escape or avoidance behaviors (see Chapter 4). For instance, escape and avoidance responses at school take many forms, including inattention, cheating, lying, refusal to participate in classroom activities, and truancy (e.g., Gardner, Wacker, & Boelter, 2009; B. F. Skinner, 1938; Taylor & Romanczyk, 1994).

♦ *Improving behavior in one context may lead to more frequent behavior problems in another.* When reinforcement or punishment is consistently used in one situation, overall behavior may improve in that situation but decline in others—a phenomenon known as **behavioral contrast** (e.g., S. J. Simon, Ayllon, & Milan, 1982; Wahler, Vigilante, & Strand, 2004). For example, some children who behave badly at school may be described by parents as being “little angels” at home. Such children are possibly being held to strict behavioral rules on the home front, with severe punishment following any infractions. If so, they may engage in the forbidden behaviors at school, where they can do so with milder consequences.

Despite such concerns, reinforcement and punishment can be highly effective means of bringing about desired behavior changes, as we'll see in the next two sections.

## Using Reinforcement to Increase Desirable Behaviors

Behaviorists have offered a number of suggestions for using reinforcement effectively in classrooms and therapeutic contexts:

♦ *Specify desired behavior(s) up front.* Behaviorists recommend that the desired end result, or **terminal behavior**, be described at the very beginning in concrete, observable terms—ideally, with specification of both the form and the frequency of the behavior. For example, rather than talk about the need for students to “learn responsibility,” teachers might instead talk about the

importance of always following instructions, bringing needed books and supplies to class every day, and turning in all assignments by their due dates. By specifying terminal behaviors up front, teachers give both themselves and their students targets to shoot for, and they can better determine whether they're making progress toward those targets.

It's often important to specify quality as well as quantity. For instance, rather than reinforcing students simply for sitting quietly at their desks, teachers should also reinforce them for working productively during that time. And rather than reinforcing students simply for the number of books they read (which may encourage students to read many short, simple books), teachers should reinforce them for completing challenging reading material appropriate for their ability level (McCaslin & Good, 1996).

♦ *Use extrinsic reinforcers only when desired behaviors aren't already occurring on their own.* It's neither possible nor necessary to reinforce every good deed. Learners of all ages often engage in appropriate, productive behaviors of their own volition. Furthermore, many extrinsic reinforcers lose their effectiveness when used repeatedly (Michael, 2000; E. S. Murphy, McSweeney, Smith, & McComas, 2003).

♦ *Identify consequences that are truly reinforcing for each learner.* In school settings, social reinforcers (e.g., praise) or activity reinforcers (e.g., special privileges) are often quite effective. In some cases, immediate feedback that a student has done something correctly is all the reinforcement a student needs, especially when the quality of the performance isn't otherwise clear (Hattie & Timperley, 2007; J. A. Kulik & Kulik, 1988; Shute, 2008).

One of the most common mistakes that teachers make in applying behaviorist principles is to assume that certain consequences will be reinforcing for *all* students. For example, a first-grade teacher once consulted me about one of her students, a boy so disruptive that he was able to spend only a half day in the classroom. In an effort to modify the disruptive behavior, the teacher had attached to the boy's desk a large sheet of heavy cardboard that was cut and painted to look like a clown, with a small red light bulb for a nose. When the boy exhibited appropriate classroom behaviors (e.g., sitting quietly or staying on task), the teacher would push a remote button that lit up the red nose. "I don't understand why his behavior isn't improving," she told me. I suggested that perhaps the clown wasn't reinforcing for him. "Nonsense!" the teacher replied. "The clown has always worked with *other* children!"

Not everyone will work for the same reinforcers. For example, although most students find their teacher's praise reinforcing, some may feel uncomfortable when their individual efforts are publicly singled out as noteworthy; for such students, praise given in private or praise for the achievements of their *group* can be more powerful (Fuller, 2001; Jiang, 2010). And for some students, only material reinforcers will do. In such a situation, having parents provide the reinforcers at home for behaviors exhibited at school often works quite well (Kelley & Carper, 1988; D. L. Miller & Kelley, 1994).

How can teachers determine what events will be reinforcing for different students? One way is to ask the students' parents, or even the students themselves. Yet children don't always have a good sense of which consequences they will actually work for (Atance & Meltzoff, 2006; Northup, 2000), so in some instances a better approach is to observe students over a period of time to see which consequences really have an impact.

Teachers should keep in mind, too, that any single reinforcer won't necessarily maintain its reinforcing value indefinitely, especially if used frequently (Bowman, Piazza, Fisher, Hagopian, & Kogan, 1997; Viken & McFall, 1994). For example, as much as you enjoy the praise of people

The “reinforcer” must be reinforcing for the learner.



you respect, constant praise becomes tiresome after a while. It's certainly possible to get too much of a good thing.

- ◆ *Make sure that learners will gain more than they lose by changing their behavior.* Consciously or otherwise, children and adults alike sometimes engage in a cost–benefit analysis when considering the consequences of different behaviors (Eccles & Wigfield, 1985; Feather, 1982; Friman & Poling, 1995; A. C. Perry & Fisher, 2001). Although they may have learned that a certain response will be reinforced, they're unlikely to make that response if they have too much to lose or too little to gain by doing so. For example, people are more likely to recycle paper and aluminum cans if recycling containers are close at hand rather than located down the hall (Brothers, Krantz, & McClannahan, 1994; Ludwig, Gray, & Rowell, 1998). And consider the college student who estimates that she'll have to study at least 20 hours a week to get an A in a history class. Even if the A is an effective reinforcer, it may not be worth the amount of time she'll have to spend to earn it.

- ◆ *Explicitly describe response–consequence contingencies.* Reinforcement is typically more effective when learners know exactly what consequences will follow various behaviors. For example, kindergartners are more likely to behave appropriately when they're told, “The quietest group will be first in line for recess.” High school students are more likely to complete their Spanish assignments if they know that doing so will earn them a field trip to a local Cinco de Mayo festival.

One explicit way of communicating contingencies is through a **contingency contract**, an agreement that specifies certain expectations for the student (the terminal behavior) and the consequences of meeting those expectations (the reinforcer). To develop such a contract, the teacher meets with a student to discuss a problem behavior (e.g., talking to friends during independent seatwork or making rude comments to classmates). The teacher and the student then identify and agree on specific behaviors that the student will demonstrate (e.g., completing seatwork assignments within a certain time frame or speaking with classmates in a friendly, respectful manner). The two also agree on one or more reinforcers for those behaviors (e.g., a certain amount of free time or a particular number of points earned toward a desired privilege or prize).

Together the teacher and the student write and sign a contract that describes the behaviors the student will perform and the reinforcers that will result. Contingency contracts have been shown to be effective for addressing a wide variety of academic and social behaviors (Brooke & Ruthren, 1984; D. L. Miller & Kelley, 1994; Rueger & Liberman, 1984; Welch, 1985).

- ◆ *Administer reinforcement consistently.* In group situations (e.g., in classrooms), it's sometimes inconvenient to reinforce a behavior every time it occurs. But as you learned in Chapter 4, continuous reinforcement brings about more rapid behavior change than intermittent reinforcement. If a student's behavior has been particularly disruptive and time consuming, a little extra time devoted *now* to the continuous reinforcement of appropriate behaviors (inconvenient as it may occasionally be) will probably save time over the long run.

- ◆ *Gradually shape complex behaviors.* In many situations, encouraging a desirable behavior requires a process of gradually shaping the behavior. Each response should be well learned before reinforcement proceeds to a closer approximation. If an attempt at shaping moves too quickly, such that each response isn't well established before a more sophisticated one is expected, reinforcement may not bring about any lasting behavior change.

To illustrate, let's say that Ms. Garcia, a third-grade teacher, wants to reinforce an especially hyperactive boy for sitting quietly in his seat; her goal (the terminal behavior) is for him to sit quietly for 20-minute periods. On the first morning of the intervention program, the boy sits quietly for 1 minute, and so Ms. Garcia reinforces him. She probably *doesn't* want to move on to a 2-minute criterion after he has met the 1-minute criterion only once. Instead, she should continue reinforcing him for 1-minute sits until the frequency of his sitting behavior makes it clear that she can begin to expect that behavior for a longer time.

- ◆ *When giving reinforcement publicly, make sure all students have an opportunity to earn it.* In their attempts to improve the behavior of some students, teachers may unintentionally slight other, equally deserving students. Furthermore, some students may be unable to perform particular behaviors through no fault of their own. As an example, consider the case of a young immigrant girl who had to adjust very quickly from a 10:00–5:00 school day in Vietnam to a 7:45–3:45 school day in the United States:

Every week on Friday after school, the teacher would give little presents to kids that were good during the week. And if you were tardy, you wouldn't get a present. . . . I would never get one because I would always come to school late, and that hurt at first. I had a terrible time. I didn't look forward to going to school. (Igoa, 1995, p. 95)

Ultimately, school should be a place where *all* students can, in one way or another, earn reinforcement and in other ways be successful. Classrooms are busy places, however, and it may be all too easy to overlook a few students who desperately want and need a teacher's attention. In such cases the teacher can explicitly *teach* children appropriate ways of seeking out and getting reinforcement—for instance, by raising their hands or quietly approaching the teacher at an appropriate time, asking questions (e.g., “How am I doing?” “What do I do next?”), and keeping the teacher informed of their progress (“Look, I'm all finished!”) (Craft, Alberg, & Heward, 1998, p. 402; K. A. Meyer, 1999).

- ◆ *Use objective criteria to monitor progress.* Regardless of whether we define learning as a mental change or a behavioral one, we know that learning has occurred only when we can see an actual change in behavior. Behaviorists urge us to assess that change in concrete, objective terms—in particular, by assessing the frequency of a desired behavior both before and during

any systematic use of reinforcement. The frequency of a behavior before reinforcement begins is its **baseline** level. Some behaviors occur frequently even when they aren't explicitly being reinforced, whereas other behaviors occur rarely or not at all. Only by comparing the baseline frequency of a response with its frequency after reinforcement begins can teachers and other practitioners determine whether their use of reinforcement is actually yielding results.

♦ *Foster the ability to delay gratification.* In the preceding chapter, I stressed the importance of *immediate* reinforcement in operant conditioning, especially for young children and animals. Ultimately, however, success both in school and in the outside world requires people to **delay gratification**—that is, to forgo immediate pleasures in order to earn more satisfying consequences over the long run. In general, the ability to delay gratification improves with age, in part as a result of maturational changes in the brain (Green, Fry, & Myerson, 1994; M. I. Posner & Rothbart, 2007; Steinberg et al., 2009).

When immediate reinforcement isn't possible, it's often helpful to tell children that reinforcement will come later (S. A. Fowler & Baer, 1981). For example, a teacher who wants to reinforce students' persistence through a difficult lesson might say, "Because we're working so hard this morning, after lunch we'll rehearse the class skit you've all been enjoying so much." Also, children can more successfully delay gratification when the waiting period is increased gradually and when they learn strategies for coping with the wait—for instance, by engaging in an activity in the interim or by telling themselves "If I wait a little longer, I'll get a bigger reward" (Binder, Dixon, & Ghezzi, 2000; M. R. Dixon & Cummings, 2001; M. R. Dixon, Rehfeldt, & Randich, 2003).

♦ *Once the terminal behavior is occurring regularly, gradually wean learners off extrinsic reinforcers.* When a previously learned response is no longer reinforced *at all*, it may quickly disappear. From a behaviorist perspective, either of two conditions can prevent such extinction. In some cases, improvements in behavior begin to lead to intrinsic reinforcement—to internal feelings of accomplishment, pride, and so on—and so continue of their own accord. But not all important behaviors are, in and of themselves, intrinsically satisfying. When a desired behavior involves a tedious but necessary activity—for instance, practicing basic math facts or cleaning up after messy art projects—an intermittent reinforcement schedule can help to maintain it indefinitely.

## Strategies for Decreasing Undesirable Behaviors

In this and the preceding chapter, we've talked at length about how new responses can be learned, modified, and maintained through the use of reinforcement. But sometimes the goal may be to *decrease*—and ideally eliminate—a behavior. Four possible methods of reducing and eliminating misbehavior are extinction, noncontingent reinforcement, reinforcement of other behaviors, and punishment.

### *Extinguishing Responses*

During a lengthy hospitalization, a child named Jimmy acquired an alarming habit of banging his head on the side of his crib. Whenever nurses heard him doing so, they rushed to his room and restrained him, inadvertently reinforcing and maintaining his head-banging behavior with their attention. A consulting psychologist successfully eliminated the head banging through a process of extinction: A protective helmet was strapped on Jimmy's head to prevent injury, and the nurses were instructed to ignore Jimmy during head-banging episodes. At the same time, because Jimmy clearly craved attention, the nurses *did* spend time with him on other occasions.

Extinction—making sure that a particular response no longer leads to reinforcement—is sometimes an effective means of eliminating inappropriate behavior in the classroom. For instance, students who engage in disruptive classroom behavior may stop if such behavior no longer yields the attention they seek. And cheating on classroom assignments may soon disappear if students never receive credit for the scores they obtain on those assignments. We don't necessarily want to eliminate the particular reinforcers that have been operating in such circumstances (e.g., attention, class credit); we simply need to make sure that those reinforcers *aren't* contingent on inappropriate responses.

Unfortunately, extinction isn't a completely dependable method of eliminating unwanted behavior, for several reasons. First, it isn't always possible to identify the specific consequence actually reinforcing a response; for example, although some children engage in head-banging behavior to gain attention (as Jimmy did), others do so to escape from unpleasant tasks (a form of negative reinforcement) or provide self-stimulation (Iwata, Pace, Cowdery, & Miltenberger, 1994). Second, several reinforcers may be maintaining a response, including some that are hard to remove; for example, although a teacher may be able to ignore the jokes of a disruptive class clown, classmates may continue to laugh at the jokes (Landrum & Kauffman, 2006). Third, even if all sources of reinforcement can be removed, the behavior may show an extinction burst, increasing in frequency before it begins to decline (see Chapter 4). Fourth, extinguished behaviors sometimes show spontaneous recovery, popping up again at a later date, perhaps in a different context (Alberto & Troutman, 2009; B. F. Skinner, 1953). Finally, some responses may be particularly resistant to extinction because they've previously been reinforced on an intermittent schedule (Pipkin & Vollmer, 2009). When responses can't be extinguished for any of these reasons, other approaches are usually necessary.

### ***Presenting Noncontingent Reinforcement***

In recent years, some researchers have found that presenting desired consequences noncontingently—for instance, giving attention at unpredictable times or providing regular breaks from difficult tasks—can lead to a decrease in inappropriate behavior (J. L. Austin & Soeda, 2008; Ecott & Critchfield, 2004; Waller & Higbee, 2010). In this way, children gain the consequences they seek without having to act out. The primary disadvantage of this approach, of course, is that children don't necessarily learn more appropriate behaviors to replace the counterproductive ones. Occasionally, too, it might lead to superstitious behavior (see Chapter 4).

### ***Reinforcing Other Behaviors***

Rather than using noncontingent reinforcement, a teacher or therapist might identify specific behaviors that will be reinforced while also making sure that the behavior to be eliminated *isn't* reinforced. Sometimes a learner is reinforced for making *any* response other than a particular (presumably undesirable) response during a certain time period; in this situation, the learner must never make that particular response at all.<sup>1</sup> As an example, consider the teacher who says, "I'm going to write down the name of every student who speaks out of turn today. If your name isn't on the board by 3 o'clock, you can have a half hour of free time." A drawback with this approach is that students can potentially earn the reinforcer if they exhibit other inappropriate behaviors during that time period.

---

<sup>1</sup>This approach is known as *differential reinforcement of other behaviors* (a DRO schedule).

A better strategy is to reinforce only desirable alternatives to an undesirable behavior (e.g., Lerman, Kelley, Vorndran, Kuhn, & LaRue, 2002; Vladescu & Kodak, 2010; Vollmer, Roane, Ringdahl, & Marcus, 1999).<sup>2</sup> Ideally the other behaviors are *incompatible* with the behavior to be eliminated. (Recall our use of incompatible behaviors in counterconditioning and breaking habits in Chapter 3.) The first step is to identify a response that's incompatible with the response to be eliminated—a response that can't be performed at the same time as the undesirable response. That incompatible behavior is then reinforced whenever it occurs. For example, a child's inappropriate out-of-seat behavior might be reduced by reinforcing the child whenever she is sitting down. A tennis player who displays inappropriate emotional outbursts every time he misses a shot can be reinforced for keeping his frustration under control by standing still, taking several deep breaths, and then continuing to play (Allen, 1998). A chronic litterbug might be put in charge of his school's antilitter campaign and given considerable recognition and praise for his efforts (Krumboltz & Krumboltz, 1972). Reinforcing other (possibly incompatible) behaviors is often more effective than extinction, provided that teachers or therapists are consistent in their reinforcement of desired behaviors and *non*reinforcement of inappropriate ones (Pipkin, Vollmer, & Sloman, 2010; Woods & Miltenberger, 1995; Zirpoli & Melloy, 2001).

### ***Using Punishment***

The use of punishment as a means of behavior control is widespread in both child-rearing and educational practice (Landrum & Kauffman, 2006; Straus, 2000a, 2000b). One likely reason for the prevalence of punishment as a disciplinary measure is that, because it tends to decrease or eliminate an undesirable behavior fairly quickly, the punisher is *negatively reinforced*: By using punishment, he or she gets rid of an unwanted state of affairs, at least temporarily.

Punishment is often used when methods such as extinction or reinforcement of incompatible behaviors are unproductive or impractical; furthermore, punishment is sometimes more effective than other behaviorist techniques (Conyers et al., 2004; Frankel & Simmons, 1985; Lerman & Vorndran, 2002; Pliffner & O'Leary, 1987). Punishment is especially advised when a behavior might harm either oneself or others; in such cases, using punishment to eliminate this behavior rapidly may actually be the most humane course of action.

Psychologists and educators have offered numerous suggestions for using punishment effectively, many of which decrease the chances of negative side effects. The guidelines that follow are among those most commonly cited:

- ◆ *Choose a "punishment" that is truly punishing without being overly severe.* Punishment, like reinforcement, is defined by its effect on behavior: True punishment decreases the response it follows, and typically it does so quite rapidly. (For example, return to Figure 4.5 in Chapter 4 and notice how quickly Andrea's biting and pinching decreased.) If a given consequence doesn't decrease the response it's intended to punish, the consequence may not be aversive to the person being "punished"; in fact, it may be reinforcing. For example, when my children were growing up, a common "punishment" in our house was to be sent to one's room. For my two sons, this consequence was truly aversive because they would much rather socialize with other family members than be isolated in their rooms for any length of time. But when my daughter Tina was banished to her bedroom, she was probably being reinforced: She rearranged her furniture,

---

<sup>2</sup>This approach is known as either *differential reinforcement of alternative behavior* (a DRA schedule) or *differential reinforcement of incompatible behavior* (a DRI schedule).



Tina is “punished.”



listened to her radio, or settled under the covers with a good book. And the behaviors for which she was most often punished in this way—behaviors related in one way or another to annoying and teasing her brothers—seemed to increase rather than decrease.

As noted in Chapter 4, certain forms of punishment (e.g., physical punishment, public humiliation) tend not to be effective and should be avoided. Whatever consequence is used should be strong enough to discourage inappropriate behavior without being overly severe (Landrum & Kauffman, 2006; Lerman & Vorndran, 2002). Harsh punishments—those that far surpass the severity of the crime—are the ones most apt to lead to such undesirable side effects as resentment, hostility, aggression, and escape behavior. Furthermore, although severe punishment can quickly suppress a response, the response may reappear at its original level once the punisher has left the scene (Appel & Peterson, 1965; Azrin, 1960; Landrum & Kauffman, 2006). The ultimate purpose of administering punishment is to communicate that the limits of acceptable behavior have been exceeded; it shouldn't be so excessive that it undermines the personal relationship between the punisher and the person being punished (Spaulding, 1992).

- ◆ *Inform learners ahead of time about what behaviors will be punished.* Punishment is most likely to deter behavior when an individual *knows* that the behavior will lead to punishment and what the punishment will be (Aronfreed, 1968; Landrum & Kauffman, 2006; also see Chapter 6). I recall an incident when, as a 4-year-old, I was punished without warning. Sitting at lunch one day, apparently considering the adage “Waste not, want not,” I licked a large quantity of peanut butter off my butter knife. An adult scolded me sternly for my behavior, and I was devastated. Being the Miss Goody-Two-Shoes I was at the time, I would never have engaged in knife-licking behavior if I had known it was unacceptable.

Often the knowledge that certain responses will be punished is, in and of itself, sufficient for improving behavior. For example, in a study by R. V. Hall and his colleagues (1971, Experiment 4), three high school students enrolled in a French class earned higher grades when after-school tutoring was the “punishment” for low grades. These students—Dave, Roy, and Debbie—had been consistently earning Ds and Fs on daily quizzes. Their teacher informed them that because they were obviously having difficulty with their French, they would have to come in for a half hour of tutoring after school whenever they received a grade lower than C. Quiz grades during baseline periods and during times when poor quiz performance would be punished are shown in Figure 5.1. Notice the *multiple baseline* approach here: The intervention was intentionally started at different times for different students in order to demonstrate that the imposed consequence

**Figure 5.1**

Quiz grades for three high school French class students

Reprinted with permission from "The Effective Use of Punishment to Modify Behavior in the Classroom" by R. V. Hall, S. Axelrod, M. Foundopoulos, J. Shellman, R. A. Campbell, & S. S. Cranston, 1972, in K. D. O'Leary & S. O'Leary (Eds.), *Classroom Management: The Successful Use of Behavior Modification*, p. 180. Copyright © 1972 by Pergamon Press, Ltd.

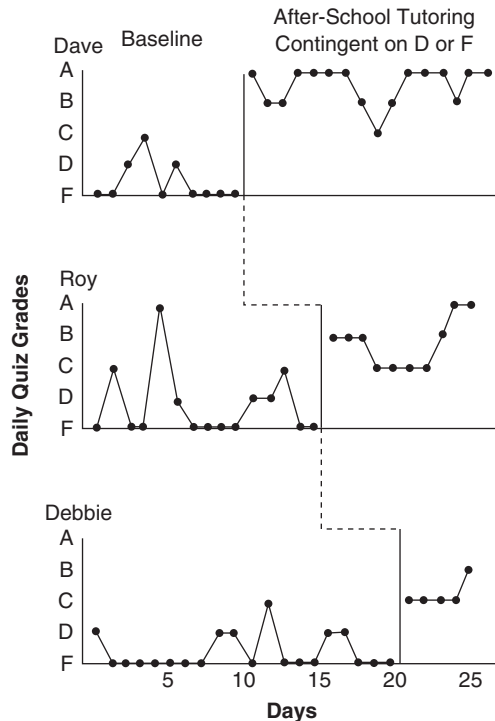

(rather than some other factor occurring at school or elsewhere) was probably the reason for the behavior changes. As you can see from Figure 5.1, none of the students ever needed to report for after-school tutoring. Apparently, the threat of punishment alone was sufficient to bring about desired study behaviors. Perhaps temporary removal of the threat—made possible by studying for each quiz—was sufficient negative reinforcement to increase regular study habits.

One common mistake many teachers and parents make, however, is to continue to threaten punishment without ever following through. One warning is advisable, but repeated threats are not. For instance, when a mother continually says "If you hit your sister again, Tommy, I'll send you to your room for the rest of the week!" but never actually sends Tommy to his room, she's communicating the message that no response–punishment contingency really exists.

One reason that teachers and parents fail to follow through with threatened punishments is that they often bluff, proposing punishment that's impractical or unrealistically extreme. Tommy's mother doesn't punish her son because forcing Tommy to spend "the rest of the week" in his room would be a major inconvenience for both of them. A teacher who threatens that certain behaviors will result in students not going on a promised field trip should do so only if he or she knows that leaving some students behind at school is logistically possible.

- ◆ *Describe unacceptable behaviors in clear, concrete terms.* Learners should understand exactly which responses will result in punishment. A student who is told, "If you disrupt the class again this morning, you'll lose your free time," may not understand exactly what the teacher means by "disrupt" and so may continue to engage in inappropriate behavior. The teacher should instead take the student aside and say something such as, "Sharon, there are two behaviors that are unacceptable in

this classroom. When you talk without permission and when you get out of your seat during quiet reading time, you keep other children from getting their work done. This morning I expect you to talk and get out of your seat only when I give you permission to do so. Otherwise, you'll have to sit quietly at your desk this afternoon when the other children have their free time."

◆ *Whenever possible, administer punishment immediately after the inappropriate behavior.* As is true for reinforcement, the effectiveness of punishment decreases dramatically when it's delayed. The more closely punishment follows a misbehavior, the more effective it will be. When, for whatever reason, punishment can't be administered immediately, the contingency between the behavior and the consequence must be made crystal clear (Aronfreed & Reber, 1965; Landrum & Kauffman, 2006; Lerman & Vorndran, 2002; Trenholme & Baron, 1975).

◆ *Administer punishment within the context of a generally warm, supportive environment.* Punishment is more effective when the person administering it has previously established a good working relationship with the learner (J. Ellis, Fitzsimmons, & Small-McGinley, 2010; Landrum & Kauffman, 2006; Nucci, 2001). The message should ultimately be: "I care for you and want you to succeed, and your current behavior is interfering with your success."

◆ *Explain why the behavior is unacceptable.* Although behaviorists tend to focus attention on responses and their consequences, a significant body of research indicates that punishment is more effective when *reasons* are given for why certain behaviors cannot be tolerated (M. L. Hoffman, 1975, 2000; Parke, 1977; D. G. Perry & Perry, 1983). For example, in an example presented earlier, Sharon's teacher incorporated reasoning into her description of Sharon's inappropriate behaviors: "When you talk without permission and when you get out of your seat during quiet reading time, *you keep other children from getting their work done.*"

Providing reasons as to why behaviors are unacceptable has at least four advantages (Cheyne & Walters, 1970; G. C. Walters & Grusec, 1977):

- When punishment is accompanied by reasoning, the immediacy of punishment is a less critical factor in its effectiveness.
- Reasoning increases the likelihood that other, similar misbehaviors are also suppressed; that is, the effect of the punishment generalizes to other misbehaviors.
- If reasons are given, misbehaviors are likely to be suppressed even when the punisher is absent.
- Older children apparently *expect* to be told why certain behaviors are prohibited and are apt to be defiant when reasons aren't given.

◆ *Be consistent in imposing punishment for inappropriate behavior.* Just as is true for reinforcement, punishment is far more effective when it *always* follows a particular response (Leff, 1969; Lerman & Vorndran, 2002; Parke & Deur, 1972). When a response is punished only occasionally, with other occurrences of the response being either ignored or reinforced, the response disappears slowly, if at all.

Consistency is important not only across time but also across contexts (Boyanton, 2010). When a student with chronic behavior problems has two or more teachers, all teachers should coordinate their efforts. And ideally, teachers and parents should agree on the behaviors they will reinforce and punish. In this way, they minimize the likelihood of behavioral contrast between school and home.

Unfortunately, people can be punished only when they're caught in the act. Thieves are rarely apprehended, and speeders are ticketed only when they drive on roadways that are

patrolled. Many undesirable classroom behaviors, such as talking out, acting aggressively, and cheating, may be reinforced as often as they're punished. To deal with the difficulty of detecting some undesirable student behaviors, the next two guidelines are especially critical.

- ◆ *Modify the environment so that misbehavior is less likely to occur.* The temptation to engage in a misbehavior should be reduced or, if possible, eliminated. For instance, troublemaking friends might be placed on opposite sides of the classroom or in different classes. Cheating on an exam can be reduced by having students sit apart from one another or administering two different forms of the exam to different students (Cizek, 2003).

- ◆ *Teach and reinforce more appropriate behaviors.* In and of itself, punishment tells an individual what *not* to do but not what should be done instead (B. F. Skinner, 1938). Punishment of misbehavior is typically more effective over the long run when it's combined with support for—as well as reinforcement of—more productive behaviors (R. G. Carey & Bucher, 1986; Landrum & Kauffman, 2006; Lerman & Vorndran, 2002; Ruef, Higgins, Glaeser, & Patnode, 1998). For example, when punishing aggression on the playground, teachers should remember also to teach and reinforce effective social skills. Teachers can punish a student for cheating, but they should also teach the student good study habits and reinforce the student for working well independently.

## APPLIED BEHAVIOR ANALYSIS

---

Sometimes problem behaviors are so entrenched and counterproductive that they require intensive, systematic intervention. One effective approach in dealing with such behaviors is **applied behavior analysis (ABA)**. (You may also see such terms as *behavior modification*, *behavior therapy*, and *contingency management*). Applied behavior analysis is based on the assumption that serious problem behaviors are, like most human behaviors, the result of past and present response–consequence contingencies. It involves the application of a variety of behaviorist concepts—reinforcement, shaping, cueing, extinction, punishment, and so on—to create an environment more conducive to productive behaviors. It is especially beneficial for learners who must continually be encouraged to engage in appropriate academic and social behaviors. Thus, it is frequently used in education and therapy for students with special needs, including those with significant learning difficulties and those with serious mental illnesses.

Typically, ABA interventions are tailored to individual circumstances, but several strategies are common to many of them:

- ◆ *Behaviors that are the focus of an intervention are identified in observable, measurable terms.* Consistent with behaviorist tradition, teachers and therapists who use ABA focus on specific, concrete responses, which they call **target behaviors**. Sometimes interventions are aimed at increasing certain (presumably desirable) target behaviors. At other times they're designed to decrease certain (presumably undesirable) target behaviors.

- ◆ *Target behaviors are measured both before and during the intervention.* Only by objectively measuring target behaviors both before and during an intervention can we determine whether the intervention is effectively bringing about a behavior change. For example, we might divide a class period into 5-minute intervals or divide an entire school day into 1-hour intervals and then determine whether—or perhaps how often—a certain target behavior occurs during each interval.

In applied behavior analysis, target behaviors are observed and recorded as objectively as possible. Ideally, one or more people (e.g., teachers, therapists) administer the ABA intervention and at least two other individuals trained in observation techniques observe and record occurrences of the target behavior. If the method of behavior measurement is such that the behavior is being objectively and accurately recorded, the agreement between the recordings of the two observers (the **interrater reliability**) should be very high.

◆ *Environmental conditions that may be encouraging problem behaviors are identified.* It's often helpful to collect information not only about target behaviors but also about events that immediately precede and follow those behaviors. A teacher or therapist typically takes an ABC approach, observing the individual in his or her daily environment and collecting ongoing information about the following:

- **Antecedents:** stimuli and events that the individual encounters
- **Behaviors:** responses that the individual subsequently makes
- **Consequences:** stimuli and events that immediately follow the behaviors

For example, imagine a hypothetical student (we'll call him Johnny) who frequently hits his classmates. Part of baseline data collection might include recording any observed antecedents and consequences of each hitting response. Figure 5.2 illustrates this process using 5-minute time intervals.

Once such information is collected, the teacher or therapist looks for patterns in the data and identifies specific events that may be triggering or reinforcing a target behavior—an approach known as **functional analysis** or *functional behavioral assessment*.<sup>3</sup> As an example, consider Jeb, a 5-year-old boy with autism. Jeb's teachers reported that he spent a great deal of each school day covering his ears. Researchers Tang, Kennedy, Koppekin, and Caruso (2002) set out to determine

Antecedent		Peer teased him			None observed	Peer hit him	
Target behavior (hitting)	no	yes	no	no	yes	yes	no
Consequence		scolded			scolded	none	
	9:00	9:05	9:10	9:15	9:20	9:25	9:30

(Times indicate start of each 5-minute interval)

**Figure 5.2**

A record of Johnny's target behaviors in conjunction with antecedent and consequent events

<sup>3</sup>In some functional analyses, the teacher or therapist systematically *manipulates* the environment as a way of testing various hypotheses about influential antecedent stimuli and consequences (e.g., K. M. Jones, Drew, & Weber, 2000; K. A. Meyer, 1999; M. M. Mueller, Sterling-Turner, & Scattone, 2001; Piazza et al., 1999).

**Figure 5.3**

Frequency of Jeb's ear-covering responses under various antecedent and consequent conditions

Reprinted with permission from "Functional Analysis of Stereotypical Ear Covering in a Child with Autism" by J.-C. Tang, C. H. Kennedy, A. Koppekin, & Mary Caruso, 2002, *Journal of Applied Behavior Analysis*, 35, p. 96. Copyright 2002 by the Society for the Experimental Analysis of Behavior, Inc.

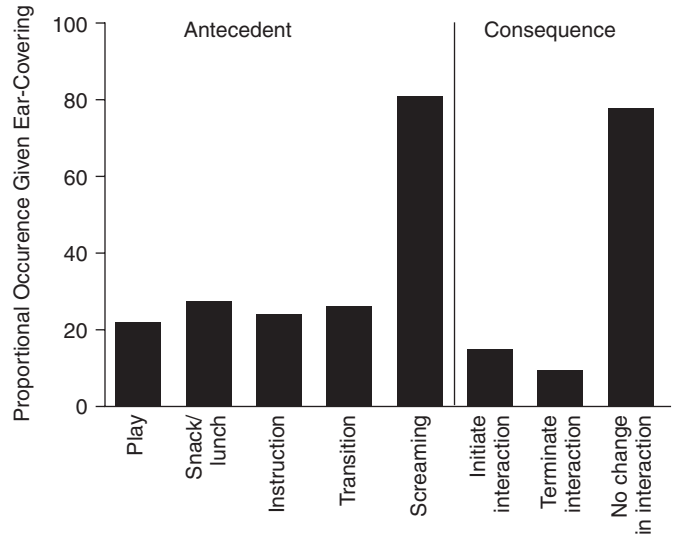

why ear-covering behavior was so frequent. At 30-second intervals, they recorded (1) each occurrence of ear covering; (2) specific events occurring at the time (i.e., whether the response occurred during playtime, snack or lunch, instruction, and transition between activities, and whether another child was screaming); and (3) teacher behavior following each response (i.e., whether a teacher began, stopped, or continued interacting with Jeb). Figure 5.3 shows the frequency with which the ear-covering behavior occurred under various antecedent and consequent conditions. As you can see, the teachers typically didn't change their behavior toward Jeb when he covered his ears; thus they apparently weren't reinforcing the target behavior. A look at the antecedent stimuli is more enlightening: 80% of the ear-covering incidents occurred immediately after a classmate screamed. Quite possibly, Jeb had heightened sensitivity to loud noises, a characteristic seen in many children with autism (R. C. Sullivan, 1994; D. Williams, 1996).

♦ *A specific intervention or treatment plan is developed and implemented.* Developing a treatment plan involves determining the method by which a target behavior is to be modified. Sometimes a behavior's frequency can be increased simply by reinforcing the behavior every time it occurs. When the existing frequency (baseline) of a desired response is very low, however, the response may have to be shaped through the reinforcement of successively closer and closer approximations. An undesirable behavior can be eliminated through such methods as extinction, reinforcement of incompatible behaviors, or punishment. In many cases, explicit instruction is part of the intervention as well.

In designing an intervention, it's often helpful to address the apparent functions that particular behaviors serve for the individual (as previously determined by a functional analysis). It's also helpful to change the environment in ways that encourage productive behaviors. In school settings, an approach known as **positive behavior support (PBS)** does both of these things by employing strategies such as the following (Crone & Horner, 2003; Koegel, Koegel, & Dunlap, 1996; Ruef, Higgins, Glaeser, & Patnode, 1998; Wheeler & Richey, 2010):

- Teach behaviors that can serve the same purpose as (and can therefore replace) inappropriate behaviors.

- Minimize conditions that might trigger inappropriate behaviors.
- Establish a predictable daily routine as a way of minimizing anxiety and making the student feel more comfortable and secure.
- Give the student opportunities to make choices; in this way the student can often gain desired outcomes without having to resort to inappropriate behavior.
- Make adaptations in the curriculum, instruction, or both to maximize the likelihood of academic success (e.g., build on the student's interests, present material at a slower pace, or intersperse challenging tasks among easier and more enjoyable ones).

Although positive behavior support has behaviorist elements, it also incorporates contemporary theories of motivation, as reflected in its attempts to minimize anxiety, provide opportunities for choice making, and promote mastery of classroom tasks. The importance of doing such things will become clearer when we discuss motivation and emotion in Chapters 16 and 17.

♦ *The treatment is monitored for effectiveness as it progresses, and it's modified if necessary.* When a desired behavior increases or an unwanted behavior decreases during the intervention program (compared with the baseline rate), the logical conclusion is that the intervention is effective. When little change is observed from baseline to treatment, however, a modification is warranted. Perhaps the teacher or therapist is trying to shape behavior too quickly. Perhaps the “reinforcer” isn't really reinforcing. Perhaps an undesired behavior that the teacher or therapist is trying to eliminate through extinction is being maintained by reinforcers beyond his or her control. An unsuccessful intervention program should be carefully examined for these and other possible explanations for its ineffectiveness and then modified accordingly.

♦ *Measures are taken to promote generalization of newly acquired behaviors.* Although people sometimes generalize the responses they learn in one situation to other situations, there's no guarantee that they'll do so. In fact, many ABA programs have limited success precisely because responses that are learned under some stimulus conditions don't generalize to others (Alberto & Troutman, 2009; Landrum & Kauffman, 2006; Schloss & Smith, 1994). Psychologists have suggested several strategies for promoting generalization during an ABA program:

- Teach the target behavior in numerous contexts, including many realistic ones; if possible, teach the behavior in the actual situations in which it is ultimately desired.
- Teach many different versions of the behavior; for example, when teaching interpersonal skills, teach a variety of ways to interact appropriately with others.
- Teach the relationship of the desired behavior to reinforcers that occur naturally in the environment; for example, point out that better personal hygiene leads to more rewarding interactions with others.
- Reinforce the behavior when it spontaneously occurs in new situations; in other words, specifically reinforce generalization (Bourbeau, Sowers, & Close, 1986; Emshoff, Redd, & Davidson, 1976; Haring & Liberty, 1990; B. M. Johnson et al., 2006; T. F. Stokes & Baer, 1977).

♦ *Treatment is phased out after the desired behavior is acquired.* Once the terminal behavior has been reached, the ABA program is gradually phased out. In many instances, newly acquired behaviors begin to lead to reinforcement naturally; for example, the aggressive student who learns more acceptable social behaviors starts making friends, and the student who has finally learned to read begins to feel successful and enjoy reading. In other situations, maintaining the target behavior may require intermittent reinforcement, such as a series of successively higher variable-ratio reinforcement schedules.

Although a large body of research indicates that ABA techniques work, psychologists don't always know exactly *why* they work. One likely factor underlying their effectiveness is the use of clearly specified response–reinforcement contingencies. Because desired behaviors are described in specific, concrete terms, learners know exactly what's expected of them. And the immediate feedback that learners receive through reinforcement provides them with clear guidance as to when their behaviors are on target and when they aren't.

## Using Applied Behavior Analysis with Large Groups

Our emphasis until now has been on the use of applied behavior analysis with individuals. But ABA techniques can also be used to change the behavior of *groups* of people—for example, the behavior of an entire class of students. At least three methods have been shown to be effective in working with groups: a group contingency, a token economy, and schoolwide positive behavior support.

### **Group Contingency**

In a **group contingency**, an entire group must perform a desired behavior in order for reinforcement to occur. For example, in one study (Lovitt, Guppy, & Blattner, 1969), a group contingency improved the weekly spelling test performance of a class of 32 fourth graders. In Phase 1 of the study, when normal classroom procedures were in place (baseline), an average of only 12 students (38%) had perfect spelling tests in any given week. In Phase 2, the same test was given four different times during the week, and students who obtained perfect test scores had free time (the reinforcer) during subsequent administrations of the test. During this individual-contingency phase, the percentage of correct spelling tests each week more than doubled (80%). In Phase 3, the individual contingency continued to apply, but in addition, if the entire class achieved perfect spelling tests by Friday, the class could listen to the radio for 15 minutes. This group contingency led to 30 perfect spelling tests (94% of the class) a week.

The *good behavior game* is an example of how a group contingency can significantly reduce the overall rate of classroom misbehaviors (Bradshaw, Zmuda, Kellam, & Ialongo, 2009; Embry, 2002; Taub & Pearrow, 2006). The earliest documented use of this approach (Barrish, Saunders, & Wolf, 1969) involved a class of particularly unruly fourth graders, seven of whom had repeatedly been referred to the principal for problem behaviors. The students were divided into two teams, and their behaviors were carefully observed during math and reading lessons. Each time a student engaged in out-of-seat or talking-out behavior, that student's team gained a mark on its designated part of the chalkboard. The team that received fewer marks during the lesson won special privileges (e.g., being first in the lunch line, having free time later in the day). If both teams had a maximum of only five marks, both won privileges.

Figure 5.4 shows the results of the intervention. Notice how baseline data were first collected during both math and reading each day. The good behavior game was instituted in the math lesson on Day 23; at this point, out-of-seat and talking-out behaviors decreased sharply during math while continuing at a high frequency during reading. On Day 45, the game was initiated during reading instruction and stopped during math instruction; notice how the frequencies of misbehaviors changed accordingly. On Day 51, the game was reinstated in math, resulting (again) in a decrease in misbehavior during that time. In this study, two techniques were used to minimize the likelihood that other, unknown factors were responsible for the behavior changes: starting the game on different days for math versus reading—a multiple baseline approach—and switching from reinforcement to nonreinforcement and then back again—a technique called *reversal*.



**Figure 5.4**

Percentage of 1-minute intervals in which talking-out and out-of-seat behaviors occurred during math and reading periods

From “Good Behavior Game: Effects of Individual Contingencies for Group Consequences on Disruptive Behavior in a Classroom” by H. H. Barrish, M. Saunders, & M. M. Wolf, 1969, *Journal of Applied Behavior Analysis*, 2, p. 122. Copyright 1969 by *Journal of Applied Behavior Analysis*. Reprinted by permission.

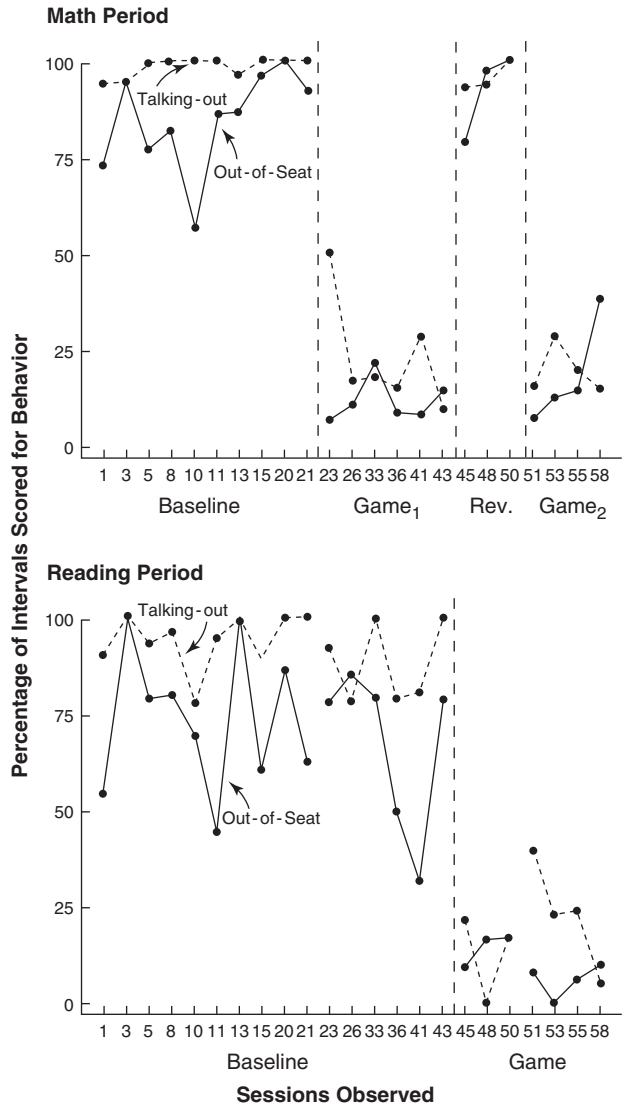

Group contingencies have been shown to improve not only academic achievement and classroom behavior but also playground behaviors in young elementary students and energy-saving behaviors in college dormitory residents (Bekker et al., 2010; Heck, Collins, & Peterson, 2001). However, they're effective *only if* everyone in the group is capable of making the desired responses. Peer pressure and social reinforcement partly account for their effectiveness: Students encourage their peers to do well and offer praise when performance improves. In addition, when increased academic achievement is the desired behavior, high-achieving students may assist their lower-achieving classmates by tutoring and providing extra practice in the subject matter (Pigott, Fantuzzo, & Clement, 1986; S. L. Robinson & Griesemer, 2006; Slavin, 1983b).

A challenge in using group contingencies is to identify a consequence that all students find reinforcing. One possible strategy is use of a “mystery reinforcer” that varies from day to day. For instance, a teacher might have an envelope or jar containing slips of paper describing various possibilities—free time, a pizza party, and so on. Once students have, as a group, met the criterion for reinforcement, the teacher or a student pulls out a slip of paper identifying the surprise consequence for the day (S. L. Robinson & Griesemer, 2006).

### ***Token Economy***

In a **token economy**, individuals who behave appropriately are reinforced with **tokens**—items that can later be traded for **backup reinforcers**, which are objects or privileges of each individual’s choice. For example, a classroom teacher might reinforce students with one poker chip for each completed assignment. Just before lunch, students can use their poker chips to “buy” small treats, free time in the reading center, or a prime position in the lunch line. A token economy typically includes the following elements:

- *A set of rules* describing the responses that will be reinforced. The rules should be relatively few in number so that they can easily be remembered.
- *Token reinforcers* that can be awarded immediately when appropriate behaviors are exhibited. For instance, tokens might be poker chips, checkmarks on a grid sheet, play money, or points. Even class grades have been successfully used as tokens (McKenzie, Clark, Wolf, Kothera, & Benson, 1968).
- *A variety of backup reinforcers* for which tokens can be exchanged. Examples are free time, favorite activities, participation in special events, and small toys and trinkets. In one study, parent-awarded allowances were successfully used as backup reinforcers (McKenzie et al., 1968).
- *A “store” at which the backup reinforcers can be “purchased.”* Young children should be allowed at least one purchase opportunity a day; for older children, one or two opportunities a week may be sufficient.

Token economies have at least two advantages in group settings. First, teachers and therapists can easily use the tokens to provide immediate (rather than delayed) reinforcement. Second, the availability of many different backup reinforcers increases the odds that everyone in the program can work for a desired consequence. In fact, children and adults alike seem to prefer having some choice in the reinforcers for which they work (Fisher & Mazur, 1997; Geckeler, Libby, Graff, & Ahearn, 2000; Sran & Borrero, 2010; Tiger, Hanley, & Hernandez, 2006). The tokens themselves often become effective reinforcers as well (Hundert, 1976). Perhaps they become secondary reinforcers through repeated association with other reinforcing objects and events, or perhaps they’re effective simply because they provide feedback that learners are doing something right.

### ***Schoolwide Positive Behavior Support***

In recent years some schools have successfully instituted positive behavior support programs in an effort to encourage productive behaviors in *all* students. These programs typically include most or all of the following:

- Explicitly defining and teaching appropriate behaviors, including productive ways of getting desired outcomes (e.g., teacher attention)

- Designing a curriculum and implementing instructional practices tailored to students' current needs and ability levels
- Giving students opportunities to make choices
- Regularly reinforcing students for behaving appropriately, almost always with praise but often also with tokens or coupons that can be traded for special prizes and privileges (e.g., school supplies, stuffed animals, free time in the gymnasium)
- Continually monitoring the program's effectiveness by examining office referrals, disciplinary actions, and other relevant data

Such steps often lead to dramatic changes in students' behavior and are especially helpful in schools that have historically had many discipline problems. Furthermore, teachers become more optimistic that they can truly make a difference in improving students' classroom behavior and academic achievement (T. J. Lewis, Newcomer, Trussell, & Richter, 2006; Osher, Bear, Sprague, & Doyle, 2010; Warren et al., 2006).

## Adding a Cognitive Component to ABA

Increasingly, many teachers, clinicians, and other practitioners are adding cognitive elements to ABA techniques, perhaps using such terms as *cognitive behavior modification*, *cognitive behavior therapy*, or *cognitive-behavioral intervention* to describe their approaches. For instance, interventions often include *modeling* the desired behavior, a practice that draws from social cognitive theory (see Chapter 6). Another common strategy is **coaching**, whereby the teacher or therapist verbally instructs and guides the learner in the practice of appropriate behaviors. Such approaches also focus on problem solving; for example, a teacher or therapist might ask the student to think carefully about the effects that various behaviors may have in problem situations and to choose those behaviors that are likely to bring about desired consequences.

Individual and schoolwide positive behavior support programs are, by their very nature, hybrids that incorporate both behaviorist and cognitivist principles. For instance, typical curricular and instructional adaptations make use of many of the principles we'll examine in upcoming discussions of cognitive psychology (Chapters 8 through 11). It seems that, in general, practitioners are increasingly agreeing with a point I made in Chapter 1: Virtually all theoretical perspectives provide useful insights into how we might help children and adults learn and behave more effectively.

## INSTRUCTIONAL OBJECTIVES

---

As we've seen, a standard practice in behaviorist techniques is to specify the terminal behavior in precise, observable terms before conditioning begins. This principle of *a priori* specification of the terminal behavior in observable, measurable terms has been applied to classroom instruction in the form of **instructional objectives**, descriptions of what students should know and be able to do at the end of instruction.

### Behavioral Objectives

Initially, instructional objectives had a predominantly behaviorist flavor and were known as **behavioral objectives**. Ideally, a behavioral objective has three components (Mager, 1962, 1984;

Schloss & Smith, 1994). First, the outcome is stated in terms of an observable and measurable behavior. Consider this objective:

The student will be aware of current events.

A student's "awareness" isn't easily observable. The same objective can be stated in terms of one or more specific behaviors that a student should exhibit; consider this one as an example:

The student will describe the major points of dissension between the Israelis and the Palestinians.

Some verbs (e.g., *be aware of, understand, appreciate, know, remember*) tell us little, if anything, about what students should actually be able to do, but others (e.g., *describe, write, compute, list, select*) clearly communicate observable responses. We can probably conceptualize almost any objective in behavioral terms if we think about the specific things people would have to do to convince someone that they've met the objective (Mager, 1972).

Second, a behavioral objective identifies the conditions under which the behavior should be exhibited. Sometimes we expect desired behaviors to occur in specific situations (i.e., under certain stimulus conditions). For example, when I taught a graduate course in educational assessment, one of my objectives was as follows:

The student will correctly compute test–retest reliability.

I didn't expect students to memorize the formula for calculating test–retest reliability, however. Rather, there was a condition under which I expected the behavior to occur:

Given the formula for a correlation coefficient, the student will correctly compute test–retest reliability.

Finally, a behavioral objective includes a criterion for judging the acceptable performance of the desired behavior. Many behaviors aren't strictly right or wrong; instead, they vary on a continuum of relative rightness versus wrongness. In cases where right and wrong behaviors aren't obvious, a behavioral objective should specify the criterion for acceptable performance, perhaps in terms of a certain percentage of correct answers, a certain time limit, or the degree of acceptable deviation from the correct response (Mager, 1962, 1984). Following are some examples to illustrate this point:

On weekly written spelling tests, the student will correctly spell at least 85% of assigned spelling words.

Given a sheet of 100 single-digit addition problems that include all possible combinations of the digits 0 through 9, the student will correctly write the answers to these problems within 5 minutes.

Given the formula for a correlation coefficient, the student will correctly compute test–retest reliability, with differences from a computer-calculated coefficient being attributable to rounding errors.

## Current Perspectives on Instructional Objectives

Traditional behavioral objectives have frequently been criticized for focusing on picayune, concrete details rather than on more central—but often more abstract—educational goals. For instance, many lists of behavioral objectives focus on **lower-level skills** rather than

**higher-level skills:** They emphasize behaviors that depend on knowledge of facts rather than on behaviors that reflect more complex and sophisticated thinking and learning. Such lower-level objectives may be prevalent simply because they're the easiest ones to conceptualize and write.

In any given school year, students must accomplish a wide variety of tasks, including many that involve lower-level skills and many others that involve higher-level skills. Writing behavioral objectives that cover each and every one of them can become a burdensome, if not impossible, task. As a result, many educators have proposed that a smaller number of general, nonbehavioral objectives provide a reasonable alternative (e.g., Gronlund & Brookhart, 2009; Popham, 1995; G. J. Posner & Rudnitsky, 1986). But in such situations, it's helpful to list examples of behaviors that reflect each abstract objective. To illustrate, imagine that we want high school students to understand, evaluate, and critique the things that they read—an objective that certainly involves higher-level thinking skills. We might list several behavioral manifestations of critical thinking skills in reading, including the following:

1. Distinguishes between main ideas and supporting details
2. Distinguishes between facts and opinions
3. Distinguishes between facts and inferences
4. Identifies cause-effect relations
5. Identifies errors in reasoning
6. Distinguishes between valid and invalid conclusions
7. Identifies assumptions underlying conclusions (Gronlund & Brookhart, 2009, p. 72)

This is hardly an exhaustive list of what critical thinking in reading entails, but it does give us an idea of the terminal behaviors we want to see.

## Usefulness and Effectiveness of Objectives

Although educators have largely drifted away from identifying specific behavioral objectives, more general instructional objectives—perhaps labeled as *goals*, *outcomes*, *standards*, *proficiencies*, *targets*, or *benchmarks*—continue to play a key role in curriculum design and assessment practices. From a teacher's perspective, instructional objectives serve several useful functions (Gronlund & Brookhart, 2009; Stiggins, 2008; Tomlinson & McTighe, 2006). First, specification of a lesson's objectives in precise terms helps a teacher choose the most effective method of teaching the lesson.<sup>4</sup> For instance, when teaching a unit on basic addition, a teacher might use flash cards if the objective is *rapid recall* of number facts but should probably use word problems or real-life problem-solving activities if the objective is the *application* of those number facts. A second advantage is that objectives, especially when described in behavioral terms, are easily communicated from one teacher to another. For example, although teachers may differ in their conception of what "application of addition principles" means, they're likely to interpret "correct

---

<sup>4</sup>Some educators advocate an approach known as a *backward design*, in which a teacher begins at the end—identifying the desired final objectives of instruction—and then works backwards in time, determining observable student behaviors that reflect accomplishment of the objectives and, finally, choosing appropriate instructional methods and experiences through which students can acquire those behaviors (e.g., Tomlinson & McTighe, 2006; G. Wiggins & McTighe, 2005).

solution of two-digit addition word problems” similarly. Finally, objectives facilitate the evaluation of both students and instructional programs: Student accomplishment and program effectiveness can be evaluated on the basis of whether manifestations of the desired outcomes are observed.

From a student’s perspective, instructional objectives have additional advantages. Students who are told what they should be able to do at the conclusion of an instructional unit know what they must focus on, have tangible goals to strive for, and are better able to judge how successfully they’ve learned (Gronlund & Brookhart, 2009; McAshan, 1979; Stiggins, 2008).

Despite such potential benefits, research studies investigating the effectiveness of objectives for improving academic performance have yielded mixed results. Objectives tend to focus teachers’ and students’ attention toward certain information and skills (those things included in the objectives) and away from other subject matter (R. L. Linn, 2003; McCrudden, Schraw, & Kambe, 2005; Slavin, 1990b). If the stated objectives encompass *everything* that students should learn, the use of objectives in the classroom can enhance learning. But if the objectives include only a portion of what the teacher deems to be important, while excluding other, equally important, material, some critical information and skills are less likely to be mastered than they might otherwise.

Basing major decisions on whether students achieve predetermined objectives—that is, making decisions about promotion, graduation, teacher salaries, school funding, and so on, based on students’ scores on a single **high-stakes test**—exacerbates the problem. When teachers are held accountable for their students’ performance on a particular test, many of them understandably devote many class hours to the knowledge and skills the test assesses, and students may focus their studying efforts on that same material (Au, 2007; Hursh, 2007; R. L. Linn, 2000, 2003). The result is often that students perform at higher levels on the test *without* improving their achievement and abilities more generally (Amrein & Berliner, 2002; Jacob, 2003; R. M. Ryan & Brown, 2005).

In the United States, such concerns have come to a head with the passage of the No Child Left Behind Act of 2001—often known simply as NCLB. This legislation mandates that all states establish

challenging academic content standards in academic subjects that—

- (I) specify what children are expected to know and be able to do;
- (II) contain coherent and rigorous content; and
- (III) encourage the teaching of advanced skills (P.L. 107–110, Sec. 1111)

School districts must annually assess students in grades 3 through 8 to determine whether students are making *adequate yearly progress* in meeting state-determined standards in reading, math, and science. The nature of this progress is defined differently by each state, but assessment results must clearly show that all students, including those from diverse racial and socioeconomic groups, are making significant gains. (Students with significant cognitive disabilities may be given alternative assessments, but they must show improvement commensurate with their ability levels.) Schools that demonstrate progress receive rewards, such as teacher bonuses or increased budgets. Schools that *don’t* show progress are subject to sanctions and corrective actions (e.g., administrative restructuring, dismissal of staff members), and students have the option of attending a better public school at the school district’s expense.

The intent behind NCLB—to boost children’s academic achievement, especially that of children from minority groups and low-income backgrounds—is certainly laudable. However, many

experts fear that its focus on increasing test scores and accountability, rather than on supporting and rewarding effective instructional practice, is misplaced. High standards for performance may be unrealistic for students who may have had poor nutrition and little preparation for academic work prior to the school years (Forte, 2010; Hursh, 2007; Mintrop & Sunderman, 2009). And many students may have little motivation to put forth their best effort on statewide exams, hence providing significant underestimates of what they've learned (Chabrán, 2003; K. E. Ryan, Ryan, Arbuthnot, & Samuels, 2007; Siskin, 2003). Whether such problems can be adequately addressed by revisions to the legislation or its implementation remains to be seen.

## Formulating Different Levels of Objectives

In one form or another, objectives, standards, benchmarks—call them what you will—are here to stay, at least for the foreseeable future. The trick is to make sure that they truly reflect the knowledge and skills that are most important for learners to acquire. Part of the challenge is that teachers, parents, taxpayers, and even experts often disagree on the specific objectives that students at various grade levels should achieve. For example, some constituencies ask schools to increase students' factual knowledge—a perspective sometimes referred to as “back to the basics” or “cultural literacy” (e.g., Hirsch, 1996). Yet many others encourage schools to foster higher-level thinking skills such as problem solving and critical thinking and to help students develop the “habits of mind” (e.g., scientific reasoning, drawing inferences from historical documents) central to various academic disciplines (e.g., Brophy, Alleman, & Knighton, 2009; M. C. Linn, 2008; Monte-Sano, 2008; R. K. Sawyer, 2006). In my own view, objectives that reflect fairly simplistic acquisitions—knowledge of basic math facts, locations of different continents and countries on the globe, and so on—are sometimes quite appropriate. But in many circumstances, objectives reflecting relatively sophisticated levels of learning are more desirable, especially as students get older.

Fortunately, educators have several resources from which they can draw as they formulate objectives for their students and school districts. Some resources take the form of **taxonomies** of objectives—descriptions of various behaviors we might want to see students demonstrate, often listed in order of increasing complexity. One early and widely used example, Bloom's Taxonomy of Educational Objectives (B. S. Bloom, Englehart, Furst, Hill, & Krathwohl, 1956), describes six general levels of knowing and using information, shown in Figure 5.5. Bloom and his colleagues originally presented the six levels as a hierarchy, with each one depending on those preceding it in the list. Although the hierarchical nature of Bloom's taxonomy is in doubt (L. W. Anderson et al., 2001; Krathwohl, 1994; Marzano & Kendall, 2007), it nevertheless provides a useful reminder that instructional objectives should often encompass higher-level thinking skills as well as the knowledge of simple, discrete facts. In Chapter 11, we'll look at an alternative taxonomy that's based on more contemporary, cognitivist perspectives of learning and thinking.

Another source of guidance comes from national or international standards created by professional organizations that represent various academic disciplines. Many discipline-specific professional groups have established standards for their discipline. You can find examples at websites for the following organizations:

- American Council on the Teaching of Foreign Language ([www.actfl.org](http://www.actfl.org))
- National Association for Sport and Physical Education ([www.aahperd.org/NASPE](http://www.aahperd.org/NASPE))
- National Association for Music Education ([www.menc.org](http://www.menc.org))

<ol style="list-style-type: none"> <li>1. <b>Knowledge:</b> Rote memorizing of information in a basically word-for-word fashion; for example, reciting definitions of terms or remembering lists of items.</li> <li>2. <b>Comprehension:</b> Translating information into one's own words; for example, rewording a definition or paraphrasing a rule.</li> <li>3. <b>Application:</b> Using information in a new situation; for example, applying mathematical principles to the solution of word problems or applying psychological theories of learning to educational practice.</li> </ol>	<ol style="list-style-type: none"> <li>4. <b>Analysis:</b> Breaking information down into its constituent parts; for example, discovering the assumptions underlying a philosophical essay or identifying fallacies in a logical argument.</li> <li>5. <b>Synthesis:</b> Constructing something new by integrating several pieces of information; for example, developing a theory or presenting a logical defense for a particular point of view.</li> <li>6. <b>Evaluation:</b> Placing a value judgment on data; for example, critiquing a theory or determining the appropriateness of conclusions drawn from a research study.</li> </ol>
--	--

**Figure 5.5**

Bloom's Taxonomy of Educational Objectives

Adapted from B. S. Bloom, Englehart, Furst, Hill, & Krathwohl, 1956.

- National Center for History in the Schools ([www.sscnet.ucla.edu/nchs](http://www.sscnet.ucla.edu/nchs))
- National Council of Teachers of English ([www.ncte.org](http://www.ncte.org))
- National Council of Teachers of Mathematics ([www.nctm.org](http://www.nctm.org))
- National Council for Geographic Education ([www.ncege.org](http://www.ncege.org))

Such standards typically reflect the combined thinking of many experts in a discipline and so almost certainly reflect much of the best of what the discipline has to offer.

Existing standards are certainly useful in helping teachers focus instruction on important educational objectives—including problem solving, critical thinking, and other higher-level processes—in various content domains. They must be used with caution, however, as some of them offer lengthy lists that can't realistically be accomplished in any single school year (M. C. Linn, 2008; W. H. Schmidt, 2008; R. M. Thomas, 2005). Furthermore, most of them omit objectives that transcend particular academic disciplines—for instance, objectives related to acquiring effective work habits, study skills, and interpersonal behaviors. In addition to any existing standards teachers may draw on, then, they should also formulate some of their *own* objectives for students' learning.

## PROGRAMMED INSTRUCTION AND COMPUTER-ASSISTED INSTRUCTION

Recall B. F. Skinner's concern that reinforcement in the classroom is presented inconsistently, and often only long after desired responses have been made. To remedy the situation, Skinner (1954) developed a technique most frequently known as **programmed instruction**, or **PI**. Initially, programmed instruction involved a *teaching machine*, a box enclosing a long roll of printed material that a student could advance past a display window, exposing small portions of information successively and systematically. In the 1960s and 1970s, PI increasingly took the form of programmed textbooks and, eventually, computer software.

Regardless of its medium, programmed instruction consists of several standard features. First, the material to be learned is presented through a series of discrete segments, or **frames**.



The first frame presents a new piece of information and poses a question about it. The student responds to the question and then moves to the next frame; that frame provides the correct answer to the question, presents more information, and asks another question. The student continues through the frames, encountering new information, responding to questions, and checking answers. Intrinsic to this approach are several behaviorist concepts and principles, including the following:

- *Active responding.* The student must make a response in each frame.
- *Shaping.* Instruction begins with information the student already knows. New information is broken into tiny pieces, and instruction proceeds through a gradual presentation of increasingly difficult pieces. As the successive pieces are presented and questions of increasing difficulty are answered, the terminal behavior—demonstrated mastery of the topic—is gradually shaped.
- *Immediate reinforcement.* Shaping proceeds so slowly that students almost always make a correct response; in this way, students practice appropriate rather than inappropriate responses, and so the probability of reinforcement is quite high. Each correct answer is reinforced immediately in the form of feedback that it's correct.<sup>5</sup>
- *Individual differences in learning rate.* Programmed instruction is self-paced, allowing students to progress through an instructional unit at their own rate of speed.

Early programmed instruction involved a **linear program**: All students proceeded through exactly the same sequence of frames in exactly the same order. In 1961, Crowder and Martin introduced the **branching program**, which typically progresses in larger steps than a linear program (each frame presents more information), so that error rates in responding are somewhat higher. A student who responds incorrectly is directed to one or more remedial frames for further practice on that part of the lesson before being allowed to continue with new material. The major advantage of a branching program is that it provides remedial instructional frames only for students who have difficulty with a particular concept or skill; other students can move on to new material without having to spend time on practice they don't need.

A branching program can be cumbersome in a paper form (students are often referred to different pages, depending on their responses) but is easy to use when administered through computer technology—an approach known as **computer-assisted instruction** or **CAI**. Computer-assisted instruction has several advantages over paper-and-pencil-based programmed instruction. First, the computer automatically presents appropriate follow-up frames for various student responses. Second, because of computers' graphics capabilities (e.g., videos, animations), CAI can present information in ways that traditional paper-and-pencil programmed instruction cannot. Third, the computer can record and maintain ongoing data for each student—how often a student is right and wrong, how quickly he or she answers questions, how far he or she progresses in the program, and so on. With such data, a teacher can monitor each student's progress and identify students who are having unusual difficulty. And finally, a computer can be used to provide instruction when flesh-and-blood teachers aren't available; for example, CAI has been used to deliver college instruction in rural areas far removed from university settings.

---

<sup>5</sup>Skinner believed that making errors interferes with learning, in large part because students practice incorrect responses. In contrast, many cognitive theorists believe that errors can sometimes be helpful, in that they encourage students to examine and reevaluate their reasoning and problem-solving strategies (e.g., see the discussion of conceptual change in Chapter 10).

## Effectiveness of PI and CAI

Noncomputer-based programmed instruction appears to provide little if any advantage over traditional instructional methods (C. C. Kulik, Schwalb, & Kulik, 1982; J. A. Kulik, Cohen, & Ebeling, 1980). In contrast, CAI can sometimes lead to greater academic achievement and improved student attitudes toward schoolwork, at least in comparison with more traditional methods. However, the differences in achievement for CAI versus traditional methods are typically small or moderate, rather than large (Blok, Oostdam, Otter, & Overmaat, 2002; Fletcher-Flinn & Gravatt, 1995; Liao, 1992; Lockee, Larson, Burton, & Moore, 2008; Luyben, Hipworth, & Pappas, 2003).

Generally speaking, PI and CAI are more likely to be effective when behaviorist principles—opportunities for making active responses, immediate reinforcement of responses, gradual shaping of the terminal behavior, and so on—are adhered to (e.g., Kritch & Bostrow, 1998; Tudor, 1995). Exceptions have been noted, however. In one study of programmed instruction at the college level, occasional 10-second delays in feedback actually *enhanced* students' learning, apparently because the delays gave students more time to study the material in front of them (Crosbie & Kelly, 1994).

As cognitivism increasingly dominates theories of human learning, computer instruction is no longer restricted to the traditional, behaviorism-based CAI approach; hence, you may sometimes see reference to such terms as *computer-based instruction (CBI)* or *computer-assisted learning (CAL)* rather than CAI. Today's computer-based instruction encompasses a wide variety of innovations, including simulations that engage students in realistic activities (e.g., dissecting an animal, flying an airplane), *intelligent tutors* that diagnose and address specific problem areas, computer tools (e.g., spreadsheets, graphing programs, music composition software), and challenging problems and games. Later in the book, we'll consider how computer technology can be used to enhance group learning and meaning-making (Chapter 13), promote more effective study strategies (Chapter 14), and provide authentic problem-solving tasks (Chapter 15).

## MASTERY LEARNING

---

Inherent in the behaviorist perspective is the belief that, given appropriate environmental conditions, people are capable of acquiring many complex behaviors. Such optimism is reflected in **mastery learning**, an approach to instruction in which students must learn the material in one lesson to a high level of proficiency before proceeding to the next lesson. Underlying this approach is the assumption that most students can truly master school subject matter if they're given sufficient time and instruction to do so. Mastery learning gained prominence during the 1960s, and many educators have since advocated for it in one form or another (e.g., B. S. Bloom, 1981; J. B. Carroll, 1989; Gentile & Lalley, 2003; Knutson, Simmons, Good, & McDonagh, 2004; Piotrowski & Reason, 2000).

Mastery learning is based, in part, on the concept of *shaping*. At first, a relatively simple response is reinforced until it's emitted frequently (i.e., until it's mastered), then a slightly more difficult response is reinforced, and so on until eventually the desired terminal behavior is acquired. Consistent with shaping, mastery learning usually includes the following components:

- *Small, discrete units.* Course content is broken up into a number of separate units or lessons, with each unit covering a small amount of material.

- *A logical sequence.* Units are sequenced such that basic concepts and procedures—those that provide the foundation for later units—are learned first. More complex concepts and procedures, including those that build on basic units, are learned later. For example, a unit in which students learn what a fraction is would obviously come before a unit in which they learn how to add two fractions. The process through which the component parts of the subject matter are identified and sequenced, going from simple to more complex, is called **task analysis**. (For various approaches to task analysis, see R. E. Clark, Feldon, van Merriënboer, Yates, & Early, 2008; Jonassen, Hannum, & Tessmer, 1989.)
- *Demonstration of mastery at the completion of each unit.* Before “graduating” from one unit to the next, students must show that they’ve mastered the current unit—for example, by taking a test on the unit’s content.
- *A concrete, observable criterion for mastery of each unit.* Mastery of a topic is defined in specific, concrete terms. For example, to pass a unit on adding fractions with the same denominator, students might have to answer at least 90% of test items correctly.
- *Additional, remedial activities for students needing extra help or practice.* Students don’t always demonstrate mastery on the first try. Additional support and resources—perhaps alternative approaches to instruction, different materials, workbooks, study groups, and individual tutoring—are provided for students who need them.

Students engaged in mastery learning often proceed through the various units at their own speed; hence, different students may be studying different units at any given time. But it’s also possible for an entire class to proceed through a sequence at the same time: Students who master a unit earlier than their classmates can pursue various enrichment activities, or they can serve as tutors for those still working on the unit (Block, 1980; Guskey, 1985).

### Keller’s Personalized System of Instruction (PSI)

One form of mastery learning—Fred Keller’s **personalized system of instruction** (also known as **PSI** or the **Keller Plan**)—is sometimes used at the college level (Keller, 1968, 1974; also see E. J. Fox, 2004; Lockee et al., 2008). In addition to the discrete units, logical sequence, self-pacing, and frequent measures of mastery characteristic of other mastery-learning approaches, PSI encompasses the following features:

- *Emphasis on individual study.* Most learning occurs through independent study of such written materials as textbooks and study guides. One-on-one tutoring provides additional assistance when necessary.
- *Unit exams.* An examination on each unit assesses students’ mastery of the material. Students receive immediate feedback about their performance.
- *Supplementary instructional techniques.* Traditional group instructional methods (e.g., lectures, demonstrations, discussions) are occasionally provided to supplement the material that appears in the textbook or other assigned readings. These group classes are optional but are intended to motivate and stimulate students.
- *Use of proctors.* Proctors, usually more advanced students, administer and score exams and tutor students on topics with which they’re having difficulty.

As you can see, the teacher of a PSI course doesn’t lecture very much; instead, the teacher serves primarily as a curriculum developer, exam writer, proctor coordinator, and record keeper.

Rather than leading students through course content, the PSI teacher provides an elaborate system whereby students, with the assistance of study guides and tutors, find their own way through the content.

## Effectiveness of Mastery Learning and PSI

By and large, research findings indicate that mastery learning (including PSI) facilitates student learning and often leads to higher achievement than more traditional instruction (Arlin, 1984; J. L. Austin, 2000; E. J. Fox, 2004; Hattie, 2009; C. C. Kulik, Kulik, & Bangert-Drowns, 1990). Furthermore, students in mastery learning programs often retain the things they've learned for longer periods of time; for instance, in one study, college students in mastery-based psychology classes remembered 75 to 85% of the material after 4 months and 70 to 80% after 11 months (DuNann & Weber, 1976; J. A. Kulik, Kulik, & Cohen, 1979; Semb, Ellis, & Araujo, 1993). And PSI, at least, facilitates better study habits: Although PSI students don't appear to study more than other students, they study regularly rather than procrastinating and cramming the way students in traditional courses often do (Born & Davis, 1974; J. A. Kulik et al., 1979). Low-achieving students in particular seem to benefit from a mastery learning approach (DuNann & Weber, 1976; Knutson et al., 2004; C. C. Kulik et al., 1990).

Mastery learning and PSI have their downsides, however (Arlin, 1984; Berliner, 1989; Prawat, 1992). In many cases, students who learn quickly receive less instruction than their classmates, raising a concern about possibly inequitable treatment of these students. Furthermore, when, for logistical reasons, fast-learning students must wait until their slower classmates have also mastered the material, they learn less than they might otherwise. Yet when all students are allowed to work at their own pace, teachers must assist and keep track of perhaps 25 or 30 students working on different tasks and succeeding at different rates; hence, teachers may do more "managing" (e.g., distributing materials, grading tests) than actual teaching.

Additional weaknesses have been noted for PSI in particular (Gasper, 1980; Sussman, 1981; Swenson, 1980). One difficulty lies in the required mastery of material: Some students never meet the criterion for passing exams despite repeated assessments. A second weakness is the lack of social interaction with peers—interaction that many students see as beneficial to their learning. A third problem is related to the self-paced nature of a PSI course, which is sometimes compromised if university policy requires that students complete a course within a single term: Poorly motivated students are apt to procrastinate until finally they must withdraw from the course. Withdrawal rates for PSI courses are especially high when students take a course entirely online, without ever seeing a classroom or fellow classmates (C. C. Kulik et al., 1990; J. A. Kulik et al., 1979; Pear & Crone-Todd, 1999). Several techniques have been shown to reduce procrastination and withdrawal from PSI, among them setting target dates for the completion of different units, giving bonus points for early completion of units, and eliminating the need to complete the course within a single college term (Bufford, 1976; Reiser & Sullivan, 1977; Sussman, 1981).

Mastery learning is probably most appropriately used when a teacher's main objective is for students to learn specific skills or a specific body of information prerequisite to later topics. In such situations, the immediate feedback and emphasis on mastery of course material may well be reasons why mastery learning increases student achievement, especially for low-achieving students. When the objective is something other than acquiring information or skills, however—

for example, when the objective is for students to gain a better understanding of controversial issues or to work cooperatively with classmates to solve complex problems—a mastery approach may not be the method of choice.

## WHEN BEHAVIORIST TECHNIQUES ARE MOST APPROPRIATE \_\_\_\_\_

Instructional methods based on concepts and principles of instrumental conditioning can be beneficial for most learners at one time or another, especially when important behaviors and skills require considerable repetition and practice to master (Brophy, 2004). As you undoubtedly know from your own experience, tedious drill-and-practice activities often have little intrinsic appeal, and so some external consequence—perhaps a few M&Ms once in a while, or perhaps an occasional break to check and respond to incoming email messages (an activity reinforcer)—can help keep you going.

Overall, however, behaviorist approaches are probably more appropriate for certain types of students than for others. Frequent success experiences and reinforcements, such as those provided by programmed instruction or mastery learning, are especially beneficial to students who have previously had little success in their academic careers (Gentile & Lalley, 2003; Gustafsson & Undheim, 1996; Snow, 1989). Children officially identified as having a “developmental delay” or “learning disability” fall into this category, as do many students with chronic behavior problems. A regular pattern of academic success is exactly what such students need to bolster the low self-confidence resulting from a long string of academic failures.

Students with little motivation to engage in academic tasks can also profit from behaviorist techniques. The introduction of extrinsic reinforcers (material, social, or activity reinforcers) contingent on academic accomplishments can be helpful in motivating seemingly “uninterested” students to master essential skills (Cameron, 2001; Covington, 1992; Lepper, 1981).

Students with chronically high levels of anxiety are another group who stand to benefit. Such students often need considerable structure to feel comfortable in the classroom and perform well on academic tasks (Corno et al., 2002; Dowaliby & Schumer, 1973; Helmke, 1989). For instance, they need a classroom environment that specifies expectations for behavior and clearly lays out response–reinforcement contingencies. They also seem to require frequent success experiences and positive feedback. Many methods derived from behaviorist principles address the needs of anxious children especially well: Applied behavior analysis techniques clearly communicate which behaviors will yield reinforcement, instructional objectives spell out desired academic behaviors in concrete terms, and programmed instruction and mastery learning offer regular success and positive feedback.

Finally, there are some individuals for whom little else works. Techniques based on behaviorist principles have been shown to be effective methods of changing even the most resilient of problem behaviors (e.g., Embry, 2002; Greer, 1983; Rimm & Masters, 1974; Webber & Plotts, 2008). Such stubborn conditions as severe childhood autism and serious behavior disorders have been dealt with more successfully by applied behavior analysis than by any other method currently available.

Yet behaviorist approaches are probably not well suited for everyone. Bright students may find the gradual, inch-by-inch approach of programmed instruction slow, tedious, and boring (Lockee et al., 2008). A token economy in a classroom of highly motivated college-bound adolescents may undermine the intrinsic desire of these students to achieve at high levels. Other learning theories, notably cognitive theories, are probably more useful in designing and implementing instruction for these students.

---

## SUMMARY

If we look at typical classrooms from a behaviorist perspective, we realize that reinforcement comes far less frequently than it should (and often only after a considerable delay), and punishment comes all too often. The use of both reinforcement and punishment in classrooms has been subject to other criticisms as well; some reflect a misunderstanding of common behaviorist practices, but others are legitimate.

When certain guidelines are followed, the well-planned, systematic use of reinforcement can be highly effective in improving students' classroom learning and behavior. To maximize reinforcement's effectiveness, desired behaviors should be specified up front, reinforcers should be tailored to individual students, and response–reinforcement contingencies should be explicitly communicated and consistently applied. Meanwhile, inappropriate behaviors can often be reduced through extinction, noncontingent reinforcement, reinforcement of other behaviors, or punishment. A number of strategies enhance punishment's effectiveness; for instance, punishment is more effective when students know in advance what behaviors will be punished and how, when it's administered within the context of a generally warm and supportive environment, and when it's accompanied by reasons why certain behaviors are unacceptable.

*Applied behavior analysis (ABA)* involves the application of behaviorist principles to address serious and chronic behavior problems. Typically it involves concrete specification and measurement of target behaviors, manipulation of antecedent events and consequences in order to change the frequency

of various responses, ongoing monitoring of an intervention to ensure its effectiveness, and specific plans for generalization and phase-out. Such mechanisms as group contingencies, token economies, and schoolwide positive behavior support allow teachers and therapists to use reinforcement effectively even in large-group settings.

*Instructional objectives*, and especially behavioral objectives (which describe educational outcomes in terms of precise, observable responses), are a direct outgrowth of the behaviorist concept of terminal behavior. Objectives facilitate communication among students and teachers; they also help in the selection of appropriate instructional strategies and evaluation techniques. Objectives tend to focus teachers' and students' attention on the information and skills they identify (an advantage) and away from other information and skills (a decided disadvantage if *all* important objectives haven't been identified or aren't being assessed).

*Programmed instruction*, *computer-assisted instruction*, and *mastery learning* incorporate such behaviorist principles as active responding, shaping, and immediate reinforcement. In general, noncomputer-based programmed instruction appears to be no more effective than traditional instructional methods, whereas computer-assisted instruction and mastery learning often lead to better learning. Behaviorist approaches to instruction are probably best used with certain kinds of students (e.g., those with a history of academic failure, low motivation, or high anxiety) rather than as a matter of course with all students.

# SOCIAL COGNITIVE THEORY

### *General Principles of Social Cognitive Theory*

*Environmental Factors in Social Learning: Revisiting Reinforcement and Punishment*

*Problems with a Strict Behaviorist Analysis of Social Learning*

*Cognitive Factors in Social Learning*

*Reciprocal Causation*

*Modeling*

*How Modeling Affects Behavior*

*Characteristics of Effective Models*

*Behaviors That Can Be Learned through Modeling*

*Conditions Necessary for Effective Modeling to Occur*

*Self-Efficacy*

*How Self-Efficacy Affects Behavior and Cognition*  
*Factors in the Development of Self-Efficacy*

*Self-Regulation*

*Elements of Self-Regulation*

*Promoting Self-Regulated Behavior*

*The Cognitive Side of Self-Regulation*

*Educational Implications of Social Cognitive Theory*

*Summary*

One summer my sons Alex and Jeff spent quite a bit of time with their Uncle Pete, a large man who could pick them both up at the same time and carry them around on his shoulders. Uncle Pete's feats of strength were quite a contrast to Mom's and Dad's difficulties in lifting either boy alone, or even in opening pickle jars. For several years after that summer, Alex and Jeff spoke often of wanting to be like Uncle Pete, and I found that I could talk them into eating many foods they had previously shunned simply by saying, "This is what helps Uncle Pete get big and strong." The ploy never did work for broccoli, however.

When my daughter Tina was in junior high school, certain friends often called her before school to find out what she'd be wearing that day. Tina was apparently a bit of a fashion trendsetter at school, and several other girls were mimicking her attire. Given Tina's apparel choices on many occasions, I shuddered at the thought of how her cronies must have looked.

People learn a great deal from observing their fellow human beings. Young boys may emulate hero figures such as Superman, Spiderman, and Uncle Pete. Through watching and copying one another, young adolescent girls may begin to behave in similar ways, dressing alike, wearing their hair in faddish styles, and participating in the same extracurricular activities. Children may imitate their parents by developing similar hobbies and interests, expressing similar political and religious beliefs, and using their parents' disciplinary techniques in raising their own children. And in the classroom, students learn many academic skills—reading, writing, arithmetic, and so on—at least partly through watching and imitating what their teachers and classmates do.

Such learning by observation and modeling is the focus of **social cognitive theory** (e.g., Bandura, 1977, 1986, 2006; T. L. Rosenthal & Zimmerman, 1978). This perspective was initially called *social learning theory* to reflect the fact that a great deal of human learning involves watching and interacting with other people. In its earliest forms, it was based largely on behaviorist principles, but it now includes many cognitivist ideas—hence the gradual shift in label to *social cognitive theory*.<sup>1</sup>

---

<sup>1</sup>In my own experience, I've found that students sometimes misinterpret the term *social learning theory* to mean that it refers primarily to how we acquire social skills. In reality, social learning/cognitive theory can also explain how we learn many nonsocial behaviors (e.g., how to study for a test or how to use weight machines at the gym).

My daughter the trendsetter

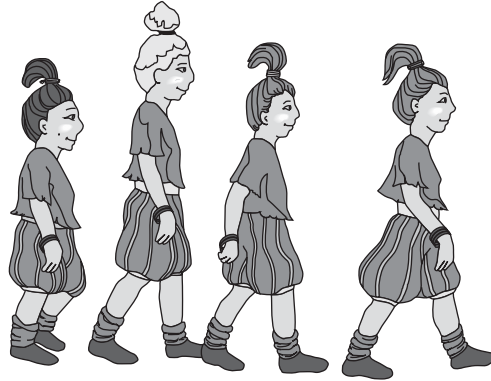

In this chapter, we'll examine social cognitive theorists' views on how environmental and cognitive factors interact to influence human learning and behavior. We'll explore the phenomenon of *modeling*, examining its effects on human behavior and its cognitive underpinnings. We'll find that people's decisions to undertake certain tasks depend, in part, on their *self-efficacy*—their beliefs regarding their ability to complete the tasks successfully. And we'll discover how, through the acquisition of *self-regulation* skills, people increasingly take charge of their own learning and behavior. At the end of the chapter, we'll identify implications of social cognitive theory for educational practice.

## GENERAL PRINCIPLES OF SOCIAL COGNITIVE THEORY

The study of learning through observation and imitation was launched in a 1941 book by behaviorists Neal Miller and John Dollard. In the 1960s a theory of imitation and modeling separate from its behaviorist roots began to take shape, largely through the research and writings of Albert Bandura of Stanford University (e.g., Bandura, 1969, 1973, 1977, 1986, 1989; Bandura & Walters, 1963). You'll find numerous references to Bandura and others who build on his ideas (e.g., Dale Schunk, Barry Zimmerman) throughout the chapter.

Many species of animals can learn by imitation (K. J. Hayes & Hayes, 1952; Herbert & Harsh, 1944; Zentall, 2003). However, social cognitive theory deals primarily with *human* learning, and so we'll be putting research involving laboratory animals aside for the time being. The following general principles underlie social cognitive theory:

- ◆ *People can learn by observing others' behaviors and the consequences that result.* Many early behaviorists viewed learning largely as a matter of trial and error: In any new situation, people try a variety of responses, increasing those that lead to desirable consequences and leaving unproductive ones behind. In contrast, social cognitive theorists propose that most learning takes place not through trial and error but instead through observing both the behaviors of other individuals (**models**) and the outcomes that various behaviors bring about.

- ◆ *Learning can occur without a change in behavior.* As noted in Chapter 3, behaviorists have traditionally defined learning as a change in behavior; from such a perspective, no learning can occur unless behavior *does* change. In contrast, social cognitive theorists argue that because people



can learn through observation alone, their learning won't necessarily be reflected in their actions. Something learned at one time might be reflected in behavior exhibited at the same time, at a later time, or never at all.

- ◆ *Cognition plays important roles in learning.* Over the past few decades, social cognitive theory has become increasingly cognitivist in its explanations of human learning. For example, contemporary social cognitive theorists maintain that *awareness* of response–reinforcement and response–punishment contingencies and *expectations* regarding future contingencies are important factors affecting learning and behavior. Also, as you'll soon see, social cognitive theorists incorporate such cognitive processes as *attention* and *retention* (memory) into their explanations of how learning occurs.

- ◆ *People can have considerable control over their actions and environments.* In behaviorist views of learning, people are largely at the mercy of environmental circumstances—what stimuli are encountered simultaneously (which can lead to classical conditioning), what consequences follow certain responses (which can lead to instrumental conditioning), and so on. In contemporary social cognitive theory, however, people can take active steps to create or modify their environments—perhaps by making changes themselves, or perhaps by convincing others to offer assistance and support—and they often do so consciously and intentionally. As social cognitive theorists put it, human beings have **personal agency** (Bandura, 2006, 2008; Schunk & Pajares, 2005).

## ENVIRONMENTAL FACTORS IN SOCIAL LEARNING: REVISITING REINFORCEMENT AND PUNISHMENT

---

If we were to use principles of instrumental conditioning to explain imitation, we might suggest that people imitate others because they're reinforced for doing so. This is exactly what behaviorists Neal Miller and John Dollard proposed in 1941. According to Miller and Dollard, an individual uses another person's behavior as a discriminative stimulus for an imitative response. The observer is then reinforced in some way for displaying imitation. For example, let's say that a French teacher carefully enunciates:

*Comment allez vous?*      (Discriminative stimulus)

Students repeat the phrase in more or less the same way:

*Comma tally voo?*      (Response)

The teacher then praises them for their efforts:

*Trés bien! Very good!*      (Reinforcement)

Miller and Dollard further proposed that imitative behaviors are maintained by an intermittent reinforcement schedule: Individuals aren't *always* reinforced for mimicking the responses of others, but they're reinforced often enough that they continue to copy those around them. Eventually imitation itself becomes a habit—a phenomenon Miller and Dollard called **generalized imitation**.

Instrumental conditioning continued to be a major component of Albert Bandura's early work as well (e.g., Bandura & Walters, 1963). In the 1970s, however, social cognitive theorists

broadened their view of how the environment might reinforce—and might also occasionally punish—modeling, as reflected in the following ideas:

- ◆ *The observer is reinforced by the model.* In the French-lesson dialogue presented earlier, the model—the teacher—reinforces students for imitative behavior. People often reinforce others who copy what they themselves do. For example, a clique of teenage girls is more likely to welcome a new girl into the group if she dresses as they do. A gang of antisocial boys will probably accept a new member only if he acts in tough, “macho” ways.

Adults in any culture are most likely to reinforce children for copying behaviors that their culture deems to be appropriate. For example, when my children were young, I would occasionally hear one of them use polite, adultlike language on the telephone, perhaps along this line: “I’m sorry, but my mother is busy right now. If you’ll give me your name and number, I’ll have her call you back in a few minutes.” Such a statement was similar to what I myself would tell callers, and I was likely to praise the child profusely. However, a statement such as, “Ma! Telephone! Hurry up and get off the potty!” was definitely *not* learned through observation of the adults in the house, and I certainly never reinforced it.

- ◆ *The observer is reinforced by a third person.* On some occasions a learner is reinforced by a third person rather than by the model. For example, when my youngest child, Jeff, was a toddler, I’d occasionally tell him, “Oh, you’re such a big boy now! You’re getting dressed all by yourself, just like Alex does!”

During the Beatlemania of the 1960s, many teenage boys began sporting “moppet” haircuts like those of the Beatles. Such haircuts were “in,” at least at my high school, and none of us girls would have been caught dead with a boy who had hair shorter than John Lennon’s. My friends and I were, in essence, reinforcing boys who modeled themselves after the Beatles. In earlier days, we might have reinforced anyone who could play the guitar and bat his eyelashes in a come-hither fashion, just as Ricky Nelson used to do in the television sitcom *Ozzie and Harriet*.

- ◆ *The imitated behavior itself leads to reinforcing consequences.* Many behaviors that we learn through observing others produce satisfying (reinforcing) results. For example, a French student who pronounces his *Comment allez vous?* correctly will have greater success communicating with a Parisian. An individual who can closely model a tennis instructor’s body positions and arm movements is more likely to get the ball over the net and into the opponent’s court.

- ◆ *Consequences of the model’s behavior affect the observer’s behavior vicariously.* When people observe a model making a particular response, they may also observe the consequence of the response. If a model is reinforced for a response, the *observer* may show an increase in that response; this phenomenon is known as **vicarious reinforcement**. For example, if Andy sees Adam gain popularity among the girls because he can play the guitar and bat his eyelashes in a come-hither fashion, Andy may very well buy a guitar and take a few guitar lessons; he may also stand in front of the mirror practicing eyelash batting.

The power of vicarious reinforcement (and of **vicarious punishment** as well) was dramatically illustrated in an early study by Bandura (1965b). Children watched a film of a model hitting and kicking an inflated punching doll. One group of children saw the model reinforced for such aggressive behavior, a second group saw the model punished, and a third group saw the model receive no consequences for the aggression. When the children were then placed in a room with the doll, those who had seen the model being reinforced for aggression displayed the most aggressive behavior toward the doll: They’d been vicariously reinforced for aggression. Conversely,

Reinforcement of the model affects the observer's behavior as well.

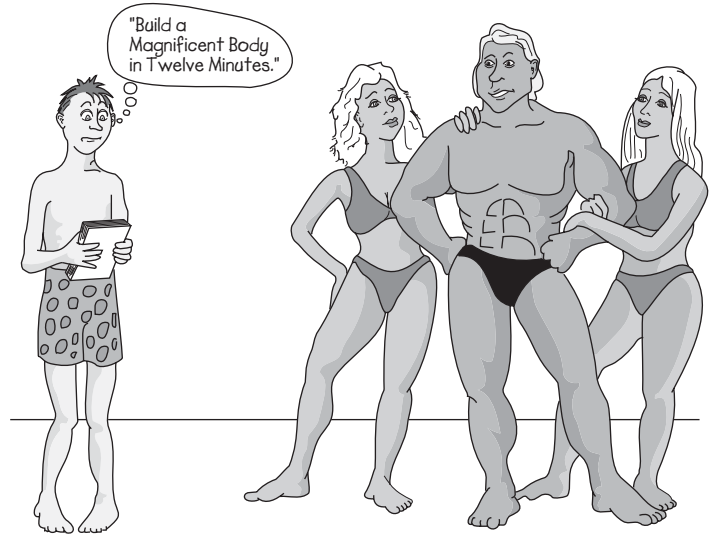

those children who had seen the model punished for aggression were the least aggressive of the three groups: They'd been vicariously punished for such behavior.

### Problems with a Strict Behaviorist Analysis of Social Learning

Although early social learning theorists tried to explain imitative behavior from the perspective of instrumental conditioning, they encountered several difficulties in doing so. One problem is that entirely new behaviors can be acquired simply by watching others perform them (Bandura, 1977, 1986; T. L. Rosenthal, Alford, & Rasp, 1972). In instrumental conditioning, however, new behaviors typically start only from *existing* behaviors that are gradually shaped and modified over time.

A second difficulty is the phenomenon of **delayed imitation**: Some behaviors that are learned through observing others don't appear until a later time. In Chapter 4, we diagrammed the relationship of antecedent stimulus, response, and reinforcement like this:

$$(S+) R \rightarrow S_{Rf}$$

These three things follow one right after the other, with the response occurring in the presence of the discriminative stimulus. Yet as Bandura (1977) has pointed out, the response and resulting reinforcement don't always appear immediately after the discriminative stimulus; instead, they may occur days or weeks later. For such delayed imitation to be possible, learning must actually take place when the discriminative stimulus is presented, despite the absence of reinforcement at that time.

Still a third problem lies in the powerful effect of vicarious reinforcement: Individuals sometimes exhibit behaviors for which they themselves are *never* reinforced.

To address the shortcomings of a strict behaviorist analysis of imitation, social cognitive theorists have suggested that consequences often have *indirect* rather than direct effects on learning (e.g., Bandura, 1977, 1986; T. L. Rosenthal & Zimmerman, 1978). Such effects require that we add cognitive factors to the picture, as we'll do now.

## COGNITIVE FACTORS IN SOCIAL LEARNING

---

The cognitive side of social cognitive theory is evident in several of its central ideas:

- ◆ *Learning involves a mental (rather than behavioral) change.* Social cognitive theorists make a distinction between *learning* through observation (a phenomenon called **vicarious acquisition**) and the actual *performance* of what has been learned (Bandura, 1977, 1986; T. L. Rosenthal & Zimmerman, 1978). In support of this distinction, Bandura has pointed out that people can often verbally describe a behavior they've observed but haven't imitated—hence, they've learned something new even though their own behavior hasn't changed (Bandura, 1965a). Also, people who observe a model perform a behavior may exhibit that behavior only at some later time when they have a reason for doing so. For example, I previously described a study by Bandura (1965b) in which children watched a film of a model acting aggressively toward an inflated punching doll. As you may recall, the consequences of the aggression to the model (reinforcement, punishment, or no consequence) influenced the extent to which children themselves engaged in aggressive acts toward the doll. Later in the study, however, all of the children were promised rewards (stickers and fruit juice) if they could imitate the model's behavior. At that point, differences among the three groups of children disappeared. Clearly they had all *learned* the model's behavior equally well; the consequences to the model apparently affected their earlier performance but not their learning.

- ◆ *Certain cognitive processes are essential for learning to occur.* Social cognitive theorists describe specific mental processes that occur when people are learning from a model. Among these are *paying attention* to what the model is doing, mentally *rehearsing* aspects of the model's performance, and forming mental representations (*memory codes*) of what the model has done. I'll illustrate each of these ideas later in the chapter in the section on modeling.

- ◆ *Learners must be aware of existing response–consequence contingencies.* According to social cognitive theorists, reinforcement and punishment have little effect on learning and behavior unless people have mental *awareness* of the response–reinforcement and response–punishment contingencies that are operating (Bandura, 1977, 1986; Spielberger & DeNike, 1966). Reinforcement increases the likelihood of a response only when a learner realizes which particular response has led to the reinforcement. Similarly, a learner must know what particular behavior is being punished before that behavior is likely to decrease. Consider a situation in which a student receives an F on a writing assignment, with comments such as “Poorly written” and “Disorganized” scribbled in the margins. For many students, such feedback is insufficient to bring about an improvement in writing because, among other things, it doesn't identify the specific parts of the assignment that are poorly written and disorganized.

- ◆ *Learners form expectations for future response–consequence contingencies.* Social cognitive theorists suggest that people are most likely to perform behaviors for which they expect a payoff (i.e., reinforcement). For example, I learned many years ago that the capital of Alaska is Juneau. Yet I've never had a reason to demonstrate this knowledge because I've never been tested on the capital of Alaska, nor have I ever been in Alaska desperately seeking the state capital. Now, of course, I have a reason: I'm hoping you'll be impressed by the fact that I know the capital of at least one of the 50 states.

More generally, when learners are reinforced or punished for certain behaviors, they're likely to form **outcome expectations**—hypotheses about the results that future actions are likely to bring—and behave in ways that will maximize desired consequences (Bandura, 1977, 1986,

1989, 1997; T. L. Rosenthal & Zimmerman, 1978). Learners may also form outcome expectations by seeing *others* reinforced or punished for certain behaviors, and they behave accordingly—a fact that can explain the effectiveness of vicarious reinforcement and punishment.

You should notice a critical difference here between the role of reinforcement in instrumental conditioning and in social cognitive theory. In instrumental conditioning, reinforcement influences learning of the behavior it *follows*. In social cognitive theory, however, an expectation of possible future reinforcement—an **incentive**—influences the learning of a behavior it *precedes* (Bandura, 1977, 1986).

◆ *Learners also form beliefs about their ability to perform various behaviors.* Not only do people form expectations about the likely outcomes of various behaviors but they also form **efficacy expectations**—beliefs about whether *they themselves* can execute particular behaviors successfully (Bandura, 1997; Schunk & Pajares, 2004). For example, imagine yourself in a class in which the instructor has clearly described the criteria for an A. But imagine, too, that you don't believe you have the knowledge and skills to meet the criteria. Even though you know what it takes for a high grade, you don't *have* what it takes (not in your own eyes, at least), and so you can't achieve an A no matter what you do. We'll examine the nature and effects of efficacy expectations, commonly known as *self-efficacy*, later in the chapter.

◆ *Outcome and efficacy expectations influence cognitive processes that underlie learning.* The extent to which learners actively engage in cognitive processes essential for learning (paying attention, forming memory codes, etc.) depends on their beliefs about the likelihood that learning something will lead to reinforcement. For example, I've learned the hard way that when I tell my students they won't be held responsible for certain information, I'm making a BIG MISTAKE. All I have to do is say something like, "Now I want you to listen carefully to what I have to say for the next five minutes, but *it won't be on the next test*," and students put down their pens and settle back in their seats; if I'm teaching an early morning class, a few in the back row may start to nod off. People are less likely to pay attention to something when they don't anticipate a payoff for learning it.

◆ *The nonoccurrence of expected consequences is an influential consequence in and of itself.* In the social cognitive view, the nonoccurrence of expected reinforcement can be punishing and the nonoccurrence of expected punishment can be reinforcing (Bandura, 1977, 1986). Both of these principles involve situations in which outcome expectations aren't being met. For example, once again imagine yourself as a student in a class in which the teacher has described the criteria necessary to earn an A. But this time imagine that you think you *do* have what it takes to get the A. You work hard and meet the specified criteria, but at the last minute your teacher adds an additional requirement: a 20-page research paper. You're probably angry and frustrated—in a sense, you feel punished—because you've expected reinforcement based on work you've already completed and that reinforcement is now being withheld. Unexpected outcomes and *nonoutcomes* often evoke stronger emotional responses than expected ones do (e.g., Mellers, Schwartz, Ho, & Ritov, 1997).

The nonoccurrence of expected consequences can be just as influential when observed for a model rather than for oneself (Bandura, 1973, 1977, 1986). For example, in a study by Walters and Parke (1964), children in three experimental groups watched a film in which a woman told a boy not to play with a number of toys in front of him but instead to read a book she'd given him. Yet as soon as the woman left the room, the boy began to play with the toys. At this point, the film depicted one of three consequences for the boy—that is, for the model—as follows:

1. *Reward.* The woman returned, handed the boy some toys, and played affectionately with him.

2. *Punishment.* The woman returned, snatched away the toys the boy was playing with, shook him vigorously, and sat him back down with the book.
3. *No consequence.* The woman didn't return to the room.

A fourth (control) group didn't see the film. Subsequently each of the children in the study was taken to a room full of toys, told not to touch them, given a book to read, and left alone for 15 minutes. Children in the no-consequence group played with the toys—thus disobeying their instructions—just as much as those in the reward group did. Children in the punishment group were more obedient, but the most obedient children were those in the control group, which hadn't seen a disobedient model at all.

When people see others misbehave without negative consequences, they're more likely to misbehave themselves. For example, when my daughter Tina was in elementary school, she came home almost daily with complaints about who had gotten away with what on the playground that day. If playground supervisors ignore transgressions day after day, their *laissez-faire* attitude not only allows the misbehaviors to continue but may actually cause them to increase. In the same way, I suspect that people who see others quite literally get away with murder may be more likely to engage in criminal activities themselves.

## RECIPROCAL CAUSATION

---

In the preceding sections, we've seen how both the outside environment and a learner's internal mental processes influence behavior. But the influences go in the opposite direction as well: A learner's behaviors can have an impact on subsequent environmental conditions and cognitive processes. Social cognitive theorists argue that people's learning and long-term development involve the interaction of three general sets of variables:

- *Environment (E):* General conditions and immediate stimuli (including reinforcement and punishment) in the outside world
- *Person (P):* An individual's particular physical characteristics (e.g., age, gender, physical attractiveness), cognitive processes (e.g., attention, expectations), and socially and culturally conferred roles and reputations (e.g., king, student, "popular kid," "geek")
- *Behavior (B):* An individual's observable actions and reactions

Each of these three sets of variables influences the other two in a phenomenon known as **reciprocal causation** (Bandura, 1989, 2006, 2008; Schunk & Pajares, 2004; Zimmerman & Schunk, 2003).<sup>2</sup> Social cognitive theorists typically depict reciprocal causation quite simply with a graphic such as this one:

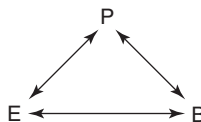

<sup>2</sup>Prior to 1989, Bandura used the term *reciprocal determinism*.

Certainly the environment—for instance, the presentation of reinforcement or punishment— influences a learner's behavior. But a learner's *perception* of the environment (a “person” variable) also affects behavior. For example, people are likely to work harder and more persistently if they *think* they're being reinforced frequently rather than infrequently, regardless of the actual reinforcement schedule they're on (A. Baron, Kaufman, & Stauber, 1969; Kaufman, Baron, & Kopp, 1966). And in the classroom, students are more likely to work hard to master academic subject matter if they *believe* their teachers will give them the support they need to be successful (Bouchey & Harter, 2005).

Meanwhile, behavior affects both the environment and personal variables. The responses people make (e.g., the academic courses they choose, the extracurricular activities they pursue, the company they keep) determine the learning opportunities they have and the consequences they experience (environment). For example, individuals typically behave in ways that increase reinforcement and decrease punishment, and their actions may put them in situations that present new response–reinforcement contingencies.<sup>3</sup> Furthermore, the general quality of their responses over time affects their self-confidence and expectations for future success (person variables). A boy who stumbles and falls frequently may begin to think of himself as a klutz. By consistently performing well on mathematics assignments, a girl may begin to believe she has high aptitude for learning math.

Finally, person variables and environmental variables affect each other. For example, a child who is physically attractive (a person variable) is more likely to elicit favorable reactions from peers (an environmental variable). But the reverse can be true as well: Peers who behave favorably toward a child can enhance the child's self-perception of being a physically or socially attractive individual (Harter, 1996; McCallum & Bracken, 1993).

One prime example of the interplay among environment, person, and behavior variables is modeling, a topic we turn to now.

## MODELING

---

As you discovered in Chapter 2, children begin to imitate other people's facial expressions within a day or two after birth and possibly are genetically prewired with an ability to imitate (recall the discussion of *mirror neurons*). Indeed, human beings in all cultures seem to have both the ability and the inclination to imitate the behaviors of others (S. S. Jones, 1987; Nielsen & Tomaselli, 2010).

Social cognitive theorists suggest that a good deal of our learning comes from observing and modeling what other people do (e.g., Bandura, 1977, 1986). In this section, we'll consider the various ways in which modeling can affect behavior, the types of models that are most likely to influence learning, and the kinds of behaviors that can be modeled. We'll also look at four processes essential for learning to occur through modeling. Before we proceed, however, I should point out that social cognitive theorists sometimes use the term *modeling* to describe what a

---

<sup>3</sup>I've seen a similar idea in behaviorist literature. Rosales-Ruiz and Baer (1997) define the term *behavioral cusp* as “any behavior change that brings the organism's behavior into contact with new contingencies that have even more far-reaching consequences” (p. 533). For example, when infants begin to crawl, they gain greater access to toys, other family members, and potentially hazardous objects. When students begin to read fluently, they open up many new opportunities for learning and instruction.

model does (i.e., demonstrate a behavior) and at other times to describe what the observer does (i.e., mimic that behavior). I've tried to write this section in such a way that the term's meaning is always readily discernible from the context in which I use it.

## How Modeling Affects Behavior

Social cognitive theorists (e.g., Bandura, 1977, 1986; Bandura & Walters, 1963; T. L. Rosenthal & Zimmerman, 1978) have proposed that modeling has several effects:

- ◆ *Modeling teaches new behaviors.* People can learn entirely new behaviors by observing others perform them. For example, by listening to and imitating what someone else says, a person can learn to correctly pronounce a previously unknown word (e.g., although the word *Arkansas* looks a lot like *Kansas*, it's pronounced “**ar**-can-saw,” not “**ar-can**-ziss”). And by watching how a parent swings a bat and following the parent's verbal instructions (“Keep your eye on the ball!”), a child learns to hit a baseball.

- ◆ *Modeling influences the frequency of previously learned behaviors.* As noted earlier, people are more likely to exhibit behaviors they've previously learned if they see others being reinforced for such behaviors; in other words, vicarious reinforcement has a **facilitation** effect. And people are less likely to perform behaviors for which they've seen others being punished; in other words, vicarious punishment has an **inhibition** effect.

- ◆ *Modeling may encourage previously forbidden behaviors.* In some situations, when people observe a model engaging in behavior that has previously been portrayed as forbidden or in some other way wrong—and especially when the model is reinforced for the behavior—they themselves are more likely to exhibit the behavior. On these occasions, vicarious reinforcement has a **disinhibition** effect (because previously inhibited behavior is now reoccurring). For example, in early studies by Walters and his colleagues (R. H. Walters & Thomas, 1963; R. H. Walters, Thomas, & Acker, 1962), adults viewed either a film depicting aggression and violence (*Rebel Without a Cause*) or a neutral film (*Picture Making by Teenagers*) and then were asked to administer “shocks” to other individuals. (These other individuals, who were confederates of the experimenter, didn't really receive any shocks but behaved as if they did.) People who had watched the violent, aggressive film administered more frequent and more intense “shocks” to the confederates. The film had apparently disinhibited previously learned aggressive behavior.

- ◆ *Modeling increases the frequency of similar behaviors.* When a person observes a model performing a particular behavior, the person may display similar rather than identical behavior. For instance, a boy who sees his older brother excel at basketball but lacks his brother's height advantage may instead strive to become a successful soccer player. As a high school student, I would have given my eyeteeth to become a cheerleader—a role that was the ultimate in what was “cool” in those days—but didn't have the gymnastic skills necessary for cheerleading. Instead, I became a majorette in the marching band, a position that was almost as cool.

## Characteristics of Effective Models

Bandura has identified three general types of models. One type, of course, is a **live model**—an actual person demonstrating a particular behavior. But we can also learn from a **symbolic model**—a person or character portrayed in a book, film, television show, videogame, or other



medium. For example, many children model their behavior after football players, rock singers, or such fictional characters as Harry Potter and Hannah Montana. Finally, we can learn from **verbal instructions**—descriptions of how to behave—without another human being, either live or symbolic, being present at all.

Effective models, whether live or symbolic, tend to have one or more characteristics:

- ◆ *The model is competent.* People are more likely to be imitated by others if they're perceived as being competent, capable individuals (Bandura, 1986; Schunk, 1987). For example, a person who's trying to master tennis is more likely to model the techniques of a successful tennis player than those of a friend who seldom gets the ball over the net. And a student who's trying to learn how to write a good term paper is more likely to look at the work of a classmate who has consistently received high rather than low grades on past term papers. Even toddlers and preschoolers have some ability to discriminate between the effective and ineffective behaviors they see modeled, and they're more likely to imitate models who produce desired results (Schulz, Hooppell, & Jenkins, 2008; Want & Harris, 2001).

- ◆ *The model has prestige and power.* Individuals who have high status, respect, and power, either within a small group or within broader society, are more likely to serve as models for others (Bandura, 1986). For instance, a child is more likely to imitate the behaviors of a student leader or a famous rock star than the behaviors of a class dunce or rock-and-roll has-been. In one study (Sasso & Rude, 1987), researchers identified several children who were popular with their peer group and several others who were less popular. They taught these children skills for initiating effective social interactions with peers who had physical disabilities. Later, when other children saw their popular classmates approaching and interacting with children with disabilities, they were likely to do so as well. The prosocial behaviors of unpopular classmates had less of an impact.

- ◆ *The model behaves in stereotypical "gender-appropriate" ways.* Males are more likely to model behavior that's consistent with male stereotypes; similarly, females are more likely to model behaviors that follow traditional female patterns (Leaper & Friedman, 2007; C. L. Martin & Ruble, 2004; Schunk, 1987). For example, in studies in which children watch adult models

**Models are often competent, prestigious, and powerful.**



of both genders being aggressive, boys are more likely than girls to imitate the aggressive behaviors, perhaps, in part, because many people in our society view aggression as being more appropriate for males than for females (Bandura, Ross, & Ross, 1961, 1963; Leaper & Friedman, 2007).<sup>4</sup>

This is *not* to say that youngsters shouldn't see models of both genders, of course. Ideally, children and adolescents should see males and females alike modeling a wide variety of behaviors, including counterstereotypical ones. In doing so, they may begin to realize that most behaviors are truly appropriate for both genders (Bem, 1987; Bussey & Bandura, 1992; Huston, 1983; Weinraub et al., 1984).

◆ *The model's behavior is relevant to the observer's situation.* Learners are more likely to model the behaviors of people they view as similar to themselves in some important way—for instance, people who are of similar age or social status (Braaksma, Rijlaarsdam, & van den Bergh, 2002; Grace, David, & Ryan, 2008; Zimmerman, 2004). They're also more likely to model behaviors that have functional value in their own circumstances (T. L. Rosenthal & Bandura, 1978; Schunk, 1987). For example, as a child my daughter Tina modeled many of my behaviors, but she definitely didn't model the way I dressed. She told me, in so many words, that she'd be laughed out of school if she dressed the way I did.

## Behaviors That Can Be Learned through Modeling

Modeling provides an important mechanism for acquiring a wide variety of psychomotor behaviors, both relatively simple actions (e.g., brushing teeth) and far more complex ones (e.g., dance routines or gymnastics skills) (Boyer, Miltenberger, Batsche, & Fogel, 2009; Poche, McCubbrey, & Munn, 1982; SooHoo, Takemoto, & McCullagh, 2004; Vintere, Hemmes, Brown, & Poulson, 2004). It's almost a means through which people acquire many behaviors with cognitive or emotional components. For example:

- Children acquire new social skills when they watch videos of people effectively using those skills (LeBlanc et al., 2003; Nikopoulos & Keenan, 2004).
- Children are more likely to resist the enticements of a stranger when a peer has modeled techniques for resisting such enticements (Poche, Yoder, & Miltenberger, 1988).
- Children begin to respond emotionally to certain stimuli in the same ways they see others (e.g., parents) react to those stimuli (Mineka & Zinbarg, 2006; Mumme & Fernald, 2003; Repacholi & Meltzoff, 2007).
- Adults are more likely to object to racist statements if people around them refuse to tolerate such statements (Blanchard, Lilly, & Vaughn, 1991).

Considerable research has been conducted concerning the impact of modeling on three kinds of behavior in particular: academic skills, aggression, and interpersonal behaviors.

---

<sup>4</sup>One of the most consistently observed gender differences in human beings is that for physical aggression: On average, males are more physically aggressive than females. Gender stereotypes do not completely explain this difference; hormonal differences (e.g., in testosterone levels) also appear to have an impact (e.g., see Lippa, 2002).

### ***Academic Skills***

Students learn many academic skills by seeing other people demonstrate those skills. For instance, they may learn how to draw, solve long-division problems, or write a cohesive paragraph or story partly by observing how their teachers and peers do these things (Braaksma et al., 2002; Geiger, LeBlanc, Dillon, & Bates, 2010; K. R. Harris, Santangelo, & Graham, 2010; Schunk & Hanson, 1985). Modeling of academic skills can be especially effective when the model demonstrates not only how to *do* but also how to *think about* a task—in other words, when the model engages in **cognitive modeling** (R. J. Sawyer, Graham, & Harris, 1992; Schunk, 1998; Schunk & Swartz, 1993; Zimmerman, 2004). As an example, consider how a teacher might model the thinking processes involved in long division:

First I have to decide what number to divide 4 into. I take 276, start on the left and move toward the right until I have a number the same as or larger than 4. Is 2 larger than 4? No. Is 27 larger than 4? Yes. So my first division will be 4 into 27. Now I need to multiply 4 by a number that will give an answer the same as or slightly smaller than 27. How about 5?  $5 \times 4 = 20$ . No, too small. Let's try 6.  $6 \times 4 = 24$ . Maybe. Let's try 7.  $7 \times 4 = 28$ . No, too large. So 6 is correct. (Schunk, 1998, p. 146)

### ***Aggression***

Numerous research studies have revealed that children and adolescents become more aggressive when they observe aggressive or violent models (Bandura, 1965b; Goldstein, Arnold, Rosenberg, Stowe, & Ortiz, 2001; Guerra, Huesmann, & Spindler, 2003). Young people learn aggression not only from live models but also from the symbolic models they see in films, on television, and in video games (C. A. Anderson et al., 2003; Carnagey, Anderson, & Bartholow, 2007; Wartella, Caplovitz, & Lee, 2004). Even aggressive lyrics in popular music may possibly increase aggression (C. A. Anderson et al., 2003).

In the classic study in this area (Bandura et al., 1961), preschoolers were taken one at a time to a playroom containing a variety of toys and were seated at a table where they could draw pictures. Some of the children then observed an aggressive model: An adult entered the room and engaged in numerous aggressive behaviors toward an inflatable punching doll—for instance, kicking the doll in the air, straddling it and hitting its head with a wooden mallet, and making statements like “Pow!” “Kick him,” and “Punch him in the nose.” Other children instead observed a nonaggressive model: An adult came in and played in a constructive way with building blocks. Still other children saw no model while in the playroom. The children were then led to another room where they were mildly frustrated: Just as they began to play with some very attractive and entertaining toys, the toys were taken away. Finally, the children were taken to a third room that contained both nonaggressive and aggressive toys (including the inflatable punching doll and wooden mallet); their behaviors were recorded and coded for aggressive content by observers on the other side of a one-way mirror. Children who had seen the aggressive model were the most aggressive of the three groups, and in fact they mimicked many of the same behaviors that they had seen the aggressive model display. Children who had seen a nonaggressive model were even less aggressive than the no-model group. With regard to aggression, then, models can have an impact either way: Aggressive models lead to increased aggression in children, and nonaggressive models lead to decreased aggression.

### ***Interpersonal Behaviors***

Learners acquire many interpersonal skills by observing and imitating others. For example, in small groups with classmates, children may adopt one another's strategies for conducting discussions about literature, perhaps learning how to solicit one another's opinions (“What do you

think, Jalisha?”), express agreement or disagreement (“I agree with Kordell because . . .”), and justify a point of view (“I think it shouldn’t be allowed, because . . .”) (R. C. Anderson et al., 2001, pp. 14, 16, 25). And children with mild or moderate forms of an autism spectrum disorder are apt to play more effectively with age-mates after watching a videotape of a nondisabled peer using good social skills in play activities (Nikopoulos & Keenan, 2004).

Learners can also acquire generosity and other forms of altruism in part through observation and modeling (R. Elliott & Vasta, 1970; Jordan, 2003; Radke-Yarrow, Zahn-Waxler, & Chapman, 1983; Rushton, 1980, 1982). In one study (Rushton, 1980), children observed a model playing a bowling game and reinforcing himself with tokens for high performance. Some children saw the model donate half of the earned tokens to an economically disadvantaged boy named Bobby pictured on a poster in the room; other children observed the model keep all of his winnings for himself despite their awareness of Bobby. After that, the children had the opportunity to play the game and reward themselves with tokens. The more tokens they earned, the better prize they could purchase. They could make a donation to Bobby, but doing so meant lesser purchasing power for themselves. Children who had watched generous models were more likely to donate some of their tokens to Bobby than were children who had watched selfish models. This difference was observed not only in the initial experimental session but also in a follow-up session two months later.

Models in the media can have an impact as well. Rather than encouraging aggression, some characters in popular media promote prosocial behaviors—those aimed at helping others rather than at enhancing one’s personal well-being (D. R. Anderson, 2003; Huston, Watkins, & Kunkel, 1989; Jordan, 2003; Rushton, 1980). For example, in a study by Friedrich and Stein (1973), a group of preschool children watched *Mister Rogers’ Neighborhood*—a popular television show that stressed such prosocial behaviors as cooperation, sympathy, and sharing—for 30 minutes each day over a 4-week period. These children displayed more socially appropriate behavior and less aggression than children who instead watched shows with aggressive content (e.g., *Batman* and *Superman*) during the same period.

What about situations in which a model preaches one set of behaviors and practices another? A review of research by Bryan (1975) leads to a clear conclusion: When children hear a model say one thing and do something else, they’re more likely to imitate what the model *does* than what the model *says*. To be effective, then, models must practice what they preach.

## Conditions Necessary for Effective Modeling to Occur

Bandura (1977, 1986) has suggested that four conditions are necessary before an individual can successfully model the behavior of someone else: attention, retention, motor reproduction, and motivation.

### **Attention**

To imitate a behavior accurately, a person must first pay attention to the model and especially to the significant aspects of the modeled behavior. For example, if Martha wants to learn how to swing a golf club, she should watch how the golf pro stands, how her legs are placed, how she holds the club, and so on. Paying attention to irrelevant parts of the model or her behavior—how the pro annoyingly clears her throat or how her socks don’t quite match—certainly won’t be helpful.

I still remember my first French teacher, a woman who came to my fifth-grade class for an hour one day each week. This woman always wore the same dark green wool dress, which, unfortunately, turned to a turquoise color in places where she perspired. I recall focusing on those turquoise spots, fascinated that a wool dress could actually change color so dramatically just because of a little human sweat. Yes, I was paying attention to my model, but, no, I didn't learn much French, because I didn't pay attention to what was most important—her voice.

### **Retention**

After paying attention, the learner must also remember the behavior that's been observed. One simple way to remember what one has seen, at least for the short run, is **rehearsal**—repeating whatever needs to be remembered over and over (Vintere, Hemmes, Brown, & Poulson, 2004; Weiss & Klint, 1987). For instance, in a study by Vintere and colleagues (2004), an adult modeled a variety of multistep dance moves for 3- to 5-year-old dance students. The children learned the moves more quickly when they were instructed to repeat the various steps to themselves while performing them. For example, when executing a “butterfly,” they would say to themselves, “Slide, jump, slide, jump, run, and stop.” Meanwhile, a “cupcake” was easier when they told themselves, “Step, step, jump, one, two, three” (p. 309).

According to Bandura, people store both verbal representations (such as step-by-step instructions or labels that describe the actions to be performed) and visual images of the behaviors they've seen. These verbal and visual **memory codes** serve as guides when people perform the observed behavior, whether they perform it immediately after the model has demonstrated it or at some future time. As an illustration of such memory codes, my son Jeff's swimming teacher used the words *chicken*, *airplane*, and *soldier* to describe the three arm movements of the elementary backstroke (see Figure 6.1). The words provided Jeff with verbal codes for these actions; the teacher's demonstration of them presumably facilitated the formation of visual images.

Learning from a model is often easier if learners have assistance in forming memory codes for behaviors they observe (e.g., Bandura, Jeffery, & Bachicha, 1974; Coates & Hartup, 1969; R. L. Cohen, 1989; Vintere et al., 2004). For example, in a study by Gerst (1971), college students studied a number of hand signs in sign language for the deaf. Students who

**Figure 6.1**

People often remember a model's behaviors more easily when those behaviors have verbal labels.

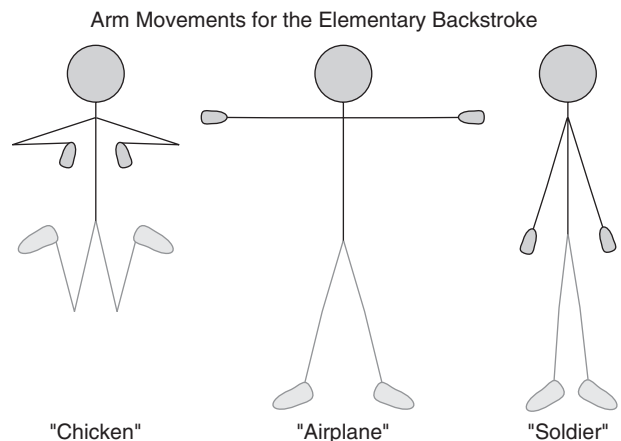

were instructed either to describe the signs verbally or to form mental images of them remembered the signs more successfully than an uninstructed control group; students who were instructed to develop verbal labels descriptive of the hand movements remembered the signs most accurately.

Cognitive theorists have studied effective means of remembering information far more extensively than social cognitive theorists have. Thus, we'll examine this topic in greater depth in Chapters 9 and 10.

### **Motor Reproduction**

A third condition necessary for successful modeling is, of course, actual replication of the behavior that a model has demonstrated. When an individual can't reproduce an observed behavior—perhaps because of physical immaturity, insufficient strength, or disability—this third condition obviously can't be met. For example, a child with articulation difficulties may never be able to pronounce *sassafras* correctly, no matter how many times she hears the word spoken. And a toddler who watches his teenage brother throw a football doesn't have the muscular coordination to mimic the throw.

In my never-ending battle with the bulge, I used to turn on Jane Fonda's physical workout videotape religiously every night (well, at least twice a month). Jane performed exercises in various pretzel-like contortions that I, even in my wildest dreams, would never be able to execute. My body wasn't built to be folded in that many ways. Motor reproduction of everything I watched Model Jane do simply wasn't possible.

Not only must learners have the *ability* to perform an observed behavior, but ideally they should have an *opportunity* to perform it at the same time they observe it (e.g., Hayne, Barr, & Herbert, 2003). Reproduction of an observed behavior as it's being observed facilitates learning for at least two reasons. For one thing, it enables learners to encode the behavior not only in verbal and visual forms but perhaps in a *motoric* form as well—that is, in terms of the specific actions it encompasses (R. L. Cohen, 1989). Furthermore, by modeling a behavior in the presence of the model, learners can get feedback about how to improve their performance. For instance, when children who have historically struggled with math are learning division, instruction that includes an opportunity for practice and immediate feedback about the quality of performance is

Modeling can't occur without the physical capability.



clearly superior to instruction that provides no opportunity for such practice and feedback (Bandura, 1977; Schunk, 1981; Shute, 2008).<sup>5</sup>

### **Motivation**

The final necessary condition for successful modeling is motivation: Learners must want to demonstrate what they've learned. For instance, many people who've grown up in our society have seen models in the media stick a gun in someone's ribs and say "Reach for the sky" or something to that effect. Fortunately, very few people are motivated to model that behavior, at least with a real gun.

Although parents and teachers are often models for children, children don't model *all* of the behaviors they observe their parents and teachers performing. For example, although my children modeled my ways of speaking to people on the telephone and my cookie-baking techniques, for some reason they never seemed to copy my broccoli-cooking or floor-scrubbing behaviors. Children model behaviors only when they have a reason—a motive—to do so.

To review, Bandura's four essential conditions for successful modeling are attention, retention, motor reproduction, and motivation. Because these conditions vary from person to person, different learners will model the same behavior differently. For example, Martha and Mary might pay attention to different aspects of their tennis instructor's tennis swing: Martha may focus on how the instructor is standing, whereas Mary may attend more to the way the instructor grips her racket. Or the two girls might store different visual images of the swing, Martha remembering that the instructor was facing the net and Mary remembering her standing with the left shoulder toward the net. Martha may be stronger, but Mary may be more motivated to play tennis well. The end result is that Martha and Mary will model the same tennis swing differently. Not only will the four essential conditions for modeling lead to individual differences in modeled behaviors, but also the absence of any one of them will make modeling unlikely to occur at all.

One important aspect of the fourth condition—motivation—is self-efficacy, and in this respect learners are often *very* different from one another. We now zoom in on this concept.

## **SELF-EFFICACY**

---

Learners are more likely to engage in certain behaviors when they believe they're capable of executing the behaviors successfully—that is, when they have high **self-efficacy** (Bandura, 1982, 1989, 2006; Schunk & Pajares, 2004). For example, I hope you believe you're capable of understanding and remembering the ideas I present in this book; in other words, I hope you have high self-efficacy for learning about learning. You may or may not believe that with instruction and practice you'll eventually be able to perform a passable swan dive; in other words, you may have high or low self-efficacy about learning to dive. You're probably quite skeptical that you could ever walk barefoot over hot coals, resulting in low self-efficacy regarding this activity.

At first glance, the concept of self-efficacy may seem similar to such notions as self-concept and self-esteem, but there's an important difference. In general, one's *self-concept* addresses the

---

<sup>5</sup>Note, however, that some children may prefer to practice newly learned behaviors in private before showing an adult what they've learned. For example, this may be the case for many Native American children (Castagno & Brayboy, 2008; Suina & Smolkin, 1994).

question “*Who am I?*” and *self-esteem* addresses the question “*How good am I as a person?*”<sup>6</sup> Both are typically characterized as pervading a wide variety of activities; thus, people are described as having generally high or low self-concepts and self-esteem. In contrast, *self-efficacy* addresses the question “*How well can I do such-and-such?*” In other words, it refers to learners’ beliefs about their competence in a specific activity or domain. For instance, people may have high self-efficacy about learning to perform a swan dive but low self-efficacy about swimming the entire length of a swimming pool underwater. They may have higher self-efficacy about learning in social studies than in mathematics (Stodolsky, Salk, & Glaessner, 1991). In recent years, self-efficacy has figured more prominently in theories of learning and motivation than have self-concept and self-esteem, in part because researchers have defined it more consistently and in part because it’s often more predictive of learners’ performance (Bong & Clark, 1999; Bong & Skaalvik, 2003).

## How Self-Efficacy Affects Behavior and Cognition

According to social cognitive theorists, people’s feelings of self-efficacy affect several aspects of their behavior, including their choices of activities, their goals, their effort and persistence, and ultimately their learning and achievement (e.g., Bandura, 1997, 2000; Pajares, 2009; Schunk & Pajares, 2005; Zimmerman, 1998).

**Choices of activities** People tend to choose tasks and activities at which they believe they can succeed; they tend to avoid those at which they think they’ll fail. For example, students who believe they can succeed at mathematics are more likely to take math courses than students who believe they’re mathematically incompetent (Eccles, Wigfield, & Schiefele, 1998). Similarly, those who believe they can win a role in the school play are more likely to try out for the play than students with little faith in their acting or singing abilities.

**Goals** People set higher goals for themselves when they have high self-efficacy in a particular domain. For instance, adolescents’ career goals and occupational levels reflect subject areas in which they have high rather than low self-efficacy. Their goals are often consistent with traditional gender stereotypes: Boys are more likely to have high self-efficacy for, and so aspire to careers in, science and technology, whereas girls are more likely to feel efficacious about, and so choose, careers in education, health, and social services (Bandura, Barbaranelli, Caprara, & Pastorelli, 2001).

**Effort and persistence** People with a high sense of self-efficacy are more likely to exert effort when they work at a task, and they’re more likely to persist when they encounter obstacles. People with low self-efficacy about a task put less effort into it and give up more quickly in the face of difficulty.

Self-efficacy seems to be most predictive of effort and persistence when people haven’t yet entirely mastered a new topic or skill—in other words, when they must still struggle to some extent (Schunk & Pajares, 2004). Once they’ve achieved mastery, there often is no *need* to exert effort, because completion of a task comes quickly and easily.

---

<sup>6</sup>I urge you not to agonize over the difference between *self-concept* and *self-esteem*, because their meanings overlap quite a bit, and so they’re often used interchangeably (Byrne, 2002; Harter, 1999; O’Mara, Marsh, Craven, & Debus, 2006).



**Learning and achievement** Not only do people with high self-efficacy try harder and persist longer but they also employ more effective study skills and are better able to delay gratification when their immediate efforts don't pay off. As a result, people with high self-efficacy tend to learn and achieve more than those with low self-efficacy, even when initial ability levels are the same. In other words, when several learners have equal ability, those who *believe* they can do a task are more likely to complete it successfully than those who don't believe they're capable of success (Bembenutty & Karabenick, 2004; Schunk & Pajares, 2005; Valentine, DuBois, & Cooper, 2004; Zimmerman & Kitsantas, 2005). Self-efficacy is an especially important factor for adolescent and adult learners, who typically have more independence in learning tasks than young children do and therefore must to some degree be self-starters (Davis-Kean et al., 2008; Schunk & Pajares, 2005).

Ideally, learners should have a reasonably accurate sense of what they can and cannot accomplish, putting them in a good position to capitalize on their strengths and address their weaknesses (Försterling & Morgenstern, 2002; J. Wang & Lin, 2005). Yet a tad of overconfidence can be beneficial, in that it entices learners to take on challenging activities that will help them develop new skills and abilities (Assor & Connell, 1992; Bandura, 1997; Pajares, 2009). Within this context, it's often useful to distinguish between **self-efficacy for learning** ("I can learn this if I put my mind to it") and **self-efficacy for performance** ("I already know how to do this"). Self-efficacy for learning—for what one can *eventually* do with effort—should be on the optimistic side, whereas self-efficacy for performance should be more in line with current ability levels (Lodewyk & Winne, 2005; Schunk & Pajares, 2004; Zimmerman & Kitsantas, 2005).

Learners are at a disadvantage when they underestimate their abilities. In such circumstances, they set low goals for themselves and give up easily in the face of small obstacles. But it's also possible to have too much of a good thing. When learners are *too* overconfident, they may set themselves up for failure by forming unrealistically high expectations or exerting insufficient effort to succeed. And they'll hardly be inclined to address weaknesses they don't realize they have (Bandura, 1997; Stevenson, Chen, & Uttal, 1990; Zimmerman & Moylan, 2009).

## Factors in the Development of Self-Efficacy

Social cognitive theorists have found that several factors affect the development of self-efficacy, including one's own previous successes and failures, one's current emotional state, the messages that others communicate, the successes and failures of others, and the successes and failures of one's group as a whole.

### **Previous Successes and Failures**

Without a doubt, the most important factor affecting learners' self-efficacy is their own history of successes and failures with a particular task or domain (J. Chen & Morris, 2008; Schunk & Pajares, 2005; Usher & Pajares, 2008; T. Williams & Williams, 2010). A student is more likely to believe he can learn to divide fractions if he has successfully mastered the process of multiplying fractions. Similarly, a student will be more confident about her ability to play field hockey or rugby if she has already developed skills in soccer. In some cases, learners' judgments of success are based on the progress they make over time. In other instances, their judgments are based on how well they perform in comparison with peers (R. Butler, 1998a; Pajares, 2009; Schunk & Zimmerman, 1997).

Once people have developed a high sense of self-efficacy, an occasional failure isn't likely to dampen their optimism very much. In fact, when historically successful people encounter small

setbacks on the way to achieving success, they learn that sustained effort and perseverance are key ingredients for that success; in other words, they develop **resilient self-efficacy** (Bandura, 1989, 2008). However, when people meet with *consistent* failure in a particular domain, they tend to have little confidence in their ability to succeed in that domain in the future. Each new failure confirms what they already “know”: They have little or no aptitude for mastering that subject area. For example, students with learning disabilities—students who typically have encountered failure after failure in classroom activities—often have low self-efficacy with regard to the things they study in school (R. M. Klassen & Lynch, 2007; Lackaye & Margalit, 2006).

### ***Current Emotional State***

As we’ll discover in Chapter 16, emotions are often intimately involved in people’s learning and motivation. For now we should simply note that learners’ current emotional states—for instance, their general mood and the extent to which they feel anxious or stressed—can significantly affect their self-efficacy for the task at hand. For example, a student who feels excessively anxious or agitated during an important academic task may interpret that feeling as a sign of low ability for the task, even if the source of the feeling is actually *unrelated* to the task (Bandura, 1997; Ciani, Easter, Summers, & Posada, 2009; Schunk & Pajares, 2005). The resulting low self-efficacy will, of course, undermine the student’s performance, perhaps to the point that the task itself subsequently evokes anxiety and stress.

### ***Messages from Others***

To some extent, learners’ self-efficacy beliefs are enhanced when other people praise good performance or provide assurances that success is possible. At school, statements such as “You can do this problem if you work at it” or “I’ll bet Judy will play with you if you just ask her” do give students a slight boost in self-confidence. The boost is short-lived, however, unless students’ efforts ultimately do meet with success (Schunk, 1989a; Schunk & Pajares, 2005).

We should note, too, that the messages learners receive are sometimes implied rather than directly stated, yet they can influence self-efficacy nonetheless. For example, by giving constructive criticism about how to improve a poorly written research paper—criticism that indirectly communicates the message that “I know you can do better, and here are some suggestions how”—a teacher can boost students’ self-efficacy for writing research papers (Hattie & Timperley, 2007; Pintrich & Schunk, 2002; Tunstall & Gipps, 1996). In some cases, actions speak louder than words. For example, the teacher who provides a great deal of assistance to a struggling student—more assistance than the student really needs—is communicating the message that “I don’t think you can do this on your own” (Schunk, 1989b).

### ***Successes and Failures of Others***

People often acquire information about their self-efficacy for a new task or domain by observing the successes and failures of individuals similar to themselves (J. Chen & Morris, 2008; Dijkstra, Kuyper, van der Werf, Buunk, & van der Zee, 2008; Schunk & Pajares, 2005). For instance, students often consider the successes and failures of their peers—especially those perceived to have similar ability—when appraising their own chances of success on academic tasks. Thus, seeing a classmate model a behavior successfully is sometimes more effective than seeing a teacher do it. As an illustration, in one study (Schunk & Hanson, 1985), elementary school children having difficulty with subtraction were given 25 subtraction problems to complete. Those who had seen another student successfully complete the problems got an average of 19 correct,

whereas those who saw a teacher complete the problems got only 13 correct, and those who saw no model at all solved only 8.

Curiously, it's sometimes better to watch a peer model who struggles with a task at first and then gradually masters it, rather than one who executes it perfectly on the first shot (Kitsantas, Zimmerman, & Cleary, 2000; Schunk, Hanson, & Cox, 1987; Zimmerman & Kitsantas, 2002). Presumably observing such a **coping model** shows learners that success doesn't necessarily come easily—that they must work and practice to achieve success—and allows them to observe the strategies the model uses to gain proficiency.

### ***Successes and Failures of the Group as a Whole***

People may have greater self-efficacy when they work in a group than when they work alone, and especially when they achieve success as a group. Such **collective self-efficacy** is a function not only of people's perceptions of their own and others' capabilities but also of their perceptions of how effectively they can work together and coordinate their roles and responsibilities (Bandura, 1997, 2000; Klassen & Usher, 2010).

To date, research on collective self-efficacy has focused largely on adults. For instance, when teachers at a school believe that, as a group, they can make a significant difference in the lives of their students, they influence students' achievement in several ways:

- The teachers are more willing to experiment with new ideas and teaching strategies that can better help students learn.
- They have higher expectations and set higher goals for students' performance.
- They put more effort into their teaching and are more persistent in helping students learn (Bandura, 1997; Roeser, Marachi, & Gehlbach, 2002; Skaalvik & Skaalvik, 2008; Tschannen-Moran, Woolfolk Hoy, & Hoy, 1998).

These effects should look familiar: Just as self-efficacy affects learners' choices of activities, goals, effort, and persistence, so, too, does it affect *teachers'* choices, goals, effort, and persistence. And probably as a result of these effects, the teachers' students have higher self-efficacy for learning and actually *do* achieve at higher levels (Goddard, 2001; Goddard, Hoy, & Woolfolk Hoy, 2000; Roeser et al., 2002; Tschannen-Moran et al., 1998).

We can reasonably assume that children, too, are likely to have higher self-efficacy when they work in groups, provided that their groups are functioning smoothly and effectively (more on this point in Chapter 13). Yet children must also acquire skills for independent learning and performance. Social cognitive theorists believe that growing learners can and should ultimately take charge of their own behavior. We therefore turn to a topic gaining increasing prominence in psychological and educational literature—the topic of *self-regulation*.

## **SELF-REGULATION**

---

As social cognitive theory has evolved over the years, it has increasingly emphasized the role of **self-regulation** in human behavior (Bandura, 1977, 1982, 1986; Zimmerman, 1989; Zimmerman & Schunk, 2004). Through both direct and vicarious reinforcement and punishment, growing children gradually learn which behaviors are and are not acceptable to the people around them. Eventually, they develop their *own* ideas about appropriate and inappropriate behavior, and they choose their actions accordingly. And in doing so, they gain an increasing sense of personal

agency—increasing confidence that they can have considerable control over the course of their lives (Bandura, 2008).

Social cognitive theorists are hardly the only ones who have considered the nature of self-regulation; behaviorists have addressed it (e.g., Belfiore & Hornyak, 1998), as have many cognitive and developmental theorists (e.g., see the discussion of Vygotsky's theory in Chapter 13). Yet, to a considerable degree, social cognitive theorists have been the ones responsible for laying the groundwork on which other theorists have built. In this section, we'll blend elements of behaviorism and cognitivism to explore the nature of self-regulated behavior.

## Elements of Self-Regulation

From the perspective of social cognitive theorists, effective self-regulation entails several processes: setting standards and goals, self-observation, self-evaluation, self-reaction, and self-reflection (Bandura, 1986, 2008; Schunk, 1989c, 1998; Zimmerman & Schunk, 2004).

**Setting standards and goals** Mature human beings tend to set standards for their own behavior; in other words, they establish criteria regarding what constitutes acceptable performance. They also identify certain goals that they value and toward which they direct many of their behaviors. People's specific standards and goals depend to some degree on the standards and goals they see other individuals adopt (Bandura, 1986, 2008; Fitzsimmons & Finkel, 2010). In other words, the behavior of *models* affects learners' standards and goals. For example, in a study by Bandura and Kupers (1964), children watched adult or child models reward themselves with candy and self-praise for their performance in a bowling game. Some of the children watched the models reward themselves only after achieving 20 points or more (reflecting very high performance); these models admonished themselves for anything up to 19 points. Other children observed models reward themselves after achieving as few as 10 points. All of the children then had the opportunity to play the game themselves and to help themselves to candy whenever they chose. Bandura and Kupers found that the children tended to reinforce themselves using performance standards very similar to those they'd seen the models use.

**Self-observation** An important part of self-regulation is to observe oneself in action. To make progress toward important goals, people must be aware of how well they're doing at present; in other words, they must know what parts of their performance are working well and what parts need improvement.

**Self-evaluation** People's behaviors are frequently judged by others—for instance, by relatives, teachers, classmates, friends, and the general public. Eventually, people begin to judge and evaluate their *own* behaviors based on the standards they hold for themselves.

**Self-reaction** As people become increasingly self-regulating, they begin to reinforce themselves—perhaps by feeling proud or telling themselves they did a good job—when they accomplish their goals. They also begin to punish themselves—perhaps by feeling sorry, guilty, or ashamed—when they do something that doesn't meet their self-chosen performance standards. Such self-praise and self-criticism can be as influential in altering behavior as the reinforcements and punishments that others administer (Bandura, 1977, 1986, 2008).

To illustrate, consider Jason, a student who perceives himself to have average intelligence. Jason is likely to form standards for his own academic achievement that match the achievement of other seemingly average-ability students; he is therefore likely to pat himself on the back for

B-level work and to maintain a similar level of effort on future tasks. In contrast, consider Joanna, a student whose close friends are the high achievers of the class. If Joanna believes that her ability is similar to that of her friends, she's likely to adopt high standards for herself and to admonish herself for the same B-level achievement of which Jason is so proud. Provided that the B doesn't appreciably undermine her self-efficacy, Joanna is likely to try harder on the same task the next time around (Bandura, 1989).

**Self-reflection** Finally, truly self-regulating learners reflect on and critically examine their goals, past successes and failures, and beliefs about their abilities, and they make any adjustments to goals, behaviors, and beliefs that seem warranted. In Bandura's view, such critical self-reflection is the most distinctly human aspect of self-regulation (Bandura, 2008). Self-reflection is a key ingredient in *metacognition*, a topic we'll explore in depth in Chapter 14.

## Promoting Self-Regulated Behavior

Writing a textbook is a major undertaking. As I sit here in my office tapping on my computer keyboard day after day, I sometimes wonder why in the world I ever committed myself to such a project when I could instead be in my warm, comfortable living room reading mystery novels or watching television game shows. Yet each day I go to my office to write a few more pages. How do I do it? I do it by reinforcing myself every time I finish a small section of the book. For example, as soon as I finished the section on self-efficacy you just read, I gave myself permission to go watch my favorite game show. But before I can go to the gym to play racquetball (a game I really enjoy), I need to finish this section on self-regulation.

Psychologists have identified several techniques for promoting self-regulated behavior. These techniques (sometimes called *self-control* or *self-management*) include self-instructions, self-monitoring, self-reinforcement, and self-imposed stimulus control.<sup>7</sup>

The author engages in self-regulation.

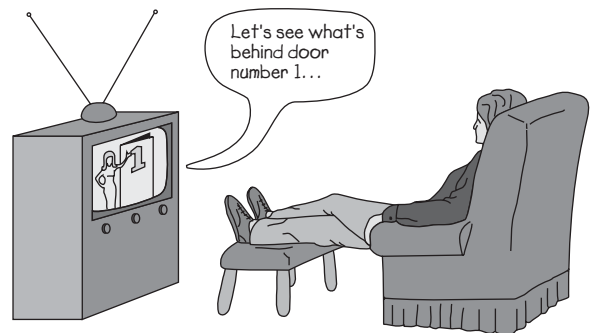

<sup>7</sup>Some theorists make a distinction between the terms *self-control* and *self-regulation*. For instance, Diaz, Neal, and Amaya-Williams (1990) define self-control as complying with someone else's standards for appropriate behavior even when the latter individual is absent, whereas self-regulation involves setting one's own standards for appropriate behavior. Schunk and Zimmerman (1997; Kitsantas et al., 2000; Zimmerman & Kitsantas, 1999) suggest that self-control is heavily dependent on comparing one's own performance with internal standards that have been acquired from a model's performance, whereas true self-regulation is more automatic and flexible, allowing adaptation to changing circumstances.

### ***Self-Instructions***

One effective strategy is to teach learners to repeat **self-instructions** that guide their behavior (Mace, Belfiore, & Shea, 1989; Meichenbaum, 1985; Schunk, 1989c). For instance, earlier in the chapter, I described a study in which preschoolers more easily learned new dance moves by reminding themselves about specific response sequences (e.g., “slide, jump, slide, jump, run, and stop”) (Vintere et al., 2004, p. 309). Similarly, beginning tennis students improve the accuracy of their returns when they give themselves these four verbal cues (Ziegler, 1987):

- “Ball” (to remind them to keep their eyes on the ball)
- “Bounce” (to continue tracking the path of the ball)
- “Hit” (to focus on contacting the ball with the racket)
- “Ready” (to get into position for the next ball) (Ziegler, 1987)

Other studies show self-instructions to be effective in helping students acquire more effective approaches to academic tasks, develop better social skills, and keep their impulsive and aggressive behavior in check (Alberto & Troutman, 2009; Guevremont, Osnes, & Stokes, 1988; Hughes, 1988; Leon & Pepe, 1983; Webber & Plotts, 2008).

Meichenbaum (1977) has successfully used five steps to teach children how to give themselves instructions to guide their behavior:

1. *Cognitive modeling*: An adult model performs the desired task while verbalizing instructions that guide performance.
2. *Overt, external guidance*: The child performs the task while listening to the adult verbalize the instructions.
3. *Overt self-guidance*: The child repeats the instructions aloud while performing the task.
4. *Faded, overt self-guidance*: The child whispers the instructions while performing the task.
5. *Covert self-instruction*: The child silently thinks about the instructions while performing the task.

This sequence is graphically depicted in Figure 6.2. As you can see, the adult initially serves as a model not only for the behavior itself but also for self-instructions. Responsibility for performing the task *and* for guiding that performance is gradually turned over to the child.

### ***Self-Monitoring***

Another method that can help people control their own behavior is simply to have them observe and assess their own responses—**self-monitoring**—just as someone else might assess those responses in applied behavior analysis (see Chapter 5). The mere recording of responses is often enough to alter the frequency of a behavior. For example, my family was once part of a research project in which randomly selected households recorded their television-watching habits over a period of several weeks. We were instructed to record every instance of television viewing, including the date, time of day, length of time, and programs watched. Each time I thought about turning on the television set, I remembered all the work I’d have to go through to record my viewing, and, as often as not, I found something else to do instead. Thus, the simple process of having to record my television-watching behavior altered that behavior.

Self-monitoring can be instituted in a classroom setting as well. For example, in one study (K. R. Harris, 1986), students having difficulty keeping their minds on their spelling assignments were given tape recorders that emitted a small beep at random intervals about 45 seconds apart.

	<b>Task Performance</b>	<b>Task Instructions</b>
<b>Step 1: Cognitive modeling</b>	The adult performs and models the desired behavior.	The adult verbalizes instructions.
<b>Step 2: Overt, external guidance</b>	The child performs the desired behavior.	The adult verbalizes instructions.
<b>Step 3: Overt self-guidance</b>	The child performs the desired behavior.	The child repeats the instructions aloud.
<b>Step 4: Faded, overt self-guidance</b>	The child performs the desired behavior.	The child whispers the instructions.
<b>Step 5: Covert self-instruction</b>	The child performs the desired behavior.	The child thinks silently about the instructions.

**Figure 6.2**  
Meichenbaum's five steps for promoting self-regulated behavior

Whenever students heard a beep, they asked themselves, “Was I paying attention?” This simple technique doubled their time on task and tripled their productivity on spelling assignments. Many other studies have obtained similar results in terms of increased on-task behavior and assignment completion (Mace, Belfiore, & Hutchinson, 2001; Reid, Trout, & Schartz, 2005; Webber, Scheuermann, McCall, & Coleman, 1993).

Just as desirable behaviors can be increased, undesirable behaviors can be *decreased* through self-monitoring. For example, self-recording of a target behavior has been found to reduce such disruptive classroom behaviors as talking out of turn, refusing to comply with teacher instructions, and acting aggressively toward classmates. Through self-monitoring, learners become more consciously aware of how frequently they engage in certain unproductive behaviors, and such awareness can be a key factor in behavior improvement (Bear, Torgerson, & Dubois-Gerchak, 2010; DuPaul & Hoff, 1998; Mace et al., 1989; Webber et al., 1993).

### ***Self-Reinforcement***

People can often change their behavior through **self-reinforcement**, giving themselves a treat or special privilege when they behave in a desired fashion and withholding reinforcement when they don't (Mace et al., 2001; Reid et al., 2005). For example, I'm able to maintain my book-writing behavior by applying the Premack principle described in Chapter 4: I let myself engage in easy, enjoyable activities only after I've completed more difficult ones.

When students learn to reinforce themselves for their accomplishments—perhaps by giving themselves some free time, helping themselves to a small treat, or simply praising themselves—their study habits and academic performance improve (Greiner & Karoly, 1976; S. C. Hayes et al., 1985; Reid et al., 2005). For example, in one study (Stevenson & Fantuzzo, 1986), students who had been performing poorly in arithmetic were taught to give themselves points when they did well on assignments, and they could later use the points to “purchase” a variety of items and privileges. Within a few weeks, these students were doing as well as their classmates on both in-class assignments and homework.

### ***Self-Imposed Stimulus Control***

As you should recall from our discussion of instrumental conditioning in Chapter 4, a response is under stimulus control when it's emitted in the presence of some stimuli but not in the presence of others. This idea can be translated into an effective means of promoting self-regulation (Mahoney & Thoresen, 1974); I call it **self-imposed stimulus control**. To increase a particular desired behavior, an individual might be instructed to seek out an environment in which that behavior is most likely to occur. For example, a student who wishes to increase the time actually spent studying each day should sit at a table in the library rather than on a bed at home. Conversely, to decrease an undesired behavior, an individual should engage in that behavior only in certain situations. For example, in an effort to stop smoking, a psychologist I once knew gradually reduced the number of locations in which he allowed himself to smoke. Eventually, he was able to smoke in only one place: facing a back corner of his office. At that point, he successfully stopped smoking.

We should note here that techniques designed to promote self-regulation work only when learners are neurologically capable of inhibiting inappropriate behaviors (see Chapter 2) and only when they're motivated to change their behavior. Under such circumstances, such techniques can help learners discover that they have some control, not only over their behavior but over their environment as well. Three precautions must be taken, however. First, people being trained in self-regulation strategies must have the capability for performing the desired behaviors; for example, students who want to modify their study habits will achieve higher grades only if they have adequate academic skills to ensure success. Second, people must *believe* they can make the necessary behavior changes; in other words, they must have high self-efficacy (Pajares, 2009; Schunk, 1998; Zimmerman & Schunk, 2004). And third, people must be cautioned not to expect too much of themselves too quickly. Many individuals would prefer overnight success, but shaping—whether of oneself or of another—is usually a slow, gradual process. Just as the dieter won't lose 40 pounds in one week, it's equally unlikely that a habitually poor student will achieve honor-roll status immediately. For self-regulation techniques to be effective, one's expectations for oneself must be practical and realistic.

## **The Cognitive Side of Self-Regulation**

We've seen numerous indications that self-regulation involves cognitive processes as well as behavior. As a concrete example, in Meichenbaum's final step for teaching self-instructions (see Figure 6.2), the learner doesn't verbalize, but merely *thinks* about, the instructions a model has provided. More generally, such elements of self-regulation as setting standards for performance, self-evaluation, and self-reaction (e.g., feeling proud or ashamed) are probably more cognitive than behavioral in nature.

In recent years, psychologists have applied the concept of self-regulation more explicitly to the control of one's mental processes; in particular, they now talk about *self-regulated learning* as well as self-regulated behavior. For example, self-regulating learners set goals for a learning activity, choose study strategies that are likely to help them accomplish the goals, monitor their progress toward the goals, and change their study strategies when necessary. We'll talk more about self-regulated learning when we discuss metacognition and study strategies in Chapter 14, where we'll draw from the work of both cognitive and social cognitive theorists.



## EDUCATIONAL IMPLICATIONS OF SOCIAL COGNITIVE THEORY \_\_\_\_\_

By focusing on and modifying environmental factors that influence learning, behaviorists and social cognitive theorists alike give cause for optimism about helping learners of all ages acquire more advanced academic skills and more appropriate classroom behaviors. But social cognitive theory adds an important concept to the mix: reciprocal causation. By choosing and appropriately adjusting teaching practices and other aspects of the classroom environment, educators can improve students' behaviors, which in turn can enhance students' self-efficacy and other personal characteristics, which can then support students' self-regulating behaviors, which then enable students to benefit more from their classroom experiences—and so on and so on, in an ongoing interaction among environment, behavior, and personal variables.

Social cognitive theory also has numerous, more specific implications for classroom practice. Following are some of the most important ones:

- ◆ *Students often learn a great deal simply by observing others.* According to many traditional behaviorists (e.g., B. F. Skinner), people must make active responses for learning to occur. But in this chapter, we've seen many examples of how learning can also occur through observations of what other people do. Furthermore, students may learn what behaviors are and aren't acceptable through their vicarious experiences—more specifically, by seeing others receive reinforcement or punishment for various responses. Accordingly, teachers and other school personnel must be consistent in the rewards and punishments they administer—not only from time to time but also from student to student. In fact, students can be quite resentful of teachers who apply different behavioral standards with different students (Babad, Avni-Babad, & Rosenthal, 2003; J. Baker, 1999; Certo, Cauley, & Chafin, 2003).

- ◆ *Describing the consequences of behaviors can effectively increase appropriate behaviors and decrease inappropriate ones.* As you should recall, social cognitive theorists propose that reinforcement and punishment affect behavior only when learners are consciously aware of response-consequence contingencies. Thus, promises of rewards for good behaviors and warnings of unpleasant consequences for misdeeds can be effective means of improving student behavior. In contrast, administering reinforcement or punishment when students don't recognize the relationship between an action and its consequence is unlikely to bring about behavior change.

- ◆ *Modeling provides an alternative to shaping for teaching new behaviors.* Behaviorists describe one effective means for teaching a new response: shaping. But to shape a new behavior, one must begin by reinforcing an existing behavior and then gradually modify it through successive approximations to the desired terminal behavior; for complex behaviors and skills, this process can be quite time consuming. Social cognitive theory offers a faster, more efficient means for teaching new behavior: modeling.

To promote effective learning from a model, a teacher must make sure that four essential conditions exist: attention, retention, motor reproduction, and motivation. First of all, the teacher must ensure that students pay attention to the model and especially to the relevant aspects of the model's behavior. Second, the teacher can facilitate students' retention of what they observe by helping them form appropriate memory codes (perhaps verbal labels or visual images) for their observations. Third, giving students opportunities to practice the behaviors they see and providing corrective feedback about their efforts will aid their motor reproduction of the responses they're modeling. Finally, the teacher must remember that students will display behaviors they've learned only if they're motivated to do so. Many children may be intrinsically

motivated to perform new skills, but others may require external incentives and reinforcers. (We'll consider numerous motivational strategies, with a particular focus on those that foster intrinsic motivation, in Chapters 16 and 17.)

♦ *Teachers, parents, and other adults must model appropriate behaviors and take care not to model inappropriate ones.* Adults often possess characteristics (e.g., competence, prestige, power) that make them influential models for children. Accordingly, they must be careful that they model appropriate behaviors for the children with whom they interact. I'm delighted when I see teachers and other adults show characteristics such as open-mindedness, empathy, and concern for physical fitness. I cringe when I see them express disdain for particular points of view, disregard the needs and concerns of other human beings, or smoke cigarettes.

A child I know once tried out for a role in a school Christmas pageant. Lisa went off to school on the morning of pageant tryouts, aware that students could each try out for only one part and thinking that she had a good chance of winning the role of Mrs. Claus. Lisa was convinced that the teacher would award the leading role of Santa Claus to a girl named Ann; however, because Ann was late that morning and the teacher had announced that latecomers wouldn't be allowed to try out, Lisa instead tried out for Santa himself. When Ann arrived 10 minutes late, the teacher disregarded her rule about latecomers being ineligible, allowed Ann to try out for Santa Claus, and ultimately gave her the role. In doing so, this teacher—one of the school's most visible role models—modeled hypocrisy and favoritism.

As an educational psychologist who helps future teachers learn how to teach, my job is a particularly challenging one because I must practice what I preach. If I tell students that immediate feedback, organization of information, vivid examples, hands-on experiences, and assessment practices that match instructional objectives are all important components of effective teaching, my students' learning will obviously be enhanced if I model all those things as well. To say one thing but do another would be not only hypocritical but also counterproductive.

Through their daily interactions with students, teachers model not only behaviors but attitudes as well (Pugh, 2002; Rahm & Downey, 2002). For example, in a unit on adaptation and evolution in his high school zoology class, science teacher Kevin Pugh (2002) consistently modeled enthusiasm for science through statements such as these:

- “What we want to do this week is learn more about how every animal is truly an amazing design. Because every animal . . . is designed to survive and thrive in a particular environment. And when you learn how to see animals in terms of how they're adapted to their environment, every animal becomes an amazing creation” (p. 1108).
- “While driving here, I passed a bunch of Canada geese and I started to think, I began to wonder, ‘Why do they have a black head and white neck? What's the adaptive purpose?’” (p. 1110).

♦ *Exposure to a variety of other models further enhances students' learning.* Adult models need not be limited to children's teachers and parents. Other adults can be invited to visit classrooms on occasion; for example, police officers, prominent city officials, businesspeople, and nurses might demonstrate appropriate behaviors and attitudes related to safety, good citizenship, responsibility, and health. Symbolic models can also be effective; for example, studying the lives of such individuals as Helen Keller, Martin Luther King, Jr., and Eleanor Roosevelt provides a simple yet effective method of illustrating many desirable behaviors (Ellenwood & Ryan, 1991; Nucci, 2001).

Models don't simply demonstrate appropriate behaviors. Carefully chosen ones can also help break down traditional stereotypes regarding what different groups of people can and cannot do. For example, teachers might introduce students to male nurses, female engineers, African American physicians, Hispanic business executives, or athletes who are wheelchair bound. By exposing students to successful individuals of both genders, from many cultural and socioeconomic backgrounds, and with a variety of disabilities, teachers can help students realize that they themselves may also have the potential to accomplish great things.

◆ *Students must believe they are capable of accomplishing school tasks.* As we've seen, students' self-efficacy affects their learning and academic achievement. Yet students are apt to differ widely in their self-confidence in various academic domains. For example, in adolescence, boys are likely to have higher self-efficacy than girls with regard to mathematics, science, and sports; meanwhile, girls are likely to have higher self-efficacy than boys for assignments in an English class (Dunning, Johnson, Ehrlinger, & Kruger, 2003; Schunk & Pajares, 2005; Wigfield, Eccles, & Pintrich, 1996).

To enhance students' self-efficacy related to school activities, teachers can make use of the factors that seem to promote self-efficacy. For instance, teachers can tell students that peers very similar to themselves have mastered the things they're studying. Teachers might also have students actually observe their peers successfully accomplishing tasks; it can be especially beneficial for students to see a peer struggling with a task or problem at first—something they themselves are likely to do—and then eventually mastering it (recall the concept of *coping model*). In addition, teachers can plan group activities in which students collaborate on challenging assignments. But most importantly, teachers can foster high self-efficacy by helping students achieve classroom success themselves—for example, by helping them master essential basic skills and providing guidance and support for tackling more advanced, difficult ones.

Changing students' self-efficacy one task or skill at a time is ultimately easier than trying to change their overall self-concepts or self-esteem (Bong & Skaalvik, 2003). Yet when students develop high self-efficacy regarding a number of different topics and subject areas, they increasingly gain confidence that, in general, they can master new domains. In other words, they may eventually develop a **generalized self-efficacy** that applies broadly to many areas of the school curriculum (Bong & Skaalvik, 2003; Schunk & Pajares, 2004).

◆ *Teachers should help students set realistic expectations for their accomplishments.* As growing children become increasingly self-regulating, they begin to adopt standards for their own behavior. Such standards are often based on those that people around them have adopted, and so they may in some cases be either overly optimistic or unnecessarily pessimistic. When a student's standards for performance are unrealistically high—as might be true for a perfectionist—continual disappointment and frustration are likely to result (F. A. Dixon, Dungan, & Young, 2003; Pajares, 2009; Zimmerman & Moylan, 2009). When a student's standards are quite low, underachievement will be the outcome. Teachers can best facilitate students' academic and social progress by helping them form optimistic self-expectations that are also reasonable given current ability levels and available instruction and support.

◆ *Self-regulation techniques provide effective methods for improving student behavior.* Earlier in the chapter, I described four techniques for promoting self-regulation: self-instructions, self-monitoring, self-reinforcement, and self-imposed stimulus control. When students are intrinsically motivated to change their own behaviors, such techniques can provide a viable alternative to behaviorist approaches.

As social cognitive theorists have so clearly shown, we can't ignore the social context of the classroom. Students can and do learn from the models—the parents, teachers, and peers—that they see every day. Social cognitive theorists have also made it clear that we must consider cognitive as well as environmental factors when trying to explain how human beings learn and behave. As we move into cognitivist perspectives in the next chapter, we'll begin to look at such factors more closely.

---

## SUMMARY

Social cognitive theory focuses on the ways in which people learn from observing one another. This perspective reflects a blending of behaviorist concepts (e.g., reinforcement and punishment) and cognitive notions (e.g., awareness and expectations regarding response–consequence contingencies, memory codes). Environmental and cognitive variables continually interact with one another and with behavior, such that each influences the others in reciprocal ways.

Many behaviors, beliefs, and attitudes are acquired through *modeling*; academic skills, aggression, and interpersonal behaviors are three examples. Effective models are likely to be competent, prestigious, and powerful and to exhibit behaviors that are perceived to be “gender-appropriate” and relevant to the observer's own situation. Four conditions are necessary for modeling to occur: attention, retention, motor reproduction, and motivation.

Individuals with high *self-efficacy*—those who believe they can perform successfully in particular activities or domains—are more likely to choose challenging activities, exert effort and persist at those activities, and exhibit high levels of achievement over the long run. Self-efficacy can be enhanced through encouraging messages, others' (especially peers') successes, group accomplishments, and, most importantly, one's own, personal successes.

Social cognitive theorists propose that although the environment influences behavior, over time people begin to regulate their own behavior; people

do so by developing their own standards for performance, observing and evaluating themselves on the basis of those standards, reinforcing or punishing themselves (even if only mentally and emotionally) for what they have or haven't done, and ultimately self-reflecting on their past performance and current goals and beliefs. Teachers can help their students become more self-regulating by teaching such techniques as self-instructions, self-monitoring, self-reinforcement, and self-imposed stimulus control.

Social cognitive theory offers numerous implications for educational practice. For example, describing response–reinforcement and response–punishment contingencies makes students aware of those contingencies; hence, such descriptions are likely to affect behavior before any consequences are ever imposed. When instruction involves teaching new skills, modeling provides an effective and potentially more efficient alternative to traditional behaviorist techniques. Modeling isn't restricted to planned instruction, however: Teachers and other adults model a variety of behaviors, attitudes, and values in their daily interactions with students, and so they must be careful that their behaviors reflect fairness, acceptance of diverse viewpoints, a healthy lifestyle, and high ethical standards. And when teaching potentially challenging subject matter, teachers must give students good reason to believe that they're truly capable of mastering that subject matter.

# INTRODUCTION TO COGNITIVISM

*Edward Tolman's Purposive Behaviorism*

*Gestalt Psychology*

*Verbal Learning Research*

*Introduction to Contemporary Cognitivism*

*General Assumptions of Cognitive Theories*

*Information Processing Theory*

*Constructivism*

*Contextual Theories*

*Integrating Cognitive Perspectives*

*General Educational Implications of Cognitive Theories*

*Summary*

Since the 1960s, cognitive psychology—also known as *cognitivism*—has been the predominant perspective within which learning research has been conducted and theories of learning have evolved. As we begin our exploration of this perspective, you'll undoubtedly notice a change in emphasis. In earlier chapters, we focused largely on the roles of environmental conditions (stimuli) and observable behaviors (responses) in learning, although social cognitive theory also provided a window into such mental phenomena as expectations, attention, and self-efficacy. At this point, we'll begin to look more directly at **cognitive processes**, considering how people perceive, interpret, remember, and in other ways think about environmental events.

As you should recall, most early behaviorists intentionally omitted internal mental events from their learning theories, arguing that such events were impossible to observe and measure and thus couldn't be studied objectively. During the 1950s and 1960s, however, many psychologists became increasingly dissatisfied with such a "thoughtless" approach to human learning. Major works with a distinctly cognitive flavor began to emerge; publications by Bruner, Goodnow, and Austin (1956) in concept learning and by Noam Chomsky (1957) in psycholinguistics are examples. Ulric Neisser's *Cognitive Psychology*, published in 1967, was a landmark book that helped to legitimize cognitive theory as a major alternative to behaviorism (Calfée, 1981). Increasingly, cognitivism began appearing in educational psychology literature as well, with Jerome Bruner (1961a, 1961b, 1966) and David Ausubel (1963, 1968; Ausubel & Robinson, 1969) being two well-known early proponents. By the 1970s, the great majority of learning theorists had joined the cognitive bandwagon (Robins, Gosling, & Craik, 1999).

Yet the roots of cognitive psychology preceded the mass discontentment with strict S-R psychology by many years. Some cognitive learning theories, notably those of American psychologist Edward Tolman and the Gestalt psychologists of Germany, appeared in the early decades of the twentieth century. At about the same time, two developmental psychologists, Jean Piaget in Switzerland and Lev Vygotsky in Russia, described how children's thought processes change with age and speculated about underlying learning mechanisms that might make such change possible.

Equally important to the cognitive movement was research conducted in the early and middle decades of the twentieth century in an area known as *verbal learning*. Verbal learning theorists originally tried to apply a stimulus-response analysis to human language and verbal behavior but soon discovered that the complexities of language-based learning were sometimes hard to explain from a strict behaviorist perspective. Increasingly, verbal learning theorists began to incorporate cognitive processes into their explanations of research results.

In this chapter, we'll consider the contributions of Tolman, Gestalt psychology, and early verbal learning research and then get a brief overview of contemporary cognitivism. We'll look more closely at contemporary cognitivist theories and research findings in Chapters 8 through 11. We'll take a developmental approach to cognition in Chapters 12 and 13, where we'll look at Piaget's and Vygotsky's early work and at recent perspectives that have built on their ideas.

## EDWARD TOLMAN'S PURPOSIVE BEHAVIORISM

Edward Chace Tolman (1932, 1938, 1942, 1959) was a prominent learning theorist during the heyday of behaviorism, yet his work had a distinctly cognitive flair. Like his behaviorist contemporaries, Tolman valued the importance of objectivity in research and used nonhuman species (especially rats) as the subjects of his research. Unlike his contemporaries, however, Tolman included internal mental phenomena in his explanations of how learning occurs. Following are examples of his ideas:

- ◆ *Learning is an internal rather than external change.* Tolman proposed that learning is an internal process that isn't necessarily reflected in an organism's behavior. As an example, let's look at a study by Tolman and Honzik (1930) in which three groups of rats ran a difficult maze under different reinforcement conditions. Group 1 rats were reinforced with food each time they completed the maze. Group 2 rats received no reinforcement for successful performance. Group 3 rats weren't reinforced during the first 10 days in the maze but began receiving reinforcement on Day 11.

The results of the experiment appear in Figure 7.1; the data points indicate the average numbers of wrong turns (errors) the three groups made while traveling the maze each day. Notice that the performance of Groups 2 and 3 improved somewhat (i.e., they made fewer wrong turns)

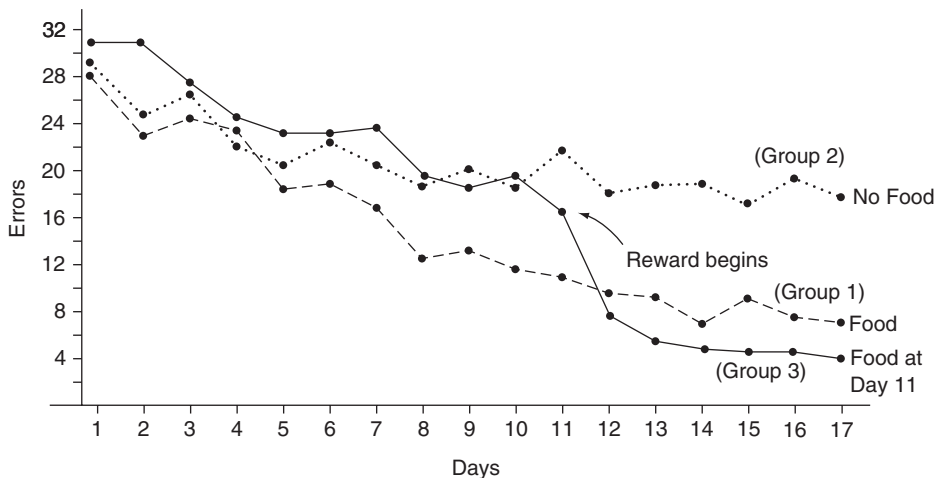

**Figure 7.1**

Maze performance of rats receiving food, no food, or food beginning on Day 11

Adapted from "Introduction and Removal of Reward, and Maze Performance in Rats" by E. C. Tolman and C. H. Honzik, 1930, *University of California Publications in Psychology*, 4, p. 267. Copyright © 1930 by University of California Press. Adapted with permission.

even when they weren't receiving reinforcement. Notice, too, that once the rats in Group 3 began receiving reinforcement on Day 11, their performance in the maze equaled (in fact, it surpassed!) Group 1's performance. Apparently, Group 3 rats had learned as much as Group 1 rats during the first 10 days even though the two groups had been performing differently. Tolman used the term **latent learning** for such unobservable learning. In Tolman's view, reinforcement influences *performance* rather than learning, in that it increases the likelihood that a learned behavior will be exhibited. (As you may recall from Chapter 6, social cognitive theorists have reached a similar conclusion.)

- ◆ *Behavior is purposive.* Tolman believed that learning should be viewed not as the formation of S–R connections but as a process of learning that certain events lead to other events (e.g., that following a particular path through a maze leads to reinforcement). He proposed that once an organism has learned that a behavior leads to a certain end result, the organism behaves in order to achieve that result. In other words, behavior has a *purpose*, that of goal attainment. Because Tolman stressed the goal-directed nature of behavior, his theory of learning is sometimes called **purposive behaviorism**.

- ◆ *Expectations affect behavior.* According to Tolman, once an organism learns that certain behaviors produce certain kinds of results, it begins to form expectations about the outcomes of its behaviors. Rather than reinforcement affecting the response that it follows, the organism's *expectation* of reinforcement affects the response that it *precedes*. (Once again we see a similarity with social cognitive theory.)

When an organism's expectations aren't met, its behavior can be adversely affected. For example, in an experiment by Elliott (described in Tolman, 1932), rats received one of two different reinforcers for running a maze: An experimental group received a favorite rat delicacy—bran mash—whereas a control group received relatively unenticing sunflower seeds. The experimental group ran the maze faster than the control group, apparently because the experimental-group rats were expecting a yum-mier treat at the end of the maze. On the tenth day, the experimental-group rats were switched to the sunflower seed reinforcement that the control group rats had been getting all along. After discovering the change in reinforcement, these rats began to move through the maze more slowly than they had previously—even more slowly than the control-group rats. Because both groups were being reinforced identically at this point (i.e., with sunflower seeds), the experimental group's inferior performance was apparently due to the change in reinforcement, resulting in the *depression effect* described in Chapter 4.

- ◆ *Learning results in an organized body of information.* Rats who run a maze appear to learn not only the appropriate responses to make at each junction but also the general arrangement of the maze—the lay of the land, so to speak. For example, in a classic study by Tolman, Ritchie, and Kalish (1946), rats ran numerous times through a maze that looked like Maze 1 of Figure 7.2. They were then put in a situation similar to Maze 2 of Figure 7.2. Because the alley that had previously led to food was now blocked, the rats had to choose among 18 other alleys. Applying the behaviorist concept of generalization, we would expect the rats to respond to a stimulus very similar to the blocked alley—perhaps Alley 9 or Alley 10. Yet few rats chose either of these routes. By far the most common choice was Alley 6, the one that presumably would provide a shortcut to the location in which the rats had come to expect food.

Based on such research, Tolman proposed that rats (and presumably many other species as well) develop **cognitive maps** of their environments: They learn where different parts of the environment are situated in relation to one another. Knowing how things are organized in space

**Figure 7.2**  
Mazes used by Tolman,  
Ritchie, and Kalish  
(1946)

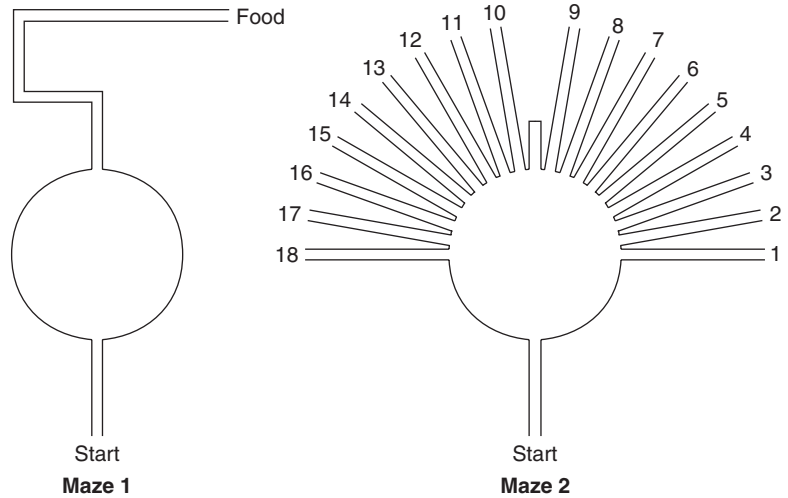

enables an organism to get from one place to another quickly and easily, often by the shortest possible route. Cognitive maps (sometimes called *mental maps*) have continued to be a topic of research for more contemporary researchers, psychologists and geographers alike (e.g., Downs & Stea, 1977; Foo, Warren, Duchon, & Tarr, 2005; García-Mira & Real, 2005; Salomon, 1979/1994).

In his research methods, Tolman was clearly influenced by behaviorists. But in developing his views about the organized nature of what organisms learn, Tolman was influenced by the ideas of the Gestalt psychologists of Germany, which we turn to now.

## GESTALT PSYCHOLOGY

In the early decades of the twentieth century, German psychologists developed a view of learning and cognition that was quite different from the behaviorist theories dominating American psychology at the time (e.g., Koffka, 1935; Köhler, 1925, 1929, 1947, 1959; Wertheimer, 1912, 1959). This perspective, known as **Gestalt psychology**, emphasized the importance of organizational processes in perception, learning, and problem solving. Following are several basic ideas to emerge from Gestalt psychology:

- ◆ *Perception is often different from reality.* The origin of Gestalt psychology is usually attributed to Wertheimer's (1912) description and analysis of an optical illusion known as the **phi phenomenon**. Wertheimer observed that when two lights blink on and off sequentially at a particular rate, they often appear to be only one light moving quickly back and forth. (You can see this effect in the blinking lights of many roadside signs.) The fact that an individual "sees" motion when observing stationary objects led Wertheimer to conclude that perception of an experience is sometimes different from the experience itself.

- ◆ *The whole is more than the sum of its parts.* Gestaltists believed that human experience can't be successfully understood if various aspects of experience are studied as separate, isolated entities. For example, we perceive the illusion of movement in the phi phenomenon only when two or more lights are present; we don't perceive motion in a single light. Similarly, we hear a particular sequence of musical notes as "Jingle Bells" and recognize this tune even when the key



changes, thus changing the specific notes being played (Rachlin, 1995). A combination of stimuli may show a pattern not evident in any of the stimuli alone; to use a Gestaltist expression, the whole is more than the sum of its parts.

The importance of interrelationships among stimuli can be seen in Köhler’s (1929) **transposition** experiments with chickens. Hens were shown two sheets of gray paper, one a bit darker than the other. Grain was placed on both sheets, but the hens were able to feed only on the darker one. On a subsequent occasion, the hens were shown a sheet of paper the same shade as that on which they had previously been fed, along with a sheet of an even darker shade. In this second situation, the hens tended to go to the darker of the two sheets—in other words, to the one on which they had *not* previously been reinforced. The hens had apparently learned something about the relationship between the two sheets of paper: Darker is better.

♦ *An organism structures and organizes experience.* Roughly translated, the German word *Gestalt* means “structured whole.” Structure isn’t necessarily inherent in a situation; instead, an organism *imposes* structure. For example, if you look at Figure 7.3a, you probably perceive three pairs of lines with single lines at each end. Yet turn your attention to Figure 7.3b, in which the same lines appear within a particular context. You probably now see the lines differently—as four pairs forming the sides of four rectangles. The vertical lines are identical in both cases, but the way in which you organize them—that is, how you group the lines together—is different. The structure of the lines is something you impose on each figure.

♦ *An organism is predisposed to organize experience in certain ways.* Gestaltists suggested that organisms (especially human beings) are predisposed to structure their experiences in similar, predictable ways. One dominant principle affecting how people organize information is the **law of proximity**: People tend to perceive as a unit those things that are close together in space. For example, look at the following dots:



Not only do you see nine dots but you probably also perceive an arrangement of three groups of three dots each. That is, you see those dots in close proximity to one another as somehow belonging together. In the same way, when you looked at Figure 7.3a, you perceived lines that were close together as forming pairs. And notice how you read and interpret the letter sequence ONEVERYHIGHWAY differently depending on whether they’re grouped this way:

ONE VERY HIGH WAY

or this way:

ON EVERY HIGHWAY

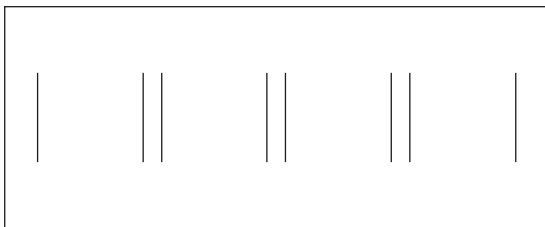

Figure 7.3a

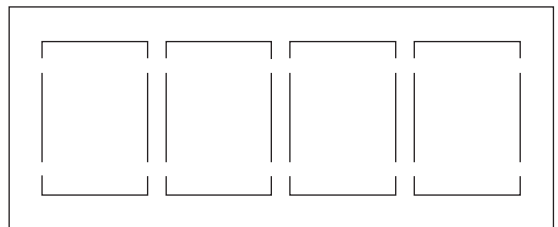
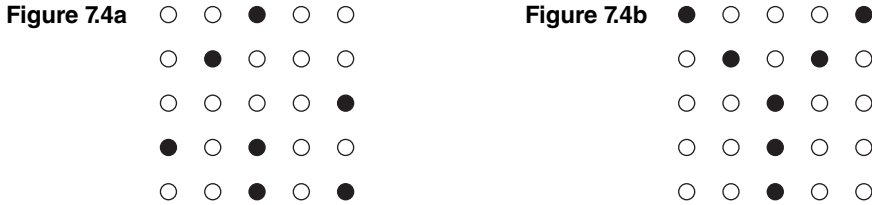

Figure 7.3b



Another organizational principle is the **law of similarity**: People tend to perceive as a unit those things that physically resemble one another. For example, look at the dots in Figure 7.4a. Can you see the letter Y among them? Perhaps not. But if you look at the dots in Figure 7.4b, a letter Y is obvious. The arrangement of the dots is the same in both cases, but in the second case the dots forming the Y are all black, and you tend to perceive those similar black dots as a unit. Yet you probably haven't noticed other letters, such as E or H, that are also formed by some of the dots. As early as 6 or 7 months of age, children show evidence that they perceive the world in accordance with the law of similarity (Quinn, Bhatt, Brush, Grimes, & Sharpnack, 2002).

Still another Gestaltist principle is the **law of closure**: People tend to fill in missing pieces to form a complete picture. For example, when you looked at Figure 7.3b, you filled in missing segments of what appeared to be continuous straight lines to perceive four rectangles. Similarly, when you look at Figure 7.5, you probably see “Singing in the rain,” even though 50% of the print is missing. You simply fill in what isn't there.

In the Gestaltist view, individuals always organize their experience as simply, concisely, symmetrically, and completely as possible—a principle known as the **law of Prägnanz** (i.e., “terseness” or “preciseness”) (Koffka, 1935). For example, you perceive rectangles in Figure 7.3b because rectangles are simple, symmetric figures. It's unlikely that you would mentally fill in the missing pieces in a wild and crazy fashion such as that shown in Figure 7.6. The “KISS” principle that many successful product designers advocate (“Keep it simple, stupid!”) is a modern-day adaptation of this law of Prägnanz.

♦ *Learning follows the law of Prägnanz.* Gestalt psychologists proposed that learning involves the formation of **memory traces**.<sup>1</sup> These memory traces are subject to the law of Prägnanz, so that over time they tend to become simpler, more concise, and more complete than the actual input. For example, after seeing the somewhat irregular objects in Figure 7.7, people are likely to remember them later as being a “circle” and a “square.” As another example, consider a study by Tversky (1981), in which people studied maps and then drew them from memory. Distortions in people's reproductions often followed the law of Prägnanz: Curvy, irregular lines were straightened, slanted lines were represented as north–south or east–west lines, and map features were placed in better alignment with one another than they had been in the original maps.

**Figure 7.5** 

<sup>1</sup>Many contemporary cognitive psychologists and neuropsychologists also use this term in their discussions of memory (e.g., Brainerd & Reyna, 2004; Suárez, Smal, & Delorenzi, 2010).

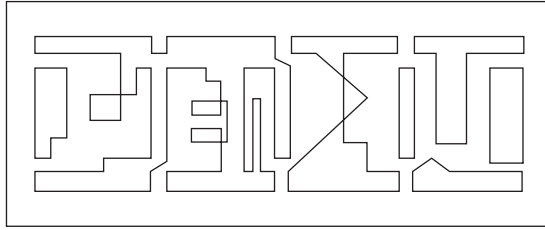
**Figure 7.6**

◆ *Problem solving involves restructuring and insight.* As noted in Chapter 4, the early American behaviorist Edward Thorndike (1898) proposed that problem solving involves a process of trial and error (recall his research involving cats in a puzzle box). In contrast, Gestaltists proposed a more cognitive view of how organisms solve problems. For example, after observing chimpanzees tackling a variety of problems, Wolfgang Köhler (1925) suggested that problem solving involves mentally combining and recombining various elements of a problem and eventually creating an organizational structure that solves the problem. In one situation, a chimp named Sultan faced a problem in which fruit was placed far enough outside his cage that he couldn't reach it. Sultan had had earlier experiences in which he had used sticks to rake in fruit; in this case, however, the only stick inside the cage was too short. A longer stick was outside the cage but, like the fruit, was beyond Sultan's reach. The following scenario ensued:

Sultan tries to reach the fruit with the smaller of the two sticks. Not succeeding, he tears at a piece of wire that projects from the netting of his cage, but that, too, in vain. Then he gazes about him (there are always in the course of these tests some long pauses during which the animals scrutinize the whole visible area). He suddenly picks up the little stick, once more goes up to the bars, directly opposite to the long stick, scratches it towards him with the [short stick], seizes it, and goes with it to the point opposite the [fruit], which he secures. From the moment that his eyes fall upon the long stick, his procedure forms one consecutive whole, without hiatus. . . . (Köhler, 1925, p. 180)

In another situation involving out-of-reach fruit, Sultan had two hollow bamboo rods, one somewhat thinner than the other, and both too short to reach the fruit. After numerous "fruitless" attempts, he seemingly gave up and resorted to playing indifferently with the sticks. At one serendipitous point, Sultan found himself holding the two sticks end to end in such a way that they appeared to form a long, straight line. He immediately pushed the end of the thinner stick into the end of the thicker one (making a single long stick), ran to the edge of the cage, and obtained the elusive fruit.

In neither of the situations just described did Sultan engage in the random trial-and-error learning that Thorndike had described for cats. Instead, it appeared to Köhler that Sultan thought

**Figure 7.7**

Irregularly shaped objects may later be remembered as "circles" or "squares."

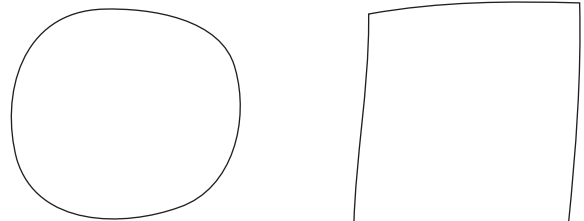

about possible solutions to the problem, arranging the problem elements in various ways—that is, **restructuring** them—until he arrived at a sudden **insight** as to a problem solution.

Gestalt psychology continues to influence how cognitive psychologists conceptualize learning and cognition. For example, we'll examine another basic organizing principle—figure-ground—when we look at the nature of attention in Chapter 8. We'll see *closure* at work when we examine constructive processes in perception and memory in Chapters 9 and 11. We'll revisit the Gestaltist idea of *insight* in our exploration of problem solving in Chapter 15. And the general idea that people organize what they learn will come up repeatedly in our discussions of learning and cognition in the chapters to come.

## VERBAL LEARNING RESEARCH

---

Beginning in the late 1920s, some researchers began to apply behaviorist principles to a uniquely human behavior: language. Such **verbal learning** research continued throughout the middle decades of the twentieth century (especially from the 1930s through the 1960s and early 1970s) and yielded many insights into the nature of human learning.

Central to verbal learning research were two learning tasks, serial learning and paired-associate learning, that could easily be analyzed in terms of an S–R perspective. **Serial learning** involves learning a set of items in a particular sequence; the alphabet, the days of the week, and the planets in our solar system are examples. Verbal learning theorists explained serial learning in this way: The first item in the list is a stimulus to which the second item is learned as a response, the second item then serves as a stimulus to which the third item is the learned response, and so on.

**Paired-associate learning** involves learning pairs of items. Two common examples are learning foreign language vocabulary words and their English equivalents (e.g., *le papier* is French for “the paper”) and learning capital cities of states or countries (e.g., the capital of Alaska is Juneau). Verbal learning theorists described paired associates as being distinct stimulus–response associations: The first item in each pair is the stimulus; the second item is the response.

Increasingly, verbal learning studies yielded results that couldn't be easily explained in terms of simple S–R connections, and theorists began to introduce a variety of mental phenomena into their discussions of learning processes. In this section, I'll describe several general learning principles that emerged from verbal learning research. Some of the findings are relatively easy to explain from a behaviorist perspective, but others are hard to explain unless we bring cognition into the picture:

- ◆ *Serial learning is characterized by a particular pattern.* A **serial learning curve** is usually observed in serial learning tasks: People learn the first few items and last few items more quickly and easily than they learn the middle items (J. F. Hall, 1971; McCrary & Hunter, 1953; Roediger & Crowder, 1976). If we were to graph the speed with which the various items in a serial list are learned, we might obtain results similar to what you see in Figure 7.8. A common example is the way in which most children learn the alphabet: They learn the first letters (A, B, C, D) and the last letters (X, Y, Z) before they learn the middle letters (e.g., J, K, L, M).

The tendency for the first items in a serial learning curve to be learned and remembered easily is called the **primacy effect**. The tendency for the last items to be learned and remembered easily is called the **recency effect**. Verbal learning theorists explained both effects by proposing

**Figure 7.8**  
A typical serial learning curve

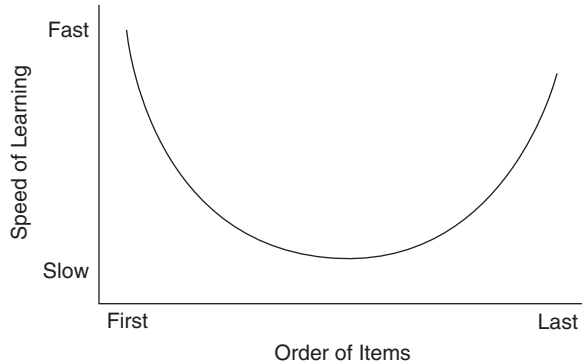

that the end points of the list (i.e., the first and last items) served as *anchors* to which the other items could then be attached in a stimulus–response fashion.

- ◆ *Overlearned material is more easily recalled at a later time.* What happens when you learn information perfectly and then continue to study it? This process of **overlearning**, in which you learn material to mastery and then practice it for additional study trials, enables you to remember the information more accurately at a later time (Krueger, 1929; Underwood, 1954). As you may recall from Chapter 3, practice is important for learning, presumably because it strengthens stimulus–response connections.

- ◆ *Distributed practice is usually more effective than massed practice.* Imagine that you have to study for a test and estimate that you need six hours to master the test material. Would you do better on the test if you studied for six hours all at once or if you divided your study time into smaller chunks—say, six one-hour sessions? Verbal learning researchers discovered that **distributed practice**, spreading study time out over several occasions, usually leads to better learning than **massed practice**, in which study time occurs all at once (A. Glenberg, 1976; Underwood, 1961; Underwood, Kapelak, & Malmi, 1976). In fact, the further apart the study sessions are, the better one’s recall for the studied information is apt to be over the long run (Rohrer & Pashler, 2007). From a behaviorist perspective, massed practice might eventually lead to fatigue, which would cause the learner to begin practicing inappropriate responses.

- ◆ *Learning in one situation often affects learning and recall in another situation.* Imagine that you have to learn two sets of paired associates, as follows:

<b>Set 1</b>	<b>Set 2</b>
house–dragon	house–paper
plant–sled	plant–clock
lamp–music	lamp–turkey
onion–pillow	onion–chair

After you’ve first learned Set 1 and then learned Set 2, you’re asked to recall the responses to each of the stimulus words in Set 1. Would you have difficulty? Probably so, because you learned different responses to those same words when you learned Set 2. You’d have an easier time remembering the correct responses you learned in Set 1 if you *hadn’t* also had to learn the Set 2 responses.

When people learn two sets of paired associates in succession, their learning of the second set often diminishes their ability to recall the first set—a phenomenon known as **retroactive inhibition**. In fact, individuals in this situation often have difficulty remembering the second set as well—a phenomenon known as **proactive inhibition**. The tendency for a set of paired associates learned at one time to interfere with the recall of a set learned either earlier or later is especially likely to occur when the two sets have the same or similar stimulus words but different response words (J. F. Hall, 1971; Osgood, 1949).

Under different circumstances, learning one set of information may actually improve the recall of information learned at another time—a phenomenon that verbal learning theorists called either **retroactive facilitation** or **proactive facilitation**, depending on the order in which the two sets of information were learned (J. F. Hall, 1971). Facilitation is most likely to occur when two situations have similar or identical stimuli and have similar responses as well (Osgood, 1949). As an example, after learning the stimulus–response pair “house–dragon,” you would probably learn “house–monster” fairly easily.

Verbal learning theorists proposed that retroactive and proactive inhibition were major factors in *forgetting* verbal information (e.g., McGeoch, 1942; Melton & Irwin, 1940; Underwood, 1948). Thus, these theorists were among the first to discuss theoretical ideas related to *memory*. Many contemporary cognitive psychologists also suggest that inhibition plays a significant role in memory and forgetting (see Chapter 11).

♦ *Characteristics of the material affect the speed with which people can learn it.* Verbal learning researchers identified a number of characteristics that affect the ease of learning and remembering verbal material:

1. Items are more quickly learned when they're *meaningful*—that is, when they can be easily associated with other ideas (Cofer, 1971; Paivio, 1971). German psychologist Hermann Ebbinghaus (1913) stumbled on this principle well before the verbal learning movement was off and running in the Western hemisphere. Serving as his own subject of study in a number of serial learning tasks, Ebbinghaus found that some words triggered associations that helped him remember the words more easily. He tried to eliminate the influence of associations by using presumably meaningless **nonsense syllables** (“words” such as JAD, MON, and ZIV). Yet even many nonsense syllables often have meaningfulness and evoke associations, thus making them relatively easy to learn (J. F. Hall, 1971). For example, the nonsense syllable JAD might make you think of “jade,” and the syllable MON might remind you of “money.”
2. Items are easier to learn and remember when they're *pronounceable* (Di Vesta & Ingersoll, 1969; Underwood & Schulz, 1960). For example, the nonsense syllable DNK should be learned faster than BPX because most people can pronounce DNK more easily.
3. *Concrete* items are easier to learn and remember than abstract items (Gorman, 1961; Paivio, 1963). For example, items such as *turtle*, *hammer*, and *sandwich* should be remembered more easily than items such as *truth*, *joy*, and *experience*.
4. One probable reason that the concreteness of items makes them easier to learn and remember is that concrete items can be *mentally visualized*. In general, items that readily evoke mental images (e.g., *turtle*) are more memorable than those that are hard to visualize (e.g., *truth*) (Paivio, 1971). This phenomenon of visual imagery—very clearly a mental phenomenon—is difficult to explain from a strict S–R perspective.

Some items are more meaningful than others.

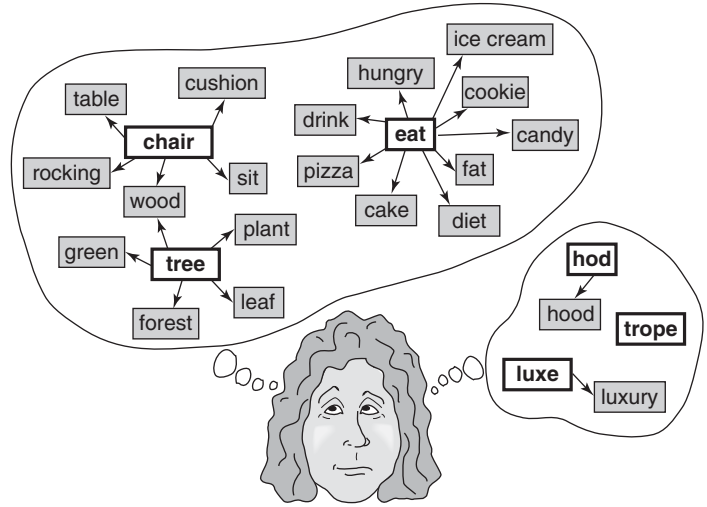

◆ *People often impose meaning on new information.* The effect of meaningfulness noted in the preceding bullet can be explained from an S–R perspective: When a stimulus word has many other words associated with it, one of those associations might in turn be associated with the response to be learned. More troublesome for an S–R approach is the fact that people will go out of their way to *make* information meaningful when trying to learn it. For example, when Bugelski (1962) asked adults to learn paired associates involving nonsense syllables, they almost invariably reported that they imposed meanings to help them learn the pairs. To illustrate, when given this pair:

DUP–TEZ

one person used the word *deputize* to help form the connection. Cognitive theories have emerged that probably better explain this tendency for human beings to search for meaning.

◆ *People organize what they learn.* When people are allowed to recall items of a serial learning task in whatever order they prefer—a task known as **free recall**—they typically *don't* recall the items in the original presentation order. Instead, their recall order often reflects an organizational scheme of some kind (Bousfield, 1953; Buschke, 1977; Jenkins & Russell, 1952). For instance, in a classic experiment by Bousfield (1953), college students were given a list of 60 words, 15 from each of four categories: animals, names, vegetables, and professions. Although the words were presented in a random order, the students tended to recall them in category clusters. For example, a typical recall order might have been something like this:

camel, giraffe, zebra, donkey, Jason, Adam, Howard, pumpkin, cabbage, carrot, lettuce,  
radish, milkman, baker, dentist

People even try to organize seemingly unorganized material (Tulving, 1962). This tendency of human beings to organize what they learn is difficult to explain using behaviorist principles. As you'll see in later chapters, however, it lends itself quite easily to an explanation based on cognitive learning theories.

◆ *People often use encoding strategies to help them learn.* As the earlier example of remembering DUP–TEZ as “deputize” illustrates, people often change, or *encode*, information in some way to

make it easier to learn (Bugelski, 1962; Dallett, 1964; Underwood & Erlebacher, 1965). Furthermore, when experimenters specifically tell people to use a certain encoding strategy to help them learn information, learning improves (Bugelski, Kidd, & Segmen, 1968; J. F. Hall, 1971). For instance, when people are instructed in techniques for forming mental visual images, they're able to remember a list of words more accurately than individuals who haven't been given such instructions (Bugelski et al., 1968).

- ◆ *People are more likely to learn general ideas than to learn words verbatim.* In fact, when people focus on learning ideas rather than on learning information word for word, their learning is faster and their recall more accurate (Briggs & Reed, 1943; H. B. English, Welborn, & Killian, 1934; H. E. Jones & English, 1926). Most verbal learning research focused on the learning of verbatim information. In doing so, it may very well have ignored the way in which human beings actually learn most verbal material.

Clearly, early verbal learning research gave us a number of useful learning principles. It also gave us two learning tasks—serial and paired-associate learning—that continue to be used in learning research. At the same time, in trying to stretch S–R models of learning to explain human verbal behavior, verbal learning research gradually uncovered weaknesses of the behaviorist perspective.

In more recent decades, the focus of much language-based learning research has been on how people learn meaningful verbal material (e.g., prose passages) rather than artificially constructed serial lists or paired associates. In fact, as researchers increasingly embraced cognitivist ideas in the latter part of the twentieth century, many of them abandoned the term *verbal learning* in favor of more obviously mental terminology—*memory*, *encoding*, *visual imagery*, and so on. For example, the *Journal of Verbal Learning and Verbal Behavior*—a widely read professional journal when I was in graduate school—became the *Journal of Memory and Language* in 1985.

## INTRODUCTION TO CONTEMPORARY COGNITIVISM

---

As we've just seen, even during behaviorism's heyday some researchers were laying a foundation for cognitive learning theories. During the 1960s, discontent with the limitations of behaviorism became more widespread. The behaviorist perspective couldn't easily explain why people often try to organize and make sense of new information and sometimes even alter its form. Learning theorists increasingly realized that they had to bring mental events—cognition—into the picture.

### General Assumptions of Cognitive Theories

The assumptions underlying contemporary cognitive theories of learning are radically different from those underlying behaviorism. What follow are some of the most central ones:

- ◆ *Some learning processes may be unique to human beings.* Because people possess abilities unique to the species (complex language is an example), the processes involved in learning are often quite different for human beings than they are for nonhuman animals. Accordingly, almost all research within the cognitivist perspective is conducted with human beings, and theories formulated from this research are typically not generalized to other species.

- ◆ *Learning involves the formation of mental representations or associations that aren't necessarily reflected in overt behavior changes.* Like Tolman and social cognitive theorists, contemporary



cognitive psychologists believe that learning involves an internal, mental change rather than the external behavior change that many behaviorists call for. Thus, learning can occur without affecting a learner's observable performance.

◆ *People are actively involved in the learning process.* Rather than being passive victims of environmental conditions, people are active participants in their learning and in fact ultimately *control* their own learning. Individual learners themselves determine how they mentally process their experiences, and these cognitive processes in turn determine what, if anything, is learned. To the extent that individual learners think differently about a situation, they'll learn different things from it.

◆ *Knowledge is organized.* An individual's knowledge, beliefs, attitudes, and emotions aren't isolated from one another but instead are all either directly or indirectly interconnected. The learning process itself contributes to this organization: As you'll discover in Chapter 9, people usually learn most effectively when they relate new information and experiences to things they already know.

◆ *The focus of scientific inquiry must be on objective, systematic observations of people's behaviors, but behaviors often allow reasonable inferences about unobservable mental processes.* Cognitive psychologists share with behaviorists the beliefs that the study of learning must be an objective endeavor that bases its theories on the results of empirical research. Also, like behaviorists, they know that learning has taken place only when they see a change in people's behavior. However, cognitivists differ from behaviorists in one critical respect: By observing people's responses to various stimulus conditions, they believe they can draw reasonable inferences about the internal mental processes that underlie those responses. In fact, researchers have become increasingly ingenious in designing research studies that enable them to draw conclusions about the cognitive processes involved in learning.

A classic study by Bransford and Franks (1971) provides an example of inference drawing in cognitive research. In this experiment, undergraduate students listened to 24 sentences and answered simple questions about each one. The sentences were variations on four general ideas: a rock rolling down a hill, a man reading a newspaper, a breeze blowing, and ants eating jelly. To illustrate, the six sentences about the ants eating jelly were as follows:

The ants ate the sweet jelly which was on the table.

The ants in the kitchen ate the jelly which was on the table.

The ants in the kitchen ate the jelly.

The ants ate the sweet jelly.

The ants were in the kitchen.

The jelly was on the table.

The students then listened to a second set of 28 sentences (variations on the same four themes as before) and were asked to indicate whether or not each had been in the first set. Most of the sentences (24 out of 28) were *new* sentences; following are some examples:

The ants in the kitchen ate the sweet jelly which was on the table.

The ants in the kitchen ate the sweet jelly.

The ants ate the jelly which was on the table.

The jelly was sweet.

The students erroneously “recognized” most of the new sentences as being ones they had seen before. They were especially likely to “recognize” new sentences that contained a lot of information—for instance, “The ants in the kitchen ate the sweet jelly which was on the table.” From such results, Bransford and Franks concluded that people construct general ideas from the many tidbits of information they receive—they don’t just learn the new information verbatim—and they organize similar ideas together in their memories. Sentences in the experiment that included most or all of the information related to a single theme may have more closely resembled the students’ organized memories and so seemed more familiar.

Obviously, Bransford and Franks didn’t directly observe the cognitive processes they described. Yet such processes seem to be reasonable explanations of the behaviors they *did* see.

Despite sharing certain common assumptions, cognitivists take somewhat different approaches in their attempts to portray how learning occurs. The predominant approach to the study of human learning, as reflected in ongoing research and journal space, is a group of theories collectively known as *information processing theory*. In recent years, however, two other perspectives—*constructivism* and *contextual theories*—have also gained popularity.

## Information Processing Theory

Many cognitive theories focus on how people think about (i.e., *process*) the information they receive from the environment—how they perceive the stimuli around them, how they “put” what they’ve perceived into their memories, how they “find” what they’ve learned when they need to use it, and so on. Such theories are collectively known as **information processing theory**.

Early views of information processing, especially those that emerged in the 1960s, portrayed human learning as being similar to how computers process information. Yet it soon became clear that the computer analogy was overly simplistic—that people often think about and interpret information in ways that are hard to explain in the rigid, algorithmic, one-thing-always-leads-to-a-predictable-other-thing ways that characterize computers (e.g., Hacker, Dunlosky, & Graesser, 2009a; Marcus, 2008; Minsky, 2006; Rubín, 2006). At the present time, the general perspective known as information processing theory includes a variety of specific theories about how people mentally deal with new information. Some are computerlike in nature, but many others are not.

Information processing researchers have been extremely helpful in identifying the many processes that human cognition involves. In doing so, however, they’ve sometimes zeroed in on trivial tasks that only remotely resemble typical human learning situations (Bjorklund, 1997; Hambrick & Engle, 2003). And although they’ve told us a great deal about *how* people learn, they’ve been less specific about exactly *what* people acquire as they learn (P. A. Alexander, White, & Daugherty, 1997). But in my mind, the biggest weakness of information processing theory is that it has been better at dissection than at synthesis: It has yet to combine various cognitive processes into an integrated whole that explains, overall, how human beings think and behave.

## Constructivism

As research findings about human learning have accumulated, it’s become increasingly apparent that learners don’t just passively absorb the information they encounter. Instead, they actively try to organize and make sense of it, often in unique, idiosyncratic ways. Many cognitive theorists

now portray learning more as *constructing* knowledge rather than directly acquiring it from the outside world. Some (but not all) theorists refer to this perspective as **constructivism** rather than information processing theory.

Early Gestalt psychologists clearly had a constructivist bent. For example, construction is involved when learners perceive separate objects as being a unit (reflecting such principles as *proximity* or *similarity*) and when they fill in missing pieces in what they're looking at (reflecting *closure*). Tolman's concept of *cognitive map* has a constructivist flavor as well: Learners combine various spatial relationships they've learned into a general mental representation of how their environment is laid out. In these situations, we see the process of construction occurring separately within each learner, reflecting a perspective known as **individual constructivism**.

In other situations, people work together to make sense of their world. For instance, several students may form a study group in which they work together to interpret and better understand a difficult and confusing textbook. As another example, astronomers have, over the course of several centuries, made increasingly better sense of phenomena they've observed through their telescopes; in the process, they've continued to add to and modify the discipline of astronomy. A perspective known as **social constructivism** encompasses theories that focus on how people work together to create new knowledge, perhaps at a single sitting or perhaps over a period of many years.

Constructivist perspectives have directed psychologists' attention to *what* is learned; the *schemas*, *scripts*, and *personal theories* to be described in Chapter 10 are examples of the forms that learner-constructed knowledge might take. Constructivist perspectives also place the reins for directing learning squarely in the hands of the learner. Teachers can't "pour" knowledge into the heads of students as they might pour lemonade into a glass; rather, students must make their own lemonade.

Yet constructivism, like information processing theory, has its drawbacks. It offers only vague explanations of the cognitive processes that underlie learning (Mareschal et al., 2007; Mayer, 2004; Tarver, 1992). Furthermore, some constructivists take the idea of learner control too far, suggesting that teachers don't have—and perhaps *shouldn't* have—much influence over how students interpret subject matter and learn from classroom activities (e.g., see critiques by Marton & Booth, 1997; Mayer, 2004; S. M. Miller, 2003). In fact, thousands of research studies—as well as countless personal experiences of students in elementary, secondary, and college classrooms—tell us that teachers' instructional practices can have a powerful impact on what students learn and how effectively they learn it.

## Contextual Theories

Some cognitivist theories place considerable emphasis on the importance of the immediate physical and social environment—the *context*—as it affects cognition and learning. In general, such **contextual theories** suggest that learners often think and perform more intelligently and effectively when they can draw on a variety of environmental support systems that enable them to make sense of new situations and help them tackle challenging tasks and problems.

Sometimes environmental supports for learning and performance are concrete and easily observable. This is the case, for instance, when people use calculators, computers, diagrams, equations, or paper and pencil to help them analyze data or solve problems. In other instances, environmental supports are so abstract and pervasive in one's culture that they're taken for granted and easily overlooked as contextual factors affecting learning. Consider, for example, the concepts *north*, *south*, *east*, and *west*. Over the years, you've undoubtedly used these concepts frequently to

help you find your way around the countryside or on a map. Despite their obvious relationship to Mother Earth, these concepts are creations that some cultures—and *only* some cultures—provide.

Contextual theories of learning have a variety of labels attached to them. Terms such as *situated learning*, *situated cognition*, *distributed learning*, *distributed intelligence*, and *embodiment* all refer to situations in which learning and thinking are influenced by the physical and social contexts in which people are immersed. For example, the term *distributed intelligence* refers, in part, to the notion that we often perform more effectively when we think about and discuss ideas with others than when we think alone. When contextual perspectives focus specifically on the influence of culture in learning, the term *sociocultural theory* is often used. Sociocultural theory and other contextual perspectives have their roots in Vygotsky's theory of cognitive development, and so we'll look at them more closely in Chapter 13.

With the exception of the work of Vygotsky and some of his Russian compatriots in the first half of the twentieth century, contextual views have been a fairly recent addition to the cognitivist scene. Accordingly, we don't yet have a large body of research that allows us to substantiate some theoretical claims and modify others. The benefit of contextual theories lies largely in how they bring our attention back to the importance of the immediate context—an idea that seemingly brings us full circle back to behaviorism. There's a very important difference, however. The emphasis here isn't on concrete, observable stimuli that bring about relatively thought-free conditioning (a behaviorist view) but rather on general factors—physical, social, and cultural—that support very “thoughtful” learning.

## Integrating Cognitive Perspectives

It's important to note that complete consensus doesn't exist—not even among cognitivists—about how different cognitive theories can best be categorized. As one simple example, some theorists (including yours truly) have portrayed contemporary information processing theory as being decidedly constructivist in nature (e.g., Derry, 1996; Phye, 1997; Prawat, 1996; Pressley, Wharton-McDonald, et al., 1997; also see Chapter 9).

Despite the fuzziness of the boundaries between various cognitive perspectives, some psychologists and educators have insisted on drawing sharp distinctions among them. This tendency to dichotomize theoretical perspectives—to portray one as black and another as white, to suggest that one points strictly to “teacher-centered” instructional methods while another supports more “learner-centered” methods, and in some cases to imply that one is a “good guy” and another is a “bad guy”—drives me nuts, and some of my colleagues in the field share my concern (e.g., Bereiter & Scardamalia, 1996; Clancey, 1997, 2009; K. R. Harris & Alexander, 1998; Prinz, 2009; R. K. Sawyer & Greeno, 2009; Sfard, 1998).

Having read countless books, articles, and papers about human learning over the past 40 years, I remain firmly convinced that ideas from information processing theory, constructivism, and contextual views—as well as ideas from theories we've already considered (e.g., social cognitive theory and recent, cognitively oriented behaviorist perspectives)—all make significant contributions to our understanding of how human beings think and learn. Taken in combination, they give us a more complete understanding of human cognition than any single approach can offer alone (e.g., J. R. Anderson, Greeno, Reder, & Simon, 2000; Gauvain, 2001; Leach & Scott, 2008; Marshall, 2009; R. K. Sawyer & Greeno, 2009; Zimmerman, 1981). Accordingly, we'll be pulling eclectically from a variety of cognitive perspectives as we continue to explore how people think and learn in the next few chapters.

## GENERAL EDUCATIONAL IMPLICATIONS OF COGNITIVE THEORIES

---

We have much more to discover about cognitivist perspectives in the chapters ahead. But even at this point, we can make two generalizations that have implications for educational practice.

♦ *Students control their own learning through the cognitive processes in which they engage.* The behaviorist B. F. Skinner (1954, 1968) argued that if students are to learn anything, they must make active responses in the classroom. Cognitivists share Skinner's view; however, they emphasize *mental* activity rather than physical activity. Students who aren't mentally active in the classroom—those who don't pay attention to, make sense of, and in other ways cognitively process the subject matter at hand—learn very little. For those who *do* become mentally engaged with the subject matter, the nature of their cognitive processes will determine what they learn and how effectively they learn it. Thus, teachers must consider not only *what* students need to learn but also *how* students are trying to learn it.

♦ *Instructional practices can have a significant impact on how students mentally process classroom material and thus also on how effectively students learn it.* Verbal learning theorists uncovered several factors that enhance learning, including the degrees to which new information is meaningful, concrete, and easy to organize. Teacher guidance regarding effective ways to study—for instance, instruction in the use of visual images—can also make a difference. In upcoming chapters, we'll consider many, many ways in which the nature of both instructional materials and instructional practices can maximize students' learning for the long run.

---

### SUMMARY

Cognitivism is currently the predominant theoretical perspective within which human learning is studied and explained. The roots of cognitive theory can be found in research and theories dating back to the 1920s and 1930s. For example, while conducting animal laboratory studies similar to those of behaviorists, Edward Tolman included mental phenomena in his views of how learning occurs. Gestalt psychologists emphasized the importance of organizational processes in perception, learning, and problem solving, proposing that people are predisposed to organize information in particular ways. In the middle decades of the twentieth century, verbal learning theorists, who initially attempted to apply an S-R analysis to the study of human language-based learning, further stoked the cognitivist fire by increasingly incorporating mental events into explanations of their research results.

Contemporary cognitivism emphasizes mental processes and proposes that many aspects of learning

are probably unique to the human species. Cognitivists share behaviorists' belief that the study of learning must be objective and that learning theories should be based on empirical research; however, they suggest that by observing the responses human learners make to different stimulus conditions, they can draw inferences about the cognitive processes that have led to various responses. Cognitivism encompasses several perspectives—information processing theory, constructivism, and contextual views—that all contribute to our understanding of how human beings think and learn.

In classroom settings, what students do “inside” typically makes a huge difference in what they learn and how well they remember it. Fortunately, as we'll see in later chapters, teachers can do many things to promote and support effective cognitive processes.

# BASIC COMPONENTS OF MEMORY

### *A Dual-Store Model of Memory*

*Sensory Register*

*Moving Information to Working Memory:*

*The Role of Attention*

*Working Memory*

*Moving Information to Long-Term Memory:*

*Connecting New Information with Prior Knowledge*

*Long-Term Memory*

### *Challenges to the Dual-Store Model*

*Are Working Memory and Long-Term Memory*

*Really Different?*

*Is Conscious Thought Necessary for Long-Term Memory Storage?*

*Alternative Views of Human Memory*

*Levels of Processing*

*Activation*

*Remembering That The Map Is Not the Territory*

*Generalizations about Memory and Their Educational Implications*

*Summary*

Imagine yourself taking an exam on the material in the preceding chapter. Imagine, too, that, as your instructor, I write ridiculously picky exam questions. You come to this question: “What was Edward C. Tolman’s middle name?”<sup>1</sup> You know you read this information in the chapter, and you even wrote it down in your notebook, but despite your best efforts you can’t recall it now that you need it. After considering all of the names you can think of that begin with C, you finally write “Charles”—although you’re pretty sure it *wasn’t* Charles—and turn in your exam. Immediately afterward, you meet your classmates in the hall and rehash the questions. “What was Tolman’s middle name?” you ask. “It was Chace,” your friend Harry responds. “I remembered that because my sister married a guy named Marvin Chace.” And then your friend Carol adds, “I learned the name by imagining Tolman *chacing* his rats down their mazes.” You grit your teeth, thinking it ridiculous that Harry and Carol could answer the question because of a coincidental brother-in-law or silly visual image. But let’s face it, your classmates remembered and you didn’t.

Mere exposure to new information doesn’t necessarily mean that you’ll learn it, and even if you do, you won’t necessarily remember it later on. Many variables determine what information gets into memory in the first place and what information stays there long enough for you to recall it when you need it. In this chapter, we’ll begin our exploration of human memory by looking at a popular model of memory—the *dual-store model*—and also at two alternative perspectives of how memory might work. As we do these things, we’ll draw largely from information processing theory. Thus, we first need to pin down some of its basic terminology: memory, storage, encoding, and retrieval.

**Memory** Information processing theorists have consistently made a distinction between *learning* and *memory*. Learning is viewed, quite simply, as the acquisition of new information or skills; as we defined it in Chapter 1, it involves a long-term change in mental representations or associations as a result of experience. In contrast, **memory** is related to the ability to *recall* previously

---

<sup>1</sup>In reality, I would *never* give you such a question, for reasons you’ll discover in Chapter 11.

acquired information. In some instances, the word *memory* refers to the process of retaining information for a period of time. In other instances, it refers to a particular “location” (e.g., *working memory* or *long-term memory*) where acquired information is kept.

**Storage** In their early, computer-analogy days, information processing theorists began to use such computer lingo as *storage*, *encoding*, and *retrieval*—terms that have remained despite the drift to non-computer-based views of human cognition. **Storage** is the process of “putting” new information in memory. For example, if you can put this fact in your head:

Jeanne Ormrod’s birthday is August 22.

then you’re *storing* the information. We’ll talk a little bit about storage processes in this chapter and examine some of them in considerable depth in Chapter 9.

**Encoding** As people store information in memory, they usually modify it in some way; this process of **encoding** often helps them store the information more easily.<sup>2</sup> Sometimes encoding involves *changing the form* of the information. For example, I once had a combination lock for which the combination was 22-8-14. I quickly learned the first two numbers by encoding them as “the day and month of my birthday.” In this case, I changed numerical information into a verbal form. Encoding may also involve *adding to* new information using one’s existing knowledge of the world. For example, consider this information:

Jeanne Ormrod was born in Providence, Rhode Island.

Reading this, you might conclude that I’m a native New Englander or that I’m a U.S. citizen— inferences you might store along with the information I actually gave you. Yet another encoding process is one of *simplifying* new information—for example, by remembering the overall meaning or gist of a situation rather than the specific details of what happened. For example, you might recall that the author of one of your textbooks mentioned her birthday but not remember the actual date.

**Retrieval** The process by which people “find” information they’ve previously stored so they can use it again is called **retrieval**. For example, I’m hoping that, come mid-August, you’ll retrieve the date of my birthday and send me a tasteful card. Because I get cards from few of my readers, we can conclude that retrieval is quite easy in some cases but more difficult in others. An alternative hypothesis, of course, is that information retrieval is occurring but isn’t resulting in a behavior change.

## A DUAL-STORE MODEL OF MEMORY

---

Late in the nineteenth century, Harvard psychologist William James (1890) proposed that human memory has three components: an after-image, a primary memory, and a secondary memory. James’s model was largely ignored during the behaviorism-dominated early decades of the twentieth century, but the advent of cognitivism during the 1960s brought a renewed interest in human

---

<sup>2</sup>In our discussion of modeling in Chapter 6, we noted that people can often remember a model’s behavior more accurately when they form verbal or visual *memory codes* to help them remember the specific actions that the model has demonstrated. Such memory codes are examples of encoding in action.

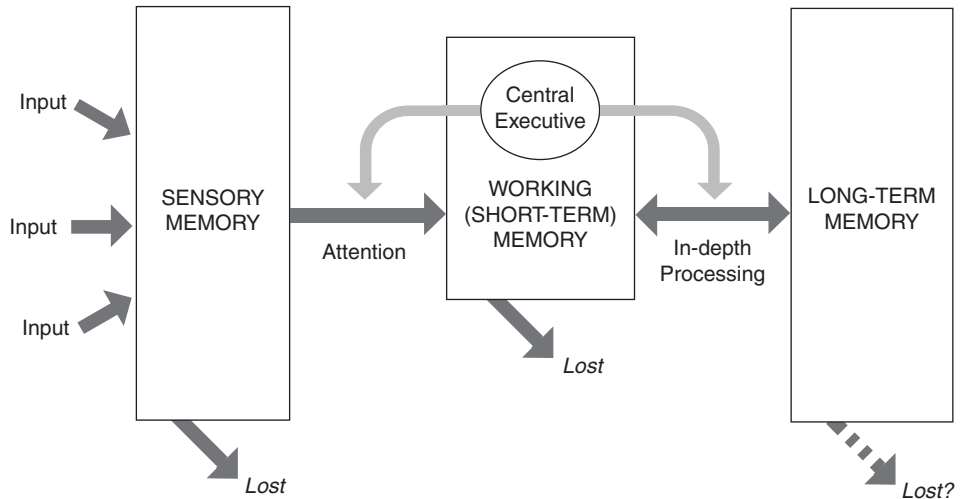

**Figure 8.1**  
A simplified dual-store model of memory

memory, and psychologists Richard Atkinson and Richard Shiffrin (1968, 1971) proposed a three-component model of memory similar to that of James. Figure 8.1 is based loosely on Atkinson and Shiffrin’s model but also takes into account more recent research findings and terminology. Despite its three components, the model depicted in Figure 8.1 is known as a **dual-store model** because of its claim that working memory and long-term memory are distinctly different entities. As you’ll discover later in the chapter, not all psychologists buy into this claim.

In upcoming pages we’ll look at each part of the model in considerable depth, as well as at various **control processes**—cognitive processes that directly affect memory’s functioning—that are involved along the way. But for now it might be helpful to think of the dual-store model as similar to an information selection and storage system you might use to deal with the many paper items you acquire at home. You undoubtedly receive numerous paper-based items over the course of a few months—perhaps newspapers, magazines, personal letters, bills, a driver’s license, university transcripts, junk mail, and grocery store receipts. You probably discard some items (e.g., junk mail and grocery receipts) as soon as you see what they are; these things get no further than the “sensory register” of your storage system. You need to deal with others briefly—for instance, you need to pay your bills—and then you can more or less forget them; that is, you process them for a short time in your system’s “working memory.” Still other items, such as a driver’s license and transcripts, may be important enough that you want to put them in some sort of “long-term memory” compartment—perhaps a wallet, file cabinet, or safe-deposit box—where you can find them later.

As we examine the three components of the dual-store model, please remember that the language we’ll use is sometimes metaphorical in nature. For example, the three components of memory aren’t necessarily three separate “places” in the brain. Furthermore, when we talk about memory processes, we aren’t necessarily saying anything about neurological events. Psychologists still have much to learn about how memory processes occur physiologically and how brain structure relates to psychological models of human memory (see Chapter 2). Occasionally I’ll suggest in footnotes where in the brain certain structures and functions may be located. But our



emphasis here will be on what psychologists have learned about memory by studying human behavior and performance—for instance, what kinds of things people seem to be able to remember, and under what circumstances they remember most effectively—rather than by studying the anatomy and physiology of the brain.

## Sensory Register

The first component of the dual-store model, the **sensory register**, holds incoming information long enough for it to undergo very preliminary cognitive processing.<sup>3</sup> For example, if you've ever played at night with a lighted sparkler—one of those metal sticks that, when lit, emits fiery sparks for a few minutes—then you've seen the tail of light that follows the sparkler as you wave it about. This trail doesn't exist in the air itself; it's the result of your sensory register saving the light for a short time after you've seen it. As another example, when you sit in a classroom for an hour or more, your attention will at some point almost inevitably wander away from the instructor. You may have noticed that when you tune back in to what the instructor is saying, you can often recall two or three words that the instructor said *right before* you tuned back in. Virtually everything the instructor has uttered has probably been recorded in your sensory register despite your mental absence from class, but, alas, only those last two or three words are still there when you decide to be mentally present again.

### *Characteristics of the Sensory Register*

Let's look specifically at three characteristics of the sensory register: capacity, forms of storage, and duration.

**Capacity** As far as psychologists can tell, the sensory register has a very large capacity. For instance, even 6-month-old infants seem to record a good deal of what they see, albeit only very temporarily (Blaser & Kaldy, 2010; Neisser, 1967).

**Forms of storage** Information appears to be stored in the sensory register in basically the same form in which it has been sensed: Visual input is stored in a visual form, auditory input in an auditory form, and so on (Coltheart, Lea, & Thompson, 1974; Cowan, 1995; Howard, 1983; Turvey & Kravetz, 1970). At this point, information hasn't yet been understood or interpreted by the learner. In other words, the sensory register holds information before any significant encoding occurs.<sup>4</sup>

**Duration** Information remains in the sensory register for only a very brief time, but measuring its exact duration is difficult. A key problem in studying the sensory register's duration is that when we ask people to report or in some other way process something they've stored there, the information automatically moves on to working memory and so is no longer in the place where we want to study it!

---

<sup>3</sup>You might also see the terms *sensory buffer*, *iconic memory* (for vision), and *echoic memory* (for hearing).

<sup>4</sup>As we discovered in Chapter 2, different parts of the brain seem to be responsible for processing different kinds of sensory input. We can reasonably guess, then, that the sensory register isn't a single structure located in a particular spot in the brain. Rather, different areas may act as sensory registers for different sensory modalities.

In an early study, George Sperling (1960) designed an ingenious method to assess the duration of information in the sensory register. Recruiting adults to participate in his experiment, Sperling presented displays of three rows of four letters and digits each; following is a typical display:

7	1	V	F
X	L	5	3
B	4	W	7

Each display was presented for a fraction of a second, and then participants were asked to recall either one particular row of symbols or all 12 symbols. When asked to recall a single row, people were able to do so with 76% accuracy; because they weren't told *which* row they would need to recall until after the display had disappeared, they apparently remembered approximately 76% of the symbols they had seen. Yet when asked to recall all 12 symbols, they could do so with only 36% accuracy. Sperling's explanation of these results was that most of the symbols were stored initially but faded from memory before the participants had a chance to report them all. In a follow-up experiment, Sperling varied the amount of time that elapsed between the display and the signal indicating which row was to be remembered. People could recall little of a display after a delay of more than a quarter of a second.

Judging from Sperling's early results, as well as from the results of more recent research, it appears that the duration of a complete visual stimulus probably remains in the sensory register for less than a second, although parts of it may remain for up to 2 seconds—perhaps a bit longer if no new visual information comes in (e.g., Gold, Murray, Sekuler, Bennett, & Sekuler, 2005; G. R. Loftus & Loftus, 1976; Sligte, Sholte, & Lamme, 2009). Auditory information is more likely to last for at least two seconds and often lasts even longer, with louder stimuli lasting longer than quieter ones (C. L. Baldwin, 2007; Cowan, Nugent, Elliott, & Saults, 2000; Darwin, Turvey, & Crowder, 1972; Lu, Williamson, & Kaufman, 1992).

Why might auditory input last longer than visual input? One possible explanation is that a major source of auditory input—human speech—can be understood only within its sequential context (Dahan, 2010; Grossheinrich, Kademmann, Bruder, Bartling, & von Suchodoletz, 2010; Wingfield & Byrnes, 1981). For example, consider this sentence:

I scream for ice cream.

You can interpret the first two words as either *I scream* or *ice cream*. Only when you hear the third word—*for*—can you begin to interpret the first two words accurately. The task of understanding speech, which is frequently filled with temporarily ambiguous sounds, is often easier if we can hold those sounds in memory in an uninterpreted form until we receive additional, clarifying information. As we human beings have acquired a greater capacity for language, then, evolution may gradually have given us a greater capacity to retain uninterpreted sequential auditory input.

Two factors probably account for the rapid disappearance of information from the sensory register (Breitmeyer & Ganz, 1976; G. R. Loftus & Loftus, 1976; Lu & Sperling, 2003; Sligte et al., 2009). First, *interference* may be a factor: New information coming in effectively replaces—and thereby erases—the information already there. Yet even without new input, existing information in the sensory register seems to quickly fade away, or *decay*, over time. In any case, in most instances people don't need to store information there for very long. Important information is often going to be processed sufficiently that it enters working memory. Unimportant information, like junk mail, is probably best thrown away.

## Moving Information to Working Memory: The Role of Attention

If we want to move information from the sensory register into working memory, it appears that, at least in most cases, we must *pay attention* to it (Atkinson & Shiffrin, 1968; Cowan, 1995; M. I. Posner & Rothbart, 2007). For example, as you read this book, you're probably attending to only a small part of the visual input your eyes are receiving from your environment (I hope you're attending to the words on this page!). In the same way, you don't worry about all of the sounds you hear at any particular time; you select only certain sounds to pay attention to. In essence, information that a learner pays attention to moves on to working memory, whereas information that isn't attended to may be lost from the memory system.

One reason people don't remember something they've seen or heard, then, is that they never really paid attention to it. If you're sitting in class with your mind a thousand miles away from the professor's lecture, you might say that you forgot what the instructor said, or you might say that you never heard it in the first place. The reality of the situation is somewhere in between: The lecture reached your sensory register but wasn't sufficiently processed to move on to your working memory.

Even when people pay attention to a particular stimulus, they don't necessarily attend to its most important aspects.<sup>5</sup> Such is especially the case with complex stimuli, such as reading materials (e.g., Faust & Anderson, 1967). Once, when I was teaching introductory psychology to first-year college students, a young woman who had failed my first two exams came to my office expressing frustration about her lack of success in my class. When I asked her to describe how she went about completing the assigned readings in the textbook, she told me, "Well, I start looking through the chapter, and when I get to a page that looks important, I read it." With further probing, I discovered that this young woman had been reading only about one out of every three pages assigned.

### **Factors Influencing Attention**

Certain kinds of stimuli tend to draw attention, whereas other kinds don't (Craik, 2006; M. I. Posner & Rothbart, 2007; Rakison, 2003). Following are several factors affecting what people pay attention to and therefore what they store in working memory.

**Motion** Imagine that you've agreed to meet some friends at a carnival. When you first see your friends in the crowd, you might wave one or both arms wildly about to get their attention. Moving objects are more likely to capture attention than stationary ones (Abrams & Christ, 2003; L. E. Bahrack, Gogate, & Ruiz, 2002).

**Size** Which of the following letters first draw your eye?

A B C D E F G

You probably noticed the B and E before the other letters because of their larger size. Attention tends to be drawn to large objects, a principle that newspaper publishers apply when they type-set front-page headlines in **large letters** and that advertisers take advantage of when they put potentially unenticing information in fine print.

<sup>5</sup>Behaviorists have referred to this issue as one of a *nominal stimulus* (what is presented to the learner) versus an *effective stimulus* (what the learner is actually attending to).

**Intensity** More intense stimuli—bright colors and loud noises, for instance—attract attention. Teachers frequently speak more loudly than usual—“**Be quiet!**”—when they want to get students’ attention. Similarly, toy manufacturers use bright colors in the toys they produce, knowing that young children browsing store shelves will be more attracted to vivid reds and yellows than to subtle pinks and beiges.

**Novelty** Stimuli that are novel or unusual in some way tend to draw people’s attention (M. Hofer, 2010; K. A. Snyder, 2007). For example, look at the women in Figure 8.2. You probably find yourself paying more attention to the woman on the right than to the other three. A gal with two heads and three legs doesn’t come along very often.

**Incongruity** Objects that don’t make sense within their context tend to capture people’s attention (Craik, 2006). For example, read this sentence:

I took a walk to the rabbit this morning.

Did you spend more time looking at the word *rabbit* than at the other words? If so, it may have been because *rabbit* is incongruous with the rest of the sentence.

**Social cues** Again imagine yourself at that carnival I mentioned earlier. You’ve now connected with your friends and are in line to ride through the Spook House. Suddenly many people in front of you gasp as they look up at the Death-Defying Triple Loop-the-Loop off to the right. Almost certainly you’ll follow their line of sight to discover why they’re gasping. People are more likely to pay attention to things they see *others* looking at and reacting to (D. A. Baldwin, 2000; Gauvain, 2001; Kingstone, Smilek, Ristic, Friesen, & Eastwood, 2003). Even infants rely on such social cues, as you’ll discover in our discussion of *social referencing* in Chapter 13.

**Emotion** Stimuli with strong emotional associations attract attention. A naked person running through a crowded room usually draws the attention (and astonished expressions) of just about everyone present. Words such as *blood* and *murder* also are attention getters because of their emotional overtones. Of course, some emotionally laden stimuli also have personal significance—our final attention-getting factor.

**Personal significance** As a general rule, the factors I’ve just listed tend to capture attention but don’t necessarily hold it for very long. In contrast, personal significance—the meaning and relevance people find in an object or event—can both capture and *maintain* attention (Barkley, 1996; Craik, 2006; S. Kaplan & Berman, 2010). When a student sits in front of a television set

**Figure 8.2**  
Novelty draws attention.



with an open textbook, the stimulus the student attends to—the television or the book—depends in large part on which stimulus is more closely related to the student's motives at the time. If the textbook is interesting or if an important exam is scheduled for the next day, the student will attend to the book. But if a popular situation comedy or a cliff-hanging soap opera is playing, or if the textbook is dry and unenticing, the student may very well forget that the text is even in the same room.

Think, for a moment, about curriculum materials, including textbooks, that you've seen recently. Do they have characteristics that are apt to catch a student's eye? Do important words and concepts stand out, perhaps because they're **larger** or **more intense** or **unusual**? Are certain topics likely to grab a student's interest because they're interesting and relevant to the age-group? If your answer to these questions is *no*, then students may very well have difficulty attending to and learning from those materials.

### ***Nature of Attention***

What do we actually do—mentally, that is—when we want to pay attention to something? On the surface, the answer might seem simple: “I just focus my eyes on the object,” you might think. Yet you can probably recall times when you've directed your eyes toward a specific object but paid no attention to it at all: Perhaps you were listening intently to a piece of music or were deep in thought about something that wasn't anywhere in sight (e.g., Mack, 2003). Furthermore, people can focus their attention in at least one sensory modality—hearing—without having to physically orient themselves in a particular direction. For example, you can go to a social gathering where numerous conversations are going on and successfully attend to just one of them, regardless of where your ears are “aimed.” You might be listening to the person standing directly in front of you, or, if that person has been rambling on for more than an hour about the trouble he has growing rhubarb, you might instead tune in to a more interesting conversation a few feet to your right or left. Even though you're looking directly at the rhubarb grower and nodding in mock agreement, your attention is somewhere else altogether.

The ability to attend to one spoken message while ignoring others—aptly called the **cocktail party phenomenon**—has been studied using a technique called *shadowing*: A person wears earphones to listen to two simultaneously spoken messages and is asked to repeat one of them. Accurately repeating one of the messages is fairly easy when the two people speaking have very different voices, are talking about different topics, and are presenting their messages from seemingly different directions. It becomes far more difficult—sometimes impossible—when the two voices, topics, or apparent locations of the speakers are similar (Cherry, 1953). Furthermore, people who shadow one of two messages notice very little of the other message; perhaps they notice whether the other speaker is male or female, but they can seldom report any of the words included in the unattended message and typically don't even notice whether the message is spoken in their native tongue (Cherry, 1953).

Given such findings, some early cognitive psychologists likened auditory attention to a *filter*: A listener uses physical characteristics to select one message and screen out others, much as a radio zeroes in on one frequency and shuts out the rest (e.g., Broadbent, 1958). Yet subsequent research has shown that people don't totally filter out information from a supposedly unattended message (J. A. Gray & Wedderburn, 1960; Heatherton, Macrae, & Kelley, 2004; Treisman, 1964). People who participate in shadowing experiments notice especially meaningful words—for instance, their own names—in the unattended message. They also hear words

that fit meaningfully into the attended message. For example, suppose you hear these two sentences simultaneously and are asked to shadow only the first one:

*Speaker 1:* I bought candy at the plate today.

*Speaker 2:* Put the rhubarb on my store, please.

You might very well “hear” the first speaker say, “I bought candy at the store today” (borrowing the word *store* from the second speaker) because that sentence makes more sense than what the speaker actually said.

Although most psychologists now reject the idea that attention is like a filter, they continue to have trouble pinning down its precise nature. It almost certainly involves both automatic responses (e.g., immediately turning to look in the direction of a loud, unexpected noise) and conscious control (e.g., deciding which conversation to listen to at a cocktail party).<sup>6</sup> It also involves learning to some degree; in particular, people learn that certain kinds of stimuli are important and that others can easily be ignored (Kruschke, 2003). In general, you might think of attention as being *focused cognitive processing of particular aspects of the environment* (Barkley, 1996; Cowan, 1995; Johnston, McCann, & Remington, 1995).

### ***Attention's Limited Capacity***

Perhaps learning would be easier if people could attend to *everything* they record in their sensory registers. Unfortunately, people aren't capable of attending to everything at once. For example, look at Figure 8.3. At first glance, you probably see a white goblet. But if you look at the black spaces on either side of the goblet, you should also be able to see two silhouettes (“Peter” and “Paul”) staring at each other.

Now try this: See if you can focus on both the goblet and the two silhouettes at *exactly* the same time, so that you can clearly see the details of both. Can you do it? Most people can't attend to the goblet and the faces at exactly the same time, although they may be able to shift their focus from the goblet to the faces and back again very quickly. The Peter–Paul goblet illustrates a phenomenon that early Gestalt psychologists called **figure–ground**: When people are focusing on

**Figure 8.3**  
The Peter–Paul goblet

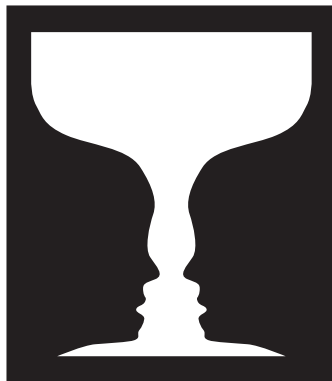

<sup>6</sup>The hindbrain, midbrain, and forebrain all have some involvement in attention. The reticular formation, hippocampus, and frontal and parietal lobes of the cortex are especially important (see Chapter 2).

the details of one object (the **figure**), they cannot also inspect other things in their line of sight—things that become the background (or **ground**) for the object. People may notice a few salient characteristics of background items (e.g., their color) but gain little other information about them.<sup>7</sup> From this perspective, the only way to gain detailed information about two or more items would be to shift the focus of attention from one item to another.

But now consider a situation in which you're driving your car while also carrying on a conversation with a friend. Certainly you're attending to two things—the road and the conversation—at once. To account for such a situation, many theorists describe attention as involving a **limited processing capacity**, with the number of stimuli being attended to depending on how much cognitive processing is required for each one (e.g., J. R. Anderson, 2005; Cowan, 2007; Pashler, 1992; Sergeant, 1996). If you're engaging in a difficult task, such as learning how to drive a car with a standard transmission, you may very well need to devote your full attention to that task and so not hear a thing your friend is telling you. However, if you're doing something more habitual or automatic, such as driving a standard transmission after years of driving experience, you can easily devote some attention to what your friend is saying. Many tasks, such as driving, become increasingly automatic over time, therefore requiring less and less of our attention (I'll say more about this phenomenon, known as *automaticity*, in Chapter 9). Even so, when people carry on a conversation while driving (say, on a cell phone), they have slower reaction times and are less likely to notice traffic signals (Strayer & Drews, 2007; Strayer & Johnston, 2001). Occasionally, people do become adept at splitting their attention among two complex tasks, but only when they have considerable practice in performing both tasks at the same time, ideally making the execution of one or both of them automatic (Lien, Ruthruff, & Johnston, 2006; Schumacher et al., 2001; Spelke, Hirst, & Neisser, 1976).

Regardless of how we view attention, one thing is clear: People's ability to attend to the stimuli around them is limited, such that they usually can't attend to or otherwise learn from two complex situations at the same time. Thus, learners must be quite selective about the information they choose to process, and they must ignore—and so lose—much of the information they receive.

Attention is closely connected with working memory, although theorists continue to debate *how* closely the two are linked (e.g., Cowan, 2007; Downing, 2000; Woodman, Vogel, & Luck, 2001). As you'll see now, working memory controls attention to some extent, and it, like attention, has a limited capacity.

## Working Memory

Historically, cognitive psychologists typically used the term *short-term memory* (or *short-term store*) to refer to a storage mechanism that holds information for a brief time after it's attended to so that it can be mentally processed. But most theorists now believe that this component of memory is also where cognitive processing itself takes place, hence their more frequent use of the term **working memory**.

In essence, working memory is the component of memory in which active thinking occurs. You might think of it as the “awareness” or “consciousness” of the memory system (e.g., Bellezza,

---

<sup>7</sup>For contemporary analyses of the figure-ground phenomenon, see M. A. Peterson (1994); M. A. Peterson and Gibson (1994); and Vecera, Vogel, and Woodman (2002).

1986; Paller, Voss, & Westerberg, 2009; Reznick, 2007). It identifies information in the sensory register that warrants attention, saves the information for a longer period of time, and processes it further. It may also hold and process information that it retrieves from long-term memory—information that will help in interpreting newly received environmental input.

Many contemporary theorists have suggested that working memory has a subcomponent known as the **central executive** (see Figure 8.1). The central executive is, if you will, the “head of the head,” in that it controls and monitors the flow and use of information throughout the memory system (e.g., Baddeley, 1986, 2001; Banich, 2009; J. H. Bernstein & Waber, 2007). As the brain continues to mature over the course of childhood and adolescence, this central executive function becomes increasingly sophisticated and effective (S. M. Carlson, Davis, & Leach, 2005; Luciana, Conklin, Hooper, & Yarger, 2005; Zelazo, Müller, Frye, & Marcovitch, 2003).<sup>8</sup> Yet even within a particular age-group, learners differ considerably in their central-executive abilities—that is, they differ in how effectively they control what they attend to and in how extensively and effectively they process it (Friedman et al., 2007; Hasher, Zacks, & May, 1999).

### ***Characteristics of Working Memory***

Working memory is quite different from the sensory register in terms of capacity, forms of storage, and duration.

**Capacity** Unlike the sensory register, working memory appears to have a very limited capacity. After reviewing a number of early studies, George Miller (1956) characterized its capacity as the *magical number seven, plus or minus two*: People can hold from five to nine units of information in working memory at one time, with the average number of memorable units being about seven. Although the *number* of information units in working memory can't be increased beyond  $7 \pm 2$ , Miller suggested, the *amount* of information in each unit can be increased. For example, in a discussion of working memory in an undergraduate psychology class, I once asked students to try to remember this string of digits:

5 1 8 9 3 4 2 7 6

Most students remembered somewhere between six and eight digits. A few remembered all nine by clumping them into groups of three like this:

5–1–8 9–3–4 2–7–6

This process of combining pieces of information in some way, called **chunking**, increases the amount of information that the limited space of working memory can hold. To use Miller's analogy, if you can hold only seven coins, you are far richer holding seven quarters, or even seven gold pieces, than seven pennies.

Miller's original assessment of  $7 \pm 2$  appears to be an overly simplistic view of working memory's capacity. The number of items that can be stored depends on how much information each item includes and how strong the associations are within the various “pieces” of each item (Alvarez & Cavanagh, 2004; Baddeley, 2001; Cowan, Chen, & Rouder, 2004). For example, in

---

<sup>8</sup>To a considerable degree, processes associated with working memory and the central executive appear to be located in the frontal lobes of the cortex. For instance, people with damage to their frontal lobes may have trouble controlling attention, planning a course of action, and inhibiting inappropriate responses (Aron, 2008; Baddeley, 2001; Kimberg, D'Esposito, & Farah, 1997; van Veen & Carter, 2006).



examining his own working memory capacity, Simon (1974) found that although he could remember a list of seven 1- or 2-syllable words, he could remember only six 3-syllable words, four 2-word phrases, and even fewer longer phrases. More recently, Cowan (2010) has suggested that young adults can typically keep only about 3 to 5 *meaningful* items (e.g., short sentences) in working memory—a capacity that (playing on a classic Beatles album title) he calls the *magical mystery four*. Ultimately, it may be virtually impossible to pin down the true capacity of working memory, at least in terms of a specific number of discrete items that can be simultaneously held there.

Furthermore, there may be a trade-off between how much processing is necessary and how much information can be held in working memory: Cognitive processing may consume some capacity, leaving less room for information storage. As an example, try to solve the following long-division problem in your head, without referring back to the page until after you’ve solved it:

$$37 \overline{)4281}$$

Almost impossible, isn’t it? You may have found that while you were dividing 37 into 42, you forgot the last two digits of the dividend. Although you probably had no trouble holding six numbers in your working memory, you may not have been able to hold all six while also doing something with them.

An additional point to keep in mind is that working memory capacity seems to differ somewhat from person to person (Cowan, 2010; Kremen et al., 2007). Younger children may have slightly less physical working memory “space” than older children do (Ben-Yehudah & Fiez, 2007; Fry & Hale, 1996; Van Leijenhorst, Crone, & Van der Molen, 2007). And on average, children with chronic learning difficulties appear to have slightly less working memory capacity than their high-achieving peers (Alloway, Gathercole, Kirkwood, & Elliott, 2009; Swanson, Cooney, & O’Shaughnessy, 1998).

**Forms of storage** A good deal of the information stored in working memory is encoded in an *auditory* form, especially when the information is language based (Alloway et al., 2009; Baddeley & Logie, 1992; Cowan, Saults, & Morey, 2006; M. I. Posner & Rothbart, 2007). For example, in an early study by Conrad (1964), adults were shown six-letter sequences, with letters being presented visually, one at a time, at intervals of three-fourths of a second. As soon as the last letter of a sequence had been presented, participants in the study wrote down all six of the letters they’d seen, guessing at any letters they couldn’t easily recall. When people recalled letters incorrectly, the letters they said they had seen were more likely to resemble the actual stimuli in terms of how the letters *sounded* than how they looked. For example, the letter *F* was “remembered” as the auditorially similar letter *S* 131 times but as the visually similar letter *P* only 14 times. Similarly, the letter *V* was remembered as *B* 56 times but as *X* only 5 times.

Yet working memory almost certainly includes ways of encoding information in other forms as well, including visual, spatial, and tactile forms (Cowan et al., 2006; J. A. Harris, Miniussi, Harris, & Diamond, 2002; M. I. Posner & Rothbart, 2007; Serences, Ester, Vogel, & Awh, 2009). As an example of visual–spatial encoding in working memory, look at Object A in Figure 8.4, and then look at Object B. Does B represent the same three-dimensional configuration as A? To answer this question, you must mentally “rotate” B in your head, and, in fact, B rotated 180 degrees is the same as A. Now compare Object C to Object A. If you “rotate” the right side of C down a bit and toward you, you should discover that C is *not* the same as A; instead, it’s a mirror image of A. Shepard and Miller (1971) asked adults to perform a task similar to the one I’ve presented here

**Figure 8.4**  
Example of visual–spatial encoding  
in working memory

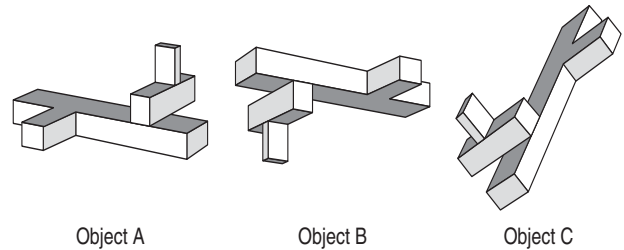

and measured people’s reaction time to each pair of figures. Results were quite dramatic: Reaction times were almost entirely a function of how much a figure would have to be turned for it to be lined up with another figure. In other words, the participants were responding as if they were mentally rotating images, with more rotation resulting in a longer reaction time (also see L. A. Cooper & Shepard, 1973).

Many theorists believe that working memory actually involves two or more separate storage systems that specialize in different sensory modalities (Baddeley, 2001; Schacter, 1999; P. Shah & Miyake, 1996; E. E. Smith, 2000; Willingham, 2004).<sup>9</sup> As an example of these separate storage systems, Alan Baddeley (e.g., 1986, 2001) has suggested that a mechanism he calls a **phonological loop**<sup>10</sup> can keep a small amount of auditory information fresh through constant repetition (more about such repetition shortly). Meanwhile, a **visuospatial sketchpad** allows manipulation and short-term retention of visual material. Presumably, working memory also includes a “place” where information from multiple modalities can be integrated into an overall understanding of a particular situation or episode; Baddeley (2001) calls this component the **episodic buffer**.

Having modality-specific storage mechanisms seems to help us stretch our working memory capacity somewhat. We have an easier time performing two tasks at the same time when one task involves primarily auditory information and the other task is more visual in nature—for instance, when we’re asked simultaneously to judge whether a series of sentences are true or false (an auditory, verbal task) and to perform tasks similar to that in Figure 8.4 (Baddeley, 1999; Just et al., 2001; Schumacher et al., 2001). Even so, people in such situations may not be able to devote the amount of mental energy to each task that they would use if they were doing only one of the tasks (Just et al., 2001).

**Duration** Working memory is just what its alternative name, *short-term memory*, implies: short. An experiment by Peterson and Peterson (1959) gives us some idea of how long information in working memory might last. In this experiment, adults were told three consonant letters (e.g., *D X P*) and then immediately asked to count backward by threes from a 3-digit number, which was different in each trial. At a signal that occurred anywhere from 3 to 18 seconds after

<sup>9</sup>Neurological evidence supports this idea: Tasks involving the processing of verbal, auditory information activate different parts of the brain than do tasks involving the processing of visual and spatial information (Awh et al., 1996; Goldman-Rakic, 1992; Jonides, Lacey, & Nee, 2005; MacAndrew, Klatzky, Fiez, McClelland, & Becker, 2002; Posner & Rothbart, 2007).

<sup>10</sup>In his early writings, Baddeley called this an *articulatory loop*. However, he changed the term to reflect the fact that it involves the *sounds* (phonemes) of speech but doesn’t necessarily involve actual speaking (articulation).

the three consonants had been presented, the participants were asked to recall the consonants. When recall was delayed only 3 seconds, people were able to remember the letters with 80% accuracy; after an 18-second interval, however, their accuracy was only about 10%.

Considering research results such as those of Peterson and Peterson, the duration of working memory appears to be less than 30 seconds, and in many cases may be considerably shorter than this (e.g., W. Zhang & Luck, 2009). As is true for the sensory register, both decay and interference have been offered as explanations for working memory's short time span (Cowan, 2007; Cowan, Wood, Nugent, & Treisman, 1997; J. S. Reitman, 1974). Some information stored in working memory may fade away (i.e., decay) if it isn't processed further. Other information may be replaced by new input—as one of my professors used to say, it's "bumped out." For example, as a woman who for many years had a husband, three children, a dog, and two cats all living in the house, I found myself frequently being interrupted in the middle of tasks. If I had a batch of cookies in the oven, and Jeff asked me to help him get a snack and Tina asked me to help her find something she'd misplaced, my cookies were very likely to be pushed from my working memory until I was confronted with new environmental input: the smell of something burning. My husband called me absentminded, but I knew better. My mind was definitely present, but the working component of it had a limited capacity, and new input interfered with the cookies-in-the-oven information I'd previously stored there.

### ***Control Processes in Working Memory***

Working memory, and especially its central-executive component, appears to be the home of many processes important for learning, thinking, and behavior—for example, directing attention, drawing inferences, making decisions, solving problems, and inhibiting irrelevant thoughts and actions (Aron, 2008; Banich, 2009; S. M. Carlson & Moses, 2001; Demetriou, Christou, Spanoudis, & Platsidou, 2002; R. W. Engle, 2002). For now we'll look at three control processes that affect the functioning of working memory itself: organization, retrieval, and maintenance rehearsal.

**Organization** Sometimes people increase what they can hold in working memory by organizing it in some way—that is, by pulling together two or more pieces of information into an integrated unit. We previously saw an example of such organization in Miller's (1956) concept of *chunking*—for instance, repeating the digit string

5 1 8 9 3 4 2 7 6

as three 3-digit chunks: 5–1–8, 9–3–4, and 2–7–6. Another common organizational strategy is to impose a rhythm or melody on the numbers (G. H. Bower & Springston, 1970). Still another way of organizing the digits is to attach some meaning to them—a process that involves retrieving information that's previously been stored in long-term memory. For instance, when I presented the 9-digit string to an undergraduate class, a varsity football player named Dave remembered all nine digits easily and claimed he could have added a few more to the list without difficulty. He explained his approach this way:

Well, "51" is Jason, a guy who played center during my freshman year. "89" is Jeff, a wide receiver from my roommate's hometown. "34" is John, a current running back on my team—well, his number has changed, but I always think of him as "34." "2" is another Dave (not me), who's a wide receiver. And "76" is my good friend Dan. My number is 75, and so Dan's locker is next to mine.

By attaching meaning to the numbers, Dave also facilitated their storage in long-term memory. In Chapter 9, we'll look at such *meaningful learning* more closely.

**Retrieval** Retrieving information from working memory is often quite easy and automatic. Yet to some degree, how quickly and easily something is retrieved depends on how much information is stored there. For example, in one early study (S. Sternberg, 1966), college students were given a set of from one to six numbers, which the students presumably stored in working memory. Then an additional number was presented, and the students were asked whether that number had been among the original set. The time it took for students to answer the question depended almost entirely on the size of the number set already stored in working memory, with each successively larger set yielding a reaction time of about 40 milliseconds longer. From such results, it appears that retrieval of information from working memory may sometimes be a process of scanning all of working memory's contents, successively and exhaustively, until the desired information is found (also see J. G. Thomas, Milner, & Haberlandt, 2003).

**Maintenance rehearsal** Imagine that you need to call a neighbor, so you look up the neighbor's number in the telephone book. Because you've paid attention to the number, it's presumably in your working memory. But then you discover that you can't find your cell phone. You have no paper and pencil handy. What do you do to remember the number until you have access to a telephone? If you're like most people, you probably repeat it to yourself over and over again.

Repeating information to keep it alive in working memory is a process known as **maintenance rehearsal**, which often takes the form of subvocal speech (Baddeley, 2001; Landauer, 1962; Sperling, 1967). Maintenance rehearsal provides a means for saving information from the forgetting processes of decay and interference; when such rehearsal isn't possible, information in working memory quickly disappears. As an example, recall Peterson and Peterson's (1959) examination of the duration of working memory described earlier. After participants in the experiment were given the three consonants they needed to remember, they were asked to count backward by threes until the signal for recall. Such backward counting kept them from rehearsing the three letters; otherwise, they might have kept them in working memory indefinitely simply by repeating them over and over as long as necessary.

There's apparently an upper limit to the amount of information people can keep in working memory simply through repetition, and this upper limit reflects how much can be repeated before some of it starts to fade (Baddeley, 1999). As an illustration, try remembering the following two lists of words. After reading the words in List 1 once or twice, cover the page and rehearse the words until you've written them all down on a piece of scrap paper:

**List 1:** beg, far, hum, late, kick, wheel

Now try the same thing with the following words:

**List 2:** caterpillar, university, ostentatious, alimony, calamity, interrogation

Each list has six items, but you probably found the first list easier to remember than the second because the words were shorter and so you could repeat them all fairly quickly. In contrast, you may have found that the words in the second list each took so long to pronounce that by the time you got to the end of the list, one or two of the early words were starting to fade away. This phenomenon—being able to remember a greater number of short items than longer items—is known as the *word length effect* (e.g., Baddeley, 2001). Here's where Baddeley's concept of

*phonological loop* comes into play. Baddeley likens the phenomenon to the circus performer who tries to spin a number of plates at the same time: Just as the performer must periodically return to each plate to keep it spinning, so, too, must a learner frequently return to and repeat each word to keep it fresh in memory. In both cases, there's an upper limit to the number of items that can simultaneously be kept active.

Maintenance rehearsal is observed more frequently in older children and adults than in younger children (Bjorklund & Coyle, 1995; Cowan et al., 2006; Gathercole & Hitch, 1993), so to some degree it's probably a learned skill. I myself often used rehearsal in high school and college whenever I had trouble remembering something I might be tested on—perhaps when I needed to know a complicated formula, verbatim definition, or list of seemingly unrelated items. I would continue to repeat the information to myself as test papers were distributed, then immediately write it in the margin so it would be there for me if I needed it.

Although maintenance rehearsal can indeed be a useful strategy for keeping information in working memory, teachers must remember that the information will disappear once rehearsal stops. If students are regularly using maintenance rehearsal to help them remember tidbits of academic subject matter, one might reasonably suspect that they're having trouble storing those tidbits in their long-term memories. Yet long-term memory is where important information ultimately *should* be stored.

## Moving Information to Long-Term Memory: Connecting New Information with Prior Knowledge

Storage processes in the first two components of memory are fairly straightforward: Anything sensed is presumably stored in the sensory register, and anything attended to is stored in working memory. Storage of information in long-term memory isn't so simple. A dual-store model of memory tells us that further processing is necessary for information to go from working memory to long-term memory, and typically such processing involves combining new information with information already in long-term memory (note the two-way arrow between working and long-term memory in Figure 8.1). In other words, people store information in long-term memory most successfully when they relate it to things they already know (more on this point in Chapter 9).

From the dual-store perspective, control processes that enable storage in long-term memory take place in working memory. As we've seen, working memory has a limited capacity and can handle only so much information at one time. The result is that long-term memory storage occurs slowly, and a great deal of information is lost in the process. In essence, working memory is the bottleneck in the memory system: It prevents most information from ever getting into long-term memory.

## Long-Term Memory

**Long-term memory** is perhaps the most complex component of the human memory system. As such, it has been studied more extensively than either the sensory register or working memory, and psychologists have offered numerous theories about its nature. I'll give you an overview of it here and then describe its characteristics and relevant control processes in more depth in the following three chapters.

### ***Characteristics of Long-Term Memory***

Much of the content of long-term memory relates to the nature of *how things are, were, or will be*—knowledge often referred to as **declarative knowledge**. But it also includes knowledge about *how to do things*—knowledge known as **procedural knowledge** (e.g., J. R. Anderson, 1983a, 1995). Its capacity is obviously much larger than that of working memory, its forms of storage appear to be more flexible, and its duration is, of course, quite a bit longer.

**Capacity** As far as theorists can determine, the capacity of long-term memory is unlimited. In fact, as you'll discover in Chapter 9, the more information that's already stored there, the easier it is to store additional information.

**Forms of storage** Information is probably encoded in long-term memory in a variety of ways. For example, language provides one basis for storing information, sensory images provide another, and nonverbal abstractions and meanings—general understandings of the world, if you will—provide still another. Over the long run, people rarely save information in the precise ways they encountered it in the environment. Rather than remember word-for-word sentences or precise mental images, people tend to remember the gist of what they see and hear, along with idiosyncratic interpretations and (often) minor or major distortions of reality.

Some of the knowledge in long-term memory is **explicit knowledge**, such that people can easily recall and explain it. But a great deal of it is, instead, **implicit knowledge** that affects people's behavior even though they can't consciously retrieve and inspect it. We'll look closely at the nature of both explicit and implicit knowledge—as well as at the nature of both declarative and procedural knowledge—in Chapter 10.

Another noteworthy characteristic of information in long-term memory is its *interconnectedness*: Related pieces tend to be associated together. Virtually every piece of information in long-term memory is probably directly or indirectly connected with every other piece.<sup>11</sup>

**Duration** As you'll learn in Chapter 11, theorists disagree regarding the duration of long-term memory. Some theorists believe that once information is stored in long-term memory, it remains permanently, and thus any “forgetting” is simply a *retrieval* problem. In contrast, others believe that information can disappear from long-term memory through a variety of forgetting processes—processes that may or may not kick in depending on how the information was initially stored and how often it's used. Ultimately, although some information may remain in long-term memory for long periods, there's probably no way to show conclusively that *all* information stored there remains permanently. The question about the duration of long-term memory is still an open one, and the best we can say is that long-term memory's duration is indefinitely *long*.

Speaking of retrieval from long-term memory, what was Edward C. Tolman's middle name? Did you perhaps remember your friend Harry's brother-in-law, Marvin *Chace*? Or did you think of Tolman *chacing* his rats down their mazes? As you'll discover in Chapter 11, the more ways that people store a piece of information in long-term memory, the better their chances of retrieving the information when they need it.

---

<sup>11</sup>As you should recall from Chapter 2, most neurons in the brain have synaptic connections with hundreds of other neurons. Presumably many of these synapses account for the organized nature of long-term memory.

## CHALLENGES TO THE DUAL-STORE MODEL

---

Up to this point, we've been talking about the dual-store (three-component) model of memory almost as if it were Ultimate Truth. But not all psychologists agree that this model accurately represents how human memory functions. I myself sometimes wonder whether the three components are the distinctly different entities that the model portrays. For example, recall my earlier point that auditory information in the sensory store typically lasts for 2 or more seconds. Also recall how Baddeley's *phonological loop* can maintain a list of spoken words in working memory only to the extent that the list is short and consists of quickly pronounceable words—a list that can be repeated in, say, 2 to 4 seconds. In fact, Baddeley (2001) has suggested that auditory information stored in working memory tends to last only about 2 seconds unless it's rehearsed. It's possible, then, that maintenance rehearsal may in some cases act on and maintain information that's actually in a sensory-register type of mechanism.

Furthermore, a number of theorists have argued that working memory and long-term memory are actually different aspects of a *single* (rather than dual) storage mechanism. Others have challenged a related idea: that active, conscious processing in working memory is really necessary for storage in long-term memory. We now look at some of the evidence related to each of these issues.

### Are Working Memory and Long-Term Memory Really Different?

Let's return to the serial learning curve described in the Chapter 7. Given a list of items to remember, people can more easily recall the first few items in the list (the *primacy effect*) and the last few items (the *recency effect*) than the middle items (to refresh your memory, look once again at Figure 7.8). Using a dual-store model of memory to explain this curve (e.g., Norman, 1969), we might say that people process the first few items sufficiently to store them in long-term memory, and they continue to hold the last few items in working memory after the entire list has been presented. They lose many of the middle items because they don't have enough time to process them adequately before later items "bump them out" of working memory. Supporting this interpretation is the finding that when presentation rate is slowed down (allowing for more processing in working memory), the primacy effect increases, and when processing is prevented, the primacy effect disappears (Glanzer & Cunitz, 1966; L. R. Peterson & Peterson, 1962). In contrast, the recency effect seems to be more affected by the recall interval: The longer that recall of the list is delayed—decreasing the likelihood that any items are still in working memory—the less people are able to remember items at the end of the list (Glanzer & Cunitz, 1966; Horn, 2008; Postman & Phillips, 1965).

Yet other research studies have cast doubt on the idea that the recency effect necessarily reflects the use of a working memory separate from long-term memory (R. G. Crowder, 1993; R. L. Greene, 1986; Öztekin, Davachi, & McElree, 2010; Wickelgren, 1973). For example, in a study by Thapar and Greene (1993), college students viewed a series of words presented two at a time on a computer screen; they also performed a 20-second distractor task (mentally adding a series of digits) after each pair of words. The students remembered the last few words in the list much better than the middle words, even though—thanks to the distractor task—*none* of the words could possibly have still been in working memory. Considering results such as these, theorists have suggested that the serial learning curve can be explained as easily by a single-store model as by a dual-store model. One possible explanation is that items in a list are easier to remember if they're distinctive in some way. Items near the end of the list might be more memorable

because of their positions: A learner may specifically identify a word as “the last one” or “the next-to-last one” (R. L. Greene, 1986; Unsworth, Heitz, & Parks, 2008; R. K. Wagner, 1996). A second possibility is simply that forgetting occurs rapidly at first and then slowly tapers off—a pattern that has been observed for many different species and many different tasks (J. R. Anderson, 1995; Wickelgren, 1973; Wixted & Ebbesen, 1991). From this perspective, the recency effect may be the result of the fact that the last items of a list haven’t yet undergone that rapid decay.

Another source of evidence that’s been used to support the dual-store model is the finding that encoding seems to be somewhat different in working memory versus long-term memory, with the former being heavily dependent on verbatim auditory encoding and latter being more likely to involve gist and general meanings that are often nonverbal in nature. Yet forms of encoding in the two components overlap quite a bit. For instance, information in working memory sometimes takes the form of general meanings (Shulman, 1971, 1972), and information in long-term memory sometimes takes an acoustic form (Intons-Peterson, Russell, & Dressel, 1992; T. O. Nelson & Rothbart, 1972; Reisberg, 1992). Furthermore, even the initial encoding of information (which presumably takes place in working memory) often draws on knowledge in long-term memory right from the get-go (P. A. Kirschner, Sweller, & Clark, 2006). For example, people recognize words in print more quickly when the words are embedded in a meaningful context (Rayner, Foorman, Perfetti, Pesetsky, & Seidenberg, 2001). And they recognize spoken words much more quickly when the words are common ones they use every day (R. K. Wagner, 1996).

Still another body of evidence that has been used on both sides of the debate comes from people who have undergone certain brain injuries or neurosurgical procedures. Sometimes these individuals show an impairment of one kind of memory without a corresponding loss of function in the other (R. C. Atkinson & Shiffrin, 1968; Eysenck & Keane, 1990; R. K. Wagner, 1996; Zechmeister & Nyberg, 1982). Some individuals can recall events experienced before a brain trauma but are unable to retain new experiences. Such a disability may suggest either (1) a problem with working memory while long-term memory remains intact (a dual-store explanation) or (2) a problem in general storage processes (a single-store explanation). Other individuals with brain injuries can recall new experiences long enough to talk briefly about them but can’t remember them a few minutes later or at any point thereafter. These might be cases in which (1) working memory is functioning but new information seemingly cannot be transferred into long-term memory (a dual-store explanation) or (2) general retrieval processes have been impaired (a single-store explanation).

To some degree, working memory and long-term memory processes seem to depend on different parts of the brain (Nee, Berman, Moore, & Jonides, 2008; Zola-Morgan & Squire, 1990). And different areas of the brain are active when people are trying to recall items from the beginning versus end of a serial list (Talmi, Grady, Goshen-Gottstein, & Moscovitch, 2005). Even so, as noted in Chapter 2, most learning and thinking tasks—even very simple ones—tend to involve *many* parts of the brain. Certainly different parts of the brain specialize in different tasks, but a human learner is likely to rely on many parts regardless of the learning or memory task at hand (e.g., Nee et al., 2008).

## Is Conscious Thought Necessary for Long-Term Memory Storage?

In the dual-store model, information must go through working memory before it can be stored in long-term memory. Working memory is, by definition, an active, conscious mechanism. It would seem, then, that a learner would have to be actively involved in storing virtually anything in long-term memory. This isn’t always the case, however. Some kinds of information—once they’ve captured a person’s attention—seem to be automatically stored in long-term memory



even if not specifically selected for further processing (Frensch & R nger, 2003; Zacks, Hasher, & Hock, 1986). For example, consider this question:

Which word occurs more frequently in English—*bacon* or *pastrami*?

You probably had no difficulty answering correctly that *bacon* is the more frequently occurring word. Hasher and Zacks (1984) found that people could easily answer such questions about the frequency of events even though they'd never been concerned about counting them. Similarly, people could answer questions about where various events occurred without having intentionally processed this information. Such automatic storage of frequency information and locations begins quite early in life and may help to establish a knowledge base on which future learning can build (Siegler & Alibali, 2005).

Much of this seemingly nonconsciously processed information becomes implicit (rather than explicit) knowledge. Quite possibly, the brain learns—and stores information in long-term memory—in at least two distinctly different ways. One is a very conscious way in which working memory plays an active role. Another is a more basic, “thoughtless” way that involves formation of simple stimulus–stimulus and stimulus–response associations similar to those of which behaviorists speak (Bachevalier, Malkova, & Beaugard, 1996; Frensch & R nger, 2003; D. J. Siegel, 1999).

Complicating the picture even further is the possibility that thinking itself may sometimes occur outside the confines of working memory. A series of studies by Dijksterhuis, Nordgren, and their colleagues indicates that complex problems—those involving far more information than working memory's limited capacity can handle—are often more effectively addressed when people don't actively think about them for a period of time (Dijksterhuis & Nordgren, 2006; Strick, Dijksterhuis, & van Baaren, 2010). Even when not consciously mulling over a complex problem, these researchers suggest, people may be slowly analyzing the problem, determining which aspects of the problem are more and less important to take into account, imprecisely estimating particular quantities, and integrating problem-relevant information into an overall summary. The result is that a complex problem is sometimes better solved when it remains outside of working memory's limited-capacity limelight for a while. The products of such nonconscious thinking are often implicit and hard to put a finger on. For instance, people might describe them as “intuition” or a “gut feeling” that they can't easily explain (Dijksterhuis & Nordgren, 2006, p. 105; also see Bargh & Morsella, 2008).

## ALTERNATIVE VIEWS OF HUMAN MEMORY

---

In attempts to address weaknesses of the dual-store model, some theorists have offered alternative models. Here we'll look at two of them: a levels-of-processing model and an activation model. Both of these theories emphasize cognitive processes involved in human memory rather than the possible structures that may comprise it.

### Levels of Processing

The **levels-of-processing** model of human memory (Cermak & Craik, 1979; Craik & Lockhart, 1972) was the first major theoretical alternative to the dual-store model. According to this view, incoming information is processed by a *central processor* (similar to the central-executive aspect of working memory I spoke of earlier) at any one of a number of different levels of complexity. This central processor has a limited capacity, in that it can hold only so much at one time; the information temporarily held there is what we're aware of at any given time.

How long and how well information is remembered depends on how thoroughly the central processor deals with it. Information that isn't processed at all leaves only a very brief impression, much as it does in the sensory register of the dual-store model. Information that is processed superficially, with attention only to surface characteristics (e.g., appearance, brightness), lasts a bit longer—perhaps as long as information lasts in the dual-store model's working memory. We're far more likely to remember information for the long haul if it undergoes "deep" processing—that is, if we interpret it and relate it to our previous knowledge (e.g., S. Kapur et al., 1994).

An experiment by Turnure, Buium, and Thurlow (1976) illustrates how different levels of processing lead to different degrees of information recall. Children who were 4 or 5 years old were asked to remember pairs of common objects (e.g., remembering that *soap* and *jacket* go together). Children processed the information in one of five ways, as follows:

1. *Labels*. They repeated the names of the objects.
2. *Sentence generation*. They made up sentences that included both objects in a pair.
3. *Sentence repetition*. They repeated experimenter-generated sentences that stated a relationship between the two objects (e.g., "The soap is hiding in the jacket").
4. *"What" question*. They answered a question about a relationship between the objects (e.g., "What is the soap doing in the jacket?").
5. *"Why" question*. They answered a question concerning why a particular relationship existed between the objects (e.g., "Why is the soap hiding in the jacket?").

In this experiment, children learned most effectively when they were required to think about a relationship between the objects: The question-answering conditions (Conditions 4 and 5) led to the greatest recall of the word pairs. Repeating a sentence that expressed such a relationship (Condition 3) led to some recall; presumably repetition promoted some processing of the association between each pair. Least effective for learning were the first two conditions. In the labeling condition (Condition 1), no relationship between objects was processed, and children in the sentence-generation condition (Condition 2) often constructed sentences that didn't effectively connect the two objects (e.g., "I have some soap and a jacket").

One element that frequently arises as an important factor in learning is **intention to learn**: People who intend to learn something are more likely to learn and remember it than people who don't specifically try to learn it. Proponents of the levels-of-processing model have argued that people process information more thoroughly when they're intending to learn it, but it's the *depth* of processing—rather than intention to learn per se—that affects learning success. In fact, research supports this point: When individuals process material deeply, they often learn it successfully even when they aren't specifically *trying* to learn it (e.g., Postman, 1964). In other words, nonintentional learning—often called **incidental learning**—is just as effective as intentional learning if the degree of processing is equal in the two situations.

A study by Hyde and Jenkins (1969) provides an example of successful incidental learning as a result of deep processing. College students were shown 24 words presented at a rate of one word every 2 seconds. Some students (a control group) were told only to learn the words; thus, they would presumably engage in intentional learning. Various experimental groups received one of three kinds of instructions, as follows:

1. *Pleasantness rating*. Students were told to rate each word for its degree of pleasantness; for example, a word such as *love* might be rated as relatively pleasant, whereas *hate* might be rated as less pleasant.

2. *Counting letters.* Students were told to count the number of letters in each word.
3. *Counting letter Es.* Students were told to count the number of letter *Es* in each word.

At the same time, some of the students in the experimental groups were told to learn the words as they went along—that is, they were instructed to engage in intentional learning. Others weren't told to learn the words; for these students, any recall of the words would presumably be the result of incidental learning.

Hyde and Jenkins's various tasks should lead to different levels of processing. In counting all letters or the frequency of *Es* in a word, a learner would need to look only at superficial characteristics and wouldn't have to interpret the word's meaning; thus, a counting task should lead to relatively shallow processing. In rating a word's pleasantness, however, the learner must examine the word's meaning—hence leading to deeper, semantic processing. Consistent with levels-of-processing theory, students who rated words for pleasantness remembered more words than students who counted letters. More interesting, however, is the fact that incidental-learning students who rated the words for pleasantness generally remembered as many words as any of the intentional-learning groups (in fact, they did *better* than the intentional-counting groups). Here was a case where learning was facilitated simply by virtue of the fact that students had to focus on the underlying meaning of the material to be learned. Depth of processing—not intention to learn—was the critical factor affecting learning.

The levels-of-processing model has certainly had its impact on psychologists' conceptualizations of learning and memory; for instance, I often see learning theorists writing about processing information “deeply” or in a more “shallow” manner. Nevertheless, weaknesses of this approach have surfaced. For one thing, the idea of *depth* of processing is a vague notion that's difficult to define or measure in precise terms (Baddeley, 1978; Willingham, 2004). Furthermore, some research indicates that degree of learning isn't always a function of the degree of processing in the way that the model predicts. For instance, the more frequently information is repeated, the better it can be remembered *regardless* of the depth of processing it has undergone (T. O. Nelson, 1977). But even more damaging is the finding that, in some cases, superficial processing actually leads to *better* recall than deeper processing. In an experiment by Morris, Bransford, and Franks (1977), college students were given a series of words and asked (1) whether each word fit appropriately into a sentence (a task involving “deep” semantic processing) or (2) whether the word rhymed with another word (a task involving “superficial” phonetic processing). When students were later given an unexpected recall test, they recalled more words if they had processed them semantically; however, the students were more successful at identifying rhymes of the original words if they had processed them phonetically (also see Stein, 1978).

Quite possibly the key to learning and more successful recall is to process new information not only semantically but also *elaboratively*—that is, a learner embellishes on new material in such a way that the material is encoded more precisely, meaningfully, and completely ( Craik & Tulving, 1975). We'll examine the process of elaboration in more detail in Chapter 9.

## Activation

Some theorists have proposed that working memory and long-term memory are, in reality, different **activation** states of a single memory (e.g., J. R. Anderson, 2005; Campo et al., 2005; A. M. Collins & Loftus, 1975; Nee et al., 2008). From this perspective, all information stored in memory is in either an active or an inactive state. Information that is currently active, which may

The author activates part of her memory.

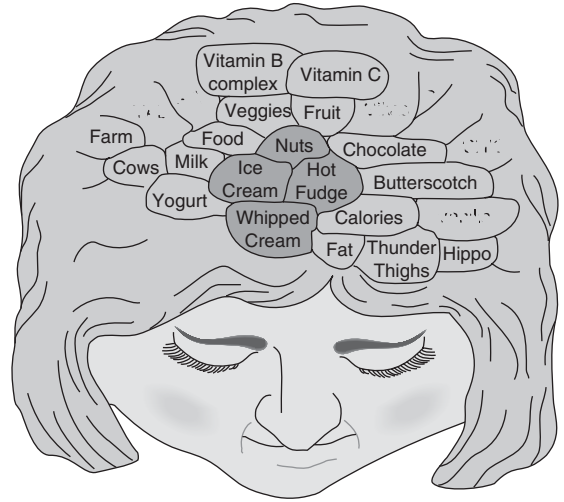

include both new information and previously stored information, is whatever a learner is paying attention to and processing—this is information I’ve previously described as being in working memory. As attention shifts, other pieces of information in memory become activated, and the previously activated information gradually becomes inactive. The bulk of the information stored in memory is in an inactive state, so that we aren’t consciously aware of it—I’ve previously described this information as being in long-term memory.

A key idea in this perspective is that activation almost invariably spreads from one piece of information to associated pieces. As evidence, theorists point to a phenomenon called **priming**. A study by Ratcliff and McKoon (1981) provides an illustration. College students first studied a series of sentences (e.g., *The doctor hated the book*). After the students knew the sentences well, they were shown a number of nouns, one at a time, and asked to identify those nouns that had appeared in the sentences they’d learned. Sometimes the nouns were immediately preceded by another noun from the same sentence (e.g., they might see *book* right after seeing *doctor*); when such was the case, the students correctly indicated having seen the second noun significantly faster than they would have otherwise. It was as if presentation of the first noun activated memories associated with that noun and so made those other memories more readily available. That is, activation of one noun stimulated, or *primed*, activation of the second.

Increasingly I’m seeing the term *activation* in discussions of working memory and long-term memory in psychological and neuropsychological research, so this perspective is clearly gaining popularity (e.g., Öztekin et al., 2010; Vallet, Brunel, & Versace, 2010; Was, 2010). Furthermore, activation theory is quite useful in understanding how people retrieve information from long-term memory. Accordingly, we’ll encounter it again in later chapters, and especially in Chapter 11.

## REMEMBERING THAT *THE MAP IS NOT THE TERRITORY*

After writing the earlier section on “Challenges to the Dual-Store Model,” I took a short coffee break to sweep my working memory clean of the difficult ideas I’d been wrestling with. (I often do this during a writing project—I call it “letting the mental dust settle”—and find that it helps

me write more clearly.) My husband was in the kitchen as I was brewing my coffee, and so I mentioned my consternation about how so many research results don't fit easily into any single model of human memory.

His response was a helpful one: "The map is not the territory." As a geographer, he was partly telling me that no single map can completely or accurately represent the physical terrain it depicts. But he was also telling me—as was Alfred Korzybski, with whom the expression originated (e.g., Korzybski, 1933)—that no single human abstraction can entirely and truthfully represent its counterpart in reality. By their very nature, human abstractions are meant to *simplify* an aspect of life—to make it more understandable and manageable.

So it is with the dual-store model of memory—and with any other model of memory, for that matter. Concepts such as working memory and long-term memory help us explain many of the phenomena we see in everyday human performance, and thus psychologists continue to use them. We, too, will continue to use these concepts throughout the book, and you'll find them to be extremely useful in summarizing much—but not all—of what we know about human thinking and learning.

## GENERALIZATIONS ABOUT MEMORY AND THEIR EDUCATIONAL IMPLICATIONS

---

Clearly, theorists don't entirely agree about how memory is structured or how it functions. But regardless of how we conceptualize the human memory system, we can make several generalizations about how it operates:

- ◆ *Attention is essential for explicit memory.* Regardless of which model of memory we use, we know that attention is critical for long-term retention of information—at least for information we can *consciously* recall. Sometimes attention to a particular stimulus is all that's needed. In other cases (e.g., when reading a textbook) attention to a particular *part* of the stimulus is important. In general, people *won't* explicitly remember things they don't process in some way, and paying attention is the first step they must take.

There's an old saying, "You can lead a horse to water, but you can't make him drink." Ormrod's corollary is "The horse can't possibly drink if you don't at least lead him to the water." Helping students focus their attention on important information is the first step in helping them learn it: It gets them to the water trough.

Classrooms are usually lively environments with many stimuli competing for students' attention. For example, think of yourself in one of your college classes. Sometimes you pay attention to what the teacher is saying, but at other times your attention drifts to such things as the instructor's irritating mannerisms, the style of another student's clothes, the doodles in your notebook, or the plans you've made for the weekend. Mind-wandering is a common phenomenon in adults as well as children (Delaney, Sahakyan, Kelley, & Zimmerman, 2010; Kane et al., 2007; Marcus, 2008). If adults can't pay attention during every minute of a class session, how can we reasonably expect younger learners to do so?

Actually, the things teachers do in the classroom make a big difference in the extent to which students pay attention to the topic at hand. Following are several effective strategies for capturing and holding students' attention:

- *Include variety in topics and presentation styles.* Repetition of the same topics and the same procedures day after day can lead to boredom and reduced attention (Pekrun, Goetz, Daniels, Stupnisky, & Perry, 2010; Zirin, 1974). Variety and novelty in topics and modes

of presentation will help keep students' attention focused on a lesson (Ainley, 2006; Berlyne, 1960; Krapp, Hidi, & Renninger, 1992).

- *Provide frequent breaks from tasks requiring considerable attention and concentration.* After prolonged periods of sitting quietly and attentively, even adults can become restless and distracted. Frequent breaks are especially important for students in the early and middle elementary grades and for students with chronic attention problems (Pellegrini & Bohn, 2005; Pfiffner, Barkley, & DuPaul, 2006).
  - *Ask questions.* Questions are an excellent way to maintain students' attention when it might otherwise wander off (L. L. Davis & O'Neill, 2004; Grabe, 1986; Marmolejo, Wilder, & Bradley, 2004). By periodically asking questions in class—perhaps by occasionally addressing questions to particular students, or perhaps by requiring everyone to answer with hand votes or preprinted *true* and *false* response cards—teachers can help students keep their attention where it should be (Lambert, Cartledge, Heward, & Lo, 2006; Munro & Stephenson, 2009). And by giving students questions they should try to answer as they read a textbook, teachers are likely to increase students' learning of content related to those questions (Ku, Chan, Wu, & Chen, 2008; McCrudden, Magliano, & Schraw, 2010; McCrudden, Schraw, & Kambe, 2005). (We'll consider additional benefits of teacher questions in Chapters 10 and 11.)
  - *Minimize distractions when independent work is assigned.* Many students—younger ones especially—are better able to concentrate on challenging independent assignments when their work environment is relatively quiet and subdued (Higgins & Turnure, 1984; Pfiffner et al., 2006).
  - *Seat students near the teacher if they have trouble staying on task.* Students are more likely to pay attention when they sit near their teacher. Such seating may be especially appropriate for students with a history of being easily distracted (Doyle, 1986; Pfiffner et al., 2006; Schwebel & Cherlin, 1972).
  - *Monitor students' behaviors.* Behaviors often provide a clue to whether students are paying attention. For example, students should be directing their eyes at the teacher, textbook, or other appropriate stimulus and should be clearly working on the task at hand (Grabe, 1986; Piontkowski & Calfee, 1979; Samuels & Turnure, 1974).
- ♦ *Learners can process only a limited amount of information at a time.* We've characterized both attention and the “working” aspect of memory as having a limited capacity; in other words, people can pay attention to and think about only a small amount of information at any one time. Educators must remember this point in pacing lectures and in choosing or creating instructional materials. When too much information is presented too fast, students simply won't be able to remember it all (F. Kirschner, Paas, & Kirschner, 2009; Mayer, 2010a; van Merriënboer & Sweller, 2005).
- ♦ *Learners must be selective about what they choose to study and learn.* Despite teachers' best intentions, students frequently encounter much more information in class than they can possibly process and remember (Brophy, 2008; Calfee, 1981; E. D. Gagné, 1985). For instance, teachers and textbooks often provide many details in order to illustrate, clarify, and elaborate on a lesson's main points. A few details can be quite helpful as students work to make sense of what they've been studying. But when confronted with many, many details, students must select some of them to the exclusion of others, and they aren't always the best judges of what things they should focus on. It's important, then, to help students sort through essential and nonessential information so that they don't lose sight of the forest because of the trees.

♦ *Even with attention-getting and appropriately paced instruction and activities, learners differ in their ability to control what they attend to and consciously think about.* As noted earlier, working memory—especially its central-executive component—is a key player in guiding attention and thinking processes, and some learners have better central-executive skills than others. Fortunately, many of these skills can be *taught*, as we’ll see in our discussion of self-regulated learning in Chapter 14.

♦ *The limited capacity of working memory isn’t necessarily a bad thing.* The working memory bottleneck forces learners to condense, organize, and synthesize the information they receive (e.g., Cowan, 2010; R. M. Gagné & Driscoll, 1988). These processes may be in learners’ best interest over the long run, as you’ll discover in the next chapter.

---

## SUMMARY

Many cognitive theorists, especially those with an information processing bent, distinguish between *learning* (acquiring new information) and *memory* (saving information for a period of time); occasionally, they also use *memory* in reference to a particular “place” (metaphorically speaking) where information is saved. Some information processing terminology is borrowed from computer lingo: *Storage* means “putting” information in memory, *encoding* involves changing information to store it more effectively, and *retrieval* is the process of “finding” information that was stored at an earlier time.

Currently the most prevalent view of human memory—a *dual-store model*—maintains that memory has three distinct components. The first component, the *sensory register*, holds virtually all incoming information for a very short time (a few seconds or less, depending on the modality). If the information held in the sensory register isn’t processed in some fashion—at a minimum, by being paid attention to—it may disappear from the memory system.

Information that is attended to moves on to *working memory* (also called short-term memory), where it’s actively processed; in essence, working memory is the “thinking” center of the memory system. Working memory has a limited capacity; for example, most people can hold no more than five to nine digits there at a single time. Furthermore, information stored in working memory typically lasts for less than half a minute unless it’s processed further.

Information that undergoes additional processing (e.g., integration with previously stored information)

moves on to the third component—*long-term memory*. Long-term memory appears to have the capacity to hold a great deal of information for a relatively long time.

Not all cognitive theorists believe that human memory has the three distinct components just described. Furthermore, some research evidence suggests that conscious processing in some sort of “working memory” isn’t always necessary for learning to occur. Accordingly, some psychologists have offered alternative views of human memory, perhaps focusing on *depth of processing* as an important factor affecting learning or perhaps suggesting that memory is one large entity of which only a tiny portion is *activated* at a time. Nevertheless, the dual-store (three-component) model effectively accounts for many research results and so continues to be a popular mechanism for helping us understand the nature of human memory.

Despite the differing perspectives of memory that currently exist, we can make a few generalizations about memory that have implications for classroom practice. For one thing, teachers must make sure that students are actively attending to classroom subject matter and, more specifically, to important parts of that material. Also, teachers must recognize that learners can process only a limited amount of information at a time. The processing bottleneck of the memory system isn’t necessarily a bad thing; it forces learners to condense and integrate information in ways that are often beneficial over the long run.

# LONG-TERM MEMORY I: STORAGE AND ENCODING

### *Construction in Storage*

*Examples of Construction in Action*

### *Long-Term Memory Storage Processes*

*Selection*

*Rehearsal*

*Meaningful Learning*

*Internal Organization*

*Elaboration*

*Visual Imagery*

*How Procedural Knowledge Is Acquired*

*Does New Knowledge Require a Consolidation  
Period?*

### *Factors Affecting Long-Term Memory Storage*

*Working Memory*

*Prior Knowledge*

*Prior Misconceptions*

*Expectations*

*Verbalization*

*Enactment*

*Repetition and Review*

*Promoting Effective Storage Processes*

*Some Final Remarks about Long-Term Memory Storage*

*Summary*

In my many years of college teaching, I've sometimes had students approach me after receiving a low score on one of my exams. "I studied so *hard!*" a student might whine, displaying a look of frustrated desperation. "I studied twice as long as my roommate did, yet my roommate got an A and I got a C-!"

Storing information in long-term memory and retrieving it later can be a tricky business. If two roommates are equally motivated to achieve in my class, the difference between them may be the result of their storage and retrieval processes. After more than 30 years of talking with college students about how they typically study, I've come to the conclusion that many are sadly uninformed about how best to learn and remember information.

Even when students effectively store information in their long-term memories, they don't always learn what their teachers *think* they're learning. For example, when my daughter Tina was in fourth grade, she came home one day complaining about a song she was learning in the school choir. "It has bad words in it, Mom," she told me. I was quite surprised to learn that she was talking about "America the Beautiful," but then she recited the guilty line from the second verse:

All the bastard cities gleam.

After shuddering at the richness of my daughter's vocabulary, I patiently explained that the line in question was actually "Alabaster cities gleam." Two weeks later, the rest of the family went to hear Tina's choir performing in concert. As the children began to sing "America the Beautiful," 6-year-old Alex turned to me and whispered, "Why are they singing about *spaceship* skies?"

Long-term memory provides a mechanism for saving information over a relatively long time period. It also provides a knowledge base from which to interpret new information. As we'll see, people frequently store incoming information in long-term memory by relating it to things they already know—that is, to things already in long-term memory. Various people often store the same information differently, then, because their existing knowledge bases are different. Alex had



never heard the word *spacious* before, but *spaceship* was a frequent word in his world of science fiction cartoons. Similarly, Tina was unfamiliar with *alabaster*, but . . . well, you get my drift.

In this chapter, we'll explore the multifaceted nature of long-term memory storage. After first considering the constructive nature of storage, we'll examine cognitive processes and other factors that influence the effectiveness of long-term memory storage. We'll then identify strategies for promoting effective long-term memory storage in instructional settings. In the two subsequent chapters, we'll look at the nature of the knowledge that accumulates in long-term memory and at the processes involved in retrieving it at a future time.

## CONSTRUCTION IN STORAGE

---

Imagine, for a minute, that your mind worked like a video camera, such that you recorded everything you saw and heard. Your memory of an event would involve a simple process of finding and replaying the appropriate video, and you would be able to remember the event as completely and accurately as if you were reliving it. Studying for an exam would be easy, you might think—no need for reading the textbook more than once or for mindless repetition of meaningless facts.

Unfortunately, our minds aren't accurate recorders of life events. As we discovered in the preceding chapter, we can process only a small amount of information in working memory at any one time, and so we quickly lose most of what we've stored in our sensory registers. In a manner of speaking, most of the information we receive from the environment goes in one ear (or eye) and out the other. In part because we retain such a small percentage of the information we receive, many learning theorists believe that long-term memory storage often involves a process of *construction*, whereby we use the bits and pieces of the information we do retain to build a reasonable understanding of the world around us.

### Examples of Construction in Action

At any given point in time, our interpretation of the environment (**perception**) is usually both less and more than the information we actually receive from the environment (**sensation**). Perception is *less* than sensation because people can't possibly interpret all of the information that bombards their sensory receptors at any given moment. Right now, as you're looking at this book, light waves are bouncing off the page and hitting the light-sensitive cells in the retinas of your eyes. At the same time, you may also be receiving light waves from the table at which you're working, the carpet on the floor, and pictures on the walls. Your ears are probably sensing numerous sound waves, perhaps from a radio, a nearby conversation, an air conditioner, or traffic outside your window. Perhaps a certain smell is drifting through the air or a certain taste from your last meal lingers in your mouth. It's neither necessary nor possible for you to interpret *all* of these sensations, so you'll attend to some of them and ignore the others.

But perception is also much *more* than sensation, because sensation alone provides insufficient information for adequate interpretations of ongoing events. It appears that people use the data their sensory receptors give them to put together, or construct, an overall perception of any given situation (Neisser, 1967; Maus & Nijhawan, 2008; Myin & O'Regan, 2009; Wittrock, 1974). As an example, consider the fact that our eyes don't provide a continual report of visual

People often make assumptions about what they don't see and may be quite surprised when such assumptions are inaccurate.

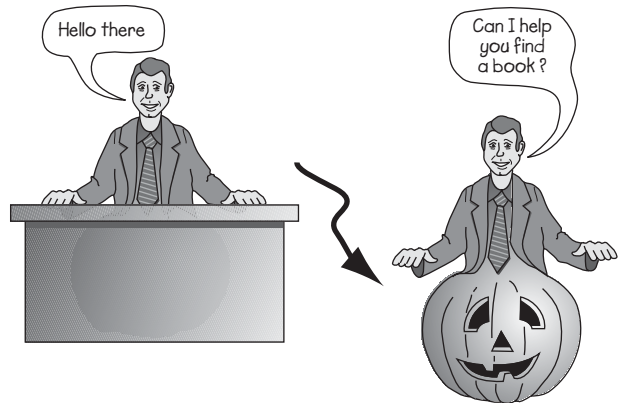

stimulation; rather, they jump from one focal point to another, taking periodic “snapshots” of the visual field. These jumps in focus, or **saccades**, occur four or five times a second, with visual sensation occurring primarily during the rest periods between them (Abrams, 1994; Irwin, 1996). If we receive only four or five snapshots of visual information each second, our visual world should appear jerky and erratic, much as an old-time movie does. The fact that we instead see smooth-flowing motion is due, in large part, to the mental “filling in” that occurs as our minds interpret visual sensations. (This principle should remind you of the Gestalt concept of *closure*.)

Even if human eyes functioned 100% of the time, they would typically give us an incomplete picture of the environment, and we would have to mentally fill in the information that we didn't sense. For example, imagine walking into a bookstore and seeing the store clerk behind the counter. You probably sense only the clerk's head and upper torso, yet you perceive an entire person. You assume that the clerk has a lower torso and two legs, and in fact you'd be quite surprised if you saw a very different lower body—a carved pumpkin, perhaps—as he emerged from behind the counter.

As another example of construction in perception, look at the three pictures in Figure 9.1. Most people perceive the picture on the left as a woman's face and neck, even though many of her features are missing. Enough features are visible—an eye and parts of the nose, mouth, chin, and hair—that you can construct a meaningful perception. Do the other two figures provide

**Figure 9.1**

Can you construct a person from each of these pictures?

Reprinted from “Age in the Development of Closure Ability in Children” by C. M. Mooney, 1957, *Canadian Journal of Psychology*, 11, p. 220. Copyright 1957 by Canadian Psychological Association. Reprinted with permission.



enough information for you to construct two more faces? Construction of a face from the figure on the right may take you a while, but it can be done.

Consider, too, how much is missing from the spoken language we hear. For example, let's say that you're in a noisy room and hear someone say:

*I -an't -ear a -ing in this -lace!*

Although you haven't heard everything the person said, you may have enough information to perceive the sentence:

*I can't hear a thing in this place!*

Even when you do hear everything the speaker says, what you *really* hear is a continuous stream of sound waves rather than . . . separate . . . words . . . spoken . . . like . . . this. Only when you're familiar with the particular language being spoken can you mentally divide the one long sound you actually sense into separate words. For instance, you can easily understand the following sentence when you hear it:

*I read a book.*

even though the identical sentence in Mandarin Chinese would give you trouble:

*Wō kàn shū.*

To an individual fluent in Mandarin Chinese but not in English, the situation would be reversed; that person would "hear" this:

*I read a book.*

and this:

*Wō kàn shū.*

The constructive nature of perception allows us sometimes to be fooled in optical illusions. Consider, for example, the four-towered structure shown in Figure 9.2. If you look closely, you'll

**Figure 9.2**  
An architectural impossibility  
Art courtesy of Roly West.

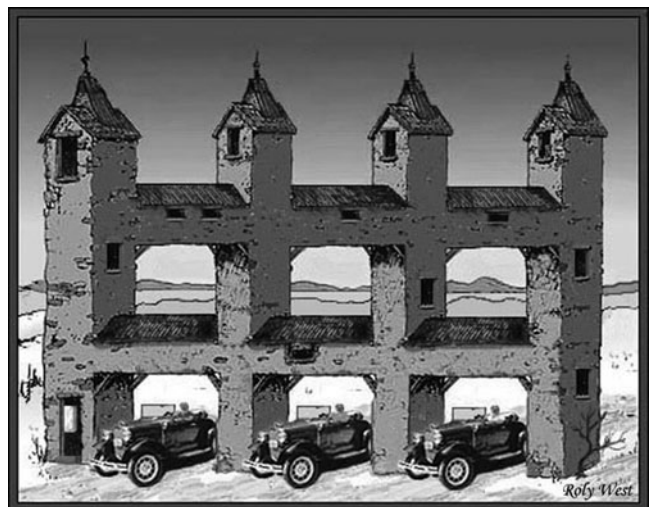

**Figure 9.3**

Reprinted from “The Role of Frequency in Developing Perceptual Sets” by B. R. Bugelski & D. A. Alampay, 1961, *Canadian Journal of Psychology*, 15, p. 206. Copyright 1961 by Canadian Psychological Association. Reprinted with permission.

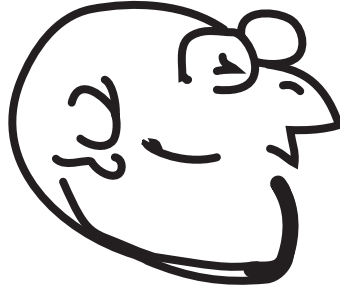

notice that it's an architectural impossibility: If all of the corners are 90° angles (as they seem to be), then the two horizontal hallways couldn't possibly connect with the four towers in the ways depicted.

Curiously, once you've constructed meaning from what you've seen or heard, that meaning then seems so obvious to you. Furthermore, you tend to perceive the same pattern of sensory information in the same way at a future time; a particular construction of sensory input tends to stick with you. For example, if you were to close this book now and not pick it up again for a week or more, you would see the three faces in Figure 9.1 almost immediately, even if you had had difficulty perceiving them originally.

Thanks to constructive processes, different people may perceive and interpret the same object or event differently. For instance, recall Tina's and Alex's rather unconventional interpretations of the lyrics of “America the Beautiful,” which I mentioned earlier. As another example, look closely at the picture in Figure 9.3. Describe to yourself what you see. Notice the shape of the head, the eye, the nose, the mouth, the jaw line. But just what is it that you *do* see? Is this a picture of a man? Or is it, perhaps, a rat or a mouse?

The man–rat picture in Figure 9.3 is an **ambiguous stimulus**—something that readily lends itself to more than one possible construction. Some people perceive the figure to be a bald man with an overbite, strangely shaped ear, and backward tilt to his head. Others instead perceive a rat or mouse with a very short front leg and a long tail curling beneath its body (Bugelski & Alampay, 1961).

As you can see, then, people often perceive the world in unique ways, and all may arrive at different conclusions about what they've seen and heard. As a result, several people witnessing the same event often store very different things in their long-term memories.

## LONG-TERM MEMORY STORAGE PROCESSES

---

Following is a short story, “The War of the Ghosts.” Read it silently *one time only*, then cover the page and write down as much of the story as you can remember.

### *The War of the Ghosts*

One night two young men from Egulac went down to the river to hunt seals, and while they were there it became foggy and calm. Then they heard war-cries, and they thought, “Maybe this is a war-party.” They escaped to the shore, and hid behind a log. Now canoes came up, and they heard the noise of paddles, and saw one canoe coming up to them. There were five men in the canoe, and they said:

“What do you think? We wish to take you along. We are going up the river to make war on the people.”

One of the young men said: “I have no arrows.”

“Arrows are in the canoe,” they said.

“I will not go along. I might be killed. My relatives do not know where I have gone. But you,” he said, turning to the other, “may go with them.”

So one of the young men went, but the other returned home.

And the warriors went on up the river to a town on the other side of Kalama. The people came down to the water, and they began to fight, and many were killed. But presently the young man heard one of the warriors say, “Quick, let us go home: that Indian has been hit.” Now he thought: “Oh, they are ghosts.” He did not feel sick, but they said he had been shot.

So the canoes went back to Egulac, and the young man went ashore to his house, and made a fire. And he told everybody and said, “Behold I accompanied the ghosts, and we went to fight. Many of our fellows were killed, and many of those who attacked us were killed. They said I was hit, and I did not feel sick.”

He told it all, and then he became quiet. When the sun rose he fell down. Something black came out of his mouth. His face became contorted. The people jumped up and cried.

He was dead. (F. C. Bartlett, 1932, p. 65)

Now cover the story and write down everything you can remember of it.

Once you’ve finished, compare your reproduction with the original. What differences do you notice? Your reproduction is almost certainly shorter than the original, with numerous details omitted. Perhaps you added some things, drawing on your prior knowledge to help you make sense of the story, consistent with the construction process described earlier. But you probably maintained the overall gist of the story—its main ideas and events, mostly in their proper sequence.

Using this Native American ghost story, Frederic Bartlett (1932) conducted one of the earliest studies of the long-term memory of meaningful verbal information. Bartlett asked his students at England’s Cambridge University to read the story two times, then to recall it at various times later on. Students’ recollections differed from the actual story in a number of ways:

1. *The words themselves were changed.* In other words, recall wasn’t verbatim.
2. *The focus was on significant events that contributed to the plot line.* Some details were retained, especially those that were essential to the story or particularly striking. Unimportant details and meaningless information, however, were omitted. For example, such details as “something black came out of his mouth” and “he was dead” were likely to be remembered; such details as “the young man . . . made a fire” and “a town on the other side of Kalama” were frequently forgotten.
3. *Parts of the story were distorted, and additional information was inserted to make the story more logical and consistent with English culture.* For example, people rarely go “to the river to hunt seals,” because most seals are saltwater animals and most rivers have fresh water. Students might therefore say that the men went to the river to *fish*. Similarly, the supernatural element didn’t fit comfortably with the religious beliefs of most Cambridge students and thus was often altered. For example, notice the additions and distortions in this recollection, written by a student six months after he had read the original story:

Four men came down to the water. They were told to get into a boat and to take arms with them. They inquired, “What arms?” and were answered “Arms for battle.” When they

came to the battle-field they heard a great noise and shouting, and a voice said: "The black man is dead." And he was brought to the place where they were, and laid on the ground. And he foamed at the mouth. (F. C. Bartlett, 1932, pp. 71–72)

The main idea of the story—a battle—is retained. But after six months, the story has been so distorted that it's barely recognizable.

4. *There was a tendency to explain as well as describe events.* For example, one student insisted on explaining events in parentheses:

The young man did not feel sick (i.e., wounded), but nevertheless they proceeded home (evidently the opposing forces were quite willing to stop fighting). (F. C. Bartlett, 1932, p. 86)

Such findings reveal several qualities about long-term memory storage: It's selective, constructive, occasionally distortive, and to some degree dependent on a learner's existing knowledge. Furthermore, it appears that human beings are motivated to make sense of—that is, to *find meaning* in—what they see and hear.

In the preceding chapter, I introduced you to the distinction between *declarative knowledge*—knowledge about how things are, were, or will be (e.g., facts, figures, events in one's personal life)—and *procedural knowledge*—knowledge about how to do things (e.g., motor skills, problem-solving techniques, study strategies). Storing declarative knowledge and procedural knowledge may involve somewhat different, although overlapping, processes. In this section of the chapter, we'll look at six cognitive processes that affect long-term memory storage—selection, rehearsal, meaningful learning, internal organization, elaboration, and visual imagery—with a particular focus on the acquisition of declarative knowledge. We'll then look at how some of these processes may also be involved in the acquisition of procedural knowledge. Finally, we'll examine evidence in support of the idea that new information in long-term memory sometimes requires a period of *consolidation* in order to endure over the long run.

## Selection

As we saw in Chapter 8, some attended-to information is automatically stored in long-term memory even if it's not specifically selected for further processing (recall our discussion of the frequencies of *bacon* versus *pastrami*). But most explicit knowledge—information that people *know* they know and can easily explain—requires not only attention but also considerable encoding in order to be stored effectively for the long run. Such encoding takes time and requires the active involvement of working memory, which, as noted in Chapter 8, has a very limited capacity. Obviously, learners must be extremely selective about the information they choose to process and so must have a means of determining what is important and what is not.<sup>1</sup>

Although the selection process itself is largely directed by working memory (presumably by its central executive component), long-term memory also plays a critical role. People's knowledge

---

<sup>1</sup>Some advocates for *speed-reading* programs claim that speed reading greatly increases the amount of information a person can learn and remember within a certain time period. Contemporary views of memory indicate that such outcomes are highly unlikely. In fact, research tells us that people's comprehension of text is significantly lower when they speed-read than when they read at a normal rate. Speed-reading is probably effective only when readers already know much of the information they're reading (R. P. Carver, 1971, 1990; R. G. Crowder & Wagner, 1992).

about the world, their personal and cultural priorities, and their predictions about what environmental input is apt to be useful all affect what they pay attention to and think about (S. Kaplan & Berman, 2010; Nairne, Pandeirada, & Thompson, 2008; K. A. Snyder, 2007; Q. Wang & Ross, 2007). A student who has learned that a teacher's lecture content will probably reappear on an upcoming exam is likely to listen closely to what the teacher is saying. A student who has learned that a teacher's exam questions are based entirely on outside reading assignments or has decided that an active social life is more important than classroom achievement may instead attend to something more relevant or interesting—perhaps a text message that has recently arrived on his or her cell phone.

Given the capacity and time constraints of human memory, how can teachers help students select important information? An obvious way is simply to tell students what information is important and what isn't (Bjork, 1972; McCrudden, Schraw, & Hartley, 2006; R. E. Reynolds & Shirey, 1988). Another way is to build redundancy into lectures and instructional materials by repeating important points several times. For example, when I'm presenting an important idea to my students, I typically present it several times. I state the idea once and then state it again using different words. I then illustrate it with at least two examples (sometimes as many as five), and I present the idea itself once again. Notice the redundancy in the last four sentences—it should have been very difficult not to process my meaning at least once! (We'll identify additional strategies in our discussion of *signals* later in the chapter.)

## Rehearsal

You should recall from the preceding chapter that **rehearsal**—repeating something over and over in a short time period (say, over the course of a minute or two)—provides a means of maintaining information in working memory indefinitely. In their early dual-store model of memory, Atkinson and Shiffrin (1971) proposed that rehearsal is also a method of storing information in long-term memory, and there's some evidence that they were right. Several early studies revealed that people remember frequently rehearsed items better than less frequently rehearsed ones (T. O. Nelson, 1977; Rundus, 1971; Rundus & Atkinson, 1971).

Yet other theorists have argued that rehearsal leads to effective long-term memory storage only if, in the process, the learner associates the new information with existing knowledge—in other words, if rehearsal also involves *meaningful learning* (e.g., Craik & Watkins, 1973; Klatzky, 1975; Watkins & Watkins, 1974). From their perspective, mere repetition of information—maintenance rehearsal—is sufficient to keep the information in working memory but *not* sufficient to move it to long-term memory. Rehearsal that in some way helps learners make associations between the new information and things they already know—sometimes known as **elaborative rehearsal**—does facilitate storage in long-term memory. For example, in one study (Craik & Watkins, 1973), college students were asked to perform two tasks simultaneously: They had to keep one word in working memory (by rehearsing it) while at the same time examining additional words to see if they met certain criteria. In this situation, the amount of rehearsal *didn't* influence the extent to which the students could recall the words they had rehearsed; apparently the second task kept them busy enough that they couldn't form associations with the rehearsed words. However, when the additional words were presented at a slower pace, recall of the rehearsed words improved, presumably because the students could devote more working memory capacity to forming associations with the words.

Learning information primarily through repetition is sometimes called **rote learning**. In rote learning, there's little or no attempt to make the information meaningful or to understand it in terms of things one already knows. If such information is stored in long-term memory at all, it's stored in relative isolation from other information. As you'll discover in Chapter 11, information stored in this unconnected fashion is hard to retrieve.

Many, many times I've seen students engage in simple repetition as a means of studying new information. This process, often called *memorizing*, emphasizes the learning of verbatim information rather than the learning of underlying meanings. Young children (e.g., elementary school students) are especially likely to use this strategy when trying to learn new information (Cuvo, 1975; Gathercole & Hitch, 1993; Lehmann & Hasselhorn, 2007), but I've observed high school and college students using it as well. Teachers must help students understand that mere repetition is an inefficient means of storing information for the long run, if it even works at all. The four storage processes we examine next—meaningful learning, internal organization, elaboration, and visual imagery—are clearly more effective.

## Meaningful Learning

Look at this string of 15 letters:

MAIGUWRSENNFLOD

And now look at this string:

MEANINGFULWORDS

Both strings are the same length, and both contain exactly the same letters. Which string is easier to learn and remember? No doubt you'll agree that the second list is easier because you can relate it to words you already know. In the same way, my daughter Tina related a phrase from "America the Beautiful" to her existing knowledge about the world—which unfortunately included *bastard* but not *alabaster*—as did my son Alex, who heard *spaceship skies* instead of *spacious skies*. By relating new information to knowledge already stored in their long-term memories, people find *meaning* in the information. This process of **meaningful learning** is what we're referring to when we talk about *understanding* or *comprehension*.

Meaningful learning appears to facilitate both storage and retrieval: Information is stored more quickly and remembered more easily (J. R. Anderson, 2005; Craik, 2006; Mayer, 1996). To illustrate, consider the following passage from an experiment by Bransford and Johnson (1972):

The procedure is actually quite simple. First you arrange things into different groups. Of course, one pile may be sufficient depending on how much there is to do. If you have to go somewhere else due to lack of facilities that is the next step, otherwise you are pretty well set. It is important not to overdo things. That is, it is better to do too few things at once than too many. In the short run this may not seem important, but complications can easily arise. A mistake can be expensive as well. At first the whole procedure will seem complicated. Soon, however, it will become just another facet of life. It is difficult to foresee any end to the necessity for this task in the immediate future, but then one never can tell. After the procedure is completed one arranges the materials into different groups again. Then they can be put into their appropriate places. Eventually they will be used once more and the whole cycle will then have to be repeated. However, that is part of life. (p. 722)



**Figure 9.4**

Doodles from Bower, Karlin, and Dueck (1975)

From “Comprehension and Memory for Pictures” by G. H. Bower, M. B. Karlin, and A. Dueck, 1975, *Memory and Cognition*, 3, p. 217. Reprinted by permission of Psychonomic Society, Inc.

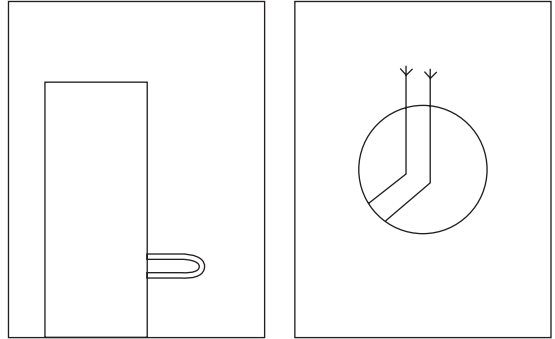

You were probably familiar with all of the words you just read, yet you may have had some trouble making sense of the passage because you didn’t know what it was about. But now try reading it again, this time thinking of it as a description of doing laundry. Bransford and Johnson found that college students who knew the topic of the passage remembered twice as much as those who had no topic with which to connect things.

People can also store nonverbal material more easily when it has meaning for them. For example, in a study by Bower, Karlin, and Dueck (1975), students were asked to remember somewhat meaningless line drawings, or “doodles”; examples appear in Figure 9.4. Students who were given meaningful labels for such pictures, such as “a midget playing a trombone in a telephone booth” or “an early bird who caught a very strong worm” could more easily remember them correctly a week later than students who weren’t given labels.

Relating new information to *oneself* can have a particularly dramatic effect on learning—a phenomenon known as the **self-reference effect** (Craik, 2006; Heatherton, Macrae, & Kelley, 2004). For example, in Chapter 8, I told you the month and day I was born. Can you recall what my birthday is? If so, there’s a good chance that it’s close to your own—perhaps a few days before or after it (Kesebir & Oishi, 2010). To refresh your memory, I was born on August 22nd. I myself am quite good at remembering the birthdays of two friends who were born 9 days earlier than me (on the 13th) and the birthday of another friend born the day after I was (the 23rd). I can also remember a coauthor’s birthday because, although she was born in January, it was the 22nd of January, and I’m especially partial to other “22” birthdates. As for those friends born in November or March—well, I’m pretty much clueless.

A study by Rogers, Kuiper, and Kirker (1977) illustrates just how powerful the self-reference effect can be. College students were shown a series of adjectives (some words were presented in large type and some in small type) and asked to respond to one of four questions about each one. The students were then unexpectedly asked to remember as many of the adjectives as they could; because they had never specifically been told to remember these words, their *incidental* (rather than intentional) learning was being assessed. Following are the four questions students might have been asked about the adjectives and the amount of incidental learning that resulted from answering each of them:

Question	Percentage Recalled
1. Does it have big letters?	3%
2. Does it rhyme with _____?	7%
3. Does it mean the same as _____?	13%
4. Does it describe you?	30%

Notice how Questions 1 and 2 resulted in very poor memory for the words; from a levels-of-processing perspective, we could say that these questions led to very shallow processing. Question 3, which required students to relate a word to something else they knew, led to better memory, although hardly stellar performance. When students were asked to relate the word to themselves (Question 4), incidental learning was more than *twice* what it was for meaningful but not self-related processing.

Because meaningful learning involves connecting new information with previously learned information, it's sometimes called *external organization* (e.g., E. D. Gagné, 1985). Another equally important process is the organization of a new body of information within itself, as we'll see now.

## Internal Organization

A body of new information is stored more effectively and remembered more completely when the various pieces are interconnected in some way—that is, when the new information has **internal organization**. For example, Figure 9.5 shows how you might organize the kinds of reinforcers and punishments described in Chapter 4. In fact, people seem to have a natural tendency to organize and integrate the information they receive. For instance, in our discussion of verbal learning research in Chapter 7, we noted that people who are asked to remember a list of words often put the words into categories while learning them (e.g., retrieving all the animals together, all the vegetables together, and so on). You may also recall the Bransford and Franks (1971) study described in Chapter 7, in which students learned that “The ants in the kitchen ate the sweet jelly which was on the table” by integrating the content of several shorter sentences.

As you might expect, material presented in an unorganized manner is easier to learn than unorganized material. An experiment by Bower, Clark, Lesgold, and Winzenz (1969) demonstrates just how dramatic the effects of internal organization can be. College students were given four study trials in which to learn 112 words that fell into four categories (e.g., minerals, plants, etc.). Some students had words arranged randomly, whereas other students had words arranged in four hierarchies similar in nature to the one I've constructed for consequences (Figure 9.5). After one study trial, students who had studied the organized words could remember more than three times as many words as those who had studied the randomized words. After four study trials, the students in the organized group remembered all 112, whereas those in the random group remembered, on average, only 70.

**Figure 9.5**  
Example of a concept hierarchy

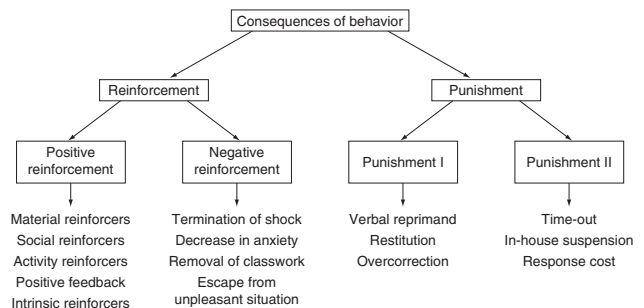

Many good students spontaneously organize information as they learn it, and such learner-generated organization can be quite effective (Britton, Stimson, Stennett, & Gülgöz, 1998; McDaniel & Einstein, 1989; Niederhauser, 2008). Furthermore, providing students with specific organizational schemes can often help students learn more effectively (R. K. Atkinson et al., 1999; Kiewra et al., 1988; Mayer, 2010b; Niederhauser, 2008).

## Elaboration

When people receive new information, they often impose their own interpretations on it—making assumptions, drawing inferences, and so on—and learn those interpretations right along with the information they’ve actually been given. In general, **elaboration** involves using prior knowledge to embellish on new information and storing the embellished version. Thus, elaboration is a process of learning *more* than the material presented; I like to think of it as *learning between the lines*.<sup>2</sup> As an example, my son Jeff tells me that when he first heard the expression “losing one’s voice” when he was in first or second grade, he concluded that people eventually lose their voices permanently. From this, he deduced that people are born with a finite amount of “voice” they eventually use up. So as not to waste his own supply, he would merely mouth the words (rather than actually sing them) during his weekly choir sessions at school.

Numerous studies lead to the same conclusion: People frequently elaborate on the information they receive and later have difficulty distinguishing between the actual truth and their elaborations of it (e.g., Graesser & Bower, 1990; M. K. Johnson, Bransford, & Solomon, 1973; E. F. Loftus, 2003; Reder & Ross, 1983). As an illustration, read the following passage *one time only*:

Nancy woke up feeling sick again and she wondered if she really were pregnant. How would she tell the professor she had been seeing? And the money was another problem.

Nancy went to the doctor. She arrived at the office and checked in with the receptionist. She went to see the nurse, who went through the usual procedures. Then Nancy stepped on the scale and the nurse recorded her weight. The doctor entered the room and examined the results. He smiled at Nancy and said, “Well, it seems my expectations have been confirmed.” When the examination was finished, Nancy left the office. (J. Owens, Bower, & Black, 1979, pp. 185–186)

Did the doctor tell Nancy she was pregnant? No, he did not. Yet in a study conducted by Owens and his colleagues (1979), when students read the passage and then were asked a day later to recall its contents, they “remembered” considerably more than they’d actually read. Many of their recalled elaborations were directly related to Nancy’s suspected condition. Other students in the experiment read only the second paragraph of the passage and thus didn’t know that Nancy thought she was pregnant; these students added far fewer elaborations.

As was the case for my son Jeff when he heard the expression “losing one’s voice,” elaboration sometimes leads to distortions and errors in what’s learned. Fortunately, elaboration usually

---

<sup>2</sup>*Meaningful learning* and *elaboration* might strike you as very similar processes, and theorists sometimes use the terms interchangeably. In my mind, it’s helpful to distinguish between the two. Whereas meaningful learning involves *connecting* new information to existing knowledge, elaboration also involves *embellishing* on new information.

involves making *correct* assumptions and interpretations, and in such cases it facilitates both storage and retrieval (Graessner & Bower, 1990; Greeno, Collins, & Resnick, 1996; N. C. Hall, Hladkyj, Perry, & Ruthig, 2004; McDaniel & Einstein, 1989; Muis & Franco, 2009).

Elaboration appears to be especially effective when it helps tie new information together—that is, when it also helps to internally organize it. For example, in studies by Stein, Bransford, and their colleagues (Stein & Bransford, 1979; Stein et al., 1982), fifth graders and college students were instructed to learn a series of sentences. Each sentence involved a particular kind of man and a particular activity; following are two examples:

The fat man read the sign.

The hungry man got into the car.

The sentences were elaborated with phrases added on to them—elaborations generated either by the experimenters or by the students themselves. Some of the elaborative phrases (*precise* elaborations) provided a connection between a man's characteristic and his activity, for example:

The fat man read the sign warning about the thin ice.

The hungry man got into the car to go to the restaurant.

Other elaborative phrases (*imprecise* elaborations) didn't tie the characteristic and activity together; here are some examples:

The fat man read the sign that was two feet high.

The hungry man got into the car and drove away.

Precise elaborations were far more effective than imprecise ones in helping the students remember the sentences.

In some cases, learners elaborate on and integrate new information to the point that they construct an entirely new idea, concept, procedure, or line of reasoning. Oftentimes, learning something by constructing it *on one's own* makes it more memorable than having someone else present it in a prepackaged format. This phenomenon is known as the **generation effect**. Self-constructed knowledge—provided that it's accurate, of course—appears to be beneficial primarily in situations where learners engage in greater elaboration of new material than they might otherwise do (Mayer, 2010a; McDaniel, Waddill, & Einstein, 1988; McNamara & Healy, 1995; Wiley & Voss, 1999).

Elaboration probably facilitates long-term memory for several reasons. First, elaborated information is less likely to be confused with other, similar information stored in long-term memory. Second, elaboration provides additional means through which a piece of information can later be retrieved; in a sense, it provides more places to “look” for the information. And third, elaboration may help in making inferences about what the information was *likely* to have been if the information itself can't be accurately recalled (J. R. Anderson, 1995, 2005; Hunt & Worthen, 2006).

## Visual Imagery

Without looking back at Figure 9.4, can you recall what the “midget playing a trombone in a telephone booth” looked like? Can you remember the “early bird who caught a very strong worm”? If so, then you may have stored these things not only as the verbal labels I gave them but also as

**visual imagery**—that is, as mental “pictures” that captured how the figures actually looked. Visual imagery relies on some of the same specific processes and brain regions that are involved in visual perception (Behrmann, 2000; Kosslyn, 1994; Speer, Reynolds, Swallow, & Zacks, 2009).

Forming visual images can be a powerful means of storing information in long-term memory. Many people of all ages have a remarkably accurate memory for visual information. For example, in one study (Konkle, Brady, Alvarez, & Oliva, 2010), college students looked at almost 3,000 scenic photographs in various categories (e.g., ocean waves, golf courses, amusement parks) over a 5½-hour period. After that, they were shown pairs of photos and asked to choose which member of each pair they’d previously seen. Their hit rates were fairly high; even when they’d seen 64 photos of ocean waves or golf courses, they could distinguish between those they’d seen and those they hadn’t with 76% accuracy. Furthermore, images can be relatively enduring. For example, in another study (D. B. Mitchell, 2006), people who viewed a series of pictures for only 1 to 3 seconds in a laboratory experiment showed better-than-chance recognition of them when asked to identify them *17 years later!*

People’s memory for visual material is often better than it is for strictly verbal material (Dewhurst & Conway, 1994; Edens & McCormick, 2000; Marley, Szabo, Levin, & Glenberg, 2008; Rubin, 2006). In fact, people tend to remember information better when it’s presented in *both* verbal and visual forms, rather than in only one form or the other (Sadoski & Paivio, 2001; Mayer, 2003, 2010a).

Especially when new information is concrete and can be easily visualized, learners sometimes create their *own* mental images. For instance, when students form visual images while reading stories or listening to explanations of classroom topics, they more effectively understand and remember what they’ve read or heard (Cothorn, Konopak, & Willis, 1990; Dewhurst & Conway, 1994; Sadoski & Paivio, 2001; Sweller, 2008). Furthermore, specifically instructing people to form visual images of what they’re studying helps them learn the material more quickly and remember it more effectively (M. S. Jones, Levin, Levin, & Beitzel, 2000; Marley et al., 2008; Pressley, Johnson, Symons, McGoldrick, & Kurita, 1989). Accordingly, imagery provides the foundation for a number of memory strategies called *mnemonics*, which we’ll consider in Chapter 14.

Children’s facility to form and manipulate visual images increases with age (Kosslyn, Margolis, Barrett, Goldknopf, & Daly, 1990; Pressley, 1977, 1982). Yet learners of all ages differ considerably in their ability to use visual imagery: Some form images quickly and easily, whereas others form them only slowly and with difficulty (Behrmann, 2000; J. M. Clark & Paivio, 1991; Kosslyn, 1985; Riding & Calvey, 1981).

It’s important to note, however, that even for good visualizers, visual images tend to be imprecise representations of external objects, with many details omitted, blurry, or altered (Chambers & Reisberg, 1985; Nersessian, 2008; S. Reed, 1974; Sadoski & Paivio, 2001). Furthermore, images can be distorted by a learner’s general knowledge, as an early study by Carmichael, Hogan, and Walters (1932) illustrates. An experimenter asked adults to remember simple pictures like the ones shown on the left side of Figure 9.6. Two groups were given different sets of labels for the pictures, and the participants tended to remember the pictures in ways that more closely fit the specific labels they were given. For instance, as you can see in Figure 9.6, the first picture was reproduced differently depending on whether it had been labeled as eyeglasses or dumbbells. Similarly, recall of the second picture was influenced by its identity as a kidney bean or a canoe. Because images tend to be incomplete and are sometimes inaccurate, they aren’t always useful when precise, detailed information must be stored—for instance, when we need to recall the correct spellings of terms such as *silhouette* and *hors d’oeuvre*.

**Figure 9.6**

Experimental stimuli and examples of participants' reproductions, from L. Carmichael, Hogan, & Walters (1932)

Adapted from "An Experimental Study of the Effect of Language on the Reproduction of Visually Perceived Form" by L. Carmichael, H. P. Hogan, and A. A. Walters, 1932, *Journal of Experimental Psychology*, 15, p. 80.

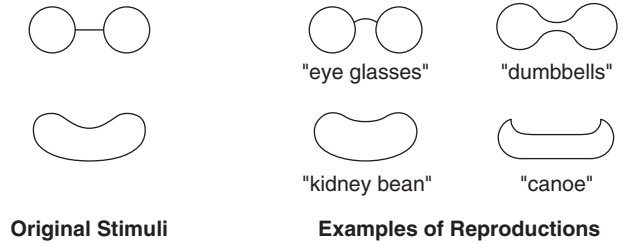

Of the six long-term memory storage processes we've just examined, the last three—internal organization, elaboration, and visual imagery—are clearly constructive in nature. Each of them involves combining new information with things already in long-term memory. When we organize information, we often use a familiar framework (perhaps a hierarchy of well-known categories) to give new material a meaningful structure. When we elaborate, we use both new information and our existing knowledge to construct a reasonable interpretation of an event. And when we use visual imagery, we often create those images for ourselves based on what we know about how objects typically appear.

## How Procedural Knowledge Is Acquired

Some of the procedures people learn—for example, driving a car with a stick shift, planting flowers, spiking a volleyball—consist primarily of overt behaviors. Other procedures—for instance, writing an essay, solving for  $x$  in an algebraic equation, surfing the Internet—have a significant mental component as well. Many procedures involve a combination of physical behaviors and mental activities.

Procedural knowledge ranges from relatively simple actions (e.g., holding a pencil correctly or using scissors) to far more complex skills. Complex procedures usually aren't learned in one fell swoop. Instead they're acquired slowly over a period of time, often only with a great deal of practice (Beilock & Carr, 2003; Charness, Tuffiash, & Jastrzembski, 2004; Ericsson, 2003; Mainz & Hambrick, 2010).

People appear to learn many physical procedures primarily as actual behaviors—in other words, as specific actions that, with practice, are stored and gradually refined (Féry & Morizot, 2000; van Merriënboer & Kester, 2008; Willingham, 1999; Willingham & Goedert-Eschmann, 1999). Yet some procedures, especially complex ones that have a mental component, may also be learned as declarative knowledge—in other words, as *information* about how to do something (J. R. Anderson, 1983a; Beilock & Carr, 2003). Learners may initially use such information to guide them as they execute a procedure (recall our discussion of self-instructions in Chapter 6). To the extent they must do so, however, their performance is apt to be slow and laborious and require a lot of concentration—that is, it consumes considerable working memory capacity. As learners continue to practice the procedure, their performance gradually becomes faster, easier, and more efficient. People who show exceptional talent in a particular skill—say, in figure skating or playing the piano—typically practice a great deal, usually a minimum of three to four hours a day over a period of 10 years or more (Ackerman, 2007; Ericsson, 1996).

Theorists haven't yet pinned down how the informational and behavioral aspects of procedural knowledge interrelate and interact during learning and long-term memory storage. Some

theorists (e.g., J. R. Anderson, 1983a, 1987; Beilock & Carr, 2003) have suggested that declarative knowledge is acquired first and, with practice, gradually *evolves* into procedural knowledge. Other theorists (Willingham & Goedert-Eschmann, 1999) have proposed that people simultaneously learn both information and behaviors in the process of acquiring a new procedure. They quickly learn the informational piece—this takes the form of explicit declarative knowledge—but learn the appropriate behaviors in a more gradual, *implicit* fashion. When the behaviors are still imperfect and inconsistent, people use their declarative information to help them remember what they need to do, presumably by engaging in overt or subvocal self-instructions. For instance, beginning tennis players might continually remind themselves to “Keep your arm straight” and “Keep your eye on the ball.” Such verbal self-support becomes less necessary as learners increasingly fine-tune and master a procedure’s behavioral aspects.

Some of the storage processes we’ve already discussed play a role in acquiring procedural knowledge as well as declarative knowledge. For instance, verbally rehearsing a sequence of steps in a motor skill enhances people’s ability to perform the skill (Weiss & Klint, 1987). Illustrations or live demonstrations of a procedure, which presumably foster visual imagery, are also quite helpful (Kitsantas, Zimmerman, & Cleary, 2000; SooHoo, Takemoto, & McCullagh, 2004; Zimmerman & Kitsantas, 1999). In fact, imagining *oneself* performing an action (e.g., executing a gymnastics skill or a basketball shot) can enhance acquisition of a procedure, although such imagined behaviors are obviously not as effective as actual practice (Feltz, Landers, & Becker, 1988; Kosslyn, 1985; SooHoo et al., 2004).

To the extent that procedural knowledge has mental as well as physical components—for example, as is true in solving mathematical word problems and conducting scientific experiments—it’s acquired and retrieved most effectively when it’s stored in conjunction with relevant declarative knowledge regarding why certain procedures are effective (e.g., Carr & Biddlecomb, 1998; D. Kuhn & Pease, 2008).

## Does New Knowledge Require a Consolidation Period?

As we’ve just seen, much procedural knowledge is acquired gradually over time. However, I’ve implied that long-term storage of declarative information can sometimes be quite rapid. For example, imagine that you encounter an intriguing new fact—*Attention is essential for learning*, let’s say. You elaborate on this fact: “That explains why I never remember anything when I try to study while watching television!” Through such elaboration, you’re able to store the fact very quickly in long-term memory, where it immediately “sticks.” But is the stick an immediate one? Some researchers don’t think so.

Some researchers have discovered that the neural underpinnings of newly acquired declarative and procedural knowledge often need some **consolidation** time—perhaps a few minutes or a few hours, or perhaps even longer (Bauer, DeBoer, & Lukowski, 2007; M. P. Walker, 2005; Wixted, 2005). Considerable evidence for such consolidation comes from studies of **retrograde amnesia**: Accident victims who suffer serious head traumas often can’t remember events immediately leading up to their accidents, and sometimes they also forget events that occurred in the last few weeks or months before their accidents (D. J. Siegel, 1999; Wixted, 2005).

At this point, theorists can only speculate about the specific processes involved in the consolidation aspect of long-term memory storage. Possibly it involves some sort of low-level, unconscious activation, rehearsal, or strengthening of newly formed associations (Bauer et al., 2007; Rasch & Born, 2008; D. J. Siegel, 1999). In any case, it appears that a good night’s sleep

enhances the consolidation of newly acquired memories (Hu, Stylos-Allan, & Walker, 2006; Massimini et al., 2005; J. D. Payne & Kensinger, 2010).

## FACTORS AFFECTING LONG-TERM MEMORY STORAGE

---

A variety of factors affect how learners store information in long-term memory. In this section, we'll consider cognitive factors—working memory, prior knowledge, prior misconceptions, and expectations—and behavioral factors—verbalization, enactment, repetition, and review—that appear to be especially influential.

### Working Memory

As we've seen, long-term memory storage is often more effective when new material is connected with existing knowledge. For learners to make a connection between a new piece of information and a piece of information they already have, they must be *aware* of the relationship between the two. In other words, both pieces must be in working memory at the same time (Daneman, 1987; Kintsch & van Dijk, 1978; Mayer, Moreno, Boire, & Vagge, 1999; Nuthall, 2000). An experiment by Hayes-Roth and Thorndyke (1979) illustrates this idea. In this experiment, students read one of two passages describing a fictional country. The same pieces of information appeared in both passages but in a different order: In one passage, related pieces of information appeared in sequential sentences, whereas in the other, they appeared in separate paragraphs. Students more frequently made connections between two related pieces of information (and thus could draw inferences from them) when the pieces of information were presented one right after the other, presumably because both items were more likely to be in working memory at the same time.

People don't necessarily have to experience two things in sequence to make connections between them, however. In many cases, new information reminds learners of something they already know, leading them to retrieve that knowledge to working memory. In other cases, a wise teacher might point out the relationships between the new information and previously learned material, thus encouraging retrieval of relevant prior knowledge.

The less working memory capacity learners have available to them, of course, the less "room" they have with which to think about how various bits of information might fit together. For instance, when learners are multitasking—that is, when their working memories are trying to handle two or more tasks at once—they're less likely to store and recall new information effectively (Sweller, 2008; Vergauwe, Barrouillet, & Camos, 2010). And learners who have relatively "small" working memories draw fewer inferences from what they read than do students who have larger-capacity ones (Linderholm & van den Broek, 2002; Oakhill, Cain, & Yuill, 1998).

### Prior Knowledge

People can connect new information to prior knowledge only when they actually *have* knowledge that relates to what they're learning. One of the most important factors affecting long-term memory storage, then, is what a learner *already knows* (Ausubel, Novak, & Hanesian, 1978; Cromley, Snyder-Hogan, & Luciw-Dubas, 2010b; Haskell, 2001; Shapiro, 2004). Learners who have a large body of information already stored in long-term memory have more ideas to which they can relate their new experiences and so can more easily engage in such



processes as meaningful learning and elaboration. Learners who lack relevant knowledge must resort to rehearsal and other inefficient rote-learning strategies (Bandalos, Finney, & Geske, 2003; E. Wood, Willoughby, Bolger, & Younger, 1993). In other words, the rich (in knowledge) get richer, and the poor stay relatively poor.

Our prior knowledge about the world often affects our ability to encode even the most basic kinds of information. For example, when you see people walking away from you, their images on your retinas get progressively smaller, yet you know they're not really shrinking—they're simply increasing their distance from you. What would happen if you had no such experience with perceiving people and other things at varying distances? Anthropologist Colin Turnbull (1961) observed this situation while studying the Ba Mbuti pygmies, a tribe living in the thick jungle of the Congo rainforest. With no open spaces in their environment, the Ba Mbuti never had the opportunity to see objects more than a few feet away from them. Turnbull described an incident in which a member of the tribe, a man named Kenge, traveled for the first time to an area of open grasslands. When Kenge spied a herd of buffalo grazing in the far distance, he asked, "What insects are those?" and dismissed as folly Turnbull's reply that they were actually buffalo that were very far away. A short time later, as the men approached the buffalo by car, Kenge grew increasingly frightened as he watched the buffalo "grow" in size, fearful that a magic trick was being played on him.

Numerous studies have illustrated the importance of previous knowledge for encoding and storing new information (Ackerman, 2007; Cromley et al., 2010b; E. Fox, 2009; Hattie, 2009). As an example, three of my colleagues and I once conducted a study of how well people from different disciplines learn and remember maps (Ormrod, Ormrod, Wagner, & McCallin, 1988). We asked faculty members and students in three disciplines—geography, sociology, and education—to study two maps and then reproduce them from memory. The first of these maps, shown in Figure 9.7, depicts a city arranged in accordance with usual citylike patterns; that is, its arrangement is *logical*. Notice how the downtown business district is located at a point where it can be easily reached from different directions (this is typical), and the mills, lumberyard, and low-income housing are situated near the railroad tracks (also typical). The second map, shown in Figure 9.8, is on a larger scale and depicts several political regions (countries, perhaps). Several things about this map make no sense; that is, its arrangement is *illogical*. Notice how a river originates in the plains and runs *up* into the mountains, transportation networks don't interconnect, and towns aren't located at transportation junctions. My colleagues and I predicted that geographers would remember more of the logical city map than either sociologists or educators because they could use their knowledge of typical urban patterns to learn the map meaningfully. We also predicted that the geographers would have no advantage over folks in the other disciplines on the illogical "countries" map because geographic principles were largely inapplicable in making sense of the map. Our predictions were confirmed: Geographers showed better recall than the other two groups for the logical city map but not for the illogical countries map. Because we had asked the participants to "think aloud" as they studied the maps, we were also able to examine the strategies they employed. As we expected, the geographers learned the maps more meaningfully than the other groups, and all three groups learned the city map more meaningfully than the countries map. Our "nongeographers" used primarily rote-learning strategies, mostly in the form of simple rehearsal.

Other studies have yielded similar results. For example, children who know a lot about spiders remember more from reading a passage about spiders than do children who initially know very little (Pearson, Hansen, & Gordon, 1979). People who know a lot about baseball or basketball can remember more new facts about those sports and more about what happened in a

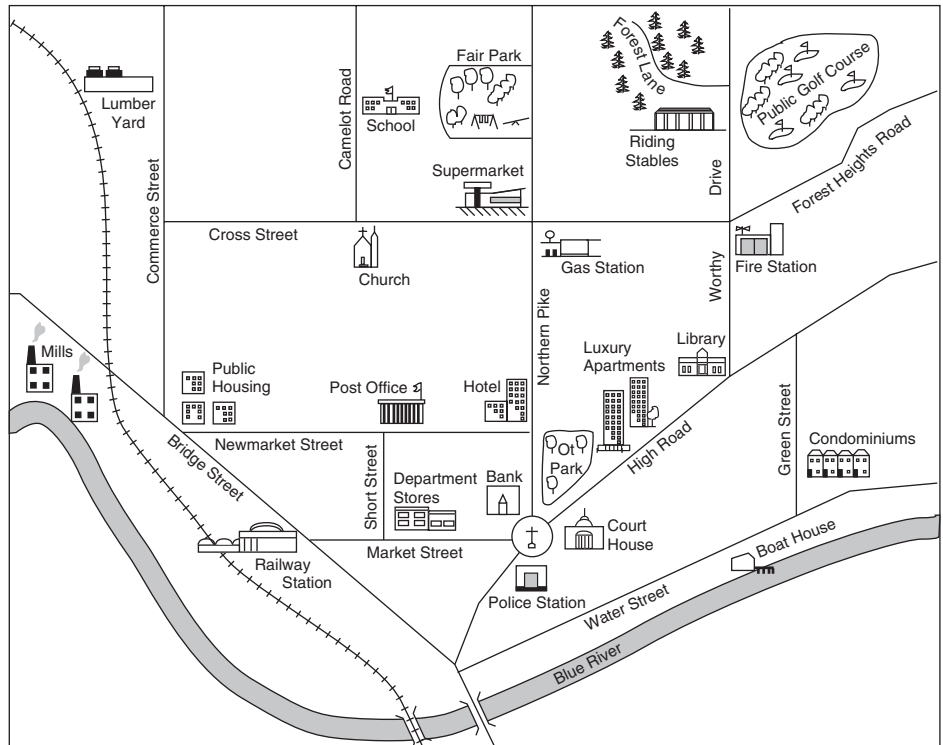

**Figure 9.7**  
The logical city map from Ormrod et al. (1988)

Reprinted from “Reconceptualizing Map Learning” by J. E. Ormrod, R. K. Ormrod, E. D. Wagner, & R. C. McCallin, 1988, *American Journal of Psychology*, 101, p. 428. Reprinted with permission of the University of Illinois Press.

particular game than can people who are relatively uninformed about the sports (V. C. Hall & Edmondson, 1992; Kuhara-Kojima & Hatano, 1991; Spilich, Vesonder, Chiesi, & Voss, 1979). And eighth graders who know a lot about American history engage in more elaborative processing when they read a history textbook (e.g., they’re more likely to summarize the material, make inferences, and identify unanswered questions) than classmates who have less history knowledge (Hamman et al., 1995).

Although older children and adults usually learn most things more easily than younger children, the reverse can sometimes be true if younger children have more knowledge about the subject matter. For example, children who are expert chess players can better remember where chess pieces are on a chessboard than adults who are relative novices at chess (Chi, 1978). Similarly, 8-year-olds who know a lot about soccer remember more from a passage they read about soccer than 12-year-olds who know very little about the game (Schneider, Körkkel, & Weinert, 1990).

Because everyone has somewhat different knowledge about the world, learners are likely to elaborate on the same information in different ways and, as a result, to learn different things. For example, how would you interpret this newspaper headline?

VIKINGS CREAM DOLPHINS

**Figure 9.8**

The illogical country map from Ormrod et al. (1988)

Reprinted from “Reconceptualizing Map Learning” by J. E. Ormrod, R. K. Ormrod, E. D. Wagner, & R. C. McCallin, 1988, *American Journal of Psychology*, 101, p. 429. Reprinted with permission of the University of Illinois Press.

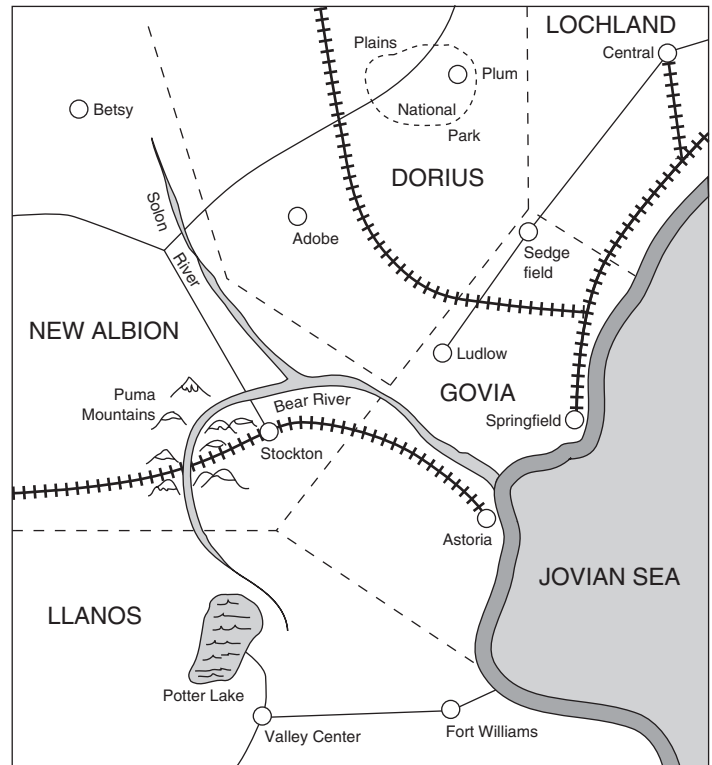

Your interpretation might depend on whether you are more attuned to American football or to possible early Scandinavian cuisine (Leinhardt, 1992). And consider the following passage from a study conducted by Anderson, Reynolds, Schallert, and Goetz (1977):

Rocky slowly got up from the mat, planning his escape. He hesitated a moment and thought. Things were not going well. What bothered him most was being held, especially since the charge against him had been weak. He considered his present situation. The lock that held him was strong but he thought he could break it. He knew, however, that his timing would have to be perfect. Rocky was aware that it was because of his early roughness that he had been penalized so severely—much too severely from his point of view. The situation was becoming frustrating; the pressure had been grinding on him for too long. He was being ridden unmercifully. Rocky was getting angry now. He felt he was ready to make his move. He knew that his success or failure would depend on what he did in the next few seconds. (R. C. Anderson et al., 1977, p. 372)

Is this story about a wrestling match? Or is it about a prison escape? Read the passage again, and you should notice that it could be about either one. Anderson and his colleagues found that students' interpretations of the story depended on their background: Physical education majors more frequently viewed it as a wrestling match, whereas music education majors (most of whom had little or no knowledge of wrestling) were more likely to interpret it as a prison escape.

It's entirely possible, however, to have existing knowledge about a topic and yet *not* bring it into play when learning new information about the topic. As noted earlier, a learner will make connections between the “new” and the “old” only if both are simultaneously in working memory. To switch from a dual-store model of memory to an activation model for a moment, we might say that both the new and the old must be *activated* at the same time. As we consider instructional strategies later in the chapter, we'll identify a variety of ways in which teachers might promote meaningful learning and elaboration by activating students' prior knowledge.

## Prior Misconceptions

When people engage in elaboration, they use what they already know about a topic to expand on and presumably make better sense of new information. But what happens when people use inaccurate “knowledge”— **misconceptions**<sup>3</sup>—to elaborate? If people think that new information is clearly wrong within the context of what they currently believe about the world, they may ignore the information altogether. Alternatively, they may distort the information to be consistent with their “knowledge” and as a result learn something quite different from what they actually saw, heard, or read (P. K. Murphy & Mason, 2006; Porat, 2004; Sneider & Pulos, 1983; Vosniadou, 2008). In some instances, then, having *misinformation* is more detrimental than having *no* information about a topic.

We saw one instance of such *mislearning* in Bartlett's (1932) study involving “The War of the Ghosts”: Many students distorted the story to make it consistent with English culture. A study by Eaton, Anderson, and Smith (1984) provides another example. Fifth graders spent several weeks studying a unit on light in their science curriculum. A pretest had shown that many students had a particular misconception about light: They believed that people see things only because the light shines on them and makes them brighter. During the unit, the correct explanation of human sight was presented: Light reflects off objects and continues to travel *to the eye*, which then detects the light and so makes vision possible. Despite reading and hearing this information, most students retained their misconceptions about vision in a test given at the end of the unit. Only 24 to 30% of them correctly indicated in their answers that light must travel not only from the light source to the object but also from the object to the eye.

Prior misconceptions can wreak havoc even at the college level (D. E. Brown & Hammer, 2008; Evans, 2008; Kendeou & van den Broek, 2005). For example, undergraduates who study the nature of vision in a psychology course—including the idea that light must travel from the object to the eye—often leave the course thinking that vision occurs because something travels in the *opposite* direction—that is, from the eye to the object (Winer, Cottrell, Gregg, Fournier, & Bica, 2002). Similarly, students in teacher education programs may disregard a professor's definitions for certain concepts (instead relying on their previous, often very different understandings of the concepts), and they're likely to ignore any recommendations for teaching practice that contradict their own beliefs about “good teaching” (Holt-Reynolds, 1992; V. Richardson, 2003). I've seen such phenomena in some of my own undergraduate teacher education classes. For instance, some students stick to their existing definitions of such terms as *negative reinforcement*

---

<sup>3</sup>Some theorists prefer terms such as *naive beliefs* or *naive conceptions* to reflect the fact that such inaccuracies, although not a good match with contemporary scientific understandings, may be reasonable conclusions from a learner's early knowledge and experiences.

and *elaboration* even though I point out quite emphatically that a psychologist defines these words differently than a layperson does. And despite the evidence I present regarding the effectiveness of meaningful learning, a few students continue to insist that rote learning is a better approach.

Teachers often present information to students with the assumption that the information will correct students' erroneous beliefs. Unfortunately, what often happens instead is that students stubbornly hold onto their preconceived notions about the world and distort the new information to fit those notions. As we examine the nature of *personal theories* in Chapter 10, we'll look in greater depth at the kinds of misbeliefs children and adults are likely to have.

## Expectations

Read this sentence:

I pledge allegiance to the flag of the United Stetes of American, and to the Republic for which it stends, one nation, under God, indivsible, with liberty and justice for all.

You may have noticed one or two typographical errors in the passage. But did you catch them all? Altogether there were *five* mistakes, as italicized below:

I pledge allegiance to the flag of the United Stetes of American, and to the Republic for which it stends, one nation, under God, indivsible, with liberty and justice for all.

If you didn't notice all the errors—and many people don't—then your expectation of what words *should* have been there influenced your interpretation of the sentence. If you've seen and heard the U.S. Pledge of Allegiance as many times as I have, you know that the phrase "I pledge allegiance . . ." is usually followed by a certain sequence of words, and so you may have seen what you expected to see.

We often form expectations about the things we'll see and hear—expectations based on our existing knowledge and beliefs about how the world typically operates—and these can influence how we encode and store new information in long-term memory (Kaiser, McCloskey, & Proffitt, 1986; Schacter, 1999). In many cases we perceive and learn something more quickly when we have a good idea ahead of time about the information we're going to receive, perhaps because relevant portions of long-term memory have already been activated (recall the discussion of *priming* in Chapter 8). The process of reading provides a good example. Beginning readers pay close attention to the letters on the page as they read and, as a result, often read slowly and comprehend little. More mature readers tend not to look as carefully at the printed page. Instead, they rely on such things as context, sentence syntax, prior knowledge about a topic, and expectations about what the author is trying to communicate in order to draw hasty, although usually accurate, conclusions about what's on the page. It's precisely because mature readers often *do* jump to rapid conclusions that they read so quickly and efficiently (Dole, Duffy, Roehler, & Pearson, 1991; R. E. Owens, 1996; Pressley, 2002).

Yet such an efficient approach to reading has a potential drawback: Readers risk jumping to the *wrong* conclusions and misperceiving or misinterpreting what's on the page. They may have difficulty proofreading accurately, "seeing" correctly spelled words that are actually misspelled. And they may have trouble learning how to spell the many new vocabulary words (e.g., *psychology*, *environment*, *reinforcement*) that they encounter in their reading (Frith, 1978, 1980; Ormrod, 1985, 1986a, 1986b, 1986c). For example, people frequently misread my name—Jeanne

Ormrod—as “Jeanne Ormond,” an error I find quite annoying. But let’s face it: Ormrod is an unusual name, whereas Ormond is more common. One can almost not blame readers who see *Orm* . . . and just assume that the rest of the word is . . . *ond*. Using the first few letters of a word to identify the word is a common strategy in reading (Lima, 1993).

Earlier in the chapter, I introduced the concept of *ambiguous stimulus*, a stimulus that can be interpreted in more than one way. Ambiguous stimuli are especially likely to be encoded in accordance with people’s expectations (Eysenck & Keane, 1990; J. W. Sherman & Bessenoff, 1999). For instance, when I show the man–rat picture (Figure 9.3) to students in my classes, I consistently find that the great majority of students who’ve been led to expect a nonhuman animal—by previously viewing a picture that’s clearly a rodent—*do* see a mouse or rat. Students who have similarly been led to expect a person see the bald-headed man. And notice how your expectations concerning how people typically behave influence your initial interpretation of the first statement in this verbal exchange (from Gleitman, 1985, p. 432):

“We’re going to have my grandmother for Thanksgiving dinner.”  
 “You are? Well, we’re going to have turkey.”

Other people’s behaviors are often subject to numerous interpretations and so are prime examples of ambiguous stimuli. For example, if you see me smile at you (my behavior), you might draw any number of possible conclusions: I’m happy to see you, I’m *not* happy to see you but am being polite, I detest you but need a favor, I think the shirt you’re wearing looks ridiculous, and so on. People tend to interpret others’ behaviors in accordance with their own expectations (Burgess, Wojslawowicz, Rubin, Rose-Krasnor, & Booth-LaForce, 2006; Crick & Dodge, 1996; Ritts, Patterson, & Tubbs, 1992; M. Snyder & Swann, 1978). They expect desirable behaviors from a person they like or admire and thus are likely to perceive that person’s behaviors in a positive light—a phenomenon known as the **halo effect**. In much the same way, they expect inappropriate behaviors from a person they dislike, and their perceptions of that person’s behaviors are biased accordingly—the **horns effect** in action. As an example, imagine that a teacher, Mr. Brighteyes has a student named Mary who consistently performs well in classwork, and another student, Susan, who more typically turns in sloppy and incomplete work. Let’s say that both girls turn in an assignment of marginal quality. Mr. Brighteyes is likely to *overrate* Mary’s performance and *underrate* Susan’s.

Many factors affect people’s expectations for—and hence their interpretations of—another person’s behaviors. For instance, people often expect higher-quality performance from people who are clean and well groomed than from people who are dirty and disheveled—hence the adage “Dress for success.” Teachers expect well-behaved students to be more academically successful than poorly behaved students; thus, their judgments of a specific student’s academic performance are likely to be influenced by the way the student behaves in the classroom (Bennett, Gottesman, Rock, & Cerullo, 1993). Stereotypes about people of different genders, races, ethnic backgrounds, and socioeconomic groups also have an effect (C. Reyna, 2000; J. W. Sherman & Bessenoff, 1999; Stephan & Stephan, 2000). An experiment by Darley and Gross (1983) provides an example. Undergraduate students were told that they were participating in a study on teacher evaluation methods and asked to view a video of a fourth grader named Hannah. Two versions of the video were designed to give two different impressions about Hannah’s socioeconomic status; her clothing, the kind of playground on which she played, and information about her parents’ occupations indirectly conveyed to some students that she was

from a low socioeconomic background and to others that she was from a high socioeconomic background. All students then watched Hannah taking an oral achievement test (on which she performed at grade level) and were asked to rate Hannah on a number of characteristics. Students who had been led to believe that Hannah came from wealthy surroundings rated her ability well above grade level, whereas students who believed she lived in an impoverished environment evaluated her as being below grade level. The two groups of students also rated Hannah differently in terms of her work habits, motivation, social skills, and general maturity.

## Verbalization

An activity that clearly facilitates long-term memory storage is **verbalization**—talking or writing about an experience that either has previously happened or is currently happening. Children often talk with their parents or teachers about past and current events, and their memory for those events is enhanced as a result (Fivush, Haden, & Reese, 2006; McGuigan & Salmon, 2004; K. Nelson, 1996). For older children and adults, verbalization can also take the form of **self-explanation**, in which learners talk to themselves in an attempt to understand difficult subject matter. For example, when reading a challenging textbook chapter, students might paraphrase the parts they understand, identify parts with which they're having trouble (e.g., "This is confusing"), draw inferences from the ideas presented, and summarize what they've read. When students are encouraged to engage in overt self-explanation as they study something, they're more likely to elaborate on it and so better understand and remember the content (R. K. Atkinson, Derry, Renkl, & Wortham, 2000; de Bruin, Whittingham, Hillebrand, & Rikers, 2003; deLeeuw & Chi, 2003; McNamara & Magliano, 2009).

Writing provides yet another form of verbalization that can facilitate long-term memory storage. For instance, when students write about what they're reading in their textbooks—answering study questions, relating the material to things they already know, analyzing various points of view, and so on—they're more likely to engage in such storage processes as meaningful learning, internal organization, and elaboration (S. L. Benton, 1997; R. E. Burnett & Kastman, 1997; S. Greene & Ackerman, 1995; T. Shanahan, 2004).

## Enactment

By **enactment**, I mean engaging in an overt psychomotor behavior—actually *doing* something—that in some way reflects what's being learned. The importance of enactment has popped up in previous chapters under different guises: In our discussion of behaviorism (Chapters 3 through 5), we noted the importance of *active responding* in learning, and in our discussion of social cognitive theory (Chapter 6), we noted the importance of *motor reproduction* in modeling.

A wide variety of physical actions seem to promote long-term memory storage. Young children can more easily remember a story when they can act out the story with toy figures, and they can more easily remember geometric shapes when they can actually draw the shapes (A. M. Glenberg, Gutierrez, Levin, Japuntich, & Kaschak, 2004; Heindel & Kose, 1990). College students studying physics can better apply the things they learn about how pulley systems work when they can experiment with actual pulleys rather than when they simply look at diagrams of various pulley systems (Ferguson & Hegarty, 1995).

Physical enactment is, of course, especially helpful when people are learning complex motor skills—that is, when they’re acquiring procedural knowledge. In such instances, people typically learn most effectively when they get regular feedback about how they’re doing (R. M. Gagné, 1985; Proctor & Dutta, 1995). Sometimes such feedback follows directly from their performance; for instance, a new tennis player can see where he hits each ball, and a novice car driver knows that she needs more practice with shifting gears if she keeps stalling a standard-transmission engine every time she tries to move the car forward. In other cases, however, people learn more effectively when a more advanced individual (e.g., a coach) commends them for proper form or gives them constructive suggestions on what they might do differently (Kladopoulos & McComas, 2001; Kluger & DeNisi, 1998; J. V. Stokes, Luiselli, & Reed, 2010).

As we discovered in Chapter 4, behaviorists think of feedback as a form of *positive reinforcement*. And as we noted in Chapter 6, social cognitive theorists propose that feedback affects learners’ *self-efficacy*. Here we see a third role that feedback can play: a source of *information* that can help learners improve their performance. Whenever possible, teachers should provide such information immediately so that students can store it in working memory simultaneously with their recollection of what they’ve just done; in this way, the two are more easily integrated (J. R. Anderson, 1987; Shute, 2008; J. V. Stokes, Luiselli, & Reed, 2010).

## Repetition and Review

As we’ve already seen, rehearsal is usually a relatively *ineffective* way to promote long-term memory storage. But in contrast to such short-lived rehearsal, reviewing and practicing information and procedures at periodic intervals over the course of a few weeks, months, or years clearly enhances retention and performance. This principle seems to hold true for people of all ages, even young infants (Dempster, 1991; Péladeau, Forget, & Gagné, 2003; Proctor & Dutta, 1995; Rohrer & Pashler, 2010; Rovee-Collier, 1993).

In essence, recent researchers have supported early verbal learning theorists’ finding that *overlearning* facilitates memory. A second verbal learning principle is also relevant here: Additional learning and practice sessions are typically more effective when they’re spaced out over a period of time—that is, when they reflect *distributed practice* rather than *massed practice* (H. P. Bahrick, Bahrick, Bahrick, & Bahrick, 1993; Dempster, 1991; Kornell, Castell, Eich, & Bjork, 2010; Pashler, Rohrer, Cepeda, & Carpenter, 2007). In the lingo of contemporary cognitive psychology, this phenomenon is known as the **spacing effect**.

It’s important to note that learning is sometimes a bit *slower* when it’s spread out over time. Its benefits are most clearly seen when we look at *long-term retention* rather than speed of initial learning (H. P. Bahrick et al., 1993; M. C. Linn, 2008; Rawson & Kintsch, 2005). For example, in a study conducted on the Internet (Cepeda, Vul, Rohrer, Wixted, & Pashler, 2008), adult volunteers who lived in various countries around the world studied a list of 32 obscure trivia facts, such as “What European nation consumes the most spicy Mexican food?” (p. 1097). The participants studied the list again in a study session that might be as little as 1 day to 4 months later. Finally, in a third session—which was delayed by as little as a week or as much as a year—they were tested on the facts. The longer the final test session was delayed, the longer was the optimal spacing of the two study sessions. If we really want to remember information for the long haul, then, we should review it periodically at lengthy intervals (also see Pashler et al., 2007; Rohrer & Pashler, 2010). (In case you’re curious, Norwegians are especially partial to spicy Mexican food.)



Mere exposure to information—no matter how often—isn't enough, however. As is true for most learning, a person must, at a minimum, pay attention to the information. For instance, in one classic experiment, American college students were shown drawings of 15 different versions of a Lincoln penny. Despite the thousands of times that the students had seen and handled pennies, a sizable proportion of them couldn't pick out the correct version (Nickerson & Adams, 1979). When searching for pennies, Americans don't need to look at minute details to distinguish them from other coins because their color alone (brownish rather than silver) is a surefire indicator.

By reviewing and practicing what we've learned over a period of time, we probably accomplish several things. First, we engage in additional processing—processing that may allow us to elaborate on learned information in new ways and so understand it more thoroughly (Dempster, 1991; McDaniel & Masson, 1985). Second, by reviewing the same information repeatedly, especially in different contexts, we form more and stronger associations with other things in memory; as a result, we can more readily recall the information when needed at a future time (J. R. Anderson, 2005; Calfee, 1981; M. C. Linn, 2008). Continued practice seems to have a third benefit as well: It promotes automaticity.

### ***Development of Automaticity***

Schneider and Shiffrin (1977; Shiffrin & Schneider, 1977) have distinguished between two types of information processing: controlled and automatic. **Controlled processing** requires much of a learner's attention and is likely to use most or all of the learner's working memory capacity. In other words, controlled processing requires conscious thought and effort. An example is the cognitive processing necessary for learning to drive a car. I still remember the summer evening many years ago when my father tried to teach me to drive using the standard transmission in our 1951 Ford convertible (no, I'm not *that* old; the car was almost an antique at the time). Trying to steer the car in the right direction while simultaneously monitoring the speed and negotiating the stick shift and clutch consumed all my attention and working memory capacity. In fact, my working memory must have been overflowing, because I kept forgetting to step on the clutch, thus jerking the car forward and almost catapulting my father into outer space. (Dad enrolled me in a drivers' education class the following morning.)

In contrast, **automatic processing**, also known as **automaticity**, occurs with little or no conscious attention or effort and requires little working memory capacity; it is, in a sense, "thoughtless." Controlled processes become increasingly automatic through repetition and practice (J. R. Anderson, 2005; Beilock & Carr, 2003; Cheng, 1985; Pashler et al., 2007). As I continued to drive that 1951 Ford, I gradually became more proficient, and I was able to devote less and less mental effort to the task of driving. After several months of persistent practice, I was cruising Main Street with my friends, tapping my fingers to early Beatles music on the radio, munching McDonald's french fries (12 cents a bag in those days), and scanning the sidewalk for male classmates of particular interest. Even though my car had a standard transmission, driving had essentially become an automatic activity for me.

Many academic tasks require performing a number of subtasks at more or less the same time. In order for these multi-subtask tasks not to overwhelm working memory, some of the subtasks should in most cases be automatic. Consider the case of reading. Comprehending what one reads is often a difficult task involving controlled, conscious effort. If learners are to understand what they read, basic reading processes such as letter and word identification must occur automatically. In fact, research is clear on this point: The more effort a student must devote to

identifying the words on the page, the lower the student's comprehension of a passage is apt to be (B. A. Greene & Royer, 1994; Klauda & Guthrie, 2008; LaBerge & Samuels, 1974; Lervåg & Hulme, 2009).

Writing, too, is a multifaceted process that can easily exceed the limits of working memory unless some processes are automatic (Berninger, Fuller, & Whitaker, 1996; Flower & Hayes, 1981; Graham, 2006; McCutchen, 1996). Good writers devote most of their attention to the communicative aspect of writing—for instance, to expressing their thoughts in a clear, logical, and organized fashion (K. R. Harris, Santangelo, & Graham, 2010). Apparently these individuals have already learned the mechanics of writing (spelling, grammar, punctuation, etc.) thoroughly enough to apply them automatically. In contrast, poor writers devote a considerable amount of attention to writing mechanics and thus can give little thought to communicating their ideas clearly (Birnbaum, 1982; Pianko, 1979). Becoming a good writer, then, is at least partly a matter of automatizing basic skills. People can devote themselves to the task of clear self-expression only if they aren't bogged down with concerns about subject-verb agreement or the correct spelling of *psychology*.

Similarly, some aspects of mathematics—especially basic math facts—need to become second nature (R. M. Gagné, 1983; Hecht & Vagi, 2010; Mayer & Wittrock, 2006). For example, in the days when I taught a course on educational assessment, my students had to be able to solve problems such as the following before they could effectively interpret intelligence test (IQ) scores:

$$\frac{70 - 100}{15} = ?$$

To solve such a problem easily, students had to have certain arithmetic facts at their fingertips; in this case, they had to subtract 100 from 70 quickly and automatically recognize that  $-30$  divided by 15 equals  $-2$ . Students who struggled with such arithmetic often lost sight of the overall task they were trying to accomplish.

Earlier in the chapter, I emphasized the importance of meaningful learning. Meaningful learning is certainly important for basic knowledge and skills. To the extent possible, students must be able to make sense of simple facts and procedures, relating them to other things already known about the world. At the same time, meaningful learning isn't enough for things that must be recalled quickly and automatically. These things should be repeated and practiced often enough that they become second nature.

Yet automaticity has its downsides as well. For one thing, people may perform habitual actions without even thinking about them, to the point where they can't remember whether or not they've done them (Reason & Mycielska, 1982). For example, occasionally I start to wonder if I've closed the garage door behind me after I've left the house for the day, and I may fret about the issue so much that I return home to make sure that the door is, in fact, closed. A more serious disadvantage of automaticity is that it increases the likelihood that an individual will quickly recall certain ideas or perform certain procedures when other, less automatic ideas or procedures are more useful (Killeen, 2001; Langer, 2000; LeFevre, Bisanz, & Mrkonjic, 1988). People are far more flexible—and thus far more likely to identify unique approaches to situations or creative solutions to problems—when they aren't automatically locked in to a particular response. We'll revisit this issue in our discussion of *mental set* in problem solving in Chapter 15.

## PROMOTING EFFECTIVE STORAGE PROCESSES

---

I often hear educators and educational psychologists making the distinction between teacher-centered and learner-centered approaches to instruction. By *teacher-centered instruction*, they mean methods in which the instructor directly presents the material to be learned—for instance, through lectures, explanations, textbooks, and educational videos. Because teacher-centered methods often present information in essentially the same form that students are expected to learn it, they are sometimes called **expository instruction**. In contrast, *learner-centered instruction* encourages students to construct their *own* knowledge and understandings, although usually within the context of planned activities and some degree of teacher guidance. Discovery learning, whole-class and small-group discussions, cooperative learning, and group problem-solving activities are all examples of learner-centered instruction.

In my opinion, the terms *teacher-centered* and *learner-centered* are misnomers. Presumably students are at the center of *any* form of instruction, in that teachers design their lessons with students' learning, rather than their own learning, in mind. The key difference isn't one of focus but rather one of *control*: Students direct the course of learning to a greater degree in learner-centered approaches than in teacher-centered approaches. Hence I suggest that we use slightly different terminology. In **teacher-directed instruction**, the teacher calls most of the shots, choosing what topics will be addressed, directing the course of the lesson, and so on. In **learner-directed instruction**, students have considerable say in the issues they address and how to address them.

Historically, most instruction has been the teacher-directed variety. Yet some early psychologists criticized teacher-directed instruction—especially the lecture method—because it doesn't allow for active student responses and hands-on involvement (e.g., Bruner, 1961a, 1961b; B. F. Skinner, 1968; B. F. Skinner & Epstein, 1982). And in recent years, many educators and educational psychologists have called for learner-directed approaches, especially those in which students interact in large or small groups. Such group-based approaches can be highly effective, but we'll be in a better position to understand their value after we've examined Lev Vygotsky's theory of cognitive development; hence, we'll examine them more closely in Chapter 13.

In the meantime, we should note that teacher-directed instruction has many advocates among contemporary cognitive theorists (e.g., Heal, Hanley, & Layer, 2009; Mayer, 2004, 2010a; Pressley, 1995; Rittle-Johnson, 2006; Weinert & Helmke, 1995). These theorists suggest that although students must often sit quietly as they listen to a teacher's explanation or lecture, nevertheless they may be *cognitively* active, busily attending to and meaningfully interpreting what they hear. Ultimately, what matters most about any instructional method is not whether it's teacher- or learner-directed but *how well it promotes effective storage processes*.

Unfortunately, some educators seem to forget this basic principle. All too often, classroom instruction and assessment methods emphasize the learning of classroom material in a verbatim manner, with little or no regard for its underlying meaning (Mac Iver, Reuman, & Main, 1995; L. Shepard, Hammerness, Darling-Hammond, & Rust, 2005). Many school textbooks are equally guilty, presenting lists of facts without showing relationships among them or considering what students might already know or *not* know about the topic (I. L. Beck and McKeown, 1994, 2001; Berti, 1994; Brophy, Alleman, & Knighton, 2009; Chambliss, Calfee, & Wong, 1990). To get a sense of what students may encounter in their textbooks, read the following textbook passage:

*The Langurian and Pitok War.* In 1367 Marain and the settlements ended a 7-year war with the Langurian and Pitoks. As a result of this war Languria was driven out of East Bacol. Marain would now rule Laman and other lands that had belonged to Languria. This brought peace to the

Bacolian settlements. The settlers no longer had to fear attacks from Laman. The Bacolians were happy to be a part of Marain in 1367. Yet a dozen years later, these same people would be fighting the Marish for independence, or freedom from United Marain's rule. This war was called the Freedom War or the Bacolian Revolution. A revolution changes one type of government or way of thinking and replaces it with another. (I. L. Beck & McKeown, 1994, p. 239)

Confused? The passage is from an actual American history textbook, albeit with a few modifications:

- 1763 has been changed to 1367
- Britain has been changed to Marain
- Colonies has been changed to settlements
- French has been changed to Langurian
- Indians has been changed to Pitoks
- North America has been changed to East Bacol
- Canada has been changed to Laman
- War for Independence has been changed to Freedom War
- American has been changed to Bacolian

If I were to show you the original passage, you would understand it easily if you grew up in the United States or for some other reason already know about the French and Indian War and the American Revolution. But for many American fifth graders, the original passage is almost as confusing as the modified one just presented, because they have little prior knowledge about the countries and events described (I. L. Beck & McKeown, 1994).

Perhaps as a result of instruction, textbooks, assignments, and assessment methods that downplay the importance of learning classroom subject matter in a meaningful fashion, students often engage in rote learning (D. E. Brown & Hammer, 2008; Newstead, 2004; Novak & Musonda, 1991; Prawat, 1989). Yet even the most teacher-directed lesson can promote meaningful learning and other effective storage processes. Following are a number of principles that should guide instructional practice regardless of whether it's teacher-directed or learner-directed:

◆ *Instruction is more effective when it activates and builds on students' prior knowledge.* Even when students have existing knowledge to which they can relate new material, they aren't always aware of connections they might make (Paris & Lindauer, 1976; Spires & Donley, 1998; Spires, Donley, & Penrose, 1990; Stodolsky, Salk, & Glaessner, 1991). Thus, effective instruction includes **prior knowledge activation**: It begins with what students already know and continues to remind students of additional things they know that relate to the topic at hand. For example, teachers and students might discuss a topic in class before students begin a reading assignment about it (Hansen & Pearson, 1983; P. T. Wilson & Anderson, 1986). And when content studied at a previous time is important for understanding something new, teachers might provide a quick refresher of that content.

When students have virtually *no* prior knowledge about a topic, teachers might provide actual experiences on which subsequent instruction can build. Consider, for example, the idea of *taxation without representation*—a policy that greatly distressed the American colonists in the pre-Revolution 1700s. Many adults can easily relate the idea of taxation without representation to their own frustrations with high taxes, but most fifth graders have little or no experience on which to build in understanding the colonists' situation. To help students empathize with the colonists' circumstances, a teacher might conduct an activity in which students are told to give

valued objects to fellow students (only temporarily) without regard for their own wishes in the matter. I frequently use this create-an-experience strategy myself, not only in my classes but also in my books; asking you to read the passage about the Langurian and Pitok War a bit earlier was an example of the kinds of things I do. I then follow up by relating new concepts and principles to the experience my students or readers have just had.

Another effective strategy is to provide analogies that relate classroom subject matter to familiar concepts and situations (Bulgren, Deshler, Schumaker, & Lenz, 2000; Donnelly & McDaniel, 1993; Pinker, 2007; Zook, 1991). Figure 9.9 presents examples of effective analogies for a variety of classroom topics. Analogies help students learn information more meaningfully and retrieve it more easily, especially when the topic is a new one for students or when the material is fairly abstract. At the same time, teachers must be careful to point out ways in which the two things being compared are *different*. Otherwise, students may take an analogy too far and draw incorrect conclusions (Duit, 1990; Sfard, 1997; Zook & Di Vesta, 1991).

◆ *Students are more likely to engage in meaningful learning when they're explicitly encouraged to do so.* Students must approach new information with the attitude that they can understand and make sense of it. In other words, they must approach it with a **meaningful learning set** (Ausubel et al., 1978; M. A. Church, Elliot, & Gable, 2001). Students are more likely to have this attitude when teachers emphasize understanding rather than verbatim recitation—for instance, when students know they'll be expected to explain concepts in their own words rather than reproduce textbook definitions. But ultimately, students must have confidence that they *can* understand new material. Students who've learned through past experience that certain kinds of subject matter are confusing or incomprehensible are more likely to resort to a rote-learning approach (Ausubel & Robinson, 1969; Bandalos et al., 2003).

◆ *Students often need guidance in determining what things are most important to learn.* When instruction provides a great deal of information, students may have trouble deciding which things are most important and relevant to instructional objectives (Dole et al., 1991; McCrudden & Schraw, 2007; Naumann et al., 2007). For example, students might focus their attention on interesting, relatively trivial details at the expense of less interesting but more important ideas, or perhaps they will look at the equations they see in a scientific proof while disregarding any verbal explanation of the equations (P. A. Alexander & Jetton, 1996; Dee-Lucas & Larkin, 1991; Garner, Alexander, Gillingham, Kulikowich, & Brown, 1991).

A variety of **signals** pointing to important information can facilitate students' learning from expository instruction. For example, writing key points on the board is a means of emphasizing those points. Underlining or italicizing important phrases and sentences in a textbook passage makes them more prominent. Identifying explicit instructional objectives for a lesson lets students know what they should focus on. And questions interspersed throughout a lecture, a textbook passage, or computer-based expository material draw students' attention to particular ideas (Armbruster, 1984; J. Hartley, Bartlett, & Branthwaite, 1980; Lorch, Lorch, & Inman, 1993; McAndrew, 1983; McCrudden & Schraw, 2007; McDaniel & Einstein, 1989; Naumann et al., 2007; Niederhauser, 2008).

◆ *Instruction is more effective when it helps students organize new material.* A variety of strategies can help students organize what they're learning. One widely recommended strategy is an **advance organizer**, a general introduction to new material that's typically designed to accomplish either or both of two purposes (Ausubel et al., 1978). An *expository organizer*

- If we think of the earth's history as a *24-hour day*, human beings have been in existence only for the last minute of that day (Hartmann, Miller, & Lee, 1984).
- The growth of a glacier is like *pancake batter being poured into a frying pan*. As more and more substance is added to the middle, the edges spread farther and farther out (courtesy of R. K. Ormrod).
- The human circulatory system is similar to a *parcel delivery system*. "Red blood cells work like trucks, carrying needed materials from a central distribution point for delivery throughout the body. Arteries and veins are like roads, acting as access routes through which the various points of delivery are reached. The heart is like the warehouse or the central point in which vehicles are loaded and dispatched, and to which empty vehicles are returned to be reloaded" (Stepich & Newby, 1988, p. 136).
- Peristalsis, a process that moves food through the digestive system, is "like *squeezing ketchup out of a single-serving packet*. You squeeze the packet near one corner and run your fingers along the length of the packet toward an opening at the other corner. When you do this, you push the ketchup through the packet, in one direction, ahead of your fingers, until it comes out of the opening" (Newby, Ertmer, & Stepich, 1994, p. 4, emphasis added).
- Any horizontal surface, such as a table, exerts force on an object that rests on it. You might think of the table as a *spring* that is compressed when something is put on top of it. The spring pushes up against the object (D. E. Brown & Hammer, 2008).
- Tying a bowline knot is like a *rabbit guarding the territory around its home*. You hold the rope vertically and make a loop near the middle. The loop is the rabbit hole, the upper end of the rope is the tree, and the lower end is the rabbit. The rabbit goes up and out of the hole, around the tree, and back down the hole (D. A. Hayes & Henk, 1986).
- A dual-store model of memory is like the *information selection and storage system you use at home*. Some things (e.g., junk mail) are discarded as soon as they arrive, others (e.g., bills) are dealt with only briefly, and still others (e.g., driver's license) are used regularly and saved for a long period of time (see Chapter 8 of this book).
- Retrieval from long-term memory is like *looking for something in a large, dark room with only a small flashlight*. You can look at only one small spot at a time, and it's virtually impossible to look everywhere (Lindsay & Norman, 1977; see Chapter 11 of this book).

**Figure 9.9**

Examples of analogies that promote connections between new ideas and things students already know

provides a rough overview or outline of the material, describing the general topics that will be presented and their relationship to one another; thus, it provides the beginnings of an internal organizational scheme. A *comparative organizer* shows how the new material relates to students' previous experiences, to information they've previously learned in school, or possibly to their purposes for studying the material—in other words, it activates students' prior knowledge.

Research consistently demonstrates the effectiveness of advance organizers in facilitating learning, especially when material isn't clearly organized and students have trouble organizing and making sense of it on their own. A variety of formats—overviews, outlines, analogies, examples, and thought-provoking questions—all appear to be effective, especially when they're fairly

concrete (L. Alexander, Frankiewicz, & Williams, 1979; Corkill, 1992; Glynn & Di Vesta, 1977; Mayer, 1979, 1984; Mayer & Bromage, 1980; Naumann, Richter, Flender, Christmann, & Groeben, 2007; Zook, 1991). In some situations, an advance organizer might even take a graphic rather than strictly verbal form. For example, when introducing a unit on minerals, a hierarchical diagram similar to the one in Figure 9.5 might provide a helpful visual overview—an expository advance organizer.

Once expository instruction is well underway, it should ideally present new information in the basic organizational format in which students should store it in memory (Dansereau, 1995; Niederhauser, 2008; Wade, 1992). For example, teachers facilitate students' learning when they present ideas in a logical sequence, identify hierarchical relationships that exist among concepts, and make cause-and-effect relationships clear. Showing how material should be organized and interrelated may be especially important for students with little relevant background knowledge or a history of learning difficulties (deLeeuw & Chi, 2003; Krajcik, 1991; Mayer, 2010a; Niederhauser, 2008).

Yet another effective strategy is a **concept map** or **knowledge map**—a diagram of a unit's concepts or main ideas (often identified by circles) and the interrelationships among them (often designated by lines and by words or phrases that link two concepts or ideas together). As an illustration, Figure 9.10 presents a concept map that a teacher might use to organize some of the key concepts in a lesson on ancient Egyptian art. But students, too, can be shown how to construct concept maps that help them organize what they're learning. Both teacher- and student-constructed organizational maps have often been shown to facilitate learning, provided that they're not so detailed that they overwhelm students' working memory capacities (Hofman & van Oostendorp, 1999; Novak, 1998; O'Donnell, Dansereau, & Hall, 2002; Stull & Mayer, 2007).

◆ *Instruction is more effective when it encourages students to elaborate on what they're learning.* Many classroom activities can potentially promote student elaboration of classroom subject matter. For example, asking students to talk about a topic, perhaps within the context of a class discussion or cooperative learning activity, almost forces them to do *something* (mentally) with the material (more on this point in Chapter 13). Asking questions that require students to draw inferences from what they're learning—and also having students themselves formulate and then answer such questions—can be helpful as well (Croninger & Valli, 2009; A. King, 1994, 1999; McCrudden & Schraw, 2007). And when students tutor their classmates on subject matter they presumably know quite well, they learn it at an even higher level of understanding (Inglis & Biemiller, 1997; O'Donnell, 2006; Roscoe & Chi, 2007; Semb, Ellis, & Araujo, 1993).

Teachers must remember, however, that elaboration can sometimes lead students to acquire erroneous ideas, especially if the students already have misconceptions about the topic at hand. Teachers must continually monitor students' understanding of classroom material—perhaps by asking questions, assigning regular homework, or giving occasional quizzes—and then take steps to correct any misinterpretations that students' responses reveal. Some of their misconceptions may be stubborn ones that aren't easily corrected; we'll identify strategies for changing such misconceptions in our discussion of *conceptual change* in Chapter 10.

◆ *Visual aids enhance long-term memory storage.* As we've seen, visual imagery can be a highly effective way of encoding information and may be especially valuable when used in conjunction with such other storage processes as meaningful learning or elaboration. Thus, presenting information in visual form—through physical objects, pictures, maps, diagrams, graphs, live models, and so on—is often a helpful supplement to verbal material (Carney & Levin, 2002;

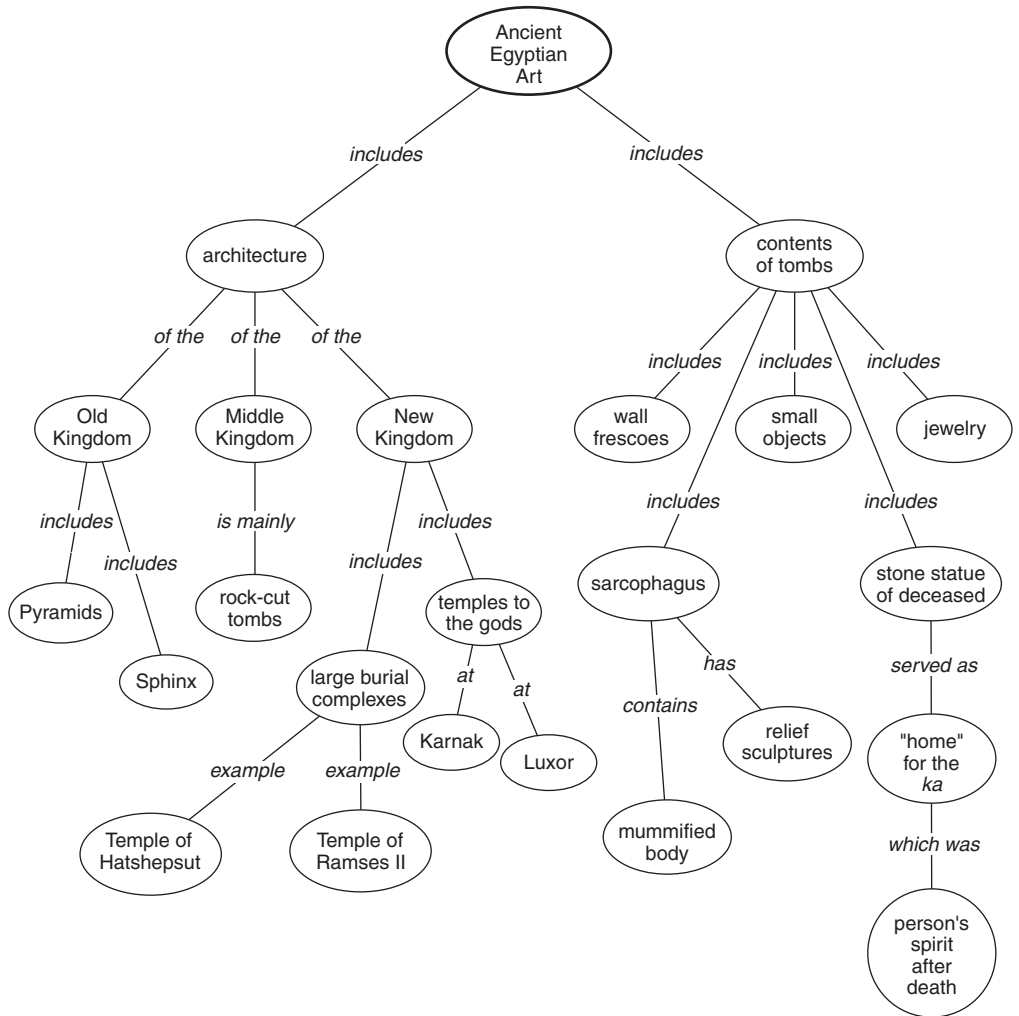

**Figure 9.10**  
A possible concept map for a lesson on ancient Egyptian art

Garry & Gerrie, 2005; Mayer, 2010a; Verdi & Kulhavy, 2002; Winn, 1991). Although you might think that adding visual aids to verbal material could overburden a limited-capacity working memory, in fact visuals seem to *reduce* the strain on working memory—apparently because they provide an external, outside-of-working-memory means of storing some of the information a learner is trying to make sense of (Butcher, 2006; R. Carlson, Chandler, & Sweller, 2003).

Also effective is having students create their *own* illustrations of concepts and principles they’re studying. For example, students might show how the nervous system works by drawing a diagram of a neuron, or they might illustrate gravity, friction, and kinetic energy using a picture of a roller coaster (Edens & Potter, 2001; Schwaborn, Mayer, Thillmann, Leopold, & Leutner, 2010; Van Meter, 2001).



In most situations, visual aids should be simple, concise, and clear, presenting major ideas without overwhelming students with detail (Butcher, 2006; P. Shah & Hoeffner, 2002; Vekiri, 2002). Images in color seem to be more memorable than those in black and white, with the colors being an integral part of what learners encode (I. Spence, Wong, Rusan, & Rastegar, 2006). In addition to promoting visual imagery, many visual aids help students see how major ideas relate to and affect one another; thus they provide one more way of helping students organize information (Levin & Mayer, 1993; Schwaborn et al., 2010; Winn, 1991).

It's important, however, that pictures and other visual aids be relevant to the material students are studying. Irrelevant pictures and graphics that are included in books and other printed material solely to enhance the material's attractiveness can sometimes distract the learner's attention away from the information that needs to be learned (Carney & Levin, 2002; Samuels, 1967, 1970; Sweller, 2008).

♦ *The most effective ways to teach procedural knowledge depend to some degree on the nature of the procedures to be learned.* When a new skill is almost entirely a behavioral one, with little or no cognitive involvement, then pictorial illustrations, live demonstrations, verbal rehearsal of the steps involved, and practice with immediate feedback can all be quite effective (Shute, 2008; SooHoo et al., 2004; J. V. Stokes, Luiselli, & Reed, 2010; Vintere, Hemmes, Brown, & Poulson, 2004; Zimmerman & Kitsantas, 1999). Also helpful is videotaping the learner in action, with subsequent analysis and feedback regarding the strengths and weaknesses of the performance (Bear, Torgerson, & Dubois-Gerchak, 2010; LeBlanc et al., 2003; J. V. Stokes, Luiselli, Reed, & Fleming, 2010).

Additional strategies are called for when procedures and skills involve considerable mental work, as is true for solving math problems, repairing car engines, and playing a strategic game of tennis. In such circumstances, instruction about procedures must go hand in hand with instruction that helps students understand why the procedures make sense—that is, procedural knowledge and declarative knowledge should be learned in tandem. For example, the instructor might verbalize his or her own thoughts—thereby demonstrating *mental* procedures and their rationales—while engaging in the task (recall our discussion of *cognitive modeling* in Chapter 6). Similarly, students can be asked to explain what they're doing and why they're doing it as they practice (deLeeuw & Chi, 2003; Dominowski, 1998). When procedures are fairly complex and multifaceted, teachers may want to break them down into smaller tasks and have students practice each one separately at first (J. R. Anderson, Reder, & Simon, 1996; Beilock & Carr, 2003; van Merriënboer & Kester, 2008).

Chapters 14 and 15 describe other strategies for facilitating the acquisition of procedural knowledge, particularly as it's related to metacognition and problem solving, respectively.

♦ *Students learn new material more effectively when they have sufficient time to process it well.* Effective long-term memory storage processes—meaningful learning, internal organization, elaboration, visual imagery—often take *time*. In learner-directed instructional activities, students have considerable control over how they spend their time, and so they can stop when they need to in order to think things through. But in teacher-directed instructional activities, the teacher is largely in control of the pacing and must be sure to give students the processing time they need. For example, when giving a lecture, teachers might lecture for 8 or 10 minutes and then give students a 2-minute interval in which to compare notes and clarify subject matter with one another (Rowe, 1987).

♦ *End-of-lesson summaries promote learning and retention.* As noted in our earlier discussion of advance organizers, students tend to learn more effectively when they receive advance notice

of the things they'll be learning. Students also tend to benefit from summaries presented at the end of a verbal lecture or written passage: They learn more effectively when they hear or read a synopsis of the information they've just studied (J. Hartley & Trueman, 1982; Lorch et al., 1993; Naumann et al., 2007). Summaries probably serve multiple functions for students: They can help students (1) review material, (2) determine which of the many ideas they've studied are most important, and (3) pull key ideas into a more cohesive organizational structure.

- ◆ *Effective instruction provides opportunities for review and practice of previously learned knowledge and skills.* As we've seen, rehearsal of information within a short time span (e.g., less than a minute) is a relatively ineffective way to store information in long-term memory. But occasional repetition of learned information over a longer period of time—for instance, over the course of a few days, weeks, or months—*does* enhance storage and retention. Thus teachers should have students review and practice important material throughout the school year, perhaps by integrating the material into the context of new lessons. Repetition is especially important for facts and skills that students need every day—basic number facts, spellings of commonly used words, punctuation rules, and so on. Basic information and skills should certainly be learned as meaningfully as possible, but they should also be practiced until students can retrieve them quickly and automatically.

- ◆ *Learning quickly doesn't always mean learning better.* Earlier in the chapter, we noted that distributed practice sometimes leads to slower learning than massed practice but tends to promote greater retention of material over the long run. More generally, the speed with which students learn something isn't necessarily a good indication of how *well* they've learned it (Phye, 2001; Rohrer & Pashler, 2010; Salomon, 1979/1994; R. A. Schmidt & Bjork, 1992). To truly master a topic, students must relate it to things they already know, form many interconnections among its various parts, draw inferences about and in other ways elaborate on it, and perhaps learn certain aspects of it to automaticity. Such things take time—in some cases a great deal of time—but for important topics and skills, it's time well spent.

Furthermore, although a certain amount of feedback is essential for learning to take place, occasional rather than continual feedback about one's performance may sometimes promote performance over the long run, even though it may result in slower improvement initially (R. A. Schmidt & Bjork, 1992). It may be that learners need practice not only in performing certain tasks but also in retrieving relevant knowledge about each task and giving *themselves* feedback about their performance (R. A. Schmidt & Bjork, 1992; Shute, 2008). And when learners make errors along the way—and especially when they're given guidance about how to *detect* and *correct* their errors—they become more comfortable with occasional mistakes and perform better over the long run (Keith & Frese, 2005; Mathan & Koedinger, 2005).

## SOME FINAL REMARKS ABOUT LONG-TERM MEMORY STORAGE \_\_\_\_\_

Before we leave our discussion of long-term memory storage, we should note a few final, general points about storage processes:

- ◆ *Long-term memory storage is idiosyncratic.* Any two people store different information from the same situation, and for several reasons. First, they attend to different aspects of the situation, and thus they store different information in their working memories. Second, they encode information in different ways; for example, some people store a great deal in a language-based form whereas others rely more heavily on visual imagery (Mayer & Massa, 2003). And third, they

bring their unique background experiences to the situation so that their interpretations are truly their own.

◆ *Storage of new information sometimes affects previously learned information as well.* Consistent with the process of elaboration, learners sometimes distort new material to fit their existing beliefs. Yet in other situations, a new piece of information may help learners recognize that something they stored earlier is inaccurate or that two previously learned pieces of information are related in a way they hadn't previously recognized.

◆ *The ways in which people store new information affect both the nature of the knowledge they possess and the ease with which they can retrieve that knowledge later on.* In the next two chapters we'll consider two other topics related to long-term memory: the nature of knowledge (Chapter 10) and retrieval processes (Chapter 11). As we address these topics, we'll continually find that long-term memory storage processes are inextricably related both to what we know and how easily we can recall it at a future time.

---

## SUMMARY

Many theorists believe that long-term memory storage processes are often constructive in nature. We typically store *less* than we've sensed because our working memories can't hold all the input that our sensory registers temporarily record. At the same time, we also store *more* than we've sensed, using the incomplete data we receive to construct a logical understanding of the objects and events we encounter.

Long-term memory storage involves a variety of cognitive processes. *Selection* is the process of distinguishing between information we should process further and information that's irrelevant to our needs. *Rehearsal* is repeating something over and over in a relatively meaningless (rote) fashion; its effectiveness in promoting long-term memory storage is questionable at best. *Meaningful learning* is connecting new material with similar ideas already stored in memory; in other words, it's a process of making sense of the material. *Internal organization* is the integration of various pieces of new information into a cohesive, interrelated whole. *Elaboration* involves embellishing on new information using one's previously acquired knowledge and beliefs. And *visual imagery* is encoding information in a mental "picture" of sorts that captures its physical appearance to some extent.

Most research investigating the effectiveness of long-term memory storage processes has involved

declarative knowledge (e.g., facts, concepts, principles). But these storage processes may also play a role in the acquisition of procedural knowledge (e.g., motor skills, problem-solving strategies), in part because declarative knowledge can evolve into procedural knowledge and can also support learners' efforts in the early stages of acquiring a new skill. The neurological underpinnings of long-term storage of declarative and procedural knowledge alike may require some time—perhaps several minutes or hours, perhaps even longer—to *consolidate*.

Several cognitive factors affect long-term memory storage. Learners are likely to relate new material to their existing knowledge only when both things are in working memory at the same time. A greater amount of existing knowledge about a topic—provided that it's *accurate*—usually facilitates long-term memory storage. Expectations about what will be seen or heard often yield more rapid and efficient learning. However, misconceptions and inaccurate predictions about the topic under consideration sometimes lead to distortions in what's learned and remembered.

Overt behaviors can affect long-term memory storage as well. It's often helpful to talk about, write about, or physically enact aspects of the information and skills being learned. Furthermore, although

repetition of information within a period of a few seconds or minutes (rehearsal) usually *isn't* a very effective way of storing information in the first place, occasional repetition of information stretched out over a lengthy time period makes the information easier to remember in the long run. Knowledge and skills needed on a regular basis should, in many cases, be practiced over and over until they're learned to a level of *automaticity*—that is, until they can be retrieved and used quickly and effortlessly.

Contemporary psychologists have made a distinction between teacher-centered and learner-centered instruction; the two approaches might better be described as *teacher-directed* versus *learner-directed*

instruction. Although some theorists have argued that one approach is better than the other, in fact the effectiveness of either approach depends on the cognitive processes it encourages students to engage in. Regardless of the instructional methods used, teachers can foster effective long-term memory storage processes in a wide variety of ways—for instance, by activating students' prior knowledge about a topic, helping students organize and integrate new material, giving signals about what's most important to learn and remember, encouraging students to draw inferences and in other ways elaborate on ideas, and providing numerous opportunities for practice and review.

# LONG-TERM MEMORY II: THE NATURE OF KNOWLEDGE

### *The Various Kinds of Knowledge*

*Declarative and Procedural Knowledge*

*Explicit and Implicit Knowledge*

### *How Knowledge Is Encoded in Long-Term Memory*

*Encoding in Terms of Physical Characteristics*

*Encoding in Terms of Actions*

*Encoding in Terms of Symbols*

*Encoding in Terms of Meanings*

*Different Forms of Encoding Are Not Mutually Exclusive*

### *The Organization of Long-Term Memory*

*Long-Term Memory as a Hierarchy*

*Long-Term Memory as a Network*

*Parallel Distributed Processing*

### *Concepts*

*Theories of Concept Learning*

*Factors Facilitating Concept Learning*

### *Schemas and Scripts*

*Personal Theories*

*Personal Theories versus Reality*

*Fostering Theory Development*

### *Worldviews*

*The Challenge of Conceptual Change*

*Promoting Conceptual Change*

*Development of Expertise*

*Generalizations about the Nature of Knowledge*

*Summary*

**T**ake a few minutes to answer the following questions:

1. What did you do yesterday?
2. In what kind of house or apartment did you live when you were 9 years old?
3. What is a *noun*?
4. How are rote learning and meaningful learning different?
5. What's the best mode of transportation around the town or city in which you live?
6. What prominent individuals would be good choices for leading your country in the next 2 or 3 decades?
7. How do you ride a bicycle?
8. When buying things at the supermarket, how do you decide which checkout line to go to?
9. What are some reasons why people own horses?
10. Why do many people prefer grass rather than gravel in their front yards?

These questions asked you about 10 very different topics, but I suspect that you could easily respond to most of them. Even if you always lose at Trivial Pursuit and would never dream of becoming a contestant on the television game show *Jeopardy*, you nevertheless have a great deal of information stored in your long-term memory. Some of what you know relates to your personal life experiences (see Questions 1 and 2), but much more of it is general knowledge about the world. You've acquired some of your knowledge from teachers or textbooks (see Questions 3 and 4), but you've probably picked up a vast amount on your own over the years. Some of your "knowledge" isn't necessarily fact but instead reflects your personal beliefs and preferences (see Questions 5 and 6). Furthermore, you don't only know and believe things about your own past

history and the world around you, but you also know how to do a great many things (see Questions 7 and 8). And you've pulled some of what you know and believe into more general understandings of why the world is the way it is (see Questions 9 and 10).

Theorists have gone in many directions in describing the possible nature of human knowledge, and it would be virtually impossible to roll all their ideas into a tight little package. But we can distinguish among different kinds of knowledge, speculate on the possible forms in which knowledge might be encoded, and examine various ways in which long-term memory might be organized—all of which we'll do in this chapter. We'll also consider the overall quality of knowledge that learners acquire and look at how expertise related to a particular field or discipline develops over time.

## THE VARIOUS KINDS OF KNOWLEDGE

---

In my overview of long-term memory in Chapter 8, I introduced you to two general distinctions regarding the multifaceted nature of knowledge in long-term memory: declarative versus procedural knowledge, and explicit versus implicit knowledge. Here we look at these distinctions in more detail.

### Declarative and Procedural Knowledge

As I mentioned in Chapter 8, **declarative knowledge** concerns the nature of how things are, were, or will be. Such knowledge enables you to interpret what you see and hear around you, recognize important people and places in your life, and recall past events. Many theorists believe that declarative knowledge takes at least two distinct forms: **episodic memory**—one's memory of personal life experiences<sup>1</sup>—and **semantic memory**—one's general knowledge of the world independent of those experiences (e.g., Barsalou, 2009; Bauer, 2006; S. K. Johnson & Anderson, 2004; Tulving, 1983). These two forms of declarative knowledge are different in several important ways. For instance, we *remember* events we've personally experienced (episodic) but *know* things about the world (semantic). We can often recall when a particular event happened to us (episodic) but usually *can't* recall when we acquired specific facts about the world (semantic). We're most likely to remember a certain life event when we're in the same place in which it happened, yet we can usually recall general information about the world regardless of where we are at the time. Our semantic memories typically stay with us longer than our episodic memories; for instance, we're far more likely to recall the typical menu items at a particular fast-food restaurant (semantic) than to remember what we actually ordered at that restaurant a year ago last Tuesday (episodic). And to some degree, episodic and semantic memory appear to involve different areas of the brain (Buckner & Petersen, 1996; Davachi & Dobbins, 2008; Prince, Tsukiura, & Cabeza, 2007).

---

<sup>1</sup>When theorists talk about memory for events important in one's own life, they sometimes use the term *autobiographical memory*; for example, see Bauer (2006), Eacott (1999), M. L. Howe (2003), and K. Nelson (1996).

In contrast to declarative knowledge, **procedural knowledge** involves knowing how to *do* things. For example, you probably know how to ride a bicycle, wrap a gift, and add the numbers 57 and 94. To do such things successfully, you must in some cases adapt your actions to changing conditions; for instance, when riding a bike, you must be able to turn left or right if you see an object directly in your path, and you must be able to come to a complete stop when you reach your destination. Accordingly, as you'll learn in our discussion of *productions* a bit later, procedural knowledge includes information about how to respond under different circumstances; that is, it includes **conditional knowledge**.

As you might guess, episodic, semantic, and procedural forms of knowledge are interconnected in long-term memory. For instance, when I think about what *dogs* are like (semantic knowledge), I might be reminded of how our former dog Anna once ate the leftover chocolate cake we brought home after Tina's birthday party at McDonalds (episodic knowledge), and I might be reminded, too, of how to put miniature snow boots on current dog Tobey's feet so that the boots stay on in deep snow (procedural knowledge). How was Anna able to get the chocolate cake? Why does Tobey need boots to walk in the snow? And why does putting on the boots in one way work better than putting them on in a different way? We pull some of our declarative and procedural knowledge together into **conceptual knowledge** that reflects our understanding of why certain events happened, why certain things are the way they are, and why certain procedures are effective but others are not (J. R. Anderson, 2005; L. W. Anderson et al., 2001; Byrnes, 2001). Don't let the term *conceptual* fool you, because I'm not talking about simple concepts here. Rather, conceptual knowledge involves the *integration* of numerous concepts plus other declarative knowledge—and sometimes procedural knowledge as well—into general understandings of certain situations or phenomena. In the sections on schemas and scripts, personal theories, and conceptual change later in the chapter, we'll be talking largely about conceptual knowledge.

## Explicit and Implicit Knowledge

How do you grow flowers from a packet of flower seeds? You can probably describe the process fairly accurately, explaining that you need to plant the seeds in soil, make sure they have plenty of light, water them regularly, and so on. But how do you keep your balance when you ride a bicycle? How do you move your legs when you skip? What things do you do to form a grammatically correct sentence when you speak? Such questions are more difficult to answer: Even though such activities are probably second nature to you, you can't really put your finger on exactly what you do when you engage in them.

Many theorists make a distinction between **explicit knowledge**—knowledge that we can easily recall and explain—and **implicit knowledge**—knowledge that we can't consciously recall or explain but that nevertheless affects our behavior (e.g., Frensch & Rüniger, 2003; Graf & Masson, 1993; C. A. Nelson, Thomas, & de Haan, 2006; Roediger, 1990). Sometimes people have no conscious awareness that they've learned something even though this knowledge clearly influences their actions. This is the case, for example, for people who have suffered certain types of brain damage (Bachevalier, Malkova, & Beaugard, 1996; Cermak, 1993; Gabrieli, Keane, Zarella, & Poldrack, 1997). There's also evidence that we acquire some implicit knowledge when we learn either a first or second language: We can produce grammatically

correct sentences even though we can't explain how we do it (Chomsky, 2006; N. C. Ellis, 1994; Reber, 1993).<sup>2</sup>

Sometimes knowledge is sufficiently dim that it affects us only in subtle ways. For example, when 9-year-olds look at pictures of classmates from their preschool days, they may have no conscious recollection of some of them, but their physiological responses suggest that they *do* recognize these children at some level (Newcombe & Fox, 1994). As another example, when college students are asked simple left–right orientation questions about well-known cultural images (e.g., when students in England are asked whether Queen Elizabeth faces left or right on a 10-pence coin, and when students in Japan are asked whether the cartoon character Hello Kitty wears her bow on the left or right side of her head), they can rarely tell you. However, when forced to choose between the correct orientation and its mirror image, they guess correctly about 65 to 80% of the time—hardly stellar performance, but certainly better than chance (Kelly, Burton, Kato, & Akamatsu, 2001).

## HOW KNOWLEDGE IS ENCODED IN LONG-TERM MEMORY \_\_\_\_\_

Take a minute and think about a rose. What things come to mind? Perhaps words such as *flower*, *red*, *beautiful*, *long-stemmed*, or *expensive* pop into your head. Perhaps you can picture what a rose looks like or recall how it smells. Perhaps you can even feel a thorn prick your finger as you imagine yourself reaching out to clip a rose from its bush.

Knowledge is probably encoded in long-term memory in a variety of ways. Sometimes it's stored in ways that reflect something's physical characteristics; for example, a rose has a certain look and a particular smell. At other times it's stored as physical actions; for example, one learns the procedure necessary for clipping a rose from a thorny rose bush. A third form of encoding is symbolic, represented in memory by words (e.g., "Roses are red, violets are blue"), mathematical expressions, or other symbolic systems. And finally, knowledge often takes the form of abstract meanings that transcend particular physical characteristics, actions, and symbols; for example, the fact that "a rose is a flower" might be stored as an abstract idea. Let's look at each of these forms of encoding more closely.

### Encoding in Terms of Physical Characteristics

Those parts of our brain we use to interpret what we see, hear, smell, and so on seem to be involved in helping us encode and remember what we've observed (Barsalou, Simmons, Barbey, & Wilson, 2003; Behrmann, 2000; Speer, Reynolds, Swallow, & Zacks, 2009). Such perception-based forms of encoding are often referred to as *imagery*. It appears that we can form and remember images based on most (and possibly all) of our sensory modalities—vision, hearing, smell, taste, touch, and so on (Minogue & Jones, 2006; Palmiero et al., 2009;

---

<sup>2</sup>The acquisition of explicit knowledge probably relies heavily on the hippocampus—that seahorse-shaped part of the limbic system I mentioned in Chapter 2. Other brain structures—for instance, the cerebellum and the amygdala—seem to be more heavily involved in acquiring implicit knowledge (Marcus, 2008; C. A. Nelson et al., 2006; D. J. Siegel, 1999).



Reisberg, 1992). Research and theory have emphasized visual imagery, so that will be our focus here.<sup>3</sup>

Although you may occasionally read about people who seem to have “photographic memories” (known in psychology as *eidetic imagery*), by and large visual images are *not* detailed mental snapshots (Chambers & Reisberg, 1985; Nersessian, 2008; S. Reed, 1974; Sadoski & Paivio, 2001).<sup>4</sup> In some instances, visual imagery involves envisioning motion, such as mentally “seeing” a galloping horse, “scanning” various parts of a picture, or “turning” a geometric figure (Nersessian, 2008; Sadoski & Paivio, 2001; D. L. Schwartz & Heiser, 2006).

Visual imagery sometimes has a spatial component, in that an individual can imagine how objects might be manipulated, arranged, or rearranged in space—a process that obviously involves working memory as well as long-term memory. (For example, return to my description of Shepard and Meltzer’s 1971 study, described on pp. 169–170 of Chapter 8; also see Figure 8.4.) In such cases it’s often called *visuospatial imagery*. Researchers have observed considerable variability in people’s visuospatial encoding ability—an ability that’s especially important in such fields as math, science, and engineering (Nersessian, 2008; Wai, Lubinski, & Benbow, 2009).<sup>5</sup>

Oftentimes people’s *gestures*—especially the ways they move their hands as they speak—reflect their attempts to communicate their visual images or knowledge of spatial relationships. For instance, my husband talks with his hands as much as with his mouth, and he consistently uses certain motions when he talks about certain kinds of things. Whenever he talks about something wavy in shape (e.g., a snake in the grass or a windy mountain road), he’ll move his hand forward in a snakelike manner. Whenever he talks about the size or shape of an object, he’ll use his hands to show its contours. (I once asked him to describe the dimensions of something while he was driving in the mountains of Colorado. *Big* mistake. He took both hands off the steering wheel to gesture while he described the object, and it was a miracle we didn’t end up in a ditch.) Gestures often seem to represent aspects of visual or spatial encoding that aren’t necessarily reflected in what we say, and in some instances they may communicate implicit rather than explicit knowledge (Bassok, 1997; Goldin-Meadow, 2006, 2009; Koschmann & LeBaron, 2002; Krauss, 1998; W.-M. Roth, 2001).

## Encoding in Terms of Actions

Although gestures sometimes reflect visual images or spatial relationships, on other occasions they may reflect knowledge about psychomotor behaviors—that is, they involve mental representations of particular movements of the arms, hands, legs, neck, and so on. And in general,

---

<sup>3</sup>One early and influential advocate for the existence of visual imagery as a distinct form of encoding was Allan Paivio. You might occasionally see reference to Paivio’s *dual coding theory*, which proposes that people store information in at least two qualitatively different ways: verbally and visually (e.g., J. M. Clark & Paivio, 1991; Paivio, 1971, 1986; Sadoski & Paivio, 2001). Don’t confuse dual coding theory with the *dual-store model* of memory described in Chapter 8. Dual coding theory distinguishes between two forms of encoding in long-term memory, whereas the dual-store model distinguishes between working memory and long-term memory.

<sup>4</sup>Eidetic imagery has been reported for some people with a mild form of autism known as *Asperger syndrome* (e.g., see Millbrath & Siegel, 1996; Ratey & Grandin, 1992; Rubinyi, 2007).

<sup>5</sup>Spatial encoding doesn’t always have a visual component; for instance, it might instead be based on what a learner has perceived through hearing or touch (W. L. Thompson & Kosslyn, 2000).

researchers are increasingly finding that our knowledge is often to some degree encoded in terms of how we physically behave in certain situations or toward certain objects (Andres, Olivier, & Badets, 2008; Goldin-Meadow, Cook, & Mitchell, 2009; Spunt, Falk, & Lieberman, 2010; Willems, Hagoort, & Casasanto, 2010). Such encoding may be involved even for declarative knowledge—knowledge that, on the surface, doesn't specifically involve physically *doing* something. For example, in one recent study (Speer et al., 2009), college students read stories about a boy named Raymond engaging in a variety of behaviors (walking quickly, shaking his head, crumpling paper, etc.). Brain scan results indicated that parts of the students' brains that would be involved in performing the behaviors were quite active even though the students were only *thinking* about them.

Action-based encoding is, of course, even more important in procedural knowledge, at least when that knowledge involves psychomotor skills—shooting a basketball, driving a car, typing on a computer keyboard, and so on. For example, imagine yourself going through the steps of making a peanut butter sandwich. Can you feel yourself twisting the lid off the peanut butter jar, putting a knife into the jar, and scooping out a gob of peanut butter? Can you feel yourself untwisting the metal twisty-tie that keeps the bread fresh in its bag, pulling out two slices of bread, and then retwisting the tie? Can you feel yourself holding a slice of bread in one hand and spreading peanut butter on it with the other hand? Might your fingers even have twitched a bit as you imagined doing these things?

Some theorists have suggested that when procedural knowledge involves conditional knowledge—that is, when it involves knowing what to do under varying circumstances—it's also encoded in the form of **productions** (J. R. Anderson, 1983a, 1987, 1995; E. D. Gagné, 1985). Productions can best be described as a set of IF–THEN rules. For example, productions for riding a bicycle would include rules such as these:

1. IF I want to speed up, THEN I pedal at a faster rate.
2. IF I want to slow down, THEN I pedal at a slower rate.
3. IF my route turns to the right, THEN I turn the handlebars in a clockwise direction.
4. IF my route turns to the left, THEN I turn the handlebars in a counterclockwise direction.
5. IF an object is directly in front of me, THEN I must turn either right or left.
6. IF I want to stop, THEN I squeeze the brakes on the handlebars.

Productions are presumably also involved in procedures that have a significant cognitive component. For example, productions for adding two 2-digit numbers would include these rules:

1. IF the sum of the digits in the “ones” column equals 9 or less, THEN I write that sum in the ones column of the answer space.
2. IF the sum of the digits in the ones column equals 10 or more, THEN I write the digit that appears in the ones column of that sum in the ones column of the answer space and carry the 1 to the “tens” column of the problem.
3. IF the sum of the digits in the tens column equals 9 or less, THEN I write that sum in the tens column of the answer space.
4. IF the sum of the digits in the tens column equals 10 or more, THEN I write the digit that appears in the ones column of that sum in the tens column of the answer space and write the 1 in the “hundreds” column of the answer space.

As you can see, the “IF” part of a production specifies the condition under which a particular action will occur, and the “THEN” part specifies what the action will actually be.

## Encoding in Terms of Symbols

A **symbol** is something that represents an object or event, often without bearing much resemblance to the thing it stands for. As human beings, we probably represent a good deal of our experience as symbols—as words, numbers, maps, graphs, and so on (DeLoache, 1995; Flavell, Miller, & Miller, 2002; Salomon, 1979/1994).

There's no question that some information is stored in terms of actual words—in other words, as **verbal codes** (Chiu, Leung, & Kwan, 2007; J. M. Clark & Paivio, 1991; Kray, Eenshuistra, Kerstner, Weidema, & Hommel, 2006; Salomon, 1979/1994).<sup>6</sup> Support for this idea comes both from everyday human experiences and from several theoretical perspectives. First, people have verbal labels for many objects and events in their lives; for instance, you think of this thing you're reading as a *book*. Second, people sometimes learn information in a verbatim fashion; Hamlet's soliloquy ("To be or not to be...") and the lyrics of "Jingle Bells" are examples of things people typically learn word for word. Third, people often talk to themselves as a way of guiding themselves through new tasks and procedures (recall our discussion of *self-instructions* in Chapter 6; Vygotsky's concept of *self-talk*, described in Chapter 13, also reflects this idea). And finally, people use language to help them associate things in memory. For example, the French word for "dog" is *chien*; I remember this word by thinking "dog chain." Many of the principles that emerged from verbal learning research (e.g., the serial learning curve) probably apply primarily to information stored in a verbal code.

## Encoding in Terms of Meanings

Despite the value of verbal codes, over the long run people are more likely to remember the general, underlying meaning—the *gist*—of what they see or hear. Participants in research studies can often remember information word for word if they're asked to do so immediately after the information has been presented. When recall is delayed, their ability to remember the exact input declines rapidly, yet they continue to remember its *meaning* fairly accurately (Brainerd & Reyna, 1998, 2005; Kintsch, 1977; J. D. Payne & Kensinger, 2010). For example, think about the section you read earlier about imagery. What do you remember about it? You probably can't remember the specific words you read, but you should be able to recall the general ideas of the section. (If you can't, go back and read the section again!)

Some theorists (J. R. Anderson, 2005; van Dijk & Kintsch, 1983; Kintsch, 1998) have suggested that meanings are stored as **propositions**—that is, as small units of knowledge concerning relationships among objects or events. To paraphrase John Anderson's (2005) definition, a proposition is the smallest unit of knowledge that (1) can stand as a separate statement or assertion and (2) can be judged as being either true or false. To illustrate, consider the following sentence:

Mary's uncle, whom she adores, owns a red Ferrari.

We can break this complex sentence into four smaller assertions, each of which contains part of its meaning:

1. Mary has an uncle.
2. Mary adores the uncle.

<sup>6</sup>We previously encountered this idea in our discussion of social cognitive theory in Chapter 6. At the time, we used Bandura's terminology, talking about words as one form of a *memory code*.

3. The uncle owns a Ferrari.
4. The Ferrari is red.

Each assertion is either true or false; if any one of them is false, the entire sentence is false. The four assertions are rough verbal analogs of the abstract propositions that might be stored in memory when the sentence itself is encountered.

Any proposition has two components. First, it includes one or more **arguments**—objects or events that are the topics of the proposition. Second, it involves a single **relation**—a description of an argument or a relationship among two or more arguments. For example, the assertion “Mary has an uncle” contains two arguments (“Mary” and “uncle”) and one relation (“has”). Arguments are usually reflected by nouns and pronouns in a sentence, whereas relations are more typically reflected by verbs, adjectives, and adverbs.

Nonverbal visual information also appears to be stored at least partly in terms of meanings (Mandler & Johnson, 1976; Mandler & Parker, 1976; Mandler & Ritchey, 1977). An experiment by Mandler and Johnson (1976) illustrates this point well. In the experiment, college students looked at line drawings that included a variety of objects; for instance, one picture was a classroom scene that included a teacher, student, desk, bookshelf, flag, clock, globe, and large map. The students were then shown another set of pictures and asked whether each of the pictures was identical to a previous picture or had been changed in some way. Students were far more likely to notice changes in the pictures that reflected a change in the general meaning (e.g., a teacher was talking about a child’s drawing instead of a world map) than in those that reflected a nonmeaningful change (e.g., the teacher’s skirt and hairstyle were different).

## Different Forms of Encoding Are Not Mutually Exclusive

The various forms of encoding I’ve just described overlap to some degree. For instance, any general, abstracts meanings we acquire may have their roots in more concrete experiences—perhaps including our recollections of physical characteristics (images) and physical actions we’ve executed in association with particular objects or events (Andres et al., 2008; Barsalou et al., 2003; Pinker, 2007). Furthermore, we sometimes encode the same information simultaneously in two or more different ways—perhaps as both words (symbols) and underlying meanings (propositions), or perhaps as both words and images. When we encode the same information in two or more distinct ways, we often associate those codes in long-term memory (Heil, Rösler, & Hennighausen, 1994; Rubin, 2006; Sadoski & Paivio, 2001; Sporer, 1991). For example, in an experiment by Pezdek (1977), college students frequently confused information they’d seen in pictures with information they’d read in sentences. As an illustration, some students first saw a picture of a car parked by a tree and then read the sentence, “The car by the tree had ski racks on it.” These students tended to recognize a picture of a car with ski racks as being one they’d seen before, even though the original picture hadn’t included a rack; hence, they were probably storing the same information in both visual and verbal forms. Similarly, in the study by Carmichael, Hogan, and Walters (1932) described in the preceding chapter, participants “remembered” pictures differently depending on their labels (e.g., “eye glasses” were remembered differently from “dumbbells,” and a “kidney bean” was remembered differently from a “canoe”; see Figure 9.6).

Of course, long-term memory also includes innumerable interconnections among bits of knowledge about *different* things—a topic we turn to now.

## THE ORGANIZATION OF LONG-TERM MEMORY

---

Contemporary theories of long-term memory are **associationistic**: They propose that the various pieces of information stored in long-term memory are either directly or indirectly associated with one another. To see what I mean, get a piece of paper and try this exercise. In just a moment, you'll read a common, everyday word. As soon as you read it, write down the first word that comes into your head. Then write down the first word that *that* word reminds you of. Continue writing down the first word that each successive word brings to mind until you've created a list of 10 words.

Ready? Here is the word to get your mind rolling:

*beach*

Once you've completed your list of 10 words, examine it carefully. It should give you an idea of what ideas are associated with what other ideas in your long-term memory.

Here's the list I constructed using the same procedure and my own long-term memory:

sand  
castle  
king  
queen  
Elizabeth  
England  
London  
theater  
*Hair*  
nude

Some of my associations might be similar to yours. For example, beach–sand and king–queen are common associates. Others might be unique to me. For instance, the last five items on my list reflect my trip to London in my college days, when I attended a different theater production every night. The most memorable of the productions was the musical *Hair*, in which several actors briefly appeared nude—a shocking sight in 1969.

Different learners relate and organize their long-term memories somewhat idiosyncratically because their past experiences have been different. Nevertheless, people's varying organizational schemes may share some common features. At least three models of long-term memory organization have been proposed: a hierarchy, a network, and parallel distributed processing.

### Long-Term Memory as a Hierarchy

An early view of long-term memory organization was that information is stored in hierarchies, with more general, superordinate information at the top and more specific, subordinate information below (Ausubel, 1963, 1968; Ausubel & Robinson, 1969; A. M. Collins & Quillian, 1969, 1972). An example of such a hierarchy is my own knowledge of the animal kingdom, part of which is depicted in Figure 10.1. Notice how the most general category—animals—is at the top of the hierarchy. Next are two major categories of animals—vertebrates and invertebrates—followed by varying levels of subordinate categories, until finally specific instances of a category are reached (e.g., Rin Tin Tin, Tippy, and Anna were all German shepherds). As you can see,

**Figure 10.1**  
The author's hierarchical knowledge of the animal kingdom

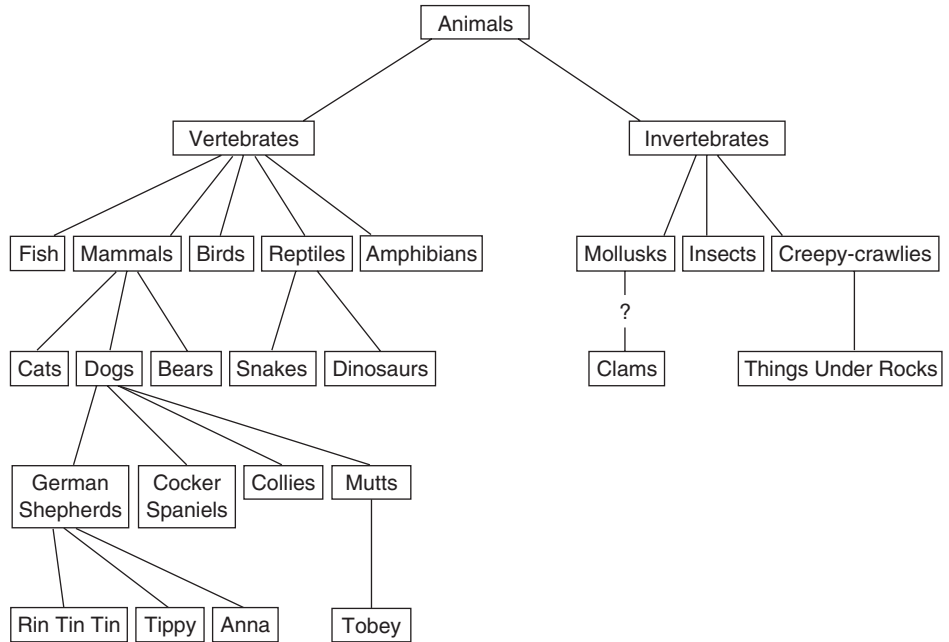

parts of my hierarchy (e.g., classes of vertebrates) would resemble that of a biologist, but other parts are uniquely my own.

In a classic study, Collins and Quillian (1969) demonstrated how long-term memory might be organized hierarchically. Adults were given a number of statements (e.g., “A canary can sing”) and asked to indicate whether they were true or false; reaction times to confirm or reject the statements were recorded. Following are examples of true statements and approximate reaction times to them:

<b>Statements about Category Membership</b>	<b>Reaction Times (msec)</b>
A canary is a canary.	1000
A canary is a bird.	1160
A canary is an animal.	1240
<b>Statements about Characteristics</b>	<b>Reaction Times (msec)</b>
A canary can sing.	1300
A canary can fly.	1380
A canary has skin.	1470

Notice how the reaction times increased for the three sentences regarding category membership: Participants most quickly verified that a canary is a canary and least quickly verified that a canary is an animal. And now notice the different reaction times for the three statements concerning a

**Figure 10.2**

A simplified version of the Collins and Quillian (1969) knowledge hierarchy  
 Based on “Retrieval Time from Semantic Memory” by A. M. Collins & M. R. Quillian, 1969, *Journal of Verbal Learning and Verbal Behavior*, 8, pp. 240–247.

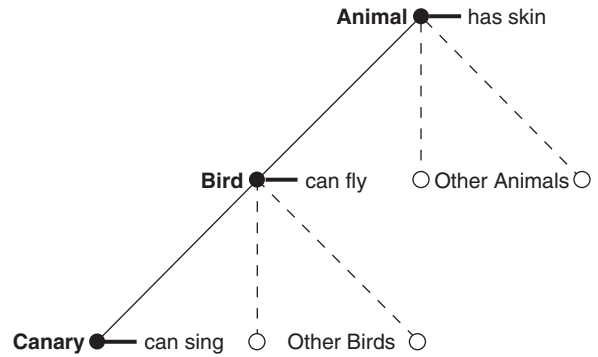

canary’s characteristics: Participants found the statement about singing easiest and the one about having skin most difficult. Collins and Quillian argued that the two sets of sentences are actually parallel, because most people associate singing directly with canaries, whereas they associate flying with birds and having skin with animals.

Collins and Quillian suggested that an individual’s knowledge about categories and category characteristics is arranged in a hierarchical fashion similar to that depicted in Figure 10.2. To verify the statements, subjects had to locate the two components of the statement (e.g., “canary” and “skin”) within their long-term memories and determine whether they were associated either directly or indirectly. The farther apart the two components were in the hierarchy, the longer it would take to verify a statement—hence the longer the reaction times.

It certainly seems to be true that we mentally subsume some categories within other, more general categories, and doing so can facilitate meaningful learning (Ausubel, Novak, & Hanesian, 1978; Chi, 2008). For example, students are more likely to learn meaningful information about an animal called a skink if they’re told that it’s “a kind of lizard that looks like a snake” than if they’re told that it’s “brightly colored” or “a shy, seldom-seen creature.” In the former case, students can store the concept *skink* under the more general concept *lizard*; in the latter two situations, they aren’t really sure where to put it.

Nevertheless, strictly hierarchical models of long-term memory have largely gone by the wayside. For one thing, much of the information we learn doesn’t have a hierarchical quality to it. Furthermore, predictions consistent with hierarchically arranged information aren’t always confirmed. For example, just as people more quickly verify that a canary is a bird than they verify that a canary is an animal, we should expect that people would agree with the statement “A collie is a mammal” faster than the statement “A collie is an animal,” because *collie* is closer to *mammal* than it is to *animal* in a logical hierarchy of animals. Yet the opposite holds true: People more quickly agree that a collie is an animal than that it’s a mammal (Rips, Shoben, & Smith, 1973). In general, although some information in long-term memory may be arranged hierarchically, most of it is probably organized less systematically.

## Long-Term Memory as a Network

A **network** model portrays memory as consisting of many pieces of information interconnected through a variety of associations (e.g., G. H. Bower, 2008; Hills, Maouene, Maouene, Sheya, & Smith, 2009). For instance, let’s return again to my own list of successive associations resulting

**Figure 10.3**  
A hypothetical network of information in long-term memory

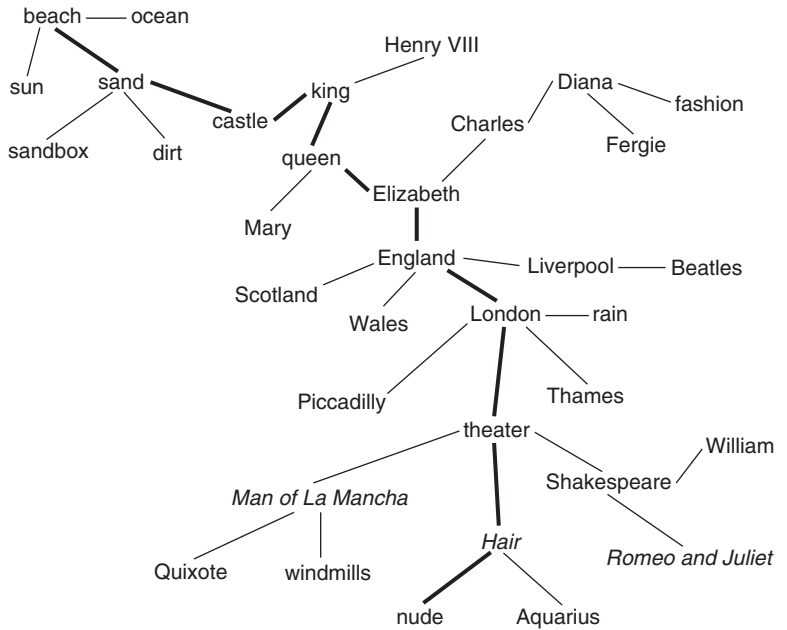

from the word *beach*: sand, castle, king, queen, Elizabeth, England, London, theater, *Hair*, nude. Such a list might have been generated from a long-term memory network such as the one in Figure 10.3. Different individuals have networks with somewhat different associations and so should generate different lists. Some individuals, depending on their past experiences at the beach, might even associate *beach* and *nude* directly with each other.

One widely used model of long-term memory organization is the **propositional network** (J. R. Anderson, 1976, 1983a, 1983b, 2005; E. D. Gagné, 1985; Lindsay & Norman, 1977; Norman & Rumelhart, 1975). A propositional network is one in which propositions and their interrelationships are stored in a networklike fashion. For example, let's return to a sentence I presented earlier:

Mary's uncle, whom she adores, owns a red Ferrari.

and to its four assertions:

1. Mary has an uncle.
2. Mary adores the uncle.
3. The uncle owns a Ferrari.
4. The Ferrari is red.

The four assertions can be diagrammed as propositions, as shown in Figure 10.4. These diagrams, using Anderson's (2005) symbols, each show a proposition (symbolized by an oval) that encompasses one relation and one or more arguments.

The four diagrams in Figure 10.4 share three concrete entities (arguments); in particular, *Mary*, *uncle*, and *Ferrari* each appear in at least two propositions. Such commonalities allow the propositions to be linked in a network; see an example in Figure 10.5. A propositional network model of long-term memory is obviously more flexible than a hierarchical model, because it can



**Figure 10.4**  
Diagrams of separate propositions

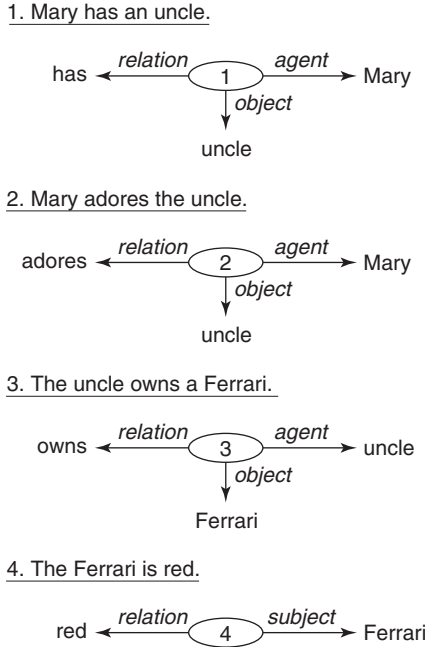

easily include a wide variety of relationships—not only category-and-subcategory but also owner-and-possession, object-and-characteristic, object-and-location, and so on.

Network models are often conceptualized as including not only propositions (meanings) but also information encoded in other forms (e.g., as images or productions). For example, you might have a visual image of a Ferrari stored in association with the information about Mary’s uncle and his red sports car. Perhaps not too far away in the same network are productions related to driving automobiles.

Using a propositional network model of long-term memory, we can characterize meaningful learning as a process of storing new propositions with related propositions in the network. For example, let’s assume that you’ve already stored propositions concerning Mary’s uncle and his red Ferrari in a form similar to that depicted in Figure 10.5. You then read the following sentence:

The uncle is named Charles.

**Figure 10.5**  
A propositional network

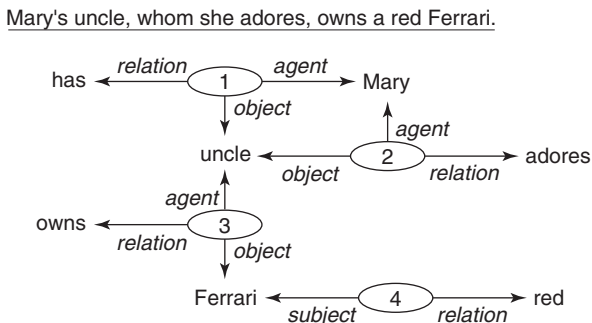

**Figure 10.6**  
Meaningful learning in a  
propositional network

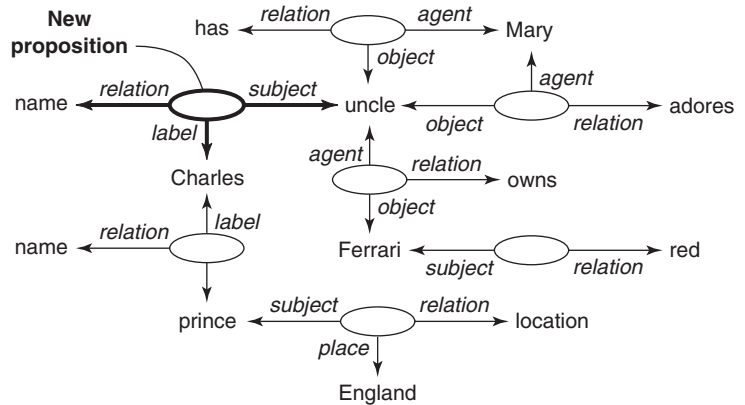

You might connect this proposition to your existing propositions about the uncle and perhaps to propositions concerning another Charles you know of—England’s Prince Charles—as illustrated in Figure 10.6.

Although a propositional network model of memory gives us greater flexibility than a strictly hierarchical model does, the black-and-white nature of propositions—each one must be definitely true or false—is troublesome. Many aspects of human experience that are stored in long-term memory, such as an interpretation of a Shakespearian play or an emotional reaction to a work of art, can’t be easily classified as right or wrong (Eisner, 1994).

## Parallel Distributed Processing

Until now, we’ve been talking as if various bits of information are each stored in a single “place” in long-term memory. But let’s return to a point I made in Chapter 2: Even when people think about something fairly simple—perhaps a single word—numerous areas of the cortex are activated. With this finding from brain research in mind, some theorists have proposed that each piece of information is stored in the form of an integrated collection of entities, called **nodes**, that are located throughout long-term memory. Any single node may be associated with many different pieces of information. Each separate idea you’ve stored in your long-term memory is represented, then, not as a single node but rather as a *unique network of interconnected nodes*. As one idea (network) is activated, other ideas that share some of its nodes may also be activated.

Such a view of long-term memory is often called **parallel distributed processing (PDP)**: Pieces of information are stored in a *distributed* fashion throughout long-term memory, with numerous nodes being processed simultaneously—that is, in *parallel* (J. L. McClelland & Rumelhart, 1986; O’Brien, 1999; Plunkett, 1996; T. T. Rogers & McClelland, 2004; Rumelhart & McClelland, 1986). Parallel distributed processing is also known as **connectionism**, but it shouldn’t be confused with Edward Thorndike’s connectionism, described in Chapter 4.

The parallel distributed processing model is useful for understanding the multidimensional nature of even the simplest of ideas (Rayner, Foorman, Perfetti, Pesetsky, & Seidenberg, 2001; Rueckl & Seidenberg, 2009). For example, when we see the word

*beach*

we may simultaneously retrieve not only what the word means but also how it sounds when spoken, how the mouth moves when pronouncing it, and what a typical beach looks like. The PDP model also helps us understand how we can often fill in missing information when a stimulus is incomplete: Enough nodes of an idea are activated that the entire network becomes activated.

Nevertheless, the PDP model is far from perfect. It tends to portray learning as a gradual process of strengthening and weakening associations and thus doesn't explain how we can sometimes learn something very rapidly, draw analogies between seemingly unrelated situations, and quickly revise certain beliefs in the face of contradictory information (Opfer & Doumas, 2008; Ratcliff, 1990; Schacter, 1989). Furthermore, some simple and highly automatized cognitive tasks seem to occur in fairly localized areas of the brain (Besner, 1999; J. S. Bowers, 2002, 2009). And although the PDP model was presumably developed to be consistent with research findings about brain functioning, its relationship to brain anatomy is a loose, speculative one at best (J. L. McClelland, 2001; Siegler & Alibali, 2005).

Regardless of how long-term memory is organized, it clearly is organized. To some degree, human beings interrelate all the information they have in their long-term memories. To an even greater degree, they interrelate their knowledge regarding very specific objects, events, and topics. We now look at several specific ways in which people might organize their experiences: concepts, schemas, scripts, personal theories, and worldviews.

## CONCEPTS

---

One night in late May many years ago, my son Jeff, then a 4-year-old, asked me a question:

Jeff: When are spring and summer coming?

Me: Spring is already here. Haven't you noticed how warm it is, and how the leaves are back on the trees, and how the birds are singing again?

Jeff: Oh. Then when is summer coming?

Me: Well, you have only one more week of school, and then a couple of weeks after that, summer will be here.

Jeff: Summer is when we go swimming, right?

Me: [I pause and think about how to answer.] Right.

Obviously Jeff had only vague understandings of the concepts *spring* and *summer*—for instance, summer was simply a time to swim.

In general, a **concept** is a mental grouping of objects or events that are similar in some way. Some concepts are **concrete concepts** that are easily identified by physical appearance; *cow*, *round*, and *swim* are examples. In contrast, **abstract concepts** have underlying similarities that aren't readily observable on the surface; examples include *cousin*, *charisma*, and *sociology*.

Abstract concepts such as *cousin* are often difficult to learn through physical inspection alone.

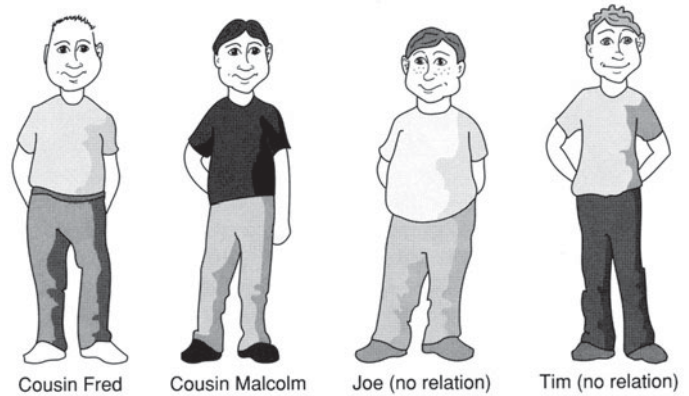

Human beings seem to be predisposed to categorize their world; even 2-month-old infants show some evidence of forming categories that help them organize their experiences (Mandler, 2007; Quinn, 2003, 2007; Quinn & Bhatt, 2006). Often people first learn a concept in a concrete form and then later acquire a more abstract understanding of it (Liu, Golinkoff, & Sak, 2001; Quinn, 2007; Rakison, 2003). For instance, for many young children *summer* means heat, no school, and swimming—all easily observable characteristics. Later, in school, they may acquire a far more abstract notion of summer: the 3-month period between the summer solstice and the autumn equinox. And children initially conceptualize various family members (cousins, uncles, etc.) in terms of things they can actually see, rather than in terms of the nature of the relationship, as illustrated in the following conversation between an experimenter (E) and a child (C):

- E: This man your daddy's age loves you and your parents and loves to visit and bring presents, but he's not related to your parents at all. He's not your mommy or daddy's brother or sister or anything like that. Could that be an uncle?
- C: Yes.
- E: What is an uncle?
- C: An uncle is that he brings you presents at Christmas.
- E: What else?
- C: An uncle is that he lets you come over to his house.
- E: Could I be your uncle?
- C: No . . . because I don't know you.
- E: If I got to know you and brought you presents, could I be your uncle?
- C: Yes. (Keil, 1989, pp. 71, 76)

Learners haven't completely acquired a concept until they can correctly identify all positive and negative instances of it. A **positive instance** is a particular example of a concept. For instance, you and I are positive instances of the concept *person*, and this thing you're reading is a positive instance of a *book*. A **negative instance** is a nonexample of the concept. You and I are negative instances of the concept *cow*, and this book is a negative instance of a *pencil*.

Learners often have sort-of-but-not-quite understandings of concepts, in that they can't always distinguish between positive and negative instances. A child who vehemently denies that

a Chihuahua is a dog hasn't completely learned the concept of *dog*; neither has the child who calls the neighbor's cow "doggie." Denying that a Chihuahua is a dog—**undergeneralization**—reflects an inability to recognize all positive instances. Identifying a cow as a dog—**overgeneralization**—reflects an inability to reject all negative instances. Psychologists have offered various theories of concept learning that can help us understand how such sort-of knowledge might exist.

## Theories of Concept Learning

In their studies of concept learning, researchers have addressed two key questions: (1) *What* do people actually learn about concepts? and (2) *How* do they learn it? The first question involves the nature of our knowledge about concepts; the second involves the cognitive processes involved in mastering a concept.

### *What Do People Learn about Concepts?*

To some degree, our knowledge about concepts includes knowing that certain **features** are important for positive instances (Bourne, 1982; Horst, Oakes, & Madole, 2005; P. G. Neumann, 1974, 1977; E. E. Smith, Shoben, & Rips, 1974; Ward, Vela, & Haas, 1990). Most central are **defining features**, characteristics that must be present in all positive instances. We're also likely to be aware of **correlational features**, which are frequently found in positive instances but aren't essential for concept membership. Consider, for example, my dog Tobey, who has numerous features worthy of note, including these:

- Four legs
- Hairy
- Wearing a red collar
- Likely to bark loudly at any negative instance of an Ormrod
- Presently located on my office floor

Of these, two defining features—two features essential for Tobey's identification as a *dog*—are four legs and hair. Two correlational features are his collar and his ability to bark at others: Most dogs bark and many wear collars, but neither of these features is characteristic of *all* dogs. Tobey's location on my office floor is an **irrelevant feature**—it has no relevance to his dogness.

Yet many real-world concepts are hard to pin down strictly in terms of features. For example, is turquoise a shade of *blue* or a shade of *green*? My husband insists that turquoise is green, but I know better: It's blue. Furthermore, objects and events can lack important features yet still be identified as positive instances of a particular concept. For example, although dogs typically have four legs and hair, you've probably seen dogs who've lost a leg in an accident, and a few hairless breeds have recently emerged.

With such problems in mind, some theorists have proposed that people's knowledge of concepts may also include a **prototype**, or typical example of the concept (Cook & Smith, 2006; Rosch, 1973, 1978; S. A. Rose, Feldman, & Jankowski, 2007; G. E. Walton & Bower, 1993). As an illustration, form an image in your mind of a *bird*. What probably comes to mind is a small creature, perhaps about the shape and size of a robin or sparrow. It's unlikely that you would instead imagine a penguin or an ostrich because these animals aren't as typically birdlike in

appearance as robins and sparrows. Similarly, imagine a *vehicle*. Your image probably resembles a car or a truck rather than a canoe or hot-air balloon, because cars and trucks are more commonly observed instances of vehicles. Now imagine *red*. You probably picture a color similar to that red crayon you had when you were age 5, rather than maroon or shocking pink.

But what do we do when features are hard to pin down and concept members don't resemble a particular prototype? In such instances, knowing a concept may depend on knowing numerous examples, or **exemplars**, of the concept (Cook & Smith, 2006; Kornell & Bjork, 2008; Medin, Unsworth, & Hirschfeld, 2007; B. H. Ross & Spalding, 1994). Exemplars give learners a sense of the variability they're apt to see in any category of objects or events. For instance, the concept *fruit* may bring to mind many different things: Apples, bananas, raspberries, pineapples, and coconuts are all possibilities. If we encounter a new instance of fruit—a blackberry, let's say—we could compare it to the variety of exemplars we've already stored and find one (perhaps a raspberry) that's relatively similar.

It's possible that prototypes or exemplars are used to identify positive instances in clear-cut situations, whereas formal definitions (which include defining features) are used in other, more ambiguous ones (Andre, 1986; Glass & Holyoak, 1975; Rouser & Ratcliff, 2006). It may also be true that for many concepts, children rely on prototypes or exemplars initially and then acquire a more general, abstract understanding—perhaps including a formal definition—later on (Horst et al., 2005; Liu et al., 2001). As a preschooler, my son Jeff adamantly denied that the concept *animal* includes people, fish, and insects. Like Jeff, many young children restrict their conception of animals to four-legged mammals (S. Carey, 1985; Saltz, 1971). Perhaps Jeff's animal prototype resembled the family dog or the cows he often saw in the countryside. When he began studying the animal kingdom in school, he learned a biology-based definition of an animal that incorporates some of its major features: a form of life that derives its food from other organisms, responds immediately to its environment, and can move its body. At that point Jeff acknowledged that people, fish, and creepy-crawlies are legitimate animals. (If he were to study biology in depth, however, he might learn that biologists don't totally agree on a definition of *animal* and that true defining features of the concept are hard to identify.)

### ***How Do People Learn Concepts?***

Early behaviorists took a decidedly noncognitive view of concept learning. Consistent with their focus on stimuli and responses, they portrayed a concept not as a mental entity but rather as a common response to a variety of stimuli (e.g., Hull, 1920; Kendler, 1961). Learning a concept, then, might involve building up associations between particular aspects of a stimulus and particular responses to that stimulus. An exercise in which you'll learn the concept *mudge* can help you understand what I mean. Your first step is to get two index cards or similar-sized pieces of paper. Use one card to cover the right side of Figure 10.7. Now take the second card and cover the left side, exposing only the top section above the first horizontal line. You'll see two objects, one of which is a mudge. Take a wild guess and see if you can pick the mudge. Once you've made your selection, move your paper down the left column to the next horizontal line, revealing the correct answer. In this section you'll also see two more objects; pick the one you think is the mudge. Keep moving your paper down the page, one section at a time, on each occasion getting your feedback and then selecting a likely mudge from the next pair of objects. Continue the process with the pairs in the right-hand column.

You've presumably learned that *mudge* is "large." From a behaviorist perspective, you were always reinforced for choosing a large square, you were never reinforced for choosing a small one, and you

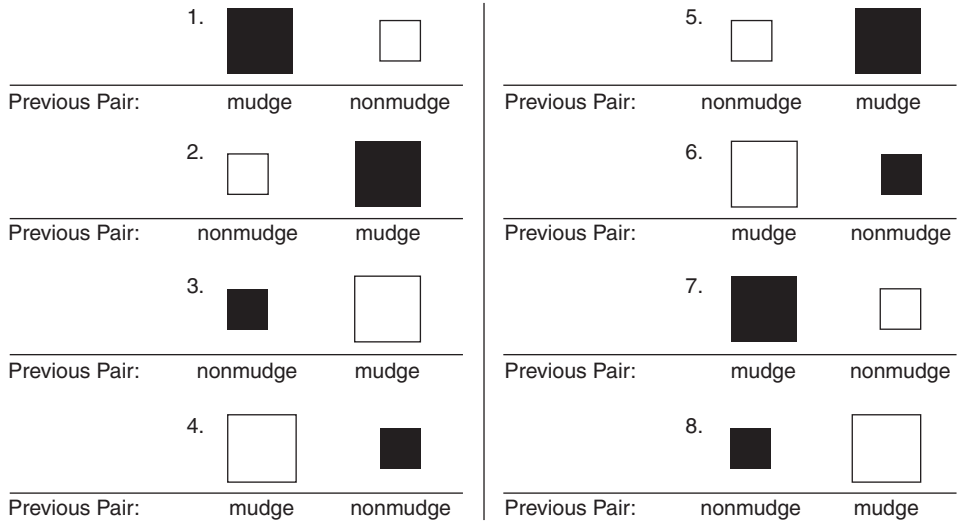
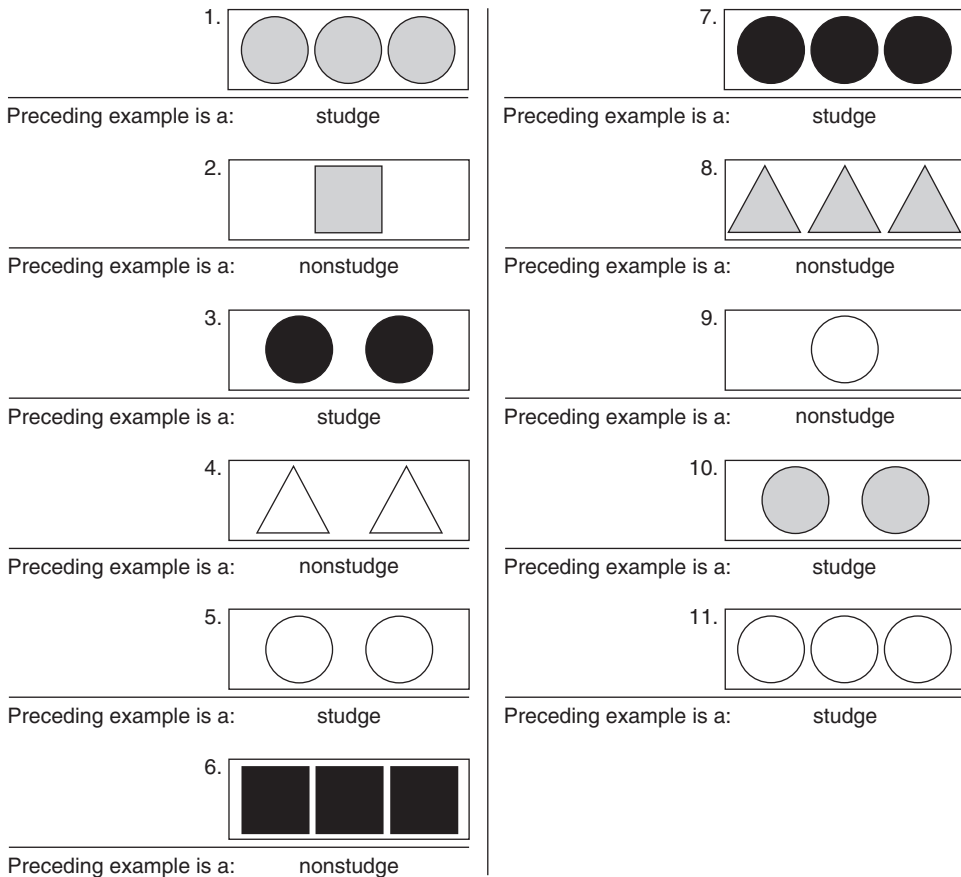

**Figure 10.7**  
Identify the *mudge* in each pair.

were reinforced for choosing black, white, left, or right squares about half of the time. Because it's been reinforced every time, the response of selecting “large” should be the strongest one for you, and you should therefore be most likely to choose a large square again, regardless of its color and position.

Although contemporary psychologists have largely abandoned simple stimulus–response explanations of human learning, many acknowledge that a relatively passive buildup of associations may form the basis of some concepts, especially for infants and young children (Gelman & Kalish, 2006; Mandler, 2007; Rakison & Lupyan, 2008; Younger, 2003; also see Kendler & Kendler, 1959). Well before their first birthday, children show an ability to detect commonly occurring patterns in the world around them: They realize that certain features tend to go together and that other features don't. In a sense, infants are budding statisticians, unconsciously tabulating the frequencies of the various characteristics they observe and detecting correlations among some of them. Such an ability may, for example, underlie infants' early understanding of words in their native language (Saffran, 2003).

In contrast to the passive buildup-of-associations approach, older children and adults are often (although not always) cognitively active in learning a concept's defining features. In some instances learners may form various hypotheses about a concept's meaning and then use positive and negative instances to confirm or reject each hypothesis (Bruner, Goodnow, & Austin; 1956; Levine, 1966). To get a sense of what this process might involve, take a few minutes to learn the concept *studge* using Figure 10.8 and the two index cards you gathered for the *mudge* exercise. Cover the right side of the figure with one card, and cover all but the top section of the left side with the other card. In the exposed section in the upper left, you'll see a rectangle with three gray circles inside; take a wild guess and decide whether the rectangle is a studge. Once you've made your guess, move the left card down to the next horizontal line, revealing the correct answer. In this section you'll also see a second rectangle, one with a gray square inside; decide whether you think it's a studge. Keep moving the card down the left side of the figure, one section at a time,



**Figure 10.8**  
Positive and negative instances of a *studge*

on each occasion getting your feedback and then deciding whether the next rectangle is a studge. Continue the process with the rectangles on the right side of the figure.

Now that you’ve finished, you have, I hope, learned that the concept *studge* is “two or three circles.” Shape and number are defining features for the concept; color is irrelevant to studge-ness. In learning about studges, perhaps you found yourself forming different hypotheses about what is and isn’t a studge. For instance, the first example was a studge. You may have used that positive instance to generate one or more hypotheses—a studge is anything gray, anything round, three of something, three gray circles, and so on. You would have eliminated a “gray” hypothesis with the second example and a “three of something” hypothesis with the third. Eventually you may have been left with only the correct, two-or-three-circles hypothesis.

Studies of early vocabulary learning suggest that children are predisposed to favor some hypotheses over others. For example, when they hear a new word—*wudge*, perhaps—attached to a particular object in a group of objects, they’re more likely to think that the object’s shape (rather than, say, its size or color) is a defining feature (Diesendruck & Bloom, 2003; Gershkoff-Stowe & Smith, 2004). Another common predisposition is to hypothesize that a new word refers



to whatever object the speaker is looking at—something that even 2-year-olds are inclined to do (Golinkoff & Hirsh-Pasek, 2006).

And, of course, there's a third, more obvious way in which human beings can learn about a new concept: Someone provides a definition (Best, Dockrell, & Braisby, 2006; R. M. Gagné, 1985; Tennyson & Cocchiarella, 1986). It's quite likely that different approaches to concept learning are more or less useful for different age-groups, for different kinds of concepts, and at different points in the learning process (Feldman, 2003; Gelman & Kalish, 2006; Reisberg, 1997).

## Factors Facilitating Concept Learning

Young children seem quite eager to learn new concepts. Hearing a new word clues them in to the fact that others in their community find the word—and so also the concept it represents—quite useful in everyday life (Goldstone & Johansen, 2003). And when children encounter a new, unfamiliar object, they're likely to ask "What is it?" and to press for information about what purpose the object serves (Kemler Nelson, Egan, & Holt, 2004).

The following principles capture important factors affecting concept learning and yield strategies for helping learners of all ages acquire new concepts:

- ◆ *Concepts are easier to learn when defining features are more salient than correlational and irrelevant features.* The more obvious a concept's defining features are—the more readily they capture a learner's attention—the easier the concept is to master, especially for young children (Mandler, 2007; Rakison, 2003). But because young children typically pay more attention to obvious features, their early understandings of concepts are apt to be based on such features. For example, in a study by DeVries (1969), 3- to 6-year-old children played for a short time with a good-natured cat named Maynard. Then, as they watched, the experimenter placed a ferocious-looking dog mask on Maynard and asked, "What is this animal now?" Many of the 3-year-olds asserted that Maynard was now a dog and refused to pet him. In contrast, the 6-year-olds could overlook the dog mask, recognizing that it didn't change Maynard's catness. As children grow older, they begin to attend less to perceptually salient features and focus more on abstract qualities (Keil, 1989; Quinn, 2007; Rakison, 2003).

Salient correlational features can often be helpful in the early stages of concept learning, in part because they make positive instances easier to identify. For example, the concept *bird* is relatively easy to learn, because many characteristics—feathers, wings, beak, small size, and scrawny legs and feet—are either defining or correlational features. But learners who are overly dependent on correlational features will sometimes make errors. More specifically, they may either overgeneralize (i.e., identify something as an example of a concept when in fact it's not) or undergeneralize (i.e., overlook a true example of a concept). For instance, the concept *animal* is difficult for many children, because many of the salient features of positive instances—body covering, nature and number of limbs, facial features, shape, and size—are correlational rather than defining features. So, too, might a true understanding of the concept *art* be a tough one to acquire. Things that stand out about a particular work of art are characteristics such as shape, color, medium (e.g., paint or clay), and subject matter (e.g., people or objects), yet these characteristics are only tangentially related to what art is.

One logical strategy for enhancing concept learning, then, is to highlight a concept's defining features while downplaying its correlational and irrelevant ones. For instance, a science teacher who creates a line drawing to illustrate the concept of *insect* might make an insect's

essential characteristics (e.g., six legs, three body parts) more noticeable by outlining them with dark, thick, lines. Similarly, a music teacher who wants to help students learn about *three-quarter time* might have them tap out the rhythm with drumsticks or their fingers as they listen to waltzes and other songs that have three beats to a measure.

- ◆ *Definitions facilitate concept learning* (Best et al., 2006; Fukkink & de Glopper, 1998; Tennyson & Cocchiarella, 1986). A good definition not only includes defining features but also describes the concept in terms of other concepts with which students are already familiar. Definitions and other explicit descriptions may be especially helpful when concepts involve defining features that aren't especially obvious or have an either-this-or-that-but-not-necessarily-both quality.

- ◆ *Numerous and varied positive instances help to illustrate a concept.* First examples should be simple and straightforward, with as few irrelevant features as possible. Later examples should be more difficult, with more irrelevant features present and salient. Ultimately, examples should illustrate the full range of the concept so that students don't undergeneralize; for example, the concept *mammal* should be illustrated by whales and platypuses as well as by cats and dogs (C. A. Carmichael & Hayes, 2001; D. C. Clark, 1971; Kinnick, 1990; L. Perry, Samuelson, Malloy, & Schiffer, in press; Tennyson & Cocchiarella, 1986).

Through encountering many and varied instances of concepts, learners can form prototypes and exemplars of the concepts. In some situations, in fact, providing a *best example* is more helpful than offering a definition. To illustrate, Park (1984) used two instructional methods to teach high school students basic psychology concepts (e.g., *positive reinforcement* and *negative reinforcement*). For some students, instruction focused on the defining features of the concepts; for others, it focused on illustrative examples. Students for whom defining features were emphasized were better able to classify new examples during instruction. However, students who had been given examples of the concepts remembered more of what they'd learned after instruction was completed. Ideally, of course, definitions and examples should be presented hand in hand, and in fact this combination of methods leads to more effective concept learning than either method alone (Dunn, 1983; Tennyson, Youngers, & Suebsonthi, 1983).

- ◆ *Negative instances are useful in demonstrating what a concept is not.* For example, in learning about dogs, students can be shown that such similar-looking animals as cats, goats, and cows are nondogs in order to learn just where to draw the line on dogness. Negative instances—especially when they're *near misses* to the concept—are helpful in defining the concept's limits and preventing overgeneralization (D. C. Clark, 1971; R. M. Gagné, 1985; Merrill & Tennyson, 1977; Tennyson & Cocchiarella, 1986).

- ◆ *Positive and negative instances are more effective when presented simultaneously.* In their everyday lives, people typically learn concepts through **sequential presentation**: They encounter a series of positive and negative instances one at a time over a period of weeks, months, or years, and in the process they may gain information about what things are and aren't examples of the concept. But a faster way to learn concepts is **simultaneous presentation**, in which people can see a number of positive and negative instances all at once or within a very short time span (Bourne, Ekstrand, & Dominowski, 1971; R. M. Gagné, 1985; Kornell & Bjork, 2008). One likely reason for the difference in effectiveness is that in sequential presentation, learners must store what they've learned from each instance in long-term memory, and that information can be forgotten from one instance to the next. In simultaneous presentation, the information to be gleaned from positive and negative instances is more likely to be available all at once, putting fewer demands on memory.

Concepts are best learned through a simultaneous presentation of both positive and negative instances.

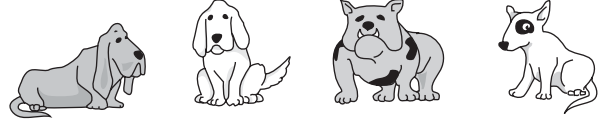

Each of these is a dog.

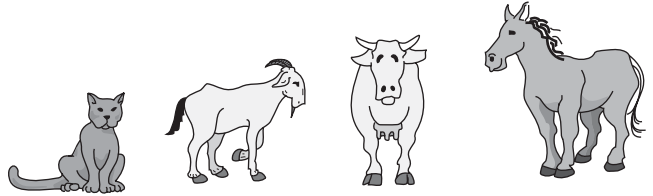

None of these is a dog.

◆ *Classroom assessment tasks can enhance as well as monitor concept learning.* Do students truly understand what a concept is, or have they simply memorized a definition in a rote, meaningless fashion? To find out, teachers can ask students to select positive instances of the concept from among numerous possibilities (Kinnick, 1990; Merrill & Tennyson, 1977; Tennyson & Cocchiarella, 1986). One educator has called this strategy an *eg hunt*, a tongue-in-cheek variation of “e.g.” (Thiagarajan, 1989). In addition, teachers might ask students to generate their *own* examples and applications of a concept. By doing so, teachers encourage students to check and refine their current understandings (H. C. Ellis & Hunt, 1983; Watts & Anderson, 1971). Students who haven’t completely mastered a concept won’t be able to identify all positive and negative instances correctly, especially in borderline cases.

Concepts are perhaps the simplest ways in which we organize the world around us. But we also organize concepts into larger, more inclusive concepts, and often organize the more inclusive concepts into even *more* inclusive ones, and so on, in a hierarchical fashion (Gelman & Kalish, 2006; Mervis, Pani, & Pani, 2003; Rosch, Mervis, Gray, Johnson, & Boyes-Braem, 1976). Children become increasingly flexible in how they organize their concepts, perhaps thinking of a *muffin* as a type of *bread* on one occasion and as a type of *breakfast food* on another occasion, depending on the demands of the situation at hand (Nguyen & Murphy, 2003). In addition, children and adults alike integrate their concepts into more complex and comprehensive understandings of their world. Our next topics of discussion, *schemas* and *scripts*, are examples of how we might pull several concepts together.

## SCHEMAS AND SCRIPTS

In contemporary cognitive theory, the term **schema** usually refers to a closely connected set of ideas (including concepts) related to a specific object or event (e.g., Dansereau, 1995; Derry, 1996; Rubin, 2006; Rumelhart & Ortony, 1977; Schraw, 2006). For example, you probably have a schema for what a faculty member’s *office* is typically like: It’s usually a small room that contains a desk, one or more chairs, bookshelves with books, and other items useful in performing academic

duties. You undoubtedly also have a schema about the nature of physical *substances*—a schema that includes ideas such as the following:

- A substance has a location: It's somewhere in particular.
- A substance is stable: It doesn't simply appear or disappear without cause.
- A substance is sensitive to gravity: It will fall toward the earth if nothing holds it up.
- A substance can move: For instance, it can be pushed. (Reiner, Slotka, Chi, & Resnick, 2000)

Our schemas often influence how we perceive and remember new situations. For instance, your schema of a faculty office might distort your later memory of what a particular office was actually like (Brewer & Treyns, 1981; Lampinen, Copeland, & Neuschatz, 2001). In one study (Brewer & Treyns, 1981), 30 college students were brought, one at a time, to a room they believed to be the experimenter's university office. After waiting in the office for less than a minute, they were taken to another room and asked to write down everything they could remember about the room. Most students correctly remembered things that one would expect to find in an office (e.g., a desk, a chair, and shelves). Relatively few of them remembered items not likely to be part of an office schema (e.g., a skull, a clown-shaped light switch, and a tennis racket). And 9 of the 30 students "remembered" books that weren't there at all.

People often form schemas about events as well as objects; such event schemas are sometimes called **scripts** (G. H. Bower, Black, & Turner, 1979; M. Cole & Cagigas, 2010; Dansereau, 1995; Schank & Abelson, 1977). The following situation provides an example:

John was feeling bad today so he decided to go see the family doctor. He checked in with the doctor's receptionist, and then looked through several medical magazines that were on the table by his chair. Finally the nurse came and asked him to take off his clothes. The doctor was very nice to him. He eventually prescribed some pills for John. Then John left the doctor's office and headed home. (G. H. Bower et al., 1979, p. 190)

You probably had no trouble understanding the passage because you've been to a doctor's office yourself and have a script for how those visits usually go. You can therefore fill in a number of details that the passage doesn't tell you. You probably inferred that John must have *traveled* to the doctor's office, although the story omits this essential step. Likewise, you probably concluded that John took his clothes in the examination room rather than in the waiting room, even though the story doesn't mention where John did his striptease. As you can see, then, a person's mental script for an event will influence what information the person "learns" from a given instance of the event. In a study by Bower and colleagues (1979), college students read the same passage you just read. The students in the experiment "remembered" reading about many activities that were likely to be part of a visit to the doctor (e.g., arriving at the doctor's office) but that they had actually *not* read.

Other research provides further support for the idea that schemas and scripts influence how learners process, store, and remember new information. For instance, people have an easier time remembering events similar to those in their own culture, presumably because such events are consistent with recognizable scripts (Lipson, 1983; Pritchard, 1990; R. E. Reynolds, Taylor, Steffensen, Shirey, & Anderson, 1982; Steffensen, Joag-Dev, & Anderson, 1979). And consider the following story about two boys playing hooky:

The two boys ran until they came to the driveway. "See, I told you today was good for skipping school," said Mark. "Mom is never home on Thursday," he added. Tall hedges hid the house from the road so the pair strolled across the finely landscaped yard. "I never knew your place was so

big,” said Pete. “Yeah, but it’s nicer now than it used to be since Dad had the new stone siding put on and added the fireplace.”

There were front and back doors and a side door which led to the garage which was empty except for three parked 10-speed bikes. They went in the side door, Mark explaining that it was always open in case his younger sisters got home earlier than their mother.

Pete wanted to see the house so Mark started with the living room. It, like the rest of the downstairs, was newly painted. Mark turned on the stereo, the noise of which worried Pete. “Don’t worry, the nearest house is a quarter of a mile away,” Mark shouted. Pete felt more comfortable observing that no houses could be seen in any direction beyond the huge yard.

The dining room, with all the china, silver, and cut glass, was no place to play so the boys moved into the kitchen where they made sandwiches. Mark said they wouldn’t go to the basement because it had been damp and musty ever since the new plumbing had been installed. (Pichert & Anderson, 1977, p. 310)

You’d probably remember different details from the story depending on whether you read it from the perspective of a potential home buyer or a potential burglar (R. C. Anderson & Pichert, 1978). Different schemas and scripts come into play for buying versus burgling a home.

As we noted in Chapter 8, the human memory system typically encounters more information than it can possibly handle. Schemas and scripts provide a means for reducing this information overload: They help people to focus their attention on things that are likely to be important and to ignore what’s probably unimportant (Ramsay & Sperling, 2010; Schraw, 2006; Sweller, 1994). Schemas also enable people to make sense of incomplete information. As a result, individuals may “remember” things that they never specifically encountered but instead filled in using their existing schemas and scripts (Farrar & Goodman, 1992; Huttenlocher & Lourenco, 2007; Kardash, Royer, & Greene, 1988; P. T. Wilson & Anderson, 1986).

Schema theory has intuitive appeal as a way of helping us understand how we organize our past experiences and use what we’ve learned to predict and interpret future experiences. It’s been criticized for being somewhat vague, however; for example, theorists haven’t been either precise or consistent regarding what schemas and scripts actually *are* (Dansereau, 1995; Mayer, 2008; R. E. Reynolds, Sinatra, & Jetton, 1996). Furthermore, although we can reasonably assume that people form and modify schemas and scripts based on the specific objects and events they encounter, the cognitive processes that occur during this learning aren’t at all clear.

Schemas and scripts usually relate to relatively specific objects and events. Another concept—that of *personal theories*—can help us understand how people may organize their knowledge and beliefs on a much grander scale.

## PERSONAL THEORIES

---





Numerous psychologists have speculated that people form general theories—coherent belief systems that encompass cause-and-effect relationships—about many aspects of the world around them, including physical phenomena, biological phenomena, social relationships, political entities, and mental events (e.g., D. E. Brown & Hammer, 2008; Flavell, 2000; Inagaki & Hatano, 2006; Torney-Purta, 1994; Wellman & Gelman, 1992). To distinguish these theories from those that scientists formulate based on considerable research evidence, I’ll refer to them as **personal theories**.<sup>7</sup>

<sup>7</sup>Some theorists instead call them *folk theories* or *alternative frameworks* (e.g., Brewer, 2008; Halldén, Scheja, & Haglund, 2008; Inagaki & Hatano, 2006).

This perspective of how people organize knowledge is sometimes known as **theory theory**. No, you're not seeing double here: We're discussing a theoretical perspective about people's everyday theories. As an illustration of this approach, take a minute to read the two scenarios in Figure 10.9 and answer the questions that each one poses.

Chances are, you concluded that the coffeepot had been transformed into a bird feeder but that the raccoon was still a raccoon despite its radical surgery; even fourth graders come to these conclusions (Keil, 1986, 1989). Now how is it possible that the coffeepot could be made into something entirely different, whereas the raccoon could not?

The concepts that people form are influenced in part by the theories they have about how the world operates (Gelman & Kalish, 2006; Keil, 1994; Medin, 1989). For example, young children—even infants—seem to make a basic distinction between human-made objects (e.g., coffeepots and bird feeders) and biological entities (e.g., raccoons and skunks) (Gelman, 2003;

<p>1. Doctors took a coffeepot that looked like this:</p>  <p>They sawed off the handle, sealed the top, took off the top knob, and sawed off and sealed the spout. They also sawed off the base and attached a flat piece of metal. They attached a little stick, cut a window in it, and filled the metal container with bird food. When they were done, it looked like this:</p>  <p>After the operation, was this a coffeepot or a bird feeder?</p>	<p>2. Doctors took this raccoon:</p>  <p>and shaved away some of its fur. They dyed what was left all black. Then they bleached a single stripe all white down the center of its back. Then, with surgery, they put in its body a sac of super-smelly odor, just like a skunk has. When they were all done, the animal looked like this:</p>  <p>After the operation, was this a skunk or a raccoon?</p>
---	--

**Figure 10.9**

What the doctors did

Both scenarios based on Keil, 1989, p. 184.

Greif, Kemler Nelson, Keil, & Gutierrez, 2006; Mandler, 2003). Furthermore, young children seem to conceptualize the two categories in fundamentally different ways: Human-made objects are defined largely by the *functions* they serve (e.g., keeping coffee warm or feeding birds), whereas biological entities are defined primarily by their origins (e.g., the parents who brought them into being or their DNA). Thus, when a coffeepot begins to hold birdseed rather than coffee, it becomes a bird feeder by virtue of the fact that its function has changed. But when a raccoon is surgically altered to look like a skunk, it still has raccoon parents and raccoon DNA and so can't possibly *be* a skunk (Keil, 1987, 1989). Thinking along similar lines, even preschoolers will tell you that you can't change a yellow finch into a bluebird by giving it a coat of blue paint or dressing it in a bluebird costume (Keil, 1989).

Theories about the world begin to emerge in the early months of life, long before children encounter formal scientific theories at school. For instance, in our discussion of *core knowledge* in Chapter 2, we saw evidence that 3- to 4-month-old infants have already begun to form one or more theories about the physical world: They're surprised when solids objects seem to be suspended in midair or appear to pass directly through other objects. Apparently, then, their early theories of physics include rudimentary understandings of gravity and of the principle that only one object can occupy a particular place at a particular time (Baillargeon, 1994; Spelke, 1994; Wynn & Chiang, 1998).

Human beings—in fact, many animal species—seem to have a keen interest in learning cause-and-effect relationships in the world around them (Gelman, 2003; Keil & Newman, 2008; Waldmann, Hagmayer, & Blaisdell, 2006). Thus, as people grow older and encounter many new experiences and a great deal of new information, they continually expand on and revise their theories about the physical world, the biological world, and the social and mental aspects of human beings. Their personal theories about the world seem to guide them as they identify potential defining features of concepts they're learning (Gelman & Kalish, 2006; Gelman & Koenig, 2003; Keil, 1987, 1989; McCauley, 1987). For example, if you were trying to learn what a *horse* is, your knowledge that it's an animal would lead you to conclude that its location (in a stable, a pasture, a shopping mall, or wherever) is an irrelevant feature. In contrast, if you were trying to learn what the *equator* is, knowing that it's something on a map or globe might lead you to suspect that location is of the utmost importance.

More generally, personal theories help people organize and make sense of personal experiences, classroom subject matter, and other new information. Although theory theory has been criticized for offering only vague descriptions of the nature, structure, and origins of a personal theory (K. Nelson, 1996; Siegler & Alibali, 2005), it's nevertheless quite useful in helping us understand why people sometimes misconstrue the world around them, as we'll see now.

## Personal Theories versus Reality

Some psychologists and educators have argued that we can never completely know what's "real" or "true" about the world because knowledge and reasoning processes are constructed and so are inherently human-made entities (e.g., Lakoff & Núñez, 1997; von Glasersfeld, 1995).<sup>8</sup> Be that as it may, some ways of understanding the world are certainly more *useful* than others, in that they're consistent with systematic scientific research and enable us to make predictions about

---

<sup>8</sup>This perspective is sometimes called *radical constructivism*.

future events with considerable accuracy (Chinn, 1998; P. K. Murphy & Alexander, 2008; Tobin & Tippins, 1993).

The personal theories children form aren't always consistent with the theories that experts in a particular field have developed. For example, what is *rain*? Here is one 7-year-old's explanation:

Clouds think it's too hot, and one day they start sweating. I guess they start sweating and then the sweat falls on us. (Stepans, 1991, p. 95)

And what shape is the earth that the rain falls on? Some fifth graders might tell you that it's "round, like a thick pancake" or a hollowed-out sphere we live inside of (Brewer, 2008; Vosniadou, 1994).

Even adults don't always have their facts straight (Brewer, 2008; Chi, 2008; Losh, Tavani, Njoroge, Wilke, & McAuley, 2003). For example, my husband (a former geography professor) tells me that some students in his undergraduate geography classes believed that rivers always run from north to south (after all, water can run only "downhill") and that the Great Lakes contain saltwater. I've found misconceptions in my own college classes as well, such as the belief that negative reinforcement involves the presentation of an aversive stimulus (see Chapter 4 for the correct explanation) and the belief that rote learning is more effective than meaningful learning (Lennon, Ormrod, Burger, & Warren, 1990). And many adults, even if they've studied physics, think that in order to keep an object moving through space, one must continually apply force to the object—a notion inconsistent with physicists' principle of *inertia* (Chi, 2008; diSessa, 1996).

Figure 10.10 lists some of the misconceptions researchers have observed in children, and in some cases in adults as well. People's erroneous notions about the world probably have a variety of sources. Sometimes misconceptions result from how things *appear* to be; for example, from our perspective living here on the earth's surface, the sun looks as if it moves around the earth, rather than vice versa. Sometimes misconceptions are fostered by common expressions in language; for instance, we often talk about the sun "rising" and "setting." Sometimes people infer incorrect cause-and-effect relationships between two events simply because the events often occur at the same time—a problem of mistaking correlation for causation. Perhaps fairy tales and popular television cartoons play a role in promoting misconceptions; as an example, after cartoon "bad guys" run off the edge of a cliff, they usually remain suspended in air until they realize there's nothing solid holding them up. And unfortunately it's sometimes the case that students acquire erroneous ideas from textbooks or teachers. For example, geometry textbooks often portray rectangles as long and skinny and parallelograms as slanted, even though some rectangles are squares and some parallelograms are rectangles (A. C. Butler, Zaromb, Lyle, & Roediger, 2009; Byrnes, 1996; diSessa, 1996; Glynn, Yeany, & Britton, 1991; Marcus 2008; Masters et al., 2010).

When students have few, if any, misunderstandings about a particular phenomenon, helping them acquire more sophisticated theories about the phenomenon is a fairly straightforward process, as we'll see in the next section. When students have many well-engrained misconceptions about the topic, however, helping them acquire scientifically acceptable understandings is more difficult, as we'll discover in a later section on conceptual change.

## Fostering Theory Development

Because personal theories (like all theories) are integrated bodies of knowledge, long-term memory storage processes that enhance such integration—for instance, meaningful learning, internal



**In biology**

- Plants use their roots to take in “food” (e.g., water, nutrients) from the soil (K. Roth & Anderson, 1988; Vosniadou, Vamvakoussi, & Skopeliti, 2008). (From the perspective of biology, plants produce their own food through photosynthesis.)
- Vision involves something moving outward from the eye toward the object being seen (Winer & Cottrell, 1996; Winer et al., 2002). (In reality, the opposite is true: Light rays bounce off the object to the eye.)

**In astronomy**

- The sun revolves around the earth. It “rises” in the morning and “sets” in the evening, at which point it “goes” to the other side of the earth (Vosniadou, 1991; Vosniadou & Brewer, 1987).
- The earth is shaped like a round, flat disk, with people living on its top, or a hollowed-out sphere, with people living on a horizontal surface in its middle (Brewer, 2008; Vosniadou et al., 2008).
- Space has an absolute “up” and “down”; people standing at the South Pole will fall off the earth (Sneider & Pulos, 1983; Vosniadou et al., 2008).

**In climatology**

- The four seasons are the result of the earth’s distance from the sun; it’s closer to the sun in the summer, farther away in the winter (V. R. Lee, 2010). (In fact, distance from the sun is largely irrelevant; seasons are the result of the angle at which the sun’s rays hit different parts of the earth’s surface.)

**In physics**

- Objects exist for a purpose. For example, some rocks are pointy so that animals that live nearby can scratch themselves when they have an itch (Kelemen, 1999, 2004).
- Any moving object has a force acting on it. For example, a ball thrown in the air continues to be pushed upward by the force of the

throw until it begins its descent (Chi, 2008; diSessa, 1996). (In reality, force is needed only to change the direction or speed of an object; otherwise, *inertia* is at work.)

- If an astronaut were to open the hatch while traveling in outer space, he or she would be “sucked out” by the vacuum in space (Haskell, 2001). (In reality, the astronaut would be blown out by the air inside the spacecraft.)

**In mathematics**

- Multiplication always leads to a bigger number (De Corte, Greer, & Verschaffel, 1996). (This principle holds true only when the multiplier is larger than 1.)
- Division always leads to a smaller number (Tirosh & Graeber, 1990; Vosniadou et al., 2008). (This principle holds true only when the divisor is larger than 1.)
- Rectangles must have widths different from their lengths (rather than four equal sides); parallelograms must be slanted (rather than having right angles) (Masters et al., 2010).

**In geography, history, and social studies**

- The lines separating countries or states are marked on the earth (H. Gardner, Torff, & Hatch, 1996).
- Erosion is largely something that happened in the past; for example, the Grand Canyon is no longer eroding (Martínez, Bannan-Ritland, Kitsantas, & Baek, 2008).
- Early human beings lived at the same time that dinosaurs did (Brophy, Alleman, & Knighton, 2009).
- Christopher Columbus was the first person to believe that the world is round rather than flat (Hynd, 2003).
- People are poor only because they don’t have enough money to buy a job. Giving a poor person a small amount of money will make the person rich (Delval, 1994).
- People can move from one social class to another by making superficial changes, perhaps by changing from rags to nice clothing, furs, and jewelry (Delval, 1994).

**Figure 10.10**

Examples of common misconceptions

organization, and elaboration—are, of course, likely to enrich those theories. Psychologists and educators have offered additional suggestions as well:

♦ *Physical models can help learners tie ideas together.* In some cases, learners' personal theories include **mental models**—representations of how particular concepts and principles interrelate or how a specific system works—that reflect the structure of external reality (Clement, 2008; Mayer, 2010a). Instructors can facilitate the formation of accurate models by presenting physical versions of them, perhaps in the form of a flowchart showing the steps a computer program takes, a diagram illustrating how pulleys can help someone lift heavy objects, a three-dimensional double helix depicting the structure of DNA, or a computer simulation of how an electric motor works (Carney & Levin, 2002; Mayer, 2010a; Reiner et al., 2000).

♦ *Group interaction can enhance learners' theoretical understandings.* Often learners acquire more sophisticated understandings when they discuss a phenomenon they've observed, exchange perspectives about it, and build on one another's ideas (e.g., O'Donnell & King, 1999; C. L. Smith, 2007; Vosniadou et al., 2008). We'll look at the nature and benefits of group interactions more closely in Chapter 13.

♦ *Some personal theories and mental models can be helpful even when they aren't entirely accurate.* Sometimes theories and models can help learners understand and predict phenomena even though they don't precisely reflect what experts believe to be the true state of affairs. For example, in Chapter 8, I presented the dual-store model of memory, and I've continued to refer to working memory and long-term memory as distinctive entities. Research findings are increasingly revealing that the dual-store model oversimplifies how human cognition and memory operate (see the section "Challenges to the Dual-Store Model" in Chapter 8). Nevertheless, the working-versus-long-term distinction is a *useful* one that can often help us predict how students are likely to learn and perform in the classroom. Similarly, a *heat-flow* model of how a warm substance heats a colder one (heat travels from one to the other) doesn't accurately capture the molecular nature of heat (molecules move more quickly in a warm substance than in a cold one). Yet the heat-flow notion can often help students make reasonably accurate predictions about temperature and is especially useful when learners have only a limited ability to think abstractly about the nature of heat (M. C. Linn, 2008; M. C. Linn & Muilenburg, 1996; Reiner et al., 2000).

We mustn't take this idea too far, however. When learners' theories and models are substantially different from experts' views, they can wreak havoc with new learning. In such situations, conceptual change is clearly in order, as we'll see shortly.

## WORLDVIEWS

---

People's personal theories tend to be related to particular phenomena in particular domains—for instance, they might be related to basic understandings of how human memory works or how physical objects interact in space. In contrast, a **worldview** is a general set of beliefs and assumptions about reality—about *how things are and should be*—that influence understandings of a wide variety of phenomena (Koltko-Rivera, 2004). Following are examples:

- Life and the universe came into being through random acts of nature *or* as part of a divine plan and purpose.

- Objects in nature (rocks, trees, etc.) have some degree of consciousness *or* are incapable of conscious thought.
- Human beings are at the mercy of the forces of nature *or* must learn to live in harmony with nature *or* should strive to master the forces of nature.
- One's sense of well-being is best secured by relying on scientific principles and logical reasoning processes *or* by seeking guidance and support from sources beyond the realm of scientific and logical thought.
- People's successes and failures in life are the result of their own actions *or* divine intervention *or* fate *or* random occurrences.
- The human world is fair and just (e.g., good deeds ultimately bring rewards, misdeeds are eventually punished) *or* is not necessarily fair and just. (M. Cole & Hatano, 2007; Furnham, 2003; Koltko-Rivera, 2004; Medin, 2005)

To a considerable degree, such beliefs and assumptions are probably culturally transmitted, with different cultures communicating somewhat different beliefs and assumptions through adults' day-to-day interactions with one another and with children (Astuti, Solomon, & Carey, 2004; M. Cole & Hatano, 2007; Koltko-Rivera, 2004; Losh, 2003). Immersion in various religious groups also comes into play. For instance, some people who strongly believe that human beings are part of a divine plan and purpose reject as preposterous the evolutionary origins of the human species (Evans, 2008; Losh, 2003).

Worldviews are often such an integral part of everyday thinking that people take them for granted and usually aren't consciously aware of them. In many cases, then, worldviews encompass *implicit* rather than explicit knowledge. Nevertheless they influence learners' interpretations of everyday events and classroom subject matter. Consider these examples:

- After a major hurricane ripped through southern Florida in the summer of 1992, many fourth and fifth graders attributed the hurricane to natural causes, but some children—those who had heard alternative explanations from family members, neighbors, or church groups—believed that people's actions or supernatural forces also played a role in the hurricane's origins and destructiveness (O. Lee, 1999).
- When American high school students talk about American history, European Americans are likely to depict historical events as leading to increasing freedom, equality, and democracy for its citizens. African Americans are more likely to depict historical events as contributing to or maintaining racist and oppressive attitudes and practices (T. Epstein, 2000). Similarly, American adults differ considerably in their views of early confrontations between the Native Americans and the European and Mexican American settlers. From an Apache perspective, the settlers were barbarians who hung people by the neck without remorse, but from the European and Mexican perspective, early Native Americans were lawless folks who shamelessly took other people's private property (Jacoby, 2008).
- When American high school students read newspaper articles about the appropriateness or inappropriateness of prayer in public schools, some view the trend away from prayer as a sign of "progress" toward greater religious freedom. But others—those from deeply religious Christian families, for instance—view the same trend as a "decline" that reflects abandonment of the country's religious heritage (Mosborg, 2002).

On some occasions, learners' differing worldviews can and must be accommodated within the context of classroom lessons and activities. But in other instances, a certain worldview may

impede learners' mastery of important classroom subject matter. In such situations, the challenge for teachers is one of bringing about *conceptual change*, our next topic.

## THE CHALLENGE OF CONCEPTUAL CHANGE

---

In some cases, replacing one belief with another belief is fairly straightforward. For instance, if you think that my birthday is January 1, I can simply tell you that, no, January 1 is *my brother's* birthday—mine is August 22—and you might very well make the mental adjustment. But when a belief or misconception is part of a larger theory or worldview, a major overhaul may sometimes be in order. The process of replacing one personal theory or belief system with another, presumably more adaptive one is known as **conceptual change**.<sup>9</sup> Don't let the term *conceptual* mislead you here: For the most part, we're talking about changing tightly interconnected sets of ideas rather than single, isolated concepts.

As a result of both informal experience and formal instruction, growing children and adolescents typically undergo some conceptual change about many topics (J. A. Dixon & Kelley, 2007; Vosniadou, 2008). Yet research in classrooms indicates that learners of all ages often hold quite stubbornly to certain misconceptions and counterproductive beliefs about the world, even after considerable instruction that explicitly contradicts them (Chambliss, 1994; Chinn & Brewer, 1993; Vosniadou, 2008; Winer, Cottrell, Gregg, Fournier, & Bica, 2002). Why are learners' counterproductive beliefs often so resistant to change? Theorists have offered several possible explanations:

- ◆ *Learners' existing beliefs affect their interpretations of new information.* Thanks to the processes of meaningful learning and elaboration—processes that usually facilitate learning—learners are more likely to interpret new information in ways that are consistent with what they already “know” about the world, to the point where they continue to believe some or all of what they've always believed (Brewer, 2008; Kendeou & van den Broek, 2005; Porat, 2004).

- ◆ *Most learners have a confirmation bias.* Learners of all ages (college students included) tend to look for information that confirms their existing beliefs and to ignore or discredit any contradictory evidence—a phenomenon known as **confirmation bias** (Chinn & Brewer, 1993; Kunda, 1990; P. K. Murphy & Mason, 2006; E. R. Smith & Conrey, 2009). For example, when students in a high school science lab observe results that contradict what they expected to happen, they might complain that “Our equipment isn't working right” or “I can never do science anyway” (Minstrell & Stimpson, 1996, p. 192).

- ◆ *Learners' existing beliefs are often consistent with their everyday experiences.* Truly accurate explanations of physical phenomena (e.g., commonly accepted principles or theories in physics) can be fairly abstract and difficult to relate to everyday reality (P. A. Alexander, 1997; D. B. Clark, 2006; Wiser & Smith, 2008). For example, although physicists agree that all matter has weight, a tiny piece of Styrofoam doesn't *feel* as if it weighs anything (C. L. Smith, 2007). And although the law of inertia tells us that force is needed to *start* an object in motion but not to *keep* it in

---

<sup>9</sup>Some theorists use the term *conceptual change* in reference to any situation in which one belief or set of beliefs is replaced by another, even a situation as simple as revising a belief about a person's birthday. They may refer to more extensive changes—the “overhaul” variety—as *radical conceptual change*, *restructuring*, or *reconstruction*.

motion, we know from experience that if we want to move a heavy object across the floor, we must keep on pushing it until we get it where we want it (Driver, Asoko, Leach, Mortimer, & Scott, 1994). Consider, too, Newton's second law: Force is a product of mass and acceleration ( $F = ma$ ). This law tells us that force must always be accompanied by acceleration—an idea that many people have trouble relating to their own observations. A young woman taking an introductory college physics course expressed her confusion this way:

I want it to be true, but there's just no way it is, you know ... I don't know why I just started doubting myself because that stupid force formula.... I mean I want what seems logical to me to make sense with what I've learned and what you can, like, you know, like when we were talking about the formulas. I mean you learn these formulas and you apply them to all these problems. But when something that you know is true—I mean to me it makes so much sense that it's crazy to even debate it, that if you're pushing this with a constant force, and you see it moving, that it's not accelerating. (diSessa, Elby, & Hammer, 2003, pp. 275–276)

- ◆ *Some erroneous beliefs are integrated into a cohesive whole, with many interrelationships existing among various ideas.* In such instances, changing misconceptions involves changing an entire organized body of knowledge—an entire theory or worldview—rather than a single belief (Derry, 1996; Koltko-Rivera, 2004; P. K. Murphy & Mason, 2006; Vosniadou et al., 2008). For example, the belief that the sun revolves around the earth may be part of a more general earth-centered view of things, perhaps one that includes the moon, stars, and various other heavenly bodies revolving around the earth as well. In reality, of course, the moon revolves around the earth, the earth revolves around the sun, and the other stars aren't significantly involved with the earth one way or the other. Yet the earth-centered view is a much easier one to understand and accept (on the surface, at least), and everything fits so nicely together.

- ◆ *Learners may fail to see an inconsistency between new information and their prior beliefs.* In many situations, people learn new information without letting go of their prior beliefs, so that long-term memory simultaneously holds inconsistent ideas (Keil & Silberstein, 1996; Mintzes, Trowbridge, Arnaudin, & Wandersee, 1991; Ohlsson, 2009; Winer & Cottrell, 1996). Sometimes this happens because people learn the new information at a rote level, without relating it to the things they already know and believe (Chambliss, 1994; Kendeou & van den Broek, 2005; C. L. Smith, 2007). In other cases it may occur because existing beliefs take the form of implicit knowledge—knowledge that can't consciously be accessed (Keil & Silberstein, 1996; Strike & Posner, 1992). In either situation, learners don't realize that the new things they've learned contradict what they already believe, and they may continue to apply previously acquired beliefs when interpreting new situations (Champagne, Klopfer, & Gunstone, 1982; Hynd, 2003; Luque, 2003).

- ◆ *Learners may have a personal or emotional investment in their existing beliefs.* For one reason or another, learners may be especially committed to certain beliefs, perhaps insisting that “This theory is what I believe in! Nobody can make me change it!” (Mason, 2003, p. 228). In some instances their beliefs may be an integral part of their religion, lifestyle, or culture (Chambliss & Garner, 1996; Porat, 2004; Southerland & Sinatra, 2003). In other cases learners may interpret challenges to their belief systems as threats to their self-efficacy, overall self-esteem, or general sense of well-being (Gregoire, 2003; Feinberg & Willer, 2011; Linnenbrink & Pintrich, 2003; D. K. Sherman & Cohen, 2002).

- ◆ *Sometimes learners' existing beliefs are supported by their social environment.* To the extent that others in a learner's support network (e.g., one's family, peers, religious group, or political party)

hold a particular set of beliefs, the learner will have less reason to abandon those beliefs (Evans, 2008; Hatano & Inagaki, 2003; Porat, 2004). We see the effect of social context even in highly educated academic communities. For instance, the dominance of behaviorism in North American psychology in the first few decades of the twentieth century encouraged most budding psychologists to take an S–R approach to learning and to reject quite adamantly any suggestion that they look at the decidedly nonobservable phenomenon called *thinking*.

## Promoting Conceptual Change

When students have few existing beliefs about a particular topic, helping them acquire more sophisticated understandings can be relatively easy. But when they have many naive beliefs and misconceptions about the topic, helping them master explanations consistent with current scientific thinking is apt to be more difficult. In the latter situation, teachers face a twofold challenge: They must not only help students learn new things but also help them *unlearn*, or at least *inhibit*, some of their existing beliefs (Hynd, 2003). Theorists and researchers have offered several suggestions for getting students on the road to conceptual change:

- ◆ *Before beginning instruction, teachers should determine what beliefs and misconceptions students currently have about a topic.* Teachers can more easily address students' counterproductive beliefs when they know what those beliefs *are* (P. K. Murphy & Alexander, 2008). Thus, a lesson might begin with informal questioning or a formal pretest to probe students' current views of the subject matter at hand. The following dialogue illustrates the kinds of probing questions that might be in order:

- Adult: What is rain?  
 Child: It's water that falls out of a cloud when the clouds evaporate.  
 Adult: What do you mean, "clouds evaporate"?  
 Child: That means water goes up in the air and then it makes clouds and then, when it gets too heavy up there, then the water comes and they call it rain.  
 Adult: Does the water stay in the sky?  
 Child: Yes, and then it comes down when it rains. It gets too heavy.  
 Adult: Why does it get too heavy?  
 Child: 'Cause there's too much water up there.  
 Adult: Why does it rain?  
 Child: 'Cause the water gets too heavy and then it comes down.  
 Adult: Why doesn't the whole thing come down?  
 Child: Well, 'cause it comes down at little times like a salt shaker when you turn it upside down. It doesn't all come down at once 'cause there's little holes and it just comes out.  
 Adult: What are the little holes in the sky?  
 Child: Umm, holes in the clouds, letting the water out. (dialogue from Stepan, 1991, p. 94)

This conception of a cloud as a "salt shaker" of sorts is hardly consistent with the scientifically accepted view of how and why rain occurs.

In some instances, effective teacher probing involves delving into students' unspoken, implicit beliefs about a topic. For example, middle school and high school students may think of numbers as being discrete entities used for counting (1, 2, 3, etc.) rather than a continuum of all

possible quantities of something; this overly simplistic understanding of numbers can wreak havoc on students' ability to understand and use fractions, decimals, and negative numbers (Vosniadou et al., 2008). And college students may think about such concepts as *heat*, *light*, and *electricity* as being physical substances rather than as emerging, dynamic processes (Slotta & Chi, 2006). In such cases, instruction may require a concerted, ongoing effort to help students reconceptualize old, seemingly familiar concepts to enable more flexible and productive thinking and learning—a paradigm shift, if you will (Chi, 2008; Clement, 2008).

◆ *Students should learn correct information in a meaningful rather than rote fashion.* Students will notice inconsistencies between new information and prior beliefs only when they try to make connections between the new and the old. To use levels-of-processing terminology for a moment, students are most likely to modify their misconceptions in light of new data if they process those data *in depth*—in other words, if they become actively engaged in learning and truly try to understand the information being presented. Thus instruction is most likely to encourage meaningful learning, and therefore to promote conceptual change, when it intensively focuses on a few key ideas rather than superficially covering many topics (D. B. Clark, 2006; diSessa, 1996, 2008; C. Howe, Tolmie, Greer, & Mackenzie, 1995; M. C. Linn, 2008; Pintrich, Marx, & Boyle, 1993; Slusher & Anderson, 1996).

In Chapter 9, I mentioned analogies as one potentially effective way of helping students relate new ideas to what they already know. Carefully chosen analogies are often useful in bringing about conceptual change, provided that students don't draw inappropriate parallels (D. B. Clark, 2006; Clement, 2008). For example, if students in a science class resist the idea that a table and a book on its surface each exerts a force on the other—the table pushing up, the book pushing down—a teacher might first show a book resting on a spring (where the upward and downward forces are both obvious), then on a foam pad, then on a thin and bendable piece of wood, and finally on a hard table (Clement, 2008).

◆ *Students can sometimes build effectively on kernels of truth in their existing understandings.* Often students' current understandings have a partly-right-and-partly-wrong quality (diSessa, 1996, 2006, 2008). For example, in the earlier question-and-answer session about rain, the child correctly understands that (1) clouds have water, (2) evaporation is somehow involved in the water cycle, and (3) rain is the result of water being too heavy to remain suspended in air. Such knowledge provides a good starting point for further instruction. For instance, it would be important to explain where in the water cycle evaporation occurs (i.e., in cloud formation) and how a cloud actually is water rather than being a shakerlike water container.

◆ *Students are more likely to revise their current way of thinking when they believe revision is in order.* Many theorists suggest that conceptual change is most likely to occur when learners encounter evidence that blatantly contradicts what they currently believe. Such contradictory evidence can create a sense of mental discomfort—something that some theorists call *disequilibrium* and others call *cognitive dissonance* (see Chapters 12 and 16, respectively). As an example, one first-grade teacher wanted to challenge her students' belief that rocks always sink in water. She showed her class two stones, a small piece of granite and a considerably larger piece of pumice. Pumice, of course, results when molten lava cools; because it has many pockets of air, it's relatively light and so can float. Before the teacher dropped the stones into a container of water, she asked the class to make a prediction, and a girl named Brianna predicted that both stones would sink. The granite did sink, but the pumice floated. Brianna was noticeably agitated: "No!

*No! that's not right! That doesn't go with my mind (student grabs her head) it just doesn't go with my mind*" (M. G. Hennessey, 2003, p. 121).

Theorists have offered several suggestions for how teachers might create mental disequilibrium and then encourage students to address it:

- Ask questions that challenge students' current beliefs.
- Present phenomena that students can't adequately explain within their existing perspectives.
- Ask students to make predictions about what will happen in various circumstances—predictions that, given their present beliefs, are likely to be wrong.
- Encourage students to conduct experiments to test various hypotheses.
- Ask students to provide possible explanations for puzzling phenomena.
- Engage students in discussions of the pros and cons of various explanations.
- Show how one explanation of an event or phenomenon is more plausible (i.e., makes more sense) than others. (Andre & Windschitl, 2003; Chinn & Malhotra, 2002; Echevarria, 2003; Guzzetti, Snyder, Glass, & Gamas, 1993; Hatano & Inagaki, 2003; C. Howe et al., 1995; P. K. Murphy & Mason, 2006; Pine & Messer, 2000; G. J. Posner, Strike, Hewson, & Gertzog, 1982; K. Roth, 2002; C. L. Smith, 2007; Vosniadou, 2008)

Such strategies encompass a wide variety of instructional methods, including demonstrations, hands-on experiments, teacher explanations, and student discussions. There's certainly no single "best" instructional method for promoting conceptual change.

♦ *Students must explicitly compare their existing beliefs with alternative explanations.* Students are more likely to replace a misconception with a more accurate understanding—rather than to accept the accurate understanding while also *retaining* the misconception—if they're thinking about both ideas at the same time. In other words, the erroneous and accurate beliefs should simultaneously be in working memory. Unfortunately, many textbook authors seem to be oblivious to this point: When they present new ideas in science or history, they neglect to point out that these ideas may be inconsistent with what students currently believe. The result is that students often *don't* shed their misconceptions in the face of contradictory information (deLeeuw & Chi, 2003; Kowalski, Taylor, & Guggia, 2004; Mason, Gava, & Boldrin, 2008; McKeown & Beck, 1990; Otero, 1998; Southerland & Sinatra, 2003).

One strategy for encouraging students to compare various beliefs and explanations is to engage them in discussions about the pros and cons of each one (P. K. Murphy & Mason, 2006; Siegler & Lin, 2010; C. L. Smith, 2007; Vosniadou et al., 2008). Textbooks can present the pros and cons of various perspectives as well. One effective approach is **refutational text**, in which possible objections to a particular explanation are presented and then discredited. In this way, students are persuaded to buy into the preferred explanation and also "inoculated" against accepting counterarguments they might encounter at a future time (Hynd, 2003; Kowalski et al., 2004; Mason et al., 2008; C. Shanahan, 2004).

♦ *Students must want to learn the correct explanation.* Students are most likely to engage in deep processing and meaningful learning when they're motivated to do so (Evans, 2008; O. Lee & Anderson, 1993; Pintrich et al., 1993). At a minimum, they must be interested in the subject matter, believe it will help them achieve their personal goals, set their sights on mastering it, and have sufficient self-efficacy to believe they *can* master it (Andre & Windschitl, 2003; Gregoire, 2003; Sinatra & Mason, 2008). Furthermore, students must not see the new, contradictory



information as in some way threatening their self-esteem or general sense of well-being (Feinberg & Willer, 2011; Minstrell & Stimpson, 1996; D. K. Sherman & Cohen, 2002). And ideally, the classroom should be socially and emotionally supportive of conceptual change (Hatano & Inagaki, 2003; Sinatra & Mason, 2008). For instance, students must feel confident that their teacher and classmates won't ridicule them for expressing logical but incorrect ideas, and they must believe that the ultimate goal of a lesson is understanding the subject matter rather than simply performing well on a quiz or assignment. As we consider motivation in Chapters 16 and 17, we'll identify strategies for accomplishing such things.

Some theorists have suggested that it may sometimes be easier to help students *understand* new explanations than to make students *believe* and *accept* them, especially when the subject matter involves controversial issues such as evolution, capital punishment, or abortion (Eagly, Kulesa, Chen, & Chaiken, 2001; D. Kuhn, Shaw, & Felton, 1997; Sinatra, Southerland, McConaughy, & Demastes, 2003; Southerland & Sinatra, 2003). Perhaps the most defensible approach when dealing with controversial issues is to help students understand the reasoning behind various perspectives, as well as the evidence for and against each one, but to acknowledge that students must ultimately come to conclusions consistent with their own moral and religious convictions (Sinatra et al., 2003; Southerland & Sinatra, 2003).

♦ *Throughout a lesson, students' understanding should be monitored for particularly tenacious misconceptions.* Because of human beings' natural tendency to reinterpret new information in light of what they already "know," some misconceptions may persist in spite of a teacher's best efforts. These misconceptions are sometimes blatantly incorrect; at other times they may be sort-of-but-not-quite correct. To illustrate the latter situation, let's consider a class discussion involving human vision and transparent objects. As you read the discussion, keep in mind that a common definition of *transparent*—"something you can see through"—erroneously implies that sight originates with the eye and goes outward to and through the transparent object. *Transparent* is more accurately defined as "something light passes through." The teacher, Ms. Ramsey, begins by projecting a drawing similar to this one on a screen at the front of the classroom:

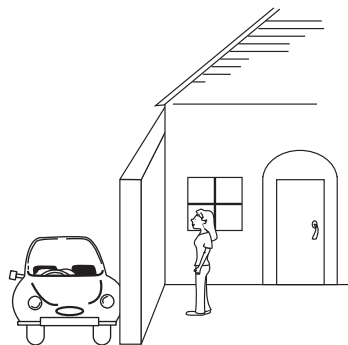

- Ms. Ramsey: Why can't the girl see around the wall?  
 Annie: The girl can't see around the wall because the wall is opaque.  
 Ms. Ramsey: What do you mean when you say the wall is opaque?  
 Annie: *You can't see through it. It is solid.*

- Brian: (calling out) The rays are what can't go through the wall.  
 Ms. Ramsey: I like that answer better. Why is it better?  
 Brian: The rays of light bounce off the car and go to the wall. They can't go through the wall.  
 Ms. Ramsey: Where are the light rays coming from originally?  
 Students: The sun.  
 Annie: *The girl can't see the car because she is not far enough out.*  
 Ms. Ramsey: So you think her position is what is keeping her from seeing it. (She flips down an overlay with the answer.) Who was better?  
 Students: Brian.  
 Ms. Ramsey: (to Annie) Would she be able to see if she moved out beyond the wall?  
 Annie: Yes.  
 Ms. Ramsey: Why?  
 Annie: *The wall is blocking her view.*  
 Ms. Ramsey: Is it blocking her view? What is it blocking?  
 Student: Light rays.  
 Ms. Ramsey: Light rays that are doing what?  
 Annie: If the girl moves out beyond the wall, then the light rays that bounce off the car are not being blocked. (K. Roth & Anderson, 1988, pp. 129–130)

Notice how Ms. Ramsey isn't satisfied with Annie's original answer that the wall is opaque. With further questioning, it becomes clear that Annie's understanding of opaqueness is off target: She talks about the girl being unable to "see through" the wall rather than light's inability to pass through the wall. With Ms. Ramsey's continuing insistence on precise language, Annie eventually begins to bring light rays into her explanation (K. Roth & Anderson, 1988).

To truly promote conceptual change, assessment of students' current understandings must go well beyond asking students to spit back facts, definitions, and formulas—things they might have memorized in a rote manner. Teachers are most likely to detect misconceptions when they ask students to *use* and *apply* what they've learned, as Ms. Ramsey does in the conversation just presented (D. E. Brown & Hammer, 2008; D. B. Clark, 2006; K. Roth, 1990).

In assessing students' progress in gaining more sophisticated and accurate understandings of classroom topics, teachers must remember that conceptual change doesn't always occur in one fell swoop. Instead it often occurs gradually over a lengthy time period, especially when it involves overhauling personal theories about complex, multifaceted topics—the nature of matter, force and energy, the solar system, evolution, and so on. And until students' newly acquired understandings are rock solid, they may give conflicting explanations from one time to the next (V. R. Lee, 2010; P. K. Murphy, 2007; Vosniadou, 2008).

As we've seen, teachers can do a variety of things to nudge learners toward conceptual change. Ultimately, however, learners themselves are in control of the cognitive processes (meaningful learning, internal organization, elaboration, etc.) that will enable them to make sense of new ideas and thereby acquire more accurate understandings. Learners' proficiency in directing their own learning efforts and their understanding of what it actually *means* to learn something are key elements in their ability to revise their thinking about classroom subject matter. Accordingly, we'll revisit the topic of conceptual change after we've discussed metacognition in Chapter 14.

Usually—but not always—learners abandon erroneous and counterproductive beliefs as they acquire considerable knowledge about a topic. We look now at how the quality of knowledge about a topic changes over time and may gradually evolve into true *expertise*.

## DEVELOPMENT OF EXPERTISE

---

Obviously, people acquire an increasing amount of information in their long-term memories over time. Many people eventually acquire a great deal of information about a particular topic or subject matter, to the point where we can say that they're *experts* in their field. It appears, however, that experts don't just know more than their peers; their knowledge is also *qualitatively* different from that of others. In particular, their knowledge tends to be tightly organized, with many interrelationships among the things they know and with many abstract generalizations unifying more concrete details. Such qualities enable experts to retrieve the things they need more easily, to interpret new domain-related situations more productively, to find parallels between seemingly diverse situations, and to solve problems more creatively and effectively (J. M. Alexander, Johnson, Scott, & Meyer, 2008; P. A. Alexander, 1998; Bédard & Chi, 1992; Horn, 2008; Peskin, 1998; Proctor & Dutta, 1995).

Patricia Alexander (1997, 1998, 2003, 2004) has suggested that there may be three, somewhat distinct stages in the acquisition of knowledge related to a particular subject matter. At the first stage, which she calls *acclimation*, learners familiarize themselves with a new content domain, perhaps by taking an introductory course in biology, economics, or art history. At this point, they pick up a lot of facts that they tend to store in relative isolation from one another. As a result of such "fragmented" learning, they're likely to hold on to many misconceptions they may have acquired before they started studying the subject systematically.

At the second stage, which Alexander calls *competence*, learners acquire considerably more information about the subject matter, and they also acquire some general principles that help tie the information together. Because learners at the competence stage make numerous interconnections among the things they learn, they're likely to correct many of the specific misconceptions they've previously developed. Those misconceptions that remain, however, are apt to pervade much of their thinking about the subject. At the competence stage, learners' entire approach to the subject matter begins to resemble that of experts; for example, they may start to "think like a historian" or to engage in some of their own scientific research. Competence is something people acquire only after studying a particular subject in depth, perhaps through an undergraduate major, a master's degree, or several years of professional experience.

At the final stage—*expertise*—learners have truly mastered their field. They know a great deal about the subject matter, and they've pulled much of their knowledge together into a tightly integrated whole. They now help lead the way in terms of conducting research, proposing new ways of looking at things, solving problems, and, in general, creating new knowledge. Expertise comes only after many years of studying and experience in a particular field; as a result, few learners ever reach this stage.

Because knowledge at the competence and expertise stages is fairly well integrated, any misconceptions at either of these stages may be especially resistant to change (P. A. Alexander, 1998).

As an example, let's return to our discussion of verbal learning research in Chapter 7. Initially, verbal learning researchers (most of them certainly experts in psychology) tried to explain human language-based learning within the context of behaviorism, the predominant theoretical perspective at the time. It was only after several decades, as evidence mounted up that behaviorist principles *couldn't* explain, that these researchers abandoned their S–R explanations for more cognitive ones.<sup>10</sup>

Alexander points out that the development of expertise depends not only on the acquisition of knowledge but also on effective learning strategies and a strong interest in the subject matter (also see Schraw, 2006). We'll identify many effective learning strategies in Chapter 14, and we'll examine the specific benefits of interest in Chapter 17.

## GENERALIZATIONS ABOUT THE NATURE OF KNOWLEDGE \_\_\_\_\_

In this chapter, we've considered a variety of perspectives about how knowledge in long-term memory might be encoded and organized. At this point, a few generalizations are in order:

- ◆ *There can be considerable redundancy in how information is stored.* When I described various possible organizational arrangements of long-term memory early in the chapter, I mentioned a particular finding by Rips and colleagues (1973): On average, people confirm that “A collie is an animal” more quickly than they confirm that “A collie is a mammal.” A more economical use of long-term memory “space” would be to remember only that a collie is a mammal and that a mammal is an animal; from these two pieces of information, one could logically deduce that a collie must be an animal. Specifically storing the collie-is-animal fact, then, is redundant with other things in long-term memory. But if we have plenty of “room” there, why not store the same information in the variety of ways in which we might need it later on?

As we've noted, too, the same information may be encoded in two or more different forms—for instance as both words and a visual image (recall the example of the car with ski racks by the tree). Different forms of encoding facilitate different ways of thinking about a topic (Eisner, 1994; Salomon, 1979/1994). A picture may sometimes be worth a thousand words, depicting spatial relationships that are hard to capture in any other way. Yet words and meanings may more easily allow us to interrelate similar ideas (perhaps through the propositions they have in common) in ways that spatial representations wouldn't allow.

- ◆ *Most of our knowledge is a summary of our experiences rather than information about specific events.* The bulk of our knowledge appears to be semantic rather than episodic in nature: As we go through life, we continually combine our many specific experiences into general knowledge about the world that's somewhat independent of those experiences.

---

<sup>10</sup>More generally, such *paradigm shifts* in scientific communities occur only after considerable evidence and a great deal of discussion and debate. For a classic discussion of paradigm shifts, see T. Kuhn's (1970) *The Structure of Scientific Revolutions*.

Concepts are a good example of how we summarize the objects and events we encounter. For example, you've probably formed a concept that encompasses the many things you've seen with the following characteristics:

- Shorter and wider than most adult humans
- Covered with a short, bristly substance
- Appended at one end by an object similar in appearance to a paintbrush
- Appended at the other end by a lumpy thing with four pointy objects sticking upward (two soft and floppy, two hard and curved around)
- Held up from the ground by four spindly sticks, two at each end
- Usually observed in pastures or barns
- Almost always eating grass

You've no doubt attached a particular label to these similar-looking things: *cow*.

As summaries of the things we've learned, concepts have several advantages:

- *Concepts reduce the world's complexity* (Bruner, 1957; Sokal, 1974). Classifying similar objects and events makes life simpler and easier to understand. For example, when you drive along a country road, it's easier to think "There are some cows" than to think "I see a brown object, covered with bristly stuff, appended by a paintbrush and a lumpy thing, and held up by four sticks. Ah, yes, and I also see a black-and-white spotted object, covered with bristly stuff, appended by a paintbrush and a lumpy thing, and held up by four sticks. And over there is a brown-and-white spotted object. . . ."
- *Concepts allow abstraction of the environment* (Bruner, 1966; Ferrari & Elik, 2003; Pinker, 2007). An object covered with bristly stuff, appended by a paintbrush and a lumpy thing, and held up by four sticks is a very concrete thing. The concept *cow*, however, can be more abstract, incorporating such characteristics as "female," "supplier of milk," and, to the dairy farmer, "economic asset." Concepts and their labels allow individuals to think about their experiences without necessarily having to consider all of their concrete physical features.
- *Concepts enhance the power of thought* (Bruner, 1966; Oakes & Rakison, 2003; Pinker, 2007). When you're thinking about an object covered with bristly stuff, appended by a paintbrush and a lumpy thing, held up by four sticks, and so on, you can think of little else; to express this point in terms of contemporary memory theory, your working memory capacity is filled to the brim. But when you simply think *cow*, you can also think about *horse*, *dog*, *goat*, and *pig* at the same time.
- *Concepts facilitate inferences and generalization to new situations* (Halford & Andrews, 2006; Mandler, 2007; Sloutsky, Lo, & Fisher, 2001; Welder & Graham, 2001). When we learn a concept, we associate certain characteristics with it. Then, when we encounter a new instance of the concept, we can draw on our knowledge of associated characteristics to make assumptions and inferences about the new instance. For example, if you see a herd of cattle as you drive through the countryside, you can assume that you're passing through either dairy or beef country, depending on whether you see large udders hanging down between two of the spindly sticks. If you purchase a potted flower, you know that you must water it regularly because of something you've learned about the concept *flower*: It needs water to live. Thanks to concepts, we don't have to learn from scratch in each new situation.
- *Concepts make it easier for us to make connections among the things we know* (Bruner, 1957; Goldstone & Johansen, 2003). Once we've condensed and abstracted information in the

form of concepts, we can easily make associations among them in long-term memory. For instance, we can relate the concept *cow* to the concepts *bull* and *calf* in a familial sort of way and to *mammal*, *animal*, and *living thing* in a hierarchical fashion.

We must remember, however, that our summaries of the world will sometimes cause us to make mistakes. For example, when we identify a new stimulus as being a positive instance of a particular concept, we're likely to react to the stimulus as we would to any other instance of the concept. In the process, we may lose sight of the unique qualities of that particular stimulus. Furthermore, if we've identified a stimulus incorrectly, our response to it may be inappropriate. I recall that, as a young child, I once tried to make a wagon using square pieces of wood for wheels. Calling those pieces of wood *wheels* was an inaccurate categorization, and, as you can imagine, my wagon didn't move very well. Finally, in some situations we may *overclassify* our experiences. For example, when we form **stereotypes** of certain groups of people (perhaps people of specific genders, races, or cultural backgrounds), we're likely to draw many incorrect inferences about how particular members of that group are apt to behave (Gelman, 2003; Medin et al., 2007; L. J. Nelson & Miller, 1995; Oskamp, 2000).

- ◆ *In most situations, integrated knowledge is more useful than fragmented knowledge.* When we integrate the things we know, we're more likely to draw inferences that go beyond the specific things we've learned. Furthermore, as we'll discover in the next chapter, organized information is easier to remember—in other words, to retrieve—than unorganized information.

Many contemporary learning theorists stress the importance of teaching an integrated body of knowledge—knowledge that includes general principles, cause-and-effect relationships, and so on—rather than simply teaching isolated facts. In the case of mathematics, for example, teachers should help students make associations between general concepts and principles of mathematics, on the one hand, and specific procedures for solving mathematical problems, on the other (Carr, 2010; Hiebert et al., 1997; Rittle-Johnson, Siegler, & Alibali, 2001). When students learn specific mathematical procedures (e.g., how to do long division or how to add two fractions by finding a common denominator) in association with the overall logic of math, they're more likely to apply problem-solving procedures appropriately and to recognize occasions when they've obtained illogical and thus probably incorrect problem solutions.

- ◆ *The in-depth study of a few topics is often more beneficial than the superficial study of many topics.* Historically, many people have seen the role of schools as being one of promoting cultural literacy—that is, of helping children learn the many facts that a seemingly “educated” person should know (e.g., see Hirsch, 1996). Adults in Western countries are often chagrined when they hear how many children don't know the capital of France, can't list the planets of the solar system, or have no idea who wrote *Romeo and Juliet*.

Certainly schooling should, in part, be about helping children acquire a basic knowledge of the world and culture in which they live so that they can participate more fully and effectively in their society (Hirsch, 1996). Yet if schools focus exclusively on imparting isolated facts, an integrated body of knowledge about the world is unlikely to develop. In recent years, many experts have suggested that teachers focus more on teaching a few topics in depth than on covering many topics at a superficial level (e.g., Brophy, Alleman, & Knighton, 2009; M. C. Linn, 2008; Sizer, 2004; G. Wiggins & McTighe, 2005). They advocate the idea that **less is more**: When students study less material so that they can study it more thoroughly, they learn it more completely and with greater understanding, and they're more likely to undergo conceptual change when such change is warranted.

---

## SUMMARY

Long-term memory includes several different kinds of knowledge. *Declarative knowledge*—knowledge about “how things are, were, or will be”—includes both recollections of prior events in one’s life (episodic memory) and general information about the world (semantic memory). In contrast, *procedural knowledge* involves “how to do things” and, often, awareness of the conditions under which various actions are called for (*conditional knowledge*). When learners integrate their declarative and procedural knowledge to address *why* questions—for instance, when they understand why it makes sense to engage in certain procedures on certain occasions—they also have *conceptual knowledge*. Some knowledge in long-term memory is *explicit*, in that people are consciously aware of it and can easily recall and explain it, whereas other knowledge is *implicit*, largely outside the range of conscious view and mental inspection.

People probably encode information in a variety of ways, including ways that encompass physical characteristics (e.g., visual images), behaviors (e.g., productions), symbols (e.g., verbal codes), and meanings (e.g., propositions). Some information may be organized in a hierarchical format that reflects superordinate and subordinate categories, but much more is probably organized as a network (perhaps consisting of interrelated propositions) that encompasses many different kinds of relationships. Building loosely on neurological research, some theorists have proposed that any single piece of information is represented in long-term memory in a distributed fashion—that is, as a network of scattered but interconnected nodes that activate simultaneously.

People often mentally summarize what they learn from their experiences, with their summaries taking such forms as concepts, schemas, scripts, personal theories, and worldviews. *Concepts* are mental groupings of objects or events that share one or more common properties. Some concepts are concrete, in that they’re easily identified by physical appearance, whereas others are more abstract and hard to pin down in terms of observable characteristics. Learning a concept often involves learning the features that

determine which objects and events are members of the concept (i.e., positive instances) and which are nonmembers (i.e., negative instances). It may also involve forming a prototype of a typical positive instance and/or storing exemplars that represent the variability of positive instances. Teachers can help students master concepts when they capitalize on factors that facilitate concept learning—for instance, when they provide definitions, highlight defining features, simultaneously present both positive and negative instances, and ask students to generate their own examples.

A *schema* is a closely connected set of ideas related to a specific object or event. A schema that summarizes how a common event typically transpires (e.g., what a visit to the doctor’s office is usually like) is sometimes called a *script*. Schemas and scripts often influence how learners process, store, and remember new situations; for example, they allow learners to fill in missing information using their knowledge about how the world typically operates.

Some of the knowledge stored in long-term memory takes the form of *personal theories*—coherent belief systems that encompass cause-and-effect relationships about physical, biological, social, political, or mental phenomena. Personal theories influence concept learning by giving learners important clues about the features that are likely to be important. Learners’ theories aren’t always accurate reflections of the world, however, as they’ve often been constructed from incomplete or inaccurate understandings.

Whereas personal theories tend to be related to particular phenomena in particular domains, *worldviews* encompass people’s general beliefs and assumptions about reality—about “how things are and should be”—that influence understandings of a wide variety of phenomena. Although worldviews often lurk well below conscious awareness—that is, they’re likely to reflect implicit rather than explicit knowledge—they can have a significant impact on how learners interpret everyday events and classroom subject matter.

When students are starting from scratch about a new topic—that is, when they have minimal

information and few, if any, misconceptions about the topic—helping them acquire a good understanding of the topic can be relatively straightforward. For instance, teachers can present physical models that depict structures or cause-and-effect relationships, and they can encourage students to build on one another's ideas in small-group or whole-class discussions. But when students must replace existing misconceptions with more accurate explanations—that is, when they must undergo *conceptual change*—the teacher's task is more challenging, in part because students are likely to distort new information to be consistent with their current understandings and in part because students may have a personal, emotional, or social stake in maintaining their existing

beliefs. Theorists have offered numerous suggestions for promoting conceptual change; for instance, teachers should encourage meaningful learning of a few key ideas rather than rote learning of many isolated facts, and they must help students discover how new explanations are more plausible and useful than their current ones.

The development of *expertise* in a particular subject area involves acquiring an increasing amount of knowledge, making numerous interconnections within that knowledge base, and eventually integrating what's been learned into a cohesive whole. People typically become experts in a particular field only after many years of intensive study and practice.



# LONG-TERM MEMORY III: RETRIEVAL AND FORGETTING

### How Retrieval Works

Retrieval Cues

### Construction in Retrieval

*The Power of Suggestion: Effects of Subsequently Presented Information*

*Constructing Entirely New “Memories”*

*Remembering Earlier Recollections*

*Self-Monitoring during Retrieval*

*Important Cautions in Probing People’s Memories*

### Forgetting

*Decay*

*Interference and Inhibition*

*Repression*

*Failure to Retrieve*

*Construction Error*

*Failure to Store or Consolidate*

*The Case of Infantile Amnesia*

*General Principles of Retrieval for Instructional Settings*  
*Summary*

Here are definitions of four words in the English language. Can you identify the specific words to which they refer?

- The fluid part of blood
- A picture form of writing used in ancient Egypt
- A game whose object is to snap small plastic disks into a container
- A small, hard-shelled, ocean-dwelling animal that attaches itself to rocks and ships

You probably identified some of these words almost without thinking. But there’s a good chance that you couldn’t retrieve all four instantaneously. For one or more of them, you may have found yourself looking around in your long-term memory, perhaps for a minute or longer, in “places” where a word might be located. (In case you couldn’t retrieve all four words, they are *plasma*, *hieroglyphics*, *tiddlywinks*, and *barnacle*.)<sup>1</sup>

Retrieving information from long-term memory is sometimes easy and automatic, at other times slow and strenuous, and at still other times virtually impossible. We tend to remember frequently used information without conscious effort. For instance, we can quickly retrieve our mailing addresses and the names of close friends. It’s more difficult to retrieve information we seldom use. For example, we often have trouble remembering words we rarely encounter in our everyday lives (words such as *hieroglyphics* and *barnacle*). In some cases, we may feel that such words are on the tips of our tongues, yet we still can’t recall them (A. Brown, 1991; R. Brown & McNeill, 1966; also see R. Thompson, Emmorey, & Gollan, 2005). Similarly, we may experience difficulty in identifying people we haven’t seen recently or frequently (Yarmey, 1973).

In this chapter, we’ll look at how memory theorists believe long-term memory retrieval works and at how retrieval, like storage, is often a constructive process. Later, we’ll explore

---

<sup>1</sup>Some of my readers, of course—especially those for whom English is a second or third language—may never have stored them in the first place.

several explanations of why we sometimes can't retrieve the things we think we've learned—in other words, why we forget. Finally, we'll make use of our knowledge about retrieval to identify additional implications of memory theory for instructional practice.

## HOW RETRIEVAL WORKS

---

Sometimes certain memories seemingly rise to the surface on their own—that is, we retrieve them without intentionally trying to do so. Often, however, retrieval is a conscious, effortful process: We *want* to retrieve certain information that's relevant to our present circumstances and deliberately “look” for it (Berntsen, 2010; Davachi & Dobbins, 2008). Our ability to control the things we retrieve depends, in part, on brain maturation (especially the prefrontal cortex), and so it improves markedly over the course of infancy and early childhood (Oakes & Bauer, 2007).

Once our brains have matured sufficiently to enable reasonable control, our success at retrieving what we know depends to some extent on how we initially *stored* the desired information—and in particular on whether we stored it in a thoughtful, well-organized manner. Unlike working memory, which is functionally quite small, long-term memory is so large that an exhaustive inspection of it all is probably impossible. Thus a search of long-term memory must be selective, focusing only on certain “sections.” If the sought-after information isn't in one of them, we're out of luck.

To understand the role that organization plays in retrieval, let's look at an analogous situation—your great-grandmother's attic. (I'm going back three generations, because young families typically have homes without much attic space, and many grandparents seem to live in condominiums these days.) Granny probably kept many things in her attic, including furniture, books, old clothes, seldom-used cooking utensils, and holiday decorations. She may have been a very organized woman who stored all books in one place, all clothes in another, and all holiday decorations somewhere else. Alternatively, she may have been more haphazard, throwing things up there any old place, so that some cooking utensils were with books, others were with clothes, and still others were stuffed in an old dresser or on the top shelf of a dilapidated armoire. How Granny stored items in her attic undoubtedly affected her ability to find them later. If she stored things systematically (books with books, cooking utensils with cooking utensils, etc.), she would have been able to locate them easily when she needed them. But if she stored them in a helter-skelter fashion, she may have had to purchase new canning jars every summer because she couldn't track down her jars from any of the previous 13 years.

So it is with long-term memory. Retrieval is easier when related pieces of information are stored in close association with one another, because we then have a good idea about where to find a particular item. To illustrate, try answering this question about a concept I presented in an earlier chapter:

What is a discriminative stimulus?

You may be able to answer the question quickly and easily, or you may have to search your long-term memory for a while. Your ability to retrieve the answer depends partly on how well you've organized the information you acquired from previous chapters. The word *stimulus* should, of course, lead you to look among the many pieces of information you've stored about behaviorist learning theories. The word *discriminative* might suggest to you that you look more specifically in your information about discrimination. If your knowledge about discrimination is stored with what

An organized long-term memory makes things easier to retrieve.

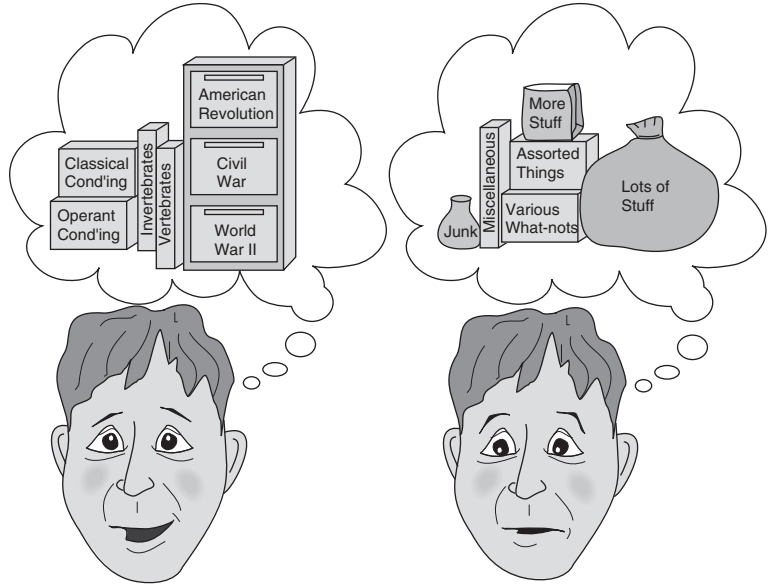

you know about antecedent stimuli (and it should be, because the two concepts are related), then you should find the answer to the question. A discriminative stimulus lets you know that a particular response is likely to be reinforced; it *sets the occasion* for a particular response–reinforcement contingency to be in effect.

You might think of long-term memory retrieval as being similar to looking for something in a large, dark room with only a small flashlight (Lindsay & Norman, 1977). Imagine that the electricity goes off in Granny's house on a dark, moonless night. Because Granny can no longer use either her electric can opener or her electric lights, she takes a flashlight to the attic to find the manual can opener she put there last October. She switches on her flashlight and begins her search. Unfortunately, the flashlight can't illuminate the whole attic at once. Instead, she must aim the light first at one spot, then at another, until eventually she finds the can opener. The necessity to search the attic one spot at a time won't be a problem if Granny knows the opener's exact location (e.g., in a particular drawer that contains many small cooking utensils), but she may search fruitlessly all night if she has no idea where she might have stashed the thing. In much the same way, retrieval from long-term memory may be a process of looking in various small "locations" in memory, just one location at a time. Information that's been stored in a logical place (i.e., associated with similar ideas) will probably be found quickly. Information that's been stored haphazardly, in a rote-learning fashion, will turn up only after a great deal of searching, if it turns up at all.

Retrieval of information is also easier when learners engage in thought processes similar to those they previously used when storing the information—a phenomenon known as **encoding specificity** (Hanna & Remington, 1996; Tulving, 1983; Tulving & Thomson, 1973; Zeelenberg, 2005). For example, Marian and Neisser (2000) interviewed American college students who had immigrated to the United States from Russia or the Soviet Union and thus were fluent in both English and Russian. In two parts of the interview—one conducted in English, the other in Russian—the students were given certain words and asked to tell stories from their personal lives

that the words called to mind. The interview language had a significant influence on the stories recalled: The students recalled more events from their birth country when they were speaking in Russian but more events from their time in the United States when they were speaking in English. Presumably they had, to some degree, *encoded* these personal events in the language they'd been speaking at the time.

Let's return to the activation model of memory described in Chapter 8. According to this model, all information stored in memory is in either an active or inactive state. Information in an active state is what we might think of as being in working memory, whereas inactive information is in long-term memory. The activation model lends itself particularly well to an understanding of how long-term memory retrieval might work. From this perspective, our starting point in long-term memory might be an idea triggered by something in the environment. Retrieval is then a process of **spreading activation**, with the activation flowing through connections within the network of stored information (e.g., J. R. Anderson, 2005; A. M. Collins & Loftus, 1975; see Marcus, 2008, for a similar explanation). Only a small part of the network can be activated at once, thus accounting for the limited-capacity, "flashlight" quality of retrieval. If the activation eventually spreads to that part of the network in which the information is located—something that's more likely to happen if similar ideas are closely associated in the network—we'll retrieve the desired information.

Generally speaking, retrieval is easier for things we know *well*—things we've practiced a lot and use frequently—and particularly for things we've learned to automaticity. It's as if we go to those "places" often enough that we don't even have to think about where to go in order to find them.

In addition, retrieval is usually easier when we're relaxed rather than anxious about retrieving information, especially if we're looking for *nonautomatized* information (Ashcraft, 2002; Beilock, 2008; Zeidner & Matthews, 2005). Anxiety adversely affects retrieval: We don't search long-term memory in an open-minded manner, and so we reduce our chances of finding what we're seeking. As an analogy, think about what happens when you're looking for your car keys and are desperate to find them quickly because you're already late for an important appointment. As you begin to panic, your search strategies become less and less efficient. You look in the same places over and over again; you don't think creatively about the wide variety of places in which the keys might be lurking.

## Retrieval Cues

Retrieval is obviously easier when we have a good idea where to "look" in long-term memory—that is, when we know which part of long-term memory to activate. Accordingly, hints about where to find information—**retrieval cues**—are often helpful. Essentially, retrieval cues are likely to activate the part of long-term memory where a desired piece of information can be found (recall the discussion of *priming* in Chapter 8).

In Chapter 9, you read a story called "The War of the Ghosts." Can you fill in the blank in this sentence from the story?

And the warriors went on up the river to a town on the other side of \_\_\_\_\_.

See if you can remember the name of the town before you continue reading.

Any luck? If not, then perhaps you can recognize the town among these four choices: (1) Bisantri, (2) Dormro, (3) Muckaruck, (4) Kalama. Is it any easier to fill in the blank now?

It should be. Perhaps you've now correctly identified Kalama as the answer. In this question, I gave you a type of retrieval cue known as an **identity cue** (Bourne, Dominowski, Loftus, & Healy, 1986), because it was identical to the information you were trying to retrieve. Recognition tasks (e.g., multiple-choice tests) are often easier than recall tasks (Kelly, Burton, Kato, & Akamatsu, 2001; Semb, Ellis, & Araujo, 1993), presumably because of the identity cues that recognition tasks provide.

Now try this exercise. Read the following list of 24 words *one time only*. I'll ask you to recall them as soon as you've finished.

tulip	pencil	spoon	bed	baker	ruby
hat	mountain	doctor	paper	daisy	shirt
chair	fork	diamond	canyon	knife	table
hill	soldier	rose	pen	shoe	emerald

Now that you've read all 24 words, cover the page and write as many of them as you can remember. *Don't look back at the list just yet.*

If you can't remember all 24, see if these words and phrases help you:

clothing	professions
eating utensils	writing supplies
gemstones	furniture
flowers	land forms

These category names should help you remember more of the words, because all 24 words fall into one of the categories. Such **associate cues** are related to the words you were searching for; as such, they should direct your search toward relevant parts of your long-term memory.

A third kind of retrieval cue is an organizational structure, or **frame**, that systematically guides the search of long-term memory (e.g., Calfee, 1981). For example, in Chapter 9, I described an experiment by Bower and his colleagues (1969) in which presenting words in a logically organized format (e.g., the "minerals" hierarchy in Figure 9.5) facilitated learning and recall. An overall organizational structure provides numerous cues that should focus retrieval efforts (e.g., "Hmmm, now that I've remembered the rare and common metals, I need to remember the alloys"). We find another example of a frame in the sentence

King Philip comes over for good spaghetti.

Biology students often tell me that they use this sentence—in particular, the first letters of the words in the sentence—to remember the categories in the biological classification system: *kingdom*, *phylum*, *class*, *order*, *family*, *genus*, and *species*. By reminding students of the letters that the various category names begin with, the sentence focuses their long-term memory search on terms that begin with those letters. The sentence essentially serves as a *superimposed meaningful structure*, a type of mnemonic I'll describe in Chapter 14.

Sometimes the physical environment in which something has been learned also facilitates retrieval (Godden & Baddeley, 1975; S. M. Smith, Glenberg, & Bjork, 1978). That is, it serves as a **contextual cue**. In an unusual demonstration of this principle, Godden and Baddeley (1975)

had scuba divers learn 36 unrelated words in either of two environments: on shore or 20 feet below the water's surface. They were then asked to remember the words in either the same or a different environment. On a free recall task, the divers were able to recall more words when they were in the same environment in which they'd learned the words than when they were in the other environment. Yet even when the environment itself isn't the specific one in which we originally learned something, exposure to certain characteristics of that environment—perhaps the same smells or the same background music—can help us remember (Balch, Bowman, & Mohler, 1992; Cann & Ross, 1989; Holland, Hendriks, & Aarts, 2005; Schab, 1990).<sup>2</sup>

Retrieval cues are most effective when we've associated them *frequently* with the specific information we're trying to remember (Tulving, 1968, 1975; Tulving & Thomson, 1971; Underwood, 1983). For example, when retrieving the list of 24 words I gave you earlier, once you remembered *table*, you should have had little trouble remembering *chair* as well (or vice versa), because the two words often occur together in everyday conversation.

A downside of retrieval cues is that they may occasionally set boundaries on the areas of long-term memory we search. For instance, in one study (J. Brown, 1968), an experimental group of college students was given a list of 25 U.S. states to read, while a control group had no such list. Both groups were then asked to recall as many of the 50 states as they could. Compared with the control group, the experimental group remembered more of the states they'd previously read but *fewer* of the states they *hadn't* read. Thus, retrieval cues can hinder recall when they direct a learner's search to parts of long-term memory *other* than those that hold desired information.

## CONSTRUCTION IN RETRIEVAL

---

Long-term memory retrieval, like long-term memory storage, may involve constructive processes. People often retrieve only a portion of the information they've previously stored and then fill in the holes based on what's logical or consistent with their existing knowledge and beliefs about themselves or about the world in general. For example, in Chapter 9, I described research by Carmichael, Hogan, and Walters (1932) in which people's reproductions of line drawings reflected how the drawings had been labeled—for instance, as eyeglasses or dumbbells (see Figure 9.6). The participants probably remembered only parts of the drawings and filled in the rest based on what they knew about the concepts to which the labels referred. Another example of constructive retrieval can be found in recalling crimes one has witnessed. Eyewitness testimony isn't necessarily an accurate representation of what actually happened (Brainerd & Reyna, 2005; E. F. Loftus, 1991, 1992). Observers' descriptions of a crime may vary considerably, depending on prior knowledge about the individuals involved, expectations about what typically happens in such a situation, and additional information presented at a later time (I'll say more about the additional-information point shortly).

Even especially vivid memories can be partly reconstructed and thus have the potential to be inaccurate. As an example, think about where you were and what you were doing when, on September 11, 2001, you first heard about the attack on the World Trade Center. You might be able to recall where you were and what you were doing in considerable detail. But how *accurate* is your recollection? Unless you have a video of yourself when you first heard the news, there's no way to be sure.

---

<sup>2</sup>The physical context may even affect the retrieval of classically conditioned responses; see Bouton (1994) for an explanation.

Neisser and Harsch (1992) studied college students' memory for another disaster, the crash of the space shuttle *Challenger* on January 28, 1986. (To refresh your memory, the *Challenger* plummeted into the ocean soon after liftoff, and seven astronauts perished, including Christa McAuliffe, the first teacher to travel into space.) Neisser and Harsch asked the students to describe the circumstances in which they heard the news both the morning after the incident and then 2½ years later. Even after more than 2 years, many students were quite confident about their recollections. Despite their confidence, some of them were way off base. For example, one student gave this account the morning after hearing about the disaster:

I was in my religion class and some people walked in and started talking about [it]. I didn't know any details except that it had exploded and the schoolteacher's students had all been watching which I thought was so sad. Then after class I went to my room and watched the TV program talking about it and I got all the details from that. (Neisser & Harsch, 1992, p. 9)

The same student had this recollection 2½ years later:

When I first heard about the explosion I was sitting in my freshman dorm room with my roommate and we were watching TV. It came on a news flash and we were both totally shocked. I was really upset and I went upstairs to talk to a friend of mine and then I called my parents. (Neisser & Harsch, 1992, p. 9)

Our memories of experiencing or hearing about significant and emotion-laden events are often quite vivid, detailed ones with a seemingly “snapshot” quality to them; hence, psychologists call them **flashbulb memories**. Yet we shouldn't let such vividness lead us astray: Many flashbulb memories are quite accurate, but many others are not (Brewer, 1992; Rubin, 1992; Schmolck, Buffalo, & Squire, 2000; Talarico & Rubin, 2003).

Although constructive processes may be responsible for many errors in what we remember, construction usually facilitates long-term memory retrieval. When our memory of an event is incomplete, we can fill in details based on what makes sense. For example, an American student may not immediately remember which general surrendered at Appomattox at the end of the American Civil War; however, the student might reasonably assume that, because the South lost the war and General Robert E. Lee commanded the Southern troops, it was probably General Lee who surrendered at Appomattox. Similarly, a student trying to remember how to spell the word *ascertain* may surmise that, because the word is related in meaning to the word *certain*, it should be spelled similarly.

## The Power of Suggestion: Effects of Subsequently Presented Information

Sometimes people's recollections are influenced not only by their prior knowledge but also by information presented sometime *after* they learned whatever they're retrieving. Generally speaking, this is a good thing: People should continually update their knowledge and understanding as new information comes in. In some cases, however—for instance, in eyewitness testimony—further information in the form of incorrect statements or misleading questions can be detrimental.

As an illustration of how constructive processes can lead people astray in eyewitness testimony, let's look at an experiment by Loftus and Palmer (1974). Five different groups of adults watched a film depicting a car accident, and then people in each group were asked one of five questions about how fast the car was going. The participants' estimates of the speed varied

significantly, depending on how the question was worded (*italics highlight the variations in wording*):

Question Asked	Estimated Speed (mph)
About how fast were the cars going when they <i>contacted</i> each other?	31.8
About how fast were the cars going when they <i>hit</i> each other?	34.0
About how fast were the cars going when they <i>bumped</i> into each other?	38.1
About how fast were the cars going when they <i>collided</i> into each other?	39.3
About how fast were the cars going when they <i>smashed</i> into each other?	40.8

As you can see, the participants' reconstructions of the accident were influenced to some extent by the severity of the crash implied by the question they were asked.

As another example, let's consider what has become a classic study of eyewitness testimony in young children (Leichtman & Ceci, 1995). A man identified as "Sam Stone" briefly visited a preschool classroom; he commented on the story the teacher was reading to the children, strolled around the perimeter of the room, waved goodbye, and left. Later, an adult asked, "When Sam Stone got that bear dirty, did he do it on purpose or as an accident?" and "Was Sam Stone happy or sad that he got the bear dirty?" (p. 571). When asked these questions, many of the children recalled that Sam soiled a teddy bear, even though he never touched a stuffed animal during his visit. Susceptibility to leading questions was especially common in 3- and 4-year-olds; 5- and 6-year-olds were less likely to be swayed by the suggestive remarks (Leichtman & Ceci, 1995).

The results just described illustrate the **misinformation effect**: People's memory for an event may become distorted when they subsequently receive inaccurate information about the event. Apparently, people integrate the misinformation with their original knowledge of the event in order to reconstruct what "must" have happened (Brainerd & Reyna, 2005; J. C. K. Chan, Thomas, & Bulevich, 2009; E. F. Loftus, 1992; Principe, Kanaya, Ceci, & Singh, 2006; Zaragoza & Mitchell, 1996).

## Constructing Entirely New "Memories"

In some cases, retrieval is almost entirely constructive, in that a person is asked to provide information that's never specifically been stored. For example, consider this arithmetic problem:

$$\frac{1}{2} \times 0 = ?$$

Quite possibly you've never been given the answer to this specific problem, yet you no doubt learned long ago that anything times zero equals zero. Hence you could construct the correct answer:

$$\frac{1}{2} \times 0 = 0$$

Constructive retrieval enables people to produce information beyond what they've specifically stored. Such construction takes time, however. For example, in a study by Stazyk, Ashcraft, and Hamann (1982), students easily retrieved multiplication facts they had practiced many times and so quickly answered such problems as  $2 \times 3$  and  $4 \times 6$ . They were slower to answer "zero" problems such as  $2 \times 0$  and  $0 \times 6$ . Many students probably store only a general rule for zero problems (anything times zero equals zero) and must therefore construct their answer each time such a problem is presented. When fast reaction times are essential—for instance, when a learner



needs numerous basic math facts to solve complex problems—it's probably to the learner's advantage to learn the specific information required rather than a more general rule.

Occasionally new “memories” have little or no basis in fact. In particular, they're **false memories** for things that never happened (Brainerd & Reyna, 2005; E. F. Loftus, 2003, 2004). For example, asking people to picture an imaginary object or event increases the likelihood that, later on, they'll remember actually experiencing it; young children have an especially difficult time distinguishing fact from fantasy (Foley, Harris, & Herman, 1994; Gonsalves et al., 2004; Mazzoni & Memon, 2003; J. Parker, 1995). And when people see photographs of themselves partaking in a certain event—for instance, when an experimenter has electronically imposed their faces on photographs of people taking a hot-air balloon ride—they may later recall actually participating in the event (Garry & Gerrie, 2005).

False memories are common when stimuli might reasonably or logically have been encountered. For example, in word-list learning tasks, people may “remember” seeing words that they never actually saw but that are close associates of words they *did* see, presumably because the unseen words were activated during the learning session (Brainerd & Reyna, 1998; Roediger & McDermott, 2000; Seamon, Luo, & Gallo, 1998; Urbach, Windmann, Payne, & Kutas, 2005). Plausibility also increases false recall of nonexperienced events, especially for older children and adults (D. M. Bernstein & Loftus, 2009; Ghetti & Alexander, 2004; Pezdek, Finger, & Hodge, 1997). For example, in a study by Pezdek and colleagues (1997), high school students were asked whether certain events happened when they were 8 years old. Some of the events actually happened, but the experimenters fabricated two others, one involving a common religious ritual for Catholic children and another involving a common ritual for Jewish children. As you might guess, Catholic students were more likely to “remember” the Catholic event, whereas Jewish students were more apt to “remember” the Jewish one, and their scripts for such events allowed them to “recall” numerous details about what had transpired.

## Remembering Earlier Recollections

In the study of memory about the *Challenger* disaster I described earlier (Neisser & Harsch, 1992), many students were interviewed a third time, 3 years after the disaster itself and thus 6 months after the second recall session. On this third occasion, most students essentially repeated their stories from 6 months before. When participants who inaccurately remembered the occasion were given hints about where they'd actually been and what they'd actually been doing, they stuck with their prior misrecollections; furthermore, they were quite surprised when they were shown their original, morning-after descriptions. It appeared that these students were remembering not what had actually had happened but what they had previously *said* had happened.

Recalling an event we've previously experienced often affects our later memory for the event, especially if we verbally describe it and perhaps embellish on it in some way (Coman, Manier, & Hirst, 2009; E. J. Marsh, 2007; Mazzoni & Kirsch, 2002). Such **narratives** can definitely be constructive in nature. Author Marion Winik has described the process this way:

Sometimes I think childhood memories are fabricated like pearls around a grain of sand. You know how it works: take one old photograph and the quick current of memory it sparks; add what you heard happened, what could have happened, what probably happened; then tell the story over and over until you get the details down. It doesn't take a degree in psychology to reverse-engineer your childhood based on the adult it produced.

Even if I've made it all up, it doesn't matter. I'm stuck with the past I believe in, even if it's wrong. (Winik, 1994, p. 40)

Many children acquire a rudimentary narrative structure before they're 2 years old, and this structure enhances their memory of what they've experienced. As children get older, their narratives become more detailed and complete; for instance, they begin to talk not only about what happened but also about particular people's motives and intentions. Some children construct more elaborate narratives than others—in part because their parents encourage such elaboration—and their memories for events are better as a result (Bauer, 2006; Fivush & Nelson, 2004; Gauvain, 2001; Leichtman, Pillemer, Wang, Koreishi, & Han, 2000; K. Nelson & Fivush, 2004).

### Self-Monitoring during Retrieval

In Chapter 6, I described an aspect of self-regulation known as *self-monitoring*, in which people observe and assess their own behaviors. It appears that people may also engage in self-monitoring of a more cognitive nature when they retrieve information from long-term memory. In particular, they reflect on their recollections in an effort to determine whether they're remembering something accurately or inaccurately (Koriat & Goldsmith, 1996). For instance, people are more likely to believe a recollection is accurate when it's plausible—when it's consistent with what they know about themselves and about the world in general. They're also more likely to have confidence in the accuracy of a memory when it's vivid, detailed, and easy to retrieve—perhaps when it seems to “jump out” at them. And because they know that their memories of long-ago events are typically rather hazy, they'll often agree that nonrecalled events in early childhood—including some that a researcher has made up—probably happened. Consistent with what you'll learn about *metacognition* in Chapter 14, the ability to take such factors into account when self-monitoring the accuracy of memories improves over the course of childhood (Ghetti, 2008; Ghetti & Alexander, 2004; Mazzoni & Kirsch, 2002; Mazzoni, Scoboria, & Harvey, 2010).

One troublesome aspect of retrieval self-monitoring is **source monitoring**—remembering when or where a memory actually came into being (M. Carroll & Perfect, 2002; M. K. Johnson, 2006; D. G. Payne, Neuschatz, Lampinen, & Lynn, 1997; E. J. Robinson & Whitcombe, 2003). For example, memory expert Donald Thomson was once accused of raping a woman at the exact time he was engaged—ironically—in a television interview about memory. The woman described Dr. Thomson in vivid detail and was certain he had been her attacker. In fact, she had watched the interview just before she was raped, and in the process of confusing her sources his face became an integral part of her recollection of the crime (Schacter, 1999; Thomson, 1988).

Faulty source monitoring is sometimes at the root of people's false memories of things they've imagined rather than actually experienced (M. Carroll & Perfect, 2002; Giles, Gopnik, & Heyman, 2002; M. K. Johnson, 2006). It can also lead to unintentional plagiarism of another person's ideas. For instance, in 1976 a U.S. court found former Beatle George Harrison guilty of copyright infringement after noting striking similarities between Harrison's song “My Sweet Lord” and an earlier piece by the Chiffons called “He's So Fine.” Harrison recalled having heard the Chiffons' hit but had no conscious awareness that it might have been the source of his own tune (M. Carroll & Perfect, 2002).

## Important Cautions in Probing People's Memories

Teachers, clinicians, law-enforcement officers, attorneys, and other individuals who rely on people's memories to conduct their work must continually keep in mind the constructive nature of long-term memory retrieval. Sometimes human memory is reasonably accurate. But at other times a person's recollection can be seriously distorted or even completely fabricated. And a person's sense of confidence about a memory isn't always a good indication of how accurate the memory really is. For example, people can be quite confident about having seen people they've never actually laid eyes on (M. K. Johnson, 2006; Perfect, 2002; Wells, Olson, & Charman, 2002).

Occasionally distortions and fabrications in memory are the result of the kinds of questions and feedback that professionals present (Gilstrap & Ceci, 2005; G. S. Goodman & Quas, 2008; Wells et al., 2002; Zaragoza, Payment, Ackil, Drivdahl, & Beck, 2001). Leading questions are to be avoided at all costs, especially when the details of an event are largely unknown. For example, the question "Where were you when So-And-So attacked you?" implies both that an attack occurred and that So-And-So was its perpetrator—implications that don't necessarily reflect the facts. Instead, professionals should ask open-ended questions such as "What did you see?" or "What happened next?" (e.g., R. E. Holliday, 2003). And they should refrain from repeatedly asking the same questions, insisting that people provide speculative answers to questions about which they're unsure, or implying that certain responses are correct or in some other way acceptable (Hirstein, 2005; D. J. Siegel, 1999; Wells et al., 2002).

Although people sometimes "remember" something they've never actually experienced, it's more often the case that they can't retrieve something they *did* experience. We turn our attention now to explanations of why attempts at retrieval aren't always successful.

## FORGETTING

---

In the early decades of cognitive psychology, many theorists thought that once information is stored in long-term memory, it remains there permanently in some form (E. F. Loftus & Loftus, 1980). Some evidence indicates that information may indeed remain in long-term memory for a very long time (H. P. Bahrick, 1984; D. B. Mitchell, 2006; Semb & Ellis, 1994). For instance, in one study (H. P. Bahrick, 1984), individuals remembered a considerable amount of the Spanish they had learned in high school or college as many as 50 years before, even if they hadn't spoken Spanish since that time. Other evidence is found in studies in which people *relearn* information they've previously learned but can no longer recall or recognize: These individuals learn the information more quickly than people who haven't previously studied the same material (C. M. MacLeod, 1988; T. O. Nelson, 1971, 1978).

The observations of neurosurgeon Wilder Penfield (1958, 1969; Penfield & Roberts, 1959) have been cited as evidence for the permanence of long-term memory. Penfield sometimes operated on locally anesthetized but otherwise conscious patients. In doing so, he discovered that stimulating portions of the brain with a weak electric current could evoke vivid sensations. Patients would describe hearing a song, delivering a baby, or going to a circus as if the experience were actually happening to them at that very moment. They acted almost as if they were reliving previous events in their lives.

Unfortunately, Penfield never determined whether the events his patients "remembered" had actually occurred. A more difficult challenge for a permanence-of-memory view is that, although

certainly some information lasts a long time, researchers haven't yet demonstrated—and quite possibly *can't* demonstrate—that *all* information stored in long-term memory remains there for the life of the individual (Eysenck & Keane, 1990; Willingham, 2004).

One thing about long-term memory is certainly clear: Over time, people recall less and less about the events they've experienced and the information they've acquired. Theorists have offered a number of explanations about why we forget much of what we learn. Here we'll look at several possibilities and then consider reasons why our earliest experiences are especially difficult to recall.

## Decay

Increasingly psychologists have come to believe that information can gradually fade away, or **decay**, and eventually disappear from memory altogether. Decay seems to be especially common when information is used rarely or not at all (Altmann & Gray, 2002; Byrnes, 2001; E. F. Loftus & Loftus, 1980; Schacter, 1999).

Some kinds of information are apparently more susceptible to decay than others. In particular, the exact details of an event—verbatim information, if you will—fade more quickly than the underlying meaning, or gist, of the event (Brainerd & Reyna, 1992, 2002, 2005; G. Cohen, 2000). We find an exception to this general rule when certain details are surprising, personally significant, or in some other way quite distinctive (Davachi & Dobbins, 2008; Hunt & Worthen, 2006; Pansky & Koriat, 2004). Meanwhile, less distinctive ones are forgotten or become a general blur. To illustrate, when I think back to my early lessons in U.S. history, I remember the general idea behind the American Revolution: The colonists were fighting for independence from British rule. I also remember certain distinctive details; for example, the Battle of Bunker Hill is commemorated by a monument I visited a couple of times as a child, and the Boston Tea Party was a unique and colorful illustration of the colonists' dissatisfaction with British taxation policies. However, I've forgotten the details of many other events, because, to my young mind, they involved nondistinctive people and places.

Yet just as it may be impossible to determine whether information stays forever in long-term memory, it may be equally impossible to show conclusively that it disappears from memory altogether. For instance, perhaps a person who seemingly loses information simply never “looks” in the right place. It does appear, however, that unused memories weaken and become less accessible over time.

## Interference and Inhibition

In Chapter 7, I described the phenomena of proactive and retroactive inhibition: In both situations, learning one set of verbal material interferes with the ability to recall another set. Verbal learning theorists proposed that such inhibition is a major cause of forgetting verbal information (McGeoch, 1942; Melton & Irwin, 1940; Postman & Underwood, 1973; Underwood, 1948). Some contemporary memory theorists agree, although they often use the term **interference** rather than inhibition (Altmann & Gray, 2002; Dempster & Corkill, 1999; Healey, Campbell, Hasher, & Osher, 2010; Lustig, Konkel, & Jacoby, 2004). In support of this explanation of forgetting, recall of word lists can be as high as 85% when sources of interference are removed from a serial learning task (Underwood, 1957).

An interference view of forgetting might best be described as a theory of confusion: A person has learned numerous responses and gets them mixed up. An experiment by John Anderson (1974) helps us place interference within a contemporary cognitive framework. College students learned a long list of single-proposition sentences, each of which involved a person and a place; here are some examples:

- A hippie is in the park.
- A hippie is in the church.
- A policeman is in the park.
- A sailor is in the park.

The people and places appeared in varying numbers of sentences; some items (e.g., the policeman) appeared in only one sentence, whereas others (e.g., the park) appeared several times. The students studied the sentences until they knew them very well—more specifically, until they could respond to a long list of questions (e.g., “Who is in the park?” “Where are the hippies?”) with 100% accuracy. At that point, they were given a new set of sentences and asked to indicate whether or not these had been in the first set. The more frequently the person and the place had appeared in the first set of sentences, the longer it took the students to determine whether the person and place had appeared *together* in the first set. Anderson (1974, 1983a, 2005) has explained these results as being a function of the numerous associations the students developed to the frequently appearing people and places. For example, the more frequently certain places had been associated with *hippie* in the original set of sentences, the longer students would take to search among their associations with *hippie* to determine whether a new sentence about a hippie had been encountered before. Thus, multiple associations with a concept can slow down retrieval time for information connected with the concept—a phenomenon Anderson calls the **fan effect**.

Now let’s return to the term *inhibition*, this time putting it within a contemporary cognitive framework. Although retrieving one memory usually facilitates retrieval of related memories (again recall the discussion of *priming* in Chapter 8), in some instances related memories are inhibited—a phenomenon called **retrieval-induced forgetting** (Bäuml & Sameniéh, 2010; M. D. MacLeod & Saunders, 2008; Román, Soriano, Gómez-Ariza, & Bajo, 2009; Storm & Angello, 2010). In particular, a learner may intentionally want to recall certain things but *not* to recall certain other, related things and thus learns to inhibit recall of those other things. Let’s take a simple example. Imagine that you think the capital of Turkey is Istanbul. Given that Istanbul is by far Turkey’s largest and best-known city, this is a reasonable conclusion. But in fact, the capital of Turkey is a very different city: Ankara. If for some reason you needed to remember Turkey’s capital correctly, you’d have to retrieve “Ankara” and inhibit your inclination to retrieve “Istanbul.”

## Repression

Earlier in the chapter, I mentioned that emotionally laden news sometimes results in a flashbulb memory—a vivid, detailed recollection of where we were and what we were doing when experiencing or learning about an especially significant event. In some situations, however, we may have an experience that’s so painful or emotionally distressing that we tend either not to remember it at all or else to remember only isolated fragments of it (Arrigo & Pezdek, 1997; Nadel &

Jacobs, 1998; Ray et al., 2006). This phenomenon, often called **repression**,<sup>3</sup> was first described by Sigmund Freud (1915/1957, 1922). To describe repression in contemporary memory terminology, painful information begins to produce anxiety whenever the relevant part of long-term memory is approached. Because anxiety itself is unpleasant, the memory search will tend to steer clear of the anxiety-arousing part of long-term memory. Thus, the painful memory, as well as any other information stored in close association with it, remains out of reach and so is essentially “forgotten” (M. C. Anderson & Levy, 2009; S. M. Smith & Moynan, 2008).

Most victims of traumatic events can consciously recall the events (Berntsen, 2010; G. S. Goodman et al., 2003; S. Porter & Peace, 2007). Yet repression is occasionally observed in clinical settings (Pezdek & Banks, 1996; Schooler, 2001). Over a series of therapy sessions, perhaps with the help of hypnosis (which induces relaxation), a client gradually recalls bits and pieces of a traumatic incident; eventually, the client may remember the entire event. Unfortunately, many presumably repressed “memories” are never checked for accuracy; thus, they may or may not be based on something that actually occurred (Geraerts et al., 2009; E. F. Loftus, 1993; McNally, 2003). For instance, although a hypnotic state may increase people’s confidence and willingness to talk about past events, it doesn’t necessarily improve their memory for what transpired (Brainerd & Reyna, 2005; Dinges et al., 1992; Erdelyi, 2010; Lynn, Lock, Myers, & Payne, 1997).

When true repression occurs—and sometimes it really does—it’s probably a form of inhibition: People either consciously or unconsciously try *not* to recall a highly anxiety-arousing, traumatic event (M. C. Anderson & Green, 2001; M. C. Anderson & Levy, 2009; Ray et al., 2006). However, it appears that most people don’t repress painful information as a matter of course (Bernsten, 2010; G. S. Goodman et al., 2003; S. Porter & Peace, 2007).

## Failure to Retrieve

You can probably think of occasions when you couldn’t remember something at first but then recalled it later on. Obviously the information was still in your long-term memory; you just couldn’t retrieve it the first time around.

Using our flashlight analogy again, we might say that failure to retrieve occurs when people neglect to “look” in the part of long-term memory that holds the desired information. Perhaps the information was initially stored in connection with ideas very different from those one is thinking about at the present time. Or perhaps the information was stored with very few connections to other ideas; as a result, even a broad search of memory doesn’t focus the activation “flashlight” on it (J. R. Anderson, 1995). Given appropriate retrieval cues, however, people may eventually find what they’re looking for.

Some instances of failure to retrieve involve forgetting to do something that needs to be done at a future time—a problem of **prospective memory** (Einstein & McDaniel, 2005; S. A. Stokes, Pierroutsakos, & Einstein, 2007). As an example, when I was considerably younger, I often forgot to turn off my car lights after driving to work on a foggy morning. I occasionally forgot important meetings. Sometimes I forgot to bring crucial handouts or other needed materials to class. Yes, yes, I know what you’re thinking: I was suffering from the absentminded professor syndrome.

It’s not that I would lose information from my long-term memory. When I went to the parking lot at the end of the day and discovered that my car battery was dead, I would readily

<sup>3</sup>Arrigo and Pezdek (1997) prefer the term *psychogenic amnesia*, which describes the nature of the phenomenon without offering the “repression” explanation of why it occurs.

remember that I had turned on my car lights that morning. When I was reminded of an important meeting I'd missed or got to the point in a class session where I needed the handout I'd forgotten to bring, I would think, "Oh, yes, of course!" My problem was that I *forgot to retrieve* important information at the appropriate time. Fortunately, as I've learned more about memory, I've also developed a strategy to overcome my absentmindedness. I'll share it with you near the end of the chapter.

## Construction Error

We've already seen how construction can lead to errors in recall. Construction can occur either at storage (i.e., learner-invented information is stored) or at retrieval (i.e., the learner "remembers" information that was never encountered). Construction at retrieval time is especially likely when the information retrieved has holes in it—holes possibly due to decay, interference, or unsuccessful retrieval. So, as you might expect, erroneous reconstruction of an event or a body of learned information is increasingly likely to occur as time goes on (R. C. Anderson & Pichert, 1978; Bergman & Roediger, 1999; Dooling & Christiaansen, 1977; Lampinen, Copeland, & Neuschatz, 2001; Odegard, Cooper, Lampinen, Reyna, & Brainerd, 2009).

## Failure to Store or Consolidate

A final explanation of "forgetting" is the fact that some information may never have been completely stored in the first place. Perhaps a learner didn't pay attention to the information, so it never entered working memory. Or perhaps the learner didn't process it sufficiently to get it into long-term memory. Even if it *did* get into long-term memory, perhaps some outside factor—a serious accident, for instance—interfered with consolidation processes (see Chapter 9).

In some instances, the brain may be able to store information only in ways that lead to implicit knowledge, which isn't accessible to *conscious* retrieval. This is the case for people with certain kinds of brain injuries (J. R. Anderson, 2005; D. J. Siegel, 1999; Wixted, 2005). And it partly explains why people have little or no recollection of their first few years of life, as we'll see now.

## The Case of Infantile Amnesia

You probably remember very little of your infancy and early childhood. I remember a couple of snippets—for instance, I recall waiting patiently in my crib one morning until my parents woke up, and I recall being held lovingly by my Nana one day in her flower garden—but for all I know, these "memories" never really happened. I certainly don't remember the first birthday party my parents gave me at age 1, even though photographs suggest that it must have been a festive occasion. Generally speaking, people remember little or nothing about specific events in their lives that occurred before age 3—a phenomenon known as **infantile amnesia**.

Children have *some* ability to remember information from a very early age—in fact, even before birth (DeCasper & Spence, 1986; Dirix, Nijhuis, Jongma, & Hornstra, 2009). In one study (DeCasper & Spence, 1986), pregnant women read aloud a passage from a children's book (e.g., Dr. Seuss's *The Cat and the Hat*) twice a day for the final six weeks of their pregnancies. Soon after delivery, their babies were given pacifiers, and the babies' sucking rates (either fast or slow)

controlled whether they heard a recording of their mother reading either the prebirth story or a different one. Even though the infants were only 2 or 3 days old, they began to adjust their sucking rate so that they could hear the familiar story—the one they'd previously heard only while still in the womb!

Young infants clearly remember some of their postbirth experiences as well. For instance, when a ribbon connected to a mobile is tied to a baby's foot, even a 2-month-old easily learns that kicking makes the mobile move and remembers the connection over a period of several days—longer if the child has an occasional reminder (Rovee-Collier, 1999). By 6 months of age, infants can recall and imitate actions they've seen 24 hours earlier, and their memory for observed actions increases in duration in the months that follow (Bauer, 1995, 2006; Collie & Hayne, 1999).

Much of what infants learn and remember appears to be in the form of *implicit knowledge*—knowledge that affects their behavior even though they can't consciously recall it (Nadel, 2005; C. A. Nelson, 1995; Newcombe, Drummey, Fox, Lie, & Ottinger-Albergs, 2000). Theorists have offered at least two plausible explanations for why we consciously recall so little of our early years. First, brain structures that are actively involved in explicit memories, such as the hippocampus and frontal cortex, aren't fully developed at birth, and the frontal cortex in particular continues to mature in significant ways for several years thereafter (Oakes & Bauer, 2007; C. A. Nelson, Thomas, & de Haan, 2006; Newcombe et al., 2000). Second, talking about experiences enhances memory for them (recall our discussions of *verbalization* in Chapter 9 and of *narratives* earlier in this chapter), but infants and toddlers don't have the language skills to talk in detail about events. As they gain linguistic proficiency, and particularly when people around them engage them in conversations about what they're experiencing, their memories improve dramatically. Presumably, talking about events enables them to encode the events in a verbal (language-based) form, making the events more easily retrievable at a later time (Eacott, 1999; Fivush, Haden, & Reese, 2006; R. Richardson & Hayne, 2007; Simcock & Hayne, 2002).

Perhaps all of the explanations I've just presented are partially responsible for the universal human problem of forgetting. Yet forgetting isn't necessarily a bad thing. Many of the things we learn have little use to us later (especially *much* later), and we rarely need to remember things exactly as we originally experienced them. In fact, saving every scrap of information we've ever acquired—you might think of this as *mental hoarding*—would probably make retrieval of things we *do* need extremely difficult (J. R. Anderson & Schooler, 1991; Ratey, 2001; Schacter, 1999). Think once again about Granny's attic: What shape would it be in if she saved every single object she'd ever laid her hands on?

Yet in classroom settings, students sometimes forget things related to important instructional objectives. In the final section of the chapter, we'll pull together what we've learned about retrieval and forgetting, as well as about memory more generally, into several general principles that have implications for instructional practice.

## GENERAL PRINCIPLES OF RETRIEVAL FOR INSTRUCTIONAL SETTINGS

---

In the preceding three chapters, we've identified numerous principles about memory and knowledge that have implications for classroom practice. Following are several additional ones that are especially relevant to retrieval of academic subject matter:



♦ *The internal organization of a body of information facilitates its retrieval.* When material is presented in an organized fashion—for instance, when hierarchical structures, cause-and-effect relationships, and so on are clearly specified—students are more likely to store it in a similar organizational network. And when information in long-term memory is organized, it can more easily be retrieved.

Some of my own students have found the following analogy useful in helping them understand the importance of organization for retrieval:

Imagine 10,000 buttons scattered on a hardwood floor. Randomly choose two buttons and connect them with a thread. Now put this pair down and randomly choose two more buttons, pick them up, and connect them with a thread. As you continue to do this, at first you will almost certainly pick up buttons that you have not picked up before. After a while, however, you are more likely to pick at random a pair of buttons and find that you have already chosen one of the pair. So when you tie a thread between the two newly chosen buttons, you will find three buttons tied together. In short, as you continue to choose random pairs of buttons to connect with a thread, after a while the buttons start becoming interconnected into larger clusters. . . . (Kauffman, 1995, p. 56)

Eventually you'll form a single giant cluster of buttons. At this point, you can pick up almost any button in the pile and have most of the others follow. Now think of the buttons as being individual pieces of information related to a particular topic, and think of the threads as being your associations among those pieces. Eventually you make enough associations that when you retrieve one idea about the topic, you can also retrieve, either directly or indirectly, most of the other things you know about it.<sup>4</sup>

♦ *How something is retrieved at one time affects how it will be retrieved later on.* As we've seen, retrieval can be quite constructive. We've seen, too, that people tend to remember things in the same way time after time. If they remember something incorrectly once, they're likely to remember it in the same incorrect way on a future occasion.

When students don't know how best to interconnect the ideas they're studying, they may pull the ideas together in a way that seems logical but isn't necessarily accurate (recall the discussion of *theory theory* in Chapter 10). As an illustration, when a researcher asked fourth graders from Michigan why the Americas were once called the New World, a girl named Rita had this to say:

Because they used to live in England, the British, and they didn't know about . . . they wanted to get to China 'cause China had some things they wanted. They had some cups or whatever—no, they had furs. They had fur and stuff like that and they wanted to have a shorter way to get to China so they took it and they landed in Michigan, but it wasn't called Michigan. I think it was the British that landed in Michigan and they were there first and so they tried to claim that land, but it didn't work out for some reason so they took some furs and brought them back to Britain and they sold them, but they mostly wanted it for the furs. So then the English landed there and they claimed the land and they wanted to make it a state, and so they got it signed by the government or whoever, the big boss, then they were just starting to make it a state so the British just went up to the Upper Peninsula and they thought they could stay there for a little while. Then they had to fight a war, then the farmers, they were just volunteers, so the farmers went right back and tried to get their family put together back again. (VanSledright & Brophy, 1992, p. 849)

Rita has taken bits and pieces of information she's learned in school and pulled them into a scenario that makes sense to her. In the process, she's made some creative connections indeed. For

---

<sup>4</sup>I'm indebted to a former student, Jason Cole, for this analogy.

instance, she associates China with both cups (and after all, many cups *are* made of china) and furs (which early traders actually obtained in western North America). Notice, too, how Rita maintains that the British found a shorter way to get to China—one that apparently went through Michigan. At the same time, Rita *doesn't* make at least one essential connection that would help her understand early American history—the fact that the “British” and the “English” were the same people.

Although Rita's description of American history has a few elements of truth, these elements have been combined to form an overall “knowledge” of history that could give any historian heart failure. If teachers want students to connect and remember classroom subject matter in a particular way, then, they should make the appropriate connections clear *right from the start*.

◆ *Information that must be retrieved within a particular context should ideally be stored within that context.* People are most likely to retrieve information relevant to a situation when they've stored that information in close association with other aspects of the situation. Accordingly, teachers should give students numerous opportunities to relate classroom material to the various situations that are later likely to require its retrieval. For example, a student is more likely to retrieve mathematical ideas relevant to accounting, surveying, or engineering if the math teacher incorporates problems involving accounting, surveying, and engineering into instruction. Similarly, a student studying for a psychology test that stresses application will be better prepared if he or she uses study time to consider numerous situations in which psychological principles can be applied. Furthermore, students should have opportunities to use the things they learn in real-world contexts; we'll consider such *authentic activities* in Chapters 13 and 15.

◆ *External retrieval cues minimize failure to retrieve.* Earlier I mentioned the problem of *prospective memory*—forgetting to do something you need to do. The best way to address this problem, I've found, is to create an **external retrieval cue**—a physical reminder outside of (external to) the memory system. The classic example is a string around the finger: The string is tied in a spot impossible to overlook and serves as a reminder that something needs to be remembered.<sup>5</sup>

Finger strings are terribly unfashionable, but other external retrieval cues can be equally effective. Over the years I've developed several that have made me one of the *least* absentminded people on the planet. I keep a weekly calendar open by the telephone on my desk, and I write in it not only the meetings and appointments I need to go to but also the things I do regularly every week—playing racquetball Monday evenings, going to yoga class on Friday afternoons, and so on. I write notes to myself about things I need to do on a particular day or accomplish by the end of the week, and I put them in plain sight on my desk. And if I need to be sure to bring something with me when I go somewhere, I put it on the floor between my desk and my office door, so that I'll definitely see it as I leave. Essentially, what I'm doing is guaranteeing retrieval of the things I need to remember.

As we'll discover in Chapter 14, children and adolescents are typically quite naive about how their memories work (and don't work), and teachers are in an excellent position to help them learn to use their memories most effectively. Teachers can, of course, provide occasional verbal reminders (e.g., “Don't forget to bring your permission slips back tomorrow!”). But ultimately,

---

<sup>5</sup>An *external retrieval cue* should remind you of the concept *cueing* (or prompting) described in Chapter 4. Behaviorists think of cues as evoking desired responses, whereas cognitivists think of them as facilitating retrieval. The effect is the same—a desired behavior is more likely to occur—but the explanation for the effect is different.

students should also be shown how to develop their *own* retrieval cues—paper or electronic calendars, to-do lists, self-reminder sticky notes, and so on—so that they can eventually become responsible for their own retrieval.

◆ *Questions about previously learned material can promote both review and further elaboration.* In our discussion of instructional objectives in Chapter 5, we made a distinction between lower-level skills and higher-level skills. This was essentially a distinction between simply *knowing* something versus *doing* something (mentally) with that knowledge—for instance, applying, analyzing, synthesizing, or evaluating it. We can make a similar distinction between **lower-level questions** and **higher-level questions**: The former ask students to retrieve something pretty much as they've stored it in memory, whereas the latter ask students to elaborate on the retrieved information.

Teacher questioning is a widely used teaching technique, probably because it has several potential benefits. We've noted two possible benefits in earlier chapters: Questions help focus students' attention on classroom activities (see Chapter 8) and can alert teachers to students' misconceptions about a topic (see Chapter 10). Questions also provide a feedback mechanism through which teachers and students alike can discover how much students have learned from a current lesson or can remember from previous lessons. When questions focus students' attention on previously studied material, they encourage review of the material that should promote greater recall later on (S. K. Carpenter, Pashler, & Cepeda, 2009; McDaniel, Anderson, Derbish, & Morrisette, 2007; Wixson, 1984). And higher-level questions have the additional advantage of encouraging students to go beyond the information itself and construct more sophisticated understandings (Aulls, 1998; Brophy, Alleman, & Knighton, 2009; Mayer, 2010a; Minstrell & Stimpson, 1996). Here's an example of something a middle school science teacher in Colorado might ask (note that the altitude of Rocky Mountain National Park ranges from 1½ to more than 2 miles above sea level):

A group of Girl Scouts went hiking in Rocky Mountain National Park. They noticed that it was harder to breathe when hiking in the mountains than when hiking in [hometown]. During the hike, one girl opened a tube of suntan lotion that she bought in [hometown]. When she opened it, a small squirt of air and lotion shot out.

- Why did the girls have a hard time breathing?
- Why did the air and lotion squirt out of the tube? (Pugh, Schmidt, & Russell, 2010, p. 9)

◆ *Taxonomies of objectives can be useful reminders of the various ways in which students might be asked to think about and apply what they've learned.* In our discussion of instructional objectives in Chapter 5, we looked at Bloom's early Taxonomy of Educational Objectives, which suggests six, increasingly complex levels of behavior that teachers might encourage and assess (B. S. Bloom, Englehart, Furst, Hill, & Krathwohl, 1956). More recently, a collaborative group of educational psychologists (L. W. Anderson et al., 2001) revised the taxonomy, in part to reflect theoretical advances in learning and cognition. The revision is a two-dimensional taxonomy that includes six *cognitive processes*, each of which is potentially relevant to four different *types of knowledge* (see Figure 11.1). The six cognitive processes are similar to the six levels in Bloom's original taxonomy (see Figure 5.5 on page 104). However, the cognitive processes are described by verbs rather than nouns, and the last two, *evaluate* and *create*, reflect a reversal of Bloom's *synthesis* and *evaluation* levels. The four types of knowledge include two forms of declarative knowledge, *factual knowledge* and *conceptual knowledge*, as well as *procedural knowledge* and *metacognitive knowledge* (we'll look at the nature of the last one more closely in Chapter 14).

The revised taxonomy includes six *cognitive processes*, each of which is potentially relevant to four different *types of knowledge*.

### Cognitive Processes

1. **Remember:** recognizing or recalling information learned at an earlier time and stored in long-term memory
2. **Understand:** constructing meaning from instructional materials and messages (e.g., drawing inferences, identifying new examples, summarizing)
3. **Apply:** using knowledge in a familiar or new situation
4. **Analyze:** breaking information into its constituent parts, and perhaps identifying interrelationships among those parts
5. **Evaluate:** making judgments about information using certain criteria or standards
6. **Create:** putting knowledge and/or procedures together to form a coherent, structured, and possibly original whole

### Types of Knowledge

- A. **Factual knowledge:** knowing specific pieces of information (e.g., facts, terminology)
- B. **Conceptual knowledge:** knowing more general structures and interrelationships among pieces of information (e.g., general principles, schemas, models, theories)
- C. **Procedural knowledge:** knowing how to do something (e.g., using step-by-step algorithms, employing scientific research methods), and possibly applying certain criteria in choosing the procedure to use
- D. **Metacognitive knowledge:** knowing about the nature of thinking and about effective learning strategies, and being aware of one's own cognitive processes

**Figure 11.1**

A two-dimensional revision of Bloom's Taxonomy (L. W. Anderson et al., 2001)

The two dimensions of the revised taxonomy are intended to represent two continuums that progress from very simple cognitive processes and types of knowledge to more complex ones. The continuums aren't hard and fast, however; for example, some forms of conceptual knowledge can be fairly complex and abstract, whereas some forms of procedural knowledge are quite simple and concrete (L. W. Anderson et al., 2001; Marzano & Kendall, 2007). Rather than nit-pick about the extent to which certain cognitive processes or types of knowledge are truly more complex than others, a more useful perspective of the revised taxonomy is to regard it as a helpful reminder of the various kinds of knowledge that students might have and the various ways in which they might use and apply it in new tasks and situations.<sup>6</sup>

◆ *Retrieval can take time.* Sometimes retrieval happens quickly and easily, especially for material that has been used repeatedly and possibly been learned to automaticity. But in other instances, searching long-term memory for information relevant to a particular question or task can take a considerable amount of time. Learners need even more time if they must pull together what they can remember to draw new inferences, make new comparisons, generate new applications, and so on.

In the classroom, then, it's unreasonable to expect students to formulate insightful, creative responses to higher-level questions in a split second. Yet when teachers ask students a question,

<sup>6</sup>Another useful taxonomy is Marzano and Kendall's (2007) New Taxonomy, which also includes attitudes and emotions and distinguishes among various *levels of processing*. It's detailed enough that I can't really do it justice in a book such as this one.

they typically wait for only a very short time—often a second or less—and if students don't respond in that short interval, teachers tend to speak again, perhaps by asking different students the same question, rephrasing the question, or answering the question themselves (Jegede & Olajide, 1995; Rowe, 1974, 1987). Teachers are equally reluctant to let much time elapse after students answer questions or make comments in class; on average, they allow one second or less of silence before responding to a statement or asking another question (Jegede & Olajide, 1995; Rowe, 1987).

The amount of time teachers allow to pass after their own and students' questions and comments is known as **wait time**. Research indicates that students benefit tremendously simply from being given a little time to think. When teachers instead allow at least *three seconds* of wait time, more students—especially more females and minority-group members—participate in class, and students begin to respond to one another's comments and questions. In addition, students are more likely to support their reasoning with evidence or logic and more likely to speculate when they don't know an answer. Furthermore, they're more motivated to learn classroom subject matter, thereby increasing actual learning and decreasing behavior problems. Such changes are due, in part, to the fact that with increased wait time, *teachers'* behaviors change as well. Teachers ask fewer lower-level questions (e.g., those requiring recall of facts) and more higher-level ones (e.g., those requiring elaboration). They also modify the direction of discussion to accommodate students' comments and questions, and they allow their classes to pursue a topic in greater depth than they had originally anticipated. Moreover, their expectations for many students, especially low-achieving ones, begin to improve (Castagno & Brayboy, 2008; Giaconia, 1988; Mohatt & Erickson, 1981; Moon, 2008; Rowe, 1974, 1987; Tharp, 1989; Tobin, 1987).<sup>7</sup>

When the objective is recall of facts—when students need to retrieve information very quickly, to “know it cold”—then wait time during a question–answer session should be short. There's a definite advantage to rapid-fire drill and practice for skills that teachers want students to learn to a level of automaticity (Tobin, 1987). But when objectives include more complex processing of ideas and issues, longer wait time provides both teachers and students the time they need to retrieve relevant ideas and think them through.

♦ *Classroom assessments significantly affect both storage and retrieval.* In my college classes I give regular quizzes—usually every 2 or 3 weeks in undergraduate classes and at least once a month in masters' level classes. I also give frequent out-of-class assignments in which students must apply what they're learning to their personal and professional lives. My assessments encourage review, of course, but they also encourage students to reflect on classroom material in new ways. Even my multiple-choice questions require students to elaborate on what they've learned, often by asking them to recognize new examples of concepts or to evaluate various classroom strategies using principles of effective learning and memory.

My assessment practices don't just affect what students do at retrieval time, however. They also affect how students study classroom subject matter to begin with; in other words, they affect students' storage processes. Because my students know from Day 1 that I'm going to assess their *understanding* and *application* of what they learn in my class, most of them focus on meaningful learning and elaboration when they listen, speak, read, and study. A few of them, alas, do what they've always done in other classes—they rote-memorize—and these students typically struggle

---

<sup>7</sup>Note, however, that waiting *too* long can be detrimental because students' attention begins to drift elsewhere, so that important information is no longer in working memory (Duell, 1994).

on my quizzes and assignments until they either seek my assistance or else stumble on more effective approaches themselves.

Research tells us that classroom assessments, *when designed appropriately*, can enhance students' learning and memory in several ways:

- *By promoting effective storage processes.* Students tend to read and study differently depending on how they expect their learning to be assessed (J. R. Frederiksen & Collins, 1989; N. Frederiksen, 1984b; Lundeberg & Fox, 1991; L. Shepard, Hammerness, Darling-Hammond, & Rust, 2005). For example, students are likely to focus on memorizing isolated facts at a rote level if they believe a test will require verbatim recall. They're more likely to try to make sense of what they're studying—that is, to engage in meaningful learning—when they know they'll have to put things in their own words. And they're more likely to elaborate on class material if elaboration will be required at assessment time—for instance, if they know they'll have to apply, analyze, or synthesize what they've learned.
- *By encouraging review before the assessment.* As we discovered in Chapter 9, students have a better chance of remembering things over the long run if they periodically review those things. Preparing for assessments is one way of reviewing classroom material. For instance, most students study class material more and learn it better when they're told they'll be tested on it than when they're simply told to learn it (N. Frederiksen, 1984b; Halpin & Halpin, 1982). We should note, however, that students typically spend more time studying the information they think will be on a assessment than the things they think an assessment won't cover (Corbett & Wilson, 1988; J. R. Frederiksen & Collins, 1989; N. Frederiksen, 1984b).
- *By requiring review during the assessment itself.* Taking a test or completing an assignment is, in and of itself, an occasion for retrieving and reviewing learned information. Generally speaking, the very process of completing an assessment on classroom material helps students learn the material better (Dempster, 1991; Karpicke & Roediger, 2008; Pashler, Rohrer, Cepeda, & Carpenter, 2007; Roediger & Karpicke, 2006; Rohrer & Pashler, 2010). But once again, the nature of the assessment probably makes a difference here. For instance, tasks that require students to write about what they've learned (e.g., short-answer questions) lead to better recall than tasks that require only recognition of facts (e.g., multiple-choice questions) (A. C. Butler & Roediger, 2007; S. H. K. Kang, McDermott, & Roediger, 2007). And tasks that require students to go beyond the material itself (e.g., to draw inferences) are more likely to be effective than those that ask only for recall of previously learned facts (Foss & Fisher, 1988).
- *By providing feedback.* Assessments provide a concrete mechanism for letting students know what things they've learned correctly and what things they've learned either incorrectly or not at all. For example, when students get constructive comments on their essays—comments that point out the strengths and weaknesses of each response, indicate where answers are ambiguous or imprecise, suggest how an essay might be more complete or better organized, and so on—their understanding of class material and their writing skills are both likely to improve (J. B. Baron, 1987; Hattie & Timperley, 2007; Krampen, 1987; Shute, 2008).

When we look at typical classroom tests, we're apt to see test items that focus largely on lower-level skills—such as knowledge of simple facts—perhaps because such items are the easiest ones

to write (J. R. Frederiksen & Collins, 1989; Newstead, 2004; Nickerson, 1989; Poole, 1994; Silver & Kenney, 1995). If teachers want students to do *more* than memorize facts, they must develop assessments that encourage students to process information in certain ways—perhaps to rephrase ideas in their own words, generate their own examples of concepts, relate principles and procedures to real-world situations, use class material to solve problems, or examine ideas with a critical eye. Sometimes, of course, well-constructed test items can encourage such processes. In many cases, however, teachers may want to use other kinds of assessment tasks—perhaps writing stories, collecting and synthesizing data, comparing contradictory historical accounts, critiquing government policies, creating portfolios—that more readily allow students to apply classroom subject matter to new problems and situations, including those in their own lives (DiMartino & Castaneda, 2007; R. L. Johnson, Penny, & Gordon, 2009; R. S. Johnson, Mims-Cox, & Doyle-Nichols, 2006; L. Shepard et al., 2005).

♦ *Long-term memory can probably never be a totally reliable record of information.* Long-term memory storage and retrieval are both constructive processes that will always be fallible. Students' memories can never be complete, verbatim repositories of what they've studied at school or elsewhere. At the same time, students can certainly learn how to capitalize on the strengths of the human memory system and how to compensate for its weaknesses—a point we'll explore in depth in our discussion of metacognition in Chapter 14.

---

## SUMMARY

Retrieval from long-term memory appears to be a process of searching its contents, in one “location” at a time, until the desired information is found. Retrieval is easier when information has previously been stored in connection with many other ideas in memory, when it's been learned to automaticity, or when relevant *retrieval cues* are present. Presumably interconnections among ideas, automaticity, and appropriate retrieval cues increase the probability that looked-for information will be activated.

Retrieval is often a constructive process: Some pieces of information are directly retrieved and other, nonretrieved details are filled in to create a logical, coherent (albeit sometimes incorrect) recollection. Recall of information and events can also be affected by information or misinformation (e.g., misleading questions) presented at a later time. People sometimes “remember” things they've never specifically learned, perhaps because they draw reasonable inferences from what they *have* learned or perhaps because related ideas in their long-term memories were activated during a learning experience.

Describing a previous event in a particular way increases the likelihood that the learner will remember it in the same way on future occasions; in a sense, people remember their previous *recollections* of an event as much as (or even more than) they remember the event itself. As children get older, they increasingly reflect on the things they retrieve from long-term memory, and they begin to evaluate the quality of their recollections based on such factors as vividness and plausibility.

Theorists have offered a variety of explanations for why people “forget” things they've presumably learned, including *decay*, *interference*, *inhibition*, *repression*, *failure to retrieve*, *construction error*, and *failure to completely store or consolidate* information. *Infantile amnesia*—remembering little or nothing about what happens during the first few years of life—may be a manifestation of the last of these explanations. Forgetting isn't necessarily a bad thing: We typically have little use for the trivial details of everyday life, and we rarely need to remember important information word for word.

Numerous instructional practices facilitate students' ability to retrieve the things they've learned. If students learn a new body of information in an organized manner—and if they also associate the information with contexts in which it's apt to be useful—they're more likely to retrieve ideas when the ideas are potentially applicable or helpful. Yet retrieval is never guaranteed, and so *external retrieval*

*cues* (e.g., “notes to self”) can ensure that important things are remembered. Teacher questions and assessment practices can encourage retrieval and review. Lower-level questions and tasks can promote review and automaticity, but higher-level ones—those that ask students to infer, apply, justify, problem solve, and so on—can also encourage further elaboration.



# COGNITIVE-DEVELOPMENTAL PERSPECTIVES

*Piaget's Theory of Cognitive Development*

*Key Ideas in Piaget's Theory*

*Piaget's Stages of Cognitive Development*

*Current Perspectives on Piaget's Theory*

*Capabilities of Different Age-Groups*

*Effects of Experience and Prior Knowledge*

*Effects of Culture*

*Views on Piaget's Stages*

*Neo-Piagetian Theories of Cognitive Development*

*Case's Theory*

*Implications of Piagetian and Neo-Piagetian Theories*

*Summary*

In Chapter 7, I described three general approaches that cognitive theorists have taken in conceptualizing learning: information processing theory, constructivism, and contextual theories. Our discussion of memory in the last four chapters has drawn primarily from information processing theory, albeit sometimes with a constructivist bent. Information processing theory had some roots in verbal learning research, which, in turn, was influenced by the S–R views of early behaviorists. Yet at the same time that behaviorists were dominating learning research in the early decades of the twentieth century, other researchers examining a somewhat different topic—child development—were coming to very different conclusions about what learning entails. One of these researchers, Swiss developmentalist Jean Piaget, proposed that through interacting with and reflecting on their physical and social worlds, children self-construct increasingly complex understandings and reasoning abilities with age. In making such a proposal, Piaget was a pioneer in *individual constructivism*. Meanwhile, Russian psychologist Lev Vygotsky focused on the importance of society and culture for children's development, laying the groundwork for a contextual view known as *sociocultural theory*.

In this chapter and the next one, we'll look at Piaget's and Vygotsky's theories of learning and cognitive development, as well as at contemporary perspectives that their work has inspired. Our focus in this chapter will be on the views of Piaget and of researchers who have followed in his footsteps. These theories—collectively known as **cognitive-developmental theories**—focus on how thinking processes change, qualitatively, with age and experience. In such perspectives, children typically play an active role in their own development: They seek out new and interesting experiences, try to make sense of what they see and hear, and work actively to reconcile discrepancies between new information and what they've previously believed to be true. In the process of doing these things, children's thinking gradually becomes more abstract and systematic.

## PIAGET'S THEORY OF COGNITIVE DEVELOPMENT

---

In the 1920s, Jean Piaget began a six-decade research program in Switzerland that has had a tremendous influence on contemporary theories of learning and cognitive development. Trained as a biologist, Piaget also had interests in philosophy and was especially curious about the origins of knowledge, a branch of philosophy known as *epistemology*. To discover where knowledge comes from and the forms that it takes as it develops, Piaget and his colleagues undertook a series of studies that offer many unique insights into how children think and learn about the

world around them (e.g., Inhelder & Piaget, 1958; Piaget, 1928, 1952b, 1959, 1970, 1971, 1972, 1980; Piaget & Inhelder, 1969).

Although Piaget's theory dates from the 1920s, its impact on psychological thought in the western hemisphere wasn't widely felt until the 1960s, probably for several reasons. One likely reason is that Piaget, being Swiss, wrote in French, making his early work less accessible to English-speaking psychologists. Although his writings were eventually translated into English, his ideas initially gained widespread prominence and visibility largely through a summary of his early work written by the American psychologist John Flavell (1963).

A second reason that Piaget's research program had only minimal influence at first was his unconventional research methodology. Piaget used what he called the **clinical method**: He gave children a variety of tasks and problems, asking a series of questions about each one. He tailored his interviews to the particular responses children gave, with follow-up questions varying from one child to the next. Such a procedure was radically different from the standardized, tightly controlled conditions typical of behaviorist animal research and was thus unacceptable to many of Piaget's contemporaries in North America.

But perhaps the most critical reason that Piaget's theory didn't immediately become part of the mainstream of psychological thought was its philosophical incompatibility with the behaviorist perspective that dominated the study of learning until the 1960s. Piaget focused on mental events—for example, on logical reasoning processes and the structure of knowledge—at a time when such mentalism was still being rejected by many learning theorists. The cognitivism that began to emerge in the 1960s was more receptive to Piagetian ideas.

Piaget's work is probably so popular today because it's such a global theory of intellectual development, incorporating such diverse topics as language, logical reasoning, moral judgments, and conceptions of time, space, and number. In addition, Piaget's unique studies with children—often involving cleverly designed problem situations—reveal a great deal about the nature of children's thought.

## Key Ideas in Piaget's Theory

Central to Piaget's theory are the following principles and concepts:

- ◆ *Children are active and motivated learners.* Piaget proposed that children are naturally curious about their world and actively seek out information to help them make sense of it (e.g., Piaget, 1952b). Rather than simply responding to the stimuli they encounter, children manipulate those stimuli and observe the effects of their actions. For example, consider Piaget's observation of his son Laurent at 16 months of age:

Laurent is seated before a table and I place a bread crust in front of him, out of reach. Also, to the right of the child I place a stick about 25 cm. long. At first Laurent tries to grasp the bread without paying attention to the instrument, and then he gives up. I then put the stick between him and the bread. . . . Laurent again looks at the bread, without moving, looks very briefly at the stick, then suddenly grasps it and directs it toward the bread. But he grasped it toward the middle and not at one of its ends so that it is too short to attain the objective. Laurent then puts it down and resumes stretching out his hand toward the bread. Then, without spending much time on this movement, he takes up the stick again, this time at one of its ends . . . and draws the bread to him.

An hour later I place a toy in front of Laurent (out of his reach) and a new stick next to him. He does not even try to catch the objective with his hand; he immediately grasps the stick and draws the toy to him. (Piaget, 1952b, p. 335)

In this situation, Laurent is obviously experimenting with aspects of his environment to see what outcomes he can achieve. In Piaget's view, much of children's cognitive development is the result of such efforts to make sense of the world.

◆ *Children organize what they learn from their experiences.* Children don't just amass the things they learn into a collection of isolated facts. Instead they pull their experiences together into an integrated view of how the world operates. For example, by observing that food, toys, and other objects always fall down (never up) when released, children begin to construct a basic understanding of gravity. As they interact with family pets, visit zoos, look at picture books, and so on, they develop an increasingly complex understanding of animals. Piaget depicted learning as a very *constructive* process: Children create (rather than simply absorb) their knowledge about the world.

In Piaget's terminology, the things that children learn and can do are organized as **schemes**, groups of similar actions or thoughts that are used repeatedly in response to the environment.<sup>1</sup> Initially, children's schemes are largely behavioral in nature, but over time they become increasingly mental and, eventually, abstract. For example, an infant might have a scheme for grasping and apply this scheme in grabbing everything from bottles to rubber ducks. A teenager may have certain schemes related to logical thinking that might be applied to reasoning about a variety of social, political, or moral issues.

Piaget proposed that children use newly acquired schemes over and over in both familiar and novel situations. As children develop, new schemes emerge, and existing schemes are repeatedly practiced, occasionally modified, and sometimes integrated with one another into **cognitive structures**. A good deal of Piaget's theory focused on the development of the cognitive structures that govern logical reasoning—structures that Piaget called **operations**.

◆ *Interaction with the physical environment is critical for learning and cognitive development.* In the process of interacting with their environment, growing children develop and modify their schemes. For example, in the earlier anecdote involving Piaget's son Laurent, we see a toddler actively manipulating parts of his physical environment—more specifically, manipulating the stick and bread—and presumably learning that some objects can be used as tools to obtain other objects. By exploring and manipulating the world around them—by conducting many little experiments with objects and substances—children learn the nature of such physical characteristics as volume and weight, discover principles related to force and gravity, acquire a better understanding of cause-and-effect relationships, and so on. In Piaget's view, then, children act as young scientists, although without the benefit of sophisticated scientific reasoning processes that adult scientists use (more on this point later).

◆ *Interaction with other people is equally critical for learning and development.* Although Piaget believed that children's knowledge and understandings of the world are largely self-constructed, nevertheless they have much to learn from interacting with others. For example, as you'll discover shortly, preschoolers often have difficulty seeing the world from anyone's perspective but their own. Through social interactions, both positive (e.g., conversations) and negative (e.g., conflicts over such issues as sharing and fair play), young children gradually come to realize that

---

<sup>1</sup>Don't confuse Piaget's schemes with the schemas described in Chapter 9, although both concepts reflect ways of organizing things that are learned. In fact, Piaget himself made a distinction between a *scheme* and a *schema* (plural for the latter is *schemata*), and he used *schema* in a different sense than contemporary cognitivists do (e.g., see Piaget, 1970, p. 705).

different people see things differently and that their own view of the world isn't necessarily a completely accurate or logical one. Elementary school children may begin to recognize logical inconsistencies in what they say and do when someone else points out the inconsistencies. And through discussions with peers or adults about social and political issues, high school students may slowly modify their newly emerging idealism about how their fellow human beings should behave.

♦ *Children adapt to their environment through the processes of assimilation and accommodation.* According to Piaget, children interact with their environment through two unchanging processes (he called them *functions*) known as assimilation and accommodation. **Assimilation** entails responding to and possibly interpreting an object or event in a way that's consistent with an existing scheme. For example, an infant who sees Mama's flashy, dangling earrings may assimilate the earrings to his grasping scheme, clutching and pulling at them in much the same way that he grasps bottles. A second grader who has developed a scheme for adding two apples and three apples to make five apples may apply this scheme to a situation involving the addition of two dollars and three dollars.

Yet sometimes children can't easily respond to a new object or event using existing schemes. In such situations, one of two forms of **accommodation** will occur: Children will either (1) modify an existing scheme to account for the new object or event or else (2) form an entirely new scheme to deal with it. For example, an infant who has learned to crawl must adjust her crawling style when she meets a flight of stairs. And a child who encounters a long, snakelike creature with four legs may, after some research, reject the *snake* scheme—because snakes don't have legs—in favor of a new scheme: *skink*.

Assimilation and accommodation are complementary processes: Assimilation involves modifying one's perception of the environment to fit a scheme, and accommodation involves modifying a scheme to fit the environment. In Piaget's view, the two processes typically go hand in hand, with children responding to new events within the context of their existing knowledge (assimilation) but also modifying their knowledge as a result of those events (accommodation).

As you might guess, *learning* is largely the result of accommodation—that is, of modifying existing schemes or forming new ones. Yet assimilation is almost always a necessary condition for accommodation to occur: You must be able to relate a new experience to what you already know before you can learn from it. As you discovered in Chapter 8, this necessity for overlap between prior knowledge and new information is an important principle not only in Piaget's theory but in contemporary cognitive learning theories as well.

♦ *The process of equilibration promotes progression toward increasingly complex forms of thought.* Piaget suggested that children are sometimes in a state of **equilibrium**: They can comfortably interpret and respond to new events using existing schemes. But this equilibrium doesn't continue indefinitely. As children grow older, they frequently encounter situations for which their current knowledge and skills are inadequate. Such situations create **disequilibrium**, a sort of mental discomfort that spurs them to try to make sense of what they observe. Sometimes the easiest thing to do is simply ignore the perplexing state of affairs. But on other occasions—especially when the same puzzling phenomenon occurs time after time—children may be motivated to revamp their current schemes. By replacing, reorganizing, or better integrating their schemes—in other words, through accommodation—children eventually can better understand and address previously mystifying events. The process of moving from equilibrium to disequilibrium and back to equilibrium again is known as **equilibration**. In Piaget's

view, equilibration and children's intrinsic desire to achieve equilibrium promote the development of more complex levels of thought and knowledge.

♦ *Children think in qualitatively different ways at different age levels.* A major feature of Piaget's theory is his description of four distinct stages of cognitive development, each with its own unique patterns of thought. Each stage builds on the accomplishments of any preceding stages, and thus children progress through the four stages in the same, invariant sequence. In his early writings, Piaget suggested that the stages are *universal*—that they describe the cognitive development of children throughout the world.

Piaget speculated that children's progression through the four stages is limited by neurological maturation—that is, by genetically controlled developmental changes in the brain. In other words, a child is capable of moving from one stage to the next only when the brain matures sufficiently to enable the cognitive structures and thought processes associated with the next stage. As we discovered in Chapter 2, the brain continues to develop throughout childhood, adolescence, and early adulthood. Quite possibly, this continuing neurological development, and especially the development of the frontal cortex, may allow growing human beings to think in increasingly sophisticated ways. Although some researchers have found evidence that significant neurological changes do occur at the typical transition ages for progression from one of Piaget's cognitive stages to the next (H. Epstein, 1978; Hudspeth, 1985), whether such changes are specifically related to the cognitive changes that Piaget described is still very much an open question.

As you'll discover later in the chapter, many psychologists question the notion that cognitive development is either as stagelike or as universal as Piaget believed. Nevertheless, Piaget's stages provide helpful insights into the nature of children's thinking at different age levels, and so we'll look at them more closely.

## Piaget's Stages of Cognitive Development

Piaget's four stages are summarized in Table 12.1. The age ranges noted in the table are *averages*: Some children reach a stage a bit earlier, others a bit later. Also, children are occasionally in *transition* from one stage to the next, displaying characteristics of two adjacent stages at the same time. You should note, too, that children and adolescents don't always take advantage of their advanced cognitive abilities, and thus they may show considerable variability in ways of thinking in their day-to-day activities (Chapman, 1988; Piaget, 1960). Figure 12.1 depicts the transitional and flexible nature of children's progress through the stages.

### ***Sensorimotor Stage (Birth Until Age 2)***

According to Piaget, newborns' behaviors are little more than *reflexes*—biologically built-in responses to particular stimuli (e.g., sucking on a nipple)—that ensure their survival. But in the second month, infants begin to exhibit voluntary behaviors that they repeat over and over, reflecting the development of perception- and behavior-based schemes—hence the label **sensorimotor stage**. Initially infants' voluntary behaviors focus almost exclusively on their own bodies (e.g., they might repeatedly put certain fingers in their mouths), but eventually their behaviors involve surrounding objects as well. For much of the first year, Piaget suggested, behaviors are largely spontaneous and unplanned.

Late in the first year, after repeatedly observing that certain actions lead to certain consequences, infants gradually acquire knowledge of cause-and-effect relationships in the world

**Table 12.1**  
Piaget's stages of cognitive development

Stage and Age Range	General Description
<b>Sensorimotor Stage</b> (birth until about 2 years old)	Schemes primarily entail perceptions and behaviors. Children's understandings of the world are based largely on their physical interactions with it.
<b>Preoperational Stage</b> (2 until about 6 or 7 years old)	Many schemes now have a symbolic quality, in that children can think and talk about things beyond their immediate experience. Children begin to reason about events, although not always in ways that are "logical" by adult standards.
<b>Concrete Operations Stage</b> (6 or 7 until about 11 or 12 years old)	Children acquire cognitive structures that enable them to reason in logical, adultlike ways about concrete, reality-based situations. They also realize that their own perspectives are not necessarily shared by others.
<b>Formal Operations Stage</b> (11 or 12 through adulthood)	Children can now think logically about abstract, hypothetical, and contrary-to-fact situations. They acquire many capabilities essential for advanced reasoning in mathematics and science.

around them. At this point, they begin to engage in **goal-directed behavior**, acting in ways they know will bring about desired results. At about the same time, they acquire **object permanence**, an understanding that physical objects continue to exist even when out of sight.

Piaget believed that for much of the sensorimotor period, children's thinking is restricted to objects in their immediate environment. But in the latter half of the second year, children develop

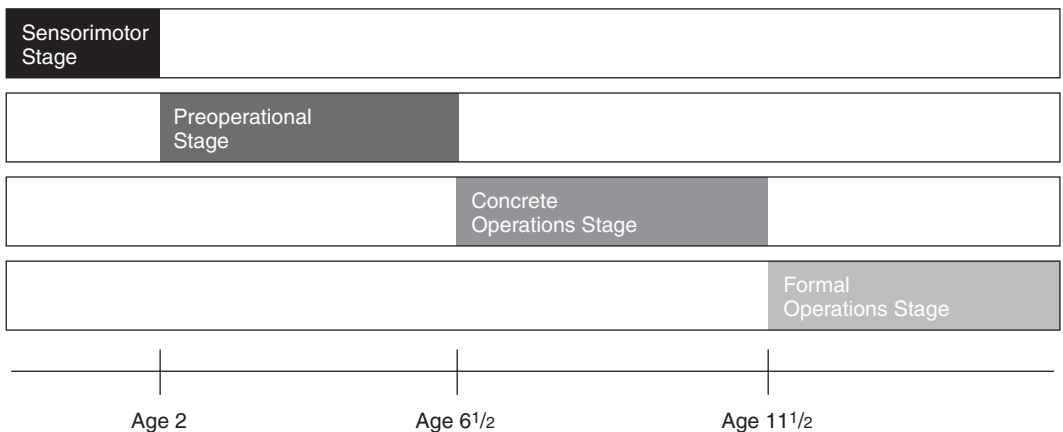

**Figure 12.1**  
Children gain abilities associated with more advanced Piagetian stages slowly over time, and they don't necessarily leave behind the characteristics associated with previous stages.

Adapted from CHILD DEVELOPMENT AND EDUCATION 4/E by T. M. McDevitt & J. E. Ormrod, 2010, p. 199, Upper Saddle River, NJ: Pearson Education. Adapted with permission.

**symbolic thought**, an ability to represent and think about objects and events in terms of internal, mental entities, or *symbols*. They may “experiment” with objects in their minds, first predicting what will happen if they do something to an object and then putting their plans into action. They may also recall and imitate behaviors they’ve seen other people exhibit—for instance, pretending to “talk” on a toy telephone. Such symbolic thinking marks the beginning of true thought as Piaget defined it.<sup>2</sup>

### ***Preoperational Stage (Age 2 Until Age 6 or 7)***

The ability to represent objects and events mentally (symbolic thought) gives children in the **preoperational stage** a more extended view of the world than they had during the sensorimotor stage. One key source of symbols is language, which virtually explodes during the early part of the preoperational stage. The words in children’s rapidly increasing vocabularies provide labels for newly developed mental schemes and serve as symbols that enable children to think about objects and events at distant places and times. Furthermore, language enables children to communicate their thoughts and receive information from other people in ways that weren’t possible during the sensorimotor stage.

With the emergence of symbolic thought, then, young children are no longer restricted to the here-and-now and so can think and act far more flexibly than they did previously. They can now recall past events and envision future ones, and they begin to tie their experiences together into an increasingly complex understanding of the world.

Yet preoperational thinking has definite limitations, especially as compared to the concrete operational thinking that emerges later. For example, young children tend to confuse psychological phenomena (e.g., thoughts and emotions) with physical reality, a confusion manifested by such actions as attributing feelings to inanimate objects and insisting that monsters and bogeymen lurk under the bed. They also tend to exhibit **egocentrism**, an inability to view situations from another person’s perspective.<sup>3</sup> Young children may have trouble understanding how a thoughtless remark might have hurt someone else’s feelings. And they may say things without considering the perspective of the listener—for instance, leaving out critical details as they tell a story and giving a fragmented version that a listener can’t possibly understand. Here we see one reason why, in Piaget’s view, social interaction is so important for development. Only by getting repeated feedback from other people can children learn that their thoughts and feelings are unique to them—that their own perception of the world isn’t necessarily shared by others.

When we consider adult forms of logical reasoning, preoperational children’s thinking doesn’t measure up. An example is difficulty with **class inclusion**: an ability to simultaneously classify an object as belonging both to a particular category and to one of its subcategories. Piaget provided an illustration in an interview that reflects the *clinical method* mentioned earlier. An

---

<sup>2</sup>The changes I’ve described in this section reflect six substages of the sensorimotor stage. For a detailed discussion of these substages, see Piaget’s *The Origins of Intelligence in Children* (1952b) or Flavell’s *The Developmental Psychology of Jean Piaget* (1963).

<sup>3</sup>Don’t confuse Piaget’s definition of *egocentrism* with its more commonly used meaning. When we describe a person as being *egocentric* in everyday speech, we usually mean that the person is concerned only about his or her own needs and desires; hence, the term refers to a personality characteristic. In Piaget’s theory, however, an egocentric child has a cognitive limitation, not a personality flaw: The child doesn’t yet have the *ability* to look at the world from other people’s perspectives.

adult begins the interview by showing a 6-year-old boy a box containing about a dozen wooden beads, two of which are white and the rest brown. The following discussion ensues:

- Adult: Are there more wooden beads or more brown beads?
- Child: More brown ones, because there are two white ones.
- Adult: Are the white ones made of wood?
- Child: Yes.
- Adult: And the brown ones?
- Child: Yes.
- Adult: Then are there more brown ones or more wooden ones?
- Child: More brown ones.
- Adult: What color would a necklace made of the wooden beads be?
- Child: Brown and white. (Here [he] shows that he understands that all the beads are wooden.)
- Adult: And what color would a necklace made with the brown beads be?
- Child: Brown.
- Adult: Then which would be longer, the one made with the wooden beads or the one made with the brown beads?
- Child: The one with the brown beads.
- Adult: Draw the necklaces for me.

The child draws a series of black rings for the necklace of brown beads. He then draws a series of black rings plus two white rings for the necklace of wooden beads.

- Adult: Good. Now which will be longer, the one with the brown beads or the one with the wooden beads?
- Child: The one with the brown beads. (dialogue from Piaget, 1952a, pp. 163–164)

Another example of the illogical quality of preoperational thinking is a young child’s typical response to a **conservation of liquid** problem. Imagine three glasses: Glasses A and B are tall, thin, and filled to equal heights with water, whereas Glass C is short, fat, and empty, as is shown in the “Before” part of Figure 12.2. Clearly Glasses A and B contain the same amount of water.

**Figure 12.2**  
 The water in Glass B (“Before”) is poured into Glass C (“After”). Does Glass C have the same amount of water that Glass B did?

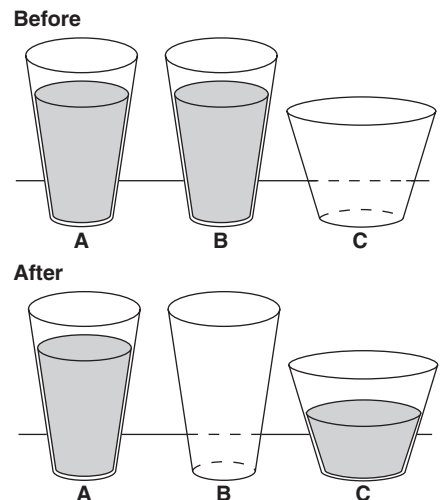



But now the contents of Glass B are poured into Glass C, thereby creating the situation shown in the “After” part of Figure 12.2. Do Glass A and Glass C contain the same amount of water, or does one contain more?

Being a logical adult, you’d probably conclude that the two glasses hold identical amounts of water (excluding a few drops that might have been lost during pouring). In contrast, preoperational children are likely to say that the glasses hold different amounts of water: Most will say that Glass A has more because it’s taller, although a few will say that Glass C has more because it’s fatter. The children’s thinking depends more on perception than logic during the preoperational stage and so is susceptible to outward appearances: The glasses *look* different and therefore must *be* different.

As children approach the later part of the preoperational stage, perhaps at around age 4 or 5, they show early signs of being logical. For example, they sometimes draw correct conclusions about class inclusion problems (e.g., the wooden beads problem) and conservation problems (e.g., the water glasses problem). But they base their reasoning on hunches and intuition rather than on any conscious awareness of underlying logical principles, and so they can’t yet explain *why* their conclusions are correct.

### ***Concrete Operations Stage (Age 6 or 7 Until Age 11 or 12)***

When children move into the **concrete operations stage**, their thinking processes begin to take the form of logical *operations* that enable them to integrate various qualities and perspectives of an object or event. Such operational thought enables a number of more advanced abilities. For example, children now realize that their own viewpoints and feelings aren’t necessarily shared by others and may reflect personal opinions rather than reality. Accordingly, they know they can sometimes be wrong and thus begin to seek out external validation for their ideas, asking such questions as “What do you think?” and “Did I get that problem right?”

Children in the concrete operations stage are capable of many forms of logical thought. For example, they show **conservation**: They understand that if nothing is added or taken away, the amount stays the same despite any changes in shape or arrangement. They also exhibit class inclusion—for instance, recognizing that brown beads can simultaneously be wooden beads. They can readily explain their reasoning, as the following interview with an 8-year-old about the wooden beads problem illustrates:

Adult: Are there more wooden beads or more brown beads?

Child: More wooden ones.

Adult: Why?

Child: Because the two white ones are made of wood as well.

Adult: Suppose we made two necklaces, one with all the wooden beads and one with all the brown ones. Which one would be longer?

Child: Well, the wooden ones and the brown ones are the same, and it would be longer with the wooden ones because there are two white ones as well. (dialogue from Piaget, 1952a, p. 176)

Children continue to develop their newly acquired logical thinking capabilities throughout the concrete operations stage. For example, over time they become capable of dealing with increasingly complex conservation tasks. Some forms of conservation, such as the conservation of liquid task illustrated in Figure 12.2, appear at age 6 or 7. Other forms may not appear until several years later. Consider the task involving conservation of weight depicted in Figure 12.3. Using a balance scale, an adult shows a child that two balls of clay have the same weight. One

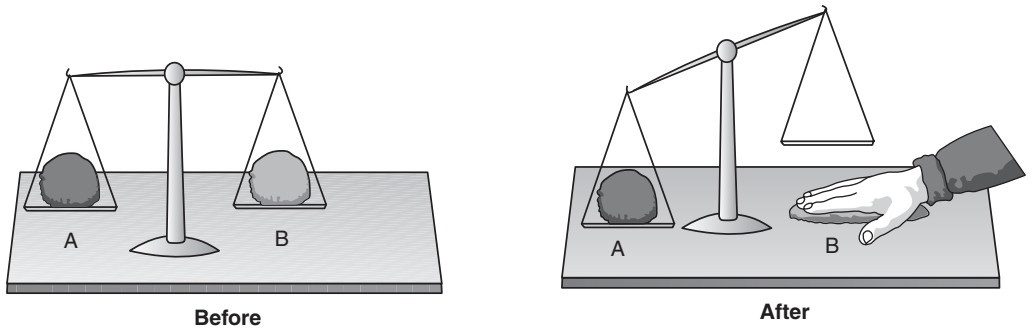

**Figure 12.3**

Balls A and B initially weigh the same (“Before”). When Ball B is flattened into a pancake shape (“After”), how does its weight now compare with that of Ball A?

ball is removed from the scale and smashed into a pancake shape. The child is then asked if the pancake weighs the same as the unsmashed ball or if the two pieces of clay weigh different amounts. Children typically don’t achieve conservation of weight—that is, they don’t realize that the flattened pancake weighs the same as the round ball—until relatively late in concrete operations.<sup>4</sup>

Despite their advancements in reasoning, children in the concrete operations stage are limited in one very important respect: They can apply their logical operations only to concrete, observable objects and events—hence the term *concrete* operations. They have trouble dealing with abstract concepts and with hypothetical ideas that contradict reality as they know it. For example, the concrete operational child should readily agree with this logic:

If all first graders are children,  
And if all children are people,  
Then all first graders are people.

Yet the concrete operational child would have trouble recognizing the logical validity of a similar problem that includes a contrary-to-fact premise:

If all first graders are children,  
And if all children are hippopotamuses,  
Then all first graders are hippopotamuses.

Concrete operational children cannot easily distinguish between logic and reality, and, after all, first graders *aren’t* hippopotamuses.

### ***Formal Operations Stage (Age 11 or 12 through Adulthood)***

Sometime around puberty, children enter the **formal operations stage**. At this point, they become capable of thinking and reasoning about things that have little or no basis in physical reality—abstract concepts, hypothetical ideas, contrary-to-fact statements, and so on. For example, they

<sup>4</sup>The idea that *any* form of matter has weight—no matter how small in size—seems to be troublesome even for adolescents (and, I suspect, also for many adults). For example, although most eighth graders acknowledge that a large block of Styrofoam has weight, they may claim that a tiny piece torn from the block has no weight at all (C. L. Smith, Maclin, Grosslight, & Davis, 1997; Wisner & Smith, 2008).

become able to see the underlying meanings of proverbs such as *A rolling stone gathers no moss* and *Don't put the cart before the horse*. They become better able to understand abstract concepts in mathematics, science, and social studies: *negative number, infinity, momentum, quark, republic, human rights*, and so on.

Other abilities essential to mathematical and scientific reasoning emerge as well. For instance, children acquire **proportional thinking**, which enables them to comprehend the nature of proportions in various forms (e.g., fractions, decimals, ratios). And children become capable of **separation and control of variables**: In testing a hypothesis about which factor among many is responsible for a particular result, they'll test one factor at a time while holding all others constant. Consider, for example, the case of a pendulum—a suspended object that swings back and forth indefinitely (a yo-yo and a playground swing are two everyday examples). What one or more characteristics of a pendulum determine how fast it swings? You might generate several hypotheses regarding the underlying cause(s) of a pendulum's oscillation rate, including (1) the weight of the object at the bottom; (2) the length of the rope, string, or other material suspending the object; (3) the force with which the pendulum is pushed; and (4) the height from which the object is first released. To determine conclusively which one or more of these hypotheses are correct, you would need to test the effect of one characteristic at a time while keeping the other characteristics constant. For example, if you were testing the hypothesis that weight makes a difference, you might try objects of different weights while keeping constant the length of the string, the force with which you push each object, and the height from which you release or push it. Similarly, if you hypothesized that the length of the string is a critical factor, you might vary the length while continuing to use the same object and setting the pendulum in motion in the same manner. If you carefully separate and control variables, you would come to the correct conclusion: Only *length* affects a pendulum's oscillation rate.

With the onset of formal operations children are also able to examine their own thought processes and evaluate the quality and logic of those thoughts. For example, a child might say, "Oops, I just contradicted myself, didn't I?" In essence, children who have reached the formal operations stage can apply mental operations to *other* mental operations—they can think about their thinking.

Because learners capable of formal operational reasoning can deal with hypothetical and contrary-to-fact ideas, they can envision how the world might be different from—and possibly better than—the way it actually is. Thus they may initially be quite idealistic about social, political, and ethical issues. Many adolescents begin to show concern about world problems and devote some of their energy to worthy issues such as global warming, world hunger, or animal rights. However, they often offer recommendations for change that seem logical but aren't practical in today's world. For example, they might argue that racism would disappear overnight if people would just begin to "love one another," or perhaps they will propose that a nation should disband its armed forces and eliminate all of its weaponry as a way of moving toward world peace. Piaget suggested that adolescent idealism reflects an inability to separate one's own logical abstractions from the perspectives of others and from practical considerations.<sup>5</sup> Only through experience do adolescents eventually begin to temper their optimism with some realism about what's possible in a given time frame and with limited resources.

---

<sup>5</sup>In Piaget's view, the inability to separate logical abstractions from others' perspectives and practical considerations is another form of *egocentrism*—in this case, one that characterizes formal operational rather than preoperational thought.

## CURRENT PERSPECTIVES ON PIAGET'S THEORY

---

Perhaps Piaget's greatest contribution to our understanding of cognitive development was the nature of the research questions he asked and tried to answer about how children think and reason. In addition, some of his key ideas—for instance, that children actively seek information about their world, that they construct their own understandings of it, that they must relate new experiences to what they already know, and that encountering puzzling phenomena can sometimes spur them to revise their understandings—have stood the test of time.

However, Piaget's descriptions of processes that *propel* development—especially assimilation, accommodation, and equilibration—can be frustratingly vague (Chapman, 1988; diSessa, 2006; Klahr, 2001). And interaction with one's physical environment, while certainly valuable, may be less critical than Piaget believed. For instance, children with significant physical disabilities, who can't actively experiment with physical objects, learn a great deal about the world simply by observing what happens around them (Bebko, Burke, Craven, & Sarlo, 1992; Brainerd, 2003).

Piaget's theory has inspired a great deal of research about cognitive development. In general, this research supports Piaget's proposed *sequence* in which different abilities emerge (Chapman, 1988; Flavell, Miller, & Miller, 2002; Ginsburg, Cannon, Eisenband, & Pappas, 2006). For example, the ability to reason about abstract ideas emerges only after children are already capable of reasoning about concrete objects and events, and the order in which various conservation tasks are mastered is much as Piaget reported. Contemporary researchers question the *ages* at which various abilities actually appear, however. They're also finding that children's logical reasoning capabilities may vary considerably depending on their previous experiences, knowledge, and cultural backgrounds. And most contemporary researchers seriously doubt that cognitive development is as stagelike as Piaget proposed.

### Capabilities of Different Age-Groups

Infants are apparently more competent than Piaget's description of the sensorimotor stage suggests. For instance, they show preliminary signs of object permanence as early as 2½ months old and continue to firm up this understanding over a period of many months (Baillargeon, 2004; L. B. Cohen & Cason, 2006). Also, by 12 months of age, infants who haven't yet acquired language can nonverbally communicate about—and so apparently can also *think* about—objects and events they aren't currently perceiving or experiencing (Liskowski, Schäfer, Carpenter, & Tomasello, 2009; Mandler, 2007).

Toddlers and preschoolers, too, are more capable than Piaget's preoperational stage would have us believe. For instance, preschool children don't always show egocentrism: If we ask them to show us their artwork, they hold it so that we (rather than they) can see it (Newcombe & Huttenlocher, 1992). Under some circumstances they're capable of class inclusion and conservation (Donaldson, 1978; Goswami & Pauen, 2005; Morra, Gobbo, Marini, & Sheese, 2008). Occasionally they even show rudimentary forms of abstract and contrary-to-fact thinking—thinking that, in Piaget's view, doesn't appear until adolescence (S. R. Beck, Robinson, Carroll, & Apperly, 2006; Ginsburg, Lee, & Boyd, 2008; McNeil & Uttal, 2009).

Piaget may have underestimated the capabilities of elementary school children as well. For example, even first and second graders show some ability to understand and use simple proportions (e.g.,  $\frac{1}{2}$ ,  $\frac{1}{3}$ ,  $\frac{1}{4}$ ) if they can relate these proportions to everyday objects (Empson, 1999; Van Dooren, De Bock, Hessels, Janssens, & Verschaffel, 2005). And some elementary school children

can separate and control variables, especially when asked to choose among several possible experiments or given hints about the importance of controlling all variables except the one being tested (Barchfeld, Sodian, Thoermer, & Bullock, 2005; Lorch et al., 2010; Metz, 1995; Ruffman, Perner, Olson, & Doherty, 1993).

Yet Piaget seems to have *overestimated* what adolescents can do. Formal operational thinking processes (e.g., proportional reasoning, separation and control of variables) emerge much more gradually than Piaget suggested, and even high school students don't necessarily use them regularly (Flieller, 1999; Schliemann & Carraher, 1993; Tourniaire & Pulos, 1985; Zohar & Aharon-Kravinsky, 2005). In fact, even *adults* don't always reason in the logical ways that supposedly characterize formal operational thought (X. Lin & Lehman, 1999; Morra et al., 2008; Pascarella & Terenzini, 1991). For instance, when adults draw conclusions and inferences about real-world events, they may overrely on their existing knowledge about the world—thus having the same difficulty in separating logic from reality that children in concrete operations do (D. Kuhn & Franklin, 2006). Perhaps the rules of formal logic—the kind you might learn in a philosophy class—don't reflect the typical ways in which children or adults reason (Halford & Andrews, 2006; D. Kuhn & Franklin, 2006). To some degree, Piaget's formal operations stage may capture people's capabilities under the best of circumstances rather than their normal, day-to-day reasoning processes (R. J. Sternberg, 2003).

## Effects of Experience and Prior Knowledge

Piaget proposed that neurological maturation places significant constraints on children's reasoning abilities at any particular age. Although maturation certainly places limits on cognitive development (see Chapter 2), Piaget may have overrated its importance in logical thought, especially for older children and adolescents. Explicit training and other experiences often help youngsters acquire reasoning abilities sooner than Piaget predicted (Brainerd, 2003; D. Kuhn, 2006). For instance, children as young as age 4 or 5 begin to show conservation after having experience with conservation tasks, especially if they can actively manipulate the task materials and discuss their reasoning with someone who already exhibits conservation (D. Field, 1987; Halford & Andrews, 2006; Siegler & Chen, 2008; Siegler & Lin, 2010). Similarly, instruction with concrete manipulatives can help children grasp the nature of proportions (Fujimura, 2001; Sarama & Clements, 2009). Children ages 10 and 11 can more easily solve logical problems involving hypothetical ideas if they're taught relevant problem-solving strategies, and they become increasingly able to separate and control variables when they have numerous experiences that require them to do so (D. Kuhn & Pease, 2008; S. Lee, 1985; Lorch et al., 2010; Schauble, 1990).

Piaget acknowledged that as children gain new logical thinking skills, they may apply the skills in one subject area but not necessarily in another (Chapman, 1988; Piaget, 1940). It's becoming increasingly apparent that for people of all ages, the ability to think logically can vary considerably from one situation to the next, depending on knowledge, background experiences, and training relevant to the situation (Brainerd, 2003; D. Kuhn & Franklin, 2006). For instance, adolescents may demonstrate formal operational thought in one academic subject area while thinking more concretely in others (Klaczynski, 2001; Lovell, 1979; Tamburrini, 1982). Evidence of formal operations typically emerges in the physical sciences earlier than in such subjects as history and geography, perhaps because the latter subjects are further removed from students' everyday realities. And in general, adolescents and adults are apt to apply formal operational thought to topics about which they have a great deal of knowledge and yet think concretely

about topics with which they're unfamiliar (Giroto & Light, 1993; M. C. Linn, Clement, Pulos, & Sullivan, 1989; Schliemann & Carraher, 1993).

One experience that promotes more advanced reasoning is formal education. Going to school and the specific nature of one's schooling are associated with mastery of concrete operational and formal operational tasks (Artman & Cahan, 1993; Dias, Roazzi, O'Brien, & Harris, 2005; Flieller, 1999; Rogoff, 2003). For instance, you'll be happy to learn that taking college courses in a particular area (in the psychology of learning, perhaps?) leads to improvements in formal reasoning skills related to that area (Lehman & Nisbett, 1990).

## Effects of Culture

Although Piaget eventually acknowledged that different cultural groups might foster different ways of thinking, he gave virtually no attention to culture as a prominent factor affecting cognitive development (Chapman, 1988). Yet research indicates that the course of cognitive development varies somewhat from one cultural group to another, probably because different cultures give children somewhat different experiences (Maynard & Greenfield, 2003; Morra et al., 2008). For example, Mexican children whose families make pottery for a living acquire conservation skills earlier than their peers in other Mexican families (Price-Williams, Gordon, & Ramirez, 1969). Apparently, making pottery requires children to make frequent judgments about needed quantities of clay and water—judgments that must be fairly accurate regardless of the specific shape or form of the clay or water container. In other cultures, especially in some where children don't attend school, conservation appears several years later than it does in Western cultures, and formal operational reasoning may never appear at all (M. Cole, 1990; Fahrmeier, 1978). In such contexts, some logical reasoning skills may simply have little relevance to people's daily lives (J. G. Miller, 1997; Morra et al., 2008).

## Views on Piaget's Stages

In light of all the evidence, does it still make sense to talk about discrete stages of cognitive development? Even Piaget acknowledged that the characteristics of any particular stage don't necessarily hang together as a tight, inseparable set of abilities (Chapman, 1988; Piaget, 1940). Most contemporary developmental theorists now believe that cognitive development can more accurately be described in terms of gradual *trends*—for instance, a trend toward increasingly abstract thought—rather than discrete stages (e.g., L. B. Cohen & Cashon, 2006; Flavell, 1994; D. Kuhn & Franklin, 2006; Siegler & Alibali, 2005). They further suggest that Piaget's stages may better describe how children *can* think—rather than how they typically *do* think—and that the nature of cognitive development may be somewhat specific to different contexts, content areas, and cultures (Halford & Andrews, 2006; Klaczynski, 2001; Rogoff, 2003).

Yet some psychologists believe that by entirely rejecting Piaget's notion of stages, we may be throwing the baby out with the bath water. We look at their neo-Piagetian perspectives now.

## NEO-PIAGETIAN THEORIES OF COGNITIVE DEVELOPMENT

---

Some theorists have combined some of Piaget's ideas with concepts from information processing theory to construct **neo-Piagetian theories** of how children's learning and reasoning capabilities change over time (e.g., Case, 1985, 1991; Case & Okamoto, 1996; Fischer & Bidell, 2006;

Fischer & Daley, 2007; Morra et al., 2008). Neo-Piagetian theorists don't always agree about the exact nature of children's thinking at different age levels or about the exact mechanisms that promote cognitive development. Nevertheless, several ideas are central to their thinking:

- ◆ *Cognitive development is constrained by the maturation of information processing mechanisms in the brain.* Neo-Piagetian theorists have echoed Piaget's belief that cognitive development depends somewhat on brain maturation. Recall, for example, the concept of *working memory*, that limited-capacity component of the human memory system in which active, conscious mental processing occurs. Children certainly use their working memories more effectively as they get older, courtesy of such processes as myelination, chunking, maintenance rehearsal, and automaticity (see Chapters 2, 8, and 9). But the actual physical "space" of working memory may increase somewhat as well (see Chapter 8). Neo-Piagetian theorists propose that children's more limited working memory capacity at younger ages restricts their ability to acquire and use complex thinking and reasoning skills. Thus it probably places an upper limit on what children can accomplish at any particular age (Case & Mueller, 2001; Case & Okamoto, 1996; Fischer & Bidell, 1991; Morra et al., 2008).

- ◆ *Children acquire new knowledge through both unintentional and intentional learning processes.* Many contemporary psychologists agree that children learn some things with little or no conscious awareness or effort. For example, consider this question about household pets: "On average, which are larger, cats or dogs?" Even if you've never intentionally thought about this issue, you can easily answer "dogs" because of the many characteristics (including size) you've learned to associate with both species. Children unconsciously learn that many aspects of their world are characterized by consistent patterns and associations (see the discussion of concept learning in Chapter 10).

Yet especially as children's brains mature in the first year or two of life, they increasingly think actively and consciously about their experiences, and they begin to devote considerable mental attention to constructing new understandings of the world and solving the little problems that come their way each day (Case & Okamoto, 1996; Morra et al., 2008; Pascual-Leone, 1970). As they do so, they draw on what they've learned (perhaps unconsciously) about common patterns in their environment, and they may simultaneously *strengthen* their knowledge of those patterns. Thus both the unintentional and intentional learning processes typically work hand in hand as children tackle day-to-day tasks and challenges and increasingly make sense of and adapt to their world (Case, 1985; Case & Okamoto, 1996).

- ◆ *Children acquire cognitive structures that affect their thinking in particular content domains.* As we've seen, children's ability to think logically depends on their specific knowledge, experiences, and instruction related to the task at hand, and so the sophistication of their reasoning may vary considerably from one situation to another. With this point in mind, neo-Piagetian theorists reject Piaget's notion that children develop increasingly integrated systems of mental processes (operations) that they can apply to a wide variety of tasks and content domains. Instead, neo-Piagetians suggest, children acquire more specific systems (**structures**) of concepts and thinking skills that influence thinking and reasoning capabilities relative to specific topics or content domains.

- ◆ *Development in specific content domains can sometimes be characterized as a series of stages.* Although neo-Piagetian theorists reject Piaget's notion that a single series of stages characterizes all of cognitive development, they speculate that cognitive development in specific content domains often has a stagelike nature (e.g., Case, 1985; Case & Okamoto, 1996; Fischer & Bidell,

1991; Fischer & Immordino-Yang, 2002; Morra et al., 2008). Children's entry into a particular stage is marked by the acquisition of new abilities, which children practice and gradually master over time. Eventually, they integrate these abilities into more complex structures that mark their entry into a subsequent stage. Thus, as is true in Piaget's theory, each stage constructively builds on the abilities acquired in any preceding stages.

Even in a particular subject area, however, cognitive development isn't necessarily a single series of stages through which children progress as if they were climbing rungs on a ladder. In some cases, development might be better characterized as progression along "multiple strands" of skills that occasionally interconnect, consolidate, or separate in a weblike fashion (Fischer & Daley, 2007; Fischer & Immordino-Yang, 2002; Fischer, Knight, & Van Parys, 1993). From this perspective, children may acquire more advanced levels of competence in a particular area through any one of several pathways. For instance, as they become increasingly proficient in reading, children may gradually develop their word decoding skills, their comprehension skills, and so on—and they may often combine these skills when performing a task—but the relative rates at which each skill is mastered will vary from child to child.

◆ *Formal schooling has a greater influence on cognitive development than Piaget believed.* Whereas Piaget emphasized the importance of children's informal interactions with their environment, neo-Piagetians argue that within the confines of children's neurological maturation and working memory capacity, formal instruction can definitely impact cognitive development (Case & Okamoto, 1996; Case et al., 1993; Fischer & Immordino-Yang, 2002; S. A. Griffin, Case, & Capodilupo, 1995). One prominent neo-Piagetian, Robbie Case, has been particularly adamant about the value of formal education for cognitive advancements. A closer look at his theory can give you a flavor for the neo-Piagetian approach.

## Case's Theory

Robbie Case was a highly productive neo-Piagetian researcher at the University of Toronto until his untimely death in 2000. Central to Case's theory is the notion of **central conceptual structures**, integrated networks of concepts and cognitive processes that form the basis for much of children's thinking, reasoning, and learning in particular areas (Case, 1991; Case & Okamoto, 1996; Case, Okamoto, Henderson, & McKeough, 1993). Over time, these structures undergo several major transformations, each of which marks a child's entry into the next higher stage of development.

Case speculated about the nature of children's central conceptual structures with respect to several domains, including number, spatial relationships, and social thought (Case, 1991; Case & Okamoto, 1996). A central conceptual structure related to *number* underlies children's ability to reason about and manipulate mathematical quantities. This structure reflects an integrated understanding of how such mathematical concepts and operations as numbers, counting, addition, and subtraction are interconnected. A central conceptual structure related to *spatial relationships* underlies children's performance in such areas as drawing, construction and use of maps, replication of geometric patterns, and psychomotor activities (e.g., writing in cursive, hitting a ball with a racket). This structure enables children to align objects in space according to one or more reference points (e.g., the *x*- and *y*-axes used in graphing). And a central conceptual structure related to *social thought* underlies children's reasoning about interpersonal relationships, their knowledge of common scripts related to human interactions, and their comprehension of



short stories and other works of fiction. This structure includes children’s general beliefs about human beings’ thoughts, desires, and behaviors. Case found evidence indicating that these three conceptual structures probably develop in a wide variety of cultural and educational contexts (Case & Okamoto, 1996).

From ages 4 to 10, Case suggested, parallel changes occur in children’s central conceptual structures in each of the three areas, with such changes reflecting increasing integration and multidimensional reasoning over time. We’ll take the development of children’s understanding of number as an example.

***A Possible Central Conceptual Structure for Number***

From Case’s perspective, 4-year-old children understand the difference between *a little* and *a lot* and recognize that adding objects leads to more of them and subtracting objects leads to fewer of them. Applying such knowledge to apples might take the form depicted in the top half of Figure 12.4. Furthermore, many 4-year-olds can accurately count a small set of objects and conclude that the last number they count equals the total number of objects in the set. This process,

**Figure 12.4**  
Possible number structures at age 4

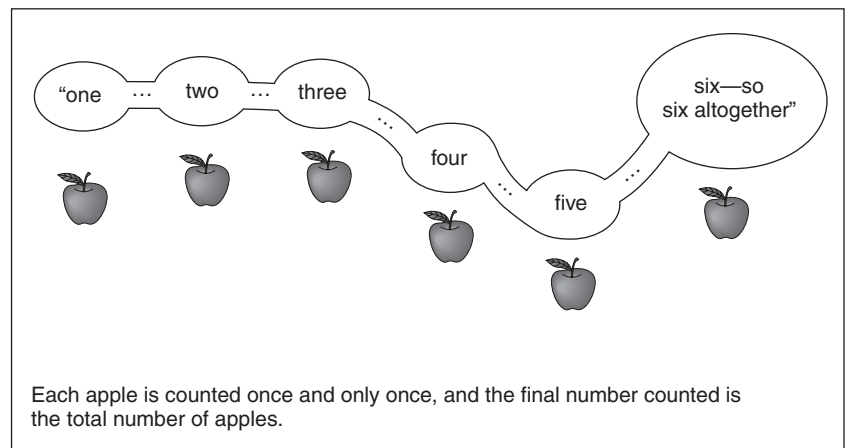
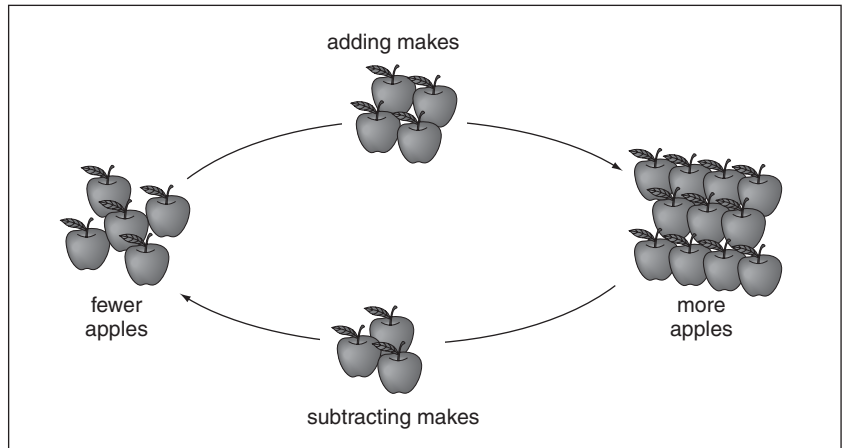

again using apples, is depicted in the bottom half of Figure 12.4. Thus 4-year-olds can visually compare a group of 5 objects with a group of 6 objects and tell you that the latter group contains more objects, and they may also count accurately to either 5 or 6. Yet they cannot answer a question such as, “Which is more, 5 or 6?”—a question that involves knowledge of *both* more-versus-less and counting. It appears that they have not yet integrated their two understandings of number into a single conceptual framework.

By the time children are 6 years old, they can easily answer simple “Which is more?” questions. Case proposed that at age 6, the two number structures illustrated in Figure 12.4 have become integrated into a single, more comprehensive number structure that now includes several key elements:

- Children understand and can say the verbal numbers “one,” “two,” “three,” and so on.
- They recognize the written numerals 1, 2, 3, and so on.
- They have a systematic process for counting objects: They say each successive number as they touch each successive object in a group. Eventually, children count by mentally “tagging” (rather than physically touching) each object.
- They also use their fingers for representing small quantities (e.g., 3 fingers equals 3 objects). Their use of fingers for both counting objects and representing quantities may be a key means through which they integrate the two processes into a single conceptual structure.
- They equate movement toward higher numbers with such concepts as *a lot*, *more*, and *bigger*. Similarly, they equate movement toward lower numbers with such concepts as *a little*, *less*, and *smaller*.
- They understand that movement from one number to the next is equivalent to either adding one unit to the set or subtracting one unit from it, depending on the direction of movement.
- They realize that any change in one dimension (e.g., from 3 to 4) must be accompanied by an equivalent change along other dimensions (e.g., from “three” to “four,” and from ●●● to ●●●●).

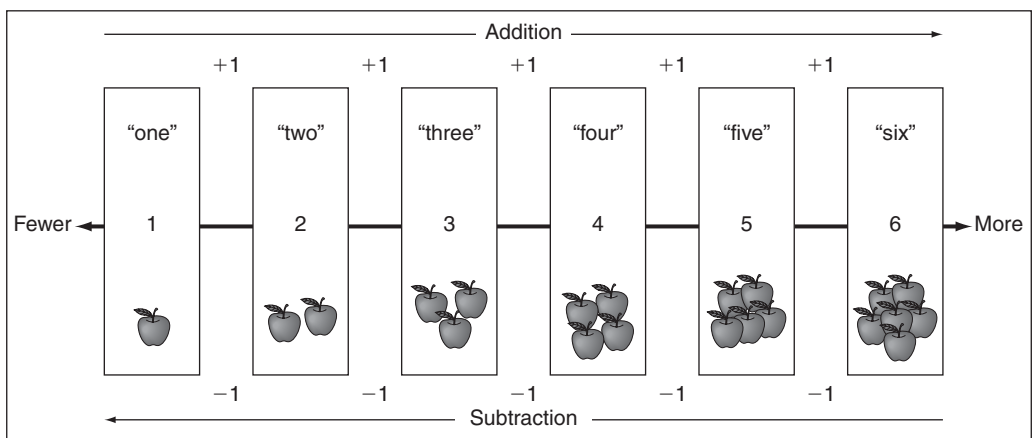

**Figure 12.5**  
Possible central conceptual structure at age 6

In essence, the more comprehensive conceptual structure at age 6 forms a mental number line that children can use to facilitate their understanding and execution of such processes as addition, subtraction, and comparisons of quantities (e.g., see Figure 12.5).

At age 8, Case proposed, children have sufficiently mastered this central conceptual structure that they can begin to use two number lines simultaneously to solve mathematical problems. For example, they can now answer such questions as, “Which number is bigger, 32 or 28?” and “Which number is closer to 25, 21 or 18?” Such questions require them to compare digits in both the “ones” column and “tens” column, with each comparison taking place along a separate mental number line. In addition, 8-year-olds presumably have a better understanding of operations that require transformations across columns, such as “carrying a 1” to the tens column during addition or “borrowing a 1” from the tens column during subtraction.

Finally, at about age 10, children become capable of generalizing the relationships of two number lines to the entire number system. They now understand how the various columns (ones, tens, hundreds, etc.) relate to one another and can expertly move back and forth among the columns. They can also treat the answers to mathematical problems as mental entities in and of themselves and so can answer such questions as “Which number is bigger, the difference between 6 and 9 or the difference between 8 and 3?”

Case tracked the development of children’s central conceptual structure for number only until age 10. He acknowledged, however, that children’s understanding of numbers continues to develop well into adolescence. For instance, he pointed out that teenagers often have trouble with questions such as “What is a half of a third?” and suggested that their difficulty results from an incomplete conceptual understanding of division and the results (e.g., fractions) that it yields.

Neo-Piagetian theorists haven’t come to consensus—and certainly they don’t completely agree with Piaget—about the nature and structure of children’s abilities at various age levels (e.g., see Morra et al., 2008). Even so, cognitive-developmental perspectives have much to offer educators and other practitioners, as we’ll see now.

## IMPLICATIONS OF PIAGETIAN AND NEO-PIAGETIAN THEORIES

---

Piaget’s theory and the subsequent research and theories it has inspired have numerous practical implications for educators and other professionals, as revealed in the following principles:

- ◆ *Children and adolescents can learn a great deal through hands-on experiences.* Young people learn many things by exploring their natural and human-made physical worlds (Flum & Kaplan, 2006; Ginsburg et al., 2006; Hutt, Tyler, Hutt, & Christopherson, 1989). In infancy, such exploration might involve experimenting with objects that have visual and auditory appeal, such as rattles, stacking cups, and pull toys. At the preschool level, it might involve playing with water, sand, wooden or plastic blocks, and age-appropriate manipulative toys. During the elementary school years, it might entail throwing and catching balls, working with clay and watercolor paints, or constructing Popsicle-stick structures. Despite an increased capacity for abstract thought after puberty, adolescents also benefit from opportunities to manipulate and experiment with concrete materials—perhaps equipment in a science lab, food and cooking utensils, or wood and woodworking tools. Such opportunities allow teenagers to tie abstract scientific concepts to the concrete, physical world. Figure 12.5 captures some of this structure’s elements, again using applies for illustrative purposes.

In educational settings, learning through exploration is sometimes called **discovery learning**. Piaget suggested that effective discovery learning should be largely a child-initiated and child-directed effort. By and large, however, researchers are finding that students benefit more from carefully planned and structured activities that help them construct appropriate interpretations (M. C. Brown, McNeil, & Glenberg, 2009; Hardy, Jonen, Möller, & Stern, 2006; Mayer, 2004; McNeil & Jarvin, 2007; J. Sherman & Bisanz, 2009).

A variation of discovery learning, **inquiry learning**, typically has the goal of helping students acquire more effective *reasoning processes* either instead of or in addition to acquiring new information. For example, kindergarten teachers can teach students how to ask questions about phenomena in their physical world and then (1) make predictions, (2) gather and record data related to their predictions, and (3) draw conclusions (Patrick, Mantzicopoulos, & Samarapungavan, 2009). And middle school science teachers can give students practice in separating and controlling variables by guiding them as they design and conduct experiments related to, say, factors affecting how fast a pendulum swings or how far a ball travels after rolling down an incline (e.g., Lorch et al., 2010).

Effective discovery and inquiry learning sessions don't necessarily have to involve actual physical objects; they can instead involve experimentation in computer-based simulations. For example, children can learn a great deal about fractions with virtual "manipulatives" on a computer screen, and adolescents can systematically test various hypotheses that might affect earthquakes or avalanches in a virtual world (D. Kuhn & Pease, 2010; Moreno, 2006; Sarama & Clements, 2009; Zohar & Aharon-Kravetsky, 2005).

The extent to which discovery and inquiry activities need to be structured depends somewhat on students' current knowledge and reasoning skills. For instance, advanced high school science students may profit from their own, self-directed experiments if they can test various hypotheses systematically through careful separation and control of variables and if they have appropriate concepts (*force, momentum*, etc.) with which to interpret their findings. Younger and less knowledgeable students are apt to need more guidance about how to design conclusive experiments and interpret their findings (de Jong & van Joolingen, 1998; D. Kuhn & Pease, 2010; B. Y. White & Frederiksen, 2005; Zohar & Aharon-Kravetsky, 2005).

Teachers should keep in mind that discovery and inquiry learning activities have a downside—one related to the *confirmation bias* phenomenon I mentioned in Chapter 10. In particular, students may misinterpret what they observe, either learning the wrong thing or confirming their existing misconceptions about the world (de Jong & van Joolingen, 1998; Hammer, 1997; Schauble, 1990). Consider the case of Barry, an eleventh grader whose physics class was studying the idea that an object's mass and weight do *not*, in and of themselves, affect the speed at which the object falls. Students were asked to design and build an egg container that would keep an egg from breaking when dropped from a third-floor window. They were told that on the day of the egg drop, they would record the time it took for the eggs to reach the ground. Convinced that heavier objects fall faster, Barry added several nails to his egg's container. Yet when he dropped it, classmates timed its fall at 1.49 seconds, a time very similar to that for other students' lighter containers. He and his teacher had the following discussion about the result:

Teacher: So what was your time?

Barry: 1.49. I think it should be faster.

Teacher: Why?

Barry: Because it weighed more than anybody else's and it dropped slower.

Teacher: Oh really? And what do you attribute that to?

Barry: That the people weren't timing real good. (Hynd, 1998a, p. 34)

It's essential, then, that teachers carefully monitor the interpretations that students draw from their hands-on activities.

◆ *Puzzling phenomena can create disequilibrium and spur children to acquire new understandings.* Events and information that conflict with youngsters' current understandings create disequilibrium that may motivate them to reevaluate and perhaps modify what they "know" to be true (e.g., Chouinard, 2007; M. G. Hennessey, 2003; Zohar & Aharon-Kravetsky, 2005). For instance, if they believe that "light objects float and heavy objects sink" or that "wood floats and metal sinks," an instructor might present a common counterexample: a metal battleship (floating, of course) that weighs many tons. From Piaget's perspective, we're talking here about revising existing schemes; from the perspective of contemporary cognitive psychology, we're talking about *conceptual change*.

◆ *Interactions with peers can also promote more advanced understandings.* As noted earlier, Piaget proposed that interaction with peers helps children realize that others often view the world very differently than they do and that their own ideas aren't always completely logical or accurate. Furthermore, interactions with age-mates that involve differences of opinion—**sociocognitive conflict**—can create disequilibrium that may spur children to reevaluate their current perspectives.

Many contemporary psychologists share Piaget's belief in the importance of sociocognitive conflict. Interactions with peers have several advantages. First, peers speak at a level children can understand. Second, whereas children may accept an adult's ideas without argument, they're more willing to disagree with and challenge the ideas of their peers. And third, when children hear competing views held by peers—individuals who presumably have knowledge and abilities similar to their own—they may be motivated to reconcile the contradictions (N. Bell, Grossen, & Perret-Clermont, 1985; Champagne & Bunce, 1991; De Lisi & Golbeck, 1999; Hatano & Inagaki, 1991; D. W. Johnson & Johnson, 2009b; C. L. Smith, 2007; Webb & Palincsar, 1996).

◆ *Children are more likely to reason in sophisticated ways when they work with familiar tasks and topics.* Earlier I mentioned that children and adolescents display more advanced reasoning skills when they work with subject matter they know well. We find an example in a study by Pulos and Linn (1981). In this study, 13-year-olds were shown the picture presented in Figure 12.6 and told, "These four children go fishing every week, and one child, Herb, always catches the most fish. The other children wonder why." If you look at the picture, it's obvious that Herb differs from the other children in several ways, including the kind of bait he uses, the length of his fishing rod, and his location by the pond. Students who were avid fishermen more effectively separated and controlled variables for this situation than they did for the pendulum problem described earlier, whereas the reverse was true for nonfishermen.

◆ *Piaget's clinical method can offer many insights into children's reasoning processes.* By presenting a variety of Piagetian tasks involving either concrete or formal operational thinking skills—tasks involving class inclusion, conservation, separation and control of variables, proportional reasoning, and so on—and observing students' responses to such tasks, teachers can gain valuable insights into how their students think and reason (e.g., diSessa, 2007). Teachers need not stick to traditional Piagetian reasoning tasks, however. On the contrary, the clinical method is applicable to a wide variety of academic domains and subject matter. To illustrate, a teacher might present various kinds of maps (e.g., a road map of Pennsylvania, an aerial map of Chicago, a three-dimensional relief map of a mountainous area) and ask students to interpret what they see. Children in the early elementary grades are apt to interpret many map symbols very concretely.



**Figure 12.6**  
Fishing picture used in Pulos and Linn (1981)  
Picture used with permission of Steven Pulos.

For instance, they might think that roads depicted in red are *actually* red. They might also have difficulty with the scale of a map, perhaps thinking that a line can't be a road because it's "not fat enough for two cars to go on" or that a mountain depicted by a bump on a relief map isn't really a mountain because "it's not high enough" (Liben & Myers, 2007, p. 202). Understanding the concept of *scale* of a map requires proportional reasoning—an ability that doesn't fully emerge until adolescence—and so it's hardly surprising that young children would be confused by it.

◆ *Piaget's stages can provide some guidance about when certain abilities are likely to emerge, but they shouldn't be taken too literally.* As we've seen, Piaget's four stages of cognitive development aren't always accurate descriptions of children's and adolescents' thinking capabilities. Nevertheless, they do provide a rough idea about the reasoning skills youngsters are likely to have at various ages (D. Kuhn, 1997; Metz, 1997). For example, preschool teachers shouldn't be surprised to hear young children arguing that the three pieces of a broken candy bar constitute more candy than a similar, unbroken bar—a belief that reflects lack of conservation. Elementary school teachers should recognize that their students are apt to have trouble with proportions (e.g., fractions, decimals) and with such abstract concepts as *historical time* in history and  $\pi$  ( $\pi$ ) in mathematics (Barton & Levstik, 1996; Byrnes, 1996; Tourniaire & Pulos, 1985). And educators and other professionals who work with adolescents should expect to hear passionate arguments that reflect idealistic yet unrealistic notions about how society should operate.

Piaget's stages also provide guidance about strategies that are likely to be effective in teaching children at different age levels. For instance, given the abstract nature of historical time, elementary school teachers planning history lessons should probably minimize the extent to which they talk about specific dates before the recent past (Barton & Levstik, 1996). Also, especially in the elementary grades—and to a lesser degree in middle and high school—instructors should find ways to make abstract ideas more concrete for students.

Yet teachers must remember that most reasoning skills probably emerge far more gradually than Piaget's stages suggest. For instance, students have some ability to think abstractly in elementary school but continue to have trouble with certain abstractions in high school, especially about topics they don't know much about. And they may be able to deal with simple proportions (e.g.,  $\frac{1}{2}$ ,  $\frac{1}{3}$ ) in the elementary grades and yet struggle with problems involving complex proportions (e.g.,  $\frac{15}{27} \div \frac{19}{33}$ ) in the middle and secondary school years.

◆ *Children can succeed in a particular domain only if they have mastered basic concepts and skills central to that domain.* Some basic forms of knowledge provide the foundation on which a great deal of subsequent learning depends. Examples include knowledge and skills related to counting (recall our discussion of a central conceptual structure for number) and locating objects accurately in two-dimensional space (recall the central conceptual structure for spatial relationships). If children come to school without such knowledge and skills, they may be on a path to long-term academic failure unless educators actively intervene.

For example, as noted earlier, a central conceptual structure for number seems to emerge in a wide variety of cultures. Yet Robbie Case and his colleagues have found that some children—perhaps because they've had little or no prior experience with numbers and counting—begin school without a sufficiently developed conceptual structure for number to enable normal progress in a typical mathematics curriculum. Explicit instruction in such activities as counting, connecting specific number words (e.g., “three,” “five”) with specific quantities of objects, and making judgments about relative number (e.g., “Since this set [•••] has more than this set [••], we can say that ‘three’ has more than ‘two’”) leads to improved performance not only in these tasks but in other quantitative tasks as well (Case & Okamoto, 1996; S. A. Griffin et al., 1995).

Another early and highly influential developmental psychologist, Lev Vygotsky, was quite vocal about the importance of explicit formal instruction for promoting children's learning and cognitive development. We turn to Vygotsky's ideas in the next chapter.

---

## SUMMARY

*Cognitive-developmental theories* focus on how thinking processes change, qualitatively, with age and experience. A classic cognitive-developmental theory is that of Swiss psychologist Jean Piaget, who conducted innumerable research studies beginning in 1920s and continuing through the 1970s. Piaget portrayed children as active and motivated learners who interact with and increasingly adapt to their physical and social worlds through two processes: *assimilation* (responding to and possibly interpreting an object or event in a

way that's consistent with an existing scheme) and *accommodation* (either modifying an existing scheme or forming a new one in order to deal with a new object or event). Piaget proposed that children's cognitive development is to some degree propelled by the process of *equilibration*: Children encounter situations for which their current knowledge and skills are inadequate (such situations create *disequilibrium*) and may be spurred to acquire new knowledge and skills that help return them to a state of *equilibrium*.

Piaget characterized cognitive development as proceeding through four stages: (1) the sensorimotor stage (when cognitive functioning is based primarily on behaviors and perceptions); (2) the preoperational stage (when symbolic thought and language become prevalent but reasoning is illogical by adult standards); (3) the concrete operations stage (when logical reasoning capabilities emerge but are limited to concrete objects and events); and (4) the formal operations stage (when thinking about abstract, hypothetical, and contrary-to-fact ideas becomes possible).

Developmental researchers have found that Piaget probably underestimated the capabilities of infants, preschoolers, and elementary school children and overestimated the capabilities of adolescents. Researchers have found, too, that children's reasoning on particular tasks depends somewhat on their prior knowledge, background experiences, and formal schooling relative to those tasks. The great majority of developmentalists now doubt that cognitive development can accurately be characterized as a series of general stages that pervade children's

thinking in diverse content domains. A few theorists, known as neo-Piagetians, propose that children acquire more specific systems of concepts and thinking skills relevant to particular domains and that these systems may change in a stagelike manner. Many others suggest that, instead, children exhibit gradual trends in a variety of abilities. However, virtually all contemporary theorists acknowledge the value of Piaget's research methods and his views about motivation, the construction of knowledge, and the appearance of qualitative changes in cognitive development.

Piaget's influence is seen in a number of contemporary educational practices. For example, the use of discovery learning and inquiry learning activities is consistent with the importance Piaget placed on hands-on activities for cognitive development. Classroom demonstrations of puzzling physical phenomena and discussions with peers about controversial issues can provoke disequilibrium, motivating children to acquire more advanced understandings. And Piaget's clinical method can yield numerous insights into children's reasoning processes.



# SOCIOCULTURAL THEORY AND OTHER CONTEXTUAL PERSPECTIVES

### *Vygotsky's Theory of Cognitive Development*

*Key Ideas in Vygotsky's Theory*

*Comparing Piaget's and Vygotsky's Theories*

### *Current Perspectives on Vygotsky's Theory*

*Social Construction of Meaning*

*Scaffolding*

*Participation in Adult Activities*

*Apprenticeships*

*Acquisition of Teaching Skills*

*Dynamic Assessment*

### *Adding a Sociocultural Element to Information*

*Processing Theory*

*Intersubjectivity*

### *Social Construction of Memory*

*Collaborative Use of Cognitive Strategies*

### *Expanding the Contextualist Framework*

*General Implications of Sociocultural and Contextualist Theorists*

### *Peer-Interactive Instructional Strategies*

*Class Discussions*

*Reciprocal Teaching*

*Cooperative Learning*

*Peer Tutoring*

*Communities of Learners*

*Technology-Based Collaborative Learning*

*Summary*

Much of our discussion so far has portrayed learning as an individual enterprise—as something that happens to and inside of a single learner. Yet human beings are, by nature, very social creatures, and a great deal of their learning involves interacting with and acquiring knowledge and skills from the people around them. For example, in virtually all cultures, the members of previous generations—parents, teachers, and so on—are largely responsible for helping growing children acquire the accumulated wisdom of their culture. In the 1920s and early 1930s, Russian developmental psychologist Lev Vygotsky suggested that society and culture provide a wide variety of concepts and strategies that children gradually begin to use in thinking about and dealing with everyday tasks and problems. Through his research and writings, Vygotsky laid much of the groundwork for a contextual view that has come to be known as **sociocultural theory**.

In this chapter, we'll look at key ideas in Vygotsky's theory and at current perspectives that have built on Vygotsky's work. As we do so, we'll find that learners' immediate environmental circumstances and supports can significantly enhance their thinking and learning. Later, as we explore other contextual perspectives, we'll find that human learning and cognition may be inextricably *bound* to learners' immediate environments—that many human thought processes have a *partly-in-the-head-and-partly-in-the-outside-world* quality to them. Finally, we'll consider the implications of sociocultural and other contextual perspectives for instructional practice.

## VYGOTSKY'S THEORY OF COGNITIVE DEVELOPMENT

---

As a Russian, Lev Vygotsky was deeply influenced by Karl Marx's proposal that changes in society over time have a significant impact on how people think and behave. And like Marx's colleague Friedrich Engels, Vygotsky saw much value in the use of *tools* for moving a society forward (M. Cole &

Scribner, 1978). In Vygotsky's mind, however, some of these tools are *cognitive* entities—concepts, theories, problem-solving strategies, and so on—rather than actual physical objects.

With the assistance of his students, Vygotsky conducted numerous studies of children's thinking from the 1920s until his early death from tuberculosis in 1934. In his major writings, he typically described his findings only in general terms, saving the details for technical reports he shared with the small number of research psychologists working in Russia at the time (Kozulin, 1986). But in his book *Thought and Language* he explained that his approach to studying children's cognitive development was radically different from that of Piaget and other psychologists of his era. Rather than determine the kinds of tasks children could successfully perform *on their own* (as Piaget did), he often examined the kinds of tasks children could complete *only with adult assistance*. For example, he described two hypothetical children who could, without help, do things that a typical 8-year-old might be able to do. He would give each of the children progressively more difficult tasks and offer some help, perhaps asking a leading question or suggesting a reasonable first step. With such assistance, both children could almost invariably tackle more difficult tasks than they could handle on their own. However, the *range* of tasks that the two children could complete with assistance might be quite different, with one child stretching his or her abilities to succeed at typical 12-year-old-level tasks and the other succeeding only with typical 9-year-old-level tasks (Vygotsky, 1934/1986).

Western psychologists were largely unfamiliar with Vygotsky's work until the last few decades of the twentieth century, when his major writings were translated from Russian into English (e.g., Vygotsky, 1978, 1934/1986, 1987a, 1997). Although Vygotsky never had the chance to develop his theory fully, his ideas are clearly evident in many contemporary theorists' discussions of learning and development today. In fact, while Piaget's influence has been on the wane in recent years (Bjorklund, 1997), Vygotsky's influence has become increasingly prominent.

## Key Ideas in Vygotsky's Theory

Vygotsky acknowledged that biological factors (e.g., neurological maturation) play a role in development. Children bring certain characteristics and dispositions to the situations they encounter, and their responses vary accordingly. Furthermore, children's behaviors, which are influenced in part by inherited traits, affect the particular experiences children have (Vygotsky, 1997). However, Vygotsky's primary focus was on the role of the environment—especially a child's social and cultural environment—in fostering cognitive growth. Following are central concepts and principles in Vygotsky's theory:

- ◆ *Some cognitive processes are seen in a variety of species; others are unique to human beings.* Vygotsky distinguished between two kinds of processes, or *functions*. Many species exhibit **lower mental functions**: certain basic ways of learning and responding to the environment—discovering what foods to eat, how best to get from one location to another, and so on. But human beings are unique in their use of **higher mental functions**: deliberate, focused cognitive processes that enhance learning, memory, and logical reasoning. In Vygotsky's view, the potential for acquiring lower mental functions is biologically built in, but society and culture are critical for the development of higher mental functions.

- ◆ *Through both informal conversations and formal schooling, adults convey to children the ways in which their culture interprets and responds to the world.* To promote higher mental functions, adults share with children the *meanings* they attach to objects, events, and, more generally, human

experience. In the process, they transform, or *mediate*, the situations children encounter. Meanings are conveyed through a variety of mechanisms, including language (spoken words, writing, etc.), mathematical symbols, art, music, and so on.

Informal conversations are one common method through which adults pass along culturally relevant ways of interpreting situations. But no less important in Vygotsky's eyes is formal education, in which teachers systematically impart the ideas, concepts, and terminology used in various academic disciplines. Although Vygotsky, like Piaget, saw value in allowing children to make some discoveries themselves, he also saw value in having adults pass along the discoveries of previous generations.

Increasingly, contemporary developmental psychologists are recognizing the many ways in which culture shapes children's cognitive development. A society's culture ensures that each new generation benefits from the wisdom that preceding generations have accumulated. It guides children in certain directions by encouraging them to pay attention to particular stimuli (and not to others) and to engage in particular activities (and not in others). And it provides a mental "lens" through which children come to construct culturally appropriate interpretations of their experiences.

◆ *Every culture passes along physical and cognitive tools that make daily living more effective and efficient.* Not only do adults teach children specific ways of interpreting experience but they also pass along specific tools that can help children tackle the various tasks and problems they're apt to face. Some tools, such as scissors, sewing machines, and computers, are physical objects. Others, such as writing systems, number systems, maps, and spreadsheets, involve symbols as well as physical entities. Still others, such as strategies for studying a textbook and mentally calculating change from a dollar, may have no physical basis at all. In Vygotsky's view, acquiring tools that are at least partly symbolic or mental in nature—**cognitive tools**—greatly enhances children's thinking abilities.<sup>1</sup>

Different cultures pass along different cognitive tools. Thus Vygotsky's theory leads us to expect considerable diversity in children's specific cognitive abilities as a result of their varying cultural backgrounds. For example, children are more likely to acquire map-reading skills if maps (perhaps of roads, subway systems, and shopping malls) are a prominent part of their community and family life (Liben & Myers, 2007). And children learn counting and arithmetic operations (e.g., addition, multiplication) only in cultures that have a precise number system—one that systematically assigns different symbols to different quantities (M. Cole, 2006; Pinker, 2007).

◆ *Thought and language become increasingly interdependent in the first few years of life.* One very important cognitive tool is language. For us as adults, thought and language are closely interconnected. We often think in terms of the specific words that our language provides; for example, when we think about household pets, words such as *dog* and *cat* are likely to pop up repeatedly in our heads. In addition, we usually express our thoughts when we converse with others; as we sometimes put it, we "speak our minds."

Vygotsky proposed that, in contrast to the state of affairs for adults, thought and language are distinctly separate functions for infants and young toddlers. In these early years of life, thinking occurs independently of language, and when language appears, it's first used primarily as a

---

<sup>1</sup>Human beings aren't the only species to use tools. For example, certain other primate species have also been observed using tools in their natural environments, as have crows (M. Cole & Hatano, 2007; Emery & Clayton, 2004).

means of communication rather than as a mechanism of thought. But sometime around age 2, thought and language become intertwined: Children begin to express their thoughts when they speak, and they begin to think in terms of words.<sup>2</sup>

When thought and language merge, young children often talk to themselves and in doing so may appear to be speaking in the “egocentric” manner Piaget described. In Vygotsky’s view, such **self-talk** (also known as *private speech*) plays an important role in cognitive development. By talking to themselves, children learn to guide and direct their own behaviors through difficult tasks and complex maneuvers in much the same way that adults have previously guided them. Self-talk eventually evolves into **inner speech**, in which children talk to themselves mentally rather than aloud. That is, they continue to direct themselves verbally through tasks and activities, but others can no longer see and hear them do it. Here we’re essentially talking about *self-regulation*—a concept we previously explored in Chapter 6 and will take up once again in Chapter 14.

Research has supported Vygotsky’s views regarding the progression and role of self-talk and inner speech. The frequency of children’s audible self-talk decreases during the preschool and early elementary years, but this decrease is at first accompanied by an increase in whispered mumbling and silent lip movements, presumably reflecting a transition to inner speech (Bivens & Berk, 1990; R. E. Owens, 1996; Winsler & Naglieri, 2003). Furthermore, self-talk increases when children are performing more challenging tasks, at which they must exert considerable effort to be successful (Berk, 1994; Schimmoeller, 1998; Vygotsky, 1934/1986). As you undoubtedly know from your own experience, even adults occasionally talk to themselves when they face new challenges.

◆ *Complex mental processes emerge out of social activities; as children develop, they gradually internalize the processes they use in social contexts and begin to use them independently.* Vygotsky proposed that higher mental functions have their roots in social interactions. As children discuss objects, events, tasks, and problems with adults and other knowledgeable individuals—often within the context of everyday cultural activities—they gradually incorporate into their own thinking the ways in which the people around them talk about and interpret the world, and they begin to use the words, concepts, symbols, and strategies—in essence, the cognitive tools—that are typical for their culture.

The process through which social activities evolve into internal mental activities is called **internalization**. The progression from self-talk to inner speech just described illustrates this process: Over time, children gradually internalize adults’ directions so that they’re eventually giving *themselves* directions.

Not all higher mental functions emerge through children’s interactions with adults, however. Some also develop as children interact with peers. For example, children frequently argue with one another about a variety of matters—how best to carry out an activity, what games to play, who did what to whom, and so on. According to Vygotsky, childhood arguments help children discover that there are often several points of view about the same situation. Eventually, Vygotsky suggested, children internalize the arguing process and acquire the ability to look at a situation from a variety of angles *on their own*.

---

<sup>2</sup>Vygotsky sometimes used the term *sign* in his discussion of words, numbers, and other symbols. In general, signs have little or no resemblance to the objects, events, or ideas they represent. (Why is a dog called a *dog*, rather than, say, a *snuffleupagus*?) In Vygotsky’s view, signs provide an important means of mediating children’s experiences and thereby facilitating effective thought processes.

♦ *Children appropriate their culture’s tools in their own idiosyncratic manner.* Children don’t necessarily internalize *exactly* what they see and hear in a social context. Rather, they often transform ideas, strategies, and other cognitive tools to suit their own needs and purposes—thus, Vygotsky’s theory has a constructivist element to it. The term **appropriation** refers to this process of internalizing but also adapting the ideas and strategies of one’s culture for one’s own use.

♦ *Children can accomplish more difficult tasks when they have the assistance of people more advanced and competent than themselves.* Vygotsky distinguished between two kinds of ability levels that characterize children’s skills at any particular point in development. A child’s **actual developmental level** is the upper limit of tasks that he or she can perform independently, without help from anyone else. A child’s **level of potential development** is the upper limit of tasks that he or she can perform with the assistance of a more competent individual. To get a true sense of children’s cognitive development, Vygotsky suggested, we should assess their capabilities both when performing alone *and* when performing with assistance.

Children can typically do more difficult things in collaboration with adults than they can do on their own. For instance, they can more quickly learn how to swing a tennis racket or baseball bat when an adult is initially present to guide their movements. They can play more difficult piano pieces when an adult helps them locate some of the notes on the keyboard or provides suggestions about which fingers to use where. They can solve more difficult math problems when their teacher helps them identify critical problem components and potentially fruitful problem-solving strategies. And they can often read more complex prose within a reading group at school than they’re likely to read independently at home.

♦ *Challenging tasks promote maximum cognitive growth.* The range of tasks that children can’t yet perform independently but *can* perform with the help and guidance of others is, in Vygotsky’s terminology, the **zone of proximal development (ZPD)** (see Figure 13.1). A child’s ZPD includes learning and problem-solving abilities that are just beginning to emerge and develop—abilities that are in an immature, “embryonic” form. Naturally, any child’s ZPD will change over time. As some tasks are mastered, more complex ones will appear to present new challenges.

Vygotsky proposed that children learn very little from performing tasks they can already do independently. Instead, they develop primarily by attempting tasks they can accomplish only in collaboration with a more competent individual—that is, when they attempt tasks within their zone of proximal development. In a nutshell, it’s the challenges in life, rather than the easy successes, that promote cognitive development.

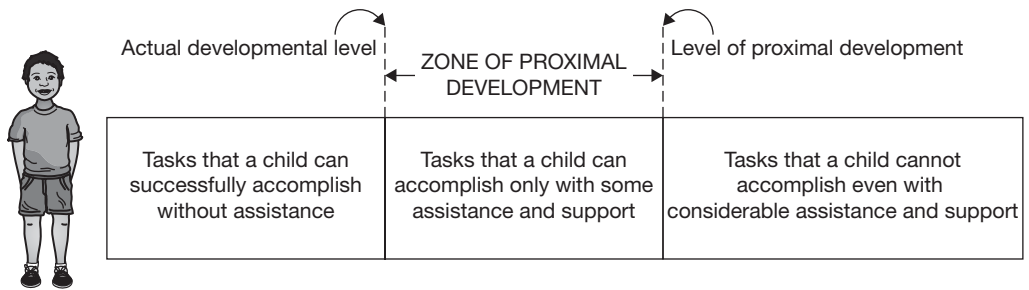

**Figure 13.1**  
 Tasks in a child’s zone of proximal development (ZPD) promote maximal learning and cognitive growth.

Whereas challenging tasks are beneficial, impossible tasks, which children can't do even with considerable structure and assistance, are of no benefit whatsoever (Vygotsky, 1987b). For example, it's pointless to ask a typical kindergartner to solve for  $x$  in an algebraic equation. In general, a child's ZPD sets a limit on what he or she is cognitively capable of learning.

♦ *Play allows children to cognitively “stretch” themselves.* When my son Jeff and his friend Scott were about 5 years old, they sometimes played “restaurant.” In a corner of our basement, the boys created a dining area from several child-sized tables and chairs, as well as a restaurant “kitchen” with a toy sink, stove, and supply of plastic dishes and food items. They also created menus, sometimes asking me how to spell a word but more often making an educated guess about a word's spelling. On one occasion they invited both sets of parents to “dine,” and when we arrived, they wrote our meal orders on paper tablets and scurried to the kitchen to assemble the requested items. Eventually they returned with our meals (hamburgers, French fries, and cookies—all of them plastic—plus glasses of imaginary milk), which we adults “ate” and “drank” with gusto.

In their restaurant play, the two boys took on several adult roles (restaurant manager, waiter, cook) and practiced a variety of adultlike behaviors. In real life such a scenario would, of course, be impossible: Very few 5-year-olds have the cooking, reading, writing, mathematical, or organizational skills necessary to run a restaurant. Yet the element of make-believe brought these tasks within the boys' reach. In Vygotsky's words, “In play a child always behaves beyond his average age, above his daily behavior; in play it is as though he were a head taller than himself” (Vygotsky, 1978, p. 102).

Furthermore, as children play, their behaviors must conform to certain standards or expectations. In the early elementary school years, children often act in accordance with how a father, teacher, or waiter would behave. In the organized group games and sports that come later, children must follow specific sets of rules. By adhering to such restrictions on their behavior, children learn to plan ahead, to think before they act, and to engage in self-restraint—skills critical for successful participation in the adult world (also see A. Diamond, Barnett, Thomas, & Munro, 2007; Pellegrini, 2009; Saracho & Spodek, 1998).

Play, then, is hardly a waste of time. Instead, it provides a valuable training ground for the adult world. Perhaps for this reason it's seen in children worldwide.

## Comparing Piaget's and Vygotsky's Theories

Piaget and Vygotsky both offered groundbreaking insights into the nature of children's learning and thinking, and both have had a profound influence on contemporary views of learning, cognition, and cognitive development. Their theories have some ideas in common that continue to appear in more contemporary views of cognitive development. Yet they also have important differences that have led modern researchers to probe more deeply into the mechanisms through which children's cognitive processes develop.

### ***Common Themes***

If we look beyond the very different terminology Piaget and Vygotsky used in their writings, four common themes emerge.

***Qualitative changes in the nature of thought*** Both Piaget and Vygotsky pointed out that children acquire more complex reasoning processes over time. Piaget described such development

in terms of four qualitatively different stages, whereas Vygotsky spoke in terms of the internalization of many different mental functions. Regardless of whose perspective we take, we come to the same conclusion: Children think differently at different ages.

**Challenge** We see the importance of challenge most clearly in Vygotsky's concept of the *zone of proximal development*: Children benefit most from tasks they can perform only with the assistance of more competent individuals. Yet challenge—albeit of a somewhat different sort—also lies at the heart of Piaget's theory: Children develop more sophisticated knowledge and thought processes only when they encounter phenomena they can't adequately understand using their existing schemes—in other words, phenomena that create *disequilibrium*.

**Readiness** According to both theories, any child will be cognitively ready for some experiences but not ready for others. From Piaget's perspective, children can accommodate to new objects and events only when some assimilation into existing schemes is also possible—that is, there must be some overlap between the “new” and the “old.” In addition, Piaget argued that children can't learn from an experience until they've begun the transition into a stage that allows them to deal with and conceptualize the experience appropriately.

Vygotsky, too, proposed that there are limits on the tasks children can reasonably handle at any particular time. As children acquire some capabilities, other, slightly more advanced ones begin to emerge, initially in an immature form. Children's newly forming abilities fall within their zone of proximal development and can be fostered through adult assistance and guidance. But still other abilities may be out of reach for the time being.

**Importance of social interaction** In Piaget's eyes, the people in a child's life can present information and arguments that create disequilibrium and foster greater perspective taking. For instance, when young children disagree with one another, they begin to realize that different people may have different yet equally valid viewpoints, and they gradually shed the egocentrism that characterizes the preoperational stage.

In Vygotsky's view, social interactions provide the very foundation for thought processes. Children gradually internalize processes they first use in collaboration with others until, ultimately, they can use these processes on their own. Furthermore, tasks within the ZPD can, by definition, be accomplished only when other people support children's efforts.

### **Key Theoretical Differences**

Following are four questions that capture significant differences between Piaget's and Vygotsky's theories.

**To what extent is language essential for learning and cognitive development?** According to Piaget, language provides verbal labels for many of the concepts and other schemes children have previously developed. Language is also the primary means through which children gain knowledge of other people's diverse perspectives on various situations and topics. In Piaget's view, however, much of cognitive development occurs independently of language.

For Vygotsky, language is absolutely critical for learning and cognitive development. Children's thought processes are internalized versions of social interactions that are largely verbal in nature. Through two language-based phenomena—self-talk and inner speech—children begin to guide their own behaviors in ways that others have previously guided them. Furthermore, in their conversations with adults, children learn the meanings that their culture ascribes to particular events and gradually begin to interpret the world in culture-appropriate ways.

The truth of the matter probably lies somewhere in the middle. Piaget clearly underestimated the importance of language: Children acquire more complex understandings of physical phenomena and events not only through their own interactions with the world but also (as Vygotsky suggested) by learning how others interpret those phenomena and events. On the other hand, Vygotsky may have overstated the case for language. Some concepts clearly emerge *before* children have verbal labels to attach to them (Fiedler, 2008; Halford & Andrews, 2006; Oakes & Rakison, 2003). Furthermore, verbal exchanges may be less important for cognitive development in some cultures than in others. For instance, adults in some rural communities in Guatemala and India place heavy emphasis on gestures and demonstrations, rather than on verbal instructions, to teach and guide children (Rogoff, Mistry, Göncü, & Mosier, 1993).

***What kinds of experiences promote learning and development?*** Piaget maintained that children's independent, self-motivated explorations of the physical world form the basis for many developing schemes, and children often construct these schemes with little or no guidance from others. In contrast, Vygotsky argued for activities that are facilitated and interpreted by more competent individuals. The distinction, then, is one of self-exploration versus guided exploration and instruction.

Children almost certainly benefit from both kinds of experiences—opportunities to manipulate and experiment with physical phenomena on their own and opportunities to draw from the wisdom of prior generations (Brainerd, 2003; Karpov & Haywood, 1998). For the most part, however, Vygotsky was probably more on target here. In general, young learners seem to gain more from hands-on, exploratory activities when knowledgeable adults guide their efforts and help them interpret their findings (see the discussion of discovery learning and inquiry learning in Chapter 12). Furthermore, *perception* of the physical world may be more important than actual physical manipulation of it. As noted in Chapter 12, children with significant physical disabilities often make major cognitive advancements despite limited hands-on experiences with physical objects (Bebko, Burke, Craven, & Sarlo, 1992). In one way or another, however, children must have some sort of experience with the physical world—encounters with various physical phenomena (e.g., pressure, inertia, oscillation), exposure to cause-and-effect relationships, and so on—if they are to get a good sense of how it operates.

***What kinds of social interactions are most valuable?*** Both theorists saw value in interacting with people of all ages. However, Piaget emphasized the benefits of interactions with peers (who could create conflict), whereas Vygotsky placed greater importance on interactions with adults and other more advanced individuals (who could support children in challenging tasks and help them make appropriate interpretations).

To some degree, interactions with peers and interactions with adults may play different roles in children's cognitive development. When children's development requires them to abandon old perspectives in favor of new, more complex ones, the sociocultural conflict that often occurs among age-mates—as well as the multiple perspectives that emerge from it—might be optimal for bringing about such change. But when children's development instead requires that they learn new skills, the thoughtful, patient guidance of a competent adult is often more beneficial (Gauvain, 2001; Radziszewska & Rogoff, 1991; Rogoff, 1991; Webb & Palincsar, 1996).

***How influential is culture?*** Piaget really didn't address the role that culture plays in development, whereas in Vygotsky's view, culture is of paramount importance in determining the specific thinking skills children acquire. Once again, Vygotsky appears to have been more on



target. For example, as we noted in Chapter 12, children's reasoning skills don't necessarily appear at the same ages in different cultures. In fact, some reasoning processes—especially those involving formal operational thinking skills—may never appear at all.

We must keep in mind, however, that there isn't necessarily a single "best" or "right" way for a culture to promote cognitive development (Rogoff, 2003). Despite their diverse child-rearing techniques and instructional practices, virtually all of the world's cultures have developed myriad strategies for helping growing children acquire the knowledge and skills they'll need to be successful adult participants in their local society.

Obviously, then, neither Piaget nor Vygotsky was completely right or completely wrong. In fact, Piaget's and Vygotsky's theories complement each other to some degree, with the former helping us understand how children often reason on their own and the latter providing ideas about how adults can help them reason more effectively.

## CURRENT PERSPECTIVES ON VYGOTSKY'S THEORY

---

Vygotsky focused more on the processes through which children develop than on the characteristics that children of particular ages are likely to exhibit. He did identify stages of development but portrayed them in only the most general terms (e.g., see Vygotsky, 1997, pp. 214–216). In addition, Vygotsky's descriptions of developmental processes were often vague and speculative (Gauvain, 2001; Haenen, 1996; Moran & John-Steiner, 2003; Wertsch, 1984). For such reasons, Vygotsky's theory has been more difficult for researchers to test and either verify or disprove than has the case for Piaget's theory.

Despite such weaknesses, many contemporary theorists and practitioners have found Vygotsky's ideas both insightful and helpful. Although they've taken Vygotsky's notions in many directions, we can discuss much of their work within the context of several general ideas: social construction of meaning, scaffolding, participation in adult activities, apprenticeships, acquisition of teaching skills, and dynamic assessment.

### Social Construction of Meaning

Some contemporary theorists have elaborated on Vygotsky's proposal that adults help children attach meaning to the objects and events around them. Oftentimes an adult will help a child make sense of the world through a discussion of a phenomenon or event that the two of them are simultaneously experiencing (Crowley & Jacobs, 2002; Eacott, 1999; Fivush, Haden, & Reese, 2006; John-Steiner & Mahn, 1996). Such an interaction, sometimes called a **mediated learning experience**, encourages the child to think about the phenomenon or event in particular ways—to attach labels to it, recognize principles that underlie it, draw certain conclusions from it, and so on. As an example, consider the following exchange, in which a 5-year-old boy and his mother are talking about a prehistoric animal exhibit at a natural history museum:

- Boy: Cool. Wow, look. Look giant teeth. Mom, look at his giant teeth.  
 Mom: He looks like a saber tooth. Do you think he eats meat or plants?  
 Boy: Mom, look at his giant little tooth, look at his teeth in his mouth, so big.  
 Mom: He looks like a saber tooth, doesn't he? Do you think he eats plants or meat?

- Boy: Ouch, ouch, ouch, ouch. (referring to sharp tooth)  
 Mom: Do you think he eats plants or meat?  
 Boy: Meat.  
 Mom: How come?  
 Boy: Because he has sharp teeth. (Growling noises) (D. Ash, 2002, p. 378)

Even without his mother's assistance, the boy would almost certainly have learned something about saber tooth tigers from his museum visit. Yet Mom has helped her son make better sense of his experience than he might have done on his own—for instance by using the label *saber tooth* and helping him connect tooth characteristics to eating preferences. Notice how persistent Mom is in asking her son to make the tooth–food connection: She continues to ask her question about meat versus plants until finally the boy correctly infers that saber teeth must have been meat eaters.

In addition to co-constructing meanings with adults, children often talk among themselves to make sense of phenomena. Not only might peer-group discussions provoke the *sociocognitive conflict* described in Chapter 12 but they can also help children make better sense of a situation than any one of them could make individually—a phenomenon consistent with the *social constructivist* perspective I described in Chapter 7. As an example of how students in a classroom might work together to construct meaning, let's consider a discussion in Keisha Coleman's third-grade class. The students are debating how they might solve the problem  $-10 + 10 = ?$ . They're using a number line like the following to facilitate their discussion.



Several students, including Tessa, agree that the solution is “zero” but disagree about how to use the number line to arrive at the answer. Excerpts from a discussion between Tessa and her classmate Chang (as facilitated by Ms. Coleman) follow:

- Tessa: You have to count numbers to the right. If you count numbers to the right, then you couldn't get to zero. You'd have to count to the left.  
 [Ms. Coleman]: Could you explain a little bit more about what you mean by that? I'm not quite sure I follow you. . . .  
 Tessa: Because if you went that way [points to the right] then it would have to be a higher number. . . .  
 Chang: I disagree with what she's trying to say. . . . Tessa says if you're counting right, then the number is—I don't really understand. She said, “If you count right, then the number has to go smaller.” I don't know what she's talking about. Negative ten plus ten is zero. . . . What do you mean by counting to the right?  
 Tessa: If you count from ten up, you can't get zero. If you count from ten left, you can get zero.  
 Chang: Well, negative ten is a negative number—smaller than zero.  
 Tessa: I know.  
 Chang: Then why do you say you can't get to zero when you're adding to negative ten, which is smaller than zero?  
 Tessa: OHHHH! NOW I GET IT! This is positive. . . . You have to count right.  
 [Ms. Coleman]: You're saying in order to get to zero, you have to count to the right? From where, Tessa?  
 Tessa: Negative 10. (P. L. Peterson, 1992, pp. 165–166)

The class continues in its efforts to pin down precisely how to use the number line to solve the problem. Eventually, Tessa offers a revised and more complete explanation. Pointing to the appropriate location on the number line, she says, “You start at negative 10. Then you add 1, 2, 3, 4, 5, 6, 7, 8, 9, 10.” She moves her finger one number to the right for each number she counts. She reaches the zero point on the number line when she counts “10” and concludes, “That equals zero” (P. L. Peterson, 1992, p. 168).

## Scaffolding

Recall Vygotsky’s suggestion that children are most likely to benefit from tasks and activities they can successfully accomplish only with the assistance and support of more competent individuals—that is, tasks within their zone of proximal development. Contemporary theorists have identified a variety of supportive techniques—collectively known as **scaffolding**—that can help students accomplish challenging tasks in instructional contexts. One effective technique is to ask questions that get students thinking in appropriate ways about a task, as illustrated in the following dialogue:

- Teacher: [writes  $6\overline{)44}$  on the board] 44 divided by 6. What number times 6 is close to 44?  
 Child: 6.  
 Teacher: What’s 6 times 6? [writes 6]  
 Child: 36.  
 Teacher: 36. Can you get one that’s any closer? [erasing the 6]  
 Child: 8.  
 Teacher: What’s 6 times 8?  
 Child: 64 . . . 48.  
 Teacher: 48. Too big. Can you think of something . . .  
 Child: 6 times 7 is 42. (Pettito, 1985, p. 251)

Scaffolding can take a variety of forms. Following are just a few of the many possibilities:

- Model the correct performance of a task.
  - Divide a complex task into several smaller, simpler activities.
  - Provide a structure or set of guidelines for accomplishing the task.
  - Provide a calculator, computer software (word processing program, spreadsheet, etc.), or other technology that makes some aspects of the task easier.
  - Keep the learner’s attention focused on the relevant aspects of the task.
  - Ask questions that get the learner thinking about the task in productive ways.
  - Give frequent feedback about how the learner is progressing.
- (A. Collins, 2006; Gallimore & Tharp, 1990; Rogoff, 1990; D. Wood, Bruner, & Ross, 1976)

Depending on their particular knowledge and ability levels, different learners at any single age or grade level may need different kinds of scaffolding to support their success (Lodewyk & Winne, 2005; Puntambekar & Hübscher, 2005; Rittle-Johnson & Koedinger, 2005). As learners become more adept at performing a new task, their scaffolding is gradually phased out so that they eventually accomplish it entirely on their own. In fact, providing *too much* scaffolding—more than a learner needs—can be unnecessarily distracting (van Merriënboer & Sweller, 2005).

Scaffolding in its various forms can be highly effective in helping learners acquire complex reasoning, metacognitive, and problem-solving skills. Accordingly, we’ll revisit this concept in Chapters 14 and Chapter 15.

## Participation in Adult Activities

Virtually all cultures allow children—and in fact usually require them—to be involved in adult activities to some degree. Children’s early experiences are often at the fringe of an activity, and their involvement is mediated, scaffolded, and supervised through what is sometimes called **guided participation** (Rogoff, 2003). From a Vygotskian perspective, gradual entry into adult activities increases the probability that children will engage in behaviors and thinking skills within their zone of proximal development. It also helps children tie newly acquired skills and thinking abilities to the specific contexts in which those skills and abilities are apt to be useful later on. As children acquire greater competence, they gradually take a more central role in a particular activity until, eventually, they are full-fledged participants (Gaskins, 1999; Lave & Wenger, 1991; Light & Butterworth, 1993; Rogoff et al., 2007).

Even for adults, entry into new activities is often a gradual process (Wenger, 1998). Imagine, for example, that you take a job at a large insurance company. You’ve never worked in the insurance business before, and so you have a lot to learn about what insurance contracts entail. But you also have to learn how your company operates—which people take responsibility for which tasks, what forms should be completed in different situations, where you can get answers to various questions, and so on. Little by little, the old-timers in your company will help you master everything you need to know, and eventually you yourself will become an old-timer who assists newcomers to the firm (Wenger, 1998).

## Apprenticeships

An especially intensive form of guided participation is an **apprenticeship**, in which a novice works with an expert mentor for a lengthy period to learn how to perform complex tasks within a particular domain.<sup>3</sup> The mentor provides considerable structure and guidance throughout the process, gradually removing scaffolding and giving the novice more responsibility as competence increases (A. Collins, 2006; Rogoff, 1990, 1991). Many cultures use apprenticeships as a way of teaching children particular skills and trades in the adult community—perhaps weaving, tailoring, or midwifery (Lave, 1991; Lave & Wenger, 1991; Rogoff, 1990). We also see apprenticeships frequently in music instruction—for instance, in teaching a student how to play a musical instrument (D. J. Elliott, 1995).

In an apprenticeship, a person learns not only the behaviors but also the language of a skill or trade (Lave & Wenger, 1991). For example, when master weavers teach apprentices their art, they might use such terms as *warp*, *weft*, and *harness* to focus attention on a particular aspect of the process. Similarly, when teachers guide students through scientific experiments, they use words like *hypothesis*, *evidence*, and *theory* to help the students evaluate their procedures and results (Perkins, 1992).

Furthermore, an apprenticeship can show novices how experts typically *think* about a task or activity—a situation known as a **cognitive apprenticeship** (J. S. Brown et al., 1989; A. Collins, 2006;

---

<sup>3</sup>Some theorists prefer the term *legitimate peripheral participation*, which communicates the idea that a learner is authentically involved in an activity but not initially taking charge of it (A. Collins, 2006; Lave & Wenger, 1991).

A. Collins, Brown, & Newman, 1989; Dennen & Burner, 2008). An example is the relationship between a university professor and a graduate student (W. Roth & Bowen, 1995). For instance, I used to teach a doctoral seminar called *Cognition and Instruction*, in which I assigned a gigantic collection of outside readings (the required articles and book chapters stacked up to a pile about 2 feet high). As a class we spent 2 or 3 hours over the course of the semester talking about how to read such a large amount of material productively. I shared such strategies as skimming, reading with particular goals in mind, and relating one theorist's perspective to another's, and I provided a list of focus questions that students should try to answer as they read. Students were also required to complete a major research project by the end of the semester; I met with each of them periodically to help them narrow down their topic, identify fruitful directions to pursue, organize their thoughts, and consider possible conclusions.

Although apprenticeships can differ widely from one context to another, they typically have some or all of the following features (A. Collins, 2006; A. Collins et al., 1989):

- *Modeling*: The mentor carries out the task, simultaneously thinking aloud about the process, while the learner observes and listens.
- *Coaching*: As the learner performs the task, the mentor gives frequent suggestions, hints, and feedback.
- *Scaffolding*: The mentor provides various forms of support for the learner, perhaps by simplifying the task, breaking it into smaller and more manageable components, or providing less complicated equipment.
- *Articulation*: The learner explains what he or she is doing and why, allowing the mentor to examine the student's knowledge, reasoning, and problem-solving strategies.
- *Reflection*: The mentor asks the learner to compare his or her performance with that of experts, or perhaps with an ideal model of how the task should be done.
- *Increasing complexity and diversity of tasks*: As the learner gains greater proficiency, the mentor presents more complex, challenging, and varied tasks to complete.
- *Exploration*: The mentor encourages the learner to frame questions and problems on his or her own, and in doing so to expand and refine acquired skills.

Apprenticeships are clearly labor intensive; as such, their use in the classroom isn't always practical or logistically feasible (De Corte, Greer, & Verschaffel, 1996). At the same time, teachers can certainly use elements of an apprenticeship model to help their students develop more complex skills. For example, prompts such as the following help students think about writing tasks in the same ways that expert writers do (Scardamalia & Bereiter, 1985):

- "My purpose . . ."
- "My main point . . ."
- "An example of this . . ."
- "The reason I think so . . ."
- "To liven this up I'll . . ."
- "This isn't very convincing because . . ."
- "I can tie this together by . . ."

Such prompts provide the same sort of scaffolding that an expert writer might provide, and they help students develop more sophisticated writing strategies (S. L. Benton, 1997; Scardamalia & Bereiter, 1985; Wong, Hoskyn, Jai, Ellis, & Watson, 2008).

## Acquisition of Teaching Skills

As children acquire new information and skills from more experienced members of their community, they may also begin to teach their new knowledge to others (Gauvain, 2001). With age and experience, they become increasingly adept at teaching others what they've learned. Let's look at an example involving the game of Monopoly. Four 8-year-old girls are playing the game while a researcher videotapes their interactions (Guberman, Rahm, & Menk, 1998). One girl, Carla, has limited math skills and little experience playing the game. On her first turn, she lands on Connecticut Avenue:

- Nancy: Do you want to buy it?  
 Carla: Hmmmm . . . [There is a long pause and some unrelated discussion among the players.]  
 How much is it again? Twelve hundred . . .  
 Nancy: A hundred and twenty dollars.  
 Carla: A hundred and twenty [She starts to count her money] . . . a hundred [She is referring to a \$10 bill] . . .  
 Sarah: You give her one of these and one of these. [She holds up first a \$100 bill and then a \$20 bill of her own money.] (Guberman et al., 1998, p. 436; format adapted)

Notice how Nancy and Sarah scaffold Carla's initial purchase. Nancy asks her to consider buying the property and tells her the purchase price. When it's clear that Carla is having trouble counting out \$120 (she thinks a \$10 bill is worth \$100), Sarah gives her sufficient guidance that she can identify the needed bills by color alone. As Carla becomes more competent later in the game, the other girls reduce their support. For instance, at one point Carla lands on Virginia Avenue, with a purchase price of \$160:

Carla hesitates making the payment, looking through her money. Eventually, she takes a \$100 bill from her money and appears unsure how to continue.

Nancy: Just a fifty and a ten.

Carla gives a \$50 bill and a \$10 bill to the banker. (Guberman et al., 1998, p. 437; format adapted)

When children and adults teach others, the "teachers" often benefit as much as the "students" (D. Fuchs, Fuchs, Mathes, & Simmons, 1997; Inglis & Biemiller, 1997; D. R. Robinson, Schofield, & Steers-Wentzell, 2005; Webb & Palincsar, 1996). For instance, when students study something with the expectation that they'll be teaching it to someone else, they're more motivated to learn it, find it more interesting, and elaborate on it (Benware & Deci, 1984; O'Donnell, 2006; Roscoe & Chi, 2007; Semb, Ellis, & Araujo, 1993). Furthermore, when children who are relatively weak in a particular skill (compared to their age-mates) have the opportunity to guide younger children in that skill, they develop greater ability to guide themselves as well, presumably because they internalize the directions they've been giving someone else (Biemiller, Shany, Inglis, & Meichenbaum, 1998).

## Dynamic Assessment

As noted earlier, Vygotsky believed that we can get a more complete picture of children's cognitive development if we assess both their *actual developmental level* (the upper limit of tasks they can successfully accomplish on their own) and their *level of potential development* (the upper limit

of tasks they can accomplish when they have the assistance of more competent individuals). When assessing children's cognitive abilities, however, most teachers focus almost exclusively on *actual* developmental level: They ask children to take tests, complete assignments, and so on, without help from anyone else. To assess children's level of potential development, some theorists have suggested an alternative known as **dynamic assessment**, which involves (1) identifying tasks that children cannot initially do independently, (2) providing in-depth instruction and practice in behaviors and cognitive processes related to the task, and then (3) determining the extent to which each child has benefited from the instruction (Feuerstein, 1979, 1980; Haywood & Lidz, 2007; Kozulin & Falik, 1995; Lidz & Gindis, 2003; Tzuriel, 2000).

Dynamic assessment often yields more optimistic evaluations of children's cognitive capabilities than traditional measures of cognitive ability and can be especially useful in assessing the abilities of children from diverse cultural backgrounds. In addition, it can yield a rich body of qualitative information about how children approach a new learning task (L. S. Fuchs et al., 2008; Haywood & Lidz, 2007; Swanson & Lussier, 2001; Tzuriel, 2000).

## ADDING A SOCIOCULTURAL ELEMENT TO INFORMATION PROCESSING THEORY

---

In Chapter 7, I briefly got on my soapbox and argued that an integration of theoretical perspectives can often yield a more complete understanding of human learning than any single theory can yield alone. Consistent with this view, some theorists have found it productive to integrate elements of information processing theory and sociocultural theory. In particular, they suggest, information processing theory may tell us a great deal about *what* changes over time, and sociocultural views (notions about mediated learning experiences, guided participation, and the like) may help us explain *how* those changes occur (Gauvain, 2001; Greeno, 2006; Leach & Scott, 2008; P. A. Ornstein & Haden, 2001).

Here we look at this blend of information processing and sociocultural approaches in three areas: intersubjectivity, social construction of memory, and collaborative use of cognitive strategies.

### Intersubjectivity

For two people to interact and communicate, they must have shared understandings on which to build. For instance, each member of the pair should have some awareness of what the other person sees, knows, thinks, and feels. Such mutual understanding is known as **intersubjectivity** (Newson & Newson, 1975; Rommetveit, 1985; Trevarthen, 1980). The beginnings of intersubjectivity are seen at about 2 months of age, when infants and their caregivers focus on and interact with each other, making eye contact, exchanging smiles, taking turns vocalizing, and so on (Adamson & McArthur, 1995; Kingstone, Smilek, Ristic, Friesen, & Eastwood, 2003).

Sometime around 9 or 10 months of age—possibly even earlier—intersubjectivity becomes more complex, taking the form of **joint attention**. At this point, an infant and caregiver can focus on a single object, with both members of the pair monitoring the *other's* attention to the object and coordinating their behaviors toward the object (Adamson & McArthur, 1995; M. Carpenter, Nagell, & Tomasello, 1998; Mundy & Newell, 2007; Trevarthen & Hubley, 1978).

Early in the second year, infants also begin to show **social referencing**, looking at someone else for clues about how to respond to or feel about a particular object or event (Feinman, 1992; Klinnert, Emde, Butterfield, & Campos, 1986; L. Murray et al., 2008; S. R. Nichols, Svetlova, & Brownell, 2010). Children are most likely to engage in social referencing when they encounter a new and uncertain situation. For example, in one study (Klinnert, 1984), 1- and 1½-year-old infants were shown three new toys to which their mothers had been instructed to respond with a happy, fearful, or neutral expression. Upon seeing each new toy, most infants looked at their mother and chose actions consistent with her response. They typically moved toward the toy if Mom showed pleasure but moved away from it if she showed fear.

As information processing theorists tell us, attention is critical to learning and cognitive development. As we bring the sociocultural perspective into the picture, we see that awareness of a *partner's* attention is critical as well. For instance, when an adult uses a word that an 18-month-old toddler has never heard before, the toddler will often look immediately at the speaker's face and follow the speaker's line of vision to the object being referenced. In this way, children probably learn many object labels (D. A. Baldwin, 2000; Golinkoff & Hirsh-Pasek, 2006). In general, a child can learn from a person with more experience only if both people are focusing on the same thing and *know* that they're sharing their focus. Because intersubjectivity is so critical for children's ability to learn from more experienced members of their community, it appears to be a universal phenomenon across cultures (Adamson & Bakeman, 1991).

## Social Construction of Memory

In the section "Social Construction of Meaning" earlier in the chapter, we saw how adults often help children construct meaning from events they're jointly experiencing. An adult can also help a child reconstruct events that the two of them have *previously* experienced and stored in their respective long-term memories. Almost as soon as children are old enough to talk, their parents begin to engage them in conversations about past events, helping them construct the *narratives* I spoke of in Chapter 11 (Fivush et al., 2006; Gauvain, 2001; P. J. Miller, Fung, & Koven, 2007; Ratner, 1984). As an example, consider the following dialogue, in which 6-year-old Kerry and her mother talk about a recent whale-watching expedition:

- Mother: And we went with, who'd we go with?  
 Kerry: David.  
 Mother: David. Who else?  
 Kerry: And Nana and Papa.  
 Mother: And who else? Daddy went too, didn't he?  
 Kerry: Yeah.  
 Mother: Yeah. Who else?  
 Kerry: That's all.  
 Mother: Oh, and Auntie Karen and Uncle Pete, right?  
 Kerry: Yeah.  
 Mother: And David's two brothers.  
 Kerry: Mhm.  
 Mother: We went whale watching and um I think it turned out to be a disaster because it was rough out there and we got kind of seasick. We did see whales, but not as good as we wanted to.  
 Kerry: I saw one.



- Mother: Yeah, we saw them. They're big, huh?  
 Kerry: [Nods.]  
 Mother: How many were there?  
 Kerry: About thirteen.  
 Mother: About thirteen! There were only two or three!  
 Kerry: No, there wasn't, because they were runnin' back and forth like fifty times! (Hemphill & Snow, 1996, p. 182)

Such discussions, sometimes called **co-constructed narratives**, can help children make better sense of an event and perhaps apply labels to it (e.g., *whale watching*, *seasick*). By doing these things, children encode and so remember the event more effectively.

As we discovered in Chapter 11, talking about an event can occasionally lead to a distorted memory for it, especially if children are led to “recall” things that didn't actually happen. But as a general rule, conversations about past events are quite productive and have several benefits (Fivush et al., 2006; Gauvain, 2001; K. Nelson, 1996). First, as noted in the discussion of *verbalization* in Chapter 9, children can better encode (and so better remember) the things they talk about. Second, because adults focus on certain aspects of events and not others, children learn what things are important to remember. Third, because adults are likely to interpret events in particular ways (e.g., finding some things amusing and others things distasteful), children acquire perspectives and values appropriate for their culture. For example, when European American mothers recall past events with their 3-year-olds, they often speculate about the thoughts and feelings of the participants. In contrast, Asian mothers are more likely to talk about social norms and expectations, such as what someone should have done instead. Such differences are consistent with the priorities and values of these cultures (MacDonald, Uesiliana, & Hayne, 2000; Mullen & Yi, 1995; Q. Wang & Ross, 2007).

In some cases, talking about an event after it has transpired enhances memory even more than talking about it at the time it's happening (McGuigan & Salmon, 2004). Perhaps the delay in discussion gives children a chance to store and consolidate certain aspects of the event on their own, with the postevent discussion offering a chance to retrieve and review—and hence better remember—the experience (McGuigan & Salmon, 2004).

## Collaborative Use of Cognitive Strategies

In discussions of cognitivist ideas in previous chapters, I've occasionally talked about mental processes as *strategies*—encoding strategies, study strategies, self-regulation strategies, and so on. Some cognitive processes are in fact quite strategic, in that people intentionally use them to accomplish certain goals. Sometimes children develop these strategies on their own. On other occasions they learn effective strategies by modeling how adults or peers approach subject matter (recall the discussion of *cognitive modeling* in Chapter 6). A combination of information processing theory and sociocultural theory gives us a third alternative: Adults can engage children in activities that require collaborative use of particular strategies. Through joint discussion and use of strategies—typically with considerable adult guidance and scaffolding at first—children gradually internalize the strategies and begin using them independently (Freund, 1990; Gauvain, 1999, 2001).

As an example of the last approach, let's consider a study by Radziszewska and Rogoff (1988) in which 9- and 10-year-old children each worked with either a parent or a peer to plan a shopping trip that would involve stops at numerous locations. Each pair was asked to imagine that

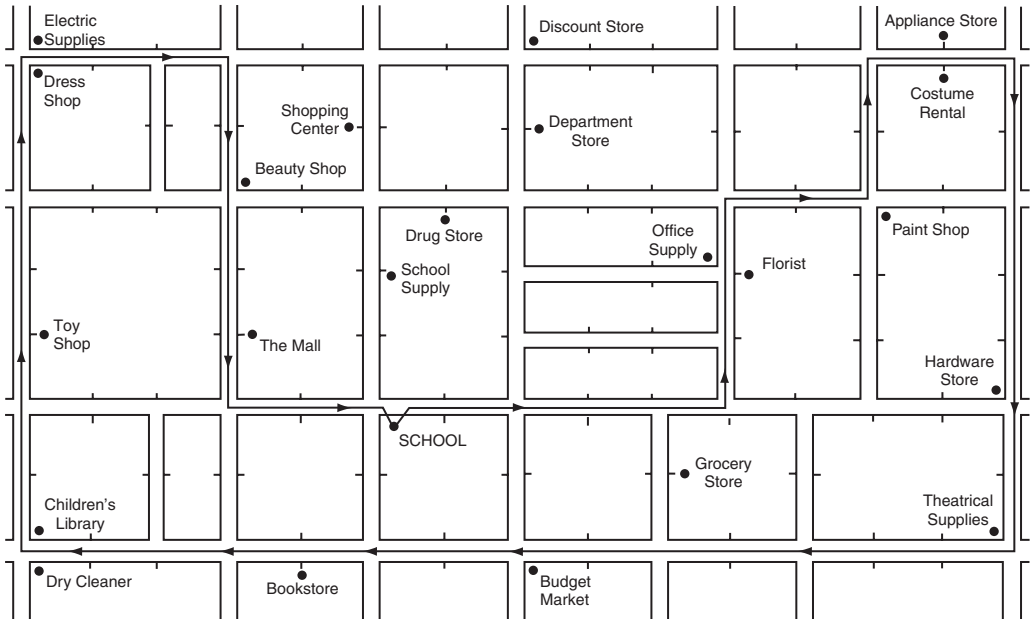

**Figure 13.2**

The imaginary town map used by Radziszewska and Rogoff (1988)

Reprinted from "Influence of Adult and Peer Collaborators on Children's Planning Skills" by B. Radziszewska & B. Rogoff, 1988, *Developmental Psychology*, 24, p. 842. Copyright 1988 by the American Psychological Association. Reprinted with permission.

they needed to go on a shopping trip to get materials for a school play (masks, costumes, etc.). They were given a shopping list of 10 items and an imaginary town map (see Figure 13.2) and instructed to identify the shortest possible route (beginning and ending at school) by which they could obtain all 10 items. Child–parent and child–peer pairs alike were able to plot a course that would enable them to get the needed items, but on average, the child–parent pairs identified shorter routes (the route marked in Figure 13.2 is an example of a good route). Furthermore, the parents provided more strategic guidance and engaged the children in more collaborative decision making than the children's age-mates did. After two planning sessions with a partner, the children were asked to plan a third trip, this time independently. Those who had previously worked with a parent identified shorter, more efficient routes than those who had worked with a peer.

## EXPANDING THE CONTEXTUALIST FRAMEWORK

So far, much of the discussion in this chapter has focused on how a learner's social context affects learning and cognitive development. Increasingly, some theorists have been arguing that learning is inextricably *bound* to its context. They use a variety of terms for this perspective—for example, *situated learning*, *distributed cognition*, and *embodiment*. Theorists' meanings for the different terms seem to overlap a bit with one another and with aspects of sociocultural theory and social constructivism

(e.g., Greeno, 2006; Markus & Hamedani, 2007; Robbins & Aydede, 2009b; Vosniadou, 2007). However, I'm going to go out on a limb here and try to tease apart what appear to me to be subtle differences in uses of the various terminologies.

First, some cognitive theorists propose that a good deal of learning and thinking is context specific—that is, it's "situated" in the environment in which it initially or typically takes place, and the skills developed in that environment won't necessarily be used in other, very different contexts. This state of affairs is often referred to as **situated learning** or **situated cognition** (e.g., J. S. Brown, Collins, & Duguid, 1989; Greeno, 2006; Kirsh, 2009; Lave & Wenger, 1991; Robbins & Aydede, 2009a). For example, children who sell candy, gum, and other items on the street may readily use basic math procedures when calculating total prices or computing change for a customer and yet not apply the same procedures in classroom math lessons (Carraher, Carraher, & Schliemann, 1985; Schliemann & Carraher, 1993). Likewise, carpenters may learn and use concepts such as *parallel* and *perpendicular* within the context of carpentry yet not realize that these concepts are applicable to other, noncarpentry situations (Millroy, 1991).

Second, people can often think and learn more effectively when they offload some of the cognitive burden onto something or someone else—an idea that's sometimes referred to as **distributed cognition** or **distributed intelligence** (e.g., T. Martin, 2009; Pea, 1993; Salomon, 1993; E. R. Smith & Conrey, 2009). Learners can "distribute" a challenging task—that is, they can offload parts of it—in at least three ways. First, they can use physical objects, especially technology (e.g., calculators, computers), to handle and manipulate large amounts of information. Second, they can mentally encode and manipulate the situations they encounter using various symbolic systems—words, charts, diagrams, mathematical equations, and so on—and other cognitive tools their culture provides. And third, they can work with other people to explore ideas and solve problems. When learners work together on complex, challenging tasks and problems, they often think more intelligently than any one of them could think alone. In fact, they sometimes teach one another strategies and ways of thinking that can help each of them think even *more* intelligently on future occasions (Applebee, Langer, Nystrand, & Gamoran, 2003; A.-M. Clark et al., 2003; Salomon, 1993; Spörer & Brunstein, 2009).

Finally, in some instances, cognition is intimately and inextricably intertwined with one's immediate physical context and bodily reactions to it—a phenomenon that some theorists call **embodiment** (e.g., Mareschal et al., 2007; Marshall, 2009; Prinz, 2009; Spunt, Falk, & Lieberman, 2010). For example, when we think about throwing a baseball, we activate those parts of the brain that control the arm and hand muscles involved in throwing—even if we aren't actually moving those muscles (Spunt et al., 2010). And when we read a book, we don't take in and remember everything on the page; instead, our eyes flit from spot to spot, taking in various bits and pieces as we need them to construct meaning from what we're reading (Mareschal et al., 2007; Myin & O'Regan, 2009; also recall the discussion of *saccades* in Chapter 9). The idea of embodiment became very real to me personally during a recent bout with carpal tunnel syndrome—a condition that left me unable to use my computer for any substantial writing projects for a month or so. When I whined about the fact that I couldn't work, several friends suggested that I use voice recognition software, thereby having a computer translate my spoken words into written text. My reply was always the same: "I think with my fingers." What I meant was that I type as I think—I long ago developed automaticity for my keyboarding skills—and thus, in a very real sense (to me, at least), my thinking and writing are inextricably tied to my computer. It helps, too, that I have a very large computer screen—one that greatly expands my (virtual) working memory capacity.

All of these (admittedly overlapping) perspectives lead to the same general conclusion: The contexts in which human beings live and learn have an *enormous* effect on their thinking and short- and long-term productivity.

## GENERAL IMPLICATIONS OF SOCIOCULTURAL AND OTHER CONTEXTUALIST THEORIES

---

Vygotsky's theory and the contemporary theoretical perspectives his work has inspired have numerous implications for instructional practice. Following are examples:

- ◆ *Learners can think more effectively when they acquire the basic cognitive tools of various activities and academic disciplines.* Virtually every activity in our society involves certain concepts and ways of thinking, and mastering them enables people of all ages to engage more successfully in the activity (Markus & Hamedani, 2007; K. Nelson, 1996). For instance, people can become better musicians when they can read music and understand what *keys*, *chords*, and *thirds* are. They develop their carpentry skills when they know how to interpret blueprints and understand terms such as *plumb* and *right angle*. Furthermore, through such disciplines as science, mathematics, and social studies, our culture passes along key concepts (e.g., *galaxy*, *right triangle*), symbols (e.g.,  $H_2O$ ,  $x^3$ ), principles (e.g., *Pythagorean theorem*, *supply-and-demand*), and visual representations (e.g., graphs, maps) that can help growing children interpret, organize, and successfully deal with the physical and social worlds in which they live (e.g., Davies & Uttal, 2007).

- ◆ *Children learn and remember more when they talk about their experiences.* Children begin to talk about their experiences almost as soon as they begin to speak, and by age 2 or 3 they do it fairly often (Fivush, Haden, & Reese, 1996; van den Broek, Bauer, & Bourg, 1997). Parents and teachers should join in the process: As we've seen, talking with children about joint experiences not only enhances children's memories of what they're seeing and doing but also helps children interpret their experiences in culturally appropriate ways.

- ◆ *Children should have opportunities to engage in activities that closely resemble those they will encounter in the adult world.* In industrialized societies, children are largely separated from the adult workplace, and so they have little exposure to the kinds of activities they'll need to perform when they themselves reach adulthood (Rogoff, 2003). Accordingly, many theorists recommend that teachers make frequent use of **authentic activities**—tasks identical or similar to those that children will eventually encounter in the outside world (e.g., Barab & Dodge, 2008; Edelson & Reiser, 2006; Greeno, Collins, & Resnick, 1996; Hickey, 1997). Such activities are likely to have several benefits. For one thing, when students work in a naturalistic context, using the physical and social resources that such a context offers (e.g., tools, peers), students should be able to accomplish more than they might accomplish in relatively artificial and unscaffolded classroom tasks. Second, complex authentic tasks can help students make meaningful connections among the various ideas and skills they've learned in the classroom. Finally, because authentic activities resemble real-world tasks and problems, they should help students make mental connections between the things they learn at school and out-of-school tasks (more about this last point in Chapter 15).

Authentic activities can be developed for virtually any area of the school curriculum. For example, teachers might have students:

- Write an editorial.
- Participate in a debate.
- Design an electrical circuit.
- Conduct an experiment.
- Write a computer program.
- Create and distribute a class newsletter.
- Perform in a concert.
- Plan a family budget.
- Converse in a foreign language.
- Make a videotape.
- Construct a museum display.
- Develop an Internet home page.

In some instances authentic activities take the form of **problem-based learning** or **project-based learning**, in which students acquire new knowledge and skills as they work on complex problems or projects similar to those they might find in the outside world (Hmelo-Silver, 2004, 2006; Krajcik & Blumenfeld, 2006; Polman, 2004). Occasionally authentic activities may also involve **service learning**—that is, they're projects that directly or indirectly enhance the quality of life in the outside community (Kahne & Sporte, 2008; Tate, 1995). To be effective in enhancing students' learning—and to be sources of pleasure and success rather than sources of frustration and failure—most complex authentic activities require considerable teacher guidance and support (Edelson & Reiser, 2006; Hmelo-Silver, Duncan, & Chinn, 2007; Mergendoller, Markham, Ravitz, & Larmer, 2006).

We should note, however, that it isn't necessarily desirable to fill the entire school day with complex, authentic tasks. For one thing, students can often master basic skills more effectively when they practice them in relative isolation from other activities (J. R. Anderson, Reder, & Simon, 1996). For example, when learning to play the violin, students need to master their fingering before they join an orchestra, and when learning to play soccer, they need to practice dribbling and passing before they play in a game. Second, some authentic tasks may be too expensive and time consuming to warrant their use on a regular basis in the classroom (M. M. Griffin & Griffin, 1994). It's probably most important that classroom tasks encourage students to engage in such cognitive processes as meaningful learning, organization, and elaboration—processes that promote long-term retention and application of classroom subject matter—than that tasks always be authentic in nature (J. R. Anderson et al., 1996).

♦ *Children often acquire better strategies when they collaborate with adults on complex tasks.* Although children internalize many important skills through interactions with their age-mates, they're likely to acquire more sophisticated strategies—and learn them more quickly—when adults rather than peers assist them in their efforts (Gauvain, 1999; McCaslin & Good, 1996; Radziszewska & Rogoff, 1988, 1991). Generally speaking, adults suggest and model more effective strategies, give more helpful guidance, and are more willing to let children take charge of a complex task at appropriate times.

♦ *Challenging tasks, especially when sufficiently scaffolded, are likely to foster maximum cognitive development.* To promote cognitive development, teachers and other adults must present some tasks and assignments that a child can perform successfully only with assistance—that is, tasks within the child's zone of proximal development. Children at any single age level are apt to have different zones of proximal development and so may need different tasks and assignments. In other words, instruction is most effective when it's individually tailored to children's unique strengths and limits.

♦ *Children’s abilities should be assessed under a variety of work conditions.* To get a good handle on children’s cognitive development, teachers ultimately need to know not only what the children can and can’t do but also under what conditions they’re most likely to accomplish various tasks successfully. By asking children to work under varying conditions—sometimes independently, sometimes in collaboration with one or more peers, and sometimes with adult instruction and support—teachers can get a better sense of the tasks that are in each child’s zone of proximal development (Calfee & Masuda, 1997; Haywood & Lidz, 2007; Horowitz, Darling-Hammond, & Bransford, 2005).

♦ *Group learning activities can help children internalize cognitive strategies.* As we’ve seen, Vygotsky suggested that children are apt to internalize—and so eventually use independently—the processes they first use in social interaction. Group study sessions, class discussions about literature, debates about controversial issues, and collaborative problem-solving tasks—all of these can help children acquire more sophisticated strategies, as we’ll discover in the next, final section of the chapter.

## PEER-INTERACTIVE INSTRUCTIONAL STRATEGIES

---

Increasingly, psychologists and educators are recognizing the value of having students work together to construct meaning about classroom subject matter—for instance, to explore, explain, discuss, and debate certain topics either in small groups or as an entire class. Following is an example of what might happen when students tackle new subject matter and problems as a group:

A third-grade class was working on the following problem: Bugs Bunny has 75 carrots. If he eats 5 carrots each day, for how many days does he have food? Most students solved the problem by writing 5s until they reached 75 and then counting the number of 5s. Maria solved the problem by writing  $10 \times 5 = 50$ ,  $5 \times 5 = 25$ , and  $10 + 5 = 15$ . After the different methods had been presented, the class discussed the ways in which Maria’s method was different from the others. Some students decided it was basically the same because Maria had added fives too, just in groups. The teacher then asked Maria why she chose 10 fives to start and not, say, 7 fives. Maria said she knew the answer to  $10 \times 5$  so it was easy. This class discussion may look rather innocuous, but it had a significant effect on the way many students thought about division. After the discussion, a number of students began division problems by looking for multiples of the divisor, often choosing multiples or powers of 10. These were important breakthroughs in students’ understandings and in the development of better methods. (Hiebert et al., 1997, pp. 44–45)

When students work together in such a manner, they are, in essence, engaging in *distributed cognition*: They spread the learning task across many minds and can draw on multiple knowledge bases and ideas. Furthermore, different students can hold different parts of a task in their working memories, essentially expanding the working memory capacity of the group as a whole (F. Kirschner, Paas, & Kirschner, 2009).

Students are apt to benefit in a variety of ways from sharing their ideas and perspectives with one another:

- They must clarify and organize their ideas well enough to explain and justify the ideas to others.
- They tend to elaborate on what they’ve learned—for example, by drawing inferences, generating hypotheses, and formulating questions to be answered.

- They're exposed to the views of others, who may have more accurate understandings.
- They can model effective ways of thinking about and studying academic subject matter for one another.
- They may discover flaws and inconsistencies in their own thinking, thereby identifying gaps in their understanding (recall the discussions of *conceptual change* in Chapter 10 and *sociocognitive conflict* in Chapter 12).
- With the support of their peers, they can gain practice in more sophisticated learning and reasoning skills, which they can eventually begin to use on their own (here is where Vygotsky's concept of *internalization* comes into play).
- They can also gain practice in the argumentation skills that experts in various disciplines use to advance the frontiers of knowledge—for instance, presenting evidence in support of conclusions and examining the strengths and weaknesses of various explanations.
- They may acquire a more sophisticated view of the nature of knowledge and learning. For example, they may begin to realize that acquiring knowledge involves acquiring an integrated set of ideas about a topic and that such knowledge is likely to evolve gradually over time (views of the nature of knowledge are known as *epistemic beliefs*; see Chapter 14). (Andriessen, 2006; Applebee et al., 2003; Asterhan & Schwarz, 2007; P. Bell & Linn, 2002; Bendixen & Rule, 2004; Carr & Biddlecomb, 1998; Chinn, 2006; A.-M. Clark et al., 2003; Hatano & Inagaki, 2003; K. Hogan, Nastasi, & Pressley, 2000; D. W. Johnson & Johnson, 2009b; A. King, 1999; D. Kuhn & Udell, 2003; P. K. Murphy & Mason, 2006; Nussbaum, 2008; B. B. Schwarz, Neuman, & Biezuner, 2000; Sinatra & Pintrich, 2003a; C. L. Smith, 2007; Vygotsky, 1978; Webb & Palincsar, 1996)

Also, many students find interactive learning sessions highly motivating, in part because they can address their social needs at the same time that they're studying classroom subject matter (Hacker & Bol, 2004; Saville, Zinn, Neef, Van Norman, & Ferreri, 2006; Stevens & Slavin, 1995). One fourth grader described the motivational benefits of small-group discussions this way:

I like it when we get to argue, because I have a big mouth sometimes, and I like to talk out in class, and I get really tired of holding my hand up in the air. Besides, we only get to talk to each other when we go outside at recess, and this gives us a chance to argue in a nice way. (A.-M. Clark et al., 2003, p. 194)

It's important to note, however, that peer-interactive approaches to instruction also have their downsides:

- Students may have insufficient expertise to tackle a task or problem without adult assistance. Even if they do have the expertise, they may have insufficient teaching and communication skills to help others understand their reasoning.
- Some students may be so anxious about making a bad impression on peers (e.g., by saying something “dumb”) that they have trouble focusing on the overall discussion.
- Some student groups may have trouble working together effectively and keeping themselves on task.
- Students of high social status may dominate discussions, with other students acquiescing to their opinions and suggestions.
- Students may become annoyed or frustrated and begin to “tune out” if they perceive a discussion to be going in irrelevant or counterproductive directions.

- Students sometimes pass along misconceptions and illogical reasoning processes to their peers. (Andre & Windschitl, 2003; Derry, DuRussel, & O'Donnell, 1998; Do & Schallert, 2004; S. Ellis & Rogoff, 1986; D. M. Hogan & Tudge, 1999; K. Hogan et al., 2000; Levy, Kaplan, & Patrick, 2000; Stacey, 1992; Wiley & Bailey, 2006; Wittenbaum & Park, 2001)

For such reasons, students probably learn most effectively with some teacher guidance and structure even when instructional methods are largely peer-interactive and learner-directed. In the pages ahead, we'll consider several forms that such guidance and structure might take.

## Class Discussions

Class discussions readily lend themselves to a variety of academic disciplines. For example, students might discuss various interpretations of classic works of literature, addressing questions with no easy or definitive right answers; when students engage in such discussions, they're more likely to relate what they're reading to their personal lives and thereby to understand it better (Applebee et al., 2003; Eeds & Wells, 1989; L. M. McGee, 1992; S. M. Miller, 2003). In history classes, students might study and discuss various documents related to a single historical event and thus begin to recognize that history isn't necessarily as cut-and-dried as traditional history textbooks portray it (Leinhardt, 1994; van Drie, van Boxtel, & van der Linden, 2006). In social studies, discussing controversial topics (e.g., civil disobedience, capital punishment) can help students understand that diverse viewpoints on an issue may all have some legitimacy (D. W. Johnson & Johnson, 2009b; D. Kuhn, Shaw, & Felton, 1997). In science classes, discussions of various and conflicting theoretical explanations of observed phenomena can help students come to grips with the idea that science isn't "fact" as much as it's a dynamic and continually evolving understanding of the world (Bereiter, 1994; M. C. Linn, 2008). And in mathematics, class discussions that focus on alternative approaches to solving the same problem can promote a more meaningful understanding and application of mathematical principles (Cobb et al., 1991; Hiebert & Wearne, 1992, 1996; Lampert, 1990; Walshaw & Anthony, 2008).

Although students typically do most of the talking in classroom discussions, teachers nevertheless play a critical role. Researchers and experienced educators have offered several guidelines for how teachers can promote effective classroom discussions:

- ◆ *Class discussions should focus on topics that lend themselves to multiple perspectives, explanations, or approaches.* Controversial topics appear to have several benefits: Students are more likely to express their views, seek out new information that resolves seemingly contradictory data, reevaluate their own positions on the issues under discussion, and develop a meaningful and well-integrated understanding of the subject matter (Applebee et al., 2003; Andriessen, 2006; E. G. Cohen, 1994; D. W. Johnson & Johnson, 2009b).
- ◆ *Students should have sufficient prior knowledge about a topic to discuss it intelligently.* Such knowledge might come either from previous class sessions or from students' personal experiences. In many cases, it's likely to come from studying a particular topic in depth (Bruning, Schraw, & Ronning, 1995; Onosko, 1996).
- ◆ *The classroom atmosphere should be conducive to open debate and the constructive evaluation of ideas.* Students are more likely to share their ideas and opinions if their teacher is supportive of multiple viewpoints and if disagreeing with classmates is socially acceptable and psychologically "safe." To promote such an atmosphere in the classroom, teachers might:



- Communicate the message that understanding a topic at the end of a discussion is more important than having the “correct” answer at the beginning of the discussion.
  - Communicate the beliefs that asking questions reflects curiosity, that differing perspectives on a controversial topic are both inevitable and healthy, and that changing one’s opinion on a topic can be a sign of thoughtful reflection.
  - Encourage students to try to understand one another’s reasoning and explanations.
  - Suggest that students build on one another’s ideas whenever possible.
  - Encourage students to be open in their agreement or disagreement with others—in other words, to “agree to disagree”—but to be critical of *ideas* rather than people.
  - Depersonalize challenges to a student’s line of reasoning by framing questions in a third-person voice—for example, by asking, “What if someone were to respond to your claim by saying . . . ?”
  - Occasionally ask students to defend a position that’s in direct opposition to what they actually believe.
  - Require students to develop compromise solutions that take into account opposing perspectives. (Cobb & Yackel, 1996; Hadjioannou, 2007; Hatano & Inagaki, 1993, 2003; Herrenkohl & Guerra, 1998; K. Hogan et al., 2000; D. W. Johnson & Johnson, 2009b; Lampert, Rittenhouse, & Crumbaugh, 1996; Perkins & Ritchhart, 2004; Reiter, 1994)
- ♦ *Small-group discussions encourage a greater number of students to participate.* Many students speak more openly when their audience is a handful of classmates rather than the class as a whole; the difference is especially noticeable for females (A.-M. Clark et al., 2003; Théberge, 1994). On some occasions, teachers may want to have students discuss an issue in small groups first, thereby allowing students to voice and gain support for their ideas in a relatively private context, and then bring students together for a whole-class discussion (Onosko, 1996).
- ♦ *Class discussions are often more effective when they’re structured in some way.* Such a structure might involve asking thought-provoking questions, setting a particular goal toward which students should work, or assigning different roles to different class members—for example, having some students evaluate the quality of evidence presented, having others evaluate the validity of conclusions, and so on (I. L. Beck & McKeown, 2001; Calfee, Dunlap, & Wat, 1994; Palincsar & Herrenkohl, 1999; C. L. Smith, 2007). Before conducting an experiment, a science teacher might ask students to make predictions about what will happen and to explain and defend why they think their predictions are correct. Later, after students have observed the outcome, the teacher might ask them to explain what happened and why (Hatano & Inagaki, 1991; Herrenkohl & Guerra, 1998). Another useful strategy is to follow a sequence such as this one:
1. The class is divided into groups of four students apiece. Each group of four subdivides into two pairs.
  2. Within a group, each pair of students studies a particular position on the issue and presents its position to the other two students.
  3. The group of four has an open discussion of the issue, giving each student an opportunity to argue persuasively for his or her own position.
  4. Each pair presents the perspective of the *opposing* side as sincerely and persuasively as possible.
  5. The group strives for consensus on a position that incorporates all of the evidence presented. (Deutsch, 1993; D. W. Johnson & Johnson, 2009b).

♦ *Some type of closure should be provided at the end of the discussion.* Regardless of whether students ultimately reach consensus about a topic, a class discussion should have some form of closure that helps students tie various ideas together. For instance, when I conduct discussions about controversial topics in my own classes, I spend a few minutes at the end of class identifying and summarizing key issues that students have raised. Another strategy is to have students explain how a discussion has helped them understand a topic more fully (Onosko, 1996).

## Reciprocal Teaching

Annemarie Palincsar and Ann Brown (1984; A. L. Brown & Palincsar, 1987) have identified four key strategies that good readers typically use but poor readers often *don't* use:

- *Summarizing:* They identify the gist and main ideas of what they read.
- *Questioning:* They ask themselves questions to make sure they understand what they're reading.
- *Clarifying:* They take steps to clarify confusing or ambiguous parts of the text, perhaps by rereading or by drawing on their own knowledge to help them make sense of the text.
- *Predicting:* They anticipate what they're likely to read next based on cues in the text (e.g., headings) and ideas the text has previously presented.

All four of these strategies are largely internal cognitive processes rather than observable behaviors. Consistent with Vygotsky's concept of internalization, Palincsar and Brown reasoned that students might acquire the strategies more easily if they first practice them aloud in collaboration with their classmates.

In **reciprocal teaching** (A. L. Brown & Palincsar, 1987; Palincsar, 2003; Palincsar & Brown, 1984, 1989; Palincsar & Herrenkohl, 1999), a classroom teacher and several students meet in a group to read a section of text, stopping periodically to discuss what they're reading. Initially the teacher leads the discussion, asking questions about the text to promote summarizing, questioning, clarifying, and predicting. But gradually, he or she turns the role of "teacher" over to different students, who then take charge of the discussion and ask one another the same kinds of questions their teacher has modeled. Eventually, students can read and discuss a text almost independently of the teacher, working together to construct its meaning and checking one another for comprehension and possible misunderstandings.

As an illustration, let's look at a reciprocal teaching session for a group of six first graders reading a passage about snowshoe rabbits. In this particular case, the classroom teacher reads the text in small segments (at higher grade levels, the students themselves take turns reading). After each segment, the teacher pauses while students discuss and process the segment. As you read the dialogue, look for examples of summarizing, questioning, clarifying, and predicting (there's at least one instance of each):

The children were reading about the snowshoe rabbit and it was the 16th day of dialogue. The teacher had just read a segment of text describing the season in which baby rabbits are born and the ways in which the mother rabbit cares for her babies. A student named Kam is the dialogue leader.

Kam: When was the babies born?

Teacher: That's a good question to ask. Call on someone to answer that question.

Kam: Robby? Milly?

Milly: Summer.

Teacher: What would happen if the babies were born in the winter? Let's think.

Several children make a number of responses including: "The baby would be very cold." "They would need food." "They don't have no fur when they are just born."

Kam: I have another question. How does she get the babies safe?

Kris: She hides them.

Kam: That's right but something else . . .

Teacher: There is something very unusual about how she hides them that surprised me. I didn't know this.

Travis: They are all in a different place.

Teacher: Why do you think she does this?

Milly: Probably because I heard another story and when they're babies they usually eat each other or fight with each other.

Teacher: That could be! And what about when that lynx comes?

Several children comment that that would be the end of all the babies.

Travis: If I was the mother, I would hide mine. I would keep them all together.

Kris: If the babies are hidden and the mom wants to go and look at them how can she remember where they are?

Teacher: Good question. Because she does have to find them again. Why? What does she bring them?

Milly: She needs to bring food. She probably leaves a twig or something.

Teacher: Do you think she puts out a twig like we mark a trail?

Several children disagree and suggest that she uses her sense of smell. One child, recalling that the snowshoe rabbit is not all white in the winter, suggests that the mother might be able to tell her babies apart by their coloring.

Teacher: So we agree that the mother rabbit uses her senses to find her babies after she hides them. Kam, can you summarize for us now?

Kam: The babies are born in the summer. . . .

Teacher: The mother . . . .

Kam: The mother hides the babies in different places.

Teacher: And she visits them . . . .

Kam: To bring them food.

Travis: She keeps them safe.

Teacher: Any predictions?

Milly: What she teaches her babies . . . like how to hop.

Kris: They know how to hop already.

Teacher: Well, let's read and see.

(dialogue courtesy of A. Palincsar)

Reciprocal teaching provides a mechanism through which both teacher and students can model effective reading and learning strategies. Furthermore, its structured nature scaffolds students' efforts to make sense of the things they read and hear. For instance, if you look back at the preceding dialogue for a moment, you may notice how the teacher models elaborative questions and connections to prior knowledge ("What would happen if the babies were born in the

winter?"; "Do you think she puts out a twig like we mark a trail?") and provides general guidance and occasional hints about how students should process the passage about snowshoe rabbits ("Kam, can you summarize for us now?"; "And she visits them . . ."). Also notice in the dialogue how students support one another in their efforts to process what they are reading; consider this exchange as an example:

Kam: I have another question. How does she get the babies safe?

Kris: She hides them.

Kam: That's right but something else . . . .

Reciprocal teaching promotes more effective reading and listening comprehension skills in students at all grade levels, and in English language learners as well as native English speakers (Alfassi, 2004; Johnson-Glenberg, 2000; K. D. McGee, Knight, & Boudah, 2001; Palincsar & Brown, 1989; Rosenshine & Meister, 1994; W. H. Slater, 2004). In the first, classic study of reciprocal teaching (Palincsar & Brown, 1984), six seventh graders with a history of poor reading comprehension participated in 20 reciprocal teaching sessions, each lasting about 30 minutes. Despite this relatively short intervention, students showed remarkable improvement in their reading comprehension skills. Furthermore, they generalized their new reading strategies to other classes, sometimes surpassing the achievement of their classmates (A. L. Brown & Palincsar, 1987; Palincsar & Brown, 1984).

You shouldn't think of reciprocal teaching as something that only reading teachers use. It's also been successfully used in science classes (where teachers have adapted it for whole-class discussions of passages in science textbooks) and math classes (where teachers have adapted it to help students make sense of complex word problems) (A. L. Brown & Palincsar, 1987; van Garderen, 2004). Furthermore, reciprocal teaching sessions can be conducted online as well as in the classroom (Reinking & Leu, 2008). Using reciprocal teaching effectively may take some practice, however. It may also require a concerted effort to make sure that students do, in fact, generate and model higher-level questions as well as lower-level ones (e.g., Hacker & Tenent, 2002).

## Cooperative Learning

In **cooperative learning**,<sup>4</sup> students work in small groups to achieve a common goal. Cooperative learning groups vary in duration, depending on the task to be accomplished. Sometimes groups are formed on a short-term basis to accomplish specific tasks—perhaps to study new material, solve a problem, or complete an assigned project. On other occasions groups are formed to work toward long-term classroom goals. For instance, **base groups** are cooperative groups that last an entire semester or school year; they provide a means through which students can clarify assignments for one another, help one another with class notes, and provide one another with a general sense of support and belonging in the classroom (D. W. Johnson & Johnson, 1991).

---

<sup>4</sup>Some theorists distinguish between *cooperative* learning and *collaborative* learning, although different theorists draw the line somewhat differently (e.g., see Palincsar & Herrenkohl, 1999; B. L. Smith & MacGregor, 1992; Teasley & Roschelle, 1993). Part of their reasoning, I suspect, is that the term *cooperative learning* has historically been associated with particular theorists and particular instructional strategies (e.g., D. W. Johnson & Johnson, 1991; Slavin, 1983a, 1990a). Here I'm using cooperative learning more broadly to refer to any instructional method in which students work together in a somewhat structured format to achieve a shared learning goal.

When designed and structured appropriately, cooperative learning activities can be quite effective in promoting learning and academic achievement. On average, students of all ability levels show higher academic achievement, with females, minority-group students, and students at risk for academic failure especially benefiting (Barron, 2000; Ginsburg-Block, Rohrbeck, & Fantuzzo, 2006; Lou et al., 1996; Qin, Johnson, & Johnson, 1995; Rohrbeck, Ginsburg-Block, Fantuzzo, & Miller, 2003; Stevens & Slavin, 1995). Cooperative learning activities can have other desirable outcomes as well, such as increased self-efficacy for academic success and more productive relationships with classmates (D. W. Johnson & Johnson, 1985; Lou, Abrami, & d'Apollonia, 2001; Lou et al., 1996; J. D. Nichols, 1996; Slavin, Hurley, & Chamberlain, 2003).

Potential downsides of cooperative learning should be noted, however. Students may sometimes be more interested in achieving a group goal with the least possible effort and so will focus more on getting a single right answer than on ensuring that all group members understand the subject matter being studied (Good, McCaslin, & Reys, 1992; Hatano & Inagaki, 1991; M. C. Linn, Songer, & Eylon, 1996). Students who do most of the work and most of the talking may learn more than other group members, and they may harbor negative feelings about peers who contribute little or nothing to the group effort (Gayford, 1992; Lotan, 2006; Webb, 1989). Students may occasionally agree to use an incorrect strategy or method that a particular group member has suggested. And in some cases, students may simply not have the skills to help one another learn (O'Donnell & O'Kelly, 1994; Webb & Mastergeorge, 2003).

Clearly, then, cooperative learning isn't simply a process of putting students in groups and setting them loose to work together on a project or assignment. For a cooperative learning activity to be successful, teachers must structure it in such a way that cooperation isn't just helpful but in fact *necessary* for academic success (D. W. Johnson & Johnson, 1991). Following are several features that enhance the effectiveness of cooperative groups:

- ◆ *Students work in small, teacher-assigned groups.* Groups are typically comprised of two to six members; groups of three to four students are especially effective (Hatano & Inagaki, 1991; Lou et al., 1996). In most cases, the *teacher* forms the groups, identifying student combinations that will work productively (D. W. Johnson & Johnson, 1991; Lotan, 2006). Some advocates of cooperative learning suggest that groups be heterogeneous, with each group including high achievers and low achievers, boys and girls, and children of various ethnic backgrounds. Others disagree, arguing that too much heterogeneity makes ability differences among students uncomfortably obvious and discourages low-ability students from actively participating (Lotan, 2006; Moje & Shepardson, 1998; O'Donnell & O'Kelly, 1994; S. E. Peterson, 1993; Webb, Nemer, & Zuniga, 2002).

Research regarding the effects of heterogeneous cooperative groups has yielded mixed results. Some studies indicate that heterogeneous groups benefit both high-achieving students (who can sharpen their knowledge by explaining it to peers) and low-achieving students (who benefit from hearing such explanations) (Lou et al., 1996; Stevens & Slavin, 1995; Webb, Nemer, Chizhik, & Sugrue, 1998; Webb & Palincsar, 1996). However, other studies indicate that high-achieving students don't always gain from working with their low-achieving classmates and may occasionally even lose ground (D. M. Hogan & Tudge, 1999; D. Kuhn & Pease, 2010; Webb et al., 2002). Ideally, an assigned group activity requires a sufficiently wide range of talents and skills that every group member has something unique and useful to contribute to the group's overall success (E. G. Cohen, 1994; Esmonde, 2009; Lotan, 2006).

- ◆ *Groups have one or more common goals toward which to work.* At the beginning of a cooperative group activity, each group should have a clear and concrete understanding of what it

needs to accomplish (D. W. Johnson & Johnson, 1991; Slavin et al., 2003). For instance, in a cooperative project-based learning activity, students begin with a “driving question” they need to answer (e.g., “Can good friends make me sick?”) and then, with appropriate teacher scaffolding and technological tools, conduct an in-depth inquiry to address the question (Krajcik & Blumenfeld, 2006, p. 322; Mergendoller et al., 2006; Polman, 2004).

◆ *Students have clear guidelines about how to behave.* Without instruction about appropriate group behaviors, some students may act in a decidedly uncooperative manner; for instance, they may try to dominate discussions, ridicule one another’s ideas, or exert pressure to complete a task in a particular way (Blumenfeld, Marx, Soloway, & Krajcik, 1996; Webb & Palincsar, 1996). Instruction on group skills such as the following seems to increase cooperative and productive group behaviors:

- Listening to others politely and attentively
- Making sure everyone has an equal chance to participate and that everyone eventually understands the material
- Asking clear, precise questions when one doesn’t understand
- Giving encouragement to others, and offering assistance as needed
- Offering feedback that is specific, kind, and constructive (e.g., “I’m curious why you chose to begin with this . . .” or “Have you considered including . . . ?”)
- Addressing differences of opinion amicably and constructively (Berger, 2003, p. 94; E. G. Cohen, 1994; Deutsch, 1993; Gillies & Ashman, 1998; D. W. Johnson & Johnson, 1991; Lotan, 2006; Lou et al., 1996; O’Donnell & O’Kelly, 1994; Webb & Farivar, 1994, 1999; Webb & Palincsar, 1996)

◆ *Group members must depend on one another for their success.* Ideally, cooperative group activities are structured so that each student’s success depends on the help and participation of other group members. Furthermore, each student must believe that it’s to his or her advantage that other group members do well (Ginsburg-Block et al., 2006; D. W. Johnson & Johnson, 2009a; Lou et al., 1996; Slavin, 1983a). Tasks that involve creative problem solving and have more than one right answer are especially likely to encourage students to work cooperatively (Blumenfeld et al., 1996). In some situations, each student might have a unique and essential function within the group, perhaps serving as group leader, critic, bookkeeper, peacekeeper, summarizer, or the like (Esmonde, 2009; D. W. Johnson & Johnson, 1991; Lotan, 2006). In other situations, the **jigsaw** technique is useful: New information is divided equally among all group members, and each student must teach his or her portion to the other group members (E. Aronson, 1997).

◆ *A structure is provided to encourage productive learning behaviors.* When students are novices at cooperative learning, it’s often helpful to give them some sort of structure—perhaps a set of steps or script to follow—that guides their interaction (Fantuzzo, King, & Heller, 1992; Gillies, 2003; Ginsburg-Block et al., 2006; Webb & Palincsar, 1996). For example, in **scripted cooperation**, students work in pairs to read and study expository text (Dansereau, 1988; O’Donnell, 1999). One member of the pair might act as “recaller,” summarizing the contents of a textbook passage. The other student acts as “listener,” correcting any errors and recalling additional important information. For the next passage, the two students switch roles. Such an approach can help students improve such learning strategies as elaboration, summarizing, and checking for understanding.

The particular structure a teacher provides influences the kind of learning that results—for instance, whether students focus on learning facts, on the one hand, or engage in more sophisticated thinking skills, on the other. In one approach, known as either **guided peer questioning** or **elaborative interrogation**, student pairs are given a structure that encourages them to ask one another higher-level questions about classroom material (Kahl & Woloshyn, 1994; A. King, 1997, 1999; A. King, Staffieri, & Adalgais, 1998; Ozgungor & Guthrie, 2004; Woloshyn, Pressley, & Schneider, 1992). More specifically, they're given “starters” such as these for constructing questions:

- Describe . . . in your own words.
- Explain why . . . .
- What is the difference between . . . and . . . ?
- How could . . . be used to . . . ? (A. King, 1999, p. 93)

Students then use such questions to probe and promote their partner's understanding. The following exchange shows two fifth graders using guided peer questioning as they study material about tide pools and tidal zones:

- Janelle: What do you think would happen if there weren't certain zones for certain animals in the tide pools?
- Katie: They would all be, like, mixed up—and all the predators would kill all the animals that shouldn't be there and then they just wouldn't survive. 'Cause the food chain wouldn't work—'cause the top of the chain would eat all the others and there would be no place for the bottom ones to hide and be protected. And nothing left for them to eat.
- Janelle: OK. But what about the ones that had camouflage to hide them? (A. King, 1999, p. 95)

We join the two girls again later in the session; at this point, Katie is now asking the questions:

- Katie: How are the upper tide zone and the lower tide zone different?
- Janelle: They have different animals in them. Animals in the upper tide zone and splash zone can handle being exposed—have to be able to use the rain and sand and wind and sun—and they don't need that much water and the lower tide animals do.
- Katie: And they can be softer 'cause they don't have to get hit on the rocks.
- Janelle: Also predators. In the spray zone it's because there's predators like us people and all different kinds of stuff that can kill the animals and they won't survive, but the lower tide zone has not as many predators.
- Katie: But wait! Why do the animals in the splash zone have to survive? (A. King, 1999, p. 97)

Clearly Janelle and Katie have become skilled at asking and answering higher-level questions. At the end of the second dialogue, we even see Katie questioning a basic assumption of the discussion—that animals in the splash zone need to survive.

♦ *The teacher serves primarily as a resource and monitor.* During effective cooperative learning activities, the teacher provides any necessary assistance and scaffolding to keep groups on track toward meeting their goal (S. M. Williams, 2010). The teacher also monitors each group to be sure that interactions are productive and socially appropriate (D. W. Johnson & Johnson, 1991; Meloth & Deering, 1999; Webb & Farivar, 1999). For instance, if students seem to be buying

into a classmate's misconceptions about the topic at hand, a gentle intervention may steer a discussion in a more productive direction (e.g., "Lydia thinks that [such-and-such]. Do the rest of you agree with that?"). And if students make hurtful remarks to peers, a reminder about the rules for behavior—and in some cases a request for an apology—may be in order. Too much intervention can be counterproductive, however: Students tend to talk less with one another when their teacher joins their group (E. G. Cohen, 1994).

- ◆ *Students are individually accountable for their achievement.* Each student demonstrates individual mastery or accomplishment of the group's goal—for example, by taking a quiz or having primary responsibility for a certain aspect of the group's final product. Individual accountability decreases the likelihood that some students will do most or all of the work while others get a free ride (Ginsburg-Block et al., 2006; D. W. Johnson & Johnson, 2009a; Karau & Williams, 1995).

- ◆ *Students are rewarded for group success.* In addition to being accountable for their own learning and achievement, group members are typically rewarded in some way for the success of the group as a whole. Group rewards often promote higher achievement overall, perhaps because students have a vested interest in helping one another learn and therefore make a concerted effort to help fellow group members understand the material being studied (Lou et al., 1996; Slavin, 1983b, 1990a; Stevens & Slavin, 1995).

It's important to note, however, that not all researchers have found group rewards to be beneficial. In particular, students may sometimes learn better when they focus on using effective learning strategies than when they focus on obtaining a group reward (Meloth & Deering, 1992, 1994). More generally, the effects of extrinsic reinforcers can be a mixed bag, as you'll discover in Chapter 16.

- ◆ *At the completion of an activity, each group evaluates its effectiveness.* Once a cooperative group has accomplished its goal, it looks analytically and critically (often with teacher assistance) at the ways in which it has functioned effectively and the ways in which it needs to improve (E. G. Cohen, 1994; D. W. Johnson & Johnson, 2009a).

## Peer Tutoring

In **peer tutoring**,<sup>5</sup> students who have mastered a topic teach those who haven't. Peer tutoring sessions often provide a context in which struggling students can more easily ask questions when they don't understand something and get immediate feedback on their performance (J. R. Sullivan & Conoley, 2004). But the tutors frequently benefit as well, in part because they can practice, elaborate on, and better internalize their emerging cognitive skills (see the earlier section "Acquisition of Teaching Skills"). Thus, both the tutors and the students they tutor may show significant academic gains (Greenwood, Carta, & Hall, 1988; O'Donnell, 2006; D. R. Robinson et al., 2005; Roscoe & Chi, 2007; J. R. Sullivan & Conoley, 2004).

---

<sup>5</sup>Some theorists use the term *peer tutoring* when referring to structured learning sessions in which students of equal ability ask one another questions about classroom subject matter. I've incorporated the literature about such tutoring in my earlier discussion of cooperative learning. I'm restricting my use of the term here largely to situations in which one learner has greater expertise in the subject matter than another.



Like other peer-interactive approaches to instruction, peer tutoring is most effective when teachers follow certain guidelines in its use. Following are several suggestions:

♦ *Teachers should be sure that tutors have mastered the material being taught and use sound instructional techniques.* Good tutors have a solid understanding of the subject matter they're teaching and provide explanations that focus on meaningful (rather than rote) learning. Also, good tutors use teaching strategies that are likely to promote learning: They ask questions, give hints, scaffold responses when necessary, provide feedback, and so on (L. S. Fuchs et al., 1996; Lepper, Aspinwall, Mumme, & Chabey, 1990; Roscoe & Chi, 2007).

Especially in the elementary grades, explicit training in tutoring skills can be helpful. For example, student tutors might be shown how to establish a good relationship with the students they're tutoring, how to break a task into simple steps, how and when to give feedback, and so on (Fueyo & Bushell, 1998; Inglis & Biemiller, 1997; Kermani & Moallem, 1997).

♦ *Structured interactions can enhance the effectiveness of peer tutoring.* Studies by Lynn and Douglas Fuchs and their colleagues indicate that providing a structure for tutoring sessions can help elementary students effectively tutor their classmates in reading comprehension skills (e.g., D. Fuchs et al., 1997; L. S. Fuchs et al., 1996; Mathes, Torgesen, & Allor, 2001; also see Spörer & Brunstein, 2009). In one study (D. Fuchs et al., 1997), 20 second-through sixth-grade classes participated in a project called Peer-Assisted Learning Strategies (PALS). In each class, students were ranked with regard to their reading performance, and the ranked list was divided in half. The first-ranked student in the top half of the list was paired with the first-ranked student in the bottom half of the list, the second student in the top half was paired with the second student in the bottom half, and so on down the list; through this procedure, students who were paired together had moderate but not extreme differences in reading level. Each pair read material at the level of the weaker reader and engaged in the following activities:

- *Partner reading with retell:* The stronger reader read aloud for 5 minutes, and then the weaker reader read the same passage of text. Reading something that had previously been read presumably enabled the weaker reader to read the material easily. After the double reading, the weaker reader described the material the pair had just read.
- *Paragraph summary:* The students both read a passage one paragraph at a time. Then, with help from the stronger reader, the weaker reader tried to identify the subject and main idea of the paragraph.
- *Prediction relay:* Both students read a page of text, and then, with help from the stronger reader, the weaker reader summarized the text and made a prediction about what the next page would say. The students then read the following page, and the weaker reader would confirm or disconfirm the prediction, summarize the new page, make a new prediction, and so on.

This procedure enabled students in the PALS program to make significantly greater progress in reading than students who had more traditional reading instruction, even though the amount of class time devoted to reading instruction was similar for both groups. The researchers speculated that the superior performance of the PALS students was probably the result of students' more frequent opportunities to respond to what they were reading, more frequent feedback about their performance, and, in general, greater support for using effective reading strategies.

♦ *Teachers must be careful that their use of higher-ability students to tutor lower-ability students isn't excessive or exploitive.* As we've seen, tutors often gain just as much from tutoring sessions as

the students they are tutoring. Nevertheless, teachers should regularly monitor the effects of a peer tutoring program to make sure that all students are reaping its benefits.

◆ *Teachers can use peer tutoring to help students with special educational needs.* Peer tutoring has been used effectively to help students with learning disabilities, physical disabilities, and other special educational needs (Cushing & Kennedy, 1997; DuPaul, Ervin, Hook, & McGoey, 1998; D. Fuchs et al., 1997). In one study (Cushing & Kennedy, 1997), low-achieving students regularly tutored classmates who had moderate or severe intellectual or physical disabilities. The student tutors clearly benefited from their tutoring assignments: They became more attentive in class, completed classroom tasks more frequently, and participated in class more regularly. I suspect that the opportunity to tutor classmates less capable than themselves may have enhanced their own self-efficacy for learning classroom subject matter, which in turn would encourage them to engage in behaviors that would ensure (rather than interfere with) academic success.

◆ *Tutoring doesn't necessarily need to be limited to same-age pairs.* In many instances, students at one grade level can effectively tutor students at a lower grade level; for example, fourth or fifth graders can tutor students in kindergarten or first grade, and high school students can tutor middle schoolers (Biemiller et al., 1998; A. L. Brown & Campione, 1994; Graesser & Person, 1994; D. R. Robinson et al., 2005; J. R. Sullivan & Conoley, 2004). Such a practice is consistent with Vygotsky's belief that older, more competent individuals are invaluable in promoting the cognitive development of young children. Furthermore, low-ability students who tutor younger children on content they themselves have mastered have a chance to regulate others' learning and, thanks to the internalization process, become more *self-regulating* (Biemiller et al., 1998).

## Communities of Learners

An important prerequisite for peer-interactive instructional methods is a *sense of community*—a sense that teacher and students have shared goals, respect and support one another's efforts, and believe that everyone makes an important contribution to classroom learning (Hom & Battistich, 1995; M. Watson & Battistich, 2006). One way to create this sense of community is to transform the classroom into a **community of learners** in which teacher and students collaborate to build a body of knowledge about a topic and help one another learn about it. A classroom that operates as a community of learners is likely to have certain characteristics:

- All students are active participants in classroom activities.
- The primary goal is to acquire a body of knowledge on a specific topic, with students contributing to and building on one another's efforts.
- Students draw on many resources—books, magazines, the Internet, and one another—in their efforts to learn about the topic.
- Discussion and collaboration among two or more students occur regularly and play a key role in learning.
- Diversity in students' interests and rates of progress is expected and respected.
- Students and teacher coordinate their efforts in helping one another learn; no one has exclusive responsibility for teaching others.
- Everyone is a potential resource for the others; different individuals are likely to serve as resources on different occasions, depending on the topics and tasks at hand. In some cases students “major” in a particular topic and become local experts on it. Occasionally people outside the classroom share their expertise as well.

- The teacher provides some guidance and direction for classroom activities, but students may also contribute guidance and direction.
- Mechanisms are in place through which students can share what they've learned with others.
- Constructive questioning and critiquing of one another's work is commonplace.
- The process of learning is emphasized as much as, and sometimes more than, the finished product. (Bielaczyc & Collins, 1999; A. L. Brown & Campione, 1994, 1996; Campione, Shapiro, & Brown, 1995; A. Collins, 2006; R. A. Engle & Conant, 2002; Kincheloe, 2009; Rogoff, 1994, 2003; Rogoff, Matusov, & White, 1996; Scardamalia & Bereiter, 2006).

Underlying a community of learners is the guiding principle that students and teacher(s) alike are committed to advancing the collective knowledge, skills, and understanding of all members of the classroom. Essentially, the class engages in **knowledge building**—authentically advancing the frontiers of the group's knowledge about a topic, much as adult researchers do in their efforts to advance the world's knowledge in various academic and professional disciplines (Bereiter & Scardamalia, 2006; Bielaczyc & Collins, 1999, 2006; Scardamalia & Bereiter, 2006). In the process, students create not only tangible products but also **conceptual artifacts**—theories, models, plans, problem-solving strategies, and other cognitive tools they can use, evaluate, and possibly modify over time (Bereiter & Scardamalia, 2006; Scardamalia & Bereiter, 2006).

In one example of how a community of learners can be structured (A. L. Brown & Campione, 1994), students are divided into small groups to study different subtopics falling under a general theme; for instance, subtopics for the theme *changing populations* might be *extinct*, *endangered*, *artificial*, *assisted*, and *urbanized*. Each group conducts research and prepared teaching materials related to its subtopic. The class then reassembles into new groups that include at least one representative from each of the previous groups. Within these groups, the students teach one another the things they've learned.

Communities of learners typically incorporate a variety of interactive instructional strategies, including class discussions, cooperative learning, peer tutoring, and perhaps reciprocal teaching (A. L. Brown & Campione, 1996). (The *changing populations* unit just described reflects the *jigsaw* technique described earlier in the section on cooperative learning.) In addition, older students or subject-matter experts may occasionally sit in on group discussions and gently guide the students as they prepare their teaching materials—for example, when the materials describe bats, asking “Remember that the reader hasn't read about echo location; is this enough to make it clear?” (A. L. Brown & Campione, 1996, p. 298).

Working in communities of learners can give students a sense of the approach scientists and other scholars take to advance the frontiers of knowledge: They conduct individual and collaborative research, share ideas, build on one another's findings, and so on. And in fact, participating in such communities appears to promote fairly complex thinking and knowledge-building processes, often for extended time periods (A. L. Brown & Campione, 1994, 1996; R. A. Engle, 2006; R. A. Engle & Conant, 2002; Scardamalia & Bereiter, 2006; J. Zhang, Scardamalia, Reeve, & Messina, 2009). Participating in a community of learners is also highly motivating for students, who often insist on going to school even when they're ill and are disappointed when summer vacation begins (Rogoff, 1994; Turkanis, 2001).

At the same time, communities of learners have two potential weaknesses (A. L. Brown & Campione, 1994; Hynd, 1998b). For one thing, what students learn is inevitably limited to the

knowledge that they themselves acquire and share with one another. In addition, students may occasionally pass their misconceptions on to classmates. Obviously, then, teachers who structure their classrooms as communities of learners must carefully monitor student interactions to make sure that instructional objectives are being achieved and that students ultimately acquire accurate understandings of the subject matter they're studying.

Many of the principles and guidelines I've offered for class discussions and cooperative learning are relevant to communities of learning as well. For instance, the classroom atmosphere should be one in which students feel comfortable sharing ideas, disagreeing with one another, and occasionally changing their minds. The final goal of a learning task should be clear, and students' efforts should be structured and scaffolding sufficiently to enable students to reach that goal. And students should realize that helping their classmates learn is ultimately in everyone's best interest.

In addition, the following guidelines can be helpful:

- ◆ *Students should focus on complex problems that need solving.* Ideally, communities of learners focus on significant issues and problems—those that have personal meaning to students and are potentially relevant to the well-being of the world at large (Brophy, 2004; R. A. Engle & Conant, 2002). The *changing populations* theme mentioned earlier is an example of a topic that many students are likely to view as important to themselves personally and to the broader society.

- ◆ *Students should learn basic skills in persuasion and argumentation.* In a community of learners, students often bring diverse ideas and perspectives to bear on a topic, and they must learn to state and defend their positions in ways that convince others. For instance, they should present solid evidence for their claims, and they must be able to critique (tactfully) any opposing claims (Cazden, 2001; R. A. Engle & Conant, 2002). Such skills are most likely to develop when encouraged, modeled, scaffolded, and regularly practiced (Andriessen, 2006; Halpern, 1998; Klahr & Chen, 2003; D. Kuhn & Udell, 2003).

- ◆ *Students must be committed to working effectively—and must learn how to work effectively—with all their classmates.* Students inevitably bring their existing relationships with classmates—including some counterproductive perceptions and emotional “baggage”—to a community of learners. Teachers may need to take active steps to help students discover the many unique abilities and other strengths that every community member can contribute to the overall learning effort (Brophy, 2004; Cazden, 2001; Esmonde, 2009).

## Technology-Based Collaborative Learning

Effective student interactions don't necessarily have to be face to face. Through such mechanisms as email, Internet chat rooms, electronic bulletin boards, and class- or school-constructed websites, computer technology enables students to communicate with their peers (either locally or around the world), exchange perspectives, brainstorm and build on one another's ideas, and occasionally pull experts into the conversation (Bielaczyc & Collins, 2006; Derry, 2006; Gehlbach et al., 2008; G. Stahl, Koschmann, & Suthers, 2006; Winn, 2002).

Software created at the University of Toronto provides an example of how technology can enhance student interaction and knowledge construction. This software, called Knowledge

Forum,<sup>6</sup> enables students to communicate regularly using a classwide or cross-institution database and essentially creates a computer-based community of learners (e.g., Hewitt & Scardamalia, 1998; S.-P. Lin & Hong, 2010; Scardamalia & Bereiter, 2006; J. Zhang et al., 2009). In this electronic environment, students post their work in the forms of notes, short stories, reports, problem solutions, diagrams and flowcharts depicting scientific phenomena, and so on. Their peers respond regularly, perhaps by giving feedback, building on ideas, offering alternative perspectives, or synthesizing what's been learned; sometimes a subject-matter expert gets involved in the conversation as well. Such technology-based interactions give students the time they may need to reflect on one another's ideas (recall our discussion of *wait time* in Chapter 11) and may be especially valuable for students who are shy or for other reasons feel uncomfortable communicating with peers more publicly (Hewitt & Scardamalia, 1998).

As the Internet becomes increasingly accessible to learners worldwide, teachers and students have virtually limitless mechanisms for communicating and collaborating with people in faraway settings about issues of common interest. An example is the GLOBE Program ([www.globe.gov](http://www.globe.gov)), through which student groups around the world collaborate on inquiry-based projects related to environmental and earth sciences. Students in participating schools and classrooms collect and analyze data about various environmental topics (e.g., climate change, watershed dynamics), write reports, and share their findings with students and professional scientists elsewhere. Such multinational student–student collaborations are an excellent way to get young learners thinking and acting as global citizens as well as citizens of a particular community and country.

As students work together to explore and evaluate various perspectives on a topic and synthesize their findings, they can make significant cognitive advancements (e.g., Andriessen, 2006; S.-P. Lin & Hong, 2010; Miyake, 2008). For example, students often discover that various academic disciplines aren't necessarily as cut-and-dried and matter-of-fact as they once may have thought. To illustrate, in a unit titled Prehistory of the New World, students in a combined fifth- and sixth-grade classroom worked in groups of three or four to study particular topics and then shared their findings through their computer database (Hewitt, Brett, Scardamalia, Frecker, & Webb, 1995). One group, which studied various theories about how human beings first migrated from Asia to the Americas, reported the following:

**What We Have Learned:** We know that we have learned lots on this project, but the more that we learn the more we get confused about which is fact and which is fiction. The problem within this problem is that there isn't any real proof to say when they came or how. The theory that is most believed is the Bering Strait theory in which people from Asia walked over a land bridge. Another theory is they kayaked the distance between the two continents. We have also unfortunately found racist theories done by people who hate people unlike their own saying that the people of the New World are these people because of human sacrifices and only this race of people would do that.

We have made are [our] own theories using information we found and trying to make sense of it. We have heard some people say they come from outer space but this theory is pretty much out of the question. I don't think the Native peoples or the Inuit would like to hear that theory either.

---

<sup>6</sup>An early version of this software was known as Computer Supported Intentional Learning Environment, or CSILE (pronounced like the name *Cecil*). You can learn more about Knowledge Forum at <http://www.KnowledgeForum.com>.

How they came isn't easily answered for some of the theories but it does make sense [sense] with the Bering Strait theory. (Hewitt et al., 1995, p. 7)

Notice how the students acknowledge that several theories exist about how people first migrated to the New World (i.e., the Western Hemisphere). In other words, they've discovered that absolute truths about a topic aren't always easy to come by—as we'll discover in Chapter 14, this is a fairly sophisticated *epistemic belief* regarding the nature of knowledge. Notice, too, how the students have attempted to evaluate the credibility of various theories they've encountered in their research, reflecting *critical thinking*—one of our topics in Chapter 15.

---

## SUMMARY

*Sociocultural theory* focuses on the importance and specific roles of society and culture in promoting learning and cognitive development. An early, highly influential sociocultural theory is that of Russian psychologist Lev Vygotsky, who conducted numerous studies of children's thinking in the 1920s and early 1930s. Vygotsky proposed that adults promote children's cognitive development by communicating the meanings their culture assigns to objects and events, passing along physical and cognitive tools that make everyday tasks and problems easier, and assisting children with challenging tasks. In Vygotsky's view, social activities are often precursors to and form the basis for complex mental processes: Children initially use new skills in the course of interacting with adults or peers and slowly internalize and modify these skills for their own, independent use.

Vygotsky's theory of cognitive development shares several common themes with Piaget's theory (described in Chapter 12), including principles related to qualitative change, challenge, readiness, and social interaction. However, the two perspectives differ with regard to the role that language plays in cognitive development, the relative value of free versus guided exploratory activities, the relative importance of interactions with peers versus adults, and the influence of culture.

Contemporary theorists have extended Vygotsky's theory in several directions. For instance, some suggest that adults can help children benefit from their experiences through joint construction of meanings,

guided participation, and cognitive apprenticeships. Others recommend that adults engage children in authentic, adultlike tasks, initially providing enough scaffolding that youngsters can accomplish the tasks successfully and gradually withdrawing it as proficiency increases. Still others have effectively combined Vygotsky's ideas with information processing theory to explore the roles of intersubjectivity, social construction of memory, and adult-child collaborations in promoting children's learning and development.

In recent years, some theorists have offered several ideas about how we might further expand our view of how learners' physical and social environments influence their thinking and learning. For example, to some degree thinking and learning may be *situated* in—that is, closely associated with—particular contexts, to the point that learners don't apply the knowledge and skills they've learned in those contexts to very different ones. Another idea gaining popularity is the notion of *distributed* cognition: Learners offload some aspects of a complex task onto physical objects and/or other people and also make use of the various symbolic systems (e.g., charts, formulas) that their culture has created. Most recently, a few theorists have proposed that human cognition may involve *embodiment*, in which a learner's mental processes are intimately and inextricably intertwined with the learner's immediate physical context and bodily reactions to it. From any of these perspectives, learners think effectively only in close interaction and collaboration with their immediate environment.

Sociocultural and other contextual perspectives have numerous implications for instructional practice. For example, Vygotsky and his followers have emphasized the value of formal education for passing along important cognitive tools that a cultural group has created (e.g., concepts and procedures in math, science, social studies, etc.) in order to better understand and respond to the world as people typically experience it. Classroom activities are apt to promote more effective learning and a smoother

integration into adult society when the activities resemble real-world tasks (i.e., when they're *authentic*) and when they're sufficiently scaffolded to ensure student success. Also, appropriately structured peer-interactive instructional strategies—class discussions, reciprocal teaching, cooperative learning, peer tutoring, communities of learners, and technology-based collaborative learning—can be especially effective in helping students make cognitive advancements and think in increasingly complex ways.

# METACOGNITION, SELF-REGULATED LEARNING, AND STUDY STRATEGIES

### *Metacognitive Knowledge and Skills*

#### *Self-Regulated Learning*

*The Roots of Self-Regulated Learning*

#### *Effective Learning and Study Strategies*

*Meaningful Learning and Elaboration*

*Organization*

*Note Taking*

*Identifying Important Information*

*Summarizing*

*Comprehension Monitoring*

*Mnemonics*

### *Development of Metacognitive Knowledge and Skills*

#### *Epistemic Beliefs*

*Developmental and Cultural Differences*

*in Epistemic Beliefs*

*Effects of Epistemic Beliefs*

#### *The Intentional Learner*

*Why Students Don't Always Use Effective*

*Strategies*

*Promoting Effective Learning and Study*

*Strategies*

*Summary*

When I look back on my days as a high school student, I think about how I used to learn—or at least *tried* to learn—and shudder. Although I was a reasonably good student, my ideas about how I could best study were incredibly naive. For example, I remember sitting on my bed “reading” my history textbook at night: My eyes dutifully went down each page, focusing briefly on every line, but my mind was miles away.<sup>1</sup> After completing a reading assignment, I often couldn’t remember a thing I’d read, yet I had the crazy notion that my supposed “knowledge” of history would miraculously bubble to the surface at test time (it didn’t). I remember, too, studying vocabulary words for my class in Mandarin Chinese: I truly believed that simply repeating the words over and over again would get them through my thick skull. In retrospect, the only subject I learned well was math, because I could easily make sense of the various mathematical concepts and principles I was studying.

When I went to college, I continued to bumble along, spending considerable time in mindless “reading” and taking notes in class that now I can barely comprehend (I have to wonder how much they helped me even then). Only after a great deal of studying experience and considerable trial and error did I begin to realize how important it was that I pay attention to course material with my mind as well as my eyes and that I try to understand what I was studying.

As you’ve been reading this book, you have, I hope, been learning a great deal about how you learn and remember; perhaps you’ve also been modifying your approach to your own learning tasks. For example, you may now be trying to pay closer attention to what you read in textbooks and what you hear in class. You may also be focusing more on understanding, organizing, and elaborating on your course material. In any case, I hope you’re not reading this book the way I used to read my history text.

People’s awareness and understandings of their own thinking and learning processes, as well as their regulation of those processes to enhance their learning and memory, are collectively

---

<sup>1</sup>Such mindless “reading” is quite common (Reichle, Reineberg, & Schooler, 2010).



How, as a metacognitively naive high school student, the author read her history textbook

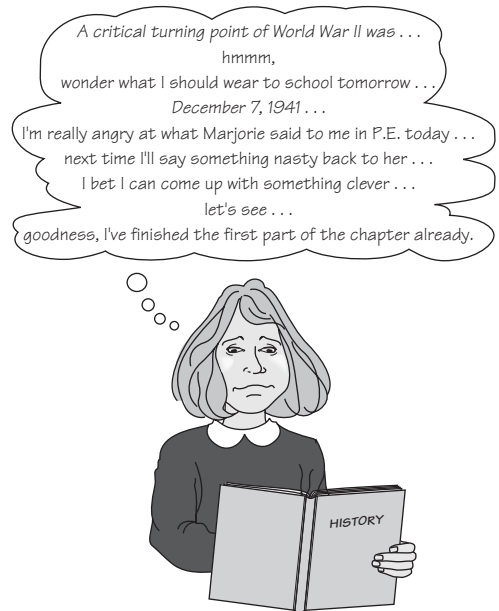

known as **metacognition**.<sup>2</sup> The more metacognitively sophisticated students are, the better their school learning and achievement are likely to be (e.g., J. Lee & Shute, 2010; P. A. Ornstein, Grammer, & Coffman, 2010). Unfortunately, many students of all ages—even many adults—appear to know little about effective learning and memory strategies.

Metacognition is closely connected to the *central executive* I described in Chapter 8. You might think of it as the “manager” or “coach” of a person’s learning (Schoenfeld, 1985): It guides information processing and monitors the effectiveness of various strategies being applied to the task at hand. But just as a basketball coach might either be quite knowledgeable about basketball or, instead, harbor counterproductive ideas about how best to play the game, so, too, can a learner’s metacognitive knowledge be either a help or a hindrance in the learning process.

In this chapter, we’ll look at the many aspects of metacognition that researchers have uncovered. We’ll also identify instructional practices that can help students become metacognitively more sophisticated and thus better able to learn and achieve over the long run.

## METACOGNITIVE KNOWLEDGE AND SKILLS

Metacognition includes knowledge and skills such as the following:

- Knowing what one’s own learning and memory capabilities are and what learning tasks one can realistically accomplish (e.g., recognizing that it isn’t possible to memorize 200 pages of text in a single evening)
- Knowing which learning strategies are effective and which are not (e.g., realizing that meaningful learning is more effective than rote learning)

<sup>2</sup>You may occasionally see the terms *metamemory* and *hypercognition*.

- Planning a viable approach to a new learning task (e.g., finding a quiet place to study)
- Tailoring learning strategies to the circumstances (e.g., taking detailed notes when lecture material might be hard to remember)
- Monitoring one's present knowledge state (e.g., determining whether information has or hasn't been successfully learned)
- Knowing effective strategies for retrieval of previously stored information (e.g., thinking about the context in which a certain piece of information was probably learned)

In essence, then, metacognition is *thinking about thinking*. As you can see, it involves some fairly complex, abstract ideas and processes. Many of these ideas and processes aren't specifically taught at school. Thus, it shouldn't surprise you to learn that students typically acquire metacognitive knowledge and skills quite slowly—if they acquire them at all—and only after many challenging learning experiences.<sup>3</sup>

As an example of metacognition, let's consider what happens when students study their textbooks. Their reading must, of course, be much more than simply identifying the words on the page; students must also make sense of what they're reading so that they can effectively store it in long-term memory and retrieve it later on. In other words, students must *read for learning*.

What specifically do students do when they read for learning? Good readers—those who understand and effectively remember what they read—do many of the following:

- Clarify their purpose for reading something and tailor their reading strategies to fit their purpose
- Determine what's most important to learn and remember, and focus their attention and efforts accordingly
- Draw on their prior knowledge to make sense of what they're reading
- Make use of illustrations, diagrams, and other embedded visual materials to help them in their sense-making efforts
- Elaborate on what they read—for instance, by drawing inferences, identifying logical relationships, making predictions, and envisioning possible examples or applications
- Ask themselves questions that they try to answer as they read
- Periodically check themselves to make sure they understand and remember what they've read
- Try to clarify seemingly ambiguous points
- Persist in their efforts to understand when they initially have trouble understanding something
- Read for possible conceptual change—in other words, read with the understanding that they may encounter ideas that are inconsistent with what they currently believe
- Critically evaluate what they read
- Summarize what they've read (L. Baker, 1989; C. Chan, Burtis, & Bereiter, 1997; Cromley, Snyder, Luciw, & Tanaka, 2008; Cromley, Snyder-Hogan, & Luciw-Dubas, 2010a; Dole, Duffy, Roehler, & Pearson, 1991; E. Fox, 2009; Graesser & Bower, 1990; Hacker, 1998b; Palincsar & Brown, 1989)

Such strategies are important not only in reading traditional textbooks but also in gaining information from Internet websites and other computer-based sources (Afflerbach & Cho, 2010;

---

<sup>3</sup>We humans aren't the only species with metacognitive skills; for example, see Foote & Crystal, 2007; Kornell, 2009; Kornell, Son, & Terrace, 2007.

**How the author *should* have read her history textbook**

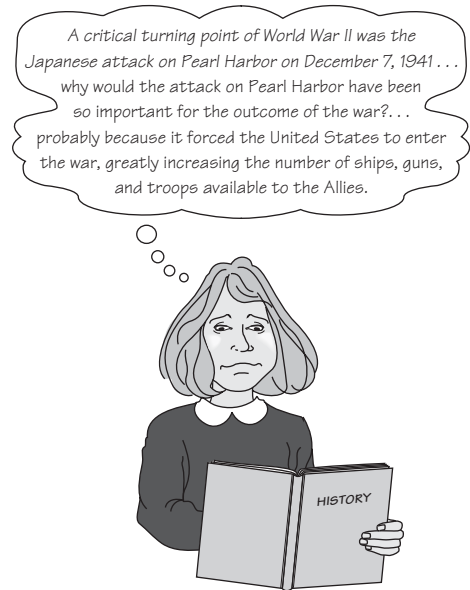

Azevedo & Witherspoon, 2009; Leu, O’Byrne, Zawilinski, McVerry, & Everett-Cacopardo, 2009; Niederhauser, 2008).<sup>4</sup>

In contrast, poor readers—those who have trouble learning and remembering what they read—use few of the strategies just listed. For example, they may have little focus and sense of purpose as they read a passage. They draw few, if any, inferences and overlook inconsistencies among ideas. And, in general, poor readers seem to have little metacognitive awareness of what they should do mentally as they read (L. Baker, 1989; A. L. Brown & Palincsar, 1987; E. Fox, 2009; McKeown & Beck, 2009; Oakhill, 1993). As examples, consider two low-achieving high school students’ descriptions of how they studied:

- I stare real hard at the page, blink my eyes and then open them—and cross my fingers that it will be right here (points at head).
- It’s easy. If [the teacher] says study, I read it twice. If she says read, it’s just once through. (A. L. Brown & Palincsar, 1987, p. 83)

Not all students are so metacognitively naive. For example, as 9-year-old Eamon describes what he does when he encounters new ideas in science, he seems to have a fairly good understanding of meaningful learning and the dynamic nature of knowledge:

I try to look for a fit. Like if it doesn’t fit with any . . . of the ideas that I have in my head I just leave it and wait for other ideas to come in so that I can try to fit them together with my ideas. Maybe they will go with my ideas and then another idea will come in and I can fit it together with that idea and my understanding just keeps on enlarging. An idea usually does fit. (M. G. Hennessey, 2003, p. 123)

<sup>4</sup>See Afflerbach and Cho (2010) for an excellent discussion of reading strategies that Internet-based learning requires.

It appears, then, that Eamon has some explicit knowledge of his own thought processes: He can actively think about and describe them. Yet a good deal of metacognition may be *implicit*: People often regulate their learning processes without conscious awareness that they're doing so.<sup>5</sup>

The process of metacognition is consistent with social cognitive theorists' notion of *self-regulation*: It provides the mechanism through which people begin to regulate one aspect of their lives—their own learning. We now look at what self-regulated learning involves.

## SELF-REGULATED LEARNING

---

In our discussion of self-regulation in Chapter 6, we discovered that as children grow older, most of them begin to set standards and goals for their own performance. They then choose behaviors they think will help them meet their standards and goals, and they evaluate the effects of their actions.

Cognitive and social cognitive theorists have begun to portray effective learning in a similar manner—as a process of setting goals, choosing learning strategies that are likely to help one achieve those goals, and then evaluating the results of one's efforts. Yet increasingly, theorists have begun to realize that effective learning includes control of one's motivation and emotions as well. Thus, **self-regulated learning** typically includes most or all of the following:

- *Goal setting*: Self-regulating learners know what they want to accomplish when they read or study—perhaps to learn specific facts, get a general understanding of the material, or simply acquire sufficient knowledge to do well on a classroom exam (Muis, 2007; Nolen, 1996; Winne & Hadwin, 1998). Typically they tie their immediate studying goals to longer-term goals and aspirations (Zimmerman & Moylan, 2009). And especially as they reach college, they may set deadlines for themselves as a way of making sure they don't leave important learning tasks until the last minute (Ariely & Wertenbroch, 2002).
- *Planning*: Self-regulating learners plan their approach to a learning task and use their time effectively to accomplish their goals (Muis, 2007; Zimmerman, 2008; Zimmerman & Moylan, 2009). Typically they devote more time to more difficult material—although they may sometimes review easy material to make sure they still know it—and they may intentionally ignore material they think is so difficult that they can't possibly master it in the time they have (Kornell & Bjork, 2008; Metcalfe, 2009; Serra & Metcalfe, 2009).
- *Self-motivation*: Self-regulating learners typically have high self-efficacy regarding their ability to accomplish a learning task (Schunk & Pajares, 2005; Trautwein, Lüdtke, Kastens, & Köller, 2006). They also show considerable self-discipline, putting work before pleasure—that is, delaying gratification (Bembenutty & Karabenick, 2004; Duckworth & Seligman, 2005). And they use a variety of strategies to keep themselves on task—perhaps embellishing on a boring assignment to make it more fun, reminding themselves of the importance of doing well, giving themselves a self-efficacy “pep talk” (“I did well before, so I can certainly do well again!”), or promising themselves a reward

---

<sup>5</sup>Some theorists propose that the phenomenon we call *metacognition* includes both explicit and implicit knowledge, but others suggest that we should use the term only to refer to knowledge and processes of which people are consciously aware (e.g., Cornoldi, 2010; diSessa et al., 2003; Hacker, 1998a). I use the term in its broader sense, which encompasses both explicit and implicit knowledge.

after they've finished (Fries, Dietz, & Schmid, 2008; Wolters, 2000, 2003a; Wolters & Rosenthal, 2000).

- *Attention control*: Maximizing attention on the learning task. Self-regulating learners try to focus their attention on the subject matter at hand and to clear their minds of potentially distracting thoughts and emotions (Cacioppo et al., 2007; S. Kaplan & Berman, 2010; Wolters, 2003a).
- *Use of effective, goal-relevant learning strategies*: Self-regulating learners have a wide variety of learning strategies at their disposal, and they use different ones depending on their specific goal for a learning task. For example, they read a magazine article differently depending on whether they're reading it for entertainment or studying for an exam (Linderholm & van den Broek, 2002; Winne, 1995; Wolters, 2003a; Zimmerman & Moylan, 2009).
- *Self-monitoring*: Self-regulating learners continually monitor their progress during a learning activity, and they change their learning strategies or modify their goals if necessary (D. L. Butler & Winne, 1995; J. A. Greene & Azevedo, 2009; Thiede, Anderson, & Theriault, 2003; Zimmerman & Moylan, 2009).
- *Appropriate help-seeking*: Self-regulated learning doesn't always involve learning independently. Self-regulating learners know when they need an expert's help to master certain topics or skills, and on such occasions they actively seek it out (Alevin, Stahl, Schworm, Fischer, & Wallace, 2003; Karabenick & Sharma, 1994; J. Lee & Shute, 2010; Newman, 2008).
- *Self-evaluation*: Self-regulating learners determine whether what they've ultimately learned is sufficient for the goal(s) they've set for themselves (Andrade, 2010; D. L. Butler & Winne, 1995; Muis, 2007; Zimmerman & Schunk, 2004).
- *Self-reflection*: Self-regulating learners evaluate the extent to which their learning strategies have been successful and efficient, and they may subsequently identify alternatives that might be more effective in the future (D. Kuhn, 2001b; Winne & Stockley, 1998; Zimmerman & Moylan, 2009).

When students are self-regulating learners, they set higher academic goals for themselves, learn more effectively, and achieve at higher levels (Bronson, 2000; D. L. Butler & Winne, 1995; Kramarski & Michalsky, 2009; Winne, 1995; Zimmerman & Risemberg, 1997). Unfortunately, only a small minority of students acquire a high level of self-regulation, perhaps in part because traditional instructional practices do little to promote it (Paris & Ayres, 1994; Zimmerman & Bandura, 1994).

## The Roots of Self-Regulated Learning

To some extent, self-regulated learning probably develops from opportunities to engage in independent, self-directed learning activities appropriate for the age-group (Coplan & Arbeau, 2009; Corno & Mandinach, 2004; Paris & Paris, 2001; Zimmerman, 2004). Regular exposure to self-regulating models—adults and peers who set high standards for their own performance, effectively keep themselves on task, and so on—may play a role as well (Corno & Mandinach, 2004; Zimmerman, 2004).

But if we take Vygotsky's perspective for a moment, we might reasonably suspect that self-regulated learning also has roots in socially regulated learning (Stright, Neitzel, Sears, & Hoke-Sinex, 2001; Vygotsky, 1934/1986). At first, other people (e.g., parents or teachers) might help

children learn by setting goals for a learning activity, keeping children's attention focused on the learning task, suggesting effective learning strategies, monitoring learning progress, and so on. Over time, children assume increasing responsibility for these processes: They begin to set their own learning goals, stay on task with little prodding from others, identify potentially effective strategies, and assess their own learning.

How might children make the transition from other-regulated learning to self-regulated learning? A possible answer can be found in our previous discussion of collaborative use of cognitive strategies in Chapter 13. From a Vygotskian perspective, a reasonable bridge between other-regulated learning and self-regulated learning is **co-regulated learning**, in which an adult and one or more children share responsibility for directing the various aspects of the learning process (Bodrova & Leong, 1996; McCaslin & Good, 1996; McCaslin & Hickey, 2001; for a related perspective, see Volet, Vaura, & Salonen, 2009). For instance, the adult and children might agree on the specific goals of a learning endeavor, or the adult might describe the criteria that indicate successful learning and then have children evaluate their own performance in light of those criteria. Initially, the adult might provide considerable structure, or scaffolding, for the children's learning efforts; in a true Vygotskian fashion, such scaffolding is gradually removed as children become more effectively self-regulating. Later in the chapter we'll consider several strategies that teachers might use to facilitate the development of self-regulation in students at a variety of age levels.

## EFFECTIVE LEARNING AND STUDY STRATEGIES ---

In my descriptions of cognitive theories in earlier chapters, I've often alluded to people's strategies for learning, studying, solving problems, and so on. Perhaps we should stop for a moment to consider what we actually mean by the term *strategy*. Sometimes people engage in effective storage processes with little conscious awareness of what they're doing (Kintsch, 1998; Stanovich, 1999). For instance, as you read an enjoyable novel, you may automatically relate events in the story to similar events in your own life. But generally speaking, when psychologists use the terms **learning strategy** and **study strategy**, they're talking about the *intentional* use of one or more cognitive processes to accomplish a particular learning task (P. A. Alexander, Graham, & Harris, 1998; Siegler & Alibali, 2005; Pressley & Harris, 2006).<sup>6</sup>

In the next few pages we'll consider research findings regarding several effective learning and study strategies. The first three—meaningful learning, elaboration, and organization—are long-term memory storage processes we initially considered in Chapter 9. The others—note taking, identifying important information, summarizing, comprehension monitoring, and mnemonics—are additional strategies that researchers have consistently found to be valuable techniques in academic learning tasks.

### Meaningful Learning and Elaboration

In Chapter 9, I described *meaningful learning* as a process of relating new material to knowledge already stored in long-term memory and *elaboration* as a process of using prior knowledge to interpret and expand on the material. Both processes clearly facilitate learning during study

---

<sup>6</sup>Snowman (1986) has suggested that we distinguish between more general *learning strategies* (overall plans for accomplishing a learning task) and *learning tactics* (more specific techniques executed during the learning task itself). For the most part, the strategies I describe in this chapter are of the more specific, tactical type.

activities. For example, in a study by Van Rossum and Schenk (1984), college students read and took notes on a historical passage and then took a test on the contents of the passage and answered questions about how they had studied. Approximately half of the students described rote-learning approaches: They interpreted the objective of the assignment as one of memorizing facts (e.g., “learning everything by heart”) and studied accordingly. The other half described meaningful and elaborative approaches: They tried to understand, interpret, and apply what they read, as one student’s self-report revealed:

First I read the text roughly through and try to form a picture of the content. The second time I read more accurately and try through the structure of the text to make the small connections in and between the paragraphs. The third or fourth time I try to repeat to myself, without looking at the text, the main lines of the argument, emphasizing reasonings. (Van Rossum & Schenk, 1984, p. 77)

The two groups of students recalled specific facts from the passage equally well, but those who used meaningful learning strategies performed better on multiple-choice questions that required drawing inferences, and they produced better-integrated and qualitatively superior responses on an essay test over the same material.

Students appear to study classroom subject matter very differently depending on whether they’re trying to remember facts or generate applications—in other words, depending on whether or not they’re trying to elaborate on what they learn (Muis, 2007; Muis & Franco, 2009). For example, in a study conducted by one of my doctoral students, Rose McCallin (McCallin, Ormrod, & Cochran, 1997), undergraduate education majors who were currently enrolled in an educational psychology class completed a questionnaire that assessed their approach to learning the course material. Some students described themselves as wanting to learn specific teaching techniques; in other words, they wanted to be told exactly what they should do in their future classrooms. Other students described themselves as preferring to understand psychological principles of human learning and behavior so that they could develop their *own* classroom procedures. Following the course’s unit on educational assessment, McCallin gave the students a list of basic concepts from the unit and asked them to draw a diagram (concept map) that showed how the concepts were interrelated. Students with a tell-me-what-to-do attitude tended to depict relationships that were simplistically factual or procedural (e.g., “*Raw scores* are used to compute a *mean*”). In contrast, students with a let-me-apply-it-myself attitude depicted relationships that reflected more sophisticated processing, including hierarchical structures, cause-and-effect connections, and deductive reasoning (e.g., “*Reliability affects the standard error of measurement*”).

## Organization

In Chapter 9, we examined evidence for the value of *internal organization*—finding connections and interrelationships within a body of new information. A variety of techniques help students organize classroom material effectively. One common approach is to create an outline of the major topics and ideas—an approach that facilitates classroom learning for many students (McDaniel & Einstein, 1989; Wade, 1992). Curiously, however, high-achieving students are *less* likely to create outlines than their average-ability classmates (L. Baker, 1989). It may be that better students organize material easily enough in their heads that paper-and-pencil outlines aren’t necessary.

A second approach—one that’s often more effective than outlining—is to integrate new material in a graphic representation, perhaps as a map, flowchart, or matrix (R. K. Atkinson et al.,

1999; Dansereau, 1995; D. H. Robinson & Kiewra, 1995; Scevak, Moore, & Kirby, 1993; Van Patten, Chao, & Reigeluth, 1986). For example, high school students can better remember historical events when they record the events on a map that depicts where each one took place (Scevak et al., 1993). As another example, consider how students might better remember the sequence in which various historical events occurred. A number of years ago, my son Alex (then a high school senior) and I took an undergraduate art history course at my university. The first unit of the course covered a 40,000-year span, including prehistoric art (e.g., cave paintings), Mesopotamian art (e.g., the Gates of Ishtar), and ancient Egyptian art (e.g., the pyramids at Giza). As we studied for our first test, Alex and I had a hard time keeping the time periods of all the cultures and artistic styles straight. We finally constructed a time line, depicted in Figure 14.1, that organized what was happening when and kept us from going into severe numbers shock. The time line didn't necessarily help us make better sense of events, but it did help us keep track of them and encode what we were studying visually as well as verbally.

Another strategy for graphically organizing information is to create a *concept map*. In Chapter 9, I described a concept map as a way that teachers can depict the overall organizational structure of a lesson or unit. Yet students can also create their *own* concept maps for a lesson. Figure 14.2 shows concept maps that two different students might construct after a lesson about gorillas. Notice how very different the knowledge of the two students appears to be, even though both students received the same information.

Self-constructed concept maps often enhance students' learning, probably for several reasons (Haugwitz, Sumfleth, & Sandmann, 2010; Holley & Dansereau, 1984; Mintzes, Wandersee, & Novak, 1997; Nesbit & Adesope, 2006; Novak, 1998). By focusing on how concepts relate to one another, students organize material better. They're also more likely to notice how new concepts are related to things they already know; thus they're more likely to learn the material meaningfully. And, like such graphic techniques as geographical maps and historical time lines, concept maps can help students encode information in long-term memory visually as well as verbally. Concept maps can be especially helpful to low-achieving students, perhaps because they provide a means of helping these students process information in ways that high-achieving students do more regularly (Dansereau, 1995; Haugwitz et al., 2010; Mintzes et al., 1997; Stensvold & Wilson, 1990).

Student-constructed concept maps can provide information to teachers as well as to students, in particular by revealing possible gaps and misconceptions in students' understandings (Novak, 1998; Novak & Musonda, 1991). For example, the concept map on the left side of Figure 14.2 reveals spotty, fragmented knowledge about gorillas. Furthermore, the student has two ideas that need correction. First, contrary to a common stereotype, gorillas don't swing from trees, although young ones may occasionally climb a tree to escape danger. Second, gorillas aren't especially "fierce" creatures. For the most part, they live a fairly peaceful existence within their family group; they get nasty (e.g., by beating their chests) only when a human being, non-family-member gorilla, or other potential encroacher threatens their territory.

## Note Taking

In general, taking notes on new information is positively correlated with student learning (S. L. Benton, Kiewra, Whitfill, & Dennison, 1993; Di Vesta & Gray, 1972; J. Lee & Shute, 2010; Peverly, Brobst, Graham, & Shaw, 2003). Note taking probably serves at least three functions for students. First, it keeps students' *attention* on the subject matter being presented. Second, it



	<i>Europe</i>	<i>Mesopotamia</i>	<i>Egypt</i>
<i>8000 B.C.</i>	<i>Paleolithic 40,000–8000</i>		
	<i>Mesolithic 8000–7000</i>		
<i>4000 B.C.</i>	<i>Neolithic 7000–2300</i>		
<i>3000 B.C.</i>	<i>Bronze Age 2300–1000</i>	<i>Sumer 3500–2340</i>	<i>Early Dynasty (Archaic) 3150–2700</i>
			<i>Old Kingdom 2700–2190</i>
<i>Akkadians 2340–2180</i>			
<i>neo-Sumer 2150–2030</i>			
<i>Babylonia 1790–1750</i>		<i>Middle Kingdom 2040–1674</i>	
<i>2000 B.C.</i>		<i>Hittites / Anatolia 1600–1200</i>	<i>New Kingdom 1552–1069</i>
<i>1000 B.C.</i>		<i>Assyrians 1000–612</i>	
		<i>neo-Babylonia 612–540</i>	
		<i>Persia 560–330</i>	

**Figure 14.1**

The Ormrod time line for prehistoric, Mesopotamian, and ancient Egyptian art

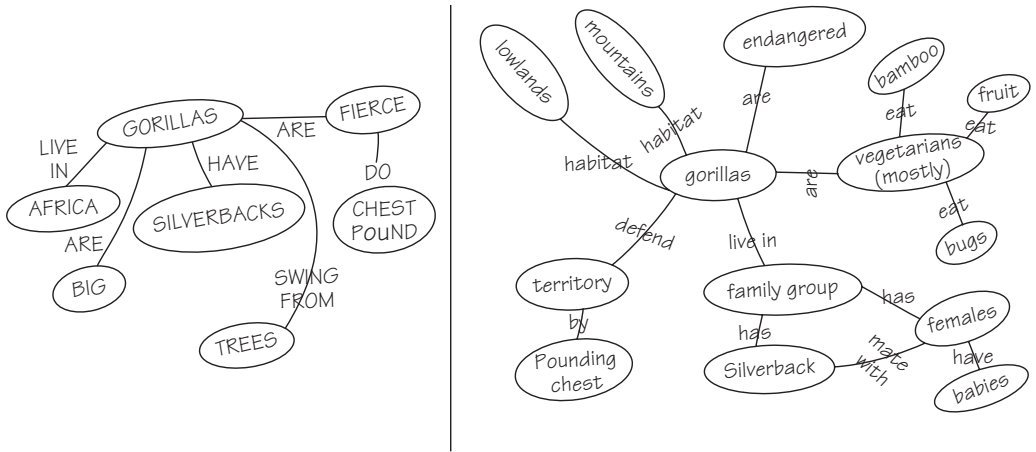

**Figure 14.2**  
Two concept maps about gorillas

facilitates *encoding* of the material: By writing new information and seeing it on paper, students are apt to encode it both verbally and visually. Finally, notes serve as a form of concrete *external storage* for information presented in class: Given the notorious fallibility of long-term memory (see Chapter 11), pen and paper often provide a dependable alternative that allows later review and study.

In my own classes I've often observed how very different the notes of various students can be, even though everyone has attended the same class sessions. Some students write extensively; others write very little. Some students try to capture all the main ideas of a lecture or explanation, whereas others only copy the specific words I write on the board—mostly terms and definitions. Some students include details and examples in their notes; others don't. As you might guess, such differences in quantity and quality have a significant impact on what students learn and remember. In general, notes are more useful when they're relatively comprehensive—including main ideas, supporting details, and possibly also students' personal elaborations—and when they're consistent with the instructional objectives of a lesson or unit (J. E. Barnett, Di Vesta, & Rogozinski, 1981; S. L. Benton et al., 1993; Kiewra, 1985, 1989; Peverly et al., 2003, 2007).

Another effective technique is reorganizing and elaborating on notes that were previously taken during a lecture or reading assignment (Kiewra, 1985; Shimmerlick & Nolan, 1976). Especially in a lecture, students have no control over how fast information is presented and may not have time to process everything meaningfully (Ku, Chan, Wu, & Chen, 2008). In such a case, students may need to focus merely on writing information during class and then appropriately organizing and encoding it afterward.

Teachers can do several simple things to improve the quality and completeness of students' notes. Writing important ideas on the chalkboard can be helpful: Students are far more likely to write down those things that their teacher writes. Emphasizing important ideas (e.g., by repeating them) also increases the likelihood that students will record the ideas on paper. Furthermore,

The effectiveness of note taking depends on the type of notes taken.

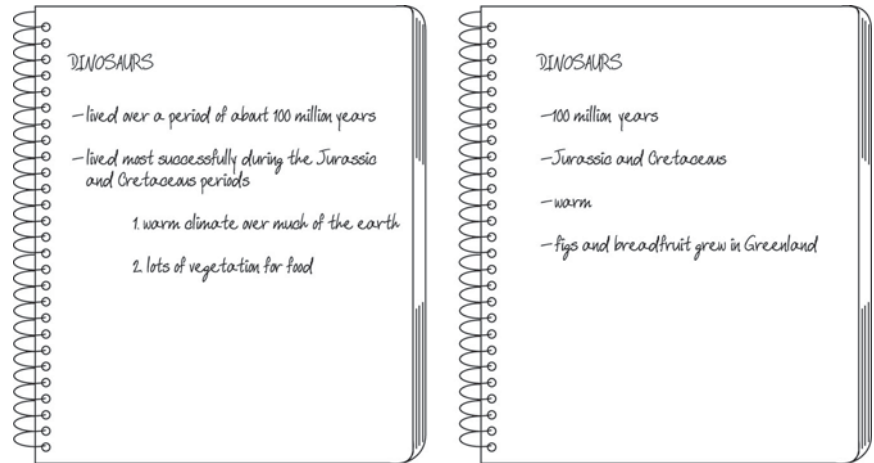

providing some kind of general organizational framework—a skeletal outline, a compare-and-contrast matrix, or the like—facilitates students’ ability to organize information in ways that their teacher envisions (S. L. Benton et al., 1993; Kiewra, 1989; Pressley, Yokoi, Van Meter, Van Etten, & Freebern, 1997; Van Meter, Yokoi, & Pressley, 1994).

## Identifying Important Information

Students often encounter more information than they can possibly store in long-term memory within a reasonable time period. As a result, they must determine which things are most important for them to learn and study—for instance, they must separate main ideas from trivial details. The task is often a challenging one, in part because the relative “importance” of different ideas is ultimately determined by the teacher, who may have a different perspective on the material than students do (P. A. Alexander & Jetton, 1996; Broekkamp, Van Hout-Wolters, Rijlaarsdam, & van den Bergh, 2002; R. E. Reynolds & Shirey, 1988; Schellings, Van Hout-Wolters, & Vermunt, 1996).

The various *signals* presented in a lecture or textbook (e.g., specified objectives of a lesson, boldfaced or italicized words, ideas written on the chalkboard) can help students discriminate between important and unimportant information (recall our discussion of signals in Chapter 9). But sometimes students overlook or misinterpret these signals, and in other cases signals are few and far between. In the absence of useful signals, students often have trouble identifying the main points of a lecture or reading assignment, especially if they have little background knowledge about the topic they’re studying (Byrnes, 1996; Dole et al., 1991; Garner, Alexander, Gillingham, Kulikowich, & Brown, 1991). Many students use relatively superficial strategies in choosing what to focus on—for instance, looking at the first sentence of each paragraph or zeroing in on definitions and formulas—and often miss critical ideas as a result (A. L. Brown & Palincsar, 1987; Mayer, 1984; Pallock & Surber, 1997; Surber, 2001).

Once students become proficient at identifying important information, then underlining or highlighting the information is apt to be beneficial, at least in materials that students personally own (e.g., class notes, purchased textbooks). I encourage my own students to underline or highlight the important ideas in their textbooks; doing so is less time consuming than taking notes on a book’s content, and it keeps specific information within its larger context. But underlining and

highlighting are probably effective only when used sparingly to emphasize main ideas and essential details (Snowman, 1986). Highlighting an entire page, as if with a paint roller, can hardly be of much value.

## Summarizing

On average, students learn and remember new material more effectively when they create a summary of it—for instance, by condensing and integrating it, deriving abstract representations of it, or identifying suitable headings to label it (L. Gil, Bråten, Vidal-Abarca, & Strømsø, 2010; Jonassen, Hartley, & Trueman, 1986; A. King, 1992; Mayer, 2010b; T. Shanahan, 2004; Wittrock & Alesandrini, 1990). If we think about it, we realize that developing a good summary is a fairly challenging task: Students must discriminate between important and unimportant information, identify main ideas that may or may not be explicitly stated, and organize critical elements into a cohesive whole. It's not surprising, then, that many students have trouble adequately summarizing what they read and hear (V. Anderson & Hidi, 1988/1989; S. Greene & Ackerman, 1995; Spivey, 1997).

Researchers have offered several suggestions for helping students create good summaries of classroom subject matter:

- Provide a scaffold such as the following to guide students' initial efforts:  
This paragraph is about \_\_\_\_ and \_\_\_\_\_. In some ways they are the same.  
\_\_\_\_\_. In other ways they are different. \_\_\_\_\_.
- When students are writing a summary, suggest that they (1) identify or invent a topic sentence for each paragraph or section, (2) identify superordinate concepts or ideas that subsume several more specific points, (3) find supporting information for each main idea, and (4) delete trivial and redundant information.
- Have students first practice developing summaries for short, easy, and well-organized passages (perhaps those only a few paragraphs in length), and then gradually introduce longer and more difficult texts to be summarized.
- Have students compare and discuss their summaries, considering what ideas they thought were important and why. (V. Anderson & Hidi, 1988/1989; A. L. Brown & Day, 1983; Rinehart, Stahl, & Erickson, 1986; Rosenshine & Meister, 1992; J. P. Williams, Stafford, Lauer, Hall, & Pollini, 2009, p. 6)

Computer software is also available to scaffold the summary-writing process (e.g., see Wade-Stein & Kintsch, 2004).

## Comprehension Monitoring

Students who learn most effectively typically check themselves periodically to be sure they're understanding and remembering what they hear in class or read in a textbook. They also take steps to remediate any comprehension difficulties they have—for example, by asking questions or rereading a passage. In other words, good students engage in **comprehension monitoring**<sup>7</sup> (L. Baker, 1989; Hacker, Dunlosky, & Graesser, 2009b; Otero & Kintsch, 1992).

<sup>7</sup>Theorists are talking about a similar idea when they use the terms *metacomprehension*, *self-regulated comprehension*, *calibration*, *judgment of learning*, and *metamnemonic evaluation*.

Unfortunately, many students of all ages *don't* carefully monitor their comprehension as they sit in class or read a textbook (Dunlosky & Lipko, 2007; Nokes & Dole, 2004; Zhao & Linderhold, 2008). As a result, they're often ignorant about what they know and don't know, and they may think they understand something they actually *misunderstand*. In other words, they have an **illusion of knowing**.<sup>8</sup> Students are especially likely to have an illusion of knowing something when they have little prior knowledge about the subject matter or when the material is especially difficult for them (Maki, 1998; N. J. Stone, 2000; Thiede, Griffin, Wiley, & Redford, 2009; Zhao & Linderhold, 2008). Illusions of knowing are also more common when students have overly simplistic ideas of what it means to “know” something (more on this point in the upcoming section on epistemic beliefs).

When students think they know classroom material, they're apt to stop studying it. Thus, students who have only the *illusion* of knowing it will stop studying prematurely (Dunning, Heath, & Suls, 2004; Kornell & Bjork, 2008; Schneider, 2010). And they're likely to be quite puzzled when, as a result, they perform poorly on an exam or assignment (Hacker, Bol, Horgan, & Rakow, 2000; Horgan, 1990). For example, students occasionally approach me to express their confusion about why they did so poorly on an exam when they “knew” the information so well. When I ask these students specific questions about the material, I usually find that they don't really have a good grasp of it at all.

Some of the strategies I've described in previous sections of the chapter—for instance, creating graphic organizers and summarizing material—are effective, in part, because they help students monitor their comprehension (Dunlosky & Lipko, 2007; Thiede et al., 2009; Van Meter, 2001). Another effective strategy is **self-questioning**, in which students formulate questions before—and ideally also *during*—a lesson or reading assignment and then try to answer the

Students aren't always accurate judges of what they know and what they don't.

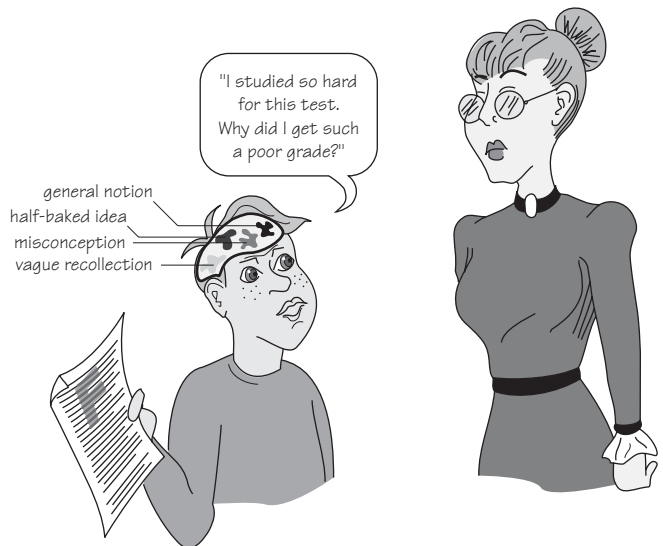

<sup>8</sup>You may also see the term *secondary ignorance*.

questions as they go along (Martínez, Bannan-Ritland, Kitsantas, & Baek, 2008; Otero, 2009; Rosenshine, Meister, & Chapman, 1996; Wong, 1985). By periodically asking themselves and then trying to answer questions, students are more likely to know when they know something and when they don't. Ideally, some self-questions should require elaborative processing—drawing inferences, thinking of new examples, and so on. For instance, teachers might encourage students to ask themselves questions such as the following:

- Explain why (how) . . .
- How would you use . . . to . . . ?
- What is a new example of . . . ?
- What do you think would happen if . . . ?
- What is the difference between . . . and . . . ?
- How are . . . and . . . similar?
- What are the strengths and weaknesses of . . . ?
- How is . . . related to . . . that we studied earlier? (A. King, 1992, p. 309)

Ideally, students should assess their understanding of class material not only immediately but also after some time has elapsed—perhaps after a few minutes, hours, or days. Learners are often inaccurate and overly optimistic judges of how much they'll be able to remember about something they've just heard or read (Dunlosky & Lipko, 2007; Serra & Metcalfe, 2009; Weaver & Kelemen, 1997). In a simple illustration of this principle (T. O. Nelson & Dunlosky, 1991), undergraduate students studied a series of 60 paired associates (e.g., *ocean–tree*) for 8 seconds apiece. Students were asked how confident they were that in 10 minutes' time they would be able to remember the second word in each pair when cued with the first; this question was sometimes asked immediately after a word pair had been presented (immediate condition) and sometimes asked after several minutes had elapsed (delayed condition). After studying all 60 pairs, students were tested for their actual ability to recall the second word in every pair. Their predictions were far more accurate for word pairs in the delayed condition than for pairs in the immediate condition; in the immediate condition, students believed they would remember many more pairs than they actually did. The problem with judging one's knowledge of something immediately after studying it, the researchers reasoned, is that the information is still in working memory and therefore can easily be retrieved. Ideally, students need to judge the likelihood that they can retrieve information from long-term memory as well—something they can judge only when they monitor their comprehension after some time has elapsed.

## Mnemonics

Most of the strategies we've discussed so far are based on the assumption that the material makes sense and can be logically organized. But if you reflect back on your own educational experiences, you can probably recall many situations in which you had trouble learning important information because it didn't hang together in any logical way. Perhaps the troublesome material consisted of long lists of items, unfamiliar words in a foreign language, or particular rules of grammar, spelling, or mathematics. **Mnemonics**—memory tricks—are devices that facilitate learning and memory of many forms of hard-to-remember material.

For example, in my recent travels to faraway places, I've found that good tour guides often give English-speaking travelers easy ways to remember non-English words. My Moroccan guide suggested that I could more easily remember his name—Ghali—by thinking of the common

expression “Golly gee!” An Egyptian guide suggested that my group could more easily pronounce and remember Queen Hapshepsut’s name if we thought “hat ship suit.” And the Saqsaywaman Incan ruins in Peru were easier to remember as “sexy woman.”

Here we’ll look at three general types of mnemonics: verbal mediation, visual imagery, and superimposed meaningful structures.

### ***Verbal Mediation***

Imagine that you’re trying to remember that the German word *Handschuh* means *glove*. Playing off how the word sounds phonetically, you might remember this word by thinking of a glove as a “shoe for the hand.” Such a mnemonic is an example of **verbal mediation**, in which two words or ideas are associated by a word or phrase (the verbal mediator) that connects them. Here are some examples of verbal mediators for other German vocabulary words:

<b>German Word</b>	<b>English Meaning</b>	<b>Mediator</b>
<i>der Hund</i>	dog	hound
<i>das Schwein</i>	pig	swine
<i>die Gans</i>	goose	gander
<i>der Stier</i>	bull	steer

Notice that in every case, the verbal mediator bridges the gap between the German word and its English equivalent. By storing the mediator, you can make a connection between the two words.

Verbal mediators clearly facilitate learning (e.g., Bugelski, 1962), and their use isn’t necessarily restricted to the learning of foreign vocabulary words. For example, here’s a mnemonic sometimes seen in spelling instruction:

The principal is my pal.

Retrieving this sentence will enable a student to remember that the correct spelling for a school administrator is “*principal*,” not “*principle*.” And as a high school student, my daughter remembered the chemical symbol for gold—Au—by thinking “*Ay, you stole my gold watch!*”

### ***Visual Imagery***

As we discovered in Chapter 9, visual images can be powerful, long-lasting means of storing information. Accordingly, visual imagery forms the basis for a number of effective mnemonic devices, including the method of loci, the pegword method, and the keyword method.

***Method of loci*** In the days of the Greek and Roman empires, orators used a particular technique to help them remember the major ideas they wanted to include in their hours-long harangues at the forum (lecture notes were apparently not used very often in those days). The orators would think about a familiar route they walked frequently—the route from home to the forum, for example—and about the significant landmarks along the way—perhaps a bridge, a large tree, and a brothel, in that order. Then, when planning a speech, they would translate each key point into some sort of concrete, observable object and form a visual image of each successive key point located at a particular landmark along the route. As an illustration, let’s say that the

first three points in an orator's speech were the frequent traffic jams near the forum, the importance of a mass transit system in downtown Rome, and the consequent necessity for a tax increase. He might store images such as these: (1) numerous horses and pedestrians entangled in a traffic jam on the bridge (first landmark), (2) a gigantic, 30-person chariot perched among the branches of the large tree (second landmark), and (3) several toga-clad prostitutes pitching coins at a tax collector from the upstairs window of the brothel (third landmark). Later, when pontificating at the forum, the orator would take a mental walk along his familiar route; as he passed each landmark, he would readily retrieve his image of the landmark, along with the object that symbolized his next major point. In this manner, he could easily remember the main ideas he wished to present and their correct order. This **method of loci** (*loci* is Latin for *places*) is clearly an effective mnemonic technique (Groninger, 1971; Snowman, 1986; A. Y. Wang & Thomas, 2000) and readily lends itself to the storage and retention of lists of items.

**Pegword method** The **pegword method** is another technique for effectively learning a list of items and their relative positions (G. H. Bower, 1972; Bugelski, Kidd, & Segmen, 1968; Carney & Levin, 2011; Mastropieri & Scruggs, 1992; A. Y. Wang & Thomas, 2000). This method consists of using a well-known or easily learned list of items that then serves as a series of “pegs” on which another list is “hung” through visual imagery. To illustrate, the following poem is sometimes used as a pegboard:

One is a bun.  
Two is a shoe.  
Three is a tree.  
Four is a door.  
Five is a hive.  
Six is sticks.  
Seven is heaven.  
Eight is a gate.  
Nine is a line; and  
Ten is a hen. (G. A. Miller, Galanter, & Pribram, 1960, p. 135)

This poem should be easy to remember because its lines are composed of the numbers 1 through 10 in conjunction with rhyming nouns. Now suppose you need to remember a list of items in a certain order. You take the first item on your list and form a visual image of it interacting with the noun that rhymes with *one* (in this case, *bun*), then take the second list item and imagine it interacting with the noun that rhymes with *two* (*shoe*), and so on. Images can be formed quickly and typically need not be practiced to be remembered.

Consider this food chain as an example of a list you might learn using the “One is a bun” poem:

*Algae* in a lake are eaten by  
*Water fleas*, which are eaten by  
*Minnows*, which are eaten by  
*Larger fish*, which are eaten by  
*Eagles*.

Using the pegword method, you form an image of algae and a bun together—perhaps a hamburger bun covered with green algae. Similarly, you visualize water fleas in conjunction with a shoe—perhaps you see a shoe filled with water and several water fleas doing the backstroke across the surface. For the last three items of the food chain, you might form images of a tree



with minnows hanging down like fruit, a door with a large fish stuffed through the keyhole, and an eagle wearing a beehive for a hat. Remembering the food chain, then, is simply a matter of thinking “One is a bun,” conjuring up the image of the bun with algae, then thinking “Two is a shoe,” retrieving the shoe image, and so on.<sup>9</sup>

**Keyword method** In my earlier description of verbal mediation as a strategy for learning foreign language words, the German words I chose for my illustrations closely resembled English words. When words in a foreign language don’t have an obvious relationship to their English meanings—and often they don’t—the **keyword method** provides an effective alternative. This technique, which is actually a combination of verbal mediation and visual imagery, involves two steps: (1) identifying an English word or phrase (the keyword) that sounds similar to the foreign word and then (2) forming a visual image of the English sound-alike word with the English meaning. For example, consider how we might remember these German words:

German Word	English Meaning	Keyword(s)	Visual Image
<i>das Pferd</i>	horse	Ford	A horse driving a Ford
<i>das Kaninchen</i>	rabbit	can on chin	A rabbit with a can on its chin
<i>der Waschbär</i>	raccoon	wash, bar	A raccoon washing with a bar of soap
<i>das Stachelschwein</i>	porcupine	stash, swine	A porcupine stashing nuts under a pig (swine)

Although only concrete objects can actually be visualized, the keyword technique can be used with more abstract words as well, provided that they can be adequately represented by a concrete object. For example, consider the Spanish word for love—*amor*—which might be learned by picturing a suit of armor (the keyword) with a big red heart (symbolizing love) painted on its chest. With some creativity, then, the keyword method can be useful in remembering a wide variety of paired associates: not only foreign language words but also English vocabulary words, names and faces, states and their capitals, cities and their products, and famous people and their creations (R. C. Atkinson, 1975; Carney & Levin, 2000; Carney, Levin, & Stackhouse, 1997; M. S. Jones, Levin, Levin, & Beitzel, 2000; Pressley, Levin, & Delaney, 1982; Rummel, Levin, & Woodward, 2003).

Identifying keywords when numbers are involved can be a bit trickier; for example, you might have trouble identifying sound-alike words for numbers such as 239 or 1861. To address this problem, Lorayne and Lucas (1974) suggested that learners use specific consonant sounds as substitutes

Using a keyword to remember that a horse is a *Pferd*

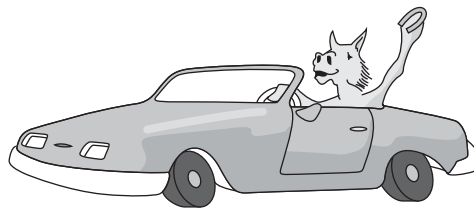

<sup>9</sup>My cousin Natalie Powell, who worked at Gallaudet College for many years, has given me a version of “One is a bun” that students who are deaf can use: *One is you, two is vegetable, three is rooster, four is football, five is paper, six is water, seven is smoking, eight is pumpkin, nine is Indian, ten is nut.* Each number is matched with a word that involves similar hand movements in American Sign Language.

for different digits and then create words using those sounds. As an illustration, imagine that you want to remember that the painting on the left side of Figure 14.3 was painted by Jean-Louis-Ernest Meissonier in 1861. To remember the artist's name, you can use the keyword *messenger*. To remember the date, you can create a word using the number-letter equivalents on the right side of Figure 14.3. To keep things simple, we'll assume that you already know that Meissonier lived in the 1800s and so will address only the last two digits of the year. If we use *J* to represent the 6 and *T* to represent the 1, we can form a second keyword, *jet*. Now, form a visual image of the man as a *messenger* who has just walked down the steps from his *jet* in the background. Although this approach may seem complicated, in fact college students learn it fairly easily, and using it helps them remember the artists and dates of paintings more easily than they would otherwise (Carney & Levin, 1994).



### Number-Letter Equivalents

- 1 = T or D
- 2 = N
- 3 = M
- 4 = R
- 5 = L
- 6 = J, soft G, SH, or CH
- 7 = K, hard C, or hard G
- 8 = F or V
- 9 = P or B
- 10 = S, Z, or soft C

To remember that this masterpiece was painted by Jean-Louis-Ernest *Meissonier* in 1861, form a visual image of the man as a *messenger* who has just walked down the steps from his *jet* (*J* for 6 and *T* for 1) in the background (Carney & Levin, 1994). (Number-letter equivalents are from Lorayne & Lucas, 1974).

**Figure 14.3**

Using the keyword method to remember the artist and year of a masterpiece

Source: *A Cavalier: Time of Louis XIII*, 1861, Jean-Louis-Ernest Meissonier. By kind permission of the Trustees of the Wallace Collection, London.

When encouraging students to use mnemonics based on visual imagery, teachers must keep three things in mind. First, many young children can't generate effective images on their own and so probably need to have pictures provided for them (Mayer, 1987). Second, for imagery to be an effective means of remembering a connection between two items (e.g., between a tree and a mass transit system, or between love and *amor*), the two items must be incorporated into the same image in an *interacting* fashion (G. H. Bower, 1972; Dempster & Rohwer, 1974). Thus, while an image of a suit of armor with a heart on its chest might be an effective way of remembering the Spanish word for *love*, an image of a heart placed beside a suit of armor probably isn't. Third, as noted in Chapter 9, imagery doesn't preserve details very well; therefore, it may not help one remember such specific information as the exact shape of a heart or the number of dents on a suit of armor.

### ***Superimposed Meaningful Structure***

One of my most vivid memories from my years as an undergraduate psychology major is being required to learn the 12 cranial nerves: olfactory, optic, oculomotor, trochlear, trigeminal, abducens, facial, auditory, glossopharyngeal, vagus, spinal accessory, and hypoglossal. It isn't the nerves themselves that I remember but rather how painfully difficult it was to learn them all in their correct order. I had little luck drilling the list into my thick skull (I was using the tried-and-not-so-true method of rehearsal) until a friend passed along this mnemonic:

On old Olympus's towering top, a Finn and German viewed some hops.

Notice that the first letters of the words in the sentence correspond with the first letters of the 12 cranial nerves: Just like in the list of nerves, the first three words in the sentence begin with *O*, the next two begin with *T*, and so on. And the sentence, though a bit strange, is fairly easy to remember because of the structure provided by its rhythm and rhyme.

"On old Olympus" illustrates a mnemonic I call a **superimposed meaningful structure**.<sup>10</sup> The technique is simple: The learner imposes a simple structure on the body of information to be learned. That structure can be a sentence, story, rhythm, acronym, or anything else that a learner can easily remember. For instance, during a trip to England, I stumbled on a catchy poem for remembering the kings and queens of England, beginning with King William I and ending with Queen Elizabeth II. An Internet search gave me several variations, but here's the gist of it:

Willie, Willie, Harry, Steve,  
 Harry, Dick, John, Harry three.  
 Edward one, two, three, Dick two,  
 Harrys four five six, then who?  
 Edwards four, five, Dick the Bad,  
 Harrys twain and Ned the lad.  
 Mary, Bessie, James the vain,  
 Charlie, Charlie, James again.  
 William and Mary, Anna Gloria,  
 Georges four, William, Victoria.  
 Edward seven, Georgie five,  
 Edward, George, and Liz (alive).

<sup>10</sup>I've also seen the terms *semantic elaboration* and *acrostic* used in reference to this technique.

Figure 14.4 lists additional examples of superimposed meaningful structures, some for declarative information and others for procedures. Such mnemonics clearly facilitate memory for otherwise hard-to-remember lists (e.g., G. H. Bower & Clark, 1969; Bulgren, Schumaker, & Deshler, 1994).

It should be clear by now that, in general, mnemonics can be extremely helpful learning aids. As you may have noticed, their effectiveness lies in their conformity with a few critical principles of storage and retrieval. First, they often impose a structure or organization on the material to be learned. Second, they help the learner relate the new material to information already stored in long-term memory (e.g., to the number system or a familiar poetic meter). And third, they

The Mnemonic	What It Represents
<b><i>For Declarative Information</i></b>	
ROY G. BIV	The spectrum: red, orange, yellow, green, blue, indigo, violet
HOMES	The five Great Lakes: Huron, Ontario, Michigan, Erie, Superior
Every good boy does fine.	The lines on the treble clef: E G B D F
Edgar ate dynamite; good-bye, Edgar.	The strings on a guitar: E A D G B E
While watching hippos, wear waterproof white hats. <sup>a</sup>	The pattern of whole and half steps in a major scale in Western music: whole, whole, half, whole, whole, whole, half.
Campbell's ordinary soup does make Peter pale.	The geologic time periods of the Paleozoic era: Cambrian, Ordovician, Silurian, Devonian, Mississippian, Pennsylvanian, Permian
When the "mites" go up, the "tites" go down.	The distinction between stalagmites and stalactites
A "boot"	The shape of Italy
A "bearskin rug"	The shape of France
George Ellen's old grandmother rode a pig home yesterday.	The correct spelling of <i>geography</i>
/ before E, except after C.	The correct spelling of words that contain either "ie" or "ei" (e.g., <i>believe</i> , <i>receive</i> )
Thirty days has September . . . .	The number of days in each month
<b><i>For Procedural Information</i></b>	
Righty, tighty; lefty, loosy.	Turning a screw (clockwise to tighten it, counterclockwise to loosen it)
BEEF	Good form for a free throw in basketball: <i>balance</i> the ball, <i>elbows in</i> , <i>elevate</i> the arms, <i>follow through</i>
FOIL	Multiplying a mathematical expression of the form $(ax + b)(cx + d)$ : Multiply the <i>first</i> terms in each set of parentheses, then the <i>outer</i> terms, the <i>inner</i> terms, and finally the <i>last</i> terms

**Figure 14.4**

Examples of superimposed meaningful structures

<sup>a</sup>I thank Lee Boissonneault for the "While watching hippos . . ." mnemonic.

provide retrieval cues (such as the *associate cues* and *frames* described in Chapter 11) that help learners find the information at a later time.

In the past few pages, I've identified a number of effective learning and study strategies. Some of them, such as outlining, taking notes, and writing summaries, are **overt strategies**: They involve behaviors we can actually see. Others—such as elaborating, identifying important information, and monitoring comprehension—are **covert strategies**: They're internal mental processes we often *can't* see. Ultimately, it's probably the ways in which students cognitively process new information—the covert strategies—that determine how effectively they learn and remember it (Kardash & Amlund, 1991).

## DEVELOPMENT OF METACOGNITIVE KNOWLEDGE AND SKILLS \_\_\_\_\_

Developmental psychologists have observed several trends in the development of metacognition:

- ◆ *Children become increasingly aware of the nature of thinking.* In Chapter 10, we examined *theory theory*, a perspective that focuses on the personal theories that children develop about various aspects of their world. Theory theorists propose that children develop personal theories not only about their physical and social worlds but also about their internal, psychological world. More specifically, children develop a **theory of mind**, which includes increasingly complex understandings of their own and others' mental states—thoughts, beliefs, perspectives, feelings, motives, and so on (e.g., Flavell, 2000; Lillard, 1998; Wellman, 1990).

Young children have only a limited ability to look inward at their own thinking and knowledge (Flavell, Green, & Flavell, 2000). Although many preschoolers have the words *know*, *remember*, and *forget* in their vocabularies, they don't fully grasp the nature of these mental phenomena. For instance, 3-year-olds use the term *forget* simply to mean “not knowing” something, regardless of whether they knew the information at an earlier time (Lyon & Flavell, 1994). And when 4- and 5-year-olds are taught a new piece of information, they may say that they've known it for quite some time (M. Taylor, Esbensen, & Bennett, 1994).

During the elementary and secondary school years, children and adolescents become better able to reflect on their own thought processes and so are increasingly aware of the nature of thinking and learning (Flavell, Miller, & Miller, 2002; P. L. Harris, 2006; Schult, 2002). To some extent, adults may foster such development by talking about the mind's activities—for instance, by referring to “thinking a lot” or describing someone's mind as “wandering” (Adrián, Clemente, & Villanueva, 2007; Wellman & Hickling, 1994).

- ◆ *Children become increasingly realistic about their memory capabilities and limitations.* Young children tend to be overly optimistic about how much they can remember. As they grow older and encounter a wide variety of learning tasks, they discover that some things are more difficult to learn than others (Bjorklund & Green, 1992; Flavell et al., 2002). They also begin to realize that their memories aren't perfect—that they can't possibly remember everything they see or hear. For example, in a study by Flavell, Friedrichs, and Hoyt (1970), four age-groups of children (ranging from preschoolers to fourth graders) were shown strips of paper picturing from 1 to 10 objects and asked to predict how many objects they thought they could remember at a time (a working memory task). The children were then tested to determine how many objects they actually could remember. All four groups of children tended to overestimate their working

memory capacities, but the older children's estimates were more realistic. For example, kindergartners predicted that they could remember an average of 8.0 objects but in fact remembered only 3.6. In contrast, the fourth graders estimated that they could remember 6.1 objects and actually recalled 5.5—a much closer prediction.

♦ *Children become increasingly aware of and use effective learning and memory strategies.* Young children have little metacognitive awareness of effective strategies. Even when they can verbally describe which learning and memory strategies are effective and which are not, they tend to use relatively ineffective ones. In contrast, older children are more likely to have a variety of strategies, to apply them broadly and flexibly, and to know when to use each one (P. A. Alexander et al., 1998; Flavell et al., 2002; P. A. Ornstein et al., 2010; Schneider & Lockl, 2002). Consider the following research findings as examples:

- When asked to study and remember numerous bits of information, 6- and 7-year-olds allocate their study time somewhat haphazardly, without regard for the difficulty of each item. In contrast, 9- and 10-year-olds focus their efforts on the more difficult items (Masur, McIntyre, & Flavell, 1973; Schneider, 2010; Schneider & Lockl, 2002).
- Rehearsal is rare in preschoolers but increases in frequency and effectiveness throughout the elementary school years. At age 7 or 8, children often rehearse information spontaneously, but they tend to repeat each item they need to remember in isolation from the others. When they reach age 9 or 10, they begin to use *cumulative rehearsal*, reciting the entire list at once and continuing to add any new items (Gathercole & Hitch, 1993; Kunzinger, 1985; Lehmann & Hasselhorn, 2007).
- Children increasingly organize the things they need to remember, perhaps by putting items into categories. They also become more flexible in their organizational strategies, especially as they reach adolescence (Moely, 1977; P. A. Ornstein et al., 2010; Plumert, 1994).
- The use of elaboration continues to increase throughout the school years (Flavell et al., 2002; Kail, 1990; Schneider & Pressley, 1989). For example, sixth graders often draw inferences from the things they read, whereas first graders rarely do (C. K. K. Chan, Burtis, Scardamalia, & Bereiter, 1992). And tenth graders are more likely than eighth graders to use elaboration when trying to remember paired associates (e.g., *doctor-machine, acorn-bathtub*) (Waters, 1982).

Certainly such trends are due, in part, to children's growing experience with a wide variety of learning tasks. But the increasing capacity of working memory and the increasing neurological maturity of that central executive I spoke of in Chapter 8 may also play a role (Borkowski & Burke, 1996; Pressley & Hilden, 2006).

♦ *Children engage in more comprehension monitoring as they get older.* Children in the early elementary grades often think they know or understand something before they actually do. As a result, they don't study things they need to learn as much as they should, and they often don't ask questions when they receive incomplete or confusing information (Dufresne & Kobasigawa, 1989; Flavell et al., 1970; Markman, 1977; McDevitt, Spivey, Sheehan, Lennon, & Story, 1990). Their ability to monitor their own comprehension improves throughout the school years, and thus they become increasingly aware of when they actually know something (Schneider, 2010; Schneider & Lockl, 2002; van Kraayenoord & Paris, 1997). Yet even many college students have trouble assessing their own knowledge accurately; for instance, they often overestimate how well they will perform or have performed on an exam (Dunlosky & Lipko, 2007; Dunning et al., 2004; Hacker et al., 2000; Zhao & Linderhold, 2008; Zimmerman & Moylan, 2009).

♦ *Some learning processes may be used unconsciously and automatically at first but become more conscious and deliberate with development.* It isn't unusual to see young learners organizing or elaborating on the things they're learning without being consciously aware that they're doing so (Bjorklund, 1987; Flavell et al., 2002; M. L. Howe & O'Sullivan, 1990). For example, young children may automatically group things into categories as a way of remembering them more effectively; only later do they *try* to categorize the things they need to learn (Bjorklund, 1987). Thus, children's learning processes become more intentional—and therefore more *strategic*—with age.

The specific learning strategies students use depend, to some extent, on their beliefs about the nature of the knowledge they're trying to acquire, as well as about the nature of learning itself. Such *epistemic beliefs* are our next topic.

## EPISTEMIC BELIEFS

---

Earlier in the chapter I described how, as a high school student, I believed that I was reading my history textbook even when I was thinking about something else and that I could effectively study my Chinese vocabulary words by repeating them aloud a few times. Clearly I had a very naive notion of what learning involves: I thought it was a relatively mindless process that would magically happen regardless of how much mental effort I invested.

I also had some pretty shaky beliefs about what “knowledge” is. I thought that the academic disciplines I was studying—history, science, literature—were pretty much set in stone, with definite right and wrong ways of looking at things. Experts didn't know everything just yet—for instance, they still hadn't figured out how to cure the common cold—but that knowledge was “out there” somewhere and would eventually be discovered. In the meantime it was my job as a student to acquire as many facts as I could. I wasn't quite sure what I'd do with them all, but I knew, deep down, that they would somehow make me a better person.

As people who learn new things every day, we all have ideas about what “knowledge” and “learning” are—ideas that are collectively known as **epistemic beliefs**.<sup>11</sup> In many cases, such beliefs are pulled together into cohesive, although not necessarily accurate, personal theories about human learning and cognition (B. Hofer & Pintrich, 1997; D. Kuhn, 2000; Lampert, Rittenhouse, & Crumbaugh, 1996; Muis, Bendixen, & Haerle, 2006). Included in these theories are beliefs about such things as:

- *The certainty of knowledge:* Whether knowledge is a fixed, unchanging, absolute “truth” **or** a tentative, dynamic entity that will continue to evolve over time<sup>12</sup>
- *The simplicity and structure of knowledge:* Whether knowledge is a collection of discrete, independent facts **or** a set of complex and interrelated ideas
- *The source of knowledge:* Whether knowledge comes from outside of learners (i.e., from a teacher or other authority figure) **or** is derived and constructed by learners themselves

<sup>11</sup>In previous editions of the book I've used the term *epistemological beliefs*, but *epistemic beliefs* is now more common. You may also see such terms as *personal epistemology*, *intuitive epistemology*, *epistemic cognition*, *ways of knowing*, *meta-knowing*, and *ontological cognition*.

<sup>12</sup>The belief that there's an ultimate “truth” that experts will eventually determine is sometimes called *logical positivism*. This view contrasts sharply with *radical constructivism*, a perspective maintaining that there's no “reality” separate from people's constructed understandings and beliefs.

- *The criteria for determining truth:* Whether an idea is accepted as true when it's communicated by an expert **or** when it's logically evaluated based on available evidence
- *The speed of learning:* Whether knowledge is acquired quickly, if at all (in which case learners either know something or they don't, in an all-or-none fashion) **or** is acquired gradually over a period of time (in which case learners can partially know something)
- *The nature of learning ability:* Whether people's ability to learn is fixed at birth (i.e., inherited) **or** can improve over time with practice and use of better strategies (Bendixen & Rule, 2004; Elder, 2002; J. A. Greene, Torney-Purta, & Azevedo, 2010; Hammer, 1994; B. Hofer, 2004; B. Hofer & Pintrich, 1997; P. M. King & Kitchener, 2002; M. C. Linn, Songer, & Eylon, 1996; Schommer, 1994a; Schommer-Aikins, Duell, & Hutter, 2005; P. Wood & Kardash, 2002)

Keep in mind that epistemic beliefs aren't as either-or as I've just portrayed them. Most or all of the dimensions I've listed probably reflect *continuums* rather than strict dichotomies (Baxter Magolda, 2002; J. A. Greene et al., 2010; P. M. King & Kitchener, 2002; D. Kuhn & Weinstock, 2002; Marton & Booth, 1997).

Whether and in what ways people's various beliefs about knowledge and learning hang together as an integrated belief system is a matter of considerable debate, fueled in part by the nature of the research methods used. Researchers obtain information about learners' beliefs primarily from interviews and questionnaires, yet some theorists suspect that learners' true beliefs may be implicit rather than explicit and thus are far removed from conscious awareness (diSessa, Elby, & Hammer, 2003; Hammer & Elby, 2002; Schraw & Moshman, 1995). In addition, the particular measures and statistical methods used seem to influence the kinds of beliefs and interrelationships among them that researchers identify (J. A. Greene et al., 2010; Schraw, Bendixen, & Dunkle, 2002).

Increasingly theorists are beginning to realize that people's epistemic beliefs are at least partly context- and situation-specific (Buehl & Alexander, 2006; Muis et al., 2006; Schommer-Aikins, 2004). For example, even though you and I may believe that humankind's collective scientific knowledge will probably continue to evolve over time—thus, we believe that knowledge is somewhat uncertain—we know that other things are fairly black and white. Two plus two give us four, France is located in Europe, and Columbus first sailed across the Atlantic in 1492; these facts are unlikely to change in the foreseeable future. Furthermore, learners' epistemic beliefs may be specific to particular content domains. Following are examples:

- Many students believe that knowledge is more certain in some disciplines than in others. For example, they may believe that knowledge in mathematics, the natural sciences, and history is pretty much a sure thing, whereas knowledge in some social sciences—psychology, for one—is more tentative (De Corte, Op't Eynde, & Verschaffel, 2002; D. Estes, Chandler, Horvath, & Backus, 2003; J. A. Greene et al., 2010; Haenen, Schrijnemakers, & Stufkens, 2003; B. Hofer, 2000; Schommer, 1994b).
- Many students think that learning math and physics means memorizing procedures and formulas and finding a single right answer and that, furthermore, there's usually only one correct way to solve a problem and only one correct answer to it (De Corte et al., 2002; Hammer, 1994; Muis, 2004).
- Many students think that when they work on math problems, they'll either solve the problems within a few minutes or else not solve them at all. Many also think that when an answer to a math problem isn't a whole number, it's probably wrong (Muis, 2004; Schoenfeld, 1988).



## Developmental and Cultural Differences in Epistemic Beliefs

Learners' epistemic beliefs often change over time. For example, young children typically believe in the certainty of knowledge: They're apt to think that there's an absolute truth about almost any topic lurking out there somewhere (Astington & Pelletier, 1996; B. Hofer & Pintrich, 1997; D. Kuhn & Weinstock, 2002). As they reach the middle school and high school years, some of them—but by no means all—begin to realize that knowledge is a subjective entity and that different perspectives on a topic may be equally valid (Belenky, Clinchy, Goldberger, & Tarule, 1986/1997; D. Kuhn & Weinstock, 2002; Perkins & Ritchhart, 2004; W. G. Perry, 1968; Schommer, Calvert, Gariglietti, & Bajaj, 1997). Other changes can also occur at the high school level. For example, students in twelfth grade are more likely than ninth graders to believe that knowledge consists of complex interrelationships (rather than discrete facts), that learning happens slowly (rather than quickly), and that learning ability can improve with practice (rather than being fixed at birth) (Schommer et al., 1997). And in general, learners' epistemic beliefs become increasingly domain-specific with age and grade level (Buehl & Alexander, 2006; Muis et al., 2006).

For some people—especially those who pursue higher education—epistemic beliefs evolve even further in adulthood. Increasingly these individuals come to view knowledge and truth as tentative, uncertain entities. And particularly if they continue on to graduate school, they begin to appreciate the need for analyzing and evaluating other people's claims and arguments (even those of experts) using logic and solid evidence (Baxter Magolda, 2002, 2004; B. Hofer & Pintrich, 1997; J. A. Greene et al., 2010; D. Kuhn, 2001a; Muis et al., 2006).

Although the acquisition of abstract thought is almost certainly a prerequisite for more advanced epistemic beliefs, environmental factors also play a role in their development. Even young children may hear adults contradict one another—for instance, a teacher might contradict something a parent has said about a topic—and so may begin to ponder the credibility of different authority figures (B. Hofer, 2004). By early adolescence, children show considerable variability in their epistemic beliefs, apparently at least partly as a result of exposure to others' beliefs about the certainty and origins of knowledge and related issues (Haerle, 2004; D. Kuhn, Daniels, & Krishnan, 2003).

Researchers have also begun to uncover cultural differences in learners' epistemic beliefs. For instance, beginning in middle school, students in the United States are more likely to question the validity of an authority figure's claims than are students in the Far East. In contrast, students in Far Eastern countries (e.g., Japan and Korea) are apt to believe that knowledge is cut-and-dried and can be effectively gained from authority figures (D. Kuhn & Park, 2005; Qian & Pan, 2002). Yet Asian learners—and also Asian American learners—have an advantage in another respect: Compared to their European American counterparts (who sometimes expect quick results with little work), college students of Asian heritage are more likely to believe that mastering complex academic topics is often a slow, effortful process requiring diligence, persistence, and a combination of rote and meaningful learning (Dahlin & Watkins, 2000; Li, 2005; Morelli & Rothbaum, 2007; Schommer-Aikins & Easter, 2008; Tweed & Lehman, 2002). Some differences exist even among Western cultures. For example, college students in Ireland are more likely than American students to view learning as a complex and constructive process that results in somewhat tentative understandings of a topic. Their peers in the United States are more likely to view learning as a process of attending carefully to presented information and memorizing it as a set of isolated facts (McDevitt, Sheehan, Cooney, Smith, & Walker, 1994).

## Effects of Epistemic Beliefs

Students' epistemic beliefs clearly influence how they study and learn. Following are specific effects that various beliefs are likely to have:

- *Beliefs regarding the certainty of knowledge:* When students believe that knowledge about a topic is a fixed, certain entity, they're apt to jump to quick and potentially inaccurate conclusions based on the information they receive. In contrast, when students view knowledge as something that continues to evolve and doesn't necessarily include definitive right and wrong answers, they're apt to enjoy cognitively challenging tasks, engage in meaningful and elaborative learning, read course material critically, undergo conceptual change when warranted, and recognize that some issues are controversial and not easily resolved (DeBacker & Crowson, 2008; Kardash & Howell, 2000; Kardash & Scholes, 1996; Mason, Gava, & Boldrin, 2008; Muis & Franco, 2009; Patrick & Pintrich, 2001; Schommer, 1994a).
- *Beliefs regarding the simplicity and structure of knowledge:* Students who believe that knowledge is a collection of discrete facts are apt to use rote-learning processes when they study and to hold on to existing misconceptions. They also tend to think that they "know" the material they're studying if they can recall basic facts and definitions. In contrast, students who believe that knowledge is a complex set of interrelated ideas are likely to engage in meaningful and elaborative learning when they study and likely to evaluate the success of their learning efforts in terms of how well they understand and can apply what they've learned (Hammer, 1994; B. Hofer & Pintrich, 1997; Mason, 2003; Muis & Franco, 2009; Purdie & Hattie, 1996; Schommer-Aikins, 2002).
- *Beliefs regarding the source of knowledge:* Students who believe that knowledge originates outside the learner and is passed along directly by authority figures are apt to be fairly passive learners, perhaps listening quietly to explanations without trying to clarify confusing ideas or perhaps exerting little effort when lessons involve inquiry activities and class discussions rather than lectures. In contrast, students who believe that knowledge is ultimately self-constructed are apt to be cognitively engaged in learning activities, make interconnections among ideas, read and listen critically, work to make sense of seemingly contradictory pieces of information, and undergo conceptual change (C. Chan et al., 1997; Haseman, 1999; K. Hogan, 1997; Kember, 2001; Schommer, 1994b; Schraw & Bruning, 1995).
- *Beliefs regarding the criteria for determining truth:* When students believe that something is probably true if it comes from an "expert" of some sort, they're apt to accept information from authority figures without question. But when they believe that ideas should be judged on their logical and scientific merit (rather than on their source), they're apt to critically evaluate new information on the basis of available evidence (P. M. King & Kitchener, 2002; Moon, 2008; Schommer-Aikins & Easter, 2005). The latter epistemic perspective is illustrated by the following interview, in which a student defends the premise that the pyramids at Giza were built by the Egyptians—rather than, say, by an earlier civilization or extraterrestrials:

Interviewer: Can you ever say you know for sure about this issue?

Student: It . . . is very far along the continuum of what is probable.

Interviewer: Can you say that one point of view is right and one is wrong?

Student: Right and wrong are not comfortable categories to assign to this kind of item. It's more or less likely or reasonable, more or less in keeping with what the facts seem to be.  
(dialogue from P. M. King & Kitchener, 1994, p. 72)

As students grow older, and especially as they move into higher levels of education (e.g., graduate school), they become increasingly adept at distinguishing between weak and strong evidence for a particular idea or point of view (D. Kuhn, 2001a).

- *Beliefs regarding the speed of learning:* When students believe that learning happens quickly in an all-or-none fashion, they're apt to believe they've learned something before they really have—perhaps after only a single reading of a textbook—and in the face of failure, they're apt to give up quickly and express discouragement or dislike regarding what they're studying. In contrast, when students believe that learning is a gradual process that often takes time and effort, they're likely to use a wide variety of learning strategies as they study and to persist until they've made sense of the material (D. L. Butler & Winne, 1995; Kardash & Howell, 2000; Ricco, Pierce, & Medinilla, 2010; Schommer, 1990, 1994b; Schommer-Aikins et al., 2005).
- *Beliefs regarding the nature of learning ability:* As you might guess, students' beliefs about the nature of learning ability are correlated with their persistence in learning. If they think that learning ability is a fixed commodity, they'll quickly give up on challenging tasks. In contrast, if they think that their ability to learn something is under their control, they'll pursue a variety of supportive learning activities and try, try again until they've mastered the subject matter (K. Hartley & Bendixen, 2001; Ricco et al., 2010; Schommer, 1994a, 1994b).

Not surprisingly, students with developmentally more advanced epistemic beliefs—for example, those who believe that knowledge is complex and uncertain and that learning is often a slow, gradual process—achieve at higher levels in the classroom (Buehl & Alexander, 2005; J. A. Chen & Pajares, 2010; Kardash & Sinatra, 2003; Muis & Franco, 2009; Schommer, 1994a). Furthermore, higher levels of academic achievement may bring about more advanced views about knowledge and learning (J. A. Greene et al., 2010; Schommer, 1994b; Strike & Posner, 1992). The more students can get beyond the basics and explore the far reaches of a discipline—whether it be science, mathematics, history, literature, or some other domain—the more they'll discover that learning involves acquiring an integrated and cohesive set of ideas, that even experts don't know everything about a topic, and that truly complete and accurate knowledge of how the world operates may ultimately be an unattainable goal.

It's important to note here that students aren't the only ones who can have relatively naive beliefs about the nature of knowledge and learning. Some *teachers* appear to have naive beliefs as well. Some teachers seem to believe that knowledge about a particular subject matter is a fixed and well-defined entity, that students need to “absorb” this knowledge in isolated bits and pieces, and that learning is a process of mindless memorization and rehearsal (Dweck & Molden, 2005; Feucht, 2010; B. Hofer & Pintrich, 1997; Patrick & Pintrich, 2001; Schommer, 1994b). Such beliefs are likely to influence the ways that teachers teach and assess their students. For example, teachers holding these beliefs are more likely to focus on lower-level skills in their instructional objectives, classroom activities, assignments, and tests (Feucht, 2010; Grossman, 1990; B. Hofer & Pintrich, 1997). Fortunately, teachers often acquire more sophisticated beliefs about their subject matter as they gain experience in the classroom (Corkill, Bouchard, & Bendixen, 2002).

## THE INTENTIONAL LEARNER

---

Earlier I described learning and study strategies as involving the *intentional* use of certain cognitive processes to learn. Truly effective learning, it appears, involves **intentional learning**, in which a learner is actively and consciously engaged in cognitive and metacognitive activities directed specifically at thinking about and learning something (Bereiter & Scardamalia, 1989; Hacker, Dunlosky, & Graesser, 2009a; Sinatra & Pintrich, 2003a).<sup>13</sup> Intentional learners have particular goals they want to accomplish as they learn, and they make use of the many self-regulatory strategies they have at their disposal to achieve those goals. Long gone is that reactive responder to environmental stimuli whom we encountered in the early days of behaviorism. Instead, we now have the learner squarely in the driver's seat with an itinerary, a road map, and considerable knowledge about how to drive the car.

Without a doubt, intentional learning involves both automatic and controlled processes. Many of the basic components of learning—retrieving word meanings, connecting new ideas to similar information already in long-term memory, and so on—have been practiced to a level of automaticity, and so the learner carries them out with little thought or effort. But overseeing the process is a very conscious, goal-directed individual who brings into play a variety of strategies as necessary: deciding what to focus on, trying to make sense of ambiguous text passages, drawing inferences for one's own life circumstances, and so on (Cornoldi, 2010; diSessa et al., 2003; Kintsch, 1998; Sinatra & Pintrich, 2003b).

Intentional learning may be especially important when learners need to overhaul their current understandings of a topic or issue—in other words, when they must undergo conceptual change (Bendixen & Rule, 2004; Inagaki & Hatano, 2008; P. K. Murphy & Mason, 2006; Sinatra & Pintrich, 2003a). Intentional learning brings into play several processes that are critical for conceptual change. First, intentional learners actively attend to and think about the new information, and thus they're more likely to notice discrepancies with what they currently believe. Second, intentional learners are eager to acquire mastery of the subject matter, and so they exert considerable effort to make sense of it. Third, they bring to the table a variety of learning and self-regulatory strategies—elaboration, self-motivation, self-monitoring, and so on—that maximize their chances for revising their beliefs in line with what they're hearing or reading. But in addition to such processes, intentional learners must have epistemic beliefs consistent with the notion of conceptual change. More specifically, they must believe that knowledge about a topic continues to evolve and improve over time and that learning something *well* often takes time, effort, and perseverance (Southerland & Sinatra, 2003).

Intentional learning is the ideal situation. Unfortunately, what's more typical is that students don't regularly, consistently, or actively use effective learning and self-regulatory strategies. We now look at reasons why.

## WHY STUDENTS DON'T ALWAYS USE EFFECTIVE STRATEGIES

---

As we've seen, many students continue to use ineffective learning and study strategies (e.g., rote memorization) throughout their academic careers. Given what you've learned about metacognition up to this point, can you generate some hypotheses about why this might be so? Following

---

<sup>13</sup>The concepts *mindful learning* and *mindfulness* (Langer, 1997, 2000) reflect a similar idea.

are several possible reasons why effective learning strategies emerge slowly, if at all; perhaps you'll find some of your own ideas in my list:

- ◆ *Students are uninformed or misinformed about effective strategies.* As should be clear by now, many students seem to be clueless about what they need to do in order to achieve at high levels. For example, in a study with low-income, inner-city middle school students (B. L. Wilson & Corbett, 2001), researchers found that many of the students aspired to professional careers (doctor, lawyer, teacher, etc.) yet misbehaved in class, inconsistently completed homework, and often skipped school. They had little idea about what it would take to do well in their studies. The following interview with one boy illustrates their naiveté:

- Interviewer: Are you on track to meet your goals?  
 Student: No. I need to study more.  
 Interviewer: How do you know that?  
 Student: I just know by some of my grades. [mostly Cs]  
 Interviewer: Why do you think you will be more inclined to do it in high school?  
 Student: I don't want to get let back. I want to go to college.  
 Interviewer: What will you need to do to get better grades?  
 Student: Just do more and more work. I can rest when the school year is over. (dialogue from B. L. Wilson & Corbett, 2001, p. 23)

Like the student in the interview, some students believe that all they need to do to learn information better is to exert more effort—that is, to *try harder*—with little regard for how they should mentally process the information.

Undoubtedly a key reason why students have little knowledge about effective learning strategies is that schools rarely *teach* such strategies; strategy instruction is especially rare in the elementary and middle school grades (Hamman, Berthelot, Saia, & Crowley, 2000; Nokes & Dole, 2004; Pressley & Hilden, 2006; E. Wood, Motz, & Willoughby, 1998). Yet when left to discover strategies on their own, students typically acquire effective ones quite slowly, if at all, and some students develop counterproductive misconceptions about how best to learn (Pressley & Hilden, 2006). Sometimes even *teachers* foster misconceptions, perhaps with maxims like this one: “Repeat a sentence out loud three times and write it down three times, and then it's yours forever” (Matlin, 2004).

- ◆ *Students have epistemic beliefs that lead them to underestimate or misrepresent a learning task.* Students are unlikely to use effective strategies if they believe that the learning task at hand is an easy one or that their learning success is unrelated to the effort they put forth (Blackwell, Trzesniewski, & Dweck, 2007; D. L. Butler & Winne, 1995; Muis, 2007). And as we've already seen, they certainly won't engage in such processes as meaningful learning, organization, and elaboration if they think that “knowledge” is nothing more than a collection of unrelated facts.

- ◆ *Students mistakenly believe that they're already using effective strategies.* Perhaps because they aren't monitoring their comprehension or perhaps because they've defined learning in an overly simplistic manner, many low-achieving students erroneously believe that their current approach to learning and studying is a good one (D. Kuhn, 2009; Loranger, 1994; Starr & Lovett, 2000). In some cases, feedback that students *aren't* mastering the material will spur them to adopt more effective strategies, at least for the short run (Starr & Lovett, 2000). In other instances, however, students may attribute their poor performance to factors outside of themselves—perhaps to poor instruction or a “picky” test (we'll discuss the nature and effects of such *attributions* in Chapter 17).

◆ *Students have little relevant prior knowledge on which they can draw.* Students who use ineffective learning and study strategies tend to know less about the subject matter they're studying—and less about the world in general—than students who use effective strategies. For example, students may know too little about a topic to distinguish between what is and isn't important. They may have few concepts or experiences to which they can meaningfully relate new material. And they're likely to have fewer organizational frameworks and schemas they can impose on what might otherwise appear to be a set of unrelated facts (P. A. Alexander & Jetton, 1996; P. A. Carpenter & Just, 1986; McDaniel & Einstein, 1989; Pressley & Hilden, 2006; Schneider, 1993; Woloshyn, Pressley, & Schneider, 1992).

◆ *Assigned learning tasks don't lend themselves to sophisticated strategies.* In some situations, teachers may assign tasks for which effective strategies are either counterproductive or impossible. For example, when teachers assign simple tasks that involve lower-level skills—for instance, when they insist that facts and definitions be learned verbatim—students are unlikely to engage in such processes as meaningful learning and elaboration (J. W. Thomas, 1993a; J. C. Turner, 1995; Van Meter et al., 1994). And when teachers expect a great deal of material to be mastered for each test, students may have to devote their limited time to getting a general, superficial impression of everything rather than to developing an in-depth understanding and integration of the subject matter (J. W. Thomas, 1993b).

◆ *Students have goals that are inconsistent with effective learning.* Students aren't always interested in learning for understanding; instead, they may be more interested in remembering information only long enough to get a passing grade, or they may want to complete an assigned task in as little time and with as little effort as possible. Effective learning strategies may be largely irrelevant to such motives (more on this point in the discussion of achievement goals in Chapter 17).

◆ *Students think that sophisticated learning strategies require too much effort to be worthwhile.* Students who believe that certain strategies involve too much time and effort are unlikely to use them, no matter how effective the strategies might be (Credé & Kuncel, 2008; Palmer & Goetz, 1988; Pressley et al., 1990; Winters, Greene, & Costich, 2008). In many cases, students seem to be unaware of how much a few simple strategies can help them learn and remember classroom material (Pressley, Levin, & Ghatala, 1984; Zimmerman, 1994). In other instances, they may have little experience with a particular strategy; thus, they've learned few or none of the strategy's components to automaticity, and so using it effectively *does* require a great deal of effort (P. A. Alexander et al., 1998; D. Kuhn & Pease, 2010; Siegler & Alibali, 2005).

◆ *Students have low self-efficacy about their ability to learn in an academic setting.* Some students—especially those with a history of academic failure—develop the belief that they're incapable of learning regardless of what they do. Such students may believe (erroneously) that *no* strategy is likely to make an appreciable difference in their school achievement (P. A. Alexander et al., 1998; Borkowski & Burke, 1996; Klassen & Usher, 2010; Palmer & Goetz, 1988).

## PROMOTING EFFECTIVE LEARNING AND STUDY STRATEGIES

---

As students move through the grade levels—from elementary school, to middle or junior high school, then to high school, and perhaps eventually to college—their learning tasks become increasingly complex and challenging. For example, students must remember more information, understand it at a more abstract level, and do more with it—for instance, by critically analyzing

it or applying it to new situations and problems. Thus, students have a greater need for sophisticated learning and study strategies as the years go by.

Many students don't develop effective learning strategies on their own, however, and so explicit instruction in how to learn and study is often critical for promoting their academic success. Explicit strategy instruction may be especially important for at-risk students—those with a history of academic difficulties and a high probability of dropping out of school before they graduate. The collective results of many, many research studies indicate that learners at all grades and ability levels *can* be taught more effective learning and study strategies, with consequent improvements in their memory, classroom performance, and academic achievement (L. Baker, 1989; Edmonds et al., 2009; Fletcher & Bray, 1996; Haller, Child, & Walberg, 1988; Hattie, Biggs, & Purdie, 1996; C. C. Kulik, Kulik, & Shwalb, 1983; Lange & Pierce, 1992; Mastropieri & Scruggs, 1989; Meltzer, 2007; J. P. Williams & Atkins, 2009).

Researchers have identified a number of practices that promote the development of more sophisticated metacognitive knowledge and skills. Following are some guidelines to keep in mind:

- ◆ *Students learn strategies more effectively when the strategies are taught within the context of specific subject domains and ongoing learning tasks* (Hattie et al., 1996; Meltzer & Krishnan, 2007; P. A. Ornstein et al., 2010; Paris & Paris, 2001; Pressley, Harris, & Marks, 1992). As students encounter specific academic content, they should simultaneously learn ways to study the content. For example, when presenting new information in class, a teacher might (1) suggest how students can organize their notes, (2) describe mnemonics for things that are hard to remember, and (3) ask various students to summarize the ideas presented. When assigning textbook pages to be read at home, a teacher might (4) suggest that students consider what they know about a topic before they begin reading about it, (5) ask students to use headings and subheadings to make predictions about upcoming content, and (6) provide questions for students to ask themselves as they read.

- ◆ *Students can use sophisticated learning strategies only when they have a knowledge base to which they can relate new material.* You should recall a point made in Chapter 9: One of the most important factors influencing such processes as meaningful learning and elaboration is *what a learner already knows*. And as we discovered in earlier sections of the chapter, students' prior knowledge affects their ability to separate important ideas from trivial facts and to effectively monitor their comprehension. Perhaps the limited capacity of working memory comes into play here: Students can do only so much (mentally) at a time, and they may not have the "room" to use sophisticated learning strategies if they must struggle to make even preliminary sense of what they're studying (e.g., see Demetriou & Kazi, 2001; Lehmann & Hasselhorn, 2007; Waters & Kunmann, 2010). Thus, teachers must be careful to present difficult material only after students have sufficiently mastered prerequisite knowledge and skills to genuinely understand it.

- ◆ *Students should learn a wide variety of strategies, as well as the situations in which each one is appropriate* (Jetton & Dole, 2004; Nist, Simpson, Olejnik, & Mealey, 1991; Pressley, Harris, & Marks, 1992; C. E. Weinstein, Goetz, & Alexander, 1988). Different strategies are useful in different situations; for instance, meaningful learning may be more effective for learning general principles within a discipline, whereas mnemonics may be more effective for learning hard-to-remember pairs and lists. Organizing ideas in a hierarchical fashion may be appropriate for one unit (e.g., see Figure 9.5); organizing them in a two-dimensional matrix may be appropriate for another (e.g., see Figure 4.2). Some students need assistance not only in organizing information but also in organizing *what they need to do*; for instance, many can benefit from explicit

instruction in how to organize their notebooks and assignments, keep track of appointments and due dates, establish priorities for a study session, and the like (Belfiore & Hornyak, 1998; Meltzer, Pollica, & Barzillai, 2007).

- ◆ *Effective strategies should be practiced with a variety of tasks and on an ongoing basis* (A. Collins, Brown, & Newman, 1989; Nokes & Dole, 2004; Pressley, El-Dinary, Marks, Brown, & Stein, 1992; Pressley et al., 1990). When students learn a strategy only for one particular task, they're unlikely to use it in other contexts. But when they apply the same strategy to many different tasks over a long period, they're apt to recognize the strategy's value and apply it in new situations. Effective strategy instruction, then, cannot be a one-shot deal.

- ◆ *Strategy instruction should include covert as well as overt strategies* (Kardash & Amlund, 1991). Certainly students stand to benefit from guidance about how to take notes, create outlines, and write summaries of what they've learned. But the sophisticated cognitive processes that underlie these behaviors—learning meaningfully, elaborating, monitoring comprehension, and so on—are ultimately the most important strategies for students to acquire.

- ◆ *Teachers can model effective strategies by thinking aloud about new material* (Brophy, Alleman, & Knighton, 2009; McKeown & Beck, 2009; P. A. Ornstein et al., 2010). When teachers think aloud about material their classes are studying (e.g., “I remember that *Au* is the symbol for gold by remembering, ‘*Ay, you stole my gold watch!*’” or “Hmm . . . it seems to me that Napoleon's military tactics were similar to those of the ancient Assyrians”), they give students specific, concrete examples of how to process information effectively.

- ◆ *Students can also benefit from reflecting on and describing their current study strategies.* Even at the college level, low achievers don't always have much metacognitive insight into how they approach classroom learning tasks. Regularly encouraging students to think about how they know something or how they went about learning it—as well as about how they might learn it more effectively—can sometimes help them bring implicit metacognitive strategies to the surface for careful scrutiny and reflection (Cornoldi, 2010; Großschedl & Harms, 2010; May & Etkina, 2002; S. Miller, Heafner, & Massey, 2009). Also beneficial is having students tell their peers about strategies that they've personally found to be useful (McGovern, Davis, & Ogbu, 2008; Meltzer et al., 2007).

- ◆ *Teachers should scaffold students' initial attempts at using new strategies, gradually phasing out the scaffolding as students become more proficient.* Many of the metacognitive activities we've considered in this chapter (e.g., note taking, comprehension monitoring, summarizing) are challenging tasks indeed, and some teacher scaffolding to facilitate them is clearly in order. We've already seen several examples of how teachers can scaffold students' learning and study strategies. For instance, teachers can provide a general organizational framework to guide note taking. They can provide examples of questions students can use to monitor their comprehension as they read (e.g., “Explain why . . .” or “What's a new example of . . . ?”). They can provide guidance about how to develop a good summary (e.g., “Identify or invent a topic sentence” or “Find supporting information for each main idea”). Such scaffolding is most likely to be helpful when students are studying subject matter they find difficult to comprehend yet *can* comprehend if they use appropriate strategies (Pressley, El-Dinary, et al., 1992).

As noted in Chapter 13, teachers can often scaffold complex classroom tasks through the use of computer tools—word processing programs, spreadsheets, and the like. In recent years, researchers have discovered that appropriately designed software can also scaffold students' learning strategies and self-regulated learning in computer-based instruction and online research



(Azevedo, 2005; Koedinger, Alevan, Roll, & Baker, 2009; B. Y. White & Frederiksen, 2005). For instance, as students study a topic in a hypermedia program—one that allows them to choose among many possible pathways and information sources—software might occasionally encourage them to set goals for their learning or ask them to identify causal relationships among concepts (Azevedo & Witherspoon, 2009; Graesser, McNamara, & VanLehn, 2005). As students search the Internet for resources about a particular topic, computer software might occasionally remind them about their goal(s) in conducting the research or about the criteria they should use to evaluate the content of a particular website (Afflerbach & Cho, 2010; Quintana, Zhang, & Krajcik, 2005).

◆ *Students can often learn effective strategies by working collaboratively with their classmates.* As noted in Chapter 13, peer-interactive instructional strategies can often promote more sophisticated cognitive processing. When students explain their thinking and reasoning, they make their thoughts more visible to themselves and others—and thus more available for inspection, reflection, and modeling. Collaborative learning activities are especially likely to promote students' metacognitive development when they're structured to promote complex cognitive processes—for instance, when students are taught to ask one another higher-level questions (see the discussions of reciprocal teaching and guided peer questioning in Chapter 13.)

◆ *Students must understand why new strategies are helpful.* Strategy instruction is more successful when students not only learn effective strategies but also learn *how* and *why* these strategies enhance learning and memory (Hattie et al., 1996; Paris & Paris, 2001; Pressley & Hilden, 2006). For example, in my own classes, I sometimes do demonstration “experiments” that illustrate the value of mnemonics: I present information that's difficult to remember and then give some students a mnemonic for learning it while giving other students no guidance at all. Next I write students' “test” scores on the board (I always present the learning task in such a way that low scores don't damage any potentially fragile egos) and compare the performance of the two groups. The difference is usually so dramatic that students readily acknowledge the usefulness of the mnemonic I've taught them.

Earlier I mentioned that students often don't realize just how ineffective their current strategies are. In several studies Pressley and his colleagues taught children and adults how to use keyword mnemonics to remember vocabulary words (Pressley, Levin, et al., 1984, 1988; Pressley, Ross, Levin, & Ghatala, 1984). Although the study participants mastered the technique, many of them chose *not* to use it for a similar learning task later on. People who were explicitly asked to consider just how much the keyword method had previously helped them were much more likely to use it again in the new learning task. In a similar manner, teachers might occasionally need to show students in a very concrete fashion—perhaps by giving an ungraded quiz—just how little they're actually learning and remembering using their current ineffective strategies and how much more they might learn using a different approach.

◆ *Students should have epistemic beliefs that are consistent with effective strategies.* As we've seen, students' epistemic beliefs influence the learning strategies they use. Study-strategies training, in and of itself, might change those beliefs but won't *necessarily* do so (Muis, 2007; Schraw & Moshman, 1995). Because students' beliefs about the nature of knowledge and learning are often in the form of implicit rather than explicit knowledge, they may be especially resistant to change (Schraw & Moshman, 1995).

Not only do epistemic beliefs affect students' ability to undergo conceptual change, but in fact revising epistemic beliefs involves conceptual change in and of itself. To nudge students toward increasingly sophisticated epistemic understandings, then, teachers must encourage

students to reflect not only about their learning strategies but also about their underlying beliefs regarding the nature of knowledge and learning (B. Hofer, 2004). Teachers should also create situations in which students find reason to doubt—and so feel dissatisfied with—their current beliefs. Piaget would have called such dissatisfaction *disequilibrium*; more recently, it's been called **epistemic doubt** (Bendixen, 2002; Bendixen & Rule, 2004).

One possible way to change students' epistemic beliefs is to talk specifically about the nature of knowledge and learning—for instance, to describe learning as an active, ongoing process of finding interconnections among ideas and eventually constructing one's own understanding of the world (Schommer, 1994b). But probably even more effective is to provide classroom experiences that lead students to discover that knowledge must by necessity be a dynamic (rather than static) entity and to realize that successful learning sometimes occurs only through effort and persistence. For example, teachers can have students address complex issues and problems that have no clear-cut right or wrong answers. They can teach strategies for gathering data and testing competing hypotheses. They can ask students to compare several explanations of a particular phenomenon and consider the validity and strength of evidence supporting each one. And they can show students, perhaps by presenting puzzling phenomena, that students' current understandings—and in some cases even those of experts in the field—don't yet adequately explain all of human experience (Andre & Windschitl, 2003; C. Chan et al., 1997; P. M. King & Kitchener, 2002; D. Kuhn, 2009; Muis et al., 2006; Schommer, 1994b; vanSledright & Limón, 2006).

Teachers must be careful how far they take such instructional strategies, however. When students are firmly rooted in their *learning-involves-facts-that-I-can-get-only-from-an-expert* beliefs, they may find little of value in—and so may gain little from—lessons that emphasize diverse perspectives and offer few solid answers (Andre & Windschitl, 2003).

♦ *Students should acquire mechanisms for monitoring and evaluating their own learning.* As noted earlier, self-regulating learners monitor their progress throughout a learning task and then evaluate their ultimate success in mastering what they've been studying. Ideally they evaluate their learning in terms of the *specific* things they have and haven't mastered: Rather than make a global judgment (“I think I finally understand this stuff”), they check themselves piece by piece (“Okay, I can correctly recognize examples of negative reinforcement and punishment, but I don't yet understand the difference between ratio and interval schedules of reinforcement”) (Dunlosky & Lipko, 2007; Zhao & Linderhold, 2008).

In addition to teaching students self-questioning—a strategy that facilitates comprehension monitoring—researchers have offered several recommendations for how teachers can help students effectively engage in self-monitoring and self-evaluation:

- Clarify the desired outcomes of a learning task; for instance, be explicit about how students' learning will be assessed (Andrade, 2010; Otero, 2009; Serra & Metcalfe, 2009; Thiede et al., 2009).
- Have students set specific goals and objectives for a study session and then describe achievements in relation to each one (Eilam, 2001; Mithaug & Mithaug, 2003; Morgan, 1985).
- Ask students to keep ongoing records of their performance and to reflect on their learning in writing assignments, journals, or portfolios (Belfiore & Hornyak, 1998; Meltzer et al., 2007; Paris & Paris, 2001; N. E. Perry, 1998).
- Provide specific criteria students can use to judge their performance; possibly include students in the development of these criteria (Andrade, 2010; McMillan, 2010; Paris & Ayres, 1994; Windschitl, 2002).

- Provide self-tests students can use to assess their current understandings of class material (Dunlosky, Rawson, & McDonald, 2002; Nietfeld & Cao, 2004; Zimmerman & Moylan, 2009).
- On some occasions, delay teacher feedback so that students first have the opportunity to evaluate their own performance (D. L. Butler & Winne, 1995; Schroth, 1992).
- Encourage students to evaluate their performance realistically, and then reinforce them (e.g., with praise or extra-credit points) when their evaluations match the teacher's (McCaslin & Good, 1996; Nietfeld & Cao, 2004; Schraw, Potenza, & Nebelsick-Gullet, 1993; Zuckerman, 1994).

Even 5- and 6-year-olds can be encouraged to reflect on their performance and progress, perhaps through questions such as “What were we doing that we’re proud of?” and “What can we do that we didn’t do before?” (Mithaug & Mithaug, 2003; N. E. Perry, VandeKamp, Mercer, & Nordby, 2002, p. 10). By engaging frequently in self-monitoring and self-evaluation of classroom learning tasks, students should eventually develop appropriate standards for their performance and regularly apply the standards to the things they accomplish—true hallmarks of a self-regulating learner.

♦ *Students must believe that, with sufficient effort and appropriate strategies, they can learn and understand challenging material.* Strategy instruction must give students a reasonable sense of self-efficacy about their ability to learn classroom material. And it must show them that their success in learning is, in fact, related to the specific strategies they use (D. L. Butler & Winne, 1995; Palmer & Goetz, 1988; Pressley, El-Dinary, et al., 1992; Shapley, 1994; Zimmerman & Moylan, 2009). Once students believe they can learn academic subject matter successfully, they’re more likely to *want* to learn it, for reasons we’ll identify in Chapter 16.

By teaching students the metacognitive knowledge and skills they need for learning challenging classroom material, teachers not only help students learn material more successfully but also help them become more effective learners over the long run. And it’s the long run for which teachers must ultimately prepare their students.

Yet even with effective learning and self-regulatory skills, and even with high self-efficacy, students won’t necessarily become intentional, “thoughtful” learners who gain maximum benefit from their classroom experiences. Ultimately, *motivating* students to learn is as important as *helping them learn how to learn*. Thus, the motivational strategies we’ll identify in Chapters 16 and 17 are important complements to the instructional strategies we’ve identified here.

---

## SUMMARY

People’s knowledge and regulation of their own thinking and learning processes is known as *metacognition*. Students with more advanced metacognitive knowledge and skills typically achieve at higher levels in the classroom.

The most successful students are *self-regulating learners*: They set goals for their performance, plan how best to use their learning time, keep their attention on what they need to accomplish as they study, choose and use effective learning strategies, seek

help when they need it, and continually monitor their progress. Some self-regulated learning skills may be self-developed, but many probably emerge when other people model them or when students work with more experienced learners (e.g., teachers) to co-regulate a learning task.

Effective learning and study strategies include meaningful learning, elaboration, organization, note taking, identifying important information, summarizing, comprehension monitoring, and using mnemonics

for hard-to-remember facts and lists. Most important are the internal mental processes (covert strategies) that students use; any observable study behaviors (overt strategies) are likely to be effective only when the underlying covert strategies are productive. Children show increasing metacognitive sophistication as they grow older and gain more experience with academic learning tasks; nevertheless, many students at the high school and college levels are sadly uninformed or misinformed about how best to learn and study.

Learners' *epistemic beliefs* are the things they believe about the nature of knowledge (e.g., whether it's static or dynamic, whether it involves isolated facts or a cohesive body of interrelated ideas, whether it comes from an outside authority or must ultimately be constructed and evaluated by oneself) and the nature of learning (e.g., whether it occurs quickly or slowly, and whether it's influenced more by inherited ability or more by effort and strategies). Students' epistemic beliefs influence the approaches they take to learning tasks and the criteria they use to decide when they've successfully mastered something. Such beliefs continue to evolve throughout students' educational careers, with particularly sophisticated ones typically not emerging until the undergraduate or graduate school years.

Ideally, students should be *intentional* learners. That is, they should be actively and consciously engaged in the learning process, identify particular goals to accomplish as they study, and bring a wide variety of learning and self-regulatory strategies to any study session. Intentional learning is especially important when students must undergo considerable

conceptual change in order to truly understand the subject matter.

There are numerous reasons why students often don't use effective strategies to learn classroom subject matter. For example, students may be uninformed about effective strategies or have overly simplistic beliefs about what "knowing" something means. They may have insufficient prior knowledge about a topic to enable meaningful learning and elaboration, or assigned classroom tasks may not lend themselves to such strategies. Students may be uninterested in mastering classroom subject matter or, alternatively, may think they can't master it regardless of what they do.

Research indicates that training in effective learning and study strategies can significantly enhance students' classroom achievement. Researchers have offered a number of suggestions for promoting more sophisticated metacognitive knowledge and skills. For example, instruction regarding effective learning strategies is more successful when presented within the context of specific academic content rather than as a topic in and of itself. Strategy instruction is also more successful when students have numerous opportunities to practice specific strategies and when teachers and classmates scaffold early efforts. Students must develop epistemic beliefs consistent with effective learning strategies, and they must acquire mechanisms for monitoring and evaluating their learning efforts. Ultimately, students must discover that, with sufficient effort and appropriate strategies, they *can* learn and understand challenging classroom material.

## CHAPTER 15

---

# TRANSFER, PROBLEM SOLVING, AND CRITICAL THINKING

### *Transfer*

*Types of Transfer*

*Theories of Transfer*

*Factors Affecting Transfer*

### *Problem Solving*

*Theories of Problem Solving*

*Cognitive Factors in Problem Solving*

*Problem-Solving Strategies*

*Meaningless versus Meaningful Problem Solving*

*Facilitating Transfer and Problem Solving in the  
Classroom*

*Critical Thinking*

*Developmental, Individual, and Cultural*

*Differences in Critical Thinking*

*Fostering Critical Thinking in the Classroom*

*Summary*

In my many years of college teaching, the course I've taught most frequently is an undergraduate educational psychology course for students preparing to become teachers. In various class sessions I introduce such topics as contemporary memory theory, instrumental conditioning, cognitive development, motivation, classroom management, and educational assessment. Many of my students seem to learn the material well: They carry on informed discussions in class and demonstrate comprehension and application on assignments and exams. But I always wonder what these students do after they finish my course. Do the things they've learned in my course eventually influence how they teach their own students? Do they really apply the concepts I've taught them? Do principles and theories of educational psychology help them solve instructional problems?

Another topic I address in my educational psychology course is the importance of psychological and educational research for informing instructional practice, and as you might guess from reading this book, throughout the semester I regularly draw on research findings. But after my students finish their formal training and become teachers, they must keep abreast of *new* research results. Can they distinguish between well-designed studies and poorly conceived and executed ones? Can they determine whether researchers' conclusions are valid and important or, instead, completely bogus?

The questions I've posed in the first paragraph are questions about *transfer* and *problem solving*; those in the second paragraph are concerned with *critical thinking*. In this chapter, we'll look at all three processes and consider how we might promote them in classroom settings.

## TRANSFER

---

When something you learn in one situation affects how you learn or perform in another situation, **transfer** is occurring. Transfer is a part of everyday life: People continually encounter new situations and draw on previously acquired knowledge and skills to deal with them. In fact, transfer is an essential component of human functioning. Without it, people would have to start

from scratch about how to behave in every new circumstance and would spend much of their time in trial-and-error learning.

If you think back to our discussions of classical and instrumental conditioning in Chapters 3 and 4, you might realize that we've already talked a bit about transfer. In those chapters we considered the phenomenon of *generalization*: After an organism learns a response to one stimulus, it often makes the same response to similar stimuli—stimuli it hasn't necessarily encountered before.

In most instructional settings, transfer should be a top priority. Most schools teach knowledge and skills with the assumption that students will in some way apply what they've learned to the outside world. Yet the things people learn in school don't always transfer to new situations. Some adults can't use basic addition and subtraction procedures to balance their checkbooks. Some teachers reinforce inappropriate behaviors in their classrooms, ignoring the basic behaviorist principles they learned in their undergraduate psychology classes. Many learning theorists agree that, in general, much school learning seems to yield **inert knowledge** that students never use outside the classroom (e.g., Carr, 2010; Haskell, 2001; Perkins & Salomon, 1989; Renkl, Mandl, & Gruber, 1996; van Merriënboer & Kester, 2008; Whitehead, 1929).

## Types of Transfer

Transfer can involve declarative knowledge, procedural knowledge, or an interplay between the two. For instance, when the word *HOMES* helps you remember the names of the five Great Lakes of North America, one piece of declarative knowledge is helping you recall several other declarative tidbits. When your skill in throwing a baseball helps you cast a fishing line, your existing procedural knowledge is assisting you in learning a new procedure. When your understanding of the base-10 number system helps you as you "borrow" in subtraction problems, your declarative knowledge is guiding your execution of a procedure. Transfer can go in the reverse direction as well—from procedural to declarative knowledge—as I found out in an attempt at waterskiing a few years ago. I had water-skied quite a bit in my teens and twenties and fancied myself to be a reasonably skillful skier. After a long hiatus, I tried skiing again in my mid-fifties. The boat had a hard time pulling me up and had to go much faster—too fast for my comfort zone—to keep me on the water's surface. I had, alas, gained 30 pounds during that ski-free hiatus. My newly acquired declarative knowledge—more poundage requires more speed to stay afloat—spurred a renewed commitment to minimize my junk food intake.

In addition to acknowledging that transfer can involve different kinds of knowledge, theorists have made several distinctions among types of transfer: positive versus negative, vertical versus lateral, near versus far, and specific versus general.

### *Positive versus Negative Transfer*

When learning in one situation facilitates learning or performance in another situation, **positive transfer** is at work. Practice in reading helps with spelling, and vice versa (N. J. Conrad, 2008). Learning principles of instrumental conditioning and self-regulation can help a teacher keep students on task in the classroom. Two long-term memory storage processes we've come to know well—meaningful learning and elaboration—are also instances of positive transfer, because they involve using previously acquired information to understand and remember new material (Ausubel, Novak, & Hanesian, 1978; Brooks & Dansereau, 1987). "Old" information can help meaningful and elaborative learning in a variety of ways—perhaps by serving as a conceptual

framework to which new material is attached, helping a learner fill in holes when new ideas are ambiguous or incomplete, or providing a concrete analogy that makes abstract ideas easier to understand.

In contrast, when something learned in one situation hinders a person's ability to learn or perform in a second situation, **negative transfer** is operating. For example, when driving a car with an automatic transmission, people accustomed to driving a standard transmission may step on a clutch that isn't there. People who learn a second language typically apply patterns of speech production characteristic of their native tongue, giving them a foreign accent; they may also mistakenly apply spelling patterns from their native language (Fashola, Drum, Mayer, & Kang, 1996; R. A. Schmidt & Young, 1987; Sun-Alperin & Wang, 2008). Students accustomed to memorizing facts in other college courses often don't perform well on my own application-oriented exams.

Negative transfer often rears its ugly head in work with decimals: Students may erroneously apply mathematical rules they've learned for whole numbers (Karl & Varma, 2010; Ni & Zhou, 2005). For example, when asked to compare decimals such as these:

2.34 versus 2.8

students may apply the rule "More digits mean a larger number" and conclude that 2.34 is the larger one (Behr & Harel, 1988). Another rule inappropriately transferred to decimals is this whole-number rule: "When a number is divided, the result is a smaller number." Even college students show negative transfer of this rule; for instance, many assert that the answer to this problem:

$5 \div 0.65$

is a number smaller than 5 (Tirosh & Graeber, 1990). The answer is actually about 7.69, a *larger* number.

As you can see, then, transfer is sometimes a good thing and sometimes not.

### ***Vertical versus Lateral Transfer***

In some subject areas, topics build on one another in a hierarchical fashion, so that a learner must almost certainly master one topic before moving to the next. For example, an elementary school student should probably master principles of addition before moving to multiplication, because multiplication is an extension of addition. Similarly, a medical student must have expertise in human anatomy before studying surgical techniques: It's difficult to perform an appendectomy if you can't find the appendix. **Vertical transfer** refers to such situations: A learner acquires new knowledge or skills by building on more basic information and procedures.

In other cases, knowledge of one topic may affect learning a second topic even though the first isn't a prerequisite to the second. Knowledge of French isn't essential for learning Spanish, yet knowing French can help with Spanish because many words are similar in the two languages. When knowledge of the first topic is helpful but not essential to learning the second one, **lateral transfer** is occurring.

### ***Near versus Far Transfer***

**Near transfer** involves situations or problems that are similar in both superficial characteristics and underlying relationships. For example, consider the following problem:

An automotive engineer has designed a car that can reach a speed of 50 miles per hour within 5 seconds. What's the car's rate of acceleration?

Let's assume that you've learned how to solve this problem using the formula  $v = a \times t$  (velocity = acceleration  $\times$  time elapsed). You then encounter this problem:

A car salesperson tells a customer that a particular model of car can reach a speed of 40 miles per hour within 8 seconds. What's the car's rate of acceleration?

The two problems have similar surface characteristics (both involve cars) and similar underlying structures (both involve the relationship among velocity, acceleration, and time). But now imagine that after solving the first problem, you instead encounter this problem:

A zoologist reports that a cheetah she's been observing can increase its speed by 6 kilometers-per-hour each second. How long will it take the cheetah to reach a running speed of 60 kilometers-per-hour?

Although the general structure is the same as before (once again, the  $v = a \times t$  formula applies), we've now switched topics (from cars to cheetahs), units of measurement (from miles-per-hour to kilometers-per-second), and unknowns (from acceleration rate to time). **Far transfer** involves two situations that are similar in one or more underlying relationships but *different* in their surface features. An even "farther" instance of transfer might involve taking the  $v = a \times t$  formula outside the classroom altogether—say, to real-world problems on a highway or at a race track.

### ***Specific versus General Transfer***

Both near and far transfer are instances of **specific transfer**, in which the original learning task and the transfer task overlap in some way. For example, knowing about human anatomy should help a veterinary student learn dog anatomy because the two species have many parallel anatomical features. A student who knows Spanish should easily learn Portuguese because the two languages have similar vocabulary and syntax.

In **general transfer**, the original task and the transfer task are different in both content and structure. For example, if knowledge of Latin helps a student learn physics, or if the study habits acquired in a physics course facilitate the learning of sociology, then general transfer is occurring.

Near transfer is more common than far transfer, and specific transfer is more common than general transfer (S. M. Barnett & Ceci, 2002; Bassok, 1997; Di Vesta & Peverly, 1984; W. D. Gray & Orasanu, 1987; Perkins & Salomon, 1989). In fact, the question of whether general transfer occurs at all has been the subject of much debate over the years. We turn now to both early and contemporary theories of transfer, which vary considerably in their perspectives of what things transfer and when.

## **Theories of Transfer**

How does transfer occur? We'll look first at an early view of transfer—one that predates twentieth-century learning theories—and then see what both behaviorists and cognitivists have had to say about how and when transfer takes place.

### ***A Historical Perspective: Formal Discipline***

In days of yore, serious scholars often studied rigorous, difficult topics—for instance, Latin, classical Greek, and formal logic—that aren't as frequently studied today. Although these subject areas may have had no specific applicability to everyday tasks, scholars believed that mastering them would improve performance in many aspects of daily life. As recently as the middle of the twentieth



century, students had frequent practice in memorizing things—poems, for example—apparently as a presumed means of improving their general learning capabilities. Such practices reflect the notion of **formal discipline**: Just as you exercise muscles to develop strength, you exercise your mind to learn more quickly and deal with new situations more effectively.

Formal discipline emphasizes the importance and likelihood of general transfer, the idea being that learning in one situation improves learning and performance in another situation regardless of how different the two situations might be. As researchers began to study human learning systematically, however, they soon discarded this mind-as-muscle idea. For example, in research he described in 1890, William James<sup>1</sup> memorized a new poem each day over the course of several weeks, predicting that the practice would enhance his poem-learning ability. Yet his poem learning didn't improve; if anything, he learned his later poems more *slowly* than the early ones. And more recently, researchers have found that learning computer programming—a skill requiring precise, detailed thinking about a logical sequence of events—has no impact on logical thinking in areas unrelated to computer use (Mayer & Wittrock, 1996; Perkins & Salomon, 1989).

The consensus of most contemporary theorists is that general transfer, in the extreme sense portrayed by the formal discipline perspective, probably doesn't occur (e.g., Haskell, 2001; Salthouse, 2006). But notice that I said *most* contemporary theorists. Some intriguing findings have emerged lately to suggest that general mental exercise might indeed have long-ranging transfer effects. For example, in research that was widely publicized in the popular media, David Snowdon (2001) studied a convent of elderly nuns who kept mentally active with seminars, debates, puzzles, journal writing, and so on well into their nineties. Many of the nuns generously donated their brains to science, and post mortem studies found many more axons and dendrites than are typically found in 90+-year-olds. Snowdon's research didn't conclusively demonstrate causation—perhaps the convent attracted especially bright nuns to begin with—but other recent studies have shown that certain kinds of mental exercise do seem to have broad benefits. For example, when children have practice using a computer joystick to quickly move a cartoon cat to various locations on a computer screen, their enhanced attention skills transfer to very different situations, presumably reflecting enhanced central-executive skills (M. I. Posner & Rothbart, 2007). And for adults, daily practice with simple computer-based memory tasks seems to enhance memory in other, dissimilar situations, at least in the short run (Jaeggi, Buschkuhl, Jonides, & Perrig, 2008). Personally, I'm taking a wait-and-see attitude about all of this: Such findings need to be replicated before we jump to definitive conclusions about the value of general mental exercise.

### ***An Early Behaviorist Theory: Thorndike's Identical Elements***

Let's consider the work of another early psychologist: Edward Thorndike, whose cat-in-a-puzzle-box observations laid a foundation for behaviorist views on reinforcement and punishment (see Chapter 4). Thorndike proposed that transfer occurs only to the extent that the original and transfer tasks have *identical elements*—that is, the two tasks involve some of the same specific stimulus–response associations. In an early study supporting his view (Thorndike & Woodworth, 1901), people received extensive training in estimating the areas of rectangles. The training improved

---

<sup>1</sup>We previously encountered William James in Chapter 8. More than 100 years ago, James (1890) suggested that human memory has three components very similar to those in the now-popular dual-store model of memory.

people's subsequent ability to estimate the areas of rectangles and other two-dimensional forms (e.g., triangles and circles) but had less impact on judgments for the nonrectangular shapes—presumably because nonrectangles have elements both similar and dissimilar to those of rectangles. In a later study, Thorndike (1924) examined the interrelationships of high school students' achievement in various academic disciplines. Achievement in one subject area appeared to facilitate students' achievement in another only when the two subjects were similar. For example, arithmetic achievement was correlated with performance in a bookkeeping course, but Latin proficiency wasn't. Thorndike concluded that the value of studying specific topics was due not to the benefits of mental exercise but to “the special information, habits, interests, attitudes, and ideals which they demonstrably produce” (Thorndike, 1924, p. 98).

### ***A Later Behaviorist Perspective: Similarity of Stimuli and Responses***

Subsequent to Thorndike's work, behaviorist views of transfer have focused on how transfer is affected by stimulus and response characteristics in both the original and transfer situations. As an illustration, consider these four lists of paired associates:

<b>List 1</b>	<b>List 2</b>	<b>List 3</b>	<b>List 4</b>
lamp–shoe	lamp–sock	rain–shoe	lamp–goat
boat–fork	boat–spoon	bear–fork	boat–shop
wall–lawn	wall–yard	sofa–lawn	wall–rice
corn–road	corn–lane	book–road	corn–fish

Imagine that you first learn List 1 and then must learn List 2. Will your knowledge of the pairs in List 1 help you learn the pairs in List 2? Based on the results of verbal learning studies (J. F. Hall, 1966, 1971), the answer is yes: Stimuli are identical and responses are similar in the two situations, so positive transfer will occur.

Now, however, imagine that you have to learn List 1 and then List 3. Will prior learning of List 1 help with List 3? The answer again is yes (J. F. Hall, 1966, 1971). Even though the stimulus words are very different, the responses in List 3 are identical to those in List 1—hence they've already been learned—and merely need to be attached to the new stimuli.

But now let's now suppose that after learning List 1, you need to learn List 4. Here's a case in which very different responses from those of List 1 must be learned to the very same stimuli. Learning List 1 is likely to make learning List 4 more difficult because you'll sometimes remember the List 1 response instead of the List 4 response (J. F. Hall, 1966, 1971), and negative transfer will result.

In general, a stimulus–response view of transfer has yielded three central principles (Osgood, 1949; Thyne, 1963):

- When stimuli and responses are similar in the two situations, maximal positive transfer will occur.
- When stimuli are different and responses are similar, some positive transfer will occur.
- When stimuli are similar and responses are different, negative transfer will occur.

As an example of the first and second principles, you may have found that certain responses you make in one computer application—say, “cutting” and “pasting” in a word-processing

program—also work in other computer applications—say, in email or spreadsheets. As an example of the third principle, I recall a year when, as a high school student, my class schedule included second-period Latin and third-period French. The word for “and” (*et*) is spelled the same in both languages but pronounced very differently (“et” in Latin and “ay” in French), hence meeting the conditions for negative transfer (similar stimuli, different responses). On several occasions I blurted out an “et” in my third-period French class—a response that inevitably evoked a disgusted scowl from my French teacher.

As learning theorists have moved away from behaviorist perspectives to more cognitive explanations of transfer, they’ve spoken less and less of specific stimulus–response connections. Nevertheless, they agree that the likelihood of transfer increases considerably when similarities exist between things already learned and the demands of a new situation.

### ***An Information Processing Perspective: Importance of Retrieval***

From an information processing perspective, the crux of the transfer matter boils down to a single thing: whether learners retrieve what they’ve previously learned at a time when it might be useful (e.g., Cormier, 1987; Haskell, 2001; S. M. Lane, Matthews, Sallas, Prattini, & Sun, 2008; Rawson & Middleton, 2009). To make a connection between their current situation and any potentially relevant prior knowledge, learners must have the two things in working memory simultaneously. Given the low probability that any particular piece of information will be retrieved, as well as the limited capacity of working memory, a good deal of potentially relevant information and skills may very well *not* be transferred to situations in which they would be useful.

The presence or absence of retrieval cues in the transfer situation influences what relevant knowledge, if any, is retrieved to working memory. A new event is more likely to call to mind previously learned information when aspects of the event and the needed information are closely associated in long-term memory. This will be the case, for instance, if learners previously anticipated the transfer situation when first storing the information.

### ***A Contextual Perspective: Situated Learning***

As we discovered in Chapter 13, some cognitive theorists have proposed that much of what we learn is context specific—that is, it’s “situated” in the environment in which it takes place. Such **situated learning** is unlikely to result in transfer to new contexts, especially those very different from the ones in which learning originally occurred (J. S. Brown, Collins, & Duguid, 1989; Greeno, Moore, & Smith, 1993; Kirsh, 2009; Lave & Wenger, 1991; Light & Butterworth, 1993; J. E. Wagner, 2006).

Even at school, knowledge and skills don’t necessarily transfer from one classroom to another. A study by Saljo and Wyndham (1992) provides an illustration. High school students were asked to determine how much postage they should put on an envelope weighing a particular amount, and they were given a table of postage rates with the information they needed. When students were given the task in a social studies class, most of them used the postage table to find the answer. But when students were given the task in a math class, most of them ignored the table and tried to *calculate* the postage in some manner, sometimes figuring it to several decimal places. Thus, the students in the social studies class were more likely to solve the problem correctly; as a former social studies teacher myself, I suspect that they were well accustomed to looking for information in tables and charts in that context. In contrast, many of the students in math class drew on strategies they associated with that class (using formulas and performing calculations) and so overlooked the more efficient and accurate approach.

It's important to note here that not all cognitivists believe that school learning is as situated as some of their colleagues claim (e.g., see J. R. Anderson, Reder, & Simon, 1996, 1997; Bereiter, 1997; Perkins, 1992). For example, most individuals in our society engage in reading and simple mathematics—two sets of skills they've probably learned at school—in many nonschool contexts. A key factor here appears to be the extent to which learners *perceive* a content domain to be applicable to a wide range of circumstances (R. A. Engle, 2006; M. C. Linn, 2008; Mayer & Wittrock, 1996; R. J. Sternberg & Frensch, 1993). For example, when baking cookies, an 11-year-old might ask a parent, “Do two one-quarters make two fourths? I know it does in math but what about in cooking?” (Pugh & Bergin, 2005, p. 16). Fortunately, most students eventually learn that math has wide applicability, perhaps because teachers ask students to apply mathematical principles to a wide variety of situations and problems. The same isn't necessarily true for other disciplines, however. For example, although college students often transfer skills they learn in algebra to a physics class, they rarely transfer skills in the other direction, from physics to algebra (Bassok, 1997).

### ***A Contemporary View of General Transfer: Learning to Learn***

We've already seen two extreme perspectives regarding general transfer. Advocates of formal discipline argued that learning rigorous and demanding subject matter facilitates virtually all future learning tasks because it “disciplines” and thus strengthens the mind. At the other extreme, Thorndike argued that learning in one situation will transfer to another situation only to the extent that the two situations have identical elements. Current perspectives about general transfer are somewhere in between: General transfer isn't as common as specific transfer, but learning occurring at one time *can* facilitate learning at another time if, in the process, the individual *learns how to learn*.

In several early studies of learning to learn, Harry Harlow (1949, 1950, 1959) found that monkeys and young children became progressively faster at discrimination-learning tasks. More recently, a number of studies have examined the transfer value of metacognitive knowledge and skills. Effective study strategies and habits, such as those we examined in Chapter 14, often do generalize from one subject matter to another (S. M. Barnett & Ceci, 2002; Bransford & Schwartz, 1999; Bransford et al., 2006; Cormier & Hagman, 1987a; De Corte, 2003).

### ***Going Beyond Transfer of Knowledge: Emotional Reactions and Motivation May Transfer as Well***

Despite their differences, all the views of transfer we've examined so far have one thing in common: As long as two tasks have at least *some* overlap in the information or skills required—even if the skills in question are general metacognitive ones rather than topic-specific ones—the possibility of transfer from one situation to the other exists. Yet transfer isn't necessarily limited to cognitive and metacognitive acquisitions. For instance, recall how, in my discussion of classical conditioning in Chapter 3, Little Albert generalized (transferred) his fear of a white rat to other fuzzy white things. Just as emotional reactions can transfer to new situations, so, too, can motivation transfer. For instance, the kinds of goals students learn to set for themselves in a learning task—perhaps to truly master the subject matter, on the one hand, or to rote-memorize just enough to “get by” on a class assignment or quiz—are apt to carry over as students move from one classroom to a very different one (Pugh & Bergin, 2005, 2006; Pugh, Linnenbrink, Kelly, Manzey, & Stewart, 2006; Volet, 1999). And in some cases, students may develop a general desire to apply what they learn in the classroom—they have a *spirit of transfer*, if you will—that consistently reappears in later instructional contexts (Haskell, 2001; Pugh & Bergin, 2005, 2006).

## Factors Affecting Transfer

Learners are, of course, more likely to transfer something they learn when they approach a learning task with a conscious intention to apply it. But several other factors also influence the probability of transfer, as reflected in the following principles:

- ◆ *Meaningful learning promotes better transfer than rote learning.* In previous chapters we've seen that meaningful learning—connecting new information with things one already knows—leads to more effective long-term memory storage and retrieval than does rote learning. Now we see an additional advantage of meaningful learning: It increases the odds of positive transfer (Brooks & Dansereau, 1987; Mayer & Wittrock, 1996; Schwaborn, Mayer, Thillmann, Leopold, & Leutner, 2010). For example, in one experiment (Mayer & Greeno, 1972), college students received one of two methods of instruction about a particular formula useful in calculating probabilities. Group 1 received instruction that focused on the formula itself, whereas Group 2 received instruction that emphasized how the formula was consistent with students' general knowledge. Group 1 students were better able to apply the formula to problems similar to those they'd studied during instruction, but Group 2 students were better able to use the formula in ways that instruction hadn't specifically addressed—that is, they could transfer the formula to a wider variety of situations.

- ◆ *The more thoroughly something is learned, the more likely it is to be transferred to a new situation.* Research is clear on this point: The probability of transfer increases when students know something *well* (J. M. Alexander, Johnson, Scott, & Meyer, 2008; Cormier & Hagman, 1987a; Haskell, 2001; Voss, 1987).

Thoroughly mastering knowledge and skills takes time, of course. In fact, some conditions that make initial learning slower and more difficult may actually be beneficial both for retention (see Chapter 9) and for transfer over the long run. For example, increasing the variability of tasks that learners practice during instruction—having them perform several different tasks or several variations on the same task within a single instructional unit—lowers their performance initially but enhances their ability to transfer what they've learned to new situations (Z. Chen, 1999; Kornell & Bjork, 2008; R. A. Schmidt & Bjork, 1992; van Merriënboer & Kester, 2008).

Clearly, then, there's a trade-off between expediency and transfer. Teachers who teach a few things in depth are more likely to promote transfer than those who teach many things quickly—the *less-is-more* principle I introduced in Chapter 10.

- ◆ *The more similar two situations are, the more likely it is that something learned in one situation will be applied to the other situation.* Behaviorists have argued that similarity of either stimuli or responses is necessary for transfer to occur. Cognitivists have instead proposed that transfer depends on retrieval of relevant information at the appropriate time, and thus the *perceived* similarity (rather than actual similarity) of the two sets of circumstances is important (Bassok & Holyoak, 1993; Di Vesta & Peverly, 1984; Haskell, 2001; Voss, 1987). Either way, similarity enhances the probability of transfer.

- ◆ *Principles are more easily transferred than discrete facts.* General principles and rules are more applicable than specific facts and information (S. M. Barnett & Ceci, 2002; Gick & Holyoak, 1987; Judd, 1932; M. Perry, 1991; Singley & Anderson, 1989). For example, if you've read Chapter 4, you can probably recall the essence of operant conditioning: *A response that is followed by a reinforcer is strengthened and therefore more likely to occur again.* This principle is easily transferable to a wide variety of situations, whereas specific facts that I mentioned in the same chapter

(e.g., who did what research study and when) are not. Similarly, when students are trying to understand such current events as revolutions and international wars, general principles of history—for example, the principle that two groups of people often engage in battle when other attempts at reaching a mutually satisfying state of affairs have failed—are probably more applicable than precise knowledge of World War II battles. General and perhaps somewhat abstract principles are especially helpful when a new situation does not, on the surface, appear to be similar to previous experiences and yet shares underlying structural or conceptual similarities with those experiences—in other words, when the new situation requires *far transfer* (J. R. Anderson et al., 1996; Perkins, 1995; Perkins & Salomon, 1989).<sup>2</sup>

As students move through the grade levels, they may acquire an ability to apply general principles to topics quite different from those they've previously studied. For example, in one research study, fifth graders and college students were asked to develop a plan for increasing the population of bald eagles, an endangered species in their state (Bransford & Schwartz, 1999). None of the students in either age-group had previously studied strategies for eagle preservation, and the plans that both groups developed were largely inadequate. Yet in the process of developing their plans, the college students addressed more sophisticated questions than the fifth graders did. In particular, the fifth graders focused on the eagles themselves (e.g., How big are they? What do they eat?), whereas the college students looked at the larger picture (e.g., What type of ecosystem supports eagles? What about predators of eagles and eagle babies?) (Bransford & Schwartz, 1999, p. 67). Thus, the college students were drawing on an important principle they had acquired in their many years of science study: Living creatures are more likely to survive and thrive when their habitat supports rather than threatens them.

◆ *Numerous and varied examples and opportunities for practice increase the extent to which information and skills will be applied in new situations.* As situated learning theorists remind us, new knowledge is often stored in association with the contexts in which it has been acquired, and revisiting such contexts increases the chances of retrieving the knowledge. On average, then, the more examples and practice situations in which particular information and skills are encountered, the greater the likelihood that future transfer will occur (J. R. Anderson et al., 1996; Cormier & Hagman, 1987b; B. D. Cox, 1997; Perkins, 1995; R. A. Schmidt & Bjork, 1992; see Bassok & Holyoak, 1993, for an exception). For instance, when students are learning basic arithmetic principles, they might be asked to apply those principles in determining best buys at a grocery store, dividing items equitably among friends, running a lemonade stand, and so on. Arithmetic will then be associated in long-term memory with all of these situations, and when the need arises to determine which of two grocery products yields the most for the money, relevant arithmetic procedures should be readily retrieved.

◆ *The probability of transfer decreases as the time interval between the original task and the transfer task increases* (S. M. Barnett & Ceci, 2002; Gick & Holyoak, 1987). Here's another principle that is probably a result of retrieval: Information that has been learned recently is more

---

<sup>2</sup>Perkins and Salomon (1989) have made a distinction between low-road transfer and high-road transfer. *Low-road transfer* occurs when a new situation is superficially quite similar to prior experiences, such that relevant knowledge and skills are readily retrieved. But in *high-road transfer*, people must make a conscious and deliberate connection between a new situation and their previous experiences; such a connection is often made on the basis of an underlying, abstract principle. In other words, low-road transfer is most likely to occur in situations involving near transfer, whereas high-road transfer is required in situations involving far transfer.

likely—and more able—to be retrieved than information acquired further back in time (recall our discussion of *decay* in Chapter 11).

♦ *Transfer increases when the cultural environment encourages and expects transfer.* Not only have behaviorists, information processing theorists, and situated learning theorists weighed in on the topic of transfer but so, too, have sociocultural theorists (R. A. Engle, 2006; Haskell, 2001; Pea, 1987; Rogoff, 2003). In particular, these theorists suggest that teachers and other experts who regularly point out similarities among seemingly diverse tasks and situations and who communicate the importance of transfer increase the chances that learners will apply what they learn to new situations. Such a culture often exists in the workplace: New employees are expected to use newly acquired declarative and procedural knowledge in a wide variety of work situations (Haskell, 2001; Wenger, 1998). It's also evident in some classrooms, but probably isn't as pervasive in schools as it should be. All too often, it seems, students are encouraged to acquire school subject matter for mysterious purposes (e.g., "You'll need to know this in college" or "It will come in handy later in life") but given little insight about when and in what ways it will be useful.

## PROBLEM SOLVING

---

When we talk about **problem solving**, we're talking about using knowledge and skills we've previously learned—that is, *transferring* them—to address an unanswered question or troubling situation. Following are examples:

1. What number is obtained when 3,354 is divided by 43?
2. How can a 60-something educational psychologist be helped to control her junk food habit?
3. How can two groups of people of differing political or religious persuasions and a mutual lack of trust be convinced to curtail their proliferation of military weapons and work toward cooperation and peaceful coexistence?

The world presents us with many different kinds of problems. Some, such as Problem 1, are straightforward: All the necessary information is presented, and the solution is definitely right or wrong. Others, such as Problem 2, may necessitate seeking out additional information (e.g., does the educational psychologist keep physically active, or does she sit around the house all day reading mystery novels and watching television game shows?), and there may be two or more solutions to the problem (e.g., self-reinforcement for altered eating habits, six months on a tropical island with no grocery stores). Still others, such as Problem 3, may be so complicated that even after considerable research and creative thought, no easy solution emerges. Different kinds of problems require different procedures and different solutions; this multifaceted nature of problem solving has made the theoretical study of problem solving a very challenging endeavor indeed.

Any problem has at least three components (Glass, Holyoak, & Santa, 1979; Wickelgren, 1974):

- *Goal:* The desired end state—what a problem solution will hopefully accomplish
- *Givens:* Pieces of information provided when the problem is presented
- *Operations:* Actions that can be performed to approach or reach the goal

Operations often take the form of IF–THEN rules: If I get such-and-such, then I next need to do such-and-such (recall the discussion of *productions* in Chapter 10).

Problems vary greatly in terms of how well the three components are specific and clear. At one extreme is the **well-defined problem**, in which the desired end result is clearly stated, all needed information is readily available, and a particular sequence of operations will (if properly executed) lead to a correct solution. At the other extreme is the **ill-defined problem**, in which the goal is ambiguous, some essential information is lacking, and there's no guaranteed means of achieving the goal. Well-defined problems often have only one right solution, whereas ill-defined problems often have several possible solutions that vary in terms of their relative rightness and acceptability. The problem of dividing 3,354 by 43 is well defined, while that of military disarmament is ill defined (e.g., the goal of “cooperation and peaceful coexistence” is ambiguous).<sup>3</sup> As you might guess, ill-defined problems are typically harder to solve and require more complex problem-solving strategies than well-defined problems.

Unfortunately, researchers have focused more on well-defined problems (often somewhat artificial ones) than on the ill-defined problems that life so often presents. You'll probably notice this bias as we proceed with our discussion of problem solving. Nevertheless, most of the theories and principles I'll present in the upcoming pages presumably apply to both kinds of problems. And in fact, later in the chapter we'll find that one strategy for solving ill-defined problems is to define them more specifically and concretely—in other words, to make them well defined.

## Theories of Problem Solving

Behaviorists and cognitivists alike have offered theories of how human beings and other animal species solve problems. Here we'll look briefly at early behaviorist and cognitivist views of problem solving. We'll then draw largely from information processing theory as we explore more contemporary explanations.

### ***Early Behaviorist Views: Trial-and-Error Learning and Response Hierarchies***

In Chapter 4, you read about Thorndike's (1898) classic work with a cat in a puzzle box. In trying to solve the problem—getting out of a confining situation—the cat explored the box, manipulating its various parts and eventually triggering a mechanism that opened the door. The poor cat was returned to the box, where it once again tried various behaviors until it triggered the release mechanism. With successive trials, the cat managed to escape more quickly (and hence was rewarded for the correct response), but its general approach was largely one of trial and error.

A trial-and-error approach is often observed in children's problem-solving behavior. For example, consider the way that many young children assemble jigsaw puzzles: They try to fit different pieces in the same spot, often without considering each piece's shape and coloring, until eventually they find a piece that fits. Such a strategy is workable only if the number of possible solutions is quite small.

In trial-and-error learning, humans and nonhumans alike may discover that they can potentially solve a particular problem in a variety of ways, with some ways having greater success rates—that is, they're reinforced more often—than others. The result is that the stimuli comprising the

---

<sup>3</sup>For a detailed discussion of ill-defined problems in international relations, see Voss, Wolfe, Lawrence, and Engle (1991).



problem might be associated with several responses, with some associations being stronger than others (e.g., G. A. Davis, 1966; Hull, 1938; Shabani, Carr, & Petursdottir, 2009; B. F. Skinner, 1966a). Such a **response hierarchy** can be graphically depicted like this (thicker arrows indicate stronger associations):

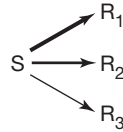

As an example, as my daughter Tina was growing up, she often had the same problem: getting permission to do something her father and I didn't want her to do. Given this problem, she typically tried three different responses, usually in the same order. First she'd smile sweetly and describe how much she wanted to engage in the forbidden activity (such a response, apparently, was associated most strongly with this particular problem situation). If that tactic was unproductive, she'd speak indignantly about how her parents never let her do anything. As a last resort, she'd run off to her room, slamming her door and shouting that her parents hated her. Tina never did learn that some problems would be solved only over her parents' dead bodies.

Although trial-and-error learning and response hierarchies are sometimes helpful in understanding problem-solving behavior, contemporary theorists have largely abandoned behaviorist approaches to focus more on cognitive processes involved in problem solving. Consistent with this trend, we, too, will abandon behaviorism at this point and embrace a more cognitively oriented perspective for the rest of our discussion.

### ***Early Cognitivist Views: Insight and Stages of Problem Solving***

In Chapter 7, I described Gestalt psychologist Wolfgang Köhler's (1925) observations of chimpanzee behavior in problem-solving situations. Köhler observed very little trial-and-error behavior of the form Thorndike had described. Rather, it appeared that the chimpanzees were carefully examining the components of a problem situation—sizing things up, so to speak—and mentally combining and recombining those components until they found a winning combination. At this point of *insight*, the chimps would immediately spring into action, deliberately making a sequence of responses to solve the problem. In Köhler's view, then, problem solving is a process of mentally *restructuring* a problem situation until insight is achieved.

Another early cognitive approach to problem solving was to identify the mental stages—perhaps including insight—through which problem solving might proceed. For example, Wallas (1926) identified four steps in problem solving:

1. *Preparation*: Defining the problem and gathering relevant information
2. *Incubation*: Thinking about the problem at a subconscious level while engaging in other activities
3. *Inspiration*: Having a sudden insight into a problem solution
4. *Verification*: Checking to be certain that the solution is correct

Whereas Wallas suggested that certain aspects of problem solving might be out of the mental limelight, Polya (1957) proposed four steps that rely heavily on conscious, controlled mental activities:

1. *Understanding the problem*: Identifying the problem's knowns (givens) and unknowns and, if appropriate, using suitable notation (e.g., mathematical symbols) to represent the problem

2. *Devising a plan*: Determining appropriate actions to take to solve the problem
3. *Carrying out the plan*: Executing the plan and monitoring its effectiveness
4. *Looking backward*: Evaluating the overall effectiveness of the plan, with the intention of learning something about how to solve similar problems in the future

Unfortunately, Wallas and Polya derived their portrayals of problem solving more from introspection and informal observation than from controlled experimentation, and they were vague about how a learner might accomplish each step (Lester, 1985; Mayer, 1992; Schoenfeld, 1992). For such reasons, these early stage theories of problem solving have been of only limited usefulness in facilitating problem-solving success.

Yet early cognitivist views have clearly had an impact on more recent explanations of problem solving. As we'll soon see, problem solving sometimes involves deliberate and controlled mental processes (similar to those Polya described) and at other times involves less conscious processes (about which Wallas speculated). Furthermore, learners sometimes reconceptualize (restructure) problems with which they're wrestling and, in doing so, can occasionally reach solutions of the sudden-insight variety.

### ***Information Processing Theory***

Most contemporary theorists focus largely on the specific cognitive processes involved in reaching problem solutions. In the following section, we'll examine key ingredients of the information processing view.

## **Cognitive Factors in Problem Solving**

The ability to solve problems successfully depends on several aspects of the human information processing system: working memory capacity, encoding processes, long-term memory retrieval, existing knowledge relevant to the problem, and metacognition. As we examine these factors, we'll identify several differences between problem-solving experts and novices within a particular content domain, discovering reasons why some people solve problems easily and effectively whereas others solve them either with great difficulty or not at all.

### ***Working Memory Capacity***

As you should recall, working memory is the component of memory in which active, conscious thinking occurs. Yet this component can hold and process only a small amount of information at a time. If the information and processes necessary to solve a problem exceed working memory's capacity—or perhaps if irrelevant thoughts consume some of its capacity—the problem can't be solved (e.g., Hambrick & Engle, 2003; Salthouse, 1991; Swanson, Jerman, & Zheng, 2008).

Problem solvers can overcome this working memory limitation in a couple of ways. First, some of the information necessary to solve the problem can be stored externally (e.g., by writing it down on paper) or perhaps even processed externally (e.g., by using a calculator). Second, as I suggested in Chapter 9, some skills involved in problem solving should be learned well enough that they become automatic, thus requiring only minimal working memory capacity.

### ***Encoding of the Problem***

Consider this classic children's riddle:

As I was going to St. Ives,  
I met a man with seven wives.

Every wife had seven sacks.  
 Every sack had seven cats.  
 Every cat had seven kits.  
 Kits, cats, sacks, wives.  
 How many were going to St. Ives?

Many people take this logical approach to the problem: 1 traveler plus 1 man plus 7 wives plus  $7^2$  sacks (49) plus  $7^3$  cats (343) plus  $7^4$  kits (2401) equal a total of 2,802 going to St. Ives. People who solve the problem in this way have encoded it incorrectly. In particular, they've overlooked the first line of the riddle: "As *I* was going to St. Ives." The problem statement doesn't tell us where the polygamist was taking his wives and menagerie—perhaps to St. Ives, perhaps not.

One critical factor in encoding a problem is determining what aspects of the problem are relevant and irrelevant to finding a solution. A second, related factor is *how* aspects of the problem are encoded (K. Lee, Ng, & Ng, 2009; Mayer & Wittrock, 2006; Ormrod, 1979; Whitten & Graesser, 2003). For example, consider these two ways of presenting the same situation:

- There are 5 birds and 3 worms. How many more birds are there than worms?
- There are 5 birds and 3 worms. How many birds won't get a worm?

First graders often struggle with the first problem and yet solve the second one quite easily (Hudson, 1983). The first problem requires students to store *relational* information—how one thing compares to another. Relational information seems to be difficult to encode, even for adults (Mayer & Wittrock, 1996). For example, in one study (Mayer, 1982), college students were asked to remember problems such as this one:

A truck leaves Los Angeles en route to San Francisco at 1 P.M. A second truck leaves San Francisco at 2 P.M. en route to Los Angeles going along the same route. Assume the two cities are 465 miles apart and that the trucks meet at 6 P.M. If the second truck travels at 15 mph faster than the first truck, how fast does each truck go? (Mayer, 1982, p. 202)

The students made three times as many errors in recalling relational aspects of problems (e.g., one truck traveling *15 mph faster* than another) than in recalling basic assertions (e.g., two cities being 465 miles apart).

How people encode a problem—and therefore how they solve it—is partly a function of how they classify the problem to begin with. They're apt to have a variety of **problem schemas**—knowledge about certain types of problems that can be solved in certain ways—that they use in problem classification (G. Cooper & Sweller, 1987; L. S. Fuchs et al., 2004; Mayer & Wittrock, 2006). For example, consider this problem:

Ana went shopping. She spent \$3.50 and then counted her money when she got home. She had \$2.35 left. How much did Ana have when she started out? (Resnick, 1989, p. 165)

If you retrieve and apply an *addition* schema as you read the problem, you'll probably get the correct answer of \$5.85. However, if the word *left* in the problem leads you to classify the problem as one requiring subtraction (because many subtraction problems ask questions such as "How many are *left*?"), you may very well get the incorrect answer of \$1.15 (Resnick, 1989).

Problem classification comes into play when solving social problems as well. Consider this situation:

The students in Alice's ninth-grade social studies class have been working in pairs on an assigned project; their teacher has said that he'll give a prize for the best project that a

pair completes. Alice is now complaining to her younger sister Louisa that her partner, Meg, no longer wants to work with her; Meg thinks Alice is too bossy. Louisa suggests that the best course of action is simply for Alice and Meg to buckle down and finish the project so they can win the prize. Alice, however, is thinking that she should instead talk with Meg and promise that she'll be less bossy. (based on Berg & Calderone, 1994)

Louisa and Alice are classifying the problem in different ways and thus arrive at different solutions. In Louisa's eyes, the problem is one of completing the project. Alice sees the problem quite differently—as one of resolving an interpersonal conflict (Berg & Calderone, 1994).

Experts and novices in a particular content domain tend to classify problems differently (Anzai, 1991; Chi, Glaser, & Farr, 1988; De Corte, Greer, & Verschaffel, 1996). Experts generally classify a problem on the basis of abstract concepts and underlying principles and patterns. They seem to have a well-developed set of problem schemas they use to represent different kinds of problems. In contrast, novices tend to focus on specific, concrete aspects of a problem and so are apt to retrieve information related only to those aspects. As an illustration, Schoenfeld and Herrmann (1982) compared the ways that mathematics professors and students categorized a variety of math problems. Professors classified them based on abstract principles related to problem solution: Problems solved by analogy were grouped together, as were those solved by contradiction, and so on. In contrast, students classified the problems based on more superficial characteristics, such as whether they contained polynomial expressions or included geometric diagrams. After taking a math course, the students repeated the classification task; at this point, they began to classify the problems as their professors had.

Experts may also spend a good deal of time defining ill-defined problems before attempting to solve them (J. B. Mitchell, 1989; Swanson, O'Connor, & Cooney, 1990; Voss, Tyler, & Yengo, 1983; Voss, Wolfe, Lawrence, & Engle, 1991). Consider this problem as an example:

Imagine that the year is 1983 and that you're the Minister of Agriculture in the Soviet Union. Crop productivity has been low for the past several years, and people are beginning to go hungry. What would you do to increase crop production? (based on Voss, Greene, Post, & Penner, 1983; Voss, Tyler, et al., 1983)

Take a few minutes to jot down some of your ideas.

How much time did you spend defining the problem? Chances are, you didn't spend much time at all; you probably went right to work thinking about possible problem solutions. If you were a political scientist specializing in the Soviet Union, however, you might have spent considerable time identifying various aspects of the problem—perhaps considering Soviet political policies, the amount of land available for farming, and so on—before thinking about how you might solve it (J. B. Mitchell, 1989; Voss, Greene, et al., 1983; Voss, Tyler, et al., 1983).

**Mental sets in encoding** People are often predisposed to approach and encode problems in particular ways—a phenomenon known as **mental set**.<sup>4</sup> Here's a problem for which people are often the victims of mental set:

How can you throw a tennis ball so that it goes a short distance, comes to a complete stop, then reverses its direction? You may not bounce the ball against a surface, nor may you attach any other object (such as a string) to it. (based on M. Gardner, 1978)

<sup>4</sup>Gestalt psychologists introduced this idea, using the term *Einstellung*.

I once gave this problem to a masters-level learning theories class, and only a handful of my 35 students could solve it. Most of them worked on the assumption that the ball had to be thrown horizontally (some even said they encoded the problem as a visual image of a pitcher). Once you break this mental set, the answer's quite simple: You throw the ball *up*.

As another example of mental set, consider this problem:

You have a bulletin board firmly affixed to the wall. Your task is to stand a thin candle upright beside the bulletin board about 4 feet above the floor. You don't want the candle touching the bulletin board (a fire hazard) but instead need to place it about a centimeter away. How can you accomplish the task with the materials shown in Figure 15.1? (based on Duncker, 1945)

Develop a solution for the problem before you continue reading.

When I've present this problem as a hands-on activity in graduate classes, students have typically identified three different solutions. One solution is to stab the knitting needle through the candle and into the bulletin board; this action almost invariably splits the candle and gouges the bulletin board. A second solution is to form a horizontal surface with the ruler, propping it against the bulletin board with thumbtacks (perhaps also using the knitting needle) and place the candle on top; however, the precariously placed ruler usually falls to the floor once the candle is added. Only a third solution works: Take the thumbtacks out of their box, attach the box to the bulletin board with tacks, then affix the candle to the top side of the box (with either melted wax or a tack). The solution is obvious once you think about it, but many people encode the box only as a container and fail to consider its other possible functions.

The tendency to think of objects as having only one function, thereby overlooking other possible uses, is a form of mental set known as **functional fixedness** (Birch & Rabinowitz, 1951; Duncker, 1945; N. R. F. Maier & Janzen, 1968). The degree to which individuals experience

**Figure 15.1**

Using some or all of these materials, how can you stand a candle upright beside the bulletin board so that you can safely light it?

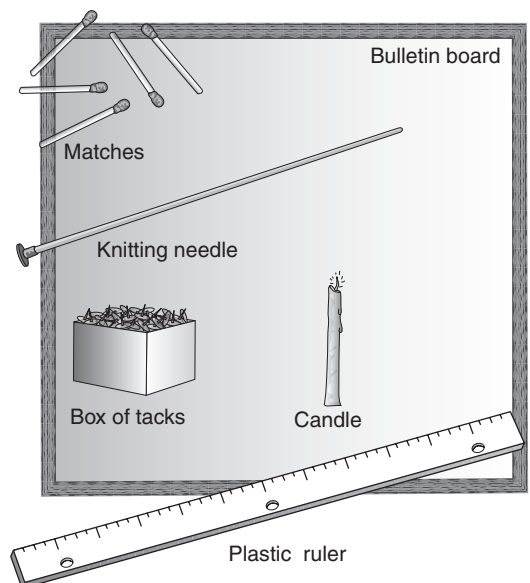

functional fixedness depends, in part, on situational conditions. People more easily solve the candle problem if the tacks are presented *outside* the box, decreasing the likelihood that the box is encoded as a container (Duncker, 1945). The problem is also easier to solve if the box itself is labeled “BOX” (Glucksberg & Weisberg, 1966), possibly because the label draws attention to the box as something that can be used in solving the problem.

Mental set and functional fixedness are partly the result of past experience: If a particular approach to a problem has worked in the past, a person is likely to continue using it and perhaps learn it to a level of automaticity. The person is then likely to apply this approach—often in a relatively “mindless” fashion—even in situations where it’s inappropriate or unnecessarily cumbersome. (Recall our discussion of automaticity’s downsides in Chapter 9.)

Luchins’s classic experiments with water jar problems (1942; Luchins & Luchins, 1950) illustrate just how strongly past experiences can influence problem solving. Imagine, if you will, that you have three jars of three different sizes:

- Jar A holds 20 ounces of water.
- Jar B holds 59 ounces of water.
- Jar C holds 4 ounces of water.

You need exactly 31 ounces of water. Given an unlimited water supply, how could you get the exact amount of water using only the three jars? Try to find a solution before you read further.

The solution to the water jar problem is as follows:

1. Fill jar B. This gives you 59 ounces.
2. Pour water from jar B into jar A until A is full. This leaves 39 ounces in jar B.
3. Pour water from jar B into jar C until C is full. This leaves 35 ounces in jar B.
4. Pour the water out of jar C and once again fill it with water from B. At this point you have 31 ounces in jar B, the exact amount you need.

Mathematically speaking, the solution to the problem is  $B - A - 2C$ .

Luchins (1942) gave people a series of such problems, with the answer always being the same:  $B - A - 2C$ . He then presented the following three problems:

Jar A holds:	Jar B holds:	Jar C holds:	Obtain this amount:
23	49	3	20
15	39	3	18
28	76	3	25

Almost everyone solved the first two problems using the same formula as before:  $B - A - 2C$ . They had trouble solving the third problem because the standard formula didn’t apply. But notice that all three can be solved quite easily: The solution for the first and third problems is  $A - C$ , and that for the second problem is  $A + C$ . The participants in Luchins’s study (who were professors and graduate students—hardly mental slouches!) were victims of a mental set established through prior experience.

In many situations a predisposition to approach similar problems in similar ways facilitates successful problem solving. A mental set influences the way in which a problem is encoded in memory, however, and this encoding in turn influences the parts of long-term memory that are searched for potentially relevant information and procedures. If a problem’s encoding steers an

individual in the wrong “direction” in long-term memory, it’s apt to hinder problem-solving performance (Bilalic, McLeod, & Gobet, 2010; N. R. F. Maier, 1945; Mayer, 1992; Stein, 1989).

### ***Retrieval from Long-Term Memory***

To use previously acquired knowledge to solve a problem, people must retrieve it while they’re thinking about the problem. Thus, the factors that facilitate long-term memory retrieval—meaningful learning, organization and integration of new ideas, and so on—facilitate problem-solving success as well.

When people search long-term memory for knowledge relevant to a problem, they begin by looking in logical “places.” They tend to retrieve familiar ideas first, identifying original or unusual problem solutions—for instance, those that require thinking “outside the box”—only later on, if at all (Bourne, Dominowski, Loftus, & Healy, 1986; Storm & Angello, 2010). People also tend to retrieve information closely associated with aspects of the problem situation; for example, they can more easily solve the candle problem if they’ve previously learned a paired-associates list that includes the pair *candle–box* (Bassok, 2003; Weisberg, DiCamillo, & Phillips, 1979). Hints that provide important retrieval cues can be helpful as well, provided that people perceive their relevance (Bassok & Holyoak, 1993; Gick & Holyoak, 1987).

As I mentioned in Chapter 11, anxiety can interfere with retrieval by restricting the part of long-term memory being searched. Thus, anxious individuals are apt to have trouble solving problems whose solutions aren’t readily apparent (Glucksberg, 1962; B. Hoffman, 2010). For example, in one early study (Glucksberg, 1962), college students were asked to solve a candle problem similar to that presented in Figure 15.1. Some students were given the tacks outside of their box (an easy version of the problem), whereas others were given the tacks inside the box (a more difficult version). Furthermore, for each version of the problem, some students were told that they could earn up to \$25 for solving the problem quickly—a tidy sum back in 1962, and one that would significantly increase students’ stress levels as they worked on the problem. Following are the average reaction times (in minutes) for the four groups of problem solvers; larger numbers indicate greater difficulty in solving the problem:

	<b>Easy Version</b>	<b>Difficult Version</b>
<i>Low anxiety</i>	4.99	7.41
<i>High anxiety</i>	3.67	11.08

When the box was empty, its use as a platform for the candle was obvious, and anxiety facilitated problem solving. But when the box was already being used as a container, anxiety made the problem even more difficult to solve than it already was.

The effects of anxiety on problem solving seem to be reduced or eliminated when people know where to search in long-term memory. Although high-anxiety individuals typically perform more poorly than low-anxiety individuals on problem-solving tasks, performance of the two groups is similar when memory aids are provided to encourage appropriate retrieval (Gross & Mastenbrook, 1980; Leherissey, O’Neil, & Hansen, 1971).

***The value of incubation in long-term memory retrieval*** In Wallas’s early four-step theory of problem solving (1926), one key step is **incubation**: letting the problem “percolate” for a while—perhaps at an unconscious level—while engaging in other activities. Many contemporary cognitive theorists have also vouched for the importance of incubation, especially in dealing with

difficult problems. For one thing, some of the factors that interfere with problem solving (e.g., fatigue, anxiety, counterproductive mental sets) may dissipate during the incubation period. And in the intervening time period, a person can search long-term memory more broadly—perhaps simply by “wandering aimlessly” through various areas (not necessarily with any conscious purpose or intent) and unexpectedly “stumbling” on potentially helpful information. When encountering the new information, the person may see its relevance for the previously unsolved problem, encode the problem in a new way (i.e., restructure it), and so tackle it differently. In some cases, the recoding may yield an almost instantaneous solution, resulting in that sudden *insight* phenomenon of which I spoke earlier (I. K. Ash & Wiley, 2006; Davidson & Sternberg, 2003; Dijksterhuis & Nordgren, 2006; Kounios & Beeman, 2009; Strick, Dijksterhuis, & van Baaren, 2010; Zhong, Dijksterhuis, & Galinsky, 2008).

In my own experience as a textbook writer, I’ve found incubation to be a highly effective strategy. Probably the biggest problem I face when I write is figuring out how best to organize the ever-expanding body of research findings related to learning and motivation. As my field continues to grow and evolve, I find that some organizational structures I’ve used in previous editions of this book are no longer useful in a later edition, and so I begin to experiment with alternative arrangements. Yet my mind seems to be able to handle only so much mini-paradigm-shifting in any single day. Oftentimes the best thing I can do is to turn off my computer in midafternoon, take a walk, perhaps watch a television game show or two, and essentially let the “mental dust” settle. When I return to my computer the following morning, I often have fresh ideas that hadn’t occurred to me the day before.

### ***Knowledge Base***

On average, successful (expert) problem solvers have a more complete and better organized knowledge base for the problems they solve. They also appear to have more knowledge of specific problem-solving strategies within their area of expertise. For instance, once they’ve categorized a problem as falling into a particular category or being consistent with a certain problem schema, they readily apply certain procedures to solve it, and they’ve often learned basic problem-solving procedures to automaticity. Lacking the rich knowledge base that experts have, novice problem solvers are more likely to engage in ineffective problem-solving strategies—for example, resorting to trial and error, persevering with unproductive procedures, making unwarranted assumptions, and applying procedures and equations in a rote, meaningless manner (Anzai, 1991; Bédard & Chi, 1992; Carr, 2010; Chi et al., 1988; Lawson & Chinnappan, 1994; Perkins & Simmons, 1988; S. K. Reed, 1993).

### ***Metacognition***

Metacognition often plays key roles in problem solving. In particular, successful problem solvers must

- Believe that they’re capable of solving the problem successfully
- Realize that some problems may take considerable time and effort to accomplish
- Plan a general course of action
- Flexibly consider potentially relevant problem-solving strategies and choose appropriate ones
- Monitor progress toward a solution, and change strategies if necessary (Carr, 2010; Davidson & Sternberg, 1998; Delclos & Harrington, 1991; Dominowski, 1998;



B. Hoffman & Spatariu, 2008; Kirsh, 2009; Lesgold & Lajoie, 1991; Mayer & Wittrock, 2006; Schoenfeld, 1992; Zimmerman & Campillo, 2003)

As an illustration of how such factors might come into play, consider this train of thought regarding a particular problem:

I'm sloppy at doing [a particular kind of problem]; I'd better go slow. This is complicated. I should go through the steps carefully. This method isn't working. I'll try something else. I need to vocalize what I'm doing to help me keep on track. I need to write these steps out. (Lester, 1985, p. 63)

This individual, while obviously not an expert at solving the problem in question, is bringing several beneficial metacognitive skills to bear on the problem—for example, acknowledging the need to go slowly and carefully, recognizing when a strategy is unproductive, and identifying specific behaviors that might facilitate problem-solving success.

Unfortunately, students sometimes have epistemic beliefs that interfere with effective problem solving. In the case of mathematics, for instance, many students believe that (1) successful problem solving is largely a matter of luck, (2) a problem can have only one right answer, (3) there's only one way to solve any particular problem, and (4) a problem is either solvable within a few minutes' time or else not solvable at all (De Corte et al., 1996; Geary, 1994; Schoenfeld, 1992). And when students have naive beliefs about the nature of a subject area or about knowledge more generally—perhaps thinking that virtually any issue has only a single right solution—they're likely to have particular difficulty addressing ill-defined problems (P. M. King & Kitchener, 2004; Schraw, Dunkle, & Bendixen, 1995).

## Problem-Solving Strategies

At several points I've alluded to the need for appropriate problem-solving strategies. Such strategies fall into two general categories: algorithms and heuristics.

### *Algorithms*

As mentioned earlier, well-defined problems can usually be solved using a particular sequence of operations. For example, you can solve the problem  $43\overline{)3,354}$  using either of two procedures: (1) apply prescribed methods of long division or (2) push the appropriate sequence of buttons on a calculator. Either approach leads to the correct answer: 78. Similarly, you can make a tasty pumpkin pie if you follow a recipe to the letter in terms of ingredients, measurements, and oven temperature. Such specific, step-by-step procedures for solving problems are called **algorithms**. Algorithms are typically domain specific: They're useful with particular problems in a particular content area but are rarely applicable elsewhere.

Young children might use any of several algorithms when given an arithmetic problem such as this one:

If I have 2 apples and you give me 4 more apples, how many apples do I have altogether?

Children can often solve such problems even if they haven't yet had formal instruction in addition (T. P. Carpenter & Moser, 1984). An early strategy is simply to put up two fingers and then four additional fingers and count all the fingers to reach the solution of "6 apples." Somewhat later, children may begin to use a *min* strategy, in which they start with the larger number (for the apple problem, they would start with 4) and then add on, one by one, the smaller number (e.g., counting

“four apples . . . then five, six . . . six apples altogether”) (Siegler & Jenkins, 1989). Still later, of course, children learn the basic addition facts (e.g., “ $2 + 4 = 6$ ”) that enable them to answer simple addition problems without having to count at all. As new strategies emerge, children may initially have trouble using them effectively and thus may often resort to the earlier, less efficient, but more dependable ones. Eventually, they acquire sufficient proficiency with their new strategies that they can comfortably leave the less efficient ones behind (Siegler & Alibali, 2005).

Sometimes, when a single algorithm is insufficient to solve a problem, several algorithms in combination can lead to a correct solution. But combining algorithms isn't necessarily as easy as it sounds (e.g., Mayer & Wittrock, 1996). In some cases, individuals may have to learn, through either formal classroom instruction or informal experiences, the process of combining algorithms. For example, in one study (Scandura, 1974), elementary school children were taught trading rules such as these:

$$\begin{aligned} n \text{ caramels} &= n + 1 \text{ toy soldiers} \\ n \text{ toy soldiers} &= n + 2 \text{ pencils} \end{aligned}$$

The children were then asked to make trades that involved combining two of the rules (e.g., trading caramels for pencils). Children who couldn't successfully combine the rules were identified, and half of them were given specific instruction on rule combination. Subsequently, all of these instructed children effectively combined the trading rules (one of them first required additional instruction), whereas none of the children in an untrained control group were able to do so.

### ***Heuristics***

Not all problems can be solved with algorithms. For instance, no surefire algorithms exist for eliminating a junk food addiction or establishing world peace. And in other situations, algorithms may be too time consuming to be practical. For example, here's an effective but impractical algorithm for determining the best move in a game of checkers: Consider every possible move, then consider every possible next move that the opponent could make in response to each of those moves, then consider every follow-up move that could be made in response to each of *those* moves, and so on until the winner is projected for every conceivable series of moves (Samuel, 1963). Such an algorithm would take either an experienced computer programmer or a lifetime of dedication to a single game of checkers.

When algorithms for a particular problem are either nonexistent or impractical, people tend to use **heuristics**—general problem-solving strategies that may or may not yield a correct solution. Following are examples.

***Talking to oneself about the problem*** In Chapter 9, I described the value of *self-explanation* for enhancing long-term memory storage. Self-explanation is often helpful in problem solving as well. Talking to oneself about a problem and the steps being taken to solve it often enhances one's ability to identify valid approaches and monitor progress to a solution, *provided that* the self-explanations are appropriate ones (Berardi-Coletta, Buyer, Dominowski, & Rellinger, 1995; Berthold & Renkl, 2009; Carr, 2010; Crowley & Siegler, 1999; see S. M. Lane & Schooler, 2004, for an exception).

***Brainstorming*** In brainstorming, one initially tries to generate a large number of possible approaches to a problem without regard for how realistic or practical they might be. Only after many possibilities have been generated—perhaps including some seemingly bizarre, outlandish

ones—are they evaluated for potential usefulness and effectiveness. This postponement of evaluation increases the odds that people will conduct a broad search of long-term memory and, perhaps, stumble on an unusual or creative solution (Halpern, 1997; Osborn, 1963; Runco & Chand, 1995).

**Means–ends analysis** In means–ends analysis, one breaks a problem into two or more sub-problems and then works successively on each of them (Z. Chen, Sanchez, & Campbell, 1997; Newell & Simon, 1972; Sweller & Levine, 1982). For example, imagine that an infant sees an attractive toy beyond her reach. A string is attached to the toy; its other end is attached to a cloth closer at hand. Between the cloth and the infant is a foam rubber barrier. Many 12-month-old infants can put two and two together and realize that to accomplish the goal (getting the toy), they must first do several other things. Accordingly, they remove the barrier, pull the cloth toward them, grab the string, and reel in the toy (Willatts, 1990).

**Working backward** In some cases it's helpful to begin at the problem goal and then work in reverse, one step at a time, toward the initial problem state (Chi & Glaser, 1985; Newell, Shaw, & Simon, 1958; Wickelgren, 1974). Working backward is often applicable to solving algebra and geometry proofs. Students are given an initial situation—a formula or geometric configuration with certain characteristics—and asked to prove, through a series of mathematically logical steps, how another formula or another characteristic (the goal) must also be true. Sometimes it's easier—and it's just as mathematically valid—to move logically from the goal backward to the initial state.

**Using visual imagery** In Chapter 8, we noted that working memory may include a *visuospatial sketchpad* that allows short-term storage and manipulation of visual material. And in Chapters 9 and 10, we discovered that visual imagery provides a potentially powerful means of storing information in long-term memory. So when problems are easily visualizable or have an obvious spatial structure, people sometimes use visual imagery to solve them (L. D. English, 1997; Geary, 2006; Hegarty & Kozhevnikov, 1999; Kosslyn, 1985; Ormrod, 1979).

**Drawing an analogy** See if you can solve the following problem:

Suppose you are a doctor faced with a patient who has a malignant tumor in his stomach. It is impossible to operate on the patient, but unless the tumor is destroyed the patient will die. There is a kind of ray that can be used to destroy the tumor. If the rays reach the tumor all at once at a sufficiently high intensity, the tumor will be destroyed. Unfortunately, at this intensity the healthy tissue that the rays pass through on the way to the tumor will also be destroyed. At lower intensities the rays are harmless to healthy tissue, but they will not affect the tumor either. What type of procedure might be used to destroy the tumor with the rays, and at the same time avoid destroying the healthy tissue? (Gick & Holyoak, 1980, pp. 307–308)

If you're having trouble solving the problem, consider this situation:

A general wishes to capture a fortress located in the center of a country. There are many roads radiating outward from the fortress. All have been mined so that, while small groups of men can pass over the roads safely, any large force will detonate the mines. A full-scale direct attack is therefore impossible. The general's solution is to divide his army into small groups, send each group to the head of a different road, and have the groups converge simultaneously on the fortress. (Gick & Holyoak, 1980, p. 309)

Now go back to the tumor problem. Perhaps the general's strategy in capturing the fortress has given you an idea about how to destroy the tumor: You can shoot a number of low-intensity rays

from different directions, such that they all converge on the tumor simultaneously. College students are more likely to solve the tumor problem when they've first read the solution to the fortress problem, because the two problems can be solved in analogous ways (Gick & Holyoak, 1980).

Drawing an analogy between a current problem and another, previously solved problem can sometimes provide insights into how the current problem might be addressed (A. L. Brown, Kane & Echols, 1986; L. D. English, 1997; Mayer & Wittrock, 1996; Schultz & Lochhead, 1991). For example, a student might solve a math problem by studying a similar, worked-out problem—one that's been correctly solved using a particular procedure (R. K. Atkinson, Derry, Renkl, & Wortham, 2000; Mwangi & Sweller, 1998; Reimann & Schult, 1996). As another example, consider a problem that the Greek scientist Archimedes confronted sometime around 250 B.C.:

King Hiero asked a goldsmith to make him a gold crown and gave the craftsman the gold he should use. When he received the finished crown, he suspected that the goldsmith had cheated him by replacing some of the gold with silver, a cheaper metal. The only way to determine the goldsmith's honesty was to compare the crown's weight against its volume. Any metal has a particular volume for any given weight, and that ratio is different for each metal. The crown could be weighed easily enough. But how could its volume be measured?

Archimedes was pondering the problem one day as he stepped into a bathtub. He watched the bathwater rise and, through analogy (and perhaps visual imagery as well), immediately identified a solution to the king's problem: The crown's volume could be determined by placing it in a container of water and measuring the amount of water that was displaced.

Using an analogy doesn't guarantee a correct solution, however: Problem solvers may make an incorrect analogy or draw inappropriate parallels (Bassok, 2003; Mayer & Wittrock, 1996;

Analogies are sometimes helpful in solving problems.

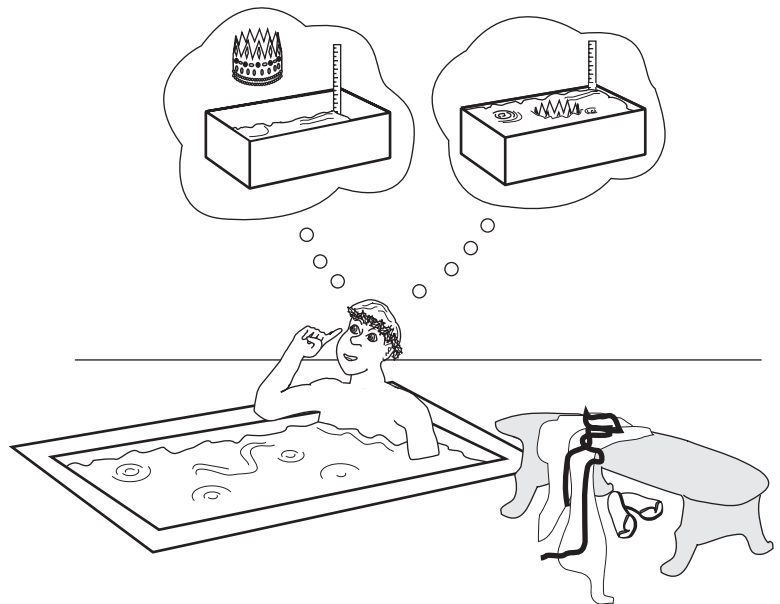

Novick, 1988). A more significant stumbling block is that without an expert's guidance, the chances of retrieving and recognizing a helpful analogy are typically quite slim. People of all ages rarely use analogies to tackle a problem unless its analogue has similar superficial features that make its relevance obvious (Bassok, 2003; Gick & Holyoak, 1980; Holyoak & Koh, 1987; Mayer & Wittrock, 1996).

**Using external representations of problem components** The limited capacity of working memory inevitably puts a limit on how much people can do in their heads while trying to solve a problem. People can augment that capacity by storing some aspects of a problem externally—for example, drawing a diagram, listing the problem's components, or jotting down potentially viable solutions. An external representation of a problem can also help people encode the problem more concretely and see interrelationships among its various elements more clearly (Anzai, 1991; Fuson & Willis, 1989; Kirsh, 2009; Prawat, 1989; Schultz & Lochhead, 1991).

Because many problems have no right or wrong solutions, there may be no single best strategy for solving them. And in any case, different strategies are appropriate in different situations. But sometimes people use strategies at the wrong times, often because they've learned such strategies at a rote, meaningless level, as we'll see now.

## Meaningless versus Meaningful Problem Solving

See if you can solve this problem before you read further:

The number of quarters a man has is seven times the number of dimes he has. The value of the dimes exceeds the value of the quarters by two dollars and fifty cents. How many has he of each coin? (Paige & Simon, 1966, p. 79)

If you found an answer to the problem—any answer at all—then you overlooked an important point: Quarters are worth more than dimes. If there are more quarters than dimes, the value of the dimes can't possibly be greater than the value of the quarters. The problem makes no sense and thus can't be solved. (If you tried using algebra to solve this problem—as I first did—you may have been puzzled to find that your answer involved *negative* quantities of both dimes and quarters.)

When people learn algorithms in a rote manner, without understanding their underlying logic, they may sometimes apply the algorithms unthinkingly and inappropriately (Carr, 2010; De Corte et al., 1996; Prawat, 1989; Walkington, Sherman, & Petrosino, 2010). As a result, they may obtain illogical or physically impossible results. Consider the following instances of meaningless mathematical problem solving as examples:

- A student is asked to figure out how many chickens and how many pigs a farmer has if the farmer has 21 animals with 60 legs in all. The student adds 21 and 60, reasoning that, because the problem says “how many in all,” addition is the logical operation (Lester, 1985).
- A student uses subtraction whenever a word problem contains the word *left*—even when a problem actually requiring addition includes the phrase “John left the room to get more apples” (Schoenfeld, 1982).

- Middle school students are asked to calculate how many 40-person buses are needed to transport 540 people to a baseball game. The majority give an answer that includes a fraction, without acknowledging that in the case of buses, only whole numbers are possible (Silver, Shapiro, & Deutsch, 1993).

All too often, when schools teach problem solving, they focus on teaching algorithms for well-defined problems but neglect to help students understand why the algorithms work and how they can be used in real-world situations (Carr & Biddlecomb, 1998; Cooney, 1991; A. Porter, 1989; Silver et al., 1993; Walkington et al., 2010). For example, perhaps you can recall learning how to solve a long-division problem, but you probably don't remember learning why you multiply the divisor by each digit in your answer and write the product in a particular location below the dividend. Or perhaps you were taught a "key word" method for solving word problems: Words such as *altogether* indicate addition, and words such as *left* mean subtraction. This approach is a meaningless one indeed and often leads to erroneous solutions.

## FACILITATING TRANSFER AND PROBLEM SOLVING IN THE CLASSROOM

---

As noted early in the chapter, students often don't apply what they've learned in school to subsequent academic tasks or to out-of-school problems. Thus, a major objective of formal instruction—positive transfer—isn't being achieved as well as it might. At the same time, students sometimes erroneously apply what they've learned to situations in which it isn't appropriate—a case of negative transfer.

Learning theorists still have much to learn about the complex processes of transfer and problem solving. Nevertheless, theories and research in both areas provide numerous suggestions for educational practice:

- ◆ *Students should learn information meaningfully and thoroughly.* In most instances, a prerequisite for successful transfer and problem solving is a solid understanding of the topic in question. Ideally, much of this understanding is the *conceptual knowledge* of which I spoke in Chapter 10: Concepts and ideas comprise an integrated whole that includes cause-and-effect relationships and other meaningful interconnections. School curricula that entail long lists of topics that can each be taught only superficially simply won't cut it (Brophy & Alleman, 1992; N. Frederiksen, 1984a; Haskell, 2001; Hecht & Vagi, 2010; M. C. Linn, 2008; Perkins, 1995).

- ◆ *Students should also learn problem-solving strategies in a meaningful manner.* All too often, students learn problem-solving algorithms as procedures separate from anything they've previously learned about the world. For example, they may learn mathematics—its symbols, principles, and procedures—in total isolation from the concrete physical world they regularly deal with. When students learn an algorithm in a rote, meaningless fashion, they're likely to use it mechanically, thoughtlessly, and often incorrectly, and they're *unlikely* to recognize many of the situations in which it might legitimately be applied (Carr, 2010; Greeno, 1991; Hiebert & Wearne, 1993; Resnick, 1989).

Rather than simply learning algorithms at a rote level, students should understand *why* they do the things they do in order to solve problems. In other words, they should connect abstract, symbol-based procedures to things they already know about the subject matter and to concrete

reality. Following are examples of how teachers might help students meaningfully learn and apply various problem-solving strategies:

- Teach general schemas for classifying different kinds of problems, and give students practice in using the schemas in a wide variety of contexts (L. S. Fuchs et al., 2003b, 2004; Gerjets & Scheiter, 2003).
- While demonstrating a particular strategy, ask students to explain why the strategy is a good one (Calin-Jageman & Ratner, 2005; Renkl & Atkinson, 2003; Rittle-Johnson, 2006).
- When teaching complex mathematical formulas and procedures, present them using words, symbols, and examples that help students connect them to things with which they're already familiar (R. K. Atkinson, Catrambone, & Merrill, 2003; J. R. Stone, Alfeld, & Pearson, 2008).
- Help students master and compare multiple approaches to solving any single problem (Rittle-Johnson & Star, 2009).

♦ *Discovery activities and expository instruction both play important roles in learning problem-solving skills.* Young children typically engage in a great deal of trial and error in their early play activities. Through such activities, they may discover the properties of a wide variety of objects, and these discoveries increase the likelihood that they will, at a later time, use the objects to solve problems (Christie & Johnsen, 1983; Pellegrini, 2009; P. K. Smith & Dutton, 1979).

Once children begin to encounter problems related to academic subject matter, occasional opportunities to discover problem-solving strategies on their own can be valuable as well. In particular, instructional approaches that emphasize *guided* discovery sometimes facilitate transfer of problem-solving skills to new situations (Hiebert et al., 1997; Mayer & Wittrock, 2006; McDaniel & Schlager, 1990; Shymansky, Hedges, & Woodworth, 1990). Discovery learning is probably most useful when (1) students have good self-regulation skills and a solid knowledge base on which to build and (2) teachers help them interpret their discoveries and monitor their understandings (Doyle, 1983; N. Frederiksen, 1984a; D. L. Schwartz & Martin, 2004).

Yet even with teacher guidance, students don't always acquire appropriate problem-solving strategies on their own. For well-structured problems that can be solved by a specific algorithm—especially problems that might initially exceed students' working memory capacity—and for students who are relatively unsophisticated about a particular topic, explicit instruction of the algorithm is often more effective (N. Frederiksen, 1984a; P. A. Kirschner, Sweller, & Clark, 2006; Rittle-Johnson, 2006).

♦ *Students should have a mental set for transfer.* As we've seen, mental sets in problem solving—predispositions to solve problems in particular ways—sometimes interfere with successful problem solving. Yet a *general* mental set to transfer school learning—a predisposition to use and apply the things learned in the classroom—is clearly beneficial. Teachers can promote such a mental set by creating a **culture of transfer**—a learning environment in which applying school subject matter to new situations, cross-disciplinary contexts, and real-world problems is both the expectation and the norm (R. A. Engle, 2006; Haskell, 2001; Pea, 1987). For example, teachers should frequently point out how academic content can be applied to a variety of situations both in and out of school. And they can encourage students to be continually thinking “How might I use this information?” as they listen, read, and study (B. D. Cox, 1997; M. C. Linn, 2008; Perkins, 1992; Stein, 1989; R. J. Sternberg & Frensch, 1993).

◆ *Some prerequisite skills should be practiced until they're learned to the level of automaticity.* Remember that problem solving occurs in working memory, which has only a limited capacity for holding and processing information at any single time. To the extent that students can process the simple and familiar aspects of a problem automatically, they can devote more “space” to the problem's difficult and novel aspects (Geary, 1994; Gerjets & Scheiter, 2003; Mayer & Wittrock, 2006; Perkins & Salomon, 1987).

◆ *Practice doesn't necessarily make perfect, but it does increase the odds of successful transfer and problem solving.* Numerous and diverse examples and practice opportunities promote associations in long-term memory between new information and a variety of relevant situations; hence, the information is more likely to be retrieved when it's needed later on. Furthermore, to the extent that students must use a concept or procedure in a slightly different way each time they apply it, they're more likely to develop a general (perhaps abstract) understanding of it—one that doesn't depend on obvious surface features of the situation—and they're less likely to develop mental sets that limit their flexibility in applying it (Bransford & Schwartz, 1999; Carr & Biddlecomb, 1998; Z. Chen, 1999). As an example, try to solve each of the following problems:

- Mary needs to locate her wood stove 6 inches from the wall. She does not have a ruler with her. However, she has three sticks that measure 15, 7, and 2 inches, respectively. Using these, how can she get the right distance (6 inches)?
- John needs exactly 20 cups of fertilizer to spray his backyard. He has a bucket of fertilizer but only three jars that hold 9, 8, and 3 cups, respectively. How can he get 20 cups of fertilizer?
- One day Chef Smith needed to get 7 ounces of flour for his cooking but had only a balance scale and three weights of 9, 5, and 3 ounces available to him. How did he get exactly 7 ounces of flour? (all three problems from Z. Chen, 1999, p. 715)

As you may have realized, all three problems can be solved using the same general strategy that Luchins's water jar problems require, in particular using three known amounts that, when added or subtracted, can yield a needed fourth amount. But notice how each problem has different surface features, including different forms of measurement (length, volume, weight) and different contexts and goals (positioning a stove, measuring fertilizer for gardening, weighing flour for cooking). Furthermore, each problem requires a different solution ( $A - B - C$ ,  $A + B + C$ ,  $A - B + C$ ). Learning a problem-solving strategy with such varied problems is apt to take longer than learning it with very similar problems (e.g., with a series of water jar problems), but learners will then apply the strategy more broadly and flexibly (Z. Chen, 1999).

Occasionally, teachers should present problems in a somewhat mixed-up order (rather than having students solve a set of problems that all require the same procedure), so that students have practice classifying problems before solving them (Geary, 1994; Mayfield & Chase, 2002; Rohrer & Pashler, 2010). Ideally, too, students should have opportunities to apply newly learned strategies to real-life problems as well as more traditional word problems (De Corte et al., 1996; Lave, 1988, 1993; M. C. Linn, 2008).

◆ *Students should have experience identifying problems for themselves.* Teachers usually provide the problems they want their students to solve. But beyond the classroom—for instance, at home and in the adult working world—people must often identify and define for themselves the problems that stand in their way. Some theorists suggest that students may benefit from getting a head start on such **problem finding** in the classroom (S. I. Brown & Walter, 1990; Eisner, 1994;



Hiebert et al., 1996; A. Porter, 1989; Resnick, Bill, Lesgold, & Leer, 1991). For example, in a math lesson, students might be given data describing the quantities and prices of grocery store items and asked to generate a number of questions that could be answered by those data. Or, in a history lesson, students might be given a scenario of an American Civil War battle in progress, instructed to identify the problems facing either the North or the South, and asked to propose possible solutions.

♦ *To minimize negative transfer, differences between two ideas should be emphasized.* Insects and spiders are similar stimuli—they're both small arthropods with exoskeletons and a generally creepy-crawly nature—and so students may inappropriately transfer what they know about one group of creepy-crawlies to the other. For similar stimuli, negative transfer can be reduced if differences rather than similarities are emphasized (R. J. Sternberg & Frensch, 1993). For instance, insects and spiders are different in a number of ways (e.g., six legs vs. eight legs, three body parts vs. two, antennae vs. no antennae), and if emphasized, these differences could reduce negative transfer from one concept to the other. Additionally, if negative transfer between two ideas is anticipated, it can be reduced by teaching each in a different environment (Bilodeau & Schlosberg, 1951; Greenspoon & Ranyard, 1957)—for example, by teaching students about insects while sitting in the classroom and teaching them about spiders while on a field trip to the natural history museum.

♦ *Instruction in general problem-solving skills (both cognitive and metacognitive) can be helpful.* As I indicated in Chapter 14, training in study skills can be effective and appears to improve classroom learning and achievement. Similarly, teaching general problem-solving strategies can enhance students' ability to solve problems successfully. Yet it's important to note that, just as study strategies are often better learned when taught within the context of specific academic content areas, so, too, may general problem-solving strategies be more effectively learned when connected with content domains to which they're applicable (Kramarski & Mevarech, 2003; Mayer & Wittrock, 2006; Resnick, 1987; Schoenfeld, 1979, 1992; Schoenfeld & Herrmann, 1982; H. A. Simon, 1980).

Many of the problem-solving heuristics we examined earlier—talking to oneself about a problem, brainstorming, incubation, drawing diagrams, and so on—are apt to be transferable to a wide variety of problem situations. And specific instruction in metacognitive and self-regulating problem-solving strategies—identifying one's final goal, monitoring one's progress toward the goal, and so on—can enhance problem-solving effectiveness in children and adults alike (Cardelle-Elawar, 1992; Carr, 2010; Desoete, Roeyers, & De Clercq, 2003; L. S. Fuchs et al., 2003a; B. Hoffman & Spataru, 2008).

♦ *Students should learn strategies for defining ill-defined problems.* Most problems presented in classroom situations are well defined (N. Frederiksen, 1984a; R. J. Sternberg et al., 2000). Students are asked to identify the protagonist and antagonist in a story, use a dictionary to find two different pronunciations of the printed word *wind*, or calculate how many pieces of candy six boys can each have if there are 18 pieces altogether. In contrast, most real-world problems are ill defined. People need to find viable means of home financing, decide what life insurance policy to purchase (if any), and maintain friendly and productive relationships with obnoxious co-workers.

Ill-defined problems often require an individual to search outside sources to find relevant and potentially helpful information. Thus students should be well versed in techniques for finding information through such resources as libraries, computer databases, and the Internet. They should also learn techniques for more precisely defining ill-defined problems; for example, one

helpful technique is to break a larger problem into a number of subproblems (recall the means-ends analysis described earlier) and to define and impose constraints on each one (Chi & Glaser, 1985; W. R. Reitman, 1964; H. A. Simon, 1973). Finally, to the extent that students possess a solid knowledge base related to the topic involved, they'll be better able to define the problems they encounter (Bédard & Chi, 1992; N. Frederiksen, 1984a).

♦ *Students' early attempts to solve difficult problems should be scaffolded.* In Chapter 14, we noted the importance of scaffolding students' early attempts to use sophisticated metacognitive strategies. Appropriate scaffolding can facilitate problem-solving performance as well (R. K. Atkinson, Renkl, & Merrill, 2003; Kirsh, 2009; Mayer & Wittrock, 2006; N. E. Perry & Winne, 2004; Rittle-Johnson & Koedinger, 2005). Teachers can do a variety of things to help students in initial attempts at challenging problems: They can simplify early problems, provide tools that ease the strain on working memory (e.g., calculators), model problem solutions (e.g., by showing worked-out examples), ask probing questions that steer thinking in productive directions, point out errors along the way, and in general keep students' frustration at a reasonable level. They can also give students questions to ask themselves as they proceed through a problem; here are some examples:

What (exactly) are you doing? Can you describe it precisely? Why are you doing it? How does it fit into your solution? (Schoenfeld, 1992, p. 356)

As students become more adept at solving problems on their own, such scaffolding can be gradually phased out.

♦ *The development of effective problem-solving strategies can be facilitated through cooperative group problem solving.* Numerous theorists have suggested that group discussions and collaborative learning activities can often help students acquire the knowledge and strategies required for effective problem solving. As an example, let's look in on Ms. Lombard's fourth-grade class, which has been studying fractions. Ms. Lombard has never taught her students how to divide a number by a fraction. Nevertheless, she gives them the following problem, which can be solved by dividing 20 by  $\frac{3}{4}$ :

Mom makes small apple tarts, using three-quarters of an apple for each small tart. She has 20 apples. How many small apple tarts can she make? (Hiebert et al., 1997, p. 118)

Ms. Lombard asks the students to work in small groups to figure out how they might solve the problem. One group of four girls—Jeanette, Liz, Kerri, and Nina—has been working on the problem for some time and so far has arrived at such answers as 15, 38, and 23. We join the girls midway through their discussion, when they've already agreed that they can use three-fourths of each apple to make a total of 20 tarts:

Jeanette: In each apple there is a quarter left. In each apple there is a quarter left, so you've used, you've made twenty tarts already and you've got a quarter of twenty see—  
 Liz: So you've got twenty quarters left.  
 Jeanette: Yes, . . . and twenty quarters is equal to five apples, . . . so five apples divided by—  
 Liz: Six, seven, eight.  
 Jeanette: But three-quarters equals three.  
 Kerri: But she can't make only three apple tarts!  
 Jeanette: No, you've still got twenty.

- Liz: But you've got twenty quarters, if you've got twenty quarters you might be right.
- Jeanette: I'll show you.
- Liz: No, I've drawn them all here.
- Kerri: How many quarters have you got? Twenty?
- Liz: Yes, one quarter makes five apples and out of five apples she can make five tarts which will make that twenty-five tarts and then she will have, wait, one, two, three, four, five quarters, she'll have one, two, three, four, five quarters. . . .
- Nina: I've got a better . . .
- Kerri: Yes?
- Liz: Twenty-six quarters and a remainder of one quarter left. (Hiebert et al., 1997, p. 121)

The discussion and occasional disagreements continue, and the girls eventually arrive at the correct answer: Mom can make 26 tarts and then will have half an apple left over.

Group problem-solving activities seem to have several benefits. By discussing concepts and principles relevant to a problem, students may identify more interrelationships among things they know and clarify things about which they're confused. By thinking aloud about how to solve a problem, they may gain a better understanding of what they're mentally doing. By observing classmates use more effective strategies, they may begin to adopt those strategies themselves, leaving their own, less efficient ones behind. And small-group efforts to tackle challenging, ill-defined problems can help students acquire the skills they need to tackle similar problems on their own (Brenner et al., 1997; Carr, 2010; Hiebert et al., 1997; Hung, Jonassen, & Liu, 2008; M. Kapur, 2008; Lampert, Rittenhouse, & Crumbaugh, 1996; Qin, Johnson, & Johnson, 1995; Silver, 1985).

♦ *Authentic activities can increase the probability that students will transfer knowledge, skills, and problem-solving strategies to real-world contexts.* In Chapter 13, we discovered that authentic activities—activities similar to real-world tasks—can help students make meaningful connections between school subject matter and their out-of-school lives. Quite possibly, authentic activities help break students out of the situated-learning rut—that is, they help students realize that the information and skills they learn in school are applicable and useful *beyond* school (A. Collins, Brown, & Newman, 1989; Rogoff, 2003; Walkington et al., 2010).

Researchers often find that authentic activities enhance problem-solving skills. For example, preschoolers acquire and use new problem-solving strategies when they actively participate in realistic problem situations while watching the children's television program *Blue's Clues* (Crowley, Anderson, Wilder, Williams, & Santomero, 1999; Gladwell, 2002). Older children and adolescents are more likely to transfer principles of science and technology (e.g., heat conduction, nutrition, electric motors) to real-life situations if classroom tasks ask them to apply the principles to real-world problems—say, designing an energy-efficient home, planning a lengthy camping trip, or trouble-shooting a malfunctioning engine (Bransford, Franks, Vye, & Sherwood, 1989; M. C. Linn, 2008; Mayer, 2010a).

In some instructional contexts, a great deal of learning occurs within the context of solving problems. In such **problem-based learning (PBL)**, students are given complex, real-world problems to tackle (usually in small groups) and must acquire new knowledge and skills in order to solve them. Problem-based learning has been used primarily at the undergraduate and graduate levels, most notably in medical schools, but it has occasionally been used in K–12 settings as well. Evaluations of PBL have yielded mixed results. On the upside, although PBL isn't necessarily better than more traditional methods for helping students master basic knowledge and skills,

it can help them interconnect what they're learning and transfer it to new situations (Capon & Kuhn, 2004; Gijbels, Dochy, Van den Bossche, & Segers, 2005; Hung et al., 2008; H. G. Schmidt, van der Molen, te Winkel, & Wijnen, 2009). On the downside, the complex problems used in some PBL activities may exceed students' working memory capacities, leaving no mental "room" for students to actually learn the new material they're working with (P. A. Kirschner et al., 2006). And in some cases students may connect new concepts only to the particular problem with which they're working—thereby *promoting* rather than curtailing situated learning (Bereiter & Scardamalia, 2006; P. A. Kirschner et al., 2006). It appears that problem-based learning is most often successful when students' efforts are sufficiently scaffolded to guide them in productive directions and to help them realize that successful problem solutions are well within their reach (Hmelo-Silver, 2006; Hmelo-Silver, Duncan, & Chinn, 2007).

In recent years, advances in technology have lent themselves to a wide variety of authentic problem-solving activities. For example, in the classic videodisc-based series *The Adventures of Jasper Woodbury*, students must apply academic subject matter to help on-screen characters solve a wide variety of realistic problems (Cognition and Technology Group at Vanderbilt, 1990; Learning Technology Center at Vanderbilt, 1996). In one episode, "Journey to Cedar Creek," Jasper has just purchased an old boat and is hoping to pilot the boat home the same day. Because the boat has no running lights, he must figure out whether he can get home by sunset, and because he's spent all his cash and used his last check, he must determine whether he has enough gas to make the trip. Throughout the video, all the information students need to answer these questions is embedded in authentic contexts (e.g., a marine radio announces time of sunset, and mileage markers are posted at various landmarks along the river), but students must sift through a lot of irrelevant information to find it.

Since the groundbreaking *Jasper* series in the 1990s, numerous software packages and Internet resources have emerged to provide realistic contexts in which students tackle authentic tasks. Some of these are available commercially (e.g., you might check out online descriptions of *Gary Gadget*, *Crazy Machines*, and *Animal Hospital*). Many Internet websites also provide both traditional and authentic problem-solving activities appropriate for children and adolescents (e.g., see [www.nsf.gov](http://www.nsf.gov) and [www.smithsonianeducation.org](http://www.smithsonianeducation.org)).

◆ *Classroom assessment practices should include measures of transfer and problem solving.* As noted in Chapter 11, traditional classroom assessment practices too often emphasize the learning of specific facts and procedures. Certainly basic knowledge and skills are important; among other things, they form the foundation for more sophisticated acquisitions. But when teachers' instructional objectives also include transfer and problem solving, school assessment tasks should ask students to demonstrate the ability to apply classroom subject matter to a variety of situations (Darling-Hammond & Bransford, 2005; Foos & Fisher, 1988; R. L. Johnson, Penny, & Gordon, 2009; R. J. Sternberg & Frensch, 1993). This practice can help successful transfer and problem solving become common phenomena rather than rare occurrences.

## CRITICAL THINKING

---

Whereas transfer and problem solving involve applying information and skills to something else, in a sense critical thinking involves applying something else—in particular, one or more evaluation criteria—to new information. Different theorists define critical thinking somewhat differently,

but for our purposes here we'll define **critical thinking** as evaluating the accuracy, credibility, and worth of information and lines of reasoning. Critical thinking is reflective, logical, and evidence-based. It also has a purposeful quality to it—that is, the learner thinks critically in order to achieve a particular goal (Beyer, 1985; Halpern, 2008; Moon, 2008).

Critical thinking can take a variety of forms, depending on the context. Following are four examples:

1. It's autumn, and the days are becoming increasingly chilly. You see the following advertisement online:

Aren't you tired of sniffles and runny noses all winter? Tired of always feeling less than your best? Get through a whole winter without colds. Take Eradicold Pills as directed. (R. J. Harris, 1977, p. 605)

Should you go out and buy a box of Eradicold Pills?

2. You've invested several thousand dollars to get a beat-up old car in working order. You can sell the car in its present condition for \$1,500, or you can invest a couple thousand dollars more on repairs and then sell it for \$3,000. What should you do? (modeled after Halpern, 1998)
3. You've been rolling a typical six-sided die (i.e., one member of a pair of dice). You know for a fact that the die isn't loaded—it's not heavier on one side than another—yet in the past 30 rolls you haven't rolled a number 4 even once. What are the odds that you'll get a 4 on the next roll?
4. Dr. Edmund Emmer reported this finding at the annual conference of the American Educational Research Association in 1994:

Teachers who feel happy when they teach are more likely to have well-behaved students.

If you're a teacher, does this finding tell you that you should try to feel happy when you begin class each morning?

In each situation, you had to evaluate information and make some sort of judgment. In Item 1, I hope you weren't tempted to purchase Eradicold Pills, because the advertisement provided no proof that they reduce cold symptoms. It simply included the suggestion to "Take Eradicold Pills as directed" within the context of a discussion of undesirable symptoms—a common ploy in persuasive advertising. In a study by Harris (1977), people who read the passage I gave you were pretty gullible: They asserted that Eradicold Pills prevented colds almost as frequently as people who read an explicit cause-and-effect statement about Eradicold's medicinal power.

As for Item 2, it makes more sense to sell the car now. If you sell it for \$3,000 after making \$2,000 worth of repairs, you'll make \$500 less than you would otherwise. Many people mistakenly believe that their past investments justify making additional ones, when in fact past investments are irrelevant to the present state of affairs (Halpern, 1998).

In Item 3, the chance of rolling a 4 on an evenly balanced die is 1 in 6. The outcomes of previous rolls are irrelevant, because each roll is independent of the others. But when a 4 hasn't shown up even once in 30 rolls, many people believe that it's long overdue and so greatly overestimate its probability—a misconception known as the *gambler's fallacy*.

Now what about a teacher trying to be happy before beginning class each day (Item 4)? One common mistake people make in interpreting research results is to think that an association

(*correlation*) between two things means that one of those things must *cause* the other. But if you've taken a research methods course, you've almost certainly learned that a correlation between two things doesn't necessarily mean that one thing causes the other. Perhaps teacher happiness directly influences students' classroom behavior, but perhaps, instead, good student behavior makes teachers feel happy, or perhaps teachers who feel upbeat use more effective teaching techniques and can better keep students on task as a result (Emmer, 1994).

The four situations I've just given you illustrate several forms that critical thinking might take (Halpern, 1997, 1998, 2008; Nussbaum, 2008):

- *Verbal reasoning*: Understanding and evaluating persuasive techniques found in oral and written language. You engaged in verbal reasoning when deciding whether to purchase Eradicold Pills.
- *Argument analysis*: Discriminating between reasons that do and don't support a conclusion. You engaged in argument analysis when you considered possible pros and cons of investing an additional \$2,000 in car repairs.
- *Probabilistic reasoning*: Determining the likelihood and uncertainties associated with various events. You engaged in probabilistic reasoning when you determined the probability of rolling a 4 on the die.
- *Hypothesis testing*: Judging the value of data and research results in terms of the methods used to obtain them and their potential relevance to certain conclusions. When hypothesis testing includes critical thinking, it involves considering questions such as these:
  - Was an appropriate method used to measure a particular outcome?
  - Have other possible explanations or conclusions been eliminated?
  - Can the results obtained in one situation be reasonably generalized to other situations?

You engaged in hypothesis testing when you evaluated Dr. Emmer's findings about teacher happiness.

The nature of critical thinking is different in various content domains. In writing, it may involve reading the first draft of a persuasive essay to look for errors in logical reasoning or for opinions that haven't been sufficiently justified. In science, it may involve revising existing theories or beliefs to account for new evidence—that is, it may involve conceptual change. In history, it may involve drawing inferences from historical documents, attempting to determine whether things *definitely* happened a particular way or only *maybe* happened that way.

## Developmental, Individual, and Cultural Differences in Critical Thinking

As you might guess, critical thinking skills emerge gradually over the course of childhood and adolescence (Amsterlaw, 2006; D. Kuhn & Franklin, 2006; Metz, 2004; Pillow, 2002). Yet all too often, learners of all ages (even college students) take the information they encounter in textbooks, media reports, Internet websites, and elsewhere at face value. In other words, they engage in little or no critical analysis of what they're reading and hearing.

To some degree, learners' tendency to think or not think critically depends on their personality characteristics: On average, critical thinkers are open-minded, enjoy intellectual challenges, and can emotionally handle the idea that they might occasionally be wrong about a topic

(Halpern, 2008; Moon, 2008; West, Toplak, & Stanovich, 2008). Learners' epistemic beliefs also come into play. Learners are more likely to look analytically and critically at new information if they believe that even experts' understanding of a topic continues to evolve as new evidence accumulates. They're *less* likely to engage in critical thinking if they believe that knowledge is an absolute, unchanging entity (Kardash & Scholes, 1996; P. M. King & Kitchener, 2002; D. Kuhn, 2001a; Muis & Franco, 2009; Schommer-Aikins, 2002).

Another influential factor is one's cultural upbringing. For example, if a culture places high value on respecting one's elders or certain religious leaders, it's likely to foster the epistemic belief that "truth" is a cut-and-dried entity that's best gained from authority figures (Delgado-Gaitan, 1994; Losh, 2003; Qian & Pan, 2002; Tyler et al., 2008). In addition, a cultural emphasis on maintaining group harmony may discourage children from hashing out differences in perspectives, which critical thinking often entails (Kağıtçıbaşı, 2007; D. Kuhn & Park, 2005; Moon, 2008). Perhaps as a result of such factors, critical thinking may be less common in some groups—for instance, in some very traditional Asian and Native American communities and in some fundamentalist religious groups—than in others (D. Kuhn, Daniels, & Krishnan, 2003; D. Kuhn & Park, 2005; Tyler et al., 2008; see Heyman, Fu, & Lee, 2007, for an exception).

## Fostering Critical Thinking in the Classroom

In encouraging critical thinking, teachers must sometimes walk a fine line between teaching students to critically evaluate persuasive arguments and scientific evidence, on the one hand, and to show appropriate respect and strive for group harmony in their community and culture, on the other. But even given the constraints of certain cultural norms and practices, adults and children alike typically benefit from instruction in critical thinking skills (Abrami et al., 2008; Bangert-Drowns & Bankert, 1990).

Perhaps because critical thinking encompasses such a variety of cognitive skills, strategies for encouraging it are many and varied. Some of the factors that promote metacognition, transfer, and problem solving are applicable to teaching critical thinking as well. Embeddedness of thinking-skill instruction within the context of specific academic disciplines, numerous opportunities to practice critical thinking, collaborative group tasks, authentic activities—all of these factors can help learners think more critically (Abrami et al., 2008; Derry, Levin, Osana, & Jones, 1998; Halpern, 1998; Monte-Sano, 2008; Nussbaum, 2008). Following are several additional research-based recommendations:

- Encourage intellectual skepticism—for instance, by urging students to question and challenge things they read and hear—and communicate the message that knowledge and understanding of any single topic often continues to change over time.
- Model critical thinking—for instance, by thinking aloud while analyzing a scientific report.
- Teach specific elements of argumentative reasoning, and have students develop persuasive arguments related to controversial issues.
- Occasionally ask students to defend a perspective quite different from their own.
- Help students understand that critical thinking involves considerable mental effort but that it's essential when one is deliberating about important issues. (Chinn, Anderson, & Waggoner, 2001; Ferretti, Lewis, & Andrews-Weckerly, 2009; Halpern, 1998; Heyman,

2008; Kardash & Scholes, 1996; D. Kuhn, 2001a; D. Kuhn & Weinstock, 2002; Nussbaum, 2008; N. J. Stone, 2000)

Teachers might also ask students to consider questions such as these when reading printed materials or gaining information from Internet websites:

- Who produced this document/website? Does the author have well-substantiated (as opposed to self-proclaimed) expertise about the topic? What biases or predispositions might the author have?
- What persuasive technique is the author using? Is it valid, or is it designed to mislead the reader?
- What evidence and/or reasons support the conclusion? What evidence and/or reasons *don't* support the conclusion?
- Is the information consistent with what you've learned from other sources? If not, in what ways is it different? How might you reconcile the inconsistencies? (Questions based on suggestions by Halpern, 1998; S. A. Stahl & Shanahan, 2004; Wiley et al., 2009)

In this age of widespread access to multiple sources of information—some legitimate, some of questionable value, and some completely bogus—critical thinking skills are now more *critical* than ever.

---

## SUMMARY

*Transfer* is the process of applying information and skills learned in one situation to learning or performance in another situation. Although most instances of transfer are beneficial, once in a while learning something at one time can negatively impact learning or performance at a later time. Over the years, views about what things transfer—and when—have varied considerably. Historically, many educators took a mind-as-muscle view, assuming that studying any rigorous subject matter strengthens the mind and thus facilitates future learning and performance. In contrast, early behaviorists proposed that similarity of stimuli or responses (or both) is essential for transfer to occur. More recently, cognitivists have suggested that people are most likely to apply what they've learned if their present context encourages retrieval of potentially useful prior knowledge *or* if they've acquired general learning strategies, motives, and dispositions that they bring to bear on virtually any learning task. Regardless of which theoretical perspective we take, it appears that transfer from one situation to another is most likely to occur when the two

situations have *something* in common or require similar skills or attitudes on the part of the learner. Among the factors that facilitate transfer are meaningful and thorough learning of a topic, a focus on general principles more than on discrete facts, a wide variety of examples and opportunities for practice, and a general classroom culture that encourages transfer.

*Problem solving* is a form of transfer, in that previously learned information is used to address an unanswered question or troubling situation. In their theories of problem solving, behaviorists have, as you might expect, focused on the nature of learners' overt responses to problems. However, present-day theories of problem solving are largely cognitivist theories, with emphases on such internal factors as working memory, encoding, retrieval, prior knowledge base, and metacognition. Some problems can be solved through specific *algorithms*, procedures that guarantee correct solutions. But many others can be solved only through more general *heuristics*—approaches without guaranteed outcomes (e.g., talking to oneself about a problem, externally representing some problem



components, brainstorming possible solutions). People typically apply problem-solving procedures more effectively and appropriately when they understand the logic behind the procedures.

Theory and research yield numerous suggestions for promoting transfer and problem solving in classroom settings. For example, a school's prescribed curriculum should make it possible for teachers to teach a few things thoroughly and meaningfully rather than many things superficially and at a rote level (the *less-is-more* idea). Students should have a *mental set* for transfer; that is, they should approach school subject matter with the idea that they might be able to use it on future occasions. Under some circumstances—for instance, when students' efforts are appropriately structured and scaffolded—such techniques as discovery learning, group problem-solving tasks, and authentic activities can facilitate the development and

transfer of effective problem-solving skills. Ideally, teachers should not only *teach* for transfer and problem solving but also emphasize it in their assessment practices.

*Critical thinking* involves evaluating the accuracy, credibility, and worth of information and lines of reasoning. It takes a variety of forms, such as analyzing or constructing persuasive arguments, reasoning about probabilities, and identifying statements and evidence that do and don't support a particular conclusion. In general, learners gain greater proficiency in critical thinking as they grow older, but personality characteristics, epistemic beliefs, and cultural upbringing also influence learners' inclinations to think or not think critically. Both explicit instruction and a classroom atmosphere that values thoughtful analysis of ideas have been shown to enhance students' critical thinking abilities.

# MOTIVATION AND AFFECT

### *General Effects of Motivation*

*Extrinsic versus Intrinsic Motivation*

### *Basic Human Needs*

*Drive Reduction*

*Arousal*

*Maslow's Hierarchy of Needs*

*Competence and Self-Worth*

*Self-Determination*

*Relatedness*

### *Individual Differences in Motivation*

*Need for Affiliation*

*Need for Approval*

### *Need for Achievement*

*Dispositions*

### *Affect and its Effects*

*How Affect Is Related to Motivation*

*How Affect Is Related to Learning and Cognition*

*Anxiety*

### *Creating a Motivating Classroom Environment*

*Summary*

Over the years I've learned how to do a great many things. For instance, I've learned how to teach and write about psychology. I've learned how to find my favorite junk food in the supermarket and my favorite television game shows in *TV Guide*. I've learned how to control my tongue and temper in committee meetings. I've learned how to mow the lawn, file a tax return, cook lima beans, and clean the garage.

Yet you don't see me doing all these things on a regular basis. I engage in some activities (e.g., writing about psychology, eating junk food, and watching television game shows) because I like doing them. I engage in others (e.g., behaving myself at committee meetings, filing tax returns, and mowing the lawn) not because I enjoy them but because they bring me things I *do* enjoy, such as productive relationships with colleagues, IRS refunds, or a well-kept yard. But there are some things that I rarely do because they aren't fun and reap few, if any, rewards. For example, you won't find me cooking lima beans (abominable little things) or cleaning the garage (the cars don't care one way or the other). And there are additional things I've never learned at all because I see little point in doing so. Batting averages of professional baseball players, locations for the "petite" sizes in ladies' clothing at Sears, and strategies for walking barefoot on hot coals all fall into this category.

**Motivation**—an internal state that arouses us to action, pushes us in particular directions, and keeps us engaged in certain activities—is the key ingredient here. Even if we're perfectly capable of learning something—and I am, mind you, quite capable of learning where to find virtually any clothing size at Sears—motivation often determines whether and to what extent we actually learn it, especially if the behaviors and cognitive processes necessary for learning are voluntary and under our control. Furthermore, once we *have* learned how to do something, motivation is largely responsible for whether we continue to do it.

We've touched on the importance of motivation in previous chapters—for instance, within our discussions of reinforcement (Chapter 4), modeling (Chapter 6), conceptual change (Chapter 10), and self-regulated learning (Chapter 14). In the final two chapters of the book, we'll look more closely at the nature of motivation. In this chapter, we'll consider how, in general, motivation influences behavior, cognition, and learning and then explore various theories regarding basic human

needs. Later, we'll turn our attention to a close companion of motivation—*affect* (emotion)—and look at the many ways in which it's involved in learning and behavior.

As we proceed, keep in mind that *learners are almost always motivated in one way or another*. For example, students in a typical sixth-grade classroom have a variety of motives (O. Lee & Anderson, 1991). Some almost certainly want to learn the subject matter being taught. Others may be more interested in getting good grades, outperforming their classmates, pleasing their teachers and parents, or simply completing assignments as quickly and painlessly as possible. Such motives all have an *approach* quality to them: Underlying them is a desire to achieve certain outcomes. Yet students may sometimes behave in order to *avoid* certain situations—perhaps an assigned task with which they're likely to struggle or a social situation in which they might encounter bullies. In general, teachers should never question *whether* their students are motivated. Instead, they should try to determine *in what ways* their students are motivated.

Keep in mind, too, that although learners bring certain motives with them to the classroom, *motivation is partly a function of the learning environment*—a phenomenon known as **situated motivation** (Paris & Turner, 1994; Rueda & Moll, 1994; J. C. Turner & Patrick, 2008). In classrooms, many factors influence students' motivation—the nature of instructional materials (e.g., whether they're interesting, challenging, and relevant to students' lives), the extent to which students must compete or cooperate with one another, the ways in which students are evaluated, and so on. Ultimately, I hope you'll discover that motivation isn't simply a “switch” that people “turn on” and “turn off” at will. Rather, it's the result of numerous factors, some of which are in learners' control but many more of which are the result of learners' past and present environmental circumstances.

## GENERAL EFFECTS OF MOTIVATION

---

Children and adults alike aren't always consciously aware of the particular motives that drive their actions (Immordino-Yang & Sylvan, 2010; Pintrich, 2003; Schultheiss & Brunstein, 2005). Yet motivation consistently reveals itself through its effects on behavior and learning:

- It directs behavior toward particular goals.
- It increases effort and energy in pursuit of those goals.
- It increases initiation of and persistence in certain activities, even in the face of occasional interruptions and frustrations.
- It affects cognitive processes, such as what learners pay attention to and how much they think about and elaborate on it.
- It determines which consequences are and aren't reinforcing and punishing. (Ladd & Dinella, 2009; Larson, 2000; Maehr & Meyer, 1997; Pintrich, Marx, & Boyle, 1993; Pugh & Bergin, 2006)

Thus, learners' motivation tends to be reflected in *personal investment* and in cognitive, emotional, and behavioral *engagement* in certain activities. In general, motivation increases **time on task**, an important factor affecting learning and achievement in a particular domain (Fredricks, Blumenfeld, & Paris, 2004; Ladd & Dinella, 2009; J. Lee & Shute, 2010; Maehr & McInerney, 2004; M.-T. Wang & Holcombe, 2010).

Yet not all forms of motivation have exactly the same effects on human learning and performance, as we'll see now.

## Extrinsic versus Intrinsic Motivation

At the beginning of the chapter, I mentioned that I engage in some activities because they bring about desirable consequences (i.e., they're extrinsically reinforced), whereas I engage in others simply because they're enjoyable. Just as behaviorists distinguish between extrinsic and intrinsic reinforcement, motivation theorists distinguish between extrinsic and intrinsic motivation.

**Extrinsic motivation** exists when the source of motivation lies outside the individual and the task being performed. For example, I file an income tax return every year partly because I usually get a refund when I do so and partly because I might be fined (i.e., punished) if I *don't* file. For many years I attended university committee meetings because university service was part of my job description and I was quite dependent on my monthly paycheck (in my current work, attending committee meetings is, thank goodness, rarely required). I give my house a thorough cleaning when preparing to host a party because I would hate for my friends to discover I'm a slob.

In contrast, **intrinsic motivation** exists when the source of motivation lies within the individual and task: The person finds the task enjoyable or worthwhile in and of itself. For example, I frequently read books and articles about human learning and motivation because they continue to shed new light on topics that are, to me, utterly fascinating. I watch television game shows because I enjoy playing along as a home viewer. I eat junk food because it tastes good (an unfortunate consequence is that I have no need for the petite sizes at Sears).

Extrinsic motivation can certainly promote successful learning and productive behavior (Cameron, 2001; Hidi & Harackiewicz, 2000; C. S. Ryan & Hemmes, 2005; also see Chapter 5). But extrinsic motivation in the classroom has its drawbacks: Extrinsically motivated students may exert only the minimal behavioral and cognitive effort they need to execute a task successfully (occasionally this may mean copying a classmate's work), and they may stop an activity as soon as reinforcement ceases (Brophy, 2004; Flink, Boggiano, Main, Barrett, & Katz, 1992; O. Lee, 1991; Reeve, 2006).

Intrinsic motivation has numerous advantages over extrinsic motivation. For any particular task, intrinsically motivated learners are more likely to:

- Pursue a task on their own initiative, without having to be prodded or cajoled
- Be cognitively engaged in the task (e.g., by keeping attention focused on it)
- Undertake more challenging aspects of the task
- Strive for true understanding of the subject matter (e.g., by engaging in meaningful rather than rote learning)
- Undergo conceptual change when warranted
- Show creativity in performance
- Persist in the face of failure
- Experience pleasure in what they're doing
- Seek out additional opportunities to pursue the task
- Achieve at high levels (Becker, McElvany, & Kortenbruck, 2010; Brophy, 1986; Corpus, McClintic-Gilbert, & Hayenga, 2009; Csikszentmihalyi, Abuhamdeh, & Nakamura, 2005; Csikszentmihalyi & Nakamura, 1989; Flink et al., 1992; Gottfried, 1990; B. A. Hennessey, 1995; Maehr, 1984; Pintrich et al., 1993; Reeve, 2006; Schweinle, Meyer, & Turner, 2006)

An especially intense form of intrinsic motivation, called **flow**, is characterized by a state of complete absorption, focus, and concentration in a challenging activity, to the point that the learner

loses track of time and completely ignores other tasks (Csikszentmihalyi, 1990; Csikszentmihalyi et al., 2005; Shernoff & Csikszentmihalyi, 2009).

Obviously, intrinsic motivation is the optimal state of affairs in the classroom. At the same time, we shouldn't assume that extrinsic and intrinsic motivation must be an either-or situation. On many occasions, learners may be *both* extrinsically and intrinsically motivated (Hidi & Harackiewicz, 2000; Lepper, Corpus, & Iyengar, 2005). Furthermore, even a single motive can have both extrinsic and intrinsic aspects; for example, students may strive for good grades not only for the external rewards that such grades bring but also for verification that they've indeed mastered the subject matter (Hynd, 2003). And as we'll discover in our discussion of *internalized motivation* in Chapter 17, some motives have a partly-extrinsic-partly-intrinsic nature.

## BASIC HUMAN NEEDS

---

Over the years, theorists have offered varying perspectives about needs that might be universal across the human species. Here we focus on early perspectives (drives, need for arousal, and Maslow's hierarchy of needs) and more recent ones (needs for competence, self-worth, self-determination, and relatedness) that are especially relevant to instructional settings. As you'll see, some of these perspectives shed light on conditions that foster intrinsic motivation.

### Drive Reduction

Drive theory is based on the notion that people and other animals (*organisms*) try to maintain physiological homeostasis—that is, they try to keep their bodies at an optimal state of functioning (e.g., Freud, 1915/1949; Hull, 1951, 1952; Woodworth, 1918). A **drive** is an internal state of need: Something necessary for optimal functioning (e.g., food, water, adequate rest) is missing. When a drive exists, the organism behaves in ways that reduce the need and bring the body back into balance. For example, a hungry person eats, a thirsty person drinks, and a tired person goes to bed. If a need-reducing response isn't immediately possible, the organism shows a general increase in activity—activity that may eventually lead to an encounter with a need-reducing stimulus.

Although early psychologists of many theoretical persuasions found value in the concept of drive, advancements in drive theory emerged largely through the work of behaviorists. From a behaviorist perspective, a reinforcer is effective to the extent that it reduces a need state, thereby simultaneously reducing drive. For example, food is reinforcing only if an organism is hungry, and a drink of water is reinforcing only if the organism is thirsty. Behaviors that reduce a need state—behaviors that are reinforced—are likely to be repeated when the same need emerges at a later time.

Probably the most widely cited version of drive theory is that of behaviorist Clark Hull (1943, 1951, 1952). Hull initially proposed that drive is based on physiological needs such as hunger and thirst. All of these needs contribute to an organism's general drive state, which itself isn't specific to a particular need. Hull further proposed that the strength (or intensity) of a behavior is a function of both *habit strength* (i.e., the degree to which a particular stimulus–response association has been learned) and drive:

$$\text{Strength of behavior} = \text{Habit} \times \text{Drive}$$

In such a multiplicative relationship, both habit (prior learning) and drive must be present. If either is zero, the strength of the behavior—the likelihood that it will occur—is also zero.

Hull based his notion of *habit times drive* on experiments conducted by two of his students (Perin, 1942; S. B. Williams, 1938). In these experiments, rats were placed in Skinner boxes and trained to press a bar for a food reinforcer. Different groups of rats received varying amounts of training, with a greater number of reinforced responses presumably leading to greater habit strength. Later, after going without food for either 3 hours (low drive) or 22 hours (high drive), the rats were once again placed in Skinner boxes, and their frequency of bar pressing was recorded under nonreinforcement (extinction) conditions. The hungrier rats pressed the bar many more times than the less hungry rats; similarly, rats who had received more training pressed the bar more often than those who had undergone little training. Rats with little drive (3 hours of food deprivation) and low habit strength (5 training trials) pressed the bar, on average, only once.

Hull later revised his thinking in two significant ways. First, he observed that some behaviors serve no apparent biological purpose. He therefore proposed that some drives are **acquired drives**: They develop when previously neutral stimuli are associated with drive-reducing stimuli such as food. To illustrate, one might become driven by a need for other people's approval if their approval has previously been associated with candy and other tasty treats. From this perspective, reinforcement results from reduction of one's drive rather than reduction of specific physiological needs.

In addition, Hull took into account research by Crespi (1942) and others indicating that reinforcers may affect performance rather than learning. (We examined Crespi's study in Chapter 4. To refresh your memory, rats running down a runway for food began to run faster when the amount of reinforcement was increased; they began to run more slowly when the amount was decreased.) Accordingly, Hull introduced the concept of *incentive* into his theory, acknowledging that behaviors are influenced by characteristics of a goal object—for example, by the amount of food at the end of a runway. Incentive became a third essential ingredient for a behavior to occur, as follows:

$$\text{Strength of behavior} = \text{Habit} \times \text{Drive} \times \text{Incentive}$$

When any of these three factors—habit strength, drive, or incentive—is absent, the behavior doesn't occur.

Other theorists have since expanded on Hull's notion that the characteristics of goal objects (incentives) are motivating forces in behavior (Mowrer, 1960; Overmier & Lawry, 1979; K. W. Spence, 1956). In their view, **incentive motivation** serves as a mediator (M) between stimuli and responses, affecting which stimuli are responded to and which are not. Symbolically, we could describe the relationship this way:

$$S \rightarrow M_{\text{incentive}} \rightarrow R$$

For example, I find a bag of Cheetos quite enticing after several hours of food-free book writing, thus leading to a reach-in-and-grab-a-handful response. However, the same bag provokes no response whatsoever right after a Thanksgiving dinner, when I've stuffed myself with turkey, mashed potatoes, and pumpkin pie.

Incentives undoubtedly play a role in human motivation. Just as Crespi's rats ran faster when they knew that mass quantities of food lay waiting at the end of the runway, so, too, do we humans apparently work harder when incentives are more attractive. When our progress toward

a particular goal object is temporarily stymied, we often intensify our efforts. And when our progress is permanently blocked, we're likely to respond with immature behavior or aggression (Bandura, Ross, & Ross, 1961; Berkowitz, 1989; Dollard, Doob, Miller, Mowrer, & Sears, 1939; Klinger, 1975, 1977).

Incentives remain in vogue as a probable factor in motivation (see the discussion of social cognitive theory in Chapter 6), and behaviorists acknowledge that different objects and events may be more or less reinforcing depending on whether an organism has been deprived of them for any significant period (McGill, 1999; Michael, 1993, 2000). But theorists have largely abandoned drives in their discussions of motivation, and for a couple of reasons. For one thing, a great deal of human behavior seems to be aimed at accomplishing long-term goals rather than addressing short-term needs and drives (we'll look at such goals in Chapter 17). Also, organisms sometimes behave in ways that actually *increase* their drive states (Olds & Milner, 1954; Rachlin, 1991; Sheffield, 1966a, 1966b). For instance, we humans voluntarily increase our drive states by going to scary movies, reading suspense novels, and riding roller coasters. Some of us are even **sensation seekers**, putting ourselves in risky or dangerous situations on a regular basis for the physiological thrills that such situations yield (Joseph, Liu, Jiang, Lynam, & Kelly, 2009; M. Zuckerman, 1994). Perhaps such sensation seeking is an extreme form of a more basic need—a need for arousal.

## Arousal

Psychologists use the term **arousal** to refer to an organism's current level of internal energy. Organisms experiencing low levels of arousal are relaxed, bored, or asleep. Organisms experiencing high levels of arousal are greatly energized, perhaps to the point of being quite anxious. Some research indicates that people have a basic need for stimulation; in other words, they have a **need for arousal**.<sup>1</sup>

As an example, let's consider a classic study by Heron (1957). Male college students were given \$20 a day (quite an incentive in the 1950s) to stay as long as they could in a boring environment—and I mean a *really* boring environment. Aside from occasional brief breaks for eating and other biological necessities, the students spent the time in a small, sparsely furnished cubicle in which the only sound was the continuous hum of an air conditioner. They wore plastic visors that allowed them to see only diffused, unpatterned light (making them functionally blind) and thick gloves and cardboard sleeves that prevented them from feeling different shapes and textures (minimizing information they could gain through touch). Naturally, many students began by catching up on their sleep. Students spent their first few waking hours thinking about college coursework, personal issues, past experiences, and so on. Eventually, they ran out of things to think about and so simply let their minds wander aimlessly. As time went on, cognitive functioning deteriorated: The students had trouble concentrating, reported distorted perceptual processes (e.g., the room seemed to move, objects seem to change size and shape), and in general were quite disoriented. Some began to hallucinate, perhaps seeing a row of cartoonlike men with open mouths or a line of marching squirrels with bags over their shoulders, or perhaps hearing a church choir singing or a music box playing. Some also reported feelings of touch or movement:

---

<sup>1</sup>Occasionally one of my students mistakenly infers that this term refers to sexual activity. On the contrary, *need for arousal* refers to a basic need for stimulation of *any* kind.

“One had a feeling of being hit in the arm by pellets fired from a miniature rocket ship he saw” (p. 54). More generally, people seem to have exceptional difficulty functioning under conditions of *sensory deprivation* for any length of time (Solomon et al., 1961).

Some theorists have suggested that not only do people have a basic need for stimulation but they also strive for a certain *optimal level* of arousal (E. M. Anderman, Noar, Zimmerman, & Donohew, 2004; Berlyne, 1960; Hsee, Yang, & Wang, 2010). Too little stimulation is unpleasant, but so is too much. For example, you may enjoy watching a television game show or listening to music, but you’d probably rather not have three television sets, five CD players, and a live rock band all blasting in your living room at once. Different people have different optimal levels: Some are sensation seekers, whereas others prefer a quieter existence. I, for one, like things a bit on a dull side. Although I certainly enjoy a suspenseful mystery novel on occasion, you’ll never catch me riding a roller coaster or bungee jumping.

I’ve seen very little reference to need for arousal in the motivation literature in recent years, but this simple concept does seem to explain some of the things we see in classrooms. For instance, it explains why students create their own excitement (perhaps passing notes or playing practical jokes on one another) when their teacher drones on at length about a dry topic (Pekrun, Goetz, Daniels, Stupnisky, & Perry, 2010). (In a sociology class I took in college, the girl who sat next to me kept a running tally of how many times the professor cleared his throat. This simple activity kept us both amused, which was fortunate, because the professor certainly didn’t.) Furthermore, descriptions of personality characteristics reflecting varying levels of need for arousal—in particular, *stimulation seeking* and the *need for cognition*—have recently appeared on the scene, as we’ll see in our discussion of *dispositions* later in the chapter.

## Maslow’s Hierarchy of Needs

Another early perspective of motivation was that of Abraham Maslow (1943, 1959, 1973, 1987). Maslow’s theory was a central feature of **humanism**, a movement in psychology that gained prominence in the 1960s and 1970s. Humanism had its roots in counseling psychology and focused its attention on how individuals acquire emotions, attitudes, values, and interpersonal skills. Although early humanist perspectives such as Maslow’s were grounded more in philosophy than in research, they offered useful insights into human motivation nevertheless. (A more contemporary, research-based version of humanism is known as **positive psychology**; for example, see Gilman, Huebner, & Furlong, 2009; C. Peterson, 2006.)

In an attempt to pull together his informal observations of human behavior, Maslow proposed that people have five distinct kinds of needs:

1. *Physiological needs*. People are motivated to satisfy needs related to their immediate physical survival—needs for food, water, exercise, rest, and so on. Maslow’s physiological needs are essentially the same as those in Hull’s early drive theory.
2. *Safety needs*. People have a need to feel safe and secure in their environment. Although they may enjoy an occasional surprise, generally speaking they prefer some structure, order, and predictability in their lives.
3. *Love and belongingness needs*. People seek affectionate relationships with others and like to feel that they belong to and are accepted in a social group.
4. *Esteem needs*. People need to feel good about themselves (**need for self-esteem**) and to believe that others also feel positively about them (**need for esteem from others**).



To develop positive self-esteem, individuals strive for achievement and mastery of their environment. To attain the esteem and respect of others, they behave in ways that gain them recognition, appreciation, and prestige.

5. *Need for self-actualization.* People have a need to **self-actualize**—to develop and become all they're capable of becoming (also see C. R. Rogers, 1951, 1961). Individuals striving toward self-actualization seek out new activities as a way of expanding their horizons and want to learn simply for the sake of learning. For example, people seeking self-actualization might be driven by their own curiosity to learn everything they can about a particular topic, or they might pursue an active interest in ballet both as a means of developing muscle tone and as an outlet for creative self-expression.

Maslow proposed that the five sets of needs form a hierarchy, as illustrated in Figure 16.1. When two or more of these needs are unmet, people tend to satisfy them in a particular sequence. They begin with the lowest needs in the hierarchy, satisfying physiological needs first, safety needs next, and so on, addressing higher needs only after lower needs have been attended to. For example, a boy with a need to release pent-up energy (a physiological need) may become excessively restless in class even though his teacher scolds him for his hyperactivity (thereby *not* satisfying the boy's need for esteem from others). A girl with an unfulfilled need for love and belonging may choose not to enroll in intermediate algebra—a class that would satisfy her desire to learn more math—if the peers whose friendships she most values tell her the class is only for nerds and dweebs. I once met a boy living in a Philadelphia ghetto who had a strong interest in learning yet often stayed home from school to avoid the violent gangs that hung out on the street corner. This boy's need for safety took precedence over any higher needs he might have had.

According to Maslow, the first four needs in the hierarchy—physiological, safety, love and belonging, and esteem needs—result from things a person *lacks*; hence, Maslow called them **deficiency needs**. Deficiency needs can be met only by external sources—by people or events in one's environment. Furthermore, once these needs are fulfilled, there's no reason to satisfy them further. In contrast, self-actualization is a **growth need**: Rather than addressing a deficiency in a person's life, it enhances the person's growth and development and thus is rarely satisfied completely. Self-actualizing activities tend to be intrinsically motivated: People engage in them because doing so gives them pleasure and satisfies their desire to know and grow.

**Figure 16.1**  
Maslow's hierarchy of needs

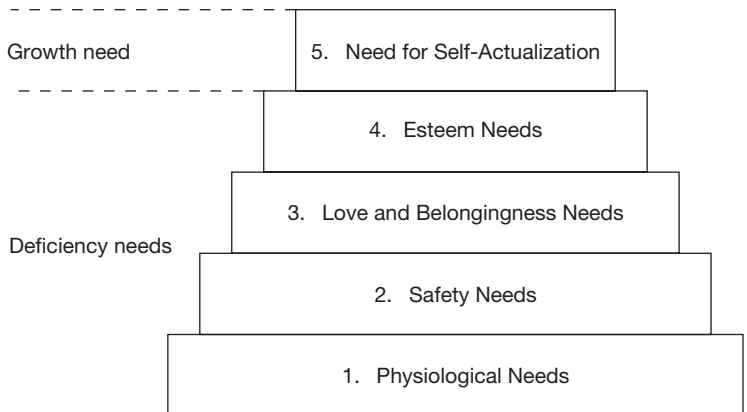

Needs that are satisfied most of the time have little effect on behavior. For example, many people in our society routinely satisfy their physiological and safety needs. The needs for love and esteem are more likely to go unfulfilled; hence, people may direct much of their effort toward developing self-respect and gaining others' love and respect. People are likely to strive for self-actualization only when all four deficiency needs are at least partially met. Once they're regularly focusing on self-actualization, however, they may occasionally disregard more basic needs, perhaps forgoing meals or jeopardizing personal safety in pursuit of a noble cause.

In Maslow's view, self-actualized individuals have many noteworthy characteristics. For example, they're independent, spontaneous, creative, and sympathetic to the plights of others. They perceive themselves and others in an objective, realistic light, and they're quite comfortable with who they are. They typically have a mission in life—an important problem that they're concerned about solving. Maslow suggested that very few people—probably less than 1% of the population—become fully self-actualized, and then only in life's later years.

Despite its intuitive appeal, Maslow's hierarchy has been criticized on several counts. For one thing, little hard evidence exists to substantiate the hierarchical nature of human motivation. Maslow derived his theory from his informal, subjective observations of presumably “self-actualized” personal friends and from published descriptions of such historical figures as Thomas Jefferson and Abraham Lincoln; it would be almost impossible for other investigators to confirm that these individuals had the characteristics Maslow identified. Furthermore, self-actualization is so rare that the hierarchy may not provide an accurate description of people in general (Petri, 1991). Finally, people's various motives are probably too diverse to be boiled down into such a short list of basic needs (Pintrich & Schunk, 2002). (You'll get a better sense of this diversity as we proceed through this and the following chapter.)

At the same time, aspects of Maslow's theory clearly have some merit. It makes sense that people will worry about their physiological well-being and personal safety before they try to address more social needs (e.g., Kenrick, Griskevicius, Neuberg, & Schaller, 2010).<sup>2</sup> And many people do seem to be eager to gain wisdom or creatively express themselves, consistent with Maslow's idea of self-actualization (Kesebir, Graham, & Oishi, 2010; C. Peterson, 2006; C. Peterson & Park, 2010). Furthermore, Maslow's notions of *esteem needs* and *love and belonging needs* are clearly reflected in contemporary theories about self-worth and relatedness—topics we turn to in upcoming sections.

## Competence and Self-Worth

Maslow has hardly been the only one to suggest that people have a need to think positively about themselves. In 1959, Robert White proposed that human beings (and, he suggested, many other species as well) have a basic need for **competence**—a need to believe they can deal effectively with their environment. Other theorists have since echoed this belief, asserting that the need for competence is a fundamental human need (e.g., Boggiano & Pittman, 1992; Connell & Wellborn, 1991; Reeve, Deci, & Ryan, 2004; R. M. Ryan & Deci, 2000).

---

<sup>2</sup>Kenrick and colleagues (2010) have suggested that our evolutionary history has endowed us with a hierarchy of fundamental human motives, which include Maslow's four deficiency needs plus three additional needs (mate acquisition, mate retention, and parenting) that ensure reproduction and preservation of our species. In their view, upper levels of the hierarchy emerge later in development and overlap with, but do not fully replace, lower levels.

To achieve a sense of competence, young children spend a great deal of time engaged in exploring and attempting to master the world. As an illustration, let's look once again at an example I presented in Chapter 12, in which Jean Piaget's son Laurent tried to reach a piece of bread that was beyond his reach:

Laurent is seated before a table and I place a bread crust in front of him, out of reach. Also, to the right of the child I place a stick about 25 cm. long. At first Laurent tries to grasp the bread without paying attention to the instrument, and then he gives up. I then put the stick between him and the bread. . . . Laurent again looks at the bread, without moving, looks very briefly at the stick, then suddenly grasps it and directs it toward the bread. But he grasped it toward the middle and not at one of its ends so that it is too short to attain the objective. Laurent then puts it down and resumes stretching out his hand toward the bread. Then, without spending much time on this movement, he takes up the stick again, this time at one of its ends . . . and draws the bread to him. (Piaget, 1952b, p. 335)

Laurent was only 16 months old at the time yet clearly had an intrinsic desire to master an aspect of his environment. According to White (1959), the need for competence has biological significance and probably evolved with our species: It pushes people to develop ways of dealing more effectively with environmental conditions and thus increases their chances of survival.

Martin Covington (1992, 2004) has proposed that *protecting* one's sense of competence—something he calls **self-worth**—is one of people's highest priorities (also see Mezulis, Abramson, Hyde, & Hankin, 2004; Sedikides & Gregg, 2008; T. D. Wilson & Gilbert, 2008). Obviously, achieving success on a regular basis is one way of maintaining or even enhancing self-worth. But consistent success isn't always possible, especially when people face challenging tasks. In such situations, an alternative way to maintain self-worth is to *avoid failure*, because failure gives the impression of low ability (Covington, 1992; Covington & Müeller, 2001; Urdan & Midgley, 2001). Failure avoidance manifests itself in a variety of ways; for instance, people may refuse to engage in an activity, downplay its importance, set and communicate low self-expectations for performance, or refuse to abandon existing beliefs in the face of considerable contradictory evidence<sup>3</sup> (Covington, 1992; Harter, 1990; A. J. Martin, Marsh, & Debus, 2001; Rhodewalt & Vohs, 2005; D. K. Sherman & Cohen, 2002).

In some situations, however, people can't avoid tasks at which they expect to do poorly and so use alternative strategies to protect their self-worth. Sometimes they make excuses that seemingly justify their poor performance (Covington, 1992; Urdan & Midgley, 2001; T. D. Wilson & Gilbert, 2008). Yet they may also do things that actually *undermine* their chances of success—a phenomenon known as **self-handicapping**. Self-handicapping takes a variety of forms, including these:

- *Setting unattainably high goals*: Working toward goals that even the most able individuals couldn't achieve
- *Taking on too much*: Assuming so many responsibilities that no one could possibly accomplish them all
- *Creating impediments*: Concocting obstructions or additional requirements that make a task almost impossible to accomplish
- *Procrastinating*: Putting a task off until success is virtually impossible
- *Reducing effort*: Putting forth an obviously insufficient amount of effort to succeed

---

<sup>3</sup>Hence, the need to protect one's self-worth may be one reason that people don't undergo *conceptual change*.

- *Cheating in class*: Presenting others' work as one's own
- *Using alcohol or drugs*: Taking substances that will inevitably reduce performance (E. M. Anderman, Griesinger, & Westerfield, 1998; Covington, 1992; Hattie, 2008; E. E. Jones & Berglas, 1978; Rhodewalt & Vohs, 2005; Riggs, 1992; Urdan, Ryan, Anderman, & Gheen, 2002; Wolters, 2003a)

It might seem paradoxical that people who want to be successful would engage in such behaviors. But if people believe they're unlikely to succeed at a particular task, they increase their chances of *justifying* their failure—and therefore they maintain self-worth—by acknowledging that under the circumstances, success wasn't very likely to begin with. Curiously, some people are more likely to perform at their best and less likely to display self-handicapping behaviors when their chances of success are slim or when a task is in a seemingly unimportant domain (Covington, 1992; Urdan et al., 2002). In such situations failure isn't interpreted as indicating low ability and so doesn't threaten people's sense of self-worth.

To date, most research on self-worth theory and self-handicapping has focused on academic tasks and accomplishments. Some theorists suggest, however, that academic achievement isn't always the most important thing affecting people's sense of self-worth; for many people, such factors as social success or physical appearance may be more influential (Harter, 1999; L. E. Park & Maner, 2009). Also troubling is the finding that people sometimes seem more comfortable maintaining *consistent* self-perceptions, even if those self-perceptions are negative ones (Hattie, 2008; Hay, Ashman, van Kraayenoord, & Stewart, 1999). Yet in most instances, positive self-perceptions do appear to be a high priority.

On average, young people's sense of competence, self-worth, and general sense of self become increasingly stable as they grow older (D. A. Cole et al., 2001; Harter, 1999; Wigfield, Byrnes, & Eccles, 2006). Generally speaking, this stability is a good thing, in that it enables learners to take their occasional failures in stride (Heppner et al., 2008).<sup>4</sup> When learners instead base their self-worth largely on their immediate successes and failures—a phenomenon known as **contingent self-worth**—they can be on an emotional roller coaster, feeling competent one day and inadequate the next (Assor, Roth, & Deci, 2004; Crocker, Karpinski, Quinn, & Chase, 2003; Dweck, 2000; Smiley, Coulson, Greene, & Bono, 2010).

**Revisiting self-efficacy** On the surface, the concepts of competence and self-worth are similar to the concept of *self-efficacy* we examined in Chapter 6. In theory, however, there are two key differences between the needs for competence and self-worth, on the one hand, and self-efficacy, on the other. First, in line with our discussion here, having a sense of competence and self-worth may be a basic human need. In contrast, social cognitive theorists have suggested that self-efficacy is certainly a *good* thing, but they don't go so far as to speculate that it's an essential driving force of human nature. Second, competence and self-worth have been conceived as being fairly general, overarching self-perceptions—that is, what you think about yourself overall—whereas self-efficacy is more task specific.

But now let's muddy the waters a bit. To some degree, how competent you think you are overall is apt to affect the confidence with which you approach a particular task, and how self-efficacious you feel about performing a task is apt to contribute in some way to your overall sense of competence and self-worth (Bong & Skaalvik, 2003; Schunk & Pajares, 2005). Furthermore, in my own reading of the motivation literature, I find that theorists sometimes use

<sup>4</sup>This idea should remind you of social cognitivists' concept of resilient self-efficacy (see Chapter 6).

the term *sense of competence* (or something similar) when talking about fairly specific tasks or situations, and they sometimes use the term *self-efficacy* to refer to a fairly general self-perception (e.g., Bandura, 1997).

One point on which many researchers agree is that one's sense of confidence—both about accomplishing specific tasks and about dealing with life in general—is an important variable influencing motivation, especially *intrinsic motivation*. Conversely, feelings of incompetence lead to decreased motivation and engagement (Boggiano & Pittman, 1992; Harter et al., 1992; Mac Iver, Stipek, & Daniels, 1991; Reeve et al., 2004; R. M. Ryan & Deci, 2000; E. Skinner, Furrer, Marchand, & Kindermann, 2008).

When we discussed self-efficacy in Chapter 6, we identified several variables that help learners believe they can succeed at a task, including encouraging messages, the successes of peers, and, most importantly, their *own* successes (either individually or as part of a group) at a task or activity. The last of these—actual successes—are, of course, the most powerful. Sometimes learners' successes are obvious; winning a bicycle race and constructing a sturdy bookcase from a set of instructions are examples. But many others aren't so clear-cut, and in such instances feedback is often helpful. Curiously, even class grades and other extrinsic reinforcers can promote *intrinsic* motivation to the extent that they signal successful performance and therefore enhance learners' self-efficacy and overall sense of competence (Cameron, 2001; Deci & Moller, 2005; Hynd, 2003; Schunk & Zimmerman, 1997).

## Self-Determination

Not only do people want to feel competent, it appears that they also have a basic need for **self-determination**: They want to have some sense of *autonomy* regarding the things they do and the directions their lives take. For instance, when we think “I *want* to do this” or “I would *find it valuable* to do that,” we have a high sense of self-determination. In contrast, when we think “I *have to*” or “I *should*,” we're telling ourselves that someone or something else is making decisions for us. Even toddlers sometimes resist adults' efforts to control their behaviors, leading some parents to refer to toddlerhood as the “terrible twos” (d'Ailly, 2003; deCharms, 1972; Deci & Ryan, 1992; Dix, Stewart, Gershoff, & Day, 2007; Reeve et al., 2004; R. M. Ryan & Deci, 2000; Vansteenkiste, Zhou, Lens, & Soenens, 2005).

Some motivation theorists have proposed that learners are more likely to be intrinsically motivated when they have a sense of self-determination about their present circumstances. For example, when current conditions and events confirm learners' feelings of self-determination, learners are likely to

- Experience pleasure in activities, and voluntarily engage in them for long periods
- Think meaningfully and creatively about tasks and problems
- Undertake challenges that maximize long-term learning and development
- Achieve at high levels
- Stay in school rather than dropping out (Amabile & Hennessey, 1992; Deci, 1992; Deci & Ryan, 1985, 1987; Hagger, Chatzisarantis, Barkoukis, Wang, & Baranowski, 2005; Hardré & Reeve, 2003; Reeve et al., 2004; Standage, Duda, & Ntoumanis, 2003; Vansteenkiste, Lens, & Deci, 2006)

In contrast, when environmental circumstances and events lead people to conclude that they have little involvement in determining the course of their lives, they may comply with external demands but are unlikely to have much intrinsic motivation—and thus unlikely to work very

hard at what they're doing. Often, too, they may feel bored or depressed and have a diminished sense of self-worth (Deci & Ryan, 1987; Pekrun et al., 2010; E. Skinner et al., 2008; Vansteenkiste et al., 2006).

Several variables appear to influence people's sense of self-determination one way or the other, as we'll see now.

**Choices** Let's return to a point I made in Chapter 5: Children and adults alike seem to prefer having some choice in the reinforcers for which they work. From the perspective of self-determination, this finding makes perfect sense. In general, people have a greater sense of self-determination—and so are more intrinsically motivated—when they're able to make choices, within reasonable limits, about the things they do and the outcomes for which they'll work (Deci & Ryan, 1992; Morgan, 1984; Patall, Cooper, & Wynn, 2010). For example, when students have legitimate choices about the activities in which they engage, they show greater interest and involvement in their schoolwork, and they display fewer off-task behaviors (Dunlap et al., 1994; Foster-Johnson, Ferro, & Dunlap, 1994; Morgan, 1984; Patall et al., 2010; Powell & Nelson, 1997; Vaughn & Horner, 1997).

We must qualify the effects of choices in a couple of ways, however. First, choices are likely to enhance one's sense of self-determination only if they're *real* choices—that is, if they truly allow a selection among two or more possible courses of action. Choices have little effect on motivation when they're highly constrained—say, when a teacher gives students a “choice” between two or three unappealing tasks (Reeve, Nix, & Hamm, 2003; Stefanou, Perencevich, DiCintio, & Turner, 2004). Second, cultural differences have been observed in the importance of choices. In particular, although many American children find choice-making opportunities highly motivating, children from Asian American families often prefer that people they trust make the choices for them (Bao & Lam, 2008; Iyengar & Lepper, 1999). Perhaps the latter see trusted others as people who can make *wise* choices—choices that will ultimately lead to higher levels of learning and competence.

**Threats and deadlines** Threats (e.g., “Do this or else!”) and deadlines (e.g., “This is due by January 15—no exceptions!”) are typically experienced as controlling one's behaviors. As a result, they reduce self-determination and intrinsic motivation (Deci & Ryan, 1987; Reeve, 2009).

**Controlling statements** Some of the things people say to us—even though they aren't threatening—nevertheless convey the message that others control our fate and so can undermine our sense of self-determination (Amabile & Hennessey, 1992; Boggiano, Main, & Katz, 1988; Reeve, 2009). For example, in one experiment (Koestner, Ryan, Bernieri, & Holt, 1984), first and second graders were asked to paint a picture of a house in which they'd like to live. The children were given the materials they needed—a paintbrush, a set of watercolor paints, two sheets of paper, and several paper towels—and then told some rules about how to proceed. For some children (the controlling-limits condition), restrictions described things they could and couldn't do, as follows:

Before you begin, I want to tell you some things that you will have to do. They are rules that we have about painting. You have to keep the paints clean. You can paint only on this small sheet of paper, so don't spill any paint on the big sheet. And you must wash out your brush and wipe it with a paper towel before you switch to a new color of paint, so that you don't get the colors all mixed up. In general, I want you to be a good boy (girl) and don't make a mess with the paints. (Koestner et al., 1984, p. 239)

For other children (the informational-limits condition), restrictions were presented only as information, like this:

Before you begin, I want to tell you some things about the way painting is done here. I know that sometimes it's really fun to just slop the paint around, but here the materials and room need to be kept nice for the other children who will use them. The smaller sheet is for you to paint on, the larger sheet is a border to be kept clean. Also, the paints need to be kept clean, so the brush is to be washed and wiped in the paper towel before switching colors. I know that some kids don't like to be neat all the time, but now is a time for being neat. (Koestner et al., 1984, p. 239)

Each child was given 10 minutes of painting time. The experimenter then took the child's painting to another room, saying he would return in a few minutes. As he left, he put two more sheets of paper on the child's table, saying, "You can paint some more on this piece of paper if you like, or, if you want, you can play with the puzzles over on that table." In the experimenter's absence, the child was surreptitiously observed, and painting time was measured. Children in the informational-limits condition spent more time painting—and so were apparently more intrinsically motivated to paint—and their paintings were judged to be more creative than was true for their counterparts in the controlling-limits condition.

**Extrinsic rewards** In Chapter 5, I expressed the concern that using extrinsic reinforcement may undermine the intrinsic reinforcement that an activity provides. Extrinsic reinforcers are most likely to have this adverse effect when people perceive them as controlling or manipulating their behavior rather than as providing information about their progress.<sup>5</sup> Thus, they're unlikely to be beneficial, at least over the long run, if people interpret them as bribes or limits on their freedom (Deci, Koestner, & Ryan, 2001; Lepper & Hodell, 1989; Reeve, 2006; R. M. Ryan, Mims, & Koestner, 1983). This principle may, in part, be the result of the message that an external reward communicates: that a task isn't worth doing for its own sake (B. A. Hennessey, 1995).

A reward for desirable behavior appears to have *no* adverse effects when learners interpret it as communicating that they're skillful or in some other way have *competence* (Cameron & Pierce, 2005; Cameron, Pierce, Banko, & Gear, 2005; Reeve et al., 2004). Nor does it undermine intrinsic motivation when it's unexpected—for instance, when scientists win the Nobel Prize for groundbreaking research findings—or when it's not contingent on specific behaviors (Cameron, 2001; Deci et al., 2001; Reeve, 2006).<sup>6</sup>

**Surveillance and evaluation** People who think or know their performance will be evaluated have a lower sense of self-determination and, as a result, are less intrinsically motivated. This is especially likely to be the case when the task at hand is a difficult one (Deci & Ryan, 1992; Harter et al., 1992; B. A. Hennessey, 1995; Reeve et al., 2004). In fact, the mere presence of a potential evaluator is apt to undermine intrinsic motivation (Deci & Ryan, 1987). For example,

<sup>5</sup>To my knowledge, theorists haven't specifically talked about the informational or controlling messages that *punishment* might communicate, but we can logically deduce that a similar pattern exists here as well. Certainly punishment can be presented in either of two ways—as a means of control or as a source of information about appropriate behavior. As we discovered in Chapter 5, punishment is more effective when it's accompanied by reasons (information) about why the punished behavior is unacceptable.

<sup>6</sup>A potential downside of noncontingent reinforcement is that it may in some cases lead to superstitious behavior (see Chapter 4).

Feelings of self-determination and intrinsic motivation are often greater when potential evaluators are absent from the scene.



even though I have a mediocre singing voice, I like to sing and will often do so when no one else is around to hear me (e.g., when I'm mowing the lawn or driving alone on business). But my intrinsic motivation to sing vanishes when anyone else is in earshot.

In Chapter 11, we discovered that formal classroom assessments (e.g., assignments and tests) often promote effective long-term memory storage. Among other things, they encourage students to review classroom material more regularly and process information more thoroughly. But here we see a disadvantage of formal assessments: They may undermine students' intrinsic motivation to learn (Grolnick & Ryan, 1987; Hatano & Inagaki, 2003; L. Shepard, Hammerness, Darling-Hammond, & Rust, 2005). For example, in one study (Benware & Deci, 1984), college students studied an article about brain functioning under either of two conditions: Some studied it with the expectation of being tested on it, while others studied it with the expectation that they would have to teach the material to someone else (a presumably nonevaluative situation). Compared with their counterparts in the testing group, students in the teaching group enjoyed their learning experience more, found the material more interesting, and engaged in more meaningful (rather than rote) learning. Similar results have been found with fifth graders (Grolnick & Ryan, 1987).

We should keep in mind that no amount of self-determination is going to make us feel intrinsically motivated to do something if we don't also have a sense of competence. As an illustration, let's consider a study with seventh graders who varied in their beliefs about their writing competence (Spaulding, 1992, pp. 54–55). All the students were asked to write an essay concerning what they'd learned in English class that year. Some students were asked to write it for their teacher, someone they believed would evaluate their work; hence, this group experienced low self-determination. Other students were asked to write the essay for the researcher so that she could tell future teachers what kinds of things students study in English; without the threat of evaluation looming over them, these students presumably experienced relatively high self-determination. Students who believed themselves to be competent writers showed greater task engagement and intrinsic motivation in the high self-determination condition—that is, when writing for the researcher. In contrast, students who believed they were poor writers were more



engaged in the task when writing for the teacher. Apparently, self-determination in the absence of perceived competence didn't promote intrinsic motivation.<sup>7</sup>

### ***Putting a Positive Spin on Controlling Circumstances***

Sometimes people respond to circumstances beyond their control by identifying ways to take charge of aspects of their lives despite existing constraints on their freedom. Because they can't change their environment, they instead change *themselves* to better adapt to it—a phenomenon known as **secondary control** (N. C. Hall, Chipperfield, Perry, Ruthig, & Goetz, 2006; N. C. Hall, Goetz, Haynes, Stupnisky, & Chipperfield, 2006; Rothbaum, Weisz, & Snyder, 1982).

One common secondary-control strategy is to reinterpret an aversive event as something that can ultimately work in one's best interest—that is, to invoke the adage “Every cloud has a silver lining.” Another is to take proactive steps to improve one's circumstances and, in the process, gain more control. For example, a college student might interpret a low grade on a difficult exam as a “wake-up call” to study harder or seek extra help. Parents of a child with a mental disability might become active, productive members of organizations such as the Autism Society of America or the National Alliance for the Mentally Ill. In part by helping people maintain their sense of self-determination, secondary control strategies enhance motivation to achieve at school and elsewhere, as well as psychological well-being more generally (J. E. Bower, Moskowitz, & Epel, 2009; N. C. Hall, Chipperfield, et al., 2006; N. C. Hall, Perry, Ruthig, Hladkyj, & Chipperfield, 2006).

## **Relatedness**

To some extent, we're all social creatures: We live, work, and play with our fellow human beings. Some theorists have proposed that people of all ages have a fundamental need to feel socially connected and to secure the love and respect of others. In other words, people have a **need for relatedness** (Connell & Wellborn, 1991; A. P. Fiske & Fiske, 2007; A. J. Martin & Dowson, 2009; Reeve et al., 2004; R. M. Ryan & Deci, 2000). As is true for the need for competence, the need for relatedness may be important from an evolutionary standpoint: People who live in cohesive, cooperative social groups are more likely to survive than people who go it alone (Wright, 1994).

In the classroom, students' need for relatedness may manifest itself in a variety of behaviors. Many children and adolescents place high priority on interacting with friends, sometimes at the expense of completing schoolwork (Dowson & McInerney, 2001; Doyle, 1986; Wigfield, Eccles, Mac Iver, Reuman, & Midgley, 1991). They may also be concerned about projecting a favorable public image—that is, by looking smart, popular, athletic, or cool (Juvonen, 2000). And some may exhibit their need for relatedness by showing concern for other people's welfare or helping peers who are struggling with classroom assignments (Dowson & McInerney, 2001; Ford, 1996). The need for relatedness seems to be especially high in the middle school years (B. B. Brown, Eicher, & Petrie, 1986; Juvonen, 2000; A. M. Ryan & Patrick, 2001). Young adolescents tend to be overly concerned about what others think, prefer to hang out in tight-knit groups, and are especially susceptible to peer influence.

---

<sup>7</sup>Using different terminology, social cognitive theorists also talk about the interplay between competence and self-determination. In particular, when people have a high sense of *self-efficacy* and good *self-regulation* skills, they gain an increasing sense of *personal agency* (Bandura, 2008; Schunk & Zimmerman, 2006; Zimmerman, 2010).

People seem to be more intrinsically motivated to accomplish new tasks when their need for relatedness has been addressed. For instance, students are more eager to engage in classroom activities and master academic subject matter when they believe their teachers truly care about them and will support them in their efforts to learn (H. A. Davis, 2003; Furrer & Skinner, 2003; Roeser, Eccles, & Sameroff, 2000). Students' motivation in the classroom also increases when their classmates support them in their learning (see Chapter 13, especially the discussion of *communities of learners*). Other people's love and respect can enhance learners' intrinsic motivation indirectly as well as directly—in particular, by communicating high expectations for performance and in other ways boosting an overall sense of competence and self-worth (L. H. Anderman, Patrick, Hrudá, & Linnenbrink, 2002; Newberg & Sims, 1996; Patrick, Anderman, & Ryan, 2002).

Occasionally the need for relatedness conflicts with the need for self-determination. If people want to gain the approval of others (which can enhance their feelings of interpersonal connectedness), they might occasionally have to comply with others' expectations or demands (which reduces their sense of autonomy). In cultures that especially value conformity and commitment to group (rather than individual) achievement—as is true in many Asian cultures—people typically place higher priority on relatedness than on self-determination. To some extent they may invoke that positive spin I spoke of earlier, acknowledging that conforming with others' wishes and goals contributes to the greater good of society as a whole (Heine, 2007; Rothbaum & Trommsdorff, 2007; Savani, Markus, Naidu, Kumar, & Berlia, 2010).

In Chapter 17, the need for relatedness will show up in our discussions of *performance goals*, *social goals*, and *image management*. Yet although the need for relatedness may to some extent be a universal phenomenon, some people seem to have a greater need for interpersonal relationships than others (Kupersmidt, Buchele, Voegler, & Sedikides, 1996). In the next section, we'll look at these and other individual differences in motivation.

## INDIVIDUAL DIFFERENCES IN MOTIVATION

---

Up to this point we've been talking about needs that probably characterize all of us. But some theorists suggest that motivation can also involve relatively enduring personality characteristics that people have to a greater or lesser extent. For example, I mentioned earlier that some people tend to be sensation seekers, whereas others prefer not to live so much on the edge. Theories that propose fairly stable individual differences in motivation are known as **trait theories**.

Historically, researchers have focused considerable attention on individual differences in people's needs for affiliation, approval, and achievement. In recent years they've also begun to look in depth at dispositions that predispose people to think or learn in particular ways. We'll look at these four individual difference variables here and then, in Chapter 17, identify additional individual differences as we consider such topics as interest, goals, and attributions.

### Need for Affiliation

The **need for affiliation** is the degree to which a person wants and needs friendly relationships with others (Boyatzis, 1973; Connell & Wellborn, 1991; C. A. Hill, 1987; D. C. McClelland, 1984). For example, as high school students, my oldest two children couldn't stand the thought of being home "alone" (i.e., with their parents) on weekend nights and so almost always found something to do with their friends. When they were home on weeknights, they spent long

hours talking to friends on the phone, to the point that schoolwork sometimes didn't get done. In contrast, my youngest child, Jeff, was always able to work or play alone quite happily for hours at a time.

Students' needs for affiliation are often reflected in the choices they make at school (Boyatzis, 1973; French, 1956; Sansone & Smith, 2002; Wigfield, Eccles, & Pintrich, 1996). For example, students with a low need for affiliation may prefer to work alone, whereas students with a high need for affiliation more often prefer to work in small groups. When choosing work partners, students with a low affiliation need are apt to choose classmates whom they believe will be competent at an assigned task; students with a high affiliation need are apt to choose their friends even if these friends are relatively incompetent. In high school, students with a low need for affiliation are likely to choose a class schedule that meets their own interests and ambitions, whereas students with a high need for affiliation tend to choose one that enables them to be with their friends. As you can see, then, a high need for affiliation can sometimes interfere with maximal classroom learning and achievement (Urdan & Maehr, 1995; Wentzel & Wigfield, 1998).

## Need for Approval

Another need in which we see individual differences is the **need for approval**, a desire to gain the acceptance and positive judgments of other people (M. Bartlett, Rudolph, Flynn, Abaied, & Koerber, 2007; Boyatzis, 1973; Crowne & Marlowe, 1964; Urdan & Maehr, 1995). Many elementary school students have a strong desire to attain the approval of their teacher; at the secondary level, students are more inclined to seek the approval of peers (Harter, 1999; Juvonen & Weiner, 1993; Urdan & Maehr, 1995).

People with a high need for approval are often those with low self-esteem. They may go out of their way to behave in ways they think will please others, sometimes compromising their own standards for appropriate behavior. They're apt to engage in and persist at school tasks primarily to gain praise, and they may self-handicap in activities at which they expect to do poorly. Especially in adolescence, students with a high need for approval give in easily to peer pressure, for fear that they might otherwise be rejected. Such efforts are often counterproductive: Perhaps because they're trying *too* hard to be liked, students with a high need for approval tend to be relatively unpopular with peers and are often the victims of bullying (M. Bartlett et al., 2007; Berndt & Keefe, 1996; Boyatzis, 1973; Crowne & Marlowe, 1964; H. A. Davis, 2003; S. C. Rose & Thornburg, 1984; Wentzel & Wigfield, 1998).

Some adolescents may be so preoccupied with peer approval that they base their own sense of self-worth largely on what their peers think of them—or at least on what *they think* their peers think of them (Dweck, 2000; Harter, 1999; Harter, Stocker, & Robinson, 1996). Teenagers who have such socially based contingent self-worth may exhibit significant mood swings, depending on how peers have recently treated them (Burwell & Shirk, 2009; Larson, Clore, & Wood, 1999).

## Need for Achievement

The **need for achievement**, sometimes called **achievement motivation**, is the need for excellence for its own sake, without regard for any external rewards one's accomplishments might bring (J. W. Atkinson, 1957, 1964; J. W. Atkinson & Feather, 1966; D. C. McClelland,

Atkinson, Clark, & Lowell, 1953; Vernon, 1969; Veroff, McClelland, & Ruhland, 1975). For example, a person with a high need for achievement might work diligently to maintain a 4.0 grade point average, practice long hours to become a professional basketball player, or play Monopoly with a vengeance.

People with a high need for achievement are realistic about the tasks they can accomplish, and they persist at tasks that are challenging yet achievable. They rarely rest on their laurels; instead, they set increasingly high standards for excellence as their current standards are met. And they're willing and able to delay gratification: They put off small, immediate rewards for the larger rewards their long-term efforts are likely to bring (French, 1955; Vernon, 1969; Veroff et al., 1975).

An early and widely cited theory of achievement motivation is that of John Atkinson and his associates (e.g., J. W. Atkinson & Birch, 1978; J. W. Atkinson & Feather, 1966; J. W. Atkinson & Raynor, 1978; also see Covington & Omelich, 1991). These theorists proposed that the tendency to strive for achievement is a function of two related needs: the **motive for success**, or  $M_s$  (the desire to do well and accomplish goals), and the **motive to avoid failure**, or  $M_{af}$  (anxiety about failing to accomplish goals and reluctance to engage in activities that may lead to failure). For many people, one of these needs is stronger than the other, and achievement behavior depends on which need predominates.

Individuals with a stronger motive for success tend to seek and tackle moderately difficult tasks—those that are challenging yet realistically accomplishable—without worrying about mistakes they might make or stumbling blocks they might encounter. In contrast, individuals with a stronger motive to avoid failure typically forgo such risks in favor of a sure thing. Given a choice, they often select easy tasks at which they'll almost certainly be successful. Curiously, though, high  $M_{af}$  individuals occasionally choose extremely difficult tasks—those at which they can't possibly succeed. When they fail at such tasks, they have a built-in explanation—after all, the task was impossible—and so they can easily rationalize the failure. This tendency to choose impossibly difficult tasks should remind you of the self-handicapping phenomenon described earlier.

In a classic study demonstrating such tendencies (J. W. Atkinson & Litwin, 1960), male college students completed a test that enabled the researchers to categorize them as being either high  $M_s$  or high  $M_{af}$ . The students then played a ring toss game, throwing circular objects in an effort to land them around an upright peg. They were told that they could stand wherever they wished, within a 15-foot range, as they attempted to throw 10 rings, one at a time, around the peg. The great majority of high  $M_s$  students opted to stand about 8 to 12 feet away from the peg (thus taking on a moderate challenge). Of the high  $M_{af}$  students, only half stood in the 8- to 12-foot range; the other half stood either within 7 feet of the peg (thus making the task an easy one) or at least 13 feet away from it (thus making it extremely difficult). Isaacson (1964) found the same pattern in the course selections of college students: Those with a higher  $M_s$  tended to choose classes of moderate difficulty, whereas those with a higher  $M_{af}$  chose either very easy or very difficult classes.

In its earliest conceptualization, the need for achievement was thought to be a general trait that people exhibit consistently in a variety of activities across many domains. More recently, however, many theorists have proposed that this need may instead be somewhat specific to particular tasks and environments. Most contemporary psychologists now think of achievement motivation as reflecting specific *achievement goals*, as we'll discover in Chapter 17.

## Dispositions

A **disposition** is a general, relatively stable inclination to approach learning and problem-solving situations in a particular way.<sup>8</sup> Dispositions are intentional rather than accidental, and they encompass cognition, motivation, and personality characteristics. Following are examples of productive dispositions theorists have identified:

- *Stimulation seeking*: Eagerly interacting with one's physical and social environment in order to encounter new experiences and information
- *Need for cognition*: Regularly seeking and engaging in challenging cognitive tasks
- *Epistemic curiosity*: Eagerly seeking knowledge about a wide range of topics
- *Conscientiousness*: Consistently addressing assigned tasks in a careful, focused, and responsible manner
- *Learned industriousness*: Persisting and persevering even when considerable effort is required
- *Open-mindedness*: Flexibly considering alternative perspectives and multiple sources of evidence, and suspending judgment for a time rather than leaping to immediate conclusions<sup>9</sup>
- *Critical thinking*: Consistently evaluating information or arguments in terms of their accuracy, logic, and credibility, rather than accepting them at face value
- *Consensus seeking*: Seeking a synthesis of diverse perspectives, rather than assuming that perspectives must necessarily be mutually exclusive
- *Future time perspective*: Predicting and considering the long-term consequences of various courses of action (Bembenutty & Karabenick, 2004; Cacioppo, Petty, Feinstein, & Jarvis, 1996; DeBacker & Crowson, 2009; Eccles, Wigfield, & Schiefele, 1998; Eisenberger, 1992; Giancarlo & Facione, 2001; Halpern, 2008; Hampson, 2008; Husman & Freeman, 1999; M. J. Kang et al., 2009; Kardash & Scholes, 1996; Onosko & Newmann, 1994; Raine, Reynolds, & Venables, 2002; Simons, Vansteenkiste, Lens, & Lacante, 2004; Southerland & Sinatra, 2003; Stanovich, 1999; Toplak & Stanovich, 2002; Trautwein, Lüdtke, Schnyder, & Niggli, 2006; West, Toplak, & Stanovich, 2008; J. S. Wiggins, 1996)

Such dispositions are often positively correlated with students' learning and achievement, and many theorists have suggested that they play a causal role in what and how much students learn. In fact, dispositions sometimes overrule intelligence in their influence on long-term achievement (Dai & Sternberg, 2004; D. Kuhn & Franklin, 2006; Perkins & Ritchhart, 2004). For instance, children who eagerly seek out physical and social stimulation as preschoolers later become better readers and earn higher grades in school (Raine et al., 2002). Adolescents who are conscientious are more self-regulating; for instance, they're more likely to do their homework (Hampson, 2008; Trautwein, Lüdtke, Kastens, & Köller, 2006). People who have a strong future time perspective are more motivated to engage in activities that will help them achieve their

---

<sup>8</sup>Theorists are addressing a similar idea when they talk about *habits of mind*.

<sup>9</sup>Open-mindedness can be contrasted with a *need for closure*, whereby learners strive to draw rapid conclusions about what is and isn't true. Learners with a need for closure tend to have relatively unsophisticated epistemic beliefs (e.g., knowledge is an accumulation of facts that can best be obtained from authority figures) and to process information in relatively superficial ways (DeBacker & Crowson, 2006, 2009; Kruglanski & Webster, 1996).

future goals (Bembenutty & Karabenick, 2004; Husman & Freeman, 1999; Simons et al., 2004). People with a high need for cognition learn more from what they read and are more likely to base conclusions on sound evidence and logical reasoning (Cacioppo et al., 1996; Dai, 2002; P. K. Murphy & Mason, 2006). People who critically evaluate new evidence and are receptive to and open-minded about diverse perspectives show more advanced reasoning capabilities; they're also more likely to undergo conceptual change when warranted (Matthews, Zeidner, & Roberts, 2006; Southerland & Sinatra, 2003).

Researchers haven't yet systematically addressed the origins of various dispositions. Perhaps inherited temperamental differences (e.g., in stimulation seeking) are involved (Raine et al., 2002). Epistemic beliefs—for instance, the belief that knowledge is fixed and unchanging, on the one hand, or dynamic and continually evolving, on the other—may also play a role (P. M. King & Kitchener, 2002; D. Kuhn, 2001b; Mason, 2003; Schommer-Aikins, Hopkins, Anderson, & Drouhard, 2005). And quite possibly teachers' actions in the classroom—for instance, whether they encourage inquisitive exploration, risk taking, and critical thinking with respect to classroom topics—make a difference (DeBacker & Crowson, 2009; Flum & Kaplan, 2006; D. Kuhn, 2001b, 2006). In the following classroom interaction, a teacher actually seems to *discourage* any disposition to think analytically and critically about classroom material:

Teacher: Write this on your paper . . . it's simply memorizing this pattern. We have meters, centimeters, and millimeters. Let's say . . . write millimeters, centimeters, and meters. We want to make sure that our metric measurement is the same. If I gave you this decimal, let's say .234 m (yes, write that). In order to come up with .234 m in centimeters, the only thing that is necessary is that you move the decimal. How do we move the decimal? You move it to the right two places. (Jason, sit up please.) If I move it to the right two places, what should .234 m look like, Daniel, in centimeters? What does it look like, Ashley?

Ashley: 23.4 cm.

Teacher: Twenty-three point four. Simple stuff. In order to find meters, we're still moving that decimal to the right, but this time, boys and girls, we're only going to move it one place. So, if I move this decimal one place, what is my answer for millimeters? (dialogue from J. C. Turner et al., 1998, p. 741)

Undoubtedly, this teacher means well: She wants her students to know how to convert from one unit of measurement to another. But notice the attitude she engenders: "Write this . . . it's simply memorizing this pattern."

## AFFECT AND ITS EFFECTS

---

A close partner of motivation is **affect**—the feelings, emotions, and general moods that a learner brings to bear on a task.<sup>10</sup> For example, earlier in the chapter we noted that intrinsically motivated individuals typically find pleasure in what they're doing. Yet too much

<sup>10</sup>Some theorists use the terms *affect* and *emotion* almost interchangeably. But others suggest that we use *emotion* to refer only to short-term states and *affect* in a broader sense to include both short-term states and longer-term moods and predispositions (Forgas, 2000; Linnenbrink & Pintrich, 2002; Rosenberg, 1998).

motivation—perhaps wanting something too much—can lead to anxiety and other unpleasant emotions. Pleasure, anxiety, excitement, pride, depression, anger, guilt, boredom—all of these are forms of affect.

Affect often has measurable physiological correlates, such as changes in blood pressure, heart rate, muscular tension, and general energy level. And it's interrelated with motivation, learning, and cognition in a variety of ways, as we'll see now.

## How Affect Is Related to Motivation

From an evolutionary perspective, the brain's immediate emotional responses to certain events—fearfully darting beyond striking range of a poisonous snake, say, or responding angrily to a neighbor who threatens violence—have helped human beings survive and thrive over the centuries (Damasio, 1994; Öhman & Mineka, 2003). But affect plays a role in the planful, thoughtful aspects of human motivation as well. In general, how people feel depends on whether their needs are being met and their goals are being accomplished (E. M. Anderman & Wolters, 2006; Goetz, Frenzel, Hall, & Pekrun, 2008; A. J. Martin & Dowson, 2009). People also consider how they're apt to feel later on—in particular, how good a success will feel (e.g., making them happy or proud) and how bad a failure will feel (e.g., making them sad or ashamed)—when deciding what activities to pursue (Mellers & McGraw, 2001).

Some emotions, known as **self-conscious emotions**, are closely tied to people's self-assessments and thus are intertwined with their sense of self-worth (M. Lewis & Sullivan, 2005; Pekrun, 2006). When people evaluate their behaviors and accomplishments as being consistent with their culture's standards for appropriate and desirable behavior, they're apt to feel pride. When, in contrast, they see themselves as failing to live up to those standards—for instance, when they thoughtlessly cause harm to someone else—they're apt to feel guilt and shame.

Occasionally, unpleasant emotions work to one's advantage; for instance, shame can spur a person to address current shortcomings, and anger about an injustice or unfair treatment can mobilize a person to make things right (Eid & Diener, 2001; Tamir, 2009). As a general rule, however, people act in ways that help them feel happy and comfortable rather than sad, confused, or angry (Isaacowitz, 2006; Tsai, 2007). *How* happy and comfortable they want to feel is to some degree a cultural matter. On average, people in European and North American cultures like a highly aroused yet pleasant affective state—for instance, a feeling of excitement—whereas people in Asian cultures prefer a more sedate, peaceful state (Mesquita & Leu, 2007; Tsai, 2007).

When learners are in a good mood during instruction, they're more likely to cognitively engage with new material and work hard to make sense of it (Linnenbrink & Pintrich, 2004; Pekrun, Goetz, Titz, & Perry, 2002). But as they study, they may occasionally encounter ideas that conflict with their current beliefs. Such discrepancies can cause considerable mental discomfort—a state of affairs that Piaget called *disequilibrium* but many contemporary theorists call **cognitive dissonance**. This dissonance typically motivates learners to try to resolve the discrepancies in some way—perhaps revising existing beliefs (thus undergoing *conceptual change*) or perhaps ignoring or discrediting the new information—so that they can return to a more contented frame of mind (Harmon-Jones, 2001; Marcus, 2008; Pintrich et al., 1993; Sinatra & Mason, 2008).

## How Affect Is Related to Learning and Cognition

Historically, a significant weakness of cognitivist and social-cognitive perspectives of learning has been their general disregard for the affective aspects of mental processes (Dai, 2005; Hidi, Renninger, & Krapp, 2004; Pintrich, 2003). Yet affect is clearly intermingled with learning and cognition. For example, while learning how to perform a task, we simultaneously learn whether we like doing it (Goetz et al., 2008; Zajonc, 1980). Problem solving is easier when we enjoy what we're doing, and successful attempts at learning and problem solving often bring on feelings of excitement, pleasure, and pride (E. M. Anderman & Wolters, 2006; C. S. Carver & Scheier, 1990; Pekrun, 2006; Shernoff & Csikszentmihalyi, 2009). Our failed attempts at a task are apt to make us feel frustrated or anxious, especially if the task is an easy one, and we're apt to develop a dislike for the task (C. S. Carver & Scheier, 1990; Shepperd & McNulty, 2002; Stodolsky, Salk, & Glaessner, 1991).

As we're thinking about, learning, or remembering something, our very thoughts and memories may have emotional overtones—a phenomenon known as **hot cognition**. Often the nature of the material we're trying to learn induces hot cognition and, as a result, affects cognitive processing. When information is emotionally charged, we're more likely to pay attention to it (Edwards & Bryan, 1997; Phelps, Ling, & Carrasco, 2006). We're also more likely to continue to think about it and repeatedly elaborate on it (G. H. Bower, 1994; Heuer & Reisberg, 1992; D. J. Siegel, 1999). Yet our ability to draw inferences from it and respond appropriately to it is sometimes hampered, at least in comparison with our ability to think logically about nonemotional topics (Blanchette & Richards, 2004; Damasio, 1994; Marcus, 2008).

The emotional nature of what we've stored in long-term memory may influence our ability to retrieve it later on. Although we may occasionally repress extremely painful memories (see Chapter 11), in general we can more easily retrieve information with high emotional content than we can recall relatively nonemotional information (G. H. Bower, 1994; Kensinger, 2007; Phelps & Sharot, 2008; Talarico, LaBar, & Rubin, 2004). As one example, recall the discussion of *flashbulb memories* in Chapter 11. As another, let's consider an experiment by Heuer and Reisberg (1990). College students looked at a series of pictures that depicted one of two stories, both involving a boy and his mother visiting the boy's father at work. For some students (the emotional-content group), the father was a surgeon operating on an accident victim; among other things, these students saw pictures of surgery in progress (with a person's internal organs in full view) and the badly scarred legs of a child. For other students (the neutral-content group), the father was an auto mechanic repairing a broken-down car; these students saw the internal workings of the car, including a piece that was clearly broken. Two weeks later, all the students were given an unexpected quiz about what they'd observed. Students who had seen the emotion-laden sequence remembered both the general gist of the story and many of the tiny details depicted in the slides far more accurately than did students who had seen the neutral sequence. In fact, although they didn't expect to be tested on what they'd seen, students in the emotional-content group remembered more than students who had watched the neutral sequence and specifically been *told* to remember its plot and details. The superior memories of the surgery-group students were probably due not only to the vividly gory visual material but also to the fact that a human being was in distressed circumstances (see Cahill & McGaugh, 1995).

General mood states, too, can affect learning and memory. When we're in a good mood (e.g., when we feel happy or excited, rather than bored or depressed), we're more likely to pay attention to information, relate it to things we already know, and creatively elaborate on it (Bäumli &



People often remember more when information packs an emotional wallop.

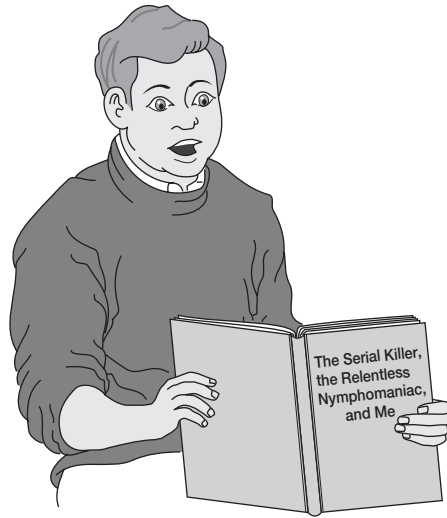

Kuhbandner, 2007; Fredrickson, 2009; Pekrun, 2006; Pekrun et al., 2010; N. Schwarz & Skurnik, 2003). A good mood is also likely to help us retrieve things we've previously stored in long-term memory (Oatley & Nundy, 1996). But in addition, we can sometimes retrieve information from long-term memory more successfully when our mood at the time of retrieval is the same as our mood when we initially stored the information—an effect known as **mood-dependent memory** (G. H. Bower & Forgas, 2001; Eich, 1995; Pekrun et al., 2002).

Some cognitive theorists have suggested that affective responses to objects and events are integral parts of the network of associations that comprises long-term memory.<sup>11</sup> Just as people can easily categorize things on the basis of concepts or schemas, so, too, can they easily categorize them on the basis of affect—what things make them happy, sad, angry, and so on (G. H. Bower & Forgas, 2001). Affective responses may, in fact, be an important source of *information* that learners have about objects and events (Clore, Gasper, & Garvin, 2001; Minsky, 2006; N. Schwarz & Skurnik, 2003; C. A. Smith & Kirby, 2001). For instance, it's quite helpful to know that reading a good book will be a source of pleasure but that spending time with a verbally abusive relative will not.

In some circumstances, the affective components of a memory are so intense that they're easily retrieved, perhaps to the point that they're hard to ignore and unlikely to be confused with other memories<sup>12</sup> (Berntsen, 2010; G. H. Bower & Forgas, 2001; Schacter, 1999). In other cases, affective components may be sufficiently subtle that learners aren't consciously aware of them; that is, they're *implicit* rather than explicit knowledge (G. H. Bower & Forgas, 2001; Ito &

<sup>11</sup>Neurological evidence supports this view. Areas of the brain associated with emotion (e.g., the limbic system) communicate regularly with those responsible for “colder” aspects of cognition (e.g., the frontal cortex), and they sound an alarm when a potentially important stimulus warrants immediate attention (Benes, 2007; Forgas, 2008; Schupp, Junghöfer, Weike, & Hamm, 2003).

<sup>12</sup>In the terminology of Chapter 11, emotionally intense memories are less prone to *interference* from other memories (G. H. Bower & Forgas, 2001).

Cacioppo, 2001; Winkielman & Berridge, 2004). Occasionally people show physiological responses to a stimulus that they have no conscious recollection of at all; in such situations, previous affective responses to that stimulus are the *only* things that appear to remain in memory (Nadel & Jacobs, 1998; Zajonc, 2000).

Probably the most widely studied form of affect within the context of learning and instruction is anxiety. Behaviorists have discovered that anxiety can be classically conditioned and sometimes leads to avoidance learning (see Chapters 3 and 4). Cognitivists have documented anxiety's negative effects on such cognitive processes as long-term memory retrieval and problem solving (see Chapters 11 and 15). Anxiety has other effects as well—some beneficial and others not, as we'll see now.

## Anxiety

**Anxiety** is a feeling of uneasiness and apprehension about a situation, typically one with an uncertain outcome. Fear and anxiety are related concepts, in that both reflect the high end of the *arousal* continuum. Yet they have one critical difference that sets them apart: Fear is a response to a specific threat, whereas anxiety is vague and relatively unfocused. For example, people are *afraid* of certain things, but they don't always know exactly what they're *anxious* about (Lazarus, 1991).

Anxiety has two distinct components: worry and emotionality (R. Carter, Williams, & Silverman, 2008; Hong, O'Neil, & Feldon, 2005; Tryon, 1980). **Worry** is the cognitive aspect of anxiety, which includes troubling thoughts and beliefs about one's ability to deal with a situation. **Emotionality** is the affective aspect, which includes such physiological responses as muscular tension (e.g., stomach "butterflies"), increased heart rate, and perspiration, as well as such behavioral responses as restlessness and pacing.

Psychologists have found it useful to distinguish between two types of anxiety. **State anxiety** is a temporary condition elicited by a particular stimulus. For example, you might experience state anxiety when working on an especially challenging math problem or thinking about an upcoming exam in a notoriously difficult class. In contrast, **trait anxiety** is a relatively stable state of affairs, such that an individual is chronically anxious in certain situations. For instance, you might have general mathematics anxiety or test anxiety, becoming anxious whenever you encounter numbers or think about exams.

### *Effects of Anxiety*

Early studies focused on the effects of anxiety on learning and performance. More recently, with the advent of cognitivism, studies have investigated the effects that anxiety is likely to have on cognitive processes. Let's examine the evidence in each of these areas.

**Effects on learning and performance** Earlier I mentioned that people may strive to seek an optimal level of arousal—a comfort zone somewhere between too little and too much. But what's optimal depends not only on the individual but also on the task at hand. Early researchers found that arousal affects learning and performance in a curvilinear ("inverted U") fashion (Broadhurst, 1959; D. W. Fiske & Maddi, 1961; Hebb, 1955; Yerkes & Dodson, 1908). More specifically, a small degree of arousal (e.g., a low level of anxiety) facilitates learning and performance. A high degree of arousal (e.g., high anxiety) may facilitate learning and performance when the task is easy but likely to interfere when the task is more difficult. For any task, there's probably some

**Figure 16.2**

The inverted U curve, depicting a curvilinear relationship between arousal and performance

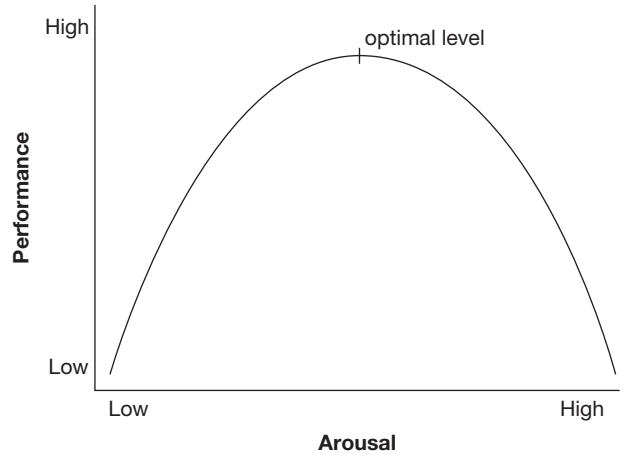

optimal level of arousal (reflected by the top point of the inverted U) at which learning and performance are maximized (see Figure 16.2).

A classic experiment with mice by Yerkes and Dodson (1908) provides a concrete illustration of how arousal level and task difficulty interact. Each mouse was placed in a chamber from which it could escape by either of two doors. The wall opposite the doors was slowly moved to make the chamber smaller and smaller, until the mouse was eventually forced to escape through one door or the other. One door led to a safe, comfortable “nest box”; the other led to electric shock. The experimenters provided a clue to help the mouse determine which door was which: The doorway leading to the nest box was consistently lighter in color than the doorway leading to shock.

For different groups of mice, the experimenters varied arousal level by the amount of shock administered—mild, intense, or somewhere in between—when the wrong door was entered. They varied task difficulty by varying the relative similarity or difference between the two doorways: some mice had to choose between white and black (an easy task), others chose between light and dark gray (a moderately difficult task), and still others chose between similar shades of gray (a very difficult, although not impossible, task).

The experimenters established a criterion of 30 correct door choices in a row as an indication that a mouse had successfully learned the discrimination. Figure 16.3 shows the average number of learning trials for mice in each condition; because the y-axis reflects quality of performance (speed of learning), groups needing fewer trials to reach the criterion appear higher in the figure than groups with more trials. Notice how the mice with an easy choice performed best under high arousal (intense shock) conditions. Those with a moderately difficult task performed better with moderate arousal (moderate shock). Those with an extremely difficult discrimination performed best when shock and arousal were relatively low.

This principle—that easy tasks are best accomplished with a relatively high level of arousal but more difficult tasks are better accomplished with a low or moderate level—is often called the **Yerkes–Dodson law**. The principle holds true not only for mice but for human beings as well. In general, a high level of anxiety enhances performance of well-learned, automatic behaviors; here we have a case of **facilitating anxiety**. But the same high level is apt to interfere with performance on a challenging new task; in this situation, we have **debilitating anxiety**. For example, people generally run faster when they’re highly anxious—running is a skill most people learn to

**Figure 16.3**

Arousal level interacts with task difficulty, resulting in different optimal levels for different tasks.

From data reported in “The relation of strength of stimulus to rapidity of habit-formation” by R. M. Yerkes and J. D. Dodson, 1908, *Journal of Comparative Neurology and Psychology*, 18, pp. 459–482.

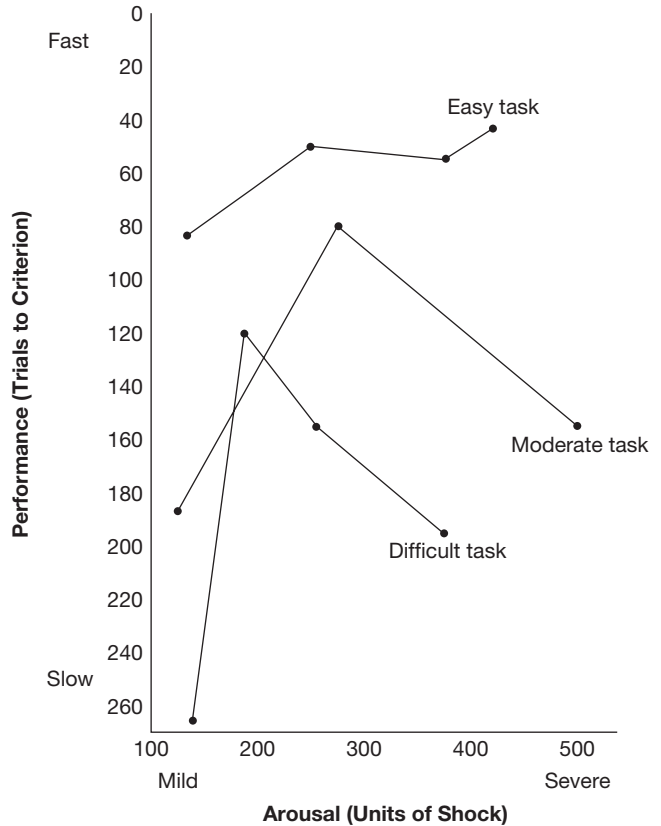

automaticity—but high anxiety levels interfere with more complex motor skills, such as playing golf (Beilock & Carr, 2001; Gladwell, 2005). And although a small amount of anxiety about an upcoming exam is apt to spur students to be diligent in their schoolwork, a lot of anxiety *during* the exam is apt to be counterproductive (Cassady, 2010b; Kirkland, 1971; Spielberger, 1966).

A useful distinction in this context is the difference between threat and challenge (Combs, Richards, & Richards, 1976). A **threat** is a situation in which learners believe they have little chance of success—they see failure as an almost inevitable outcome. In contrast, a **challenge** is a situation in which learners believe they can probably succeed if they try hard enough. Students are likely to have debilitating anxiety when they perceive a situation to be threatening. They respond to challenges more favorably; for example, they’re likely to be highly motivated to do their best, and they express considerable excitement and satisfaction when they succeed (Cassady, 2010b; Cobb, Yackel, & Wood, 1989; N. E. Perry, Turner, & Meyer, 2006; Shernoff & Csikszentmihalyi, 2009; A. G. Thompson & Thompson, 1989).

**Effects on cognition** Imagine yourself sitting in class taking an exam. Here are some thoughts that might run through your mind as you do so:

- Oh, yes, my professor introduced this concept last week. It refers to . . .
- Here’s something we didn’t specifically talk about in class. Let me see if I can relate it to something we *did* talk about . . .

- The best way to solve this problem might be to . . .
- These questions are getting harder and harder . . .
- Oh, no, I only have 10 minutes left. I can't possibly finish . . .
- What if I fail this test? It's required for my program . . .

The first three thoughts are clearly relevant to the task at hand and should help you do your best on the exam. In contrast, the last three are irrelevant to your task: You're devoting your time and thoughts to worrying rather than to thinking about how to answer the test questions. As you should recall from our discussion of attention and working memory in Chapter 8, people can attend to and process only a small amount of information at any one time. The more time and attention they devote to worrying about a test they're taking, the less capacity they have for dealing with the test itself.

Anxiety interferes with an individual's attention to a task. And because worrisome thoughts take up a certain amount of working memory capacity, anxiety also interferes with effective cognitive processing. Such effects are especially common when the task at hand is a difficult one—for instance, when it involves solving problems—and when it involves considerable retrieval of information from long-term memory (Ashcraft, 2002; Beilock & Carr, 2005; Beilock, Kulp, Holt, & Carr, 2004; Pekrun et al., 2002; Tobias, 1980).

In general, then, anxiety's debilitating effects are distractive ones: When performing a difficult task, highly anxious people are more likely to be diverted by irrelevant stimuli, think irrelevant thoughts, and exhibit irrelevant responses (Ashcraft, 2002; Beilock et al., 2004; Fletcher & Cassady, 2010; Wine, 1980).

### ***Common Sources of Anxiety***

People can be anxious about a variety of things. For example, they may be concerned about their personal appearance (N. J. King & Ollendick, 1989). They're likely to feel insecure when entering a new, unknown, and perhaps unsettling situation—for instance, when, as young adolescents, they make the transition from a nurturing elementary school to a more impersonal junior high or high school (Benner & Graham, 2009; Eccles & Midgley, 1989; Phelan, Yu, & Davidson, 1994; Tomback, Williams, & Wentzel, 2005). They may feel uncomfortable when they encounter ideas that conflict with what they currently believe; recall our earlier discussion of *cognitive dissonance* (Bendixen, 2002; Harmon-Jones, 2001). And, in general, people are likely to become anxious whenever their sense of self-worth or self-efficacy is threatened—for instance, when they know or think they're being evaluated by adults or peers (Cassady, 2010a; Covington, 1992; Eccles et al., 1998; Zeidner & Matthews, 2005).

Two forms of trait anxiety—mathematics anxiety and test anxiety—have been the focus of considerable study. Let's look at what research tells us about each of these.

***Mathematics anxiety*** Some school subjects tend to elicit more anxiety than others; for instance, some students get especially anxious in science or foreign language classes (Britner, 2010; Goetz, Frenzel, Pekrun, Hall, & Lüdtke, 2007; Horwitz, Tallon, & Luo, 2010). But of all the subjects taught in schools, none seems to elicit as much anxiety for as many students as mathematics. Math anxiety has both worry and emotionality components. First, math-anxious people firmly believe they're incapable of succeeding at mathematical tasks; in other words, they have low self-efficacy for math. Second, they have negative emotional reactions to math: They fear and dislike it, often intensely (B. Hoffman, 2010; Jain & Dowson, 2009; Jameson, 2010; Wigfield & Meece, 1988).

One possible reason that students become anxious about math is that school curricula often introduce mathematical concepts and procedures before students are cognitively ready to handle them. For example, developmental researchers have found that the abilities to understand proportions and deal with abstract ideas emerge only gradually over the course of childhood and adolescence (Schliemann & Carraher, 1993; Tourniaire & Pulos, 1985; also see Chapter 12). Yet schools often expect students to work with mathematical proportions and abstractions—for instance, fractions, ratios, negative numbers, and pi ( $\pi$ )—in the upper elementary and early junior high school years. If students are asked to deal with concepts and tasks they can't understand, many of them will undoubtedly encounter frustration and failure. And when students associate frequent failure with math, we can expect them to develop a dislike for the subject and a belief that they're incapable of doing well in it.

As you might expect, students with high math anxiety do more poorly in math than students with low math anxiety. Furthermore, highly math-anxious students are less likely to enroll in additional math classes of their own volition or pursue careers in math or related fields (e.g., science, technology). Such differences between high-math-anxious and low-math-anxious students appear even when the two groups of students have done equally well in previous math classes (Ashcraft, 2002; Chipman, Krantz, & Silver, 1992; Eccles & Jacobs, 1986; Jameson, 2010; Meece, Wigfield, & Eccles, 1990; Zeidner & Matthews, 2005).

**Test anxiety** Most of us get a little bit anxious about tests, and as we've already seen, a small amount of anxiety can actually help us do better on them. But some students become extremely anxious in test-taking situations, and these students typically get lower test scores than their less anxious classmates (Cassady & Johnson, 2002; Chapell et al., 2005; Hembree, 1988). Such students appear to be concerned primarily about the *evaluative* aspect of tests: They're terribly concerned that someone else (e.g., their teacher) will make negative judgments about them (Harter, Whitesell, & Kowalski, 1992; B. N. Phillips, Pitcher, Worsham, & Miller, 1980; Zeidner & Matthews, 2005). Test anxiety interferes not only with retrieval at the time of the test but also with encoding and storage when learners are studying for the test (Cassady, 2010b; Zeidner & Matthews, 2005). Thus, highly test-anxious students don't just "test" poorly, they also learn poorly.

Many students in the upper elementary and secondary grades have test anxiety that interferes with their test performance, especially when taking *high-stakes* tests whose results influence decisions about promotion, graduation, and other significant consequences (Chabrán, 2003; R. M. Thomas, 2005). Debilitative test anxiety is especially common in students from ethnic minority groups and students with disabilities (R. Carter et al., 2008; Putwain, 2007; Whitaker Sena, Lowe, & Lee, 2007).

Anxiety may be at the root of a phenomenon known as **stereotype threat**, in which individuals from stereotypically low-achieving groups (e.g., females, certain minority groups) perform more poorly on tests than they otherwise would simply because they're aware that their group traditionally *does* do poorly (J. Aronson & Steele, 2005; Steele, 1997). When people are aware of the unflattering stereotype—and especially when they know that the task they're performing reflects their ability in an important domain—worrisome thoughts intrude into working memory, heart rate and other physiological correlates of anxiety go up, and performance goes down (Cadinu, Maass, Rosabianca, & Kiesner, 2005; Inzlicht & Ben-Zeev, 2003; Krendl, Richeson, Kelley, & Heatherton, 2008; Schmader, 2010; G. M. Walton & Spencer, 2009). We're less likely to see the negative effects of stereotype threat when people don't interpret their performance on a task as an indication of their competence, ability, and overall status in comparison

with peers (Josephs, Newman, Brown, & Beer, 2003; McKown & Weinstein, 2003; Osborne, Tillman, & Holland, 2010; Régner et al., 2010).

To perform most effectively in the classroom, learners should be motivated to do their best yet not be overly anxious about their performance. In the final section of this chapter, we'll consider general strategies for promoting students' motivation to achieve academic success and for keeping anxiety and other emotions at productive levels.

## CREATING A MOTIVATING CLASSROOM ENVIRONMENT

---

All too often, I hear people (including some teachers) complain that students “just aren't motivated” to learn. But one thing should be clear by now: Motivation to learn classroom subject matter isn't necessarily something that students bring to school with them—it can also be something teachers *instill* in students (recall our earlier discussion of *situated motivation*).

The theories and principles we've examined in this chapter offer numerous ideas about how instructional practices can promote motivation:

- ◆ *Students learn more effectively and engage in more productive classroom behaviors when they're intrinsically rather than extrinsically motivated to learn and achieve.* Our society often focuses on the extrinsic advantages of school achievement. Parents offer money and other rewards for good grades. School athletic departments confer letters for sports participation. Teachers and guidance counselors stress the importance of high school diplomas for long-term financial success. Yet as we've seen, students are more likely to exhibit initiative, engagement, meaningful learning, and enjoyment in academic activities—and more likely to achieve at high levels—when they're *intrinsically* rather than extrinsically motivated. Unfortunately, children's intrinsic need to learn and achieve at school tends to decrease as they progress through the school grades and especially as they make the transition from elementary to secondary school (Gottfried, Fleming, & Gottfried, 2001; Lepper et al., 2005; Wigfield et al., 2006).

Researchers have identified a variety of strategies that appear to promote intrinsic motivation to learn classroom subject matter. One effective approach is to talk about intrinsic rather than extrinsic motives for pursuing classroom activities—for example, by saying, “It's nice to get good grades, but it's more important that you understand what you're studying and enjoy what you're doing” (Amabile & Hennessey, 1992; Graham & Weiner, 1996; Urdan & Turner, 2005). Adults who model intrinsic motivation—for instance, by showing enthusiasm about what they're doing—promote observers' intrinsic motivation for the same activities (Frenzel, Goetz, Lüdtke, Pekrun, & Sutton, 2009; Nolen, 2007; Radel, Sarrazin, Legrain, & Wild, 2010). And relating classroom topics to students' own lives, experiences, needs, and feelings increases the likelihood that students will genuinely want to learn about them (A. Kaplan & Flum, 2009; Urdan & Turner, 2005; M.-T. Wang & Holcombe, 2010).

- ◆ *Students are more likely to be intrinsically motivated when they feel confident they can succeed at classroom tasks.* Throughout the book I've been identifying strategies for promoting students' academic success. Yet not *all* successes enhance learners' sense of competence. To see what I mean, take a moment to do this exercise:

Write the numbers 1 to 10 on a piece of paper. See if you can do it in less than 10 seconds.

Were you successful? If so, how good did your success make you feel? I just did the task in about 4 seconds' time but had little reason to feel particularly proud. After all, I'm in my early 60s; if I can't write these numbers quickly and accurately by now, something must be terribly wrong.

Success on easy tasks, although virtually guaranteed, does little to enhance our self-efficacy and overall sense of competence. Sure, we can do it, but so can anyone else. However, challenges aren't so easily accomplished: Perhaps we've failed to accomplish them in the past, or perhaps we know others who have failed. When we successfully meet a challenge, we must obviously be pretty competent folks. Success on a challenging task, then, gives learners feelings of satisfaction that aren't possible with an easier task. Furthermore, because it enhances their feelings of competence, success in a challenging situation increases their intrinsic motivation (Deci & Ryan, 1992; Dweck, 2000; Urdan & Turner, 2005).

*Too much* of a challenge can be discouraging, however. With this point in mind, teachers should help students develop a reasonable perspective as to what success is—for instance, daily or monthly improvement qualifies, but consistent perfection isn't realistic. And teachers can cast students' errors in an appropriate light—as inevitable minor stumbling blocks on the road to success—and make sure that, despite such errors, students eventually do succeed with effort, persistence, and appropriate strategies. Ultimately, students maximize their progress when they don't agonize over how they're well they're doing or not doing—when they instead focus their attention on actually mastering the task at hand (Brophy, 2004).

◆ *Students' intrinsic motivation also increases when they have some degree of autonomy in classroom activities.* For both pedagogical and logistical reasons, students often have little control over things that happen in school. For example, society's needs and school district curricula typically dictate the kinds of knowledge and skills students must master. The use of the same facilities and resources by many different students requires adherence to certain schedules. And to keep students' attention focused on school tasks, teachers must maintain some semblance of order in the classroom.

Yet some degree of autonomy in the classroom seems to be essential for enhancing students' sense of self-determination and intrinsic motivation (e.g., Hardré, Crowson, DeBacker, & White, 2007; Hardré & Reeve, 2003; Prout, 2009). Teachers can do numerous little things to give students a sense of self-determination about classroom activities. For instance, they can provide opportunities for students to learn independently, perhaps through small-group work or computer-assisted instruction (Stefanou et al., 2004; Swan, Mitrani, Guerrero, Cheung, & Schoener, 1990). They can acknowledge that certain activities might be boring and tedious while also explaining how these activities will be beneficial over the long run (Jang, 2008; Reeve, 2009). And when evaluation is useful in promoting academic progress, teachers can provide mechanisms (e.g., checklists) through which students can evaluate themselves (McCaslin & Good, 1996; Paris & Ayres, 1994).

As noted earlier, a key factor affecting learners' sense of self-determination is having choices about what to do. Learners are more likely to have a sense of ownership about activities they've chosen for themselves (Schraw, Flowerday, & Lehman, 2001). Opportunities for choice-making must, of course, be within reasonable limits and take into account students' developmental readiness to make appropriate decisions (Brophy, 2004; K. Lane, Falk, & Wehby, 2006). For instance, when a particular objective can be accomplished in two or more different ways, teachers might give students a choice about how best to proceed or in what manner to demonstrate mastery (Clani, Middleton, Summers, & Sheldon, 2010; B. A. Hennessey & Amabile, 1987; Stefanou et al., 2004). And when extrinsic reinforcers are used as a way of encouraging students to perform dull



but necessary tasks, teachers can preserve students' sense of self-determination by giving them choices regarding the specific reinforcers they can earn by completing the tasks (Geckeler, Libby, Graff, & Ahearn, 2000; Spaulding, 1992; Tiger, Hanley, & Hernandez, 2006).

Giving students autonomy *doesn't* mean removing all structure from classroom activities (Clani et al., 2010; H. A. Davis, 2003; Jang, Reeve, & Deci, 2010; M.-T. Wang & Holcombe, 2010). Some structure—for instance, in the form of scaffolding that supports students' efforts to learn—is essential for promoting students' sense of self-efficacy and competence. In addition, a certain amount of structure can enhance students' sense of self-determination. For instance, if teachers clearly communicate expectations for academic performance (e.g., by providing evaluation criteria in advance), students know exactly what they must do to be successful (Reeve, 2006). Teachers can inform students well ahead of time about upcoming deadlines, so that students can budget their time accordingly (Spaulding, 1992). And teachers can establish general routines and procedures that students should typically follow as they work, thereby minimizing the need to give explicit instructions for each and every assignment (Spaulding, 1992).

♦ *Extrinsic motivation can also promote learning.* Although intrinsic motivation is the optimal situation, extrinsic motivation isn't necessarily a bad thing, and it's certainly better than *no* motivation to learn and achieve. Oftentimes students are motivated both by an intrinsic desire to master classroom subject matter and by the external rewards such mastery brings—the good grades, public recognition, access to desirable educational opportunities and careers, and so on (Cameron, 2001; Covington, 2000; Daniels et al., 2008; Hidi & Harackiewicz, 2000). Furthermore, many students have multiple demands on their time, to the point where they must place priority on activities that bring them good grades and other outcomes important to their future well-being (M. Hofer, 2010; C. S. Ryan & Hemmes, 2005).

As we've noted on previous occasions, extrinsic reinforcement may be most useful when desired behaviors apparently won't occur any other way. Learners may initially find a new activity boring, difficult, or frustrating and therefore need external encouragement to persist (Cameron, 2001; Deci et al., 2001; Hidi & Harackiewicz, 2000). In such circumstances teachers should ideally reinforce students not just for doing something but for doing it *well*—that is, for engaging in behaviors and cognitive processes that will maximize achievement over the long run (Cameron & Pierce, 1994; Eisenberger & Cameron, 1996). With continuing practice, students' competence and skill are likely to improve, and they may eventually begin to find the activity intrinsically rewarding.

It's important to note, too, that students' intrinsic motivation to learn classroom material isn't likely to appear overnight but instead will emerge slowly over time, especially if students have previously been accustomed to receiving extrinsic reinforcement for their efforts. When working with extrinsically motivated students, a reasonable approach is to increase emphasis on the intrinsic rewards of learning while only gradually weaning students from their dependence on external reinforcers (Covington, 1992; Lepper, 1981; Stipek, 1996).

♦ *Feedback and other forms of extrinsic reinforcement should maintain or enhance students' sense of competence and self-determination.* In Chapter 4, we talked about positive feedback as a form of reinforcement; from an operant conditioning perspective, feedback has a *direct* effect on behavior. In Chapters 6 and 9, we noted that feedback can also enhance performance *indirectly* by giving learners information about how they can improve. As we've seen in this chapter, motivation theorists suggest that feedback has an additional indirect effect on behavior: It enhances performance to the extent that it affirms an individual's sense of competence and overall self-worth.

In contrast, positive feedback is *unlikely* to be beneficial when it either (1) diminishes one's sense of competence or (2) communicates an attempt to control one's behavior and so undermines one's sense of self-determination (P. Burnett, 2001; Deci & Moller, 2005; Reeve et al., 2004). For example, I respond to my children more favorably when they tell me

Boy, Mom, these brownies you made are really good. (*a competence-enhancing statement*)  
 than when they say

It's a good thing you finally baked something around here, Ma. All my friends' mothers do it all the time. (*a controlling statement*)

Compliments about things I do well are always welcome. But statements about what "good" parents are supposed to do make me feel as if I'm not in charge in my own home. Besides, I have no intention of letting my children tell *me* how to behave.

Even *negative* feedback can be effective when it promotes competence and self-determination (Narciss, 2008; Reeve, 2006; Sedikides & Gregg, 2008). If it provides information about how to improve in the future, thereby implying that the individual can eventually be successful, it's likely to promote intrinsic motivation. If it instead conveys the message that a learner is incompetent or imposes a feeling of outside control, it's apt to undermine any intrinsic motivation to continue engaging in a task.

♦ *Students are more likely to focus on their schoolwork when their nonacademic needs have been met* (Brophy, 2004; Fredricks et al., 2004). Our earlier discussions of drives, Maslow's hierarchy, and the needs for arousal and relatedness point to a number of nonacademic needs that students are likely to have. On some occasions students may have physiological needs; for instance, they may be hungry, thirsty, tired, or restless. Students may feel uncertain or insecure about what will happen to them in class, in the schoolyard, or on the way to and from school. And many students have a strong desire to interact with other people—classmates and teachers alike—and ideally gain others' approval, respect, and companionship. The need for self-worth, too, has nonacademic implications, in that students are apt to judge themselves not only on the basis of what they can do but also on the basis of how other people treat them and respond to their actions.

Teachers can do a number of simple things to ensure that students' physiological needs are met. For example, they can help students enroll in free lunch programs, refer students with apparently untreated illnesses to the school nurse, and grant reasonable requests to use the restroom. And students are more likely to stay on task in the classroom if they have occasional opportunities for physical exercise and release of pent-up energy—thereby satisfying their need for arousal to some degree (Pellegrini & Bohn, 2005; Tomporowski, Davis, Miller, & Naglieri, 2008).

To meet students' need for safety and security at school and to keep students' anxiety about academic tasks and activities at a facilitative level, teachers must create an environment that's somewhat orderly and predictable but also psychologically warm and supportive (Brophy, 1987; Fletcher & Cassady, 2010; D. K. Meyer & Turner, 2006; Pekrun, 2006). For instance, teachers should clearly describe expectations for both academic performance and classroom behavior. They should deal with misbehaviors in a fair and consistent fashion. They should provide opportunities for students to voice their questions and concerns. And they must actively address bullying and other circumstances that may jeopardize students' physical or psychological well-being.

Students' needs for love, belonging, affiliation, and approval—in general, their need for relatedness—can be met in a variety of ways. Teacher–student relationships are, by their very nature, somewhat businesslike; after all, both teachers and students have a job to do. At the same time, teachers can express their interest and affection for students through the many little things they do throughout the day—for example, by acknowledging birthdays and other special occasions, taking students' ideas and opinions seriously, and offering a supportive and nonjudgmental ear when a particular student seems angry or depressed. Teachers should also provide opportunities for students to interact frequently with classmates—for example, through such group-oriented instructional techniques as discussions, cooperative learning, reciprocal teaching, and role playing. In general, students are more likely to be academically successful—and more likely to stay in school rather than drop out—when they believe that their teachers and peers like them and when they feel that they're valued members of the classroom (Certo, Cauley, & Chafin, 2003; Hymel, Comfort, Schonert-Reichl, & McDougall, 1996; Osterman, 2000; Patrick, Turner, Meyer, & Midgley, 2003; M. Watson & Battistich, 2006; Wentzel, Battle, Russell, & Looney, 2010).

To help students gain the esteem of others and maintain their own sense of self-worth, teachers can acknowledge students' accomplishments both in and out of class. They can schedule activities in such a way that all students are able to demonstrate their particular strengths at some point during the school day or at special events after school (Bracken, 2009; Jenlink, 1994; A. J. Martin, 2008). They can highlight students' accomplishments in many subtle ways—for example, by posting students' art projects on the wall, describing noteworthy achievements at parent–teacher conferences, and sending occasional good-news reports home to parents. But most importantly—I'm probably beginning to sound like a broken record here—teachers must have high expectations for students' performance and do everything they can to help students *meet* those expectations (L. H. Anderman et al., 2002; Roeser, Marachi, & Gehlbach, 2002).

♦ *Dispositions that involve actively and thoughtfully engaging with school subject matter should promote more effective cognitive processing and learning over the long run.* To date, researchers have focused more on how students differ in their dispositions than on how to *promote* certain dispositions. But we can reasonably assume that teachers who encourage and model productive dispositions—for instance, by presenting thought-provoking questions, asking students to evaluate the quality of scientific evidence, insisting that students defend their opinions with sound rationales, teaching strategies for constructing persuasive arguments, and consistently exhibiting their own open-mindedness about diverse perspectives—get students off to a good start (J. B. Baron, 1987; Derry, Levin, Osana, & Jones, 1998; Gresalfi, 2009; Halpern, 1998; D. Kuhn, 2001b; Nussbaum, 2008; Perkins & Ritchhart, 2004).

♦ *Learning is—and should be—an affective as well as cognitive enterprise.* There's no reason that academic subject matter need be dry and emotionless. On the contrary, students will probably remember more if they have feelings about the things they study. For example, a scientific discovery might be exciting. A look at social injustices might make students angry. A poem or musical concerto might convey peace and serenity.

Although students might occasionally feel outrage about certain historical events or current social phenomena, in general they should associate pleasure and other forms of positive affect with classroom activities. For example, although teachers don't necessarily want to give the impression that schoolwork is all fun and games, they can occasionally incorporate a few gamelike

features into classroom tasks and activities (Brophy, 1986, 2004)—perhaps by using a television game show format during a review session (this strategy also addresses social needs) or having students act as detectives in interpreting archeological artifacts. And in general, teachers must make sure that most of students' experiences with any task or subject matter—and especially their *early* experiences—are positive, nonthreatening ones.

♦ *Classroom assessments are more effective motivators when students perceive them as means of enhancing future achievement rather than as judgments of ability and worth.* Under the right circumstances, tests and other forms of classroom assessment can serve as effective motivators—albeit extrinsic ones—for academic learning. On average, students study class material more, review it more regularly, and learn it better when they're told they'll be tested on it or in some other way held accountable for it, rather than when they're simply told to learn it (Dempster, 1991; N. Frederiksen, 1984b; Halpin & Halpin, 1982). Yet *how* students are assessed is as important as *whether* they're assessed. Assessments are especially effective as motivators when they're closely aligned with important instructional objectives and challenge students to do their best (Mac Iver, Reuman, & Main, 1995; Maehr & Anderman, 1993; L. H. Meyer, Weir, McClure, & Walkey, 2008). Students' self-efficacy affects their perceptions of the challenge, of course: Students must believe that success is possible if they exert reasonable effort and use appropriate strategies.

But as we discovered earlier, some students have debilitating anxiety in test-taking situations. Researchers and practitioners have offered several suggestions for keeping students' anxiety about classroom assessments at a facilitative level:

- Help students master class material and effective study strategies to the point where successful performance on assessments is highly probable.
- Keep an assessment short enough that students can easily complete it within the allotted time.
- Encourage students to do their best without creating unnecessary anxiety about the consequences of doing poorly.
- Provide reasonable support (scaffolding) to help students perform successfully—for instance, give pretests for practice and feedback or allow students to use notes and other resources when there's no inherent value in committing certain kinds of information to memory.
- Give students some leeway to take risks and make errors without adverse consequences.
- Base students' classroom grades on many sources of data (e.g., numerous small assessments) instead of on only one or two test scores.
- Minimize—and ideally eliminate—opportunities for students to compare their performance with that of classmates. (Brookhart, 2004; Brophy, 1986, 2004; Cassady, 2010b; Covington, 1992; Gaudry & Spielberger, 1971; Gaynor & Millham, 1976; K. T. Hill, 1984; K. T. Hill & Wigfield, 1984; Kirkland, 1971; Leherissey, O'Neil, & Hansen, 1971; Naveh-Benjamin, 1991; I. G. Sarason, 1980; J. W. Thomas et al., 1993; Usher, 2009).

And above all, teachers and students alike must keep tests and other forms of classroom assessment in the proper context—as means of promoting learning and long-term achievement, rather than as means of making judgments about students' ability and worth.

---

## SUMMARY

*Motivation* is an internal state that arouses us to action, pushes us in certain directions, and keeps us engaged in certain activities. Motivation determines the extent to which we show what we've learned; it also affects whether and in what ways we process the information we receive. *Intrinsic motivation* is ultimately more beneficial than *extrinsic motivation*; for example, intrinsically motivated individuals do things on their own initiative, maintain attention on tasks, and process information in meaningful ways. Yet intrinsic and extrinsic motivation aren't necessarily mutually exclusive; often learners are simultaneously both intrinsically and extrinsically motivated.

Numerous theorists have speculated about the nature of human beings' basic, universal needs. Early *drive* theorists believed that members of many species (including humans) behave in ways that satisfy their physiological needs and maintain homeostasis; a bit later, theorists modified drive theory to include *incentives*, suggesting that characteristics of goal objects mediate a stimulus–response relationship and thereby affect which stimuli are responded to and to what degree. In addition to maintaining homeostasis, people may also have a need for stimulation, or *arousal*. People who have little access to environmental stimulation for extended periods show significant disruptions in perception and thinking. From the perspective of *Maslow's hierarchy*, people have five different sets of needs (ranging from physiological needs to self-actualization) that they strive to meet in a particular order.

More recently, some researchers have found evidence that people have a need to believe they have *competence*, but they may sometimes actually undermine their own successes as a way of protecting their sense of *self-worth*. People may also have a need for *self-determination*—a sense that they have some autonomy and control regarding the course their lives will take. A third basic need that has emerged in contemporary research literature is the need for *relatedness*—a need to interact with and feel psychologically connected to others. Some motivation theorists have suggested that learners are more

intrinsically motivated to learn new information and skills when all of these needs—competence and self-worth, self-determination, and relatedness—have been adequately addressed.

Trait theorists have found individual differences in human motivation. For instance, people seem to vary in their needs for affiliation, approval, and achievement. In addition, some learners have *dispositions*—general inclinations to approach learning and problem-solving situations in particular ways—that enhance their cognitive engagement and learning success.

Closely related to motivation is *affect*—the feelings, emotions, and moods an individual brings to bear on a task. Affect influences motivation; for example, people choose activities in part based on how they think they'll feel if they succeed or fail during those activities. Affect also influences learning; for example, people can typically store and retrieve information with emotional overtones more easily than they can recall relatively nonemotional information. Of the various forms affect might take, *anxiety* is one that researchers have investigated at length. Anxiety tends to facilitate performance on easy tasks, but high levels interfere with performance on difficult tasks, apparently by interfering with effective cognitive processing and in other ways distracting learners from what they're doing.

Theory and research on human motivation and affect yield numerous implications for promoting learning and achievement in the classroom. For example, teachers should emphasize the intrinsically motivating aspects of school learning yet remember that extrinsic rewards can also be effective motivators when necessary. Teachers can promote intrinsic motivation in part by addressing students' needs for competence and self-determination in classroom activities, as well as by addressing such nonacademic needs as those for physical well-being and supportive interpersonal relationships. Teachers should also keep in mind that certain emotions (e.g., enjoyment, excitement, and in some cases anger) can enhance classroom learning, whereas others (especially fear and anxiety) often interfere with students' concentration and performance.

# COGNITIVE FACTORS IN MOTIVATION

### Interests

Effects of Interest

Factors Promoting Interest

### Expectancies and Values

Effects of Expectancies and Values

Factors Influencing Expectancies and Values

### Goals

Achievement Goals

Work-Avoidance Goals

Social Goals

Career Goals

Coordinating Multiple Goals

### Attributions

Effects of Attributions

Factors Influencing the Nature of Attributions

Explanatory Style: Mastery Orientation versus

Learned Helplessness

Motivation, Affect, and Self-Regulation

How Motivation and Affect Influence

Self-Regulation

How Self-Regulation Influences Motivation

and Affect

Internalized Motivation

Encouraging Motivating Cognitions

A TARGETS Mnemonic for Motivational

Strategies

Summary

Within the past few decades, psychologists have radically changed their approach to the study of human motivation. Although physiological needs and drives certainly influence people's behavior, talk of such needs and drives has largely gone by the wayside. Concrete, extrinsic reinforcers play less of a role in conceptions of human learning and behavior than they did in the 1960s and 1970s. Most contemporary theorists now describe human motivation as being a function of cognitive processes—interpreting events, forming expectations about future success, setting goals toward which to strive, and so on. Not only does motivation *affect* cognition, as duly noted in Chapter 16, but in many respects motivation *is* cognition.

In our discussions of competence, self-worth, and self-determination in Chapter 16, we discovered how certain aspects of cognition—in particular, perceptions of oneself and one's circumstances—are key ingredients in human motivation. In this chapter we'll consider additional cognitive factors, including interest, expectancies, values, goals, and attributions. Later we'll consider how learners become increasingly able to *self-regulate* their motivations and emotions, and we'll discover that some behaviors that are initially motivated extrinsically may become *internalized* over time, such that a learner eventually engages in them freely and willingly.

## INTERESTS

---

When we say that people have **interest** in a particular topic or activity, we mean that they find the topic or activity intriguing and enticing. Interest, then, is one form of intrinsic motivation. Positive affect accompanies interest; for example, people pursuing a task in which they're interested experience such feelings as enjoyment, excitement, and liking (M. Hofer, 2010; Renninger, 2009; Silvia, 2008).

Theorists distinguish between two general types of interest. Some interests reside within the learner; people tend to have different preferences regarding the topics they pursue and the

activities in which they engage. Such **personal interests**<sup>1</sup> are relatively stable and manifest themselves in consistent patterns in choice making over time. For example, my husband has a strong interest in football and thus can often be found in front of the television set on Saturdays, Sundays, and certain evenings from September to January. (Fortunately, these aren't the times when my favorite game shows are on the air.) And each of my three children showed unique personal interests from an early age. When Tina was growing up, she spent many hours talking either to or about boys, and as a college student, she lived in a coeducational, so-called "fraternity" house with a ratio of three males to every female. For many years, Alex had a thing for critters; as a toddler he was fascinated with ants, and throughout the elementary and middle school grades he had an intense interest in various kinds of reptiles (lizards, snakes, dinosaurs). Jeff has always been a Lego man, in his younger days putting all his allowance toward Lego sets and spending many hours in the basement building architectural wonders. Now that he's an adult, his interest has morphed into carpentry—simply another medium for building things.

In contrast to personal interest, **situational interest** is evoked by something in the environment—something that's perhaps new, unusual, or surprising (Hidi & Renninger, 2006; M. Hofer, 2010). For example, as I was driving through the plains of eastern Colorado one day many years ago, out of the corner of my eye I saw what looked like a llama. Well, I knew quite well that the Colorado plains are cattle and horse country, not llama country, so I slowed down to look more closely and eventually confirmed the unlikely llama hypothesis. For a few minutes I was more interested in identifying the strange creature I saw than in getting to my destination. In much the same way, you might have your interest temporarily piqued by a traffic accident at the side of the road, a strange-but-true tidbit in the newspaper, or a large, brightly wrapped gift with your name on it.

## Effects of Interest

In general, interest promotes more effective information processing. People who are interested in a topic devote more attention to it and become more cognitively engaged in it. They're also more likely to process information in a meaningful, organized, and elaborative fashion—for instance, by interconnecting ideas, drawing inferences, generating their own examples, and identifying potential applications. And provided that they aren't too attached to particular perspectives about a topic, they're more likely to undergo conceptual change if they encounter information that contradicts their existing understandings. As you might guess, then, learners who are interested in what they're studying are more likely to remember it over the long run and so show higher academic achievement (Harackiewicz, Durik, Barron, Linnenbrink-Garcia, & Tauer, 2008; Hidi & Renninger, 2006; K. E. Johnson, Alexander, Spencer, Leibham, & Neitzel, 2004; McDaniel, Waddill, Finstad, & Bourg, 2000; Renninger, Hidi, & Krapp, 1992; Schraw & Lehman, 2001; Sinatra & Mason, 2008; Sinatra & Pintrich, 2003a).

The *type* of interest undoubtedly makes a difference, however. Situational interest is sometimes of the "catch" variety: It engages you for a short time (as the llama engaged me), but you quickly move on to something else, and so cognitive processing and learning are apt to be limited. Other instances of situational interest are of the "hold" variety: You stay with a task or topic for a lengthy period—say, for an hour or more. Hold-type situational interest and enduring

---

<sup>1</sup>You may also see the term *individual interests*.

personal interests are ultimately more beneficial than catch-type interest. Whereas the latter may temporarily capture a learner's attention, the former—especially personal interests—provide the impetus that ultimately sustains involvement in an activity over the long run (P. A. Alexander, Kulikowich, & Schulze, 1994; Durik & Harackiewicz, 2007; Flowerday, Schraw, & Stevens, 2004; Harackiewicz, Barron, Tauer, Carter, & Elliot, 2000; M. Mitchell, 1993).

## Factors Promoting Interest

From an early age, we humans seem to be naturally curious about the world around us, as reflected in the many *why* questions young children ask (Chouinard, 2007; Frazier, Gelman, & Wellman, 2009; Geary, 2008; also see Piaget's theory in Chapter 12). Researchers have identified numerous factors that seem to promote situational interest. Some topics—for instance, death, destruction, danger, romance, and sex—appear to be inherently interesting for human beings. Things that are new, different, or unexpected often generate interest, as do things with a high activity level or intense emotions. Children and adolescents also tend to be intrigued by topics related to people and culture (e.g., disease, violence, holidays), nature (e.g., dinosaurs, weather, the sea), and current events (e.g., television shows, video games, popular music). Works of fiction and fantasy (novels, short stories, movies, etc.) are more engaging when they include themes and characters with which people can personally identify. Nonfiction is more interesting when it's concrete and easy to understand and when relationships among ideas are clear. And challenging tasks are often more interesting than easy ones—a fortunate state of affairs if, as Lev Vygotsky proposed, challenges promote cognitive growth (Ainley, 2006; J. M. Alexander, Johnson, Leibham, & Kelley, 2008; Hidi & Renninger, 2006; M. Hofer, 2010; Schraw & Lehman, 2001; Shernoff & Csikszentmihalyi, 2009; Zahorik, 1994).

Many longer-term, personal interests probably come from people's prior experiences with various topics and activities. For example, objects or events that initially invoke situational interest may provide the seed from which a sustained personal interest eventually grows (Hidi & Harackiewicz, 2000; Hidi & Renninger, 2006; Nolen, 2007). Parents and other adults may sometimes nurture children's budding interests by providing relevant books and experiences (Leibham, Alexander, Johnson, Neitzel, & Reis-Henrie, 2005; Renninger, 2009). Learners may eventually find that acquiring greater knowledge and skill in a particular area enhances their sense of self-efficacy and competence, thereby generating intrinsic motivation (M. Hofer, 2010). To some extent, interest and knowledge seem to perpetuate each other: Personal interest in a topic fuels a quest to learn more about the topic, and the increasing knowledge that one gains may in turn promote greater interest (P. A. Alexander, 1997; Hidi & Renninger, 2006).

## EXPECTANCIES AND VALUES

---

Some theorists have proposed that motivation for performing a task is a function of two variables, both of which are fairly subjective. First, a person must have a high expectation, or **expectancy**, for success. This concept overlaps with social cognitive theorists' concept of *self-efficacy* but also takes into account such outside factors as task difficulty and availability of outside support. Equally important is **value**: A person must believe that performing a task has direct or indirect



benefits (Dweck & Elliott, 1983; Feather, 1982; Wigfield, 1994; Wigfield & Eccles, 2002; Wigfield, Tonks, & Eccles, 2004).

## Effects of Expectancies and Values

Children in the preschool and early elementary school years often pursue activities they find interesting and enjoyable, regardless of their expectancies for success (Wigfield, 1994; Wigfield et al., 2004). For older children and adults, however, intrinsically motivated behavior occurs only when both high expectancy and high value are present. For example, as a doctoral student in educational psychology in the 1970s, I found value in human learning theory and had a high expectancy that I could master it; thus I was motivated to learn as much as I could about how human beings learn. I value good music, too, but have a low expectancy for becoming an accomplished musician (I haven't yet learned basic piano playing skills to automaticity despite five years of lessons), so I don't work very hard or very often at my music. I'm much better at cooking lima beans than I am at piano playing, but I never cook them because I find no value in eating them. And there are some things that, for me, are associated with both low expectancy and low value; playing violent video games and walking barefoot on hot coals are two activities that come to mind.

To some degree, expectancies and values are related to different aspects of learners' behavior and performance. Values affect the choices learners make, such as the courses they take and the career paths they pursue. In contrast, although values certainly influence the extent to which learners work to make sense of what they're studying, on average learners' actual effort and achievement levels are more closely correlated with their expectancies for success (Durik, Vida, & Eccles, 2006; Eccles, 2005; Mac Iver, Stipek, & Daniels, 1991; R. B. Miller, Greene, & Dillion, 2010; Simons, Vansteenkiste, Lens, & Lacante, 2004; Wigfield & Eccles, 2002).

## Factors Influencing Expectancies and Values

People's expectancies are probably the result of several variables. Prior successes and failures in a particular domain make a difference, of course; for example, learners will lower their expectations after experiencing a series of failures. But other factors affect expectancy level as well, including the perceived difficulty of a task, the quality of instruction, the availability of resources and support, the amount of effort that will probably be necessary, and stereotypes about what males and females are "good at" and "not good at." From such factors, a learner comes to a conclusion—perhaps correct, perhaps not—about the likelihood of success (Dweck & Elliott, 1983; Dweck, Goetz, & Strauss, 1980; Ford & Smith, 2007; Jacobs, Davis-Kean, Bleeker, Eccles, & Malanchuk, 2005; Mac Iver et al., 1991; Wigfield & Eccles, 1992).

Expectancy–value theorists have suggested four key reasons why value might be high or low: importance, utility, interest, and cost (Eccles, 2005; Wigfield & Eccles, 1992, 2000).<sup>2</sup> Some activities are valued because they're associated with desirable personal qualities; that is, they're viewed as *important*. For example, a boy who wants to be smart and thinks that smart people do well in school will place a premium on academic success. Other activities have high value

---

<sup>2</sup>For alternative perspectives on the nature and origins of values, see Brophy (2008); D. Kuhn (2009); C. Peterson (2006).

because they're seen as means to a desired goal; that is, they have *utility*. For example, much as my daughter Tina found mathematics confusing and frustrating, she struggled through 4 years of high school math classes because many colleges require that much math. Still other activities are valued simply because they bring pleasure and enjoyment; in other words, they're *interesting*. For example, watching television game shows doesn't help me achieve any of my long-range goals, but I enjoy playing along as a home viewer and occasionally learning obscure bits of trivia.

Meanwhile, the *cost* factor may explain occasions in which a person sees little or no value in an activity. For example, I could undoubtedly improve my piano-playing skills with lessons and practice, but right now I have more important things to which I need to devote my time and energy. Other activities may be associated with too many bad feelings. For example, I can't imagine hang gliding or bungee jumping because I'm deathly afraid of heights. And anything likely to threaten one's self-esteem is a "must" to avoid (Eccles, 2005; Wigfield, 1994). For example, you may know individuals who rarely make the first move with people they'd like to date for fear of being rejected.<sup>3</sup>

In addition to the importance, utility, interest, and cost factors, *culture* undoubtedly influences values as well. In particular, the people in one's life may, through everyday communications and activities, continually convey the belief that certain things are worth doing in their own right (Eccles, 2005, 2007; Hickey & Granade, 2004; Hufton, Elliot, & Illushin, 2002). When we address the topic of *internalized motivation* later in the chapter, we'll identify one possible mechanism through which children adopt the values of the people around them.

Expectancies and values also influence *each other*. More specifically, people who don't expect to do well in a particular activity may find reasons to devalue it. And people who don't value an activity are less likely to work hard at it and so have lower expectancies about their performance. As children move through the grade levels, they increasingly attach value to activities for which they have high expectancy for success and to activities they think will help them meet long-term goals. Meanwhile, they begin to *devalue* the things they do poorly. Sadly, students' expectancies and values related to many school-related domains (e.g., math, English, music, and sports) decline markedly over the school years (Archambault, Eccles, & Vida, 2010; Eccles, 2009; Eccles et al., 1998; Jacobs, Lanza, Osgood, Eccles, & Wigfield, 2002; Wigfield et al., 2004).

## GOALS

---

Goals figure prominently in theories of motivation. In our discussion of motivation's general effects in the preceding chapter, we noted that motivation revolves around the accomplishment of certain goals, with such goals influencing both the choices people make and the consequences they find reinforcing. People's goals also influence their cognitive processing; for instance, goals affect the extent to which learners become cognitively engaged in particular tasks and the cognitive strategies they use to study and learn (E. M. Anderman & Maehr, 1994; Brickman, Miller, & Roedel, 1997; Locke & Latham, 2006; R. B. Miller & Brickman, 2004; Nolen, 1996). Furthermore, goal attainment results in considerable self-satisfaction, enhances self-efficacy, and

---

<sup>3</sup>In Chapter 5, I mentioned that learners sometimes engage in a cost–benefit analysis when deciding whether to engage in certain, potentially reinforceable behaviors. Such an analysis fits comfortably within an expectancies/values framework. In particular, we can expect that people *won't* exhibit a behavior if they think they'll have to exert an inordinate amount of effort to achieve success or if they place little value on the activity and its consequences.

leads to higher standards for future performance (Bandura, 1986, 1989; Zimmerman, 2010). We must note, however, that goals are beneficial only to the extent that they're accomplishable. If they're unrealistically high—for instance, if learners expect error-free perfection—consistent failure to achieve them may result in excessive stress, frustration, or depression (Bandura, 1986; Blatt, 1995; F. A. Dixon, Dungan, & Young, 2003).

Researchers have identified a wide variety of goals that people may have, including these:

- Gaining physical comfort and personal well-being
- Obtaining extrinsic, concrete rewards
- Doing well in school (e.g., getting good grades)
- Mastering new topics or skills
- Gaining a better understanding of the world
- Achieving and maintaining a sense of competence and self-worth
- Finding novelty and adventure
- Engaging in activities requiring intellectual or artistic challenge and creativity
- Developing productive interpersonal relationships
- Achieving a desired career
- Gaining material wealth
- Contributing to the welfare of others or to the general betterment of society
- Achieving a sense of spiritual understanding or harmony (A. P. Fiske & Fiske, 2007; Ford & Smith, 2007; J. Q. Lee, McInerney, Liem, & Ortiga, 2010; Schutz, 1994; Urdan & Maehr, 1995)

Some of these goals are well within conscious awareness. Others may lie below the surface, out of conscious awareness but influencing learners' behaviors nonetheless (Eitam, Hassin, & Schul, 2008; Gollwitzer & Bargh, 2005; J. Y. Shah, 2005).

Most human beings have and strive to achieve many of the goals just listed. For example, I achieve some degree of physical comfort by occasionally popping Cheetos into my mouth, I strive to affirm my high sense of self-worth by playing along at home as I watch television game shows, and I try to make a good impression on family and friends (or at least try not to look like a complete klutz) as I attempt parallel turns on the ski slope. But many of us have **core goals**—general goals of considerable priority for us at any given point in time—that seem to drive much of what we do (Schutz, 1994). For instance, my own Number One goal for many years has been to be a productive member of society—to leave the world a better place than I found it—and many of my behaviors (e.g., trying to raise socially responsible children, supporting friends through difficult times, and writing books that can help teachers and other professionals understand and apply psychological principles) have in one way or another been directed toward that end.

Here we'll focus on research findings related to several kinds of goals: achievement goals, work-avoidance goals, social goals, and career goals.

## Achievement Goals

As I mentioned in the preceding chapter, the need for achievement (also known as *achievement motivation*) was originally conceptualized as a general characteristic that people exhibit consistently across a variety of tasks and in many domains. But some contemporary psychologists have proposed that achievement motivation is somewhat situation-specific and can take several different

forms, depending on the circumstances. To illustrate, let's consider what each of three girls might be thinking during the first day of a basketball unit in a physical education class:

- Jane: This is my chance to show all the girls what a great basketball player I am. If I stay near the basket, Joan and June will keep passing to me, and I'll score a lot of points. I can really impress Coach and my friends.
- Joan: Boy, I hope I don't screw this up. If I shoot at the basket and miss, I'll look like a real jerk. Maybe I should just stay outside the 3-point line and keep passing to Jane and June.
- June: I'd really like to become a better basketball player. I can't figure out why I don't get more shots into the basket. I'll ask Coach to give me feedback about how I can improve my game. Maybe some of my friends will have suggestions as well.

All three girls want to play basketball well but for different reasons. Jane is concerned mostly about her performance—that is, about looking good in front of her coach and classmates—and so wants to maximize opportunities to demonstrate her skill on the court. Joan, too, is concerned about the impression she'll make, but she just wants to make sure she *doesn't* look *bad*. Unlike Jane and Joan, June isn't even thinking about how her performance will appear to others. Instead, she's interested mainly in developing her skill—in mastering the game of basketball—and doesn't expect herself to be an expert on the first day. For June, making mistakes is an inevitable part of learning a new skill, not a source of embarrassment or humiliation.

June's approach to basketball illustrates a **mastery goal**<sup>4</sup>—a desire to achieve competence by acquiring additional knowledge or mastering new skills. In contrast, Jane and Joan are each setting a **performance goal**<sup>5</sup>—a desire to present oneself as competent in the eyes of others. More specifically, Jane has a **performance-approach goal**: She wants to look good and receive favorable judgments from others. Meanwhile, Joan has a **performance-avoidance goal**: She wants *not* to look bad and receive unfavorable judgments. In essence, a mastery goal focuses on the *task*, whereas a performance goal focuses on the *self*. Performance goals often have an element of social comparison: Learners are concerned about how their accomplishments compare to those of their peers. In mastery goals, however, other people's performance is used only as a gauge to judge what mastery might ideally look like (Elliot & Thrash, 2001; Elliot, 2005; Grant & Dweck, 2003; Midgley et al., 1998; Nicholls, 1992; Régner, Escribe, & Dupeyrat, 2007).<sup>6</sup>

---

<sup>4</sup>Theorists are referring to a similar idea when they talk about *learning goals*, *task goals*, *task involvement*, or *task orientation*. Psychologists sometimes like to stick to certain terminology to indicate the particular theoretical traditions on which they're building (P. K. Murphy & Alexander, 2000). However, the inconsistency in terms can be frustrating for newcomers to the field, because it interferes with their ability to synthesize what they're seeing in the research literature. As I present research findings in this section, I'll be drawing on multiple programs of research and basically ignoring any subtle distinctions that theorists assign to the terms they use.

<sup>5</sup>You may also see the terms *ability goals*, *ego involvement*, or *ego orientation*.

<sup>6</sup>Increasingly, theorists have been arguing that mastery goals can, like performance goals, be either approach oriented or avoidance oriented in nature (L. H. Anderman & Anderman, 2009; Elliot, 1999, 2005; Elliot & Murayama, 2008; Jagacinski, Kumar, & Boe, 2003; Madjar, Kaplan, & Weinstock, 2010; Linnenbrink & Pintrich, 2002; K. E. Ryan, Ryan, Arbuthnot, & Samuels, 2007; Witkow & Fuligni, 2007). However, research on this distinction has been limited, and results have been inconsistent—and so we won't consider it here.

Mastery goals, performance-approach goals, and performance-avoidance goals aren't necessarily mutually exclusive. People may simultaneously have two kinds, or even all three (E. M. Anderman & Maehr, 1994; Daniels et al., 2008; Hidi & Harackiewicz, 2000; J. Q. Lee et al., 2010). For example, returning to our basketball example, we could imagine a fourth girl, Jeanne, who wants to improve her basketball skills *and* look good in front of peers *and* not come across as a klutz.

### ***Effects of Achievement Goals***

A considerable body of research indicates that mastery goals are the optimal situation. In fact, research findings regarding mastery goals versus performance-avoidance goals are similar to findings for motive for success versus motive to avoid failure (see Chapter 16). As Table 17.1

**Table 17.1**  
Characteristics of learners with mastery versus performance goals

Learners with Mastery Goals	Learners with Performance Goals (Especially Those with Performance-Avoidance Goals)
Are more likely to be actively engaged in classroom activities and intrinsically motivated to learn classroom subject matter	Are more likely to be extrinsically motivated (i.e., motivated by expectations of external reinforcement and punishment) and more likely to cheat to obtain good grades
Believe that competence develops over time through practice and effort; persist in the face of difficulty	Believe that competence is a stable characteristic (people either have talent or they don't); think that competent people shouldn't have to try very hard; give up quickly when facing difficulty
Exhibit more self-regulated learning and behavior	Exhibit less self-regulation
Use learning strategies that promote true comprehension and complex cognitive processes (e.g., elaboration, comprehension monitoring, transfer)	Use learning strategies that promote only rote learning (e.g., repetition, copying, word-for-word memorization); may procrastinate on assignments
Choose tasks that maximize opportunities for learning; seek out challenges	Choose tasks that maximize opportunities for demonstrating competence; avoid tasks and actions (e.g., asking for help) that might make them look incompetent
Are more likely to undergo conceptual change when confronted with convincing evidence that contradicts current beliefs	Are less likely to undergo conceptual change, in part because they're less likely to notice the discrepancy between new information and existing beliefs
React to easy tasks with feelings of boredom or disappointment	React to success on easy tasks with feelings of pride or relief
Seek feedback that accurately describes their ability and helps them improve	Seek feedback that flatters them
Willingly collaborate with peers when doing so is likely to enhance learning	Are willing to collaborate with peers primarily when doing so can help them look competent or enhance social status
Evaluate their performance in terms of the progress they make	Evaluate their performance in terms of how they compare with others

(Continued)

**Table 17.1** (Continued)

Learners with Mastery Goals	Learners with Performance Goals (Especially Those with Performance-Avoidance Goals)
Interpret failure as a sign that they need to exert more effort	Interpret failure as a sign of low ability and therefore predictive of future failures
View errors as a normal and useful part of the learning process; use errors to improve performance	View errors as a sign of failure and incompetence; engage in self-handicapping to provide apparent justification for errors and failures
Are satisfied with their performance if they try hard and make progress	Are satisfied with their performance only when they succeed; are apt to feel ashamed and depressed when they fail
View a teacher as a resource and guide to help them learn	View a teacher as a judge and as a rewarder or punisher
Remain relatively calm during tests and classroom assignments	Are often quite anxious about tests and other assessments
Are more likely to be enthusiastic about, and become actively involved in, school activities	As students, are more likely to distance themselves from the school environment; may suffer from chronic depression
Achieve at higher levels	Achieve at lower levels

*Sources:* Ablard & Lipschultz, 1998; E. M. Anderman et al., 1998; E. M. Anderman & Maehr, 1994; L. H. Anderman & Anderman, 2009; Bandalos, Finney, & Geske, 2003; Cao, 2010; L. H. Chen, Wu, Kee, Linn, & Shui, 2009; DeBacker & Crowson, 2006; Dweck, 1986, 2000; Dweck, Mangels, & Good, 2004; Gabriele, 2007; Gabriele & Montecinos, 2001; Grant & Dweck, 2003; Hardré, Crowson, DeBacker, & White, 2007; Jagacinski & Nicholls, 1984, 1987; A. Kaplan & Midgley, 1999; Lau & Nie, 2008; Levy, Kaplan, & Patrick, 2004; Liem, Lau, & Nie, 2008; Linnenbrink & Pintrich, 2002, 2003; Locke & Latham, 2006; McGregor & Elliot, 2002; Meece, 1994; Middleton & Midgley, 1997; Newman & Schwager, 1995; Nolen, 1996; Pekrun, Elliot, & Maier, 2009; Poortvliet & Darnon, 2010; Pugh, Linnenbrink, Kelly, Manzey, & Stewart, 2006; Rawsthorne & Elliot, 1999; A. M. Ryan, Pintrich, & Midgley, 2001; Senko & Harackiewicz, 2005; Shernoff & Hoogstra, 2001; Shim, Ryan, & Anderson, 2008; Sideridis, 2005; Sinatra & Mason, 2008; Sins, van Joolingen, Savelsbergh, & van Hout-Wolters, 2008; Skaalvik, 1997; Southerland & Sinatra, 2003; Tossman, Kaplan, & Assor, 2008; Urda, 2004; Wolters, 2004.

illustrates, students with mastery goals tend to engage in the very activities that will help them learn: They pay attention in class, process information in ways that promote effective long-term memory storage, and learn from their mistakes. Furthermore, students with mastery goals have a healthy perspective about learning, effort, and failure: They realize that learning is a process of trying hard and continuing to persevere even in the face of temporary setbacks. Consequently, it's usually these students who learn the most from their classroom experiences.

In contrast, students with performance goals—especially those with performance-avoidance goals—may stay away from some of the very tasks that, because of their challenging nature, would do the most to promote mastery of new skills. Furthermore, these students often experience debilitating anxiety about tests and other classroom tasks. Performance-approach goals are a mixed bag: They sometimes have very positive effects, spurring students to achieve at high levels, especially in combination with mastery goals and high self-efficacy (Hardré, Crowson, DeBacker, & White, 2007; A. Kaplan, Middleton, Urda, & Midgley, 2002; Liem, Lau, & Nie, 2008; Linnenbrink, 2005; Senko & Harackiewicz, 2005). Yet by themselves, performance-approach goals may be less beneficial than mastery goals: To achieve them, students may use

relatively superficial learning strategies (e.g., rote memorization), exert only the minimal effort necessary to achieve desired outcomes, engage in self-handicapping, and perhaps cheat on assessments. Furthermore, learners with performance-approach goals find less pleasure in what they're doing than do learners with mastery goals. Performance-approach goals appear to be most detrimental when students are younger (e.g., in the elementary grades), have relatively low ability in the subject area, and have low self-efficacy for classroom tasks (E. M. Anderman, Griesinger, & Westerfield, 1998; L. H. Chen, Wu, Kee, Linn, & Shui, 2009; Daniels et al., 2008; Hidi & Harackiewicz, 2000; Midgley, Kaplan, & Middleton, 2001; Muis & Franco, 2009; Pekrun, Elliot, & Maier, 2009).

Some learners seem to choose mastery goals over performance goals fairly consistently (L. H. Anderman & Anderman, 2009; Senko & Harackiewicz, 2005; Senko & Miles, 2008; L. A. Turner & Johnson, 2003). These people can be thought of as having a strong **motivation to learn**—a tendency to find learning activities meaningful and worthwhile and therefore to attempt to get the maximum benefit from them (Brophy, 2004, 2008; McCombs, 1988). This concept puts a new twist on the concept of achievement motivation: People want to engage in the cognitive processes that lead to successful learning as well as the behaviors that lead to observable achievements.

### ***Origins of Achievement Goals***

In some cases, mastery goals come from within. People are more likely to have mastery goals when they have high interest in a topic or activity—perhaps because it's an important part of their personal identity—and high self-efficacy for learning it (Harackiewicz et al., 2008; A. Kaplan & Flum, 2009; P. K. Murphy & Alexander, 2000; C. R. Snyder et al., 2002). For example, when my son Alex was about 12 years old, his interest in lizards led him to subscribe to an adult-level herpetology magazine and read every issue from cover to cover. Similarly, people interested in antique automobiles might tinker with a Ford Model T engine until they know the engine inside and out. And people interested in gymnastics might spend a good portion of their free time at the gym practicing, practicing, practicing.

Yet the instructional environment can encourage mastery goals as well (M. A. Church, Elliot, & Gable, 2001; A. Kaplan et al., 2002; Newman, 1998).<sup>7</sup> For instance, teachers might describe the intrinsic benefits of learning a skill, focus students' attention on the progress being made, or communicate their own goal of having students understand rather than rote-memorize classroom subject matter. In fact, *insisting* that students understand—a **press for understanding**—may be especially helpful (Danner, 2008; Fredricks, Alfeld, & Eccles, 2010; Middleton & Midgley, 2002; J. C. Turner et al., 1998). For example, teachers might continually ask students to explain and justify their reasoning, and they might refuse to accept substandard work that reflects little thought or effort.

Unfortunately, however, performance goals seem to be far more prevalent than mastery goals among today's students, especially those in the secondary grades (Blumenfeld, 1992; Bong, 2009; Elliot & McGregor, 2000; M. Lee, Lee, & Bong, 2010). Most students, if they're motivated to succeed in their schoolwork, are primarily concerned about getting good grades, and they prefer short, easy tasks to lengthier, more challenging ones. Performance goals are also common in

---

<sup>7</sup>Some motivation theorists use the term *achievement goal orientations* in reference to goals that come from within and *achievement goal structures* in reference to goals that are presented or encouraged by the instructional environment (e.g., Midgley, 2002; Wolters, 2004).

team sports, where the focus is often more on winning and gaining public recognition than on developing new skills and improving over time (Roberts, Treasure, & Kavussanu, 1997).

In some instances students adopt performance goals as a means of avoiding failure, protecting their sense of self-worth, or—especially if their need for relatedness is high—enhancing relationships with peers. In other cases students realize that performing at high levels—in particular, getting good grades—is critical for their future educational and professional opportunities (L. H. Anderman & Anderman, 1999; Covington, 1992; Covington & Müeller, 2001; Elliot & McGregor, 2000; Urdan & Mestas, 2006).

Many common teaching and coaching practices also contribute to the development of performance goals. Posting “best” papers on the wall, scoring tests on a curve, focusing on surpassing other schools and teams, reminding students that good grades are important for college admissions—all of these strategies, though undoubtedly well intended, encourage learners to focus their attention more on “looking good” than on learning. (L. H. Anderman & Anderman, 1999; M. A. Church et al., 2001; A. Kaplan et al., 2002; Lau & Nie, 2008; Roberts et al., 1997).

Even simply *attending* school can increase youngsters’ focus on performance goals. When children are young, they seem to focus primarily on mastery goals (Bong, 2009; Dweck & Elliott, 1983). But when they begin school at age 5 or 6, two things happen that begin to orient them more toward performance goals (Dweck & Elliott, 1983). First, they suddenly have many peers to whom they can compare their own behavior; as a result, they may begin to define success more in terms of doing better than classmates than in terms of task mastery. Second, whereas they’ve previously dealt primarily with physical tasks (e.g., learning to walk, fasten buttons, and ride a tricycle), they’re now being asked to deal with tasks of an intellectual and somewhat abstract nature (e.g., learning to read, write, and solve word problems). The value of these school tasks may not be readily apparent to them, and their efforts in accomplishing them might therefore seem unnecessarily laborious. Furthermore, they may have greater difficulty assessing their progress on such tasks, to the point where they must rely on others (e.g., teachers) to make judgments about their competence. As learners approach adolescence, yet another factor kicks in: They’re more likely to worry about what others think of them than they were in their early years (Hartup, 1983; Juvonen, 2000; Midgley, 1993).

Yet school is hardly the only environment influencing the acquisition of various achievement goals. Parents may encourage their toddlers and preschoolers to attempt and persist at challenging activities, on the one hand, or consistently chastise them for poor performance, on the other (L. A. Turner & Johnson, 2003). Furthermore, through the particular behaviors and values that are sanctioned and discouraged, different cultures may predispose children toward certain kinds of goals. For instance, cultures with a strong competitive element—as tends to be true in North American and some western European countries—may lead children to focus on performance goals. And cultures that instill in children a fear of bringing shame to themselves or their families—as is sometimes true in Asian families—can lead children to adopt performance-avoidance goals (Elliot, Chirkov, Kim, & Sheldon, 2001; Freeman, Gutman, & Midgley, 2002; A. Kaplan et al., 2002).

In recent years, achievement goal theory has largely dominated discussions of motivation in educational research journals (e.g., *Journal of Educational Psychology*). With such a strong presence, psychologists have observed its weaknesses as well as its strengths. Some theorists have argued that mastery and performance goals are heterogeneous categories that encompass more specific goals—goals related to achieving particular outcomes, comparing favorably with peers, validating one’s sense of competence, and so on (Brophy, 2004, 2005; Grant & Dweck, 2003).



The actual effects of various goals seem to depend on the nature of the particular task and context at hand (Elliot, Shell, Henry, & Maier, 2005). Furthermore, relationships between students' achievement goals and their classroom achievement tend to be weak ones at best, probably because students have many nonachievement-oriented goals that also influence their classroom performance (Boekaerts, de Koning, & Vedder, 2006; Brophy, 2004). And in fact, when students are simply asked to describe what they want to accomplish at school (rather than to respond to researcher-written statements on questionnaires), many seem to be more concerned about work-avoidance and social goals than about achievement goals (Brophy, 2005; Dowson & McInerney, 2001; Tobias & Everson, 2009; Urdan & Mestas, 2006). Such goals are our next two topics.

## Work-Avoidance Goals

As we've just seen, students sometimes want to avoid looking bad as they perform classroom tasks. But on other occasions, they may want to avoid having to do classroom tasks *at all*, or at least to exert as little effort as possible. In other words, they may have a **work-avoidance goal** (Dowson & McInerney, 2001; Gallini, 2000; Jagacinski, Kumar, Lam, & Lustenberger, 2008; Nicholls, Cobb, Yackel, Wood, & Wheatley, 1990).

Students with work-avoidance goals use a variety of strategies to minimize their workload. For instance, they may engage in off-task behaviors, solicit help on easy tasks and problems, pretend they don't understand something even when they *do*, complain loudly about challenging assignments, and select the least taxing alternatives whenever they have choices (Dowson & McInerney, 2001). They rarely use effective learning strategies or pull their weight in small-group activities (Dowson & McInerney, 2001; Gallini, 2000). At the college level—which gives students considerable leeway in how they schedule their time—students with work-avoidance goals are apt to put off doing assignments until the last minute (Cao, 2010; S. W. Park & Sperling, 2009; Wolters, 2003b).

In some instances peers may encourage and model work-avoidance behaviors (Nolen, 1996). More often, however, students are likely to adopt work-avoidance goals when they find little pleasure and value in academic subject matter, have low self-efficacy for learning it, and see no long-term payoffs for mastering it (Fletcher & Cassidy, 2010; Garner, 1998; Jagacinski et al., 2008; Wolters, 2003b). In other words, students are most likely to have work-avoidance goals when they have neither intrinsic nor extrinsic motivation to achieve instructional objectives. Students with work-avoidance goals may thus be among teachers' biggest challenges, and teachers will have to use a variety of motivational strategies—probably including extrinsic reinforcers—to get them engaged in, and eventually committed to mastering, important academic topics and skills.

## Social Goals

In Chapter 16, we noted that most students make social relationships a high priority, and in fact all human beings probably have some need for relatedness. Learners are apt to have a variety of social goals, perhaps including the following:

- Gaining other people's approval
- Forming and maintaining friendships
- Finding a spouse or other long-term mate

- Developing effective social skills
- Achieving status and prestige among peers (e.g., being one of the “popular kids”)
- Gaining power and control over others
- Being part of a cohesive, mutually supportive group
- Meeting social obligations and keeping interpersonal commitments
- Being a “good citizen” (e.g., following classroom rules, not unnecessarily distracting classmates from assigned tasks)
- Assisting and supporting others, and ensuring their welfare
- Being a source of honor and pride for one’s family or community (Dowson & McInerney, 2001; A. P. Fiske & Fiske, 2007; Ford, 1996; Ford & Smith, 2007; Hinkley, McInerney, & Marsh, 2001; Kiefer & Ryan, 2008; Li, 2005; Patrick, Anderman, & Ryan, 2002; A. M. Ryan & Shim, 2008; Schutz, 1994)

The nature of students’ social goals clearly affect their classroom behavior and academic performance. If students want to gain their teacher’s attention and approval, they’re apt to strive for good grades and in other ways enhance their classroom performance (Hinkley et al., 2001). If they’re seeking friendly relationships with classmates or are concerned about other people’s welfare, they may eagerly and actively engage in such activities as cooperative learning and peer tutoring; concern for others’ welfare may also foster mastery goals (L. H. Anderman & Anderman, 1999; Dowson & McInerney, 2001).

Not all social goals are productive ones, of course. For instance, if students are especially concerned about their social status, they may be willing to cooperate with classmates only if doing so maintains or enhances their standing in the eyes of peers (Levy, Kaplan, & Patrick, 2004). If students want the approval of low-achieving peers, they may exert little effort in their studies and possibly adopt work-avoidance goals (B. Brown, 1990; Ford & Nichols, 1991). And if they want to gain a sense of power over others, they’re apt to bully vulnerable classmates (Kiefer & Ryan, 2008; Pellegrini & Long, 2004).

## Career Goals

Most children and adolescents include career goals among their long-term goals. Young children set such goals with little thought and change them frequently; for instance, a 6-year-old may want to be a firefighter one week and a professional basketball player the next. By late adolescence, some (though by no means all) have reached some tentative and relatively stable decisions about the career paths they want to pursue (e.g., Lapan, Tucker, Kim, & Kosciulek, 2003; Marcia, 1980).

Despite high aspirations, many young people, especially those raised in fairly traditional cultures, tend to limit themselves to gender-stereotypical careers. Even as traditional boundaries between what professions are “appropriate” for men and women are slowly melting away, the majority of college students enrolled in engineering programs continue to be men, and the majority of education majors continue to be women. Certainly gender stereotypes aren’t the only things affecting learners’ career goals; self-efficacy, expectancies, values, and social goals are also involved. For instance, on average, females are more interested in the helping professions than males are, and they’re more concerned about juggling the demands of the workplace with the demands of raising a family (Diekman, Brown, Johnston, & Clark, 2010; Eccles, 2005; Hemmings, 2004; Olneck, 1995; Weisgram, Bigler, & Liben, 2010).

## Coordinating Multiple Goals

At any one time, people are apt to be working toward several goals. At school, for instance, students may be simultaneously concerned about learning and understanding classroom subject matter, earning the good grades so important for college admissions, and enhancing social relationships with peers.

Addressing multiple goals simultaneously can be a challenging task indeed. People use a variety of strategies to juggle their diverse goals (Covington, 2000; Dodge, Asher, & Parkhurst, 1989; M. Hofer, 2010; McCaslin & Good, 1996). They may engage in activities that allow them to address more than one goal—for instance, joining a study group as a way of satisfying both achievement goals and social goals. Alternatively, they may pursue some goals while putting others on the back burner. For example, students might complete assignments important for class grades while temporarily ignoring more enticing topics. Likewise, as I pursue the goal of completing this book, I leave dirty dishes in the sink, thereby ignoring my lower-priority goal of having a clean house. People may also modify their ideas of what it means to achieve a particular goal. For example, as I've become increasingly busy with my professional writing in recent years (thereby, I hope, satisfying my desire to make the world a better place), my definition of a clean house has deteriorated rapidly from being a spotless, Martha Stewart-like home to one in which I try to keep all the clutter in semi-tidy piles.

People are most successful and experience better emotional well-being when their multiple goals all lead them in the same direction (M. Hofer, 2010; Locke & Latham, 2006; Schultheiss & Brunstein, 2005; Wentzel, 1999). Yet in some situations, accomplishing one goal simply isn't compatible with accomplishing another. For example, achieving at a high level in the classroom may interfere with one's ability to maintain a friendship with a peer who doesn't value academic achievement. On such occasions, people may have little choice but to abandon one goal in favor of another, at least for the time being (Boekaerts et al., 2006; McCaslin & Good, 1996; J. Y. Shah, 2005). Quite possibly, human beings' evolutionary heritage comes into play here, leading people to forsake the "luxuries" of one's culture (e.g., learning to read) for more basic needs (e.g., maintaining social connectedness with others) (Geary, 1998).

Although we've identified several cognitive factors affecting motivation, we've largely ignored a very important one: the extent to which people make a *connection* between what they do and what happens to them. Certainly people are more eager to pursue an activity when they think their behaviors will help them achieve their goals. But some individuals fail to recognize existing contingencies between the behaviors they exhibit and the consequences that result. To what sources do people attribute the events that occur in their lives? To what things do they give credit when they succeed? What things do they blame when they fail? Our discussion of attributions in the next section will shed light on these questions.

## ATTRIBUTIONS

---

You've undoubtedly gotten As on some of the classroom exams you've taken. On those occasions, why do you think you did so well? Did you study hard? Were the exams easy? Did you get lucky and guess right about topics you knew little about? Or is it simply that you're an incredibly intelligent human being?

Now let's consider those exams on which you haven't done as well. On what did you blame your failures? Did you spend too little time studying, or did you perhaps study the wrong things? Were the exams too difficult? Were questions poorly worded, leading you to misinterpret them? Were you too tired or ill to think clearly? Or do you just not have what it takes?

People's various explanations for success and failure—their beliefs about what causes what—are **attributions**. People are often eager to identify the probable causes of things that happen to them, especially when events are unexpected—for instance, when they get a low score on a classroom assignment after thinking they've done a good job. Forming attributions is just one of the many ways in which human beings try to make better sense of their world (Stupnisky, Perry, Hall, & van Winkel, 2006; Tollefson, 2000; Weiner, 1986, 2000). In this case, people are trying to identify cause-and-effect relationships regarding events that affect them personally.

People are apt to explain events in a variety of ways. For instance, school children may attribute their successes and failures in the classroom to such things as effort, ability, luck, task difficulty, health, mood, physical appearance, or teachers' or peers' behaviors (Schunk, 1990). Attributions are as much a function of *perception* as of reality; thus, they're often distorted in line with existing beliefs about oneself and about how the world operates. For example, your poor performance on past exams may very well have been the result of ineffective study strategies; like many students, you may have tried to learn class material in a rote, meaningless manner (you obviously hadn't read this book yet). But because you thought of yourself as a smart person and believed you *had* studied adequately, you perhaps instead attributed your low scores to the exceptional difficulty or “pickiness” of your tests or to arbitrary and irrational teacher scoring.

People's attributions appear to vary in terms of three key dimensions: locus, stability, and controllability (Weiner, 1986, 2000, 2004).<sup>8</sup>

**Locus (“place”): Internal versus external** We sometimes attribute the causes of events to *internal* things—that is, to factors within ourselves. Thinking that a good grade is the result of your hard work and believing that a poor grade is the result of your lack of ability are examples of internal attributions. At other times, we attribute events to *external* things—to factors outside of ourselves. Concluding that you received a scholarship because you were lucky and interpreting a friend's scowl as being due to her bad mood (rather than to anything you might have done to deserve the scowl) are examples of external attributions.

Some theorists have referred to the “locus” dimension as *locus of control*. However, Weiner (1986, 2000) has pointed out that *locus* and *control* are probably two distinctly different aspects of an attribution. For instance, one's singing ability may be internal but in many people's opinions isn't entirely controllable.

**Temporal stability: Stable versus unstable** Sometimes we think that events are a result of *stable* factors—things that probably won't change much in the near future. For example, if you believe that you do well in school because of inherited ability or that you have trouble making friends because you have a funny-looking nose, you're attributing events to stable, relatively unchangeable causes. But sometimes we instead believe that events are the result of *unstable* factors—to things that can change from one time to the next. Thinking that winning a tennis

---

<sup>8</sup>In earlier writings, Weiner suggested two additional dimensions: *cross-situational generality* (global versus specific) and *intentionality* (intentional versus unintentional). More recently, however, he has focused primarily on locus, stability, and controllability (e.g., Weiner, 2004, 2005).

game was simply a fluke and believing that you got a bad test grade because you misinterpreted the instructions are examples of attributions involving unstable factors.

**Controllability: Controllable versus uncontrollable** On some occasions we attribute events to *controllable* factors—to things that we (or perhaps someone else) can influence and change. For example, if you believe a classmate invited you to lunch because you always smile and say nice things to her, and if you think you probably failed a test simply because you didn't study the right things, you're attributing these events to controllable factors. On other occasions, we attribute events to *uncontrollable* factors—to things over which neither we nor others have influence. For example, if you think that you were chosen for a title role in *Romeo and Juliet* because you have the "right face" for the part, or that you played a lousy game of basketball because you had the flu, you're attributing these events to uncontrollable factors.

Attribution theory's notion of controllability overlaps with—yet is also somewhat different from—the concept of *self-determination* (Deci & Ryan, 1987). Attribution to controllable factors involves a belief that we can influence and alter environmental events and circumstances. In contrast, self-determination involves a belief that we can autonomously choose our behaviors and, ultimately, our fate. In other words, controllable attributions reflect control of one's *environment*, whereas self-determination reflects long-term control of one's *actions*.

The controllability dimension possibly has two subcomponents (Weisz & Cameron, 1985). First, one must believe there is a *contingency* between the behavior and the outcome—in other words, that a particular behavior can cause a certain event to occur. Second, one must have a sense of *competence* (i.e., self-efficacy) that one is actually capable of performing the necessary behavior. A person is apt to believe an event is uncontrollable if either one of these components is missing. For example, a student may know that good grades will result from making correct responses in class but may not believe he or she has the ability to make those responses; in this situation there's a sense of contingency but no sense of competence (Weisz, 1986). As another example, a person from a minority group may have high self-efficacy for achieving a particular goal yet feel that the racial prejudice and discrimination of others will, nevertheless, make success impossible; in this case there's a sense of competence but no sense of contingency (Pintrich & Schunk, 2002; Sue & Chin, 1983; Weiner, 2004).

We can analyze virtually any attribution in terms of the three dimensions just described. For example, viewing success on a task as being the result of inherited ability is an internal, stable, and uncontrollable attribution. Believing that failure on a task was a case of bad luck is an external, unstable, and uncontrollable attribution. Table 17.2 analyzes eight common attributions in terms of the three dimensions.

As you look at Table 17.2, you might think that "ability can change with practice and therefore is unstable and controllable" or that "teachers' attitudes toward students often depend on how students behave in class and so are really the result of student-controllable factors." Perhaps you're right, but keep in mind that people's *beliefs* about locus, stability, and controllability—not the reality of the situation—are what affect future behavior (Dweck & Leggett, 1988; Weiner, 1994).

What about *effort* (trying or not trying hard) and *luck* (either good or bad)? Are these temporary states of affairs, or are they enduring qualities that tend to bless or haunt us time after time? People occasionally think of effort and luck as being relatively stable, enduring characteristics; for instance, they may believe that people are consistently lucky or unlucky (Weiner, 1986). To be

**Table 17.2**  
Analyzing various attributions in terms of the three dimensions

Success or Failure Attributed to	Locus	Stability	Controllability
Inherited ability	Internal	Stable	Uncontrollable
Personality	Internal	Stable	Uncontrollable
Effort	Internal	Unstable	Controllable
Health	Internal	Unstable	Uncontrollable
Energy level	Internal	Unstable	Uncontrollable
Task difficulty	External	Stable	Uncontrollable for oneself; possibly controllable for a teacher
Teacher attitudes	External	Stable	Uncontrollable for oneself; controllable for the teacher
Luck or chance	External	Unstable	Uncontrollable

consistent with much of the literature in attribution theory, however, we'll treat both effort and luck as unstable, temporary factors in our discussions here.

And what about *intelligence*? Whether intelligence is actually a stable or unstable characteristic is a matter of considerable controversy among psychologists. Nonpsychologists, too, are divided on the matter. Some children and adults have an **entity view**: They believe intelligence is a “thing” that is fairly permanent and unchangeable. Others have an **incremental view**: They believe intelligence can and does improve with effort and practice (Dweck & Molden, 2005; Dweck & Leggett, 1988; Weiner, 1994).<sup>9</sup> Because I can't offer a definitive answer about the nature of intelligence, I've omitted it from Table 17.2; I've instead included “inherited ability,” which is presumably stable and uncontrollable.

## Effects of Attributions

Attributions appear to have a significant influence on learners' performance and achievement in classroom settings (Blackwell, Trzesniewski, & Dweck, 2007; J. A. Chen & Pajares, 2010; Dweck et al., 2004; Graham, 1994; Stipek & Gralinski, 1996). In particular, attributions influence learners' emotional responses, reactions to reinforcement and punishment, self-efficacy and expectancies, effort and persistence, learning strategies, and future choices and goals—all of which, in turn, have an impact on learning and achievement.

**Emotional responses to events** Learners are, of course, happy when they succeed and sad when they fail. But they're apt to feel *self-conscious emotions*—for instance, pride about a success and shame or guilt about a failure—only if they attribute their performance to things they themselves have done. Unpleasant as shame and guilt might feel, such emotions often spur learners to

<sup>9</sup>Entity versus incremental views of intelligence are examples of *epistemic beliefs*—in particular, beliefs about the nature of learning ability (see Chapter 14).

address their shortcomings. If, instead, learners think someone else was to blame for an undesirable outcome, they're apt to be angry—an emotion that's unlikely to lead to productive follow-up behaviors (Hareli & Weiner, 2002; R. Neumann, 2000; Pekrun, 2006).

**Reactions to reinforcement and punishment** People's interpretations of the reinforcements and punishments they experience—for example, whether they think an event is the result of something they themselves have done or instead the result of something that has been done to them—influence the long-term effects that reinforcement and punishment are likely to have. Consistent with our discussion of social cognitive theory in Chapter 6, reinforcement and punishment can be effective only when people realize that *their own behavior*—something over which they have control—has been the cause of such consequences (Bandura, 1986).

**Self-efficacy and expectancies** When learners attribute their successes and failures to stable factors—perhaps to innate ability or *inability*—they expect their future performance to be similar to their current performance. In contrast, when they attribute successes and failures to *unstable* factors—for instance, to effort or luck—their current success rate has little influence on their future expectations (Dweck, 2000; Schunk, 1990; Weiner, 1986, 2000). The most optimistic learners—those with the highest expectations for future success—are the ones who attribute their successes partly to stable, dependable factors, such as natural talent and a consistently supportive environment (thus they'll know that success wasn't a fluke) and partly to unstable but controllable factors such as effort and strategies (thus they'll continue to work hard). At the same time, they should attribute their past failures primarily to unstable factors they can control and change (Dweck, 2000; Hsieh & Schallert, 2008; C. B. Murray & Jackson, 1982/1983; Pomerantz & Saxon, 2001; Weiner, 1984).

With the preceding points in mind, let's return to the phenomenon of *stereotype threat*, which I previously described in Chapter 16. If we bring attributions into the mix, we can reasonably expect that members of stereotypically low-achieving groups (e.g., females, members of certain minority groups) will be most likely to have low self-efficacy about tests of ability—and so more likely to experience anxiety that adversely affects their test scores—if they have an entity view of intelligence. If they believe that the ability being assessed is a relatively permanent thing beyond their control, their anxiety is apt to go up and so their test scores will go down. If, instead, they realize that ability can and does change with effort, practice, and appropriate strategies—and so is unrelated to their group membership—they're less likely to become the victims of stereotype threat (Dweck et al., 2004; Dweck & Molden, 2005).

**Effort and persistence** In general, learners are most likely to exert effort and persist after a failure if they attribute the failure to internal, unstable, and controllable variables. But blaming *only* lack of effort can backfire. Learners who try hard and still fail are likely to reach the conclusion that they have low ability—that they simply don't have what it takes. It's more productive for learners to attribute failure also to ineffective strategies—to believe that they could succeed if they did things *differently*. Such attributions often characterize good students, who know that they need not only to work hard but also to work strategically (Curtis & Graham, 1991; Dweck, 2000; Dweck & Molden, 2005; Pressley, Borkowski, & Schneider, 1987).

Attributions and effort sometimes interact in unproductive ways. Let's once again focus in on learners with an entity view of intelligence. Entity-view learners tend to believe that ability and effort are inversely related: Success with little effort reflects high ability, and success that comes only with a great deal of effort is a sign of low ability. Such beliefs are especially prevalent when

people have performance goals rather than mastery goals (see Table 17.1). For such individuals, effort is a double-edged sword that causes harm either way it swings. In particular, those who perceive themselves as having low ability are in a no-win situation. If they don't try hard, failure is inevitable. If they *do* try hard and fail anyway, they look "stupid," at least in their own eyes. Thus, many of them don't try very hard—that is, they *self-handicap*—perhaps as a way of saving face and hiding their self-perceived low ability. They may also decide that the activity isn't worth doing—in other words, they attach little value to it (Covington & Beery, 1976; Covington & Omelich, 1979; Dweck, 1986; Eccles & Wigfield, 1985; Graham, 1990; Jagacinski & Nicholls, 1990).

**Learning strategies** People's attributions and resulting expectations for future performance clearly affect the cognitive strategies they apply to learning tasks. Students who expect to succeed in the classroom and believe that academic success is a result of their own doing are more likely to apply effective study strategies, especially when they're taught such strategies. These students are also more likely to be self-regulating learners and to seek help when they need it (more on help seeking later in the chapter). In contrast, students who expect failure and believe that their academic performance is largely out of their control often reject effective learning strategies in favor of rote-learning approaches (Dweck et al., 2004; Dweck & Molden, 2005; Palmer & Goetz, 1988; Zimmerman, 1998).

**Future choices and goals** As you might expect, students whose attributions lead them to expect success in particular subject areas or in school in general are more likely to pursue challenging courses and set their sights on completing high school (L. E. Davis, Ajzen, Saunders, & Williams, 2002; Dweck, 1986; Weiner, 1986). Learners' attributions also affect the achievement goals they set for themselves. Once again, their beliefs about intelligence—whether it's a relatively permanent entity or, alternatively, an ability that can change incrementally over time—come into play (Blackwell et al., 2007; J. A. Chen & Pajares, 2010; Dweck et al., 2004). In particular, if learners believe that ability is something they either have or don't have (rather than something they can enhance with hard work), they're apt to set performance goals and assess their "inborn" talent by comparing themselves to others. In contrast, learners who subscribe to an incremental view are apt to set mastery goals and assess their ability by monitoring their progress over time. For example, in a series of studies conducted by Dweck and her associates (described in Dweck, 2000), middle school students were told they could choose one of three tasks, which were described as follows:

1. One that's "easy enough so you won't make mistakes"
2. One that's "like something you're good at but hard enough to show you're smart"
3. One that's "hard, new and different—you might get confused and make mistakes, but you might learn something new and useful" (Dweck, 2000, p. 21)

Students with entity views were more likely to choose either Task 1 (consistent with a performance-avoidance goal) or Task 2 (consistent with a performance-approach goal). In contrast, students with incremental views more often chose Task 3 (consistent with a mastery goal).

## Factors Influencing the Nature of Attributions

Why do different people attribute the same events to different causes? For instance, why does one person believe that a failure is merely a temporary setback due to an inappropriate strategy, while another attributes the same failure to low ability, and still another believes it to be the result



of someone else's capricious and unpredictable actions? We now look at variables related to the acquisition of different attributions.

### ***Age***

Young children become increasingly able to distinguish among the various possible causes of their successes and failures: effort, ability, luck, task difficulty, and so on. One distinction they increasingly get a handle on is that between effort and ability. In the early elementary grades, children think of effort and ability as positively correlated: People who try harder are more competent. Thus they tend to attribute their successes to hard work and are usually optimistic about their chances for future success as long as they try hard. Sometime around age 9, they begin to understand that effort and ability often compensate for each other and that people with less ability may need to exert greater effort. Many begin to attribute their successes and failures to an inherited ability that they perceive to be fairly stable and beyond their control. With age, then, learners increasingly acquire an entity view of intelligence. If they're usually successful at school tasks, they have high self-efficacy for such tasks. If, instead, they often fail, their self-efficacy is likely to plummet (Dweck, 1986, 2000; Eccles et al., 1998; Heyman, Gee, & Giles, 2003; Nicholls, 1990; E. A. Skinner, 1995).

This state of affairs can lead to a **self-fulfilling prophecy**—a situation in which a person's expectations about future events create conditions through which those expectations become reality. (We'll call it *Self-Fulfilling Prophecy #1* to distinguish it from a second phenomenon we'll examine later.) As we discovered in Chapter 6, people with low self-efficacy choose less challenging tasks and give up more easily than their more self-confident peers. And as a result, they'll have fewer opportunities to discover that success *can* come with effort.

### ***Situational Cues***

Characteristics specific to the situation at hand—especially those that are easily noticed—can influence learners' attributions. Features of the task being performed are one influential characteristic; for example, complex math problems (e.g., those that include a lot of numbers) are perceived as being more difficult, and so failure to solve them can readily be attributed to task difficulty rather than to internal causes. The performance of peers provides another cue; for example, a failure is apt to be attributed to task difficulty if everyone else is failing, whereas it's more likely to be attributed to an internal source (e.g., lack of ability) if others are succeeding (Lassiter, 2002; Schunk, 1990; Weiner, 1984).

### ***Patterns of Past Successes and Failures***

Learners' attributions are also partly the results of their previous successes and failures in a particular activity or domain. Learners who have previously tried and succeeded are more likely to believe that success is the result of internal factors, such as effort or high ability. Those who have tried and failed or have had an inconsistent pattern of successes and failures are likely to believe that success is due to something beyond their control—perhaps to an ability they don't possess or to such external factors as a tough break or poor instruction (Normandeu & Gobeil, 1998; Paris & Byrnes, 1989; Pressley, Borkowski, & Schneider, 1987; Schunk, 1990).

When we consider classroom learning, metacognition also comes into play. In Chapter 14, we discovered that students often think they've learned things they actually *haven't* learned; in other words, they have an *illusion of knowing*. When these students consistently do poorly on exams, they can't attribute their performance to internal factors; after all, they studied hard and

so think they know the material. Instead, they're likely to attribute poor performance to such external factors as bad luck, exam difficulty, or teacher capriciousness (Horgan, 1990).

### ***Verbal and Nonverbal Messages from Others***

Just as people form attributions regarding the causes of their own performance, so, too, do they form attributions for *other people's* performance. For instance, I recall a conversation I once had with a well-educated man whose training was in mechanical engineering rather than psychology or education. We were discussing the fact that, on average, children in inner-city schools achieve at lower levels than children in suburban schools. Knowing that I was an educational psychologist, the man asked me why I thought there was such a difference in performance levels. I said that there were apt to be a number of reasons, probably including smaller school budgets, larger class sizes, more obligations and fewer resources at home, poor nutrition and health care, fear for personal safety, a higher proportion of children with learning disabilities and other special needs, and so on. The man seemed quite surprised. "I always thought the kids just weren't *motivated*," he said. Notice how my attributions for the low achievement were largely external ones, whereas his sole attribution—students' motivation—was strictly internal. Unfortunately, even some experienced teachers attribute students' seemingly "unmotivated" behavior largely to internal causes (Kincheloe, 2009; J. C. Turner, Warzon, & Christensen, 2011).

The three dimensions described earlier—locus, stability, and controllability—are as relevant to people's attributions for other individuals as they are to people's self-attributions. Probably the most important dimension from an interpersonal standpoint is *controllability* (Weiner, 2000). The reasons I gave my engineer friend regarding the low achievement of many inner-city students—fewer resources, poor nutrition, a dangerous environment, and so on—all involved things beyond students' control. In contrast, my friend believed that the students performed poorly only because they didn't *want* to do well; in other words, high achievement was well within their grasp if they simply flipped that mythical motivation on-off switch I mentioned at the beginning of Chapter 16.

Other people—parents, teachers, peers, and so on—communicate their attributions for learners' successes and failures in a variety of ways. In some cases, they communicate attributions verbally and explicitly (Cimpian, Arce, Markman, & Dweck, 2007; Henderlong & Lepper, 2000; C. M. Mueller & Dweck, 1998). For example, consider the things a teacher might say about a student's success:

- "That's wonderful. Your hard work has really paid off, hasn't it?"
- "You've done very well. It's clear that you really know how to study."
- "You did it! You're so smart!"
- "Terrific! This is certainly your lucky day!"

Also consider the statements a teacher might make about a student's failure:

- "Why don't you practice a little more and then try again?"
- "Let's see whether we can come up with study strategies that might work better for you."
- "Hmmm, maybe this just isn't something you're good at. Perhaps we should try a different activity."
- "Maybe you're just having a bad day."

All of these are well-intended comments, presumably designed to make a student feel good. But notice the different attributions they imply. In some cases success or failure is attributed to

controllable (and therefore changeable) behaviors—that is, to hard work or lack of practice or to the use of effective or ineffective study strategies. But in other cases success or failure is attributed to uncontrollable ability—that is, to being smart or not “good at” something. And in still other cases an outcome is attributed to external, uncontrollable causes—that is, to a lucky break or a bad day.

People also communicate their attributions—and indirectly, their beliefs about a learner’s ability level—through the extent to which they praise or criticize the learner’s performance and through the emotional reactions they convey (Chang & Davis, 2009; Graham, 1990; Hareli & Weiner, 2002; C. Reyna & Weiner, 2001; Weiner, 2000, 2005). For example, frequent praise is often a message that learners’ successes are the result of their efforts. However, by praising a learner for *easy* tasks, people may simultaneously communicate that success wasn’t expected—in other words, that the learner has low ability. Here, then, we see a perspective very different from that of behaviorism. Behaviorists propose that, as reinforcement, praise should increase the behavior it follows. From the standpoint of attribution theory, however, praise can be counterproductive for easy tasks. If it communicates low ability, learners may be unwilling to exert much effort on later tasks. Praise for effort is likely to be effective only when learners *have* exerted the effort.

Reactions to a learner’s failures communicate attributions as well. When people criticize, express anger about, and perhaps punish a learner’s poor performance, they convey the message that the learner has sufficient ability to master the task and simply isn’t trying hard enough. But when people express pity or sympathy for the same performance, they communicate their belief that the learner’s uncontrollable low ability is the reason for the failure.

Yet another way in which adults communicate their attributions is through the amount and kinds of help they provide. For example, although teacher assistance is often an important source of scaffolding for difficult tasks, it can be counterproductive if students don’t really need it. When students struggle temporarily with a task, unsolicited help from a teacher may communicate the message that they have low ability and little control over their own successes and failures. In contrast, allowing students to struggle on their own for a reasonable amount of time—not to the point of counterproductive frustration, of course—conveys the belief that students have the ability to succeed on their own (Graham, 1990, 1997; Graham & Barker, 1990; Stipek, 1996; Weiner, 2005).

### **Culture**

People’s cultural backgrounds influence their attributions as well, particularly with respect to the controllability dimension. For example, members of some religious groups may place their fates in the hands of God, *karma*, or some other metaphysical force (Losh, 2003; also see the discussion of *worldviews* in Chapter 10). As another example, students from Asian backgrounds are more likely to attribute classroom success and failure to unstable factors—effort in the case of academic achievement, and temporary situational factors in the case of appropriate or inappropriate behaviors—than students who have grown up in mainstream Western culture (Li & Fischer, 2004; Lillard, 1997; Weiner, 2004).<sup>10</sup> In contrast to many Western students—who are

---

<sup>10</sup>Such attributions are often, but not always, a benefit. For instance, if students attribute their failures as well as their successes to effort and if they place high priority on bringing honor to their families (as is true for many Asian students), then consistent failure can lead to feelings of humiliation and depression (Dweck, 2000; Grant & Dweck, 2001).

apt to think that innate ability affects learning success—many Asian students reverse the cause-and-effect relationship: *Learning leads to intelligence* (Li, 2003).

Some studies indicate a greater tendency for African American students—even those with high self-efficacy for academic subject matter—to believe they have little control over whether they achieve academic success. Real or perceived racial prejudice may contribute to such an attribution: Some students may begin to believe that because of the color of their skin, they have little chance of success no matter what they do (Graham, 1989; B. G. Holliday, 1985; Sue & Chin, 1983; van Laar, 2000; Weiner, 2004).

### **Gender**

Some researchers have found gender differences in attributions, especially in stereotypically male domains such as mathematics and sports. In these instances, males are more likely to attribute their successes to ability and their failures to lack of effort, thus assuming the attitude that *I know I can do this because I have the ability*. Females show the reverse pattern: They attribute their successes to effort and their failures to lack of ability, believing that *I don't know if I can keep on doing it, because I'm not very good at this type of thing*. Such differences—which can be observed even when boys' and girls' previous levels of achievement are equivalent—typically reflect general beliefs in society at large about what males and females are usually “good at” (Carr & Jessup, 1997; Dickhäuser & Meyer, 2006; Eccles, Wigfield, & Schiefele, 1998; Stipek & Gralinski, 1991; Vermeer, Boekaerts, & Seegers, 2000).

### **Self-Protective Bias**

As a general rule, people tend to form attributions that maintain or enhance their sense of self-worth. For instance, we tend to attribute our successes to internal causes (e.g., to high ability or hard work) and our failures to external causes (e.g., to bad luck or another person's inconsiderate or irresponsible behavior). By patting ourselves on the back for the things we do well and putting the blame elsewhere for poor performance, we're able to maintain positive self-perceptions (Mezulis, Abramson, Hyde, & Hankin, 2004; S. W. Park, Bauer, & Arbucl, 2009; Sedikides & Gregg, 2008). This **self-protective bias** isn't always in our best interest, however: If we inaccurately attribute our failures to factors outside of ourselves, we're unlikely to change our behavior in ways that will lead to greater success (Dweck & Molden, 2005; Seligman, 1991; Zimmerman, 2004).

### **Image Management**

The attributions people communicate to others don't always reflect their true beliefs about the sources of their successes and failures. As children get older, they discover that different kinds of attributions elicit different kinds of reactions from other people (Hareli & Weiner, 2002; Juvonen, 2000). To maintain positive interpersonal relationships—and thereby satisfy their need for relatedness—they begin to modify their attributions for the particular audience at hand. This phenomenon is sometimes called *face-saving*, but I suggest using the broader term **image management**.

Teachers, parents, and other adults are often sympathetic and forgiving when children fail because of something beyond their control (illness, lack of ability, etc.) but frequently get angry when children fail simply because they didn't try very hard. By the time children reach fourth grade, most of them are aware of this fact and so may verbalize attributions that are likely to elicit favorable reactions (Juvonen, 1996, 2000; Weiner, 1995). To illustrate, a student who knows

very well that she did poorly on an assignment because she didn't put forth her best effort may distort the truth, telling her teacher that she "can't seem to make sense of this stuff" or "wasn't feeling well."

Children become equally adept at tailoring their attributions for the ears of their peers. Generally speaking, fourth graders believe that their peers value diligence and hard work, and so they're likely to tell their classmates that they did well on an assignment because they worked hard. By eighth grade, however, many students believe their peers disapprove of those who exert a lot of effort on academic tasks, and so they often prefer to convey the impression that they *aren't* working very hard—for instance, that they "didn't study very much" for an important exam or "just lucked out" when they've performed at a high level (Howie, 2002; Juvonen, 1996, 2000).

## Explanatory Style: Mastery Orientation versus Learned Helplessness

Over time, people gradually develop consistent patterns of attributions for their successes and failures, and these patterns, in turn, affect their expectations for future performance. The general, typical way in which a person interprets and explains day-to-day events and consequences is known as **explanatory style**.<sup>11</sup> For instance, some people typically attribute their accomplishments to their own abilities and efforts; they have an *I-can-do-it* attitude known as a **mastery orientation**. Other people attribute successes to outside and uncontrollable factors and believe that their failures reflect a relatively permanent lack of ability; they have an *I-can't-do-it-even-if-I-try* attitude known as **learned helplessness**. You should think of this distinction as a continuum rather than a complete dichotomy. You might also look at it as a difference between *optimists* and *pessimists* (Dweck, 2000; Eccles & Wigfield, 1985; Mikulincer, 1994; C. Peterson, 2006; C. Peterson, Maier, & Seligman, 1993; Seligman, 1991).

As an illustration, consider these two boys, keeping in mind that both boys have the same ability level:

- Jerry is an enthusiastic, energetic learner. He enjoys working hard at school activities and takes obvious pleasure in doing well. He's always looking for a challenge and especially likes to solve the brainteaser problems his teacher assigns as extra-credit work each day. He can't always solve the problems, but he takes failure in stride and is eager for more problems the following day.
- Jason is an anxious, fidgety student. He doesn't seem to have much confidence in his ability to accomplish school tasks successfully. In fact, he's always underestimating what he can do; even when he has succeeded, he doubts that he can do it again. He seems to prefer filling out worksheets that help him practice skills he's already mastered rather than attempting new tasks and problems. As for those daily brainteasers, he sometimes takes a stab at them, but he gives up quickly if the answer isn't obvious.

Jerry exhibits a mastery orientation: He clearly has his life (and his attributions) under control, and he's optimistic about his future performance. In contrast, Jason displays learned helplessness: He believes that challenging tasks are out of his reach and beyond his control, and he expects failure rather than success.

---

<sup>11</sup>You may also see the term *attributional style*.

Researchers have identified a number of ways in which people with a mastery orientation differ from those with learned helplessness. In an academic context, those with a mastery orientation tend to perform better on classroom tasks than we would predict from their aptitude test scores and previous grade point averages (Seligman, 1991). In an athletic context, optimists bounce back from a lost game more readily and overcome injuries more quickly than do equally capable but more pessimistic athletes (C. Peterson, 1990). In general, people with a mastery orientation have good mental health and behave in ways that lead to higher achievement over the long run: They set ambitious goals, seek challenging situations, and persist in the face of failure. People with learned helplessness behave very differently: Because they underestimate their ability, they set performance goals they can easily accomplish, avoid the challenges likely to maximize their learning and growth, and respond to failure in counterproductive ways (e.g., giving up quickly) that almost guarantee future failure. They're also hampered by anxiety-related thoughts, which leave limited working memory capacity available for concentrating on the task at hand (Dweck, 2000; Graham, 1989; Mikulincer, 1994; C. Peterson, 1990, 2006; Seligman, 1991).

Extreme cases of learned helplessness typically manifest themselves in three ways. First, there's a *motivational* effect: The individual is slow to exhibit responses that will yield desirable outcomes or enable escape from aversive situations. Second is a *cognitive* effect: The individual has trouble learning new behaviors that would improve environmental conditions. The third effect is an *emotional* one: The individual tends to be passive, withdrawn, anxious, and depressed (S. F. Maier & Seligman, 1976; Overmier, 2002).

Preschoolers occasionally show signs of learned helplessness about a particular task if they consistently encounter failure while attempting it (Burhans & Dweck, 1995). By age 5 or 6, some children begin to show a consistent tendency either to persist at a task and express confidence that they can master it, on the one hand, or to abandon a task quickly and say they don't have the ability to do it, on the other (Ziegert, Kistner, Castro, & Robertson, 2001). As a general rule, however, children younger than age 8 rarely exhibit extreme forms of learned helplessness, perhaps because they still believe that success is largely the result of their own efforts (Eccles et al., 1998; Lockhart, Chang, & Story, 2002; Paris & Cunningham, 1996). By early adolescence a general sense of helplessness becomes more common. Some middle schoolers believe they can't control the things that happen to them and are at a loss for strategies about how to avert future failures (Dweck, 2000; Paris & Cunningham, 1996; C. Peterson et al., 1993). By the time people reach adulthood, learned helplessness often manifests itself in chronic depression (Seligman, 1975, 1991).

### ***Roots of Learned Helplessness***

I first described Seligman and Maier's (1967) classic study of learned helplessness in Chapter 1, but a memory refresher and additional details are probably in order. In the first phase of the experiment, dogs received numerous painful and unpredictable shocks. Some dogs could escape the shocks by pushing a panel in the cage, whereas other dogs couldn't escape the shocks regardless of what they did. The following day, each dog was placed in a box that a barrier divided into two compartments. While in this box, the dog was given a series of tone–shock combinations, with a tone always preceding a shock; the dog could avoid the shock by jumping over the barrier into the other compartment as soon as it heard the tone. Dogs that had been able to escape the shocks on the first day quickly learned to avoid the shocks on the second day. In contrast, dogs that had previously been unable to escape displayed learned helplessness: They made few

attempts to escape, instead simply sitting still and whining as the shocks were presented. Seligman and Maier's study suggests that when aversive events occur repeatedly and an animal can't avoid, escape from, or otherwise terminate them, the animal will eventually give up and passively accept them.

People, too, begin to exhibit symptoms of learned helplessness when they can't control the occurrence of aversive events (e.g., Bargai, Ben-Shakhar, & Shalev, 2007; Hiroto & Seligman, 1975; C. Peterson et al., 1993). Such may be the case for schoolchildren who consistently have difficulty successfully completing academic tasks (C. S. Carver & Scheier, 2005; Dweck, 1986; Hallenbeck, 2002; Nenty & Ogwu, 2009; Núñez et al., 2005). As an example, consider the child with a learning disability. Often remaining unidentified as a student with special educational needs, the child may encounter repeated failure in academic work, despite reasonable efforts to succeed, and so may eventually stop trying. I've also seen the learned helplessness phenomenon in presumably nondisabled students when I talk with them about certain subject areas. For instance, many students attribute their math anxiety to the fact that, as elementary school students, they couldn't comprehend how to solve certain problems no matter what they did or how hard they tried. Others show learned helplessness in the area of spelling: Even when they know they've spelled a word incorrectly, they don't try to correct themselves, excusing their behavior by such statements as "I'm just a bad speller" or "I never could spell very well" (Ormrod & Wagner, 1987).

Helplessness can also develop when people observe *other individuals* having little control over their lives (I. Brown & Inouye, 1978; C. Peterson et al., 1993). How adults behave in their interactions with children can contribute to feelings of helplessness as well. For instance, mothers of children with early signs of learned helplessness are less likely to provide assistance when their children tackle challenging tasks—and they're *more* likely to suggest giving up in the face of difficulty—than mothers of mastery-oriented children (Hokoda & Fincham, 1995). Giving children negative feedback without also providing suggestions about how to improve—especially when the feedback calls into question children's overall competence and worth—can also instill helplessness (Dweck, 2000; Kamins & Dweck, 1999). Curiously, *praise for successes* can eventually lead to helplessness if the praise focuses on children's natural, inherited talents (thus fostering an entity view of ability) and the children subsequently experience failures in the same domain (Dweck, 2000; Kamins & Dweck, 1999).

Having a consistent history of being able to control one's circumstances seems to inoculate people against learned helplessness in the face of temporarily uncontrollable events (C. Peterson et al., 1993). (This point should remind you of our discussion of *resilient self-efficacy* in Chapter 6.) And under some circumstances, learned helplessness can actually be a roundabout way in which people actually try to *maintain* a sense of control in chronically adverse conditions (N. C. Hall, Hladkyj, Ruthig, Pekrun, & Perry, 2002; N. C. Hall, Hladkyj, Taylor, & Perry, 2000; Rothbaum, Weisz, & Snyder, 1982). Because they're unable to change their environment, they instead accept their circumstances, recognize their limitations, acknowledge that factors beyond themselves (fate, God, *karma*, etc.) are ultimately in charge, and try to identify the silver lining in their unhappy situation.

One of the outcomes of a mastery orientation—and of controllable attributions more generally—is an increased tendency to self-regulate one's own learning. In fact, truly effective learners regulate not only their approach to a learning task but also their motivation and affect. We now look at the interplay among motivation, affect, and self-regulation.

## MOTIVATION, AFFECT, AND SELF-REGULATION

---

In Chapter 16, we discovered how motivation and affect are interrelated with each other and with learning and cognition. Motivation and affect also influence and are influenced by self-regulation. Furthermore, the development of self-regulation often includes *internalizing* the motives, values, and goals of others.

### How Motivation and Affect Influence Self-Regulation

As we discovered early in Chapter 16, motivated individuals—and especially *intrinsically* motivated individuals—are more likely to initiate and persist at activities, more likely to be cognitively engaged in what they're doing, and more likely to use effective strategies in a learning task. Thus, motivation—and again, especially intrinsic motivation—sets the stage for self-regulation.

People are more likely to be self-regulating learners when they feel confident that they can be successful at a learning task and when they believe they can control the direction their lives are taking. In other words, self-regulating learners have a sense of both competence (self-efficacy) and self-determination. In addition, self-regulating learners tend to set mastery goals for their performance and to attribute successful outcomes to things they themselves have done—for instance, hard work and use of good strategies (R. Ames, 1983; Blazevski, McEvoy, & Pintrich, 2003; Paris & Turner, 1994; Schunk, 1995; Zimmerman, 2010; Zimmerman & Risemberg, 1997).

One aspect of self-regulated learning in which motivation and affect figure prominently is *help-seeking* behavior. Why do some students willingly seek others' assistance when they need it, whereas other struggling students consistently ignore opportunities and offers for assistance? Researchers have found that students are *less* likely to seek other people's help when they

- Perceive requests for help as threatening their sense of competence and self-worth
- Believe that asking for help will undermine their sense of autonomy and self-determination (in some instances, they may also think they can learn more if they persist on their own)<sup>12</sup>
- Have performance goals (rather than mastery goals) in combination with low ability
- Have an entity (rather than incremental) view of intelligence
- Are concerned about making a good impression on others and think that a request for help might make them look stupid
- Worry that requests for help might be disparaged and rejected (Aleven, Stahl, Schworm, Fischer, & Wallace, 2003; R. Ames, 1983; R. Butler, 1998b; Dweck & Molden, 2005; Newman & Schwager, 1992; A. M. Ryan, Hicks, & Midgley, 1997; A. M. Ryan, Pintrich, & Midgley, 2001; Skaalvik & Valas, 2001; J. C. Turner, Husman, & Schallert, 2002)

### How Self-Regulation Influences Motivation and Affect

Not only do motivational and affective factors influence self-regulated learning but self-regulating learners also *control* their motivation and affect to some degree. They do so in a variety of ways:

- *Aligning assigned tasks with areas of interest.* When they have a choice of learning activities, they intentionally choose alternatives that interest them (Covington, 2000). For example,

---

<sup>12</sup>Culture may also be a factor here. Many Western societies encourage students to be independent learners as much as possible and to minimize reliance on others (Karabenick & Sharma, 1994).



when thinking about research projects for an upcoming science fair, they might develop a project that relates to a current interest in lizards or a long-term goal of becoming a dentist.

- *Setting goals.* They set short-term as well as long-term goals for themselves (Locke & Latham, 2002; Zimmerman, 1998). For instance, they might tell themselves, “I need to finish reading this chapter on motivation before I go to lunch.” By setting and reaching short-term goals, they also enhance their self-efficacy (Wolters, 2003a).
- *Focusing on productive attributions.* They identify factors within themselves over which they have considerable control, such as good strategies (Wolters, 2003a). For instance, while tackling a difficult geometry problem, they might think, “I’ve solved these kinds of problems before. What approaches did I use that worked for me?”
- *Minimizing enticing distractions.* They create or find an environment in which they can concentrate as they study (J. Kuhl, 1987; Wolters, 2003a; Wolters & Rosenthal, 2000). For instance, they might turn off the television while studying in the living room, or they might retreat to a quiet corner of the library.
- *Reminding themselves of the importance of doing well.* They engage in self-talk that emphasizes reasons for completing a task or performing at high levels (Wolters, 2003a; Wolters & Rosenthal, 2000). For instance, they might say, “I can help others in my study group understand this only if I understand it myself” or “Getting an A on this test is important for my GPA.”
- *Enhancing the appeal of a task.* They devise ways to make a boring task more interesting and enjoyable (Sansone, Weir, Harpster, & Morgan, 1992; Wolters, 2003a; Wolters & Rosenthal, 2000; Xu, 2008). For example, they might try to make the task into a game of some sort, or they might embellish their written work with artful illustrations.
- *Self-imposing consequences.* They promise themselves rewards for doing well; they may also punish themselves in some way if they fail (Wolters, 2003a; Wolters & Rosenthal, 2000; also see the sections “Self-Reaction” and “Self-Reinforcement” in Chapter 6). For example, they might treat themselves to a night at the movies with friends if—but only if—they get at least a B on an assignment.

Emotions aren’t as easy to control as motivation, but self-regulating learners rein in unproductive ones as much as they can. For instance, they try to put worrisome thoughts out of their minds while they study. They try to think of upcoming exams as being challenges they can overcome, rather than as threatening events that foreshadow almost certain doom. They bounce back quickly after a discouraging failure, renewing their efforts and finding reasons for optimism that they’ll be successful the next time. And occasionally they adjust their expectations for themselves to be in better alignment with their current ability levels (Fletcher & Cassady, 2010; Pekrun, 2006; Richards & Gross, 2000; Wolters, 2003a; J. C. Turner et al., 2002; Zeidner, 1998).

## Internalized Motivation

As I mentioned in Chapter 14, my son Alex and I once enrolled in an undergraduate course in art history. We were both taking the course primarily to gain a better understanding of the many works of art we’d seen in museums over the years. Alex also had a second reason for taking the course: to earn credit toward his high school diploma. Alex, of course, had to get a passing grade in the course. As for me, it mattered little whether I got an A or an F. Yet I diligently studied for

every test, often forgoing things I'd rather have been doing, such as reading a mystery novel or watching a television game show. Why did I do it? Although I enjoyed attending class, studying the material before a test was definitely *not* an intrinsically motivating activity for me; the textbook had lots of beautiful pictures, but its prose was about as interesting and engaging as the telephone book. Nor was there any obvious extrinsic motivation for me to study; the grade I got in the course would in no way affect my future physical, financial, or emotional well-being. The bottom line was that, in my many years as a student, I had acquired a desire to achieve good grades, more or less for their own sake.

In our discussion so far, we've thought of intrinsic versus extrinsic motivation as an either-or state of affairs. In fact, there's a third possibility. The concept of **internalized motivation** refers to situations in which, over time, people gradually adopt behaviors that other individuals value, ultimately without regard for the external consequences that such behaviors may or may not bring.<sup>13</sup>

Edward Deci and Richard Ryan (1995; Deci & Moller, 2005; R. M. Ryan & Deci, 2000) have proposed that internalized motivation may evolve in the following sequence:

1. *External regulation.* The learner is motivated to behave in certain ways—or perhaps *not* to behave in those ways—based primarily on the external consequences that will follow various behaviors; in other words, the learner is extrinsically motivated. For instance, students may do schoolwork primarily to avoid being punished for poor grades, and they're likely to need a lot of prodding to complete assigned tasks.
2. *Introjection.* The learner behaves in particular ways in order to gain other people's approval; for example, a student may willingly complete an easy, boring assignment as a means of getting in a teacher's good graces. At this point, we see some internal pressure to engage in desired behaviors; for instance, the learner may feel guilty after violating certain standards or rules for behavior. However, the learner doesn't fully understand the rationale behind such standards and rules. Instead, the primary motives appear to be avoiding a negative self-evaluation and protecting self-worth.
3. *Identification.* The learner now sees certain behaviors as being personally important or valuable. For instance, a student is likely to value learning and academic success for their own sake, to perceive assigned classroom tasks as being essential for learning, and to need little or no prodding to get assigned work done.
4. *Integration.* The learner has fully accepted the desirability of certain behaviors and integrated them into an overall system of motives and values. For example, a student might have acquired a keen interest in science as a possible career—an interest that will be evident in many things the student regularly does.

Internalized motivation is an important aspect of self-regulated learning. It fosters a general work ethic—including that *motivation to learn* I spoke of earlier—in which the learner spontaneously engages in activities that, although not always fun or immediately gratifying, are essential for reaching long-term goals (Brophy, 2008; Harter, 1992; McCombs, 1996; R. M. Ryan, Connell, & Grolnick, 1992). In a sense, then, we're returning to the notion of *values*: A learner perceives certain activities to have direct or indirect benefits.

Be careful that you don't equate Step 4 in the internalization sequence—*integrated motivation*—with *intrinsic motivation*. Certainly they're both associated with a high degree of self-determination,

---

<sup>13</sup>This concept should remind you of Vygotsky's notion of *internalization* (see Chapter 13).

and they can ultimately have similar effects on behavior and learning, such as greater persistence and more effective learning strategies (Assor, Vansteenkiste, & Kaplan, 2009; La Guardia, 2009; Ratelle, Guay, Vallerand, Larose, & Senécal, 2007). However, intrinsic motivation comes from within the individual or is inherent in the task being performed, whereas integrated motivation has its roots in other people's messages about what things are important and valuable (Deci & Moller, 2005; Reeve, Deci, & Ryan, 2004; Stefanou, Perencevich, DiCintio, & Turner, 2004). In some cases, identified or integrated motivation (Steps 3 and 4 in the sequence) may actually be preferable to intrinsic motivation, in that learners will sustain their efforts even after an activity's intrinsic appeal wears thin (Walls & Little, 2005).

Researchers have identified several conditions that seem to promote the development of internalized motivation—conditions that in one way or another address a learner's needs for competence, self-determination, and relatedness:

- *The learner perceives an activity to be important for long-term success.* Motivated by a need for competence, the learner wants to acquire knowledge and skills essential for successful performance in society.
- *The learner operates within the context of a warm, responsive, and supportive environment.* The learner feels a sense of relatedness to and regard for important other people in his or her environment.
- *The learner has some autonomy.* The people who are largely directing the learner's behavior (e.g., parents, teachers) exert no more control than necessary, as a way of maximizing the extent to which the learner maintains a sense of self-determination. Over time, those people gradually relinquish control to the learner.
- *The learner operates within a certain degree of structure.* The environment provides information about expected behaviors and why they're important. Response–consequence contingencies are clearly identified. (Deci & Moller, 2005; La Guardia, 2009; R. M. Ryan et al., 1992; Wentzel & Wigfield, 1998)

Fostering the development of internalized motivation, then, involves a delicate balancing act between (1) giving the learner sufficient opportunities for experiencing autonomy and (2) providing some guidance about how the learner should behave. In a sense, adults scaffold desired behaviors at first, gradually reducing the scaffolding as the learner exhibits the behaviors more easily and frequently.

## ENCOURAGING MOTIVATING COGNITIONS

---

In this chapter, we've considered several cognitive factors that influence motivation, including interests, expectancies, values, goals, and attributions. With these factors and the benefits of self-regulation and internalized motivation in mind, I offer some general principles that can guide teachers' efforts to enhance students' motivation—and consequently also students' learning and achievement—in the classroom:

- ◆ *Students learn more when they find classroom material interesting as well as informative.* Almost all students learn more when a topic is interesting. Yet students often report that they find little of interest in classroom subject matter, especially once they reach the middle school and high school grades (Dotterer, McHale, & Crouter, 2009; Gentry, Gable, & Rizza, 2002; Larson, 2000; Mac Iver, Reuman, & Main, 1995).

Certainly teachers should capitalize on students' personal interests whenever possible. But situational interest factors—especially of the “hold” rather than “catch” variety—can also be incorporated into classroom topics and activities. For example, students typically enjoy opportunities to respond actively during a learning activity—perhaps by manipulating and experimenting with physical objects, creating new products, discussing controversial issues, or teaching something they've learned to their peers (Andre & Windschitl, 2003; Brophy, 2004; Hidi, Weiss, Berndorff, & Nolan, 1998). They enjoy subject matter to which they can relate on a personal level—for instance, math lessons that involve favorite foods, works of literature featuring characters with whom they can readily identify, or history textbooks that portray historical figures as real people with distinctly human qualities (Anand & Ross, 1987; Levstik, 1993; Pugh & Bergin, 2006). Students are often curious about things that are new and different and about events that are surprising and puzzling (M. Hofer, 2010; Lepper & Hodell, 1989). They like to engage in fantasy and make-believe—for example, playing out the roles of key figures in historical events or imagining what it must be like to be weightless in space (Brophy, 2004; Urdan & Turner, 2005). And they may eagerly seek out answers to questions they themselves have posed about a new topic (Brophy, Alleman, & Knighton, 2009; Hidi & Renninger, 2006).

♦ *Students tend to be more optimistic about their chances of success when they have environmental support for their efforts.* In Chapters 6 and 16, we identified a number of strategies for enhancing students' self-efficacy for accomplishing classroom tasks. But as we discovered in our earlier discussion of expectancies, learners' expectations for success depend not only on their own perceived abilities but also on the availability of people who can guide them and resources that can make some parts of a task easier. Hence we see that appropriate scaffolding is apt to promote motivation as well as learning and development (Brophy, 2004, 2008). Not only does scaffolding enhance students' expectancies for success, but it may also enhance their interest in school subject matter (Hidi & Renninger, 2006).

♦ *Students are more motivated to learn classroom subject matter when they believe it has value for them personally.* Some classroom activities will be naturally fun, interesting, and intrinsically motivating for students. But other activities—perhaps occasional drill and practice to promote automaticity of basic skills, or perhaps intensive study of dry but essential topics—may have little obvious appeal. Teachers can do many things to help students find value in school activities. For example, they can help students discover how the things they learn at school can better enable them to address their present concerns and long-term goals (Ferrari & Elik, 2003; Hulleman, Godes, Hendricks, & Harackiewicz, 2010; Simons et al., 2004). Teachers can also demonstrate how they themselves value academic activities—for example, by sharing their fascination with certain topics, modeling critical evaluation of new ideas, and describing how they use the things they themselves once learned in school (Brophy, 1999, 2004; D. Kuhn, 2006). And teachers should refrain from asking students to engage in activities with little long-term benefit—memorizing trivial facts for no good reason, reading material that's clearly beyond students' comprehension level, and so on (Brophy, 1987, 2008).

Other factors that promote the development of internalized motivation—a responsive and supportive environment, age-appropriate autonomy, and a reasonable amount of structure—should also help learners acquire values that other people believe are important for long-term well-being. And in general, teachers should help students discover for themselves that studying school subject matter isn't just a means to concrete ends (a better job, higher salary, etc.) but in fact has many intangible rewards—better understanding of world events, more informed decision

making, and so on (Brophy, 2004, 2008; Finke & Bettle, 1996). Ideally, then, students should come to value learning for its own sake.

♦ *Students learn more effectively when they set goals for themselves.* When we talked about instructional objectives in Chapter 5, we were essentially talking about goals that teachers set for their students. But it's equally important that students set their *own* goals regarding what they want to accomplish at school. Not only are self-chosen goals an important part of self-regulated learning but they can also help students make productive choices, direct students' efforts as they work in the classroom, and contribute to students' sense of self-determination. And ultimately, students are more likely to work toward—and thus more likely to accomplish—goals they've set for themselves rather than those they've had imposed on them (Reeve, 2009; Schunk & Pajares, 2005; Wentzel, 1999).

Although teachers should certainly encourage students to develop long-term goals for themselves—perhaps to go to college or become an environmental scientist—such goals are often too general and abstract to guide students' immediate behaviors (Bandura, 1997; Husman & Freeman, 1999). Many students (younger ones especially) initially respond more favorably to fairly specific, concrete, short-term goals—perhaps learning a certain number of spelling words or solving a certain number of mathematics problems. By setting and working for a series of short-term goals—sometimes known as **proximal goals**—students get regular feedback about the progress they're making, develop a greater sense of self-efficacy that they can master school subject matter, and achieve at higher levels (Kluger & DeNisi, 1998; R. B. Miller & Brickman, 2004; Page-Voth & Graham, 1999; Schunk & Pajares, 2005; Wolters, 2003a).

♦ *In general, mastery goals lead to better learning than performance goals.* To some degree, performance goals—completing assigned tasks, earning high grades and test scores, and so on—are inevitable in today's schools and in society at large. Furthermore, children and adolescents will invariably look to their peers' performance as one means of evaluating their *own* performance, and many aspects of the adult world (gaining college admission, seeking employment, playing professional sports, etc.) are inherently competitive in nature. But ultimately, mastery goals are the ones most likely to promote effective learning and achievement over the long run. Mastery goals are especially motivating when they're specific (“I want to learn how to ride a bicycle”), challenging (“Writing a limerick looks difficult, but I'm sure I can do it”), and short-term (“I'm going to learn to count to 100 in French by the end of the month”) (Alderman, 1990; K. R. Harris, Graham, Brindle, & Sandmel, 2009; Mac Iver et al., 1995; S. D. Miller & Meece, 1997).

Some theorists have proposed that different kinds of mastery goals may be more useful at different points in learning, especially when learners are trying to learn a skill of some sort (e.g., writing a good paragraph, playing basketball, throwing darts). Initially, learners may want to work toward a **process goal**, perfecting the form or procedure that the skill involves without regard to the final outcome. As the desired form or procedure becomes more automatized, they may then want to shift their attention to a **product goal**, striving for a certain standard of performance (e.g., writing a clear topic sentence, getting a certain percentage of balls in the basket or a certain number of darts in the center of the target) (Schunk & Swartz, 1993; Schunk & Zimmerman, 1997; Zimmerman & Kitsantas, 1997, 1999). On the surface, such goals might look like performance goals. However, the focus of both process and product goals is on *mastery* of a skill, not on how one's performance appears to others.

Teachers can do many things to encourage students to focus more on mastery goals than performance goals. For example, they can suggest that students look to their peers not as a

comparison group for evaluating their own performance but rather as sources of information and support (Clani, Middleton, Summers, & Sheldon, 2010; Urdan, Ryan, Anderman, & Gheen, 2002). They can communicate the idea that mistakes are an inevitable part of mastering new and complex tasks (C. Ames, 1992; N. E. Perry & Winne, 2004). They can provide mechanisms and criteria through which students may easily record and assess their academic progress (Paris & Paris, 2001; Spaulding, 1992). And rather than simply reporting test scores or letter grades, teachers can give specific feedback about how students might improve (R. Butler, 1987; Shute, 2008; M.-T. Wang & Holcombe, 2010).

♦ *Classroom activities are more effective when they enable students to meet several goals at once.* As we've seen, students are more productive when they can accomplish multiple goals simultaneously. For instance, students might work toward mastery goals by learning and practicing new skills within the context of group projects (thus meeting their social goals) and with evaluation criteria that allow for risk taking and mistakes (thus not interfering with performance goals). Students are *unlikely* to strive for mastery goals when assignments ask little of them (thereby not enhancing their sense of competence), when they must compete with one another for resources or high test scores (possibly thwarting attainment of social goals), and when any single failure has a significant impact on final grades (impeding progress toward performance goals).

Within this context, we should note that performance-approach goals can be quite beneficial when students strive for them in conjunction with mastery goals (Linnenbrink, 2005; Senko & Harackiewicz, 2005). They become problematic primarily when they're incompatible with mastery goals—for instance, when a desire to get a good grade prompts a student to cheat rather than understand the subject matter (Dweck, 2000).

♦ *Optimistic teacher attributions and expectations regarding students' achievement boost students' actual achievement.* As we discovered in Chapter 9, people often draw from their existing knowledge and beliefs to form expectations about what they're likely to see and hear. These expectations, in turn, influence what people *do* see and hear, or at least what they *think* they see and hear. Expectations are especially influential when an event is ambiguous—that is, when it can be interpreted in multiple ways.

Many of students' day-to-day behaviors in the classroom lend themselves to a variety of interpretations. What teachers conclude from these behaviors—including the attributions they make about students' successes and failures—depends on how they've previously sized up different students' motivation levels, abilities, and so on. For example, imagine that a student, Linda, fails to finish a class assignment on time. Her teacher, Mr. Jones, might possibly conclude that Linda (1) didn't try very hard, (2) used her time poorly, or (3) wasn't capable of doing the task. Which conclusion Mr. Jones draws will depend on his prior beliefs about Linda—for instance, whether he thinks she (1) is lazy and unmotivated, (2) is both motivated and capable of doing the work but hasn't yet acquired effective self-regulation skills, or (3) has little innate capacity for learning (reflecting an entity view of intelligence).

Teachers' attributions for students' current behaviors affect their expectations for students' future performance. Their expectations, in turn, affect future attributions (Weiner, 2000). And their attributions and expectations both affect the teaching strategies they use with particular students. For example, if Mr. Jones thinks Linda is "unmotivated," he might use some sort of incentive—perhaps offering some free time at the end of the day—to entice her into completing assignments on time. If, instead, he thinks Linda lacks the necessary self-regulation skills for independent work, he might strive to teach her such skills—perhaps instructing her in the

self-monitoring I described in Chapter 6. But if he thinks Linda has insufficient intelligence to master classroom topics, he may do little, if anything, to help her along.

When teachers form optimistic attributions and expectations for students—for instance, when they believe that students can perform at high levels if conditions are right—they create a warm classroom climate, frequently interact with students, provide numerous opportunities for students to respond, and give positive and specific feedback; they also present challenging tasks and topics. In contrast, when teachers have low expectations for certain students—for instance, when they believe they can do little to change students’ seemingly “low intelligence” or “poor motivation”—they offer few opportunities for speaking in class, ask easy questions, give little feedback about students’ responses, present few (if any) challenging assignments, and overlook good performance when it occurs (Babad, 1993; Good & Brophy, 1994; Graham, 1990, 1991; R. Rosenthal, 1994, 2002).

Most children and adolescents are well aware of their teachers’ differential treatment of individual students, and they use such treatment to draw logical inferences about their own abilities (R. Butler, 1994; Good & Nichols, 2001; R. S. Weinstein, 2002). Furthermore, their behaviors may begin to mirror their self-perceptions. For instance, when teachers repeatedly communicate low-ability messages, students may exert little effort on academic tasks, or they may frequently misbehave in class (Marachi, Friedel, & Midgley, 2001; Murdock, 1999). In some cases, then, teachers’ attributions and expectations can lead to a self-fulfilling prophecy: What teachers expect students to achieve becomes what students actually *do* achieve. (We’ll call this *Self-Fulfilling Prophecy #2*.) Teacher attributions and expectations appear to have a greater influence in the early elementary school years (grades 1 and 2), in the first year of secondary school, and, more generally, within the first few weeks of school—in other words, at times when students are entering new and unfamiliar school environments (de Boer, Bosker, & van der Werf, 2010; Hattie, 2009; Hinnant, O’Brien, & Ghazarian, 2009; Jussim, Eccles, & Madon, 1996; Kuklinski & Weinstein, 2001; Raudenbush, 1984; R. Rosenthal, 1994, 2002).

Obviously, then, teachers are most effective when they have optimistic attributions and expectations regarding students’ performance. Following are several strategies teachers can use to acquire and maintain such optimism:

- *Look for strengths in every student.* Sometimes students’ weaknesses are all too evident. But it’s essential that teachers also look for the many unique qualities and strengths that students inevitably bring to the classroom—perhaps exceptional leadership skills in working with classmates or considerable creativity in story telling (Carrasco, 1981; Hale-Benson, 1986; R. J. Sternberg, 2005).
- *Learn more about students’ backgrounds and home environments.* Teachers are most likely to have low expectations for students’ performance when they hold rigid stereotypes about students from certain ethnic or socioeconomic groups, often as a result of ignorance about students’ cultures and home environments (Kincheloe, 2009; McLoyd, 1998; Snow, Corno, & Jackson, 1996). When teachers have a clear picture of their students’ activities, habits, values, and families, they’re far more likely to think of their students as *individuals* than as stereotypical members of a particular group.
- *Assume that ability can and often does improve with time, practice, and high-quality instructional practices.* In other words, teachers should take an incremental view, rather than an entity view, of students’ intelligence and other abilities (Dweck & Molden, 2005).
- *Assess students’ progress objectively and frequently.* Because expectations for students’ performance often color teachers’ informal estimates of how well students are progressing,

teachers need to identify objective ways of assessing learning and achievement (Goldenberg, 1992). Here I'm not talking about the high-stakes tests of which I spoke in Chapters 5 and 16 (such tests yield only global measures of achievement), but rather about teacher-constructed assessments that can provide concrete information about what students have and haven't learned.

- *Remember that teachers can definitely make a difference.* Teachers are more likely to have high expectations for students when they're confident in their own ability to promote learning and academic success (Ashton, 1985; Brophy, 2006; Tschannen-Moran, Woolfolk Hoy, & Hoy, 1998; R. S. Weinstein, Madison, & Kuklinski, 1995).

Also, in daily interactions with students, teachers must take pains to communicate optimistic attributions about students' performance (Brophy, 2004; Dweck, 2000; Graham, 1991). For instance, when a student succeeds at a task, a teacher might attribute the success to a combination of natural ability, effort, and good strategies (e.g., "Obviously you're good at this, and you've been working very hard to apply the new writing techniques you learned"). And when a student has difficulty with a task, attributions to controllable factors such as effort and strategies are most beneficial (e.g., "Perhaps you need to study a little more next time, and here are some suggestions on how you might study a little differently . . ."). Equally important is to communicate that ability in particular domains can improve over time, especially with hard work and practice—thus conveying an incremental view of intelligence (Blackwell et al., 2007; Brophy, 2004; Dweck & Molden, 2005).

◆ *Systematic attribution retraining can positively impact students' attributions.* Numerous research studies have shown that students' attributions can be altered, with more persistence in the face of failure being the result. In these **attribution retraining** studies, children are asked to engage in a particular task (e.g., reading difficult sentences, solving arithmetic problems, or constructing geometric puzzles), with occasional failures interspersed among more frequent successes. Within this context, one viable approach for changing attributions is for an adult to interpret each success in terms of high effort or good strategies and each failure in terms of insufficient effort or ineffective strategies. But even more effective is teaching children to explicitly attribute their *own* successes and failures to amount of effort or specific strategies (Berkeley, Mastropieri, & Scruggs, 2008; S. Ellis, Mendel, & Nir, 2006; J. W. Fowler & Peterson, 1981; N. C. Hall et al., 2007; Robertson, 2000).

Teachers must keep in mind that students' views of themselves and their abilities aren't likely to change dramatically overnight (Hilt, 2005; Meece, 1994). Thus, efforts to help students acquire productive attributions must be an ongoing endeavor rather than a one-shot intervention.

◆ *Most of the time, and for most students, noncompetitive activities are more motivating than competitive ones.* Many learners can be motivated by competition if they believe they have a reasonable chance of winning (Deci & Moller, 2005; S. M. Garcia & Tor, 2009; D. W. Johnson & Johnson, 2009a). For example, the *good behavior game* described in Chapter 5, in which two groups of students compete for privileges based on good behavior, leads to marked improvements in students' classroom behavior. Although this situation has an element of competition, both teams can win if their behavior warrants it. But when competition requires that only some people can win and others must lose, several undesirable side effects can result:

- *Competition promotes performance goals rather than mastery goals.* When the key to success is doing better than everyone else, learners inevitably focus their attention on the quality



of their performance rather than on the quality of their learning (C. Ames, 1984; Nicholls, 1984; Stipek, 1996).

- *Competition promotes attributions to ability rather than to effort.* Learners who lose in competitive situations even with a great deal of effort quite logically reach the conclusion that effort isn't enough—that their failure must be the result of insufficient natural ability (C. Ames, 1984; Nicholls, 1984; Thorndike-Christ, 2008).
- *For the losers, competition promotes a low sense of competence and diminishes self-worth.* When learners define success as mastery of a task or improvement in an activity over time, success is likely to come frequently and thus will enhance self-efficacy. But when learners instead define success as coming out on top, most must inevitably be losers. In the face of such “failure,” they may understandably begin to believe themselves to be incompetent, experience unpleasant affect, and may possibly engage in self-handicapping as a way of protecting their sense of self-worth (C. Ames, 1984; Covington & Müeller, 2001; Kim, Lee, Chung, & Bong, 2010; A. J. Martin, Marsh, Williamson, & Debus, 2003).

As a result of such factors, competitive classroom environments typically lead to lower achievement for most students. Not only do students earn lower grades but they also develop more negative attitudes toward school (Covington, 1992; Graham & Golen, 1991; Krampen, 1987; M.-T. Wang & Holcombe, 2010). Competitive classroom environments can be especially detrimental to female students (Catsambis, 2005; Inglehart, Brown, & Vida, 1994).

Teachers can take a variety of steps to minimize comparison and competition among students. For example, they can keep students' performance on classroom tasks private and confidential, minimizing the degree to which students are even aware of classmates' performance levels. At any one time, they can have different students doing different tasks. They can assess students' performance independently of how well classmates are doing and encourage students to assess their own performance in a similar manner. When using short competitive activities (e.g., debates, team math games) to liven up a lesson, teachers can make sure that all students or teams have a reasonable (and, if possible, equal) chance of winning and not make a big deal about who the ultimate winners are (Brophy, 2004; Linnenbrink, 2005; Spaulding, 1992; Stipek, 1996).

♦ *Age- and ability-appropriate challenges heighten motivation and minimize boredom.* In Chapter 16, I mentioned that success on challenging tasks can enhance learners' sense of competence. Challenges have other benefits as well. For one thing, they tend to stimulate interest. Learners typically become bored with easy tasks yet are frustrated by tasks at which they always seem to fail. Challenges provide a happy medium: They have those unexpected little twists and turns that maintain interest, but success is possible with persistence and the right strategies (Fredricks et al., 2010; Hidi & Renninger, 2006; Pekrun, Goetz, Daniels, Stupnisky, & Perry, 2010; Shernoff & Csikszentmihalyi, 2009).

Another beneficial outcome of challenges is that they promote productive attributions. When learners succeed at a very easy task—one on which they've exerted very little effort—they're likely to attribute their success to the fact that, hey, anybody can do it. When learners succeed at an *extremely* difficult task—something they thought themselves incapable of doing—they might attribute their success to good luck or somebody else's assistance. However, when they succeed at a challenging task—one they know they can do if they try long and hard enough—they can't explain their success as being the result of task ease, and they have little

reason to attribute their performance to luck or assistance. Their best alternative is to attribute their hard-won success to their own efforts and clever strategies. And such an attribution should bolster their self-efficacy and sense of competence and, perhaps, their overall sense of self-worth (Clifford, 1990; Eisenberger, 1992; Lan, Repman, Bradley, & Weller, 1994; C. Peterson, 1990; J. W. Thomas et al., 1993).

As we've seen in earlier chapters, challenging tasks are important not only for motivation but also for learning and cognitive development (see the discussions of Vygotsky's theory in Chapter 13 and metacognition in Chapter 14). When are learners most likely to take on new risks and challenges? Theorists suggest that conditions such as these are optimal:

- Standards for success are realistic for each individual.
- Scaffolding is sufficient to make success possible.
- There are few, if any, penalties for errors.
- Rewards can't be obtained by engaging in easier tasks, *or* rewards are greater for challenging tasks than they are for easy ones.
- Learners believe that success will probably be the result of their own knowledge, skills, efforts, and strategies (i.e., learners have internal attributions).
- Learners have a sense of competence and a sense of self-determination. (Brophy & Alleman, 1992; Clifford, 1990; Corno & Rohrkemper, 1985; Deci & Ryan, 1985; Dweck & Elliott, 1983; Lan et al., 1994; N. E. Perry, VandeKamp, Mercer, & Nordby, 2002; Stipek, 1993)

I've already mentioned that success on challenging tasks promotes feelings of competence. But the last of the conditions I just listed indicates that the reverse is also true: Competence increases the challenges that learners willingly undertake. In other words, we have a happily "vicious" cycle here: Challenge promotes competence, and competence promotes a desire for more challenge.

Yet the school day shouldn't necessarily be one challenge after another. Such a state of affairs would be absolutely exhausting, and probably quite discouraging as well. Instead, teachers should probably strike a balance between easy tasks—those that will boost students' self-confidence over the short run—and the challenging tasks so critical for a long-term sense of competence and self-efficacy (Spaulding, 1992; Stipek, 1996).

## A TARGETS Mnemonic for Motivational Strategies

By and large, effective motivational strategies can be summed up by the mnemonic TARGETS: task, autonomy, recognition, grouping, evaluation, time, and social support (L. H. Anderman & Anderman, 2009; J. L. Epstein, 1989; Maehr & Anderman, 1993). This multifaceted approach to enhancing learners' motivation is presented in Table 17.3. If you look closely at the entries in the table, you'll find that they reflect many of the concepts we've addressed in our two chapters on motivation and affect, including intrinsic and extrinsic motivation, competence and self-worth, self-determination, relatedness, hot cognition, interests, expectancies, values, expectations, goals, and attributions. And especially if you look at Column 2, you'll be convinced, as I am, that teachers clearly *can* make a difference—in fact, a very sizable one—not only in promoting students' learning but in enhancing their motivation as well.

**Table 17.3**

Seven TARGETS principles of motivation

Principle	Examples of Classroom Practices
Classroom <b>tasks</b> affect motivation.	<ul style="list-style-type: none"> <li>• Present new topics through tasks that students find interesting, engaging, and perhaps emotionally charged.</li> <li>• Encourage meaningful rather than rote learning.</li> <li>• Relate activities to students' lives and goals.</li> <li>• Provide sufficient support to enable students to be successful.</li> </ul>
The amount of <b>autonomy</b> students have affects motivation, especially intrinsic motivation.	<ul style="list-style-type: none"> <li>• Give students some choice about what and how they learn.</li> <li>• Teach self-regulation strategies.</li> <li>• Solicit students' opinions about classroom practices and policies.</li> <li>• Have students take leadership roles in some activities.</li> </ul>
The amount and nature of the <b>recognition</b> students receive affect motivation.	<ul style="list-style-type: none"> <li>• Acknowledge not only academic successes but also personal and social successes.</li> <li>• Commend students for improvement as well as for mastery.</li> <li>• Provide concrete reinforcers for achievement only when students aren't intrinsically motivated to learn.</li> <li>• Show students how their own efforts and strategies are directly responsible for their successes.</li> </ul>
The <b>grouping</b> procedures in the classroom affect motivation.	<ul style="list-style-type: none"> <li>• Provide frequent opportunities for students to interact with one another (e.g., cooperative learning activities, peer tutoring).</li> <li>• Plan small-group activities in which all students can make significant contributions.</li> <li>• Teach the social skills that students need to interact effectively with peers.</li> </ul>
The forms of <b>evaluation</b> in the classroom affect motivation.	<ul style="list-style-type: none"> <li>• Make evaluation criteria clear; specify them in advance.</li> <li>• Minimize or eliminate competition for grades (e.g., don't grade "on a curve").</li> <li>• Give specific feedback about what students are doing well.</li> <li>• Give concrete suggestions for how students can improve.</li> </ul>
How teachers schedule <b>time</b> affects motivation.	<ul style="list-style-type: none"> <li>• Give students enough time to gain mastery of important topics and skills.</li> <li>• Let students' interests dictate some activities.</li> <li>• Include variety in the school day (e.g., intersperse high-energy activities among more sedentary ones).</li> </ul>
The amount of <b>social support</b> students believe they have in the classroom affects motivation.	<ul style="list-style-type: none"> <li>• Create a general atmosphere of mutual caring, respect, and support among all class members.</li> <li>• Convey affection and respect for every student, along with a genuine eagerness to help every student succeed.</li> <li>• Create situations in which all students feel comfortable participating actively in classroom activities (including students who are excessively shy, students who have limited academic skills, students who have physical disabilities, etc.).</li> </ul>

Sources: L. H. Anderman & Anderman, 2009; L. H. Anderman, Andrzejewski, & Allen, 2011; L. H. Anderman, Patrick, Hruda, & Linnenbrink, 2002; J. L. Epstein, 1989; Maehr & Anderman, 1993; Patrick et al., 1997.

---

## SUMMARY

Cognition plays a significant role in many aspects of human motivation. One influential factor that has both cognitive and affective components is *interest*, which can take either of two forms. *Situational interest* is temporary and evoked by something in the immediate environment. *Personal interest* is more stable and resides within the individual. Learners who are interested in the topic they're studying engage in more effective information processing and so remember the subject matter better over the long run. Teachers can often get students actively engaged in classroom subject matter both by capitalizing on individual personal interests and by evoking situational interest—for instance, by conducting hands-on activities or assigning fiction and nonfiction to which students can personally relate.

Some motivation theorists have proposed that motivation for performing any particular task depends on two subjective variables. First, learners must have an *expectancy* that they'll be successful; their expectations for success will depend not only on their current ability level but also on such outside factors as the quality of instruction and the availability of resources and support. Second, learners must *value* the task: They must believe that performing it has direct or indirect benefits—perhaps achieving a desired goal, making a good impression on others, or simply having fun. In the classroom, students must believe they'll have the support they need to master something; they must also see how school subject matter is relevant to their present concerns and long-term goals.

Learners have a wide variety of goals that may either contribute to or interfere with learning in instructional settings. Students who have *mastery goals* want to acquire additional knowledge or skills. Those who have *performance goals* either want to look competent in the eyes of others (a *performance-approach goal*) or else not to look incompetent (a *performance-avoidance goal*). These three kinds of achievement goals aren't necessarily mutually exclusive (a person might have two, or even all three), but generally speaking, learners with mastery goals are

more likely to recognize that competence comes only through effort and practice, to choose activities that maximize opportunities for learning, and to use errors constructively to improve future performance. Other common goals include *work-avoidance goals* (i.e., getting by with minimal effort), *social goals* (i.e., gaining and maintaining relationships with others), and *career goals*. Sometimes people can work toward two or more goals simultaneously; at other times, achieving one goal prevents them from satisfying others. Ideally, teachers should focus students' attention primarily on mastery goals, and they should encourage students to set some of their own goals, including short-term, concrete ones that will give them a sense of accomplishment and enable them to see the progress they're making.

*Attributions*—the cause-and-effect explanations learners construct for things that happen to them—are yet another cognitive factor affecting motivation. Attributions influence many aspects of behavior and cognition, including emotional reactions to success and failure, expectations for future success, expenditure of effort, learning strategies, and future choices and goals. People's attributions emerge from many sources. Their history of successes and failures certainly has an influence; for instance, if people consistently fail no matter what they do, they're apt to attribute this failure to something stable and uncontrollable, such as lack of natural talent. But other factors make a difference as well, including situational cues (e.g., the apparent difficulty of a task), the attributions that other individuals communicate either verbally or nonverbally, the beliefs and worldviews of one's culture, and self-protective biases. As children grow older, and especially as they reach adolescence or adulthood, many develop a general explanatory style, perhaps an I-can-do-it attitude (*mastery orientation*) that promotes effort, persistence, and preference for challenge, or perhaps an I-can't-do-it attitude (*learned helplessness*) that leads them to set easy goals and to give up quickly in the face of obstacles. Through both what they say and what they do, teachers should communicate attributions that lead

students to be optimistic about achieving success on classroom tasks.

Just as successful learners self-regulate their cognitive processes, so, too, do they intentionally try to bring productive motives and emotions to a learning situation—for instance by setting specific goals for a learning task, devising ways to make boring tasks more interesting, and trying to put worrisome

thoughts out of mind. Self-regulation is also reflected in the phenomenon of *internalized motivation*: People gradually begin to value and adopt the behaviors that those around them value and encourage. Teachers and other adults can foster internalized motivation by creating a warm and supportive environment, giving learners some autonomy in what they do and learn, and providing sufficient structure to promote success.

*This page intentionally left blank*

# References

- Ablard, K. E., & Lipschultz, R. E. (1998). Self-regulated learning in high-achieving students: Relations to advanced reasoning, achievement goals, and gender. *Journal of Educational Psychology, 90*, 94–101.
- Abrami, P. C., Bernard, R. M., Borokhovski, E., Wade, A., Surkes, M. A., Tamim, R., et al. (2008). Instructional interventions affecting critical thinking skills and dispositions: A stage 1 meta-analysis. *Review of Educational Research, 78*, 1102–1134.
- Abrams, R. A. (1994). The forces that move the eyes. *Current Directions in Psychological Science, 3*, 65–67.
- Abrams, R. A., & Christ, S. E. (2003). Motion onset captures attention. *Psychological Science, 14*, 427–432.
- Ackerman, P. L. (2007). New developments in understanding skilled performance. *Current Directions in Psychological Science, 16*, 235–239.
- Adamson, L. B., & Bakeman, R. (1991). The development of shared attention during infancy. In R. Vasta (Ed.), *Annals of child development* (Vol. 8, pp. 1–41). London: Kingsley.
- Adamson, L. B., & McArthur, D. (1995). Joint attention, affect, and culture. In C. Moore & P. J. Dunham (Eds.), *Joint attention: Its origins and role in development* (pp. 205–221). Hillsdale, NJ: Erlbaum.
- Adolphs, R., & Damasio, A. R. (2001). The interaction of affect and cognition: A neurobiological perspective. In J. P. Forgas (Ed.), *Handbook of affect and social cognition* (pp. 27–49). Mahwah, NJ: Erlbaum.
- Adrián, J. E., Clemente, R. A., & Villanueva, L. (2007). Mothers' use of cognitive state verbs in picture-book reading and the development of children's understanding of mind: A longitudinal study. *Child Development, 78*, 1052–1067.
- Afflerbach, P., & Cho, B.-Y. (2010). Determining and describing reading strategies: Internet and traditional forms of reading. In H. S. Waters & W. Schneider (Eds.), *Metacognition, strategy use, and instruction* (pp. 201–225). New York: Guilford Press.
- Ainley, M. (2006). Connecting with learning: Motivation, affect, and cognition in interest processes. *Educational Psychology Review, 18*, 391–405.
- Alberto, P. A., & Troutman, A. C. (2009). *Applied behavior analysis for teachers* (8th ed.). Upper Saddle River, NJ: Merrill/Pearson Education.
- Alderman, K. (1990). Motivation for at-risk students. *Educational Leadership, 48*(1), 27–30.
- Aleven, V., Stahl, E., Schworm, S., Fischer, F., & Wallace, R. (2003). Help seeking and help design in interactive learning environments. *Review of Educational Research, 73*, 277–320.
- Alexander, J. M., Johnson, K. E., Leibham, M. E., & Kelley, K. (2008). The development of conceptual interests in young children. *Cognitive Development, 23*, 324–334.
- Alexander, J. M., Johnson, K. E., Scott, B., & Meyer, R. D. (2008). Stegosaurus and spoonbills: Mechanisms for transfer across biological domains. In M. F. Shaughnessy, M. V. E. Vennemann, & C. K. Kennedy (Eds.), *Metacognition: A recent review of research, theory, and perspectives* (pp. 63–83). Happaage, NY: Nova.
- Alexander, L., Frankiewicz, R., & Williams, R. (1979). Facilitation of learning and retention of oral instruction using advance and post organizers. *Journal of Educational Psychology, 71*, 701–707.
- Alexander, P. A. (1997). Mapping the multidimensional nature of domain learning: The interplay of cognitive, motivational, and strategic forces. In P. R. Pintrich & M. L. Maehr (Eds.), *Advances in motivation and achievement* (Vol. 10, pp. 213–250). Greenwich, CT: JAI Press.
- Alexander, P. A. (1998). Positioning conceptual change within a model of domain literacy. In B. Guzzetti & C. Hynd (Eds.), *Perspectives on conceptual change: Multiple ways to understand knowing and learning in a complex world* (pp. 55–76). Mahwah, NJ: Erlbaum.
- Alexander, P. A. (2003). The development of expertise: The journey from acclimation to proficiency. *Educational Researcher, 32*(8), 10–14.
- Alexander, P. A. (2004). A model of domain learning: Reinterpreting expertise as a multidimensional, multistage process. In D. Y. Dai & R. J. Sternberg (Eds.), *Motivation, emotion, and cognition: Integrative perspectives on intellectual functioning and development* (pp. 273–298). Mahwah, NJ: Erlbaum.
- Alexander, P. A., Graham, S., & Harris, K. R. (1998). A perspective on strategy research: Progress and prospects. *Educational Psychology Review, 10*, 129–154.
- Alexander, P. A., & Jetton, T. L. (1996). The role of importance and interest in the processing of text. *Educational Psychology Review, 8*, 89–121.
- Alexander, P. A., Kulikowich, J. M., & Schulze, S. K. (1994). How subject-matter knowledge affects recall and interest. *American Educational Research Journal, 31*, 313–337.
- Alexander, P. A., White, C. S., & Daugherty, M. (1997). Analogical reasoning and early mathematical learning. In L. D. English (Ed.), *Mathematical reasoning: Analogies, metaphors, and images* (pp. 117–147). Mahwah, NJ: Erlbaum.
- Alfassi, M. (2004). Reading to learn: Effects of combined strategy instruction on high school students. *Journal of Educational Research, 97*, 171–184.
- Allen, K. D. (1998). The use of an enhanced simplified habit-reversal procedure to reduce disruptive outbursts during athletic performance. *Journal of Applied Behavior Analysis, 31*, 489–492.
- Alloway, T. P., Gathercole, S. E., Kirkwood, H., & Elliott, J. (2009). The cognitive and behavioral characteristics of children with low working memory. *Child Development, 80*, 606–621.
- Altmann, E. M., & Gray, W. D. (2002). Forgetting to remember: The functional relationship of decay and interference. *Psychological Science, 13*, 27–33.
- Alvarez, G. A., & Cavanagh, P. (2004). The capacity of visual short-term memory is set both by visual information load and by number of objects. *Psychological Science, 15*, 106–111.
- Amabile, T. M., & Hennessey, B. A. (1992). The motivation for creativity in children. In A. K. Boggiano & T. S. Pittman (Eds.), *Achievement and motivation: A social-developmental perspective* (pp. 54–74). Cambridge, England: Cambridge University Press.
- American Psychological Association Zero Tolerance Task Force (2008). Are zero tolerance policies effective in the schools? An evidentiary review and recommendations. *American Psychologist, 63*, 852–862.
- Ames, C. (1984). Competitive, cooperative, and individualistic goal structures: A cognitive-motivational analysis. In R. Ames & C. Ames (Eds.), *Research on motivation in education: Vol. 1. Student motivation* (pp. 177–207). Orlando: Academic Press.
- Ames, C. (1992). Classrooms: Goals, structures, and student motivation. *Journal of Educational Psychology, 84*, 261–271.
- Ames, R. (1983). Help-seeking and achievement orientation: Perspectives from attribution theory. In A. Nadler, J. Fisher, & B. DePaulo (Eds.), *New directions in helping: Vol. 2. Help seeking* (pp. 165–186). New York: Academic Press.
- Amrein, A. L., & Berliner, D. C. (2002, March 28). High-stakes testing, uncertainty, and student learning. *Education Policy Analysis Archives, 10*(18). Retrieved April 9, 2002, from <http://epaa.asu.edu/epaa/v10n18/>.
- Amsterlaw, J. (2006). Children's beliefs about everyday reasoning. *Child Development, 77*, 443–464.
- Anand, P., & Ross, S. (1987). A computer-based strategy for personalizing verbal problems in teaching mathematics. *Educational Communication and Technology Journal, 35*, 151–162.
- Anderman, E. M., Griesinger, T., & Westerfield, G. (1998). Motivation and cheating during early adolescence. *Journal of Educational Psychology, 90*, 84–93.
- Anderman, E. M., & Maehr, M. L. (1994). Motivation and schooling in the middle grades. *Review of Educational Research, 64*, 287–309.
- Anderman, E. M., Noar, S., Zimmerman, R. S., & Donohew, L. (2004). The need for sensation as a prerequisite for motivation to engage in academic tasks. In M. L. Maehr & P. Pintrich (Eds.), *Advances in motivation and achievement*:

- Vol. 13. *Motivating students, improving schools: The legacy of Carol Midgley* (pp. 1–26). Greenwich, CT: JAI Press.
- Anderman, E. M., & Wolters, C. A. (2006). Goals, values, and affect: Influences on student motivation. In P. A. Alexander & P. H. Winne (Eds.), *Handbook of educational psychology* (2nd ed., pp. 369–389). Mahwah, NJ: Erlbaum.
- Anderman, L. H., & Anderman, E. M. (1999). Social predictors of changes in students' achievement goal orientation. *Contemporary Educational Psychology*, 25, 21–37.
- Anderman, L. H., & Anderman, E. M. (2009). Oriented towards mastery: Promoting positive motivational goals for students. In R. Gilman, E. S. Huebner, & M. J. Furlong (Eds.), *Handbook of positive psychology in schools* (pp. 161–173). New York: Routledge.
- Anderman, L. H., Andrzejewski, C. E., & Allen, J. (2011). How do teachers support students' motivation and learning in their classrooms? *Teachers College Record*, 113(5). Advance online publication retrieved from <http://www.tcrecord.org/Content.asp?contentid=16085>.
- Anderman, L. H., Patrick, H., Hrudá, L. Z., & Linnenbrink, E. A. (2002). Observing classroom goal structures to clarify and expand goal theory. In C. Midgley (Ed.), *Goals, goal structures, and patterns of adaptive learning* (pp. 243–278). Mahwah, NJ: Erlbaum.
- Anderson, C. A., Berkowitz, L., Donnerstein, E., Huesmann, L. R., Johnson, J. D., Linz, D., Malamuth, N. M., & Wartella, E. (2003). The influence of media violence on youth. *Psychological Science in the Public Interest*, 4, 81–110.
- Anderson, D. R. (2003). The Children's Television Act: A public policy that benefits children. *Applied Developmental Psychology*, 24, 337–340.
- Anderson, J. R. (1974). Retrieval of propositional information from long-term memory. *Cognitive Psychology*, 6, 451–474.
- Anderson, J. R. (1976). *Language, memory, and thought*. Hillsdale, NJ: Erlbaum.
- Anderson, J. R. (1983a). *The architecture of cognition*. Cambridge, MA: Harvard University Press.
- Anderson, J. R. (1983b). A spreading activation theory of memory. *Journal of Verbal Learning and Verbal Behavior*, 22, 261–295.
- Anderson, J. R. (1987). Skill acquisition: Compilation of weak-method problem solutions. *Psychological Review*, 94, 192–210.
- Anderson, J. R. (1995). *Learning and memory: An integrated approach*. New York: Wiley.
- Anderson, J. R. (2005). *Cognitive psychology and its implications* (6th ed.). New York: Worth.
- Anderson, J. R., Greeno, J. G., Reder, L. M., & Simon, H. A. (2000). Perspectives on learning, thinking, and activity. *Educational Researcher*, 29(4), 11–13.
- Anderson, J. R., Reder, L. M., & Simon, H. A. (1996). Situated learning and education. *Educational Researcher*, 25(4), 5–11.
- Anderson, J. R., Reder, L. M., & Simon, H. A. (1997). Situative versus cognitive perspectives: Form versus substance. *Educational Researcher*, 26(1), 18–21.
- Anderson, J. R., & Schooler, L. J. (1991). Reflections of the environment in memory. *Psychological Science*, 2, 396–408.
- Anderson, L. W., Krathwohl, D. R., Airasian, P. W., Cruikshank, K. A., Mayer, R. E., Pintrich, P. R., Raths, J., & Wittrock, M. C. (Eds.) (2001). *A taxonomy for learning, teaching, and assessing: A revision of Bloom's taxonomy of educational objectives*. New York: Longman.
- Anderson, M. C., & Green, C. (2001). Suppressing unwanted memories by executive control. *Nature*, 410, 366–369.
- Anderson, M. C., & Levy, B. J. (2009). Suppressing unwanted memories. *Current Directions in Psychological Science*, 18, 189–194.
- Anderson, P., Rothbaum, B. O., & Hodges, L. F. (2003). Virtual reality exposure in the treatment of social anxiety. *Cognitive and Behavioral Practice*, 10, 240–247.
- Anderson, R. C., Nguyen-Jahiel, K., McNurlen, B., Archodidou, A., Kim, S.-Y., Reznitskaya, A., Tillmanns, M., & Gilbert, L. (2001). The snowball phenomenon: Spread of ways of talking and ways of thinking across groups of children. *Cognition and Instruction*, 19, 1–46.
- Anderson, R. C., & Pichert, J. W. (1978). Recall of previously unrecalleable information following a shift in perspective. *Journal of Verbal Learning and Verbal Behavior*, 17, 1–12.
- Anderson, R. C., Reynolds, R. E., Schallert, D. L., & Goetz, E. T. (1977). Frameworks for comprehending discourse. *American Educational Research Journal*, 14, 367–381.
- Anderson, V., & Hidi, S. (1988/1989). Teaching students to summarize. *Educational Leadership*, 46(4), 26–28.
- Andrade, H. L. (2010). Students as the definitive source of formative assessment: Academic self-assessment and the self-regulation of learning. In H. L. Andrade & G. J. Cizek (Eds.), *Handbook of formative assessment* (pp. 90–105). New York: Routledge.
- Andre, T. (1986). Problem solving and education. In G. D. Pyle & T. Andre (Eds.), *Cognitive classroom learning: Understanding, thinking, and problem solving* (pp. 169–204). Orlando: Academic Press.
- Andre, T., & Windschitl, M. (2003). Interest, epistemological belief, and intentional conceptual change. In G. M. Sinatra & P. R. Pintrich (Eds.), *Intentional conceptual change* (pp. 173–197). Mahwah, NJ: Erlbaum.
- Andres, M., Olivier, E., & Badets, A. (2008). Actions, words, and numbers: A motor contribution to semantic processing? *Current Directions in Psychological Science*, 17, 313–317.
- Andriessen, J. (2006). Arguing to learn. In R. K. Sawyer (Ed.), *The Cambridge handbook of the learning sciences* (pp. 443–459). Cambridge, England: Cambridge University Press.
- Anzai, Y. (1991). Learning and use of representations for physics expertise. In K. A. Ericsson & J. Smith (Eds.), *Toward a general theory of expertise: Prospects and limits* (pp. 64–92). Cambridge, England: Cambridge University Press.
- Appel, J. B., & Peterson, N. J. (1965). Punishment: Effects of shock intensity on response suppression. *Psychological Reports*, 16, 721–730.
- Applebee, A. N., Langer, J. A., Nystrand, M., & Gamoran, A. (2003). Discussion-based approaches to developing understanding: Classroom instruction and student performance in middle and high school English. *American Educational Research Journal*, 40, 685–730.
- Archambault, I., Eccles, J. S., & Vida, M. N. (2010). Ability self-concepts and subjective value in literacy: Joint trajectories from grades 1 through 12. *Journal of Educational Psychology*, 102, 804–816.
- Ardo, S. P., Martens, B. K., & Wolfe, L. A. (1999). Using high-probability instructional sequences with fading to increase student compliance during transitions. *Journal of Applied Behavior Analysis*, 32, 339–351.
- Ariely, D., & Wertenbroch, K. (2002). Procrastination, deadlines, and performance: Self-control by precommitment. *Psychological Science*, 13, 219–224.
- Arlin, M. (1984). Time, equality, and mastery learning. *Review of Educational Research*, 54, 65–86.
- Armbruster, B. B. (1984). The problem of "inconsiderate text." In G. G. Duffy, L. R. Roehler, & J. Mason (Eds.), *Comprehension instruction: Perspectives and suggestions* (pp. 202–217). New York: Longman.
- Aron, A. R. (2008). Progress in executive-function research: From tasks to functions to regions to networks. *Current Directions in Psychological Science*, 17, 124–129.
- Aronfreed, J. (1968). Aversive control of socialization. In W. J. Arnold (Ed.), *Nebraska Symposium on Motivation* (pp. 271–320). Lincoln: University of Nebraska Press.
- Aronfreed, J., & Reber, A. (1965). Internalized behavioral suppression and the timing of social punishment. *Journal of Personality and Social Psychology*, 1, 3–16.
- Aronson, E. (1997). *The jigsaw classroom: Building cooperation in the classroom* (2nd ed.). New York: Longman.
- Aronson, J., & Steele, C. M. (2005). Stereotypes and the fragility of academic competence, motivation, and self-concept. In A. J. Elliot & C. S. Dweck (Eds.), *Handbook of competence and motivation* (pp. 436–456). New York: Guilford Press.
- Arrigo, J. M., & Pezdek, K. (1997). Lessons from the study of psychogenic amnesia. *Current Directions in Psychological Science*, 6, 148–152.
- Artman, L., & Cahan, S. (1993). Schooling and the development of transitive inference. *Developmental Psychology*, 29, 753–759.
- Ash, D. (2002). Negotiations of thematic conversations about biology. In G. Leinhardt, K. Crowley, & K. Knutson (Eds.), *Learning conversations in museums* (pp. 357–400). Mahwah, NJ: Erlbaum.
- Ash, I. K., & Wiley, J. (2006). The nature of restructuring in insight: An individual-differences approach. *Psychonomic Bulletin & Review*, 13(1), 66–73.
- Ashcraft, M. H. (2002). Math anxiety: Personal, educational, and cognitive consequences.



- Current Directions in Psychological Science*, 11, 181–184.
- Ashton, P. (1985). Motivation and the teacher's sense of efficacy. In C. Ames & R. Ames (Eds.), *Research on motivation in education: Vol. 2. The classroom milieu* (pp. 141–174). San Diego, CA: Academic Press.
- Assor, A., & Connell, J. P. (1992). The validity of students' self-reports as measures of performance affecting self-appraisals. In D. H. Schunk & J. L. Meece (Eds.), *Student perceptions in the classroom* (pp. 25–46). Hillsdale, NJ: Erlbaum.
- Assor, A., Roth, G., & Deci, E. L. (2004). The emotional costs of parents' conditional regard: A self-determination theory analysis. *Journal of Personality*, 72, 47–89.
- Assor, A., Vansteenkiste, M., & Kaplan, A. (2009). Identified versus introjected approach and introjected avoidance motivations in school and in sports: The limited benefits of self-worth strivings. *Journal of Educational Psychology*, 101, 482–497.
- Asterhan, C. S. C., & Schwarz, B. B. (2007). The effects of monological and dialogical argumentation on concept learning in evolutionary theory. *Journal of Educational Psychology*, 99, 626–639.
- Astington, J. W., & Pelletier, J. (1996). The language of mind: Its role in teaching and learning. In D. R. Olson & N. Torrance (Eds.), *The handbook of education and human development: New models of learning, teaching, and schooling* (pp. 593–620). Cambridge, MA: Blackwell.
- Astuti, R., Solomon, G. E. A., & Carey, S. (2004). Constraints on conceptual development. *Monographs of the Society for Research in Child Development*, 69 (3, Serial No. 277).
- Atance, C. M., & Meltzoff, A. N. (2006). Preschoolers' current desires warp their choices for the future. *Psychological Science*, 17, 583–587.
- Atkinson, J. W. (1957). Motivational determinants of risk-taking behavior. *Psychological Review*, 64, 359–372.
- Atkinson, J. W. (1958). *Motives in fantasy, action, and sobriety*. Princeton, NJ: Van Nostrand.
- Atkinson, J. W. (1964). *Introduction to motivation*. Princeton, NJ: Van Nostrand.
- Atkinson, J. W., & Birch, D. (1978). *Introduction to motivation* (2nd ed.). New York: Van Nostrand.
- Atkinson, J. W., & Feather, N. T. (Eds.) (1966). *A theory of achievement motivation*. New York: Wiley.
- Atkinson, J. W., & Litwin, G. H. (1960). Achievement motive and test anxiety conceived as motive to approach success and motive to avoid failure. *Journal of Abnormal and Social Psychology*, 60, 52–63.
- Atkinson, J. W., & Raynor, J. O. (1978). *Personality, motivation, and achievement*. Washington, DC: Hemisphere.
- Atkinson, R. C. (1975). Mnemotechnics in second-language learning. *American Psychologist*, 30, 821–828.
- Atkinson, R. C., & Shiffrin, R. M. (1968). Human memory: A proposed system and its control processes. In K. W. Spence & J. T. Spence (Eds.), *The psychology of learning and motivation: Advances in research and theory* (Vol. 2). New York: Academic Press.
- Atkinson, R. C., & Shiffrin, R. M. (1971). The control of short-term memory. *Scientific American*, 225(2), 82–90.
- Atkinson, R. K., Catrambone, R., & Merrill, M. M. (2003). Aiding transfer in statistics: Examining the use of conceptually oriented equations and elaborations during subgoal learning. *Journal of Educational Psychology*, 95, 762–773.
- Atkinson, R. K., Derry, S. J., Renkl, A., & Wortham, D. (2000). Learning from examples: Instructional principles from the worked examples research. *Review of Educational Research*, 70, 181–214.
- Atkinson, R. K., Levin, J. R., Kiewra, K. A., Meyers, T., Kim, S., Atkinson, L. A., Renandya, W. A., & Hwang, Y. (1999). Matrix and mnemonic text-processing adjuncts: Comparing and combining their components. *Journal of Educational Psychology*, 91, 342–357.
- Atkinson, R. K., Renkl, A., & Merrill, M. M. (2003). Transitioning from studying examples to solving problems: Effects of self-explanation prompts and fading worked-out steps. *Journal of Educational Psychology*, 95, 774–783.
- Au, W. (2007). High-stakes testing and curricular control: A qualitative metasynthesis. *Educational Researcher*, 36, 258–267.
- Aulls, M. W. (1998). Contributions of classroom discourse to what content students learn during curriculum enactment. *Journal of Educational Psychology*, 90, 56–69.
- Austin, J., Alvero, A. M., & Olson, R. (1998). Prompting patron safety belt use at a restaurant. *Journal of Applied Behavior Analysis*, 31, 655–657.
- Austin, J. L. (2000). Behavioral approaches to college teaching. In J. Austin and J. E. Carr (Eds.), *Handbook of applied behavior analysis* (pp. 449–471). Reno, NV: Context Press.
- Austin, J. L., & Soeda, J. M. (2008). Fixed-time teacher attention to decrease off-task behaviors of typically developing third graders. *Journal of Applied Behavior Analysis*, 41, 279–283.
- Ausubel, D. P. (1963). *The psychology of meaningful verbal learning*. New York: Grune & Stratton.
- Ausubel, D. P. (1968). *Educational psychology: A cognitive view*. New York: Holt, Rinehart & Winston.
- Ausubel, D. P., Novak, J. D., & Hanesian, H. (1978). *Educational psychology: A cognitive view* (2nd ed.). New York: Holt, Rinehart & Winston.
- Ausubel, D. P., & Robinson, F. G. (1969). *School learning: An introduction to educational psychology*. New York: Holt, Rinehart & Winston.
- Awh, E., Jonides, J., Smith, E. E., Schumacher, E. H., Koeppel, R. A., & Katz, S. (1996). Dissociation of storage and rehearsal in verbal working memory: Evidence from positron emission tomography. *Psychological Science*, 7, 25–31.
- Ayoub, C. C., & Rappolt-Schlichtmann, G. (2007). Child maltreatment and the development of alternate pathways in biology and behavior. In D. Coch, G. Dawson, & K. W. Fischer (Eds.), *Human behavior, learning, and the developing brain: Atypical development* (pp. 305–330). New York: Guilford Press.
- Azevedo, R. (2005). Computer environments as metacognitive tools for enhancing learning. *Educational Psychologist*, 40, 193–197.
- Azevedo, R., & Witherspoon, A. M. (2009). Self-regulated learning with hypermedia. In D. J. Hacker, J. Dunlosky, & A. C. Graesser (Eds.), *Handbook of metacognition in education* (pp. 319–339). New York: Routledge.
- Azrin, N. H. (1960). Effects of punishment intensity during variable-interval reinforcement. *Journal of the Experimental Analysis of Behavior*, 3, 123–142.
- Azrin, N. H., Vinas, V., & Ehle, C. T. (2007). Physical activity as reinforcement for classroom calmness of ADHD children: A preliminary study. *Child and Family Behavior Therapy*, 29, 1–8.
- Babad, E. (1993). Teachers' differential behavior. *Educational Psychology Review*, 5, 347–376.
- Babad, E., Avni-Babad, D., & Rosenthal, R. (2003). Teachers' brief nonverbal behaviors in defined instructional situations can predict students' evaluations. *Journal of Educational Psychology*, 95, 553–562.
- Baccus, J. R., Baldwin, M. W., & Packer, D. J. (2004). Increasing implicit self-esteem through classical conditioning. *Psychological Science*, 15, 498–502.
- Bachevalier, J., Malkova, L., & Beaugard, M. (1996). Multiple memory systems: A neuropsychological and developmental perspective. In G. R. Lyon & N. A. Krasner (Eds.), *Attention, memory, and executive function* (pp. 185–198). Baltimore: Paul H. Brookes.
- Baddeley, A. D. (1978). The trouble with levels: A reexamination of Craik and Lockhart's framework for memory research. *Psychological Review*, 85, 139–152.
- Baddeley, A. D. (1986). *Working memory*. Oxford, England: Clarendon Press.
- Baddeley, A. D. (1999). *Essentials of human memory*. Philadelphia: Psychology Press.
- Baddeley, A. D. (2001). Is working memory still working? *American Psychologist*, 56, 851–864.
- Baddeley, A. D., & Logie, R. (1992). Auditory imagery and working memory. In D. Reisberg (Ed.), *Auditory imagery* (pp. 179–197). Hillsdale, NJ: Erlbaum.
- Bahrnick, H. P. (1984). Semantic memory content in permastore: Fifty years of memory for Spanish learned in school. *Journal of Experimental Psychology: General*, 113, 1–29.
- Bahrnick, H. P., Bahrnick, L. E., Bahrnick, A. S., & Bahrnick, P. E. (1993). Maintenance of foreign language vocabulary and the spacing effect. *Psychological Science*, 4, 316–321.
- Bahrnick, L. E., Gogate, L. J., & Ruiz, I. (2002). Attention and memory for faces and actions in infancy: The salience of actions over faces in dynamic events. *Child Development*, 73, 1629–1643.

- Baillargeon, R. (1994). How do infants learn about the physical world? *Current Directions in Psychological Science*, 3, 133–140.
- Baillargeon, R. (2004). Infants' physical worlds. *Current Directions in Psychological Science*, 13, 89–94.
- Baker, J. (1999). Teacher-student interaction in urban at-risk classrooms: Differential behavior, relationship quality, and student satisfaction with school. *The Elementary School Journal*, 100, 57–70.
- Baker, L. (1989). Metacognition, comprehension monitoring, and the adult reader. *Educational Psychology Review*, 1, 3–38.
- Baker, L., Scher, D., & Mackler, K. (1997). Home and family influences on motivations for reading. *Educational Psychologist*, 32, 69–82.
- Balch, W., Bowman, K., & Mohler, L. (1992). Music-dependent memory in immediate and delayed word recall. *Memory and Cognition*, 20, 21–28.
- Baldwin, C. L. (2007). Cognitive implications of facilitating echoic persistence. *Memory and Cognition*, 35, 774–780.
- Baldwin, D. A. (2000). Interpersonal understanding fuels knowledge acquisition. *Current Directions in Psychological Science*, 9, 40–45.
- Bandalos, D. L., Finney, S. J., & Geske, J. A. (2003). A model of statistics performance based on achievement goal theory. *Journal of Educational Psychology*, 95, 604–616.
- Bandura, A. (1965a). Behavioral modification through modeling practices. In L. Krasner & L. Ullman (Eds.), *Research in behavior modification* (pp. 310–340). New York: Holt, Rinehart & Winston.
- Bandura, A. (1965b). Influence of models' reinforcement contingencies on the acquisition of imitative responses. *Journal of Personality and Social Psychology*, 1, 589–595.
- Bandura, A. (1969). *Principles of behavior modification*. New York: Holt, Rinehart & Winston.
- Bandura, A. (1973). *Aggression: A social learning analysis*. Englewood Cliffs, NJ: Prentice Hall.
- Bandura, A. (1977). *Social learning theory*. Englewood Cliffs, NJ: Prentice Hall.
- Bandura, A. (1982). Self-efficacy mechanism in human agency. *American Psychologist*, 37, 122–147.
- Bandura, A. (1986). *Social foundations of thought and action: A social cognitive theory*. Englewood Cliffs, NJ: Prentice Hall.
- Bandura, A. (1989). Human agency in social cognitive theory. *American Psychologist*, 44, 1175–1184.
- Bandura, A. (1997). *Self-efficacy: The exercise of control*. New York: Freeman.
- Bandura, A. (2000). Exercise of human agency through collective efficacy. *Current Directions in Psychological Science*, 9, 75–78.
- Bandura, A. (2006). Toward a psychology of human agency. *Perspectives on Psychological Science*, 1, 164–180.
- Bandura, A. (2008). Toward an agentic theory of the self. In H. W. Marsh, R. G. Craven, & D. M. McInerney (Eds.), *Self-processes, learning, and enabling human potential* (pp. 15–49). Charlotte, NC: Information Age.
- Bandura, A., Barbaranelli, C., Caprara, G. V., & Pastorelli, C. (2001). Self-efficacy beliefs as shapers of children's aspirations and career trajectories. *Child Development*, 72, 187–206.
- Bandura, A., Jeffery, R. W., & Bachicha, D. L. (1974). Analysis of memory codes and cumulative rehearsal in observational learning. *Journal of Research in Personality*, 7, 295–305.
- Bandura, A., & Kupers, C. J. (1964). Transmission of patterns of self-reinforcement through modeling. *Journal of Abnormal and Social Psychology*, 69, 1–9.
- Bandura, A., Ross, D., & Ross, S. A. (1961). Transmission of aggression through imitation of aggressive models. *Journal of Abnormal and Social Psychology*, 63, 575–582.
- Bandura, A., Ross, D., & Ross, S. A. (1963). Imitation of film-mediated aggressive models. *Journal of Abnormal and Social Psychology*, 66, 3–11.
- Bandura, A., & Walters, R. H. (1963). *Social learning and personality development*. New York: Holt, Rinehart & Winston.
- Bangert-Drowns, R. L., & Bankert, E. (1990, April). *Meta-analysis of effects of explicit instruction for critical thinking*. Paper presented at the annual meeting of the American Educational Research Association, Boston.
- Banich, M. T. (2009). Executive function: The search for an integrated account. *Current Directions in Psychological Science*, 18, 89–94.
- Bao, X., & Lam, S. (2008). Who makes the choice? Rethinking the role of autonomy and relatedness in Chinese children's motivation. *Child Development*, 79, 269–283.
- Barab, S. A., & Dodge, T. (2008). Strategies for designing embodied curriculum. In J. M. Spector, M. D. Merrill, J. van Merriënboer, & M. P. Driscoll (Eds.), *Handbook of research on educational communications and technology* (3rd ed., pp. 97–110). New York: Erlbaum.
- Barbizet, J. (1970). *Human memory and its pathology*. San Francisco: Freeman.
- Barch, D. M. (2003). Cognition in schizophrenia: Does working memory work? *Current Directions in Psychological Science*, 12, 146–150.
- Barchfeld, P., Sodian, B., Thoermer, C., & Bullock, M. (2005, April). *The development of experiment generation abilities from primary school to late adolescence*. Poster presented at the biennial meeting of the Society for Research in Child Development, Atlanta, GA.
- Bargai, N., Ben-Shakhar, G., & Shalev, A. Y. (2007). Posttraumatic stress disorder and depression in battered women: The mediating role of learned helplessness. *Journal of Family Violence*, 22, 267–275.
- Bargh, J. A., & Morsella, E. (2008). The unconscious mind. *Perspectives on Psychological Science*, 3, 73–79.
- Barkley, R. A. (1996). Critical issues in research on attention. In G. R. Lyon & N. A. Krasnegor (Eds.), *Attention, memory, and executive function* (pp. 307–326). Baltimore: Paul H. Brookes.
- Barnett, J. E., Di Vesta, F. J., & Rogozinski, J. T. (1981). What is learned in note taking? *Journal of Educational Psychology*, 73, 181–192.
- Barnett, S. M., & Ceci, S. J. (2002). When and where do we apply what we learn? A taxonomy of far transfer. *Psychological Bulletin*, 128, 612–637.
- Baron, A., Kaufman, A., & Stauber, K. A. (1969). Effects of instructions and reinforcement feedback on human operant behavior maintained by fixed-interval reinforcement. *Journal of the Experimental Analysis of Behavior*, 12, 701–712.
- Baron, J. B. (1987). Evaluating thinking skills in the classroom. In J. B. Baron & R. J. Sternberg (Eds.), *Teaching thinking skills: Theory and practice* (pp. 221–247). New York: Freeman.
- Barrish, H. H., Saunders, M., & Wolf, M. M. (1969). Good behavior game: Effects of individual contingencies for group consequences on disruptive behavior in a classroom. *Journal of Applied Behavior Analysis*, 2, 119–124.
- Barron, B. (2000). Problem solving in video-based microworlds: Collaborative and individual outcomes of high-achieving sixth-grade students. *Journal of Educational Psychology*, 92, 391–398.
- Barsalou, L. W. (2009). Situating concepts. In P. Robbins & M. Aydede (Eds.), *The Cambridge handbook of situated cognition* (pp. 236–263). Cambridge, England: Cambridge University Press.
- Barsalou, L. W., Simmons, W. K., Barbey, A., & Wilson, C. D. (2003). Grounding conceptual knowledge in modality-specific systems. *Trends in Cognitive Sciences*, 7, 84–91.
- Bartlett, F. C. (1932). *Remembering: A study in experimental and social psychology*. Cambridge, England: Cambridge University Press.
- Bartlett, M., Rudolph, K. D., Flynn, M., Abaied, J., & Koerber, C. (2007, March). *Need for approval as a moderator of children's responses to victimization*. Paper presented at the biennial meeting of the Society for Research in Child Development, Boston.
- Barton, K. C., & Levstik, L. S. (1996). "Back when God was around and everything": Elementary children's understanding of historical time. *American Educational Research Journal*, 33, 419–454.
- Bassok, M. (1997). Two types of reliance on correlations between content and structure in reasoning about word problems. In L. D. English (Ed.), *Mathematical reasoning: Analogies, metaphors, and images* (pp. 221–246). Mahwah, NJ: Erlbaum.
- Bassok, M. (2003). Analogical transfer in problem solving. In J. E. Davidson & R. J. Sternberg (Eds.), *The psychology of problem solving* (pp. 343–369). Cambridge, England: Cambridge University Press.
- Bassok, M., & Holyoak, K. J. (1993). Pragmatic knowledge and conceptual structure: Determinants of transfer between quantitative domains. In D. K. Detterman & R. J. Sternberg (Eds.), *Transfer on trial: Intelligence, cognition, and instruction* (pp. 68–98). Norwood, NJ: Ablex.
- Bauer, P. J. (1995). Recalling past events: From infancy to early childhood. In R. Vasta (Ed.), *Annals of child development: A research annual* (Vol. 11, pp. 25–71). London: Jessica Kingsley.
- Bauer, P. J. (2002). Long-term recall memory: Behavioral and neuro-developmental changes in the first 2 years of life. *Current Directions in Psychological Science*, 11, 137–141.

- Bauer, P. J. (2006). Event memory. In W. Damon & R. M. Lerner (Series Eds.), D. Kuhn, & R. Siegler (Vol. Eds.), *Handbook of child psychology: Vol. 2. Cognition, perception, and language* (6th ed., pp. 373–425). New York: Wiley.
- Bauer, P. J., DeBoer, T., & Lukowski, A. F. (2007). In the language of multiple memory systems: Defining and describing developments in long-term declarative memory. In L. M. Oakes & P. J. Bauer (Eds.), *Short- and long-term memory in infancy and early childhood: Taking the first steps toward remembering* (pp. 240–270). New York: Oxford University Press.
- Bauer, P. J., Wiebe, S. A., Carver, L. J., Waters, J. M., & Nelson, C. A. (2003). Developments in long-term explicit memory late in the first year of life: Behavioral and electrophysiological indices. *Psychological Science*, *14*, 629–635.
- Bäuml, K.-H., & Kuhbandner, C. (2007). Remembering can cause forgetting—But not in negative moods. *Psychological Science*, *18*, 111–115.
- Bäuml, K.-H. T., & Sameni, A. (2010). The two faces of memory retrieval. *Psychological Science*, *21*, 793–795.
- Baumrind, D., Larzelere, R. E., & Cowan, P. A. (2002). Ordinary physical punishment: Is it harmful? Comment on Gershoff (2002). *Psychological Bulletin*, *128*(4), 580–589.
- Bavelier, D., & Neville, H. J. (2002). Cross-modal plasticity: Where and how? *Nature Reviews: Neuroscience*, *3*, 443–452.
- Baxter Magolda, M. B. (2002). Epistemological reflection: The evolution of epistemological assumptions from age 18 to 30. In B. K. Hofer & P. R. Pintrich (Eds.), *Personal epistemology: The psychology of beliefs about knowledge and knowing* (pp. 89–102). Mahwah, NJ: Erlbaum.
- Baxter Magolda, M. B. (2004). Evolution of a constructivist conceptualization of epistemological reflection. *Educational Psychologist*, *39*, 31–42.
- Bear, P., Torgerson, C., & Dubois-Gerchak, K. (2010). A positive procedure to increase compliance in the general education classroom for a student with serious emotional disorders. In G. S. Goodman (Ed.), *Educational psychology reader: The art and science of how people learn* (pp. 75–87). New York: Peter Lang.
- Bebko, J. M., Burke, L., Craven, J., & Sarlo, N. (1992). The importance of motor activity in sensorimotor development: A perspective from children with physical handicaps. *Human Development*, *35*(4), 226–240.
- Beck, I. L., & McKeown, M. G. (1994). Outcomes of history instruction: Paste-up accounts. In M. Carretero & J. F. Voss (Eds.), *Cognitive and instructional processes in history and the social sciences* (pp. 237–256). Mahwah, NJ: Erlbaum.
- Beck, I. L., & McKeown, M. G. (2001). Inviting students into the pursuit of meaning. *Educational Psychology Review*, *13*, 225–241.
- Beck, S. R., Robinson, E. J., Carroll, D. J., & Apperly, I. A. (2006). Children's thinking about counterfactuals and future hypotheticals as possibilities. *Child Development*, *77*, 413–426.
- Becker, M., McElvany, N., & Kortenbruck, M. (2010). Intrinsic and extrinsic reading motivation as predictors of reading literacy: A longitudinal study. *Journal of Educational Psychology*, *102*, 773–785.
- Bédard, J., & Chi, M. T. H. (1992). Expertise. *Current Directions in Psychological Science*, *1*, 135–139.
- Beeman, M. J., & Chiarello, C. (1998). Complementary right- and left-hemisphere language comprehension. *Current Directions in Psychological Science*, *7*, 2–8.
- Behr, M., & Harel, G. (1988, April). Cognitive conflict in procedure applications. In D. Tirosh (Chair), *The role of inconsistent ideas in learning mathematics*. Symposium conducted at the annual meeting of the American Educational Research Association, New Orleans, LA.
- Behrmann, M. (2000). The mind's eye mapped onto the brain's matter. *Current Directions in Psychological Science*, *9*, 50–54.
- Beilock, S. L. (2008). Math performance in stressful situations. *Current Directions in Psychological Science*, *17*, 339–343.
- Beilock, S. L., & Carr, T. H. (2001). On the fragility of skilled performance: What governs choking under pressure? *Journal of Experimental Psychology: General*, *130*, 701–725.
- Beilock, S. L., & Carr, T. H. (2003). From novice to expert performance: Memory, attention, and the control of complex sensorimotor skills. In A. M. Williams, N. J. Hodges, M. A. Scott, & M. L. J. Court (Eds.), *Skill acquisition in sport: Research, theory, and practice* (pp. 309–327). New York: Routledge.
- Beilock, S. L., & Carr, T. H. (2005). When high-powered people fail: Working memory and “choking under pressure” in math. *Psychological Science*, *16*, 101–105.
- Beilock, S. L., Kulp, C. A., Holt, L. E., & Carr, T. H. (2004). More on the fragility of performance: Choking under pressure in mathematical problem solving. *Journal of Experimental Psychology: General*, *133*, 584–600.
- Bekker, M. J., Cumming, T. D., Osborne, N. K. P., Bruining, A. M., McClean, J. L., & Leland, L. S., Jr. (2010). Encouraging electricity savings in a university residential hall through a combination of feedback, visual prompts, and incentives. *Journal of Applied Behavior Analysis*, *43*, 327–331.
- Belenky, M., Clinchy, B., Goldberger, N. R., & Tarule, J. (1997). *Women's ways of knowing: The development of self, mind, and voice*. New York: Basic Books. (Originally published 1986)
- Belfiore, P. J., & Hornyak, R. S. (1998). Operant theory and application to self-monitoring in adolescents. In D. H. Schunk and B. J. Zimmerman (Eds.), *Self-regulated learning: From teaching to self-reflective practice* (pp. 184–202). New York: Guilford Press.
- Belfiore, P. J., Lee, D. L., Vargas, A. U., & Skinner, C. H. (1997). Effects of high-preference single-digit mathematics problem completion on multiple-digit mathematics problem performance. *Journal of Applied Behavior Analysis*, *30*, 327–330.
- Bell, M. A., Wolfe, C. D., & Adkins, D. R. (2007). Frontal lobe development during infancy and childhood: Contributions of brain electrical activity, temperament, and language to individual differences in working memory and inhibitory control. In D. Coch, K. W. Fischer, & G. Dawson (Eds.), *Human behavior, learning, and the developing brain: Typical development* (pp. 247–276). New York: Guilford Press.
- Bell, N., Grossen, M., & Perret-Clermont, A. (1985). Sociocognitive conflict and intellectual growth. In M. W. Berkowitz (Ed.), *Peer conflict and psychological growth* (pp. 41–54). San Francisco: Jossey-Bass.
- Bell, P., & Linn, M. C. (2002). Beliefs about science: How does science instruction contribute? In B. K. Hofer & P. R. Pintrich (Eds.), *Personal epistemology: The psychology of beliefs about knowledge and knowing* (pp. 321–346). Mahwah, NJ: Erlbaum.
- Bellezza, F. S. (1986). Mental cues and verbal reports in learning. In G. H. Bower (Ed.), *The psychology of learning and motivation: Advances in research and theory* (Vol. 20, pp. 237–273). Orlando, FL: Academic Press.
- Bem, S. L. (1987). Gender schema theory and its implications for child development: Raising gender-aschematic children in a gender-schematic society. In P. Shaver & C. Hendrick (Eds.), *Sex and gender* (pp. 251–271). Thousand Oaks, CA: Sage.
- Bembenutty, H., & Karabenick, S. A. (2004). Inherent association between academic delay of gratification, future time perspective, and self-regulated learning. *Educational Psychology Review*, *16*, 35–57.
- Ben-Yehudah, G., & Fiez, J. A. (2007). Development of verbal working memory. In D. Coch, K. W. Fischer, & G. Dawson (Eds.), *Human behavior, learning, and the developing brain: Typical development* (pp. 301–328). New York: Guilford Press.
- Bendixen, L. (2002). A process model of epistemic belief change. In B. K. Hofer & P. R. Pintrich (Eds.), *Personal epistemology: The psychology of beliefs about knowledge and knowing* (pp. 191–208). Mahwah, NJ: Erlbaum.
- Bendixen, L. D., & Rule, D. C. (2004). An integrative approach to personal epistemology: A guiding model. *Educational Psychologist*, *39*, 69–80.
- Benes, F. M. (2007). Corticolimbic circuitry and psychopathology: Development of the corticolimbic system. In D. Coch, G. Dawson, & K. W. Fischer (Eds.), *Human behavior, learning, and the developing brain: Atypical development* (pp. 331–361). New York: Guilford Press.
- Benner, A. D., & Graham, S. (2009). The transition to high school as a developmental process among multiethnic urban youth. *Child Development*, *80*, 356–376.
- Bennett, R. E., Gottesman, R. L., Rock, D. A., & Cerullo, F. (1993). Influence of behavior perceptions and gender on teachers' judgments of students' academic skill. *Journal of Educational Psychology*, *85*, 347–356.
- Benton, D. (2008). Nutrition and intellectual development. In P. C. Kyllonen, R. D. Roberts, & L. Stankov (Eds.), *Extending intelligence: Enhancement and new constructs* (pp. 373–394). New York: Erlbaum/Taylor & Francis.
- Benton, S. L. (1997). Psychological foundations of elementary writing instruction. In

- G. D. Pyle (Ed.), *Handbook of academic learning: Construction of knowledge* (pp. 236–264). San Diego, CA: Academic Press.
- Benton, S. L., Kiewra, K. A., Whitfill, J. M., & Dennison, R. (1993). Encoding and external-storage effects on writing processes. *Journal of Educational Psychology, 85*, 267–280.
- Benware, C., & Deci, E. L. (1984). Quality of learning with an active versus passive motivational set. *American Educational Research Journal, 21*, 755–765.
- Berardi-Coletta, B., Buyer, L. S., Dominowski, R. L., & Rellinger, E. A. (1995). Metacognition and problem solving: A process-oriented approach. *Journal of Experimental Psychology: Learning, Memory, and Cognition, 21*, 205–223.
- Bereiter, C. (1994). Implications of postmodernism for science, or, science as progressive discourse. *Educational Psychologist, 29*(1), 3–12.
- Bereiter, C. (1997). Situated cognition and how to overcome it. In D. Kirshner & J. A. Whitson (Eds.), *Situated cognition: Social, semiotic, and psychological perspectives* (pp. 281–300). Mahwah, NJ: Erlbaum.
- Bereiter, C., & Scardamalia, M. (1989). Intentional learning as a goal of instruction. In L. B. Resnick (Ed.), *Knowing, learning and instruction: Essays in honour of Robert Glaser* (pp. 361–392). Mahwah, NJ: Erlbaum.
- Bereiter, C., & Scardamalia, M. (1996). Rethinking learning. In D. R. Olson & N. Torrance (Eds.), *The handbook of education and human development: New models of learning, teaching, and schooling* (pp. 485–513). Cambridge, MA: Blackwell.
- Bereiter, C., & Scardamalia, M. (2006). Education for the Knowledge Age: Design-centered models of teaching and instruction. In P. A. Alexander & P. H. Winne (Eds.), *Handbook of educational psychology* (2nd ed., pp. 695–713). Mahwah, NJ: Erlbaum.
- Berg, C. A., & Calderone, K. S. (1994). The role of problem interpretations in understanding the development of everyday problem solving. In R. J. Sternberg & R. K. Wagner (Eds.), *Mind in context: Interactionist perspectives on human intelligence* (pp. 105–132). Cambridge, England: Cambridge University Press.
- Berger, R. (2003). *An ethic of excellence: Building a culture of craftsmanship with students*. Portsmouth, NH: Heinemann.
- Bergman, E. T., & Roediger, H. L., III (1999). Can Bartlett's repeated reproduction experiments be replicated? *Memory & Cognition, 27*, 937–947.
- Berk, L. E. (1994). Why children talk to themselves. *Scientific American, 271*, 78–83.
- Berkeley, S., Mastropieri, M., & Scruggs, T. (2008, March). *Reading comprehension strategy instruction and attribution retraining for secondary students with disabilities*. Paper presented at the annual meeting of the American Educational Research Association, New York.
- Berkowitz, L. (1989). Frustration-aggression hypothesis: Examination and reformulation. *Psychological Bulletin, 106*, 59–73.
- Berkowitz, L., & LePage, A. (1967). Weapons as aggression-eliciting stimuli. *Journal of Personality and Social Psychology, 7*, 202–207.
- Berliner, D. C. (1989). The place of process-product research in developing the agenda for research on teacher thinking. *Educational Psychologist, 24*, 325–344.
- Berlyne, D. E. (1960). *Conflict, arousal, and curiosity*. New York: McGraw-Hill.
- Berndt, T. J., & Keefe, K. (1996). Friends' influence on school adjustment: A motivational analysis. In J. Juvonen & K. R. Wentzel (Eds.), *Social motivation: Understanding children's school adjustment* (pp. 248–278). Cambridge, England: Cambridge University Press.
- Berninger, V. W., Fuller, F., & Whitaker, D. (1996). A process model of writing development across the life span. *Educational Psychology Review, 8*, 193–218.
- Bernstein, D. M., & Loftus, E. F. (2009). The consequences of false memories for food preferences and choices. *Perspectives on Psychological Science, 4*, 135–139.
- Bernstein, J. H., & Waber, D. P. (2007). Executive capacities from a developmental perspective. In L. Meltzer (Ed.), *Executive function in education: From theory to practice* (pp. 39–54). New York: Guilford Press.
- Berntsen, D. (2010). The unbidden past: Involuntary autobiographical memories as a basic mode of remembering. *Current Directions in Psychological Science, 19*, 138–142.
- Bersh, P. J. (1951). The influence of two variables upon the establishment of a secondary reinforcer for operant responses. *Journal of Experimental Psychology, 41*, 62–73.
- Berthold, K., & Renkl, A. (2009). Instructional aids to support a conceptual understanding of multiple representations. *Journal of Educational Psychology, 101*, 70–87.
- Berti, A. E. (1994). Children's understanding of the concept of the state. In M. Carretero & J. F. Voss (Eds.), *Cognitive and instructional processes in history and the social sciences* (pp. 49–75). Mahwah, NJ: Erlbaum.
- Besner, D. (1999). Basic processes in reading: Multiple routines in localist and connectionist models. In R. M. Klein & P. A. McMullen (Eds.), *Converging methods for understanding reading and dyslexia* (pp. 413–458). Cambridge, MA: MIT Press.
- Best, R. M., Dockrell, J. E., & Braisby, N. (2006). Lexical acquisition in elementary science classes. *Journal of Educational Psychology, 98*, 824–838.
- Beyer, B. K. (1985). Critical thinking: What is it? *Social Education, 49*, 270–276.
- Bialystok, E. (1994a). Representation and ways of knowing: Three issues in second language acquisition. In N. C. Ellis (Ed.), *Implicit and explicit learning of languages* (pp. 549–569). London: Academic Press.
- Bialystok, E. (1994b). Towards an explanation of second language acquisition. In G. Brown, K. Malmkjær, A. Pollitt, & J. Williams (Eds.), *Language and understanding* (pp. 115–138). Oxford, England: Oxford University Press.
- Bielaczyc, K., & Collins, A. (1999). Learning communities in classrooms: A reconceptualization of educational practice. In C. M. Reigeluth (Ed.), *Instructional-design theories and models: A new paradigm of instructional theory* (pp. 269–292). Mahwah, NJ: Erlbaum.
- Bielaczyc, K., & Collins, A. (2006). Fostering knowledge-creating communities. In A. M. O'Donnell, C. E. Hmelo-Silver, & G. Erkens (Eds.), *Collaborative learning, reasoning, and technology* (pp. 37–60). Mahwah, NJ: Erlbaum.
- Biemiller, A., Shany, M., Inglis, A., & Meichenbaum, D. (1998). Factors influencing children's acquisition and demonstration of self-regulation on academic tasks. In D. H. Schunk & B. J. Zimmerman (Eds.), *Self-regulated learning: From teaching to self-reflective practice* (pp. 203–224). New York: Guilford Press.
- Bilalic, M., McLeod, P., & Gobet, F. (2010). The mechanism of the Einstellung (set) effect: A pervasive source of cognitive bias. *Current Directions in Psychological Science, 19*, 111–115.
- Bilodeau, I. M., & Schlosberg, H. (1951). Similarity in stimulating conditions as a variable in retroactive inhibition. *Journal of Experimental Psychology, 41*, 199–204.
- Binder, L. M., Dixon, M. R., & Ghezzi, P. M. (2000). A procedure to teach self-control to children with attention deficit hyperactivity disorder. *Journal of Applied Behavior Analysis, 33*, 233–237.
- Birch, H. G., & Rabinowitz, H. S. (1951). The negative effect of previous experience on productive thinking. *Journal of Experimental Psychology, 41*, 121–125.
- Birdsong, D. (2006). Age and second language acquisition and processing: A selective overview. *Language Learning, 56*, 9–49.
- Birnbaum, J. C. (1982). The reading and composing behaviors of selected fourth- and seventh-grade students. *Research in the Teaching of English, 16*, 241–260.
- Bivens, J. A., & Berk, L. E. (1990). A longitudinal study of the development of elementary school children's private speech. *Merrill-Palmer Quarterly, 36*, 443–463.
- Bjork, R. A. (1972). Theoretical implications of directed forgetting. In A. W. Melton & E. Martin (Eds.), *Coding processes in human memory* (pp. 217–235). Washington, DC: V. H. Winston.
- Bjorklund, D. F. (1987). How age changes in knowledge base contribute to the development of children's memory: An interpretive review. *Developmental Review, 7*, 93–130.
- Bjorklund, D. F. (1997). In search of a metatheory for cognitive development (or, Piaget is dead and I don't feel so good myself). *Child Development, 68*, 144–148.
- Bjorklund, D. F., & Coyle, T. R. (1995). Utilization deficiencies in the development of memory strategies. In F. E. Weinert & W. Schneider (Eds.), *Research on memory development: State of the art and future directions* (pp. 161–180). Hillsdale, NJ: Erlbaum.
- Bjorklund, D. F., & Green, B. L. (1992). The adaptive nature of cognitive immaturity. *American Psychologist, 47*, 46–54.
- Blackwell, L. S., Tzszewski, K. H., & Dweck, C. S. (2007). Implicit theories of intelligence predict achievement across an adolescent

- transition: A longitudinal study and an intervention. *Child Development*, 78, 246–263.
- Blanchard, F. A., Lilly, T., & Vaughn, L. A. (1991). Reducing the expression of racial prejudice. *Psychological Science*, 2, 101–105.
- Blanchette, I., & Richards, A. (2004). Reasoning about emotional and neutral materials: Is logic affected by emotion? *Psychological Science*, 15, 745–752.
- Blaser, E., & Kaldy, Z. (2010). Infants get five stars on iconic memory tests: A partial-report test of 6-month-old infants' iconic memory capacity. *Psychological Science*, 21, 1643–1645.
- Blatt, S. J. (1995). The destructiveness of perfectionism: Implication for treatment of depression. *American Psychologist*, 50, 1103–1020.
- Blazevski, J. L., McEvoy, A. P., & Pintrich, P. R. (2003, April). *The relation of achievement goals to cognitive regulation, persistence, and achievement*. Paper presented at the annual meeting of the American Educational Research Association, Chicago.
- Block, J. H. (1980). Promoting excellence through mastery learning. *Theory into Practice*, 19(1), 66–74.
- Blok, H., Oostdam, R., Otter, M. E., & Overmaat, M. (2002). Computer-assisted instruction in support of beginning reading instruction: A review. *Review of Educational Research*, 72, 101–103.
- Bloom, B. S. (1981). *All our children learning*. New York: McGraw-Hill.
- Bloom, B. S., Englehart, M. B., Furst, E. J., Hill, W. H., & Krathwohl, D. R. (1956). *Taxonomy of educational objectives. The classification of educational goals. Handbook I: Cognitive domain*. New York: Longmans Green.
- Bloom, L., & Tinker, E. (2001). The intentionality model and language acquisition. *Monographs of the Society for Research in Child Development*, 66(4, Serial No. 267).
- Blumenfeld, P. C. (1992). The task and the teacher: Enhancing student thoughtfulness in science. In J. Brophy (Ed.), *Advances in research on teaching: Vol. 3. Planning and managing learning tasks and activities* (pp. 81–114). Greenwich, CT: JAI Press.
- Blumenfeld, P. C., Marx, R. W., Soloway, E., & Krajcik, J. (1996). Learning with peers: From small group cooperation to collaborative communities. *Educational Researcher*, 25(8), 37–40.
- Bodrova, E., & Leong, D. J. (1996). *Tools of the mind: The Vygotskian approach to early childhood education*. Upper Saddle River, NJ: Merrill/Prentice Hall.
- Boekaerts, M., de Koning, E., & Vedder, P. (2006). Goal-directed behavior and contextual factors in the classroom: An innovative approach to the study of multiple goals. *Educational Psychologist*, 41, 33–51.
- Boggiano, A. K., Main, D. S., & Katz, P. A. (1988). Children's preference for challenge: The role of perceived competence and control. *Journal of Personality and Social Psychology*, 54, 134–141.
- Boggiano, A. K., & Pittman, T. S. (Eds.) (1992). *Achievement and motivation: A social-developmental perspective*. Cambridge, England: Cambridge University Press.
- Boiler, K. (1997). Preexposure effects on infant learning and memory. *Developmental Psychobiology*, 31, 93–105.
- Bong, M. (2009). Age-related differences in achievement goal differentiation. *Journal of Educational Psychology*, 101, 879–896.
- Bong, M., & Clark, R. E. (1999). Comparison between self-concept and self-efficacy in academic motivation research. *Educational Psychologist*, 34, 139–153.
- Bong, M., & Skaalvik, E. M. (2003). Academic self-concept and self-efficacy: How different are they really? *Educational Psychology Review*, 15, 1–40.
- Booth, J. R. (2007). Brain bases of learning and development of language and reading. In D. Coch, K. W. Fischer, & G. Dawson (Eds.), *Human behavior, learning, and the developing brain: Typical development* (pp. 279–300). New York: Guilford Press.
- Borkowski, J. G., & Burke, J. E. (1996). Theories, models, and measurements of executive functioning. In G. R. Lyon & N. A. Krasnegor (Eds.), *Attention, memory, and executive function* (pp. 235–261). Baltimore: Paul H. Brookes.
- Born, D. G., & Davis, M. L. (1974). Amount and distribution of study in a personalized instruction course and in a lecture course. *Journal of Applied Behavior Analysis*, 7, 365–375.
- Bortfeld, H., & Whitehurst, G. J. (2001). Sensitive periods in first language acquisition. In D. B. Bailey, Jr., J. T. Bruer, F. J. Symons, & J. W. Lichtman (Eds.), *Critical thinking about critical periods* (pp. 173–192). Baltimore: Paul H. Brookes.
- Bouchey, H. A., & Harter, S. (2005). Reflected appraisals, academic self-perceptions, and math/science performance during early adolescence. *Journal of Educational Psychology*, 97, 673–686.
- Bourbeau, P. E., Sowers, J., & Close, D. E. (1986). An experimental analysis of generalization of banking skills from classroom to bank settings in the community. *Education and Training of the Mentally Retarded*, 21, 98–107.
- Bourne, L. E., Jr. (1982). Typicality effects in logically defined concepts. *Memory and Cognition*, 10, 3–9.
- Bourne, L. E., Jr., Dominowski, R. L., Loftus, E. F., & Healy, A. F. (1986). *Cognitive processes* (2nd ed.). Englewood Cliffs, NJ: Prentice Hall.
- Bourne, L. E., Jr., Ekstrand, D. R., & Dominowski, R. L. (1971). *The psychology of thinking*. Englewood Cliffs, NJ: Prentice Hall.
- Bousfield, W. A. (1953). The occurrence of clustering in the recall of randomly arranged associates. *Journal of General Psychology*, 49, 229–240.
- Bouton, M. E. (1994). Context, ambiguity, and classical conditioning. *Current Directions in Psychological Science*, 3, 49–53.
- Bower, G. H. (1972). Mental imagery and associative learning. In L. W. Gregg (Ed.), *Cognition in learning and memory* (pp. 51–88). New York: Wiley.
- Bower, G. H. (1994). Some relations between emotions and memory. In P. Ekman & R. J. Davidson (Eds.), *The nature of emotion: Fundamental questions* (pp. 303–305). New York: Oxford University Press.
- Bower, G. H. (2008). The evolution of a cognitive psychologist: A journey from simple behaviors to complex mental acts. *Annual Review of Psychology*, 59, 1–27.
- Bower, G. H., Black, J. B., & Turner, T. J. (1979). Scripts in memory for text. *Cognitive Psychology*, 11, 177–220.
- Bower, G. H., & Clark, M. C. (1969). Narrative stories as mediators for serial learning. *Psychonomic Science*, 14, 181–182.
- Bower, G. H., Clark, M. C., Lesgold, A. M., & Winzenz, D. (1969). Hierarchical retrieval schemes in recall of categorized word lists. *Journal of Verbal Learning and Verbal Behavior*, 8, 323–343.
- Bower, G. H., & Forgas, J. P. (2001). Mood and social memory. In J. P. Forgas (Ed.), *Handbook of affect and social cognition* (pp. 95–120). Mahwah, NJ: Erlbaum.
- Bower, G. H., & Hilgard, E. R. (1981). *Theories of learning* (5th ed.). Englewood Cliffs, NJ: Prentice Hall.
- Bower, G. H., Karlin, M. B., & Dueck, A. (1975). Comprehension and memory for pictures. *Memory and Cognition*, 3, 216–220.
- Bower, G. H., McLean, J., & Meachem, J. (1966). Value of knowing when reinforcement is due. *Journal of Comparative and Physiological Psychology*, 62, 184–192.
- Bower, G. H., & Springston, F. (1970). Pauses as recoding points in letter series. *Journal of Experimental Psychology*, 83, 421–430.
- Bower, J. E., Moskowitz, J. T., & Epel, E. (2009). Is benefit finding good for your health? Pathways linking positive life changes after stress and physical health outcomes. *Current Directions in Psychological Science*, 18, 337–341.
- Bowers, F. E., Woods, D. W., Carlyon, W. D., & Friman, P. C. (2000). Using positive peer reporting to improve the social interactions and acceptance of socially isolated adolescents in residential care: A systematic replication. *Journal of Applied Behavior Analysis*, 33, 239–242.
- Bowers, J. S. (2002). Challenging the widespread assumption that connectionism and distributed representations go hand-in-hand. *Cognitive Psychology*, 45, 413–445.
- Bowers, J. S. (2009). On the biological plausibility of grandmother cells: Implications for neural network theories in psychology and neuroscience. *Psychological Review*, 116, 220–251.
- Bowman, L. G., Piazza, C. C., Fisher, W. W., Hagopian, L. P., & Kogan, J. S. (1997). Assessment of preference for varied versus constant reinforcers. *Journal of Applied Behavior Analysis*, 30, 451–458.
- Boynton, D. (2010). Behaviorism and its effect upon learning in the schools. In G. S. Goodman (Ed.), *Educational psychology reader: The art and science of how people learn* (pp. 49–65). New York: Peter Lang.
- Boyatzis, R. E. (1973). Affiliation motivation. In D. C. McClelland & R. S. Steele (Eds.), *Human motivation: A book of readings* (pp. 252–276). Morristown, NJ: General Learning Press.

- Boyer, E., Miltenberger, R. G., Batsche, C., & Fogel, V. (2009). Video modeling by experts with video feedback to enhance gymnastics skills. *Journal of Applied Behavior Analysis, 42*, 855–860.
- Braaksma, M. A. H., Rijlaarsdam, G., & van den Bergh, H. (2002). Observational learning and the effects of model-observer similarity. *Journal of Educational Psychology, 94*, 405–415.
- Bracken, B. (2009). Positive self-concepts. In R. Gilman, E. S. Huebner, & M. J. Furlong (Eds.), *Handbook of positive psychology in schools* (pp. 89–106). New York: Routledge.
- Bradshaw, C. P., Zmuda, J. H., Kellam, S. G., & Jalongo, N. S. (2009). Longitudinal impact of two universal preventive interventions in first grade on educational outcomes in high school. *Journal of Educational Psychology, 101*, 926–937.
- Brainerd, C. J. (2003). Jean Piaget, learning research, and American education. In B. J. Zimmerman & D. H. Schunk (Eds.), *Educational psychology: A century of contributions* (pp. 251–287). Mahwah, NJ: Erlbaum.
- Brainerd, C. J., & Reyna, V. F. (1992). Explaining “memory free” reasoning. *Psychological Science, 3*, 332–339.
- Brainerd, C. J., & Reyna, V. F. (1998). When things that were never experienced are easier to “remember” than things that were. *Psychological Science, 9*, 484–489.
- Brainerd, C. J., & Reyna, V. F. (2002). Fuzzy-trace theory and false memory. *Current Directions in Psychological Science, 11*, 164–169.
- Brainerd, C. J., & Reyna, V. F. (2004). Fuzzy-trace theory and memory development. *Developmental Review, 24*, 396–439.
- Brainerd, C. J., & Reyna, V. F. (2005). *The science of false memory*. Oxford, England: Oxford University Press.
- Bransford, J. D., & Franks, J. J. (1971). The abstraction of linguistic ideas. *Cognitive Psychology, 2*, 331–350.
- Bransford, J. D., Franks, J. J., Vye, N. J., & Sherwood, R. D. (1989). New approaches to instruction: Because wisdom can't be told. In S. Vosniadou & A. Ortony (Eds.), *Similarity and analogical reasoning* (pp. 470–497). Cambridge, England: Cambridge University Press.
- Bransford, J. D., & Johnson, M. K. (1972). Contextual prerequisites for understanding: Some investigations of comprehension and recall. *Journal of Verbal Learning and Verbal Behavior, 11*, 717–726.
- Bransford, J. D., & Schwartz, D. L. (1999). Rethinking transfer: A simple proposal with multiple implications. *Review of Research in Education* (Vol. 24, pp. 61–100). Washington, DC: American Educational Research Association.
- Bransford, J., Stevens, R., Schwartz, D., Meltzoff, A., Pea, R., Reschelle, J., Vye, N., Kuhl, P., Bell, P., Barron, B., Reeves, B., & Sabelli, N. (2006). Learning theories and education: Toward a decade of synergy. In P. A. Alexander & P. H. Winne (Eds.), *Handbook of educational psychology* (2nd ed., pp. 209–244). Mahwah, NJ: Erlbaum.
- Breitmeyer, B. B., & Ganz, L. (1976). Implications of sustained and transient channels for theories of visual pattern masking, saccadic suppression, and information processing. *Psychological Review, 83*, 1–36.
- Brendgen, M., Wanner, G., Vitaro, F., Bukowski, W. M., & Tremblay, R. E. (2007). Verbal abuse by the teacher during childhood and academic, behavioral, and emotional adjustment in young adulthood. *Journal of Educational Psychology, 99*, 26–38.
- Brenner, M. E., Mayer, R. E., Moseley, B., Brar, T., Durán, R., Reed, B. S., & Webb, D. (1997). Learning by understanding: The role of multiple representations in learning algebra. *American Educational Research Journal, 34*, 663–689.
- Bressler, S. L. (2002). Understanding cognition through large-scale cortical networks. *Current Directions in Psychological Science, 11*, 58–61.
- Brewer, W. F. (1992). The theoretical and empirical status of the flashbulb memory hypothesis. In E. Winograd & U. Neisser (Eds.), *Affect and accuracy in recall: Studies of “flashbulb” memories* (pp. 276–304). Cambridge, England: Cambridge University Press.
- Brewer, W. F. (2008). Naive theories of observational astronomy: Review, analysis, and theoretical implications. In S. Vosniadou (Ed.), *International handbook on conceptual change* (pp. 155–204). New York: Routledge.
- Brewer, W. F., & Treyners, J. C. (1981). Role of schemata in memory for places. *Cognitive Psychology, 13*, 207–230.
- Brickman, S., Miller, R. B., & Roedel, T. D. (1997, March). *Goal valuing and future consequences as predictors of cognitive engagement*. Paper presented at the annual meeting of the American Educational Research Association, Chicago.
- Briggs, L. J., & Reed, H. B. (1943). The curve of retention for substance material. *Journal of Experimental Psychology, 32*, 513–517.
- Britner, S. L. (2010). Science anxiety: Relationships to achievement, self-efficacy, and pedagogical factors. In J. C. Cassady (Ed.), *Anxiety in schools: The causes, consequences, and solutions for academic anxieties* (pp. 79–94). New York: Peter Lang.
- Britton, B. K., Stimson, M., Stennett, B., & Gülgöz, S. (1998). Learning from instructional text: Test of an individual differences model. *Journal of Educational Psychology, 90*, 476–491.
- Broadbent, D. E. (1958). *Perception and communication*. London: Pergamon Press.
- Broadhurst, P. L. (1959). The interaction of task difficulty and motivation: The Yerkes-Dodson law revived. *Acta Psychologica, 16*, 321–338.
- Broekkamp, H., Van Hout-Wolters, B. H. A. M., Rijlaarsdam, G., & van den Bergh, H. (2002). Importance in instructional text: Teachers' and students' perceptions of task demands. *Journal of Educational Psychology, 94*, 260–271.
- Bronfenbrenner, U. (1999). Is early intervention effective? Some studies of early education in familial and extra-familial settings. In A. Montagu (Ed.), *Race and IQ* (expanded ed., pp. 343–378). New York: Oxford University Press.
- Bronson, M. B. (2000). *Self-regulation in early childhood: Nature and nurture*. New York: Guilford Press.
- Brooke, R. R., & Ruthren, A. J. (1984). The effects of contingency contracting on student performance in a PSI class. *Teaching of Psychology, 11*, 87–89.
- Brookhart, S. M. (2004). *Grading*. Upper Saddle River, NJ: Merrill/Prentice Hall.
- Brooks, L. W., & Dansereau, D. F. (1987). Transfer of information: An instructional perspective. In S. M. Cormier & J. D. Hagman (Eds.), *Transfer of learning: Contemporary research and applications* (pp. 121–150). San Diego, CA: Academic Press.
- Brooks-Gunn, J. (2003). Do you believe in magic? What we can expect from early childhood intervention programs. *Social Policy Report, 17* (1). Ann Arbor, MI: Society for Research in Child Development.
- Brophy, J. E. (1986). *On motivating students*. Occasional Paper No. 101, Institute for Research on Teaching, Michigan State University, East Lansing.
- Brophy, J. E. (1987). Synthesis of research on strategies for motivating students to learn. *Educational Leadership, 45* (2), 40–48.
- Brophy, J. E. (1999). Toward a model of the value aspects of motivation in education: Developing appreciation for particular learning domains and activities. *Educational Psychologist, 34*, 75–85.
- Brophy, J. (2004). *Motivating students to learn* (2nd ed.). Mahwah, NJ: Erlbaum.
- Brophy, J. (2005). Goal theorists should move on from performance goals. *Educational Psychologist, 40*, 167–176.
- Brophy, J. E. (2006). Observational research on generic aspects of classroom teaching. In P. A. Alexander & P. H. Winne (Eds.), *Handbook of educational psychology* (2nd ed., pp. 755–780). Mahwah, NJ: Erlbaum.
- Brophy, J. (2008). Developing students' appreciation for what is taught in school. *Educational Psychologist, 43*, 132–141.
- Brophy, J. E., & Alleman, J. (1992). Planning and managing learning activities: Basic principles. In J. Brophy (Ed.), *Advances in research on teaching: Vol. 3. Planning and managing learning tasks and activities* (pp. 1–45). Greenwich, CT: JAI Press.
- Brophy, J., Alleman, J., & Knighton, B. (2009). *Inside the social studies classroom*. New York: Routledge.
- Brothers, K. J., Krantz, P. J., & McClannahan, L. E. (1994). Office paper recycling: A function of container proximity. *Journal of Applied Behavior Analysis, 27*, 153–160.
- Brown, A. (1991). A review of the tip-of-the-tongue experience. *Psychological Bulletin, 109*, 204–223.
- Brown, A. L., & Campione, J. C. (1994). Guided discovery in a community of learners. In K. McGilly (Ed.), *Classroom lessons: Integrating cognitive theory and classroom practice* (pp. 229–270). Cambridge, MA: MIT Press/Bradford.
- Brown, A. L., & Campione, J. C. (1996). Psychological theory and the design of innovative learning environments: On procedures, principles, and systems. In L. Schauble & R. Glaser (Eds.), *Innovations in learning: New environments for education* (pp. 289–325). Mahwah, NJ: Erlbaum.

- Brown, A. L., & Day, J. D. (1983). Macrorules for summarizing texts: The development of expertise. *Journal of Verbal Learning and Verbal Behavior*, 22, 1–14.
- Brown, A. L., Kane, M. J., & Echols, K. (1986). Young children's mental models determine analogical transfer across problems with a common goal structure. *Cognitive Development*, 1, 103–122.
- Brown, A. L., & Palincsar, A. S. (1987). Reciprocal teaching of comprehension strategies: A natural history of one program for enhancing learning. In J. Borkowski & J. D. Day (Eds.), *Cognition in special education: Comparative approaches to retardation, learning disabilities, and giftedness* (pp. 81–132). Norwood, NJ: Ablex.
- Brown, B. (1990). Peer groups. In S. Feldman & G. Elliott (Eds.), *At the threshold: The developing adolescent* (pp. 171–196). Cambridge, MA: Harvard University Press.
- Brown, B. B., Eicher, S. A., & Petrie, S. (1986). The importance of peer group ("crowd") affiliation in adolescence. *Journal of Adolescence*, 9, 73–96.
- Brown, D. E., & Hammer, D. (2008). Conceptual change in physics. In S. Vosniadou (Ed.), *International handbook on conceptual change* (pp. 127–154). New York: Routledge.
- Brown, I., & Inouye, D. K. (1978). Learned helplessness through modeling: The role of perceived similarity in competence. *Journal of Personality and Social Psychology*, 36, 900–908.
- Brown, J. (1968). Reciprocal facilitation and impairment of free recall. *Psychonomic Science*, 10, 41–42.
- Brown, J. S., Collins, A., & Duguid, P. (1989). Situated cognition and the culture of learning. *Educational Researcher*, 18 (1), 32–42.
- Brown, M. C., McNeil, N. M., & Glenberg, A. M. (2009). Using concreteness in education: Real problems, potential solutions. *Child Development Perspectives*, 3, 160–164.
- Brown, R., & Herrnstein, R. J. (1975). *Psychology*. Boston: Little, Brown.
- Brown, R., & McNeill, D. (1966). The "tip of the tongue" phenomenon. *Journal of Verbal Learning and Verbal Behavior*, 5, 325–337.
- Brown, S. I., & Walter, M. I. (1990). *The art of problem posing* (2nd ed.). Hillsdale, NJ: Erlbaum.
- Brown, W. H., Fox, J. J., & Brady, M. P. (1987). Effects of spatial density on 3- and 4-year-old children's socially directed behavior during free-play: An investigation of a setting factor. *Education and Treatment of Children*, 10, 247–258.
- Bruer, J. T. (1997). Education and the brain: A bridge too far. *Educational Researcher*, 26 (8), 4–16.
- Bruer, J. T. (1999). *The myth of the first three years: A new understanding of early brain development and lifelong learning*. New York: Free Press.
- Bruer, J. T., & Greenough, W. T. (2001). The subtle science of how experience affects the brain. In D. B. Bailey, Jr., J. T. Bruer, F. J. Symons, & J. W. Lichtman (Eds.), *Critical thinking about critical periods* (pp. 209–232). Baltimore: Paul H. Brookes.
- Bruner, J. S. (1957). On going beyond the information given. In H. Gruber, K. R. Hammond, & M. Wertheimer (Eds.), *Contemporary approaches to cognition* (pp. 41–69). Cambridge, MA: Harvard University Press.
- Bruner, J. S. (1961a). The act of discovery. *Harvard Educational Review*, 31, 21–32.
- Bruner, J. S. (1961b). *The process of education*. Cambridge, MA: Harvard University Press.
- Bruner, J. S. (1966). *Toward a theory of instruction*. New York: W. W. Norton.
- Bruner, J. S., Goodnow, J., & Austin, G. (1956). *A study of thinking*. New York: Wiley.
- Bruning, R. H., Schraw, G. J., & Ronning, R. R. (1995). *Cognitive psychology and instruction* (2nd ed.). Englewood Cliffs, NJ: Prentice Hall/Merrill.
- Bryan, J. H. (1975). Children's cooperation and helping behaviors. In E. M. Hetherington (Ed.), *Review of child development research* (Vol. 5, pp. 127–181). Chicago: University of Chicago Press.
- Buckner, R. L., & Petersen, S. E. (1996). What does neuroimaging tell us about the role of prefrontal cortex in memory retrieval? *Seminars in the Neurosciences*, 8, 47–55.
- Buehl, M. M., & Alexander, P. A. (2005). Motivation and performance differences in students' domain-specific epistemological belief profiles. *American Educational Research Journal*, 42, 697–726.
- Buehl, M. M., & Alexander, P. A. (2006). Examining the dual nature of epistemological beliefs. *International Journal of Educational Research*, 45, 28–42.
- Bufford, R. K. (1976). Evaluation of a reinforcement procedure for accelerating work rate in a self-paced course. *Journal of Applied Behavior Analysis*, 9, 208.
- Bugelski, B. R. (1962). Presentation time, total time, and mediation in paired-associate learning. *Journal of Experimental Psychology*, 63, 409–412.
- Bugelski, B. R., & Alampay, D. A. (1961). The role of frequency in developing perceptual sets. *Canadian Journal of Psychology*, 15, 205–211.
- Bugelski, B. R., Kidd, E., & Segmen, J. (1968). Image as a mediator in one-trial paired-associate learning. *Journal of Experimental Psychology*, 76, 69–73.
- Bulgren, J. A., Deshler, D. D., Schumaker, J. B., & Lenz, B. K. (2000). The use and effectiveness of analogical instruction in diverse secondary content classrooms. *Journal of Educational Psychology*, 92, 426–441.
- Bulgren, J. A., Schumaker, J. B., & Deshler, D. D. (1994). The effects of a recall enhancement routine on the test performance of secondary students with and without learning disabilities. *Learning Disabilities Research and Practice*, 9, 2–11.
- Burgess, K. B., Wojslawowicz, J. C., Rubin, K. H., Rose-Krasnor, L., & Booth-LaForce, C. (2006). Social information processing and coping strategies of shy/withdrawn and aggressive children: Does friendship matter? *Child Development*, 77, 371–383.
- Burhans, K. K., & Dweck, C. S. (1995). Helplessness in early childhood: The role of contingent worth. *Child Development*, 66, 1719–1738.
- Burnett, P. (2001). Elementary students' preferences for teacher praise. *Journal of Classroom Interaction*, 36, 16–23.
- Burnett, R. E., & Kastman, L. M. (1997). Teaching composition: Current theories and practices. In G. D. Phye (Ed.), *Handbook of academic learning: Construction of knowledge* (pp. 268–305). San Diego, CA: Academic Press.
- Burwell, R. A., & Shirik, S. R. (2009). Contingent self-worth and gender differences in adolescent depression: A commentary. *Sex Roles*, 61, 769–777.
- Buschke, H. (1977). Two-dimensional recall: Immediate identification of clusters in episodic and semantic memory. *Journal of Verbal Learning and Verbal Behavior*, 16, 201–215.
- Bussey, K., & Bandura, A. (1992). Self-regulatory mechanisms governing gender development. *Child Development*, 63, 1236–1250.
- Butcher, K. R. (2006). Learning from text with diagrams: Promoting mental model development and inference generation. *Journal of Educational Psychology*, 98, 182–197.
- Butler, A. C., & Roediger, H. L. (2007). Testing improves long-term retention in a simulated classroom setting. *European Journal of Cognitive Psychology*, 19, 514–527.
- Butler, A. C., Zaromb, F. M., Lyle, K. B., & Roediger, H. L., III (2009). Using popular films to enhance classroom learning: The good, the bad, and the interesting. *Psychological Science*, 20, 1161–1168.
- Butler, D. L., & Winne, P. H. (1995). Feedback and self-regulated learning: A theoretical synthesis. *Review of Educational Research*, 65, 245–281.
- Butler, R. (1987). Task-involving and ego-involving properties of evaluation: Effects of different feedback conditions on motivational perceptions, interest, and performance. *Journal of Educational Psychology*, 79, 474–482.
- Butler, R. (1994). Teacher communication and student interpretations: Effects of teacher responses to failing students on attributional inferences in two age groups. *British Journal of Educational Psychology*, 64, 277–294.
- Butler, R. (1998a). Age trends in the use of social and temporal comparison for self-evaluation: Examination of a novel developmental hypothesis. *Child Development*, 69, 1054–1073.
- Butler, R. (1998b). Determinants of help seeking: Relations between perceived reasons for classroom help-avoidance and help-seeking behaviors in an experimental context. *Journal of Educational Psychology*, 90, 630–644.
- Byrne, B. M. (2002). Validating the measurement and structure of self-concept: Snapshots of past, present, and future research. *American Psychologist*, 57, 897–909.
- Byrnes, J. P. (1996). *Cognitive development and learning in instructional contexts*. Boston: Allyn & Bacon.
- Byrnes, J. P. (2001). *Minds, brains, and learning: Understanding the psychological and educational*

- relevance of neuroscientific research. New York: Guilford Press.
- Byrnes, J. P. (2007). Some ways in which neuroscientific research can be relevant to education. In D. Coch, K. W. Fischer, & G. Dawson (Eds.), *Human behavior, learning, and the developing brain: Typical development* (pp. 30–49). New York: Guilford Press.
- Cacioppo, J. T., Amaral, D. G., Blanchard, J. J., Cameron, J. L., Carter, C. S., Crews, D., et al. (2007). Social neuroscience: Progress and implications for mental health. *Perspectives on Psychological Science*, 2, 99–123.
- Cacioppo, J. T., Petty, R. E., Feinstein, J. A., & Jarvis, W. B. G. (1996). Dispositional differences in cognitive motivation: The life and times of individuals varying in need for cognition. *Psychological Bulletin*, 119, 197–253.
- Cadinu, M., Maass, A., Rosabianca, A., & Kiesner, J. (2005). Why do women underperform under stereotype threat? Evidence for the role of negative thinking. *Psychological Science*, 16, 572–578.
- Cahill, L., Haier, R. J., Fallon, J., Alkire, M., Tang, C., Keator, D., Wu, J., & McGaugh, J. (1996). Amygdala activity at encoding correlated with long-term, free recall of emotional information. *Proceedings of the National Academy of Sciences*, 93, 8016–8321.
- Cahill, L., & McGaugh, J. L. (1995). A novel demonstration of enhanced memory associated with emotional arousal. *Consciousness and Cognition*, 4, 410–421.
- Cain, C. K., Blouin, A. M., & Barad, M. (2003). Temporally massed CS presentations generate more fear extinction than spaced presentations. *Journal of Experimental Psychology: Animal Behavior Processes*, 29, 323–333.
- Calfee, R. (1981). Cognitive psychology and educational practice. In D. C. Berliner (Ed.), *Review of Research in Education* (Vol. 9, pp. 3–73). Washington, DC: American Educational Research Association.
- Calfee, R., Dunlap, K., & Wat, A. (1994). Authentic discussion of texts in middle grade schooling: An analytic-narrative approach. *Journal of Reading*, 37, 546–556.
- Calfee, R. C., & Masuda, W. V. (1997). Classroom assessment as inquiry. In G. D. Phye (Ed.), *Handbook of classroom assessment: Learning, achievement, and adjustment* (pp. 71–102). San Diego, CA: Academic Press.
- Calin-Jageman, R. J., & Ratner, H. H. (2005). The role of encoding in the self-explanation effect. *Cognition and Instruction*, 23, 523–543.
- Cameron, J. (2001). Negative effects of reward on intrinsic motivation—A limited phenomenon: Comment on Deci, Koestner, and Ryan (2001). *Review of Educational Research*, 71, 29–42.
- Cameron, J., & Pierce, W. D. (1994). Reinforcement, reward, and intrinsic motivation: A meta-analysis. *Review of Educational Research*, 64, 363–423.
- Cameron, J., & Pierce, W. D. (2005). *Rewards for performance, cognitive processes, and intrinsic motivation*. Paper presented at the annual meeting of the American Educational Research Association, San Francisco, CA.
- Cameron, J., Pierce, W. D., Banko, K. M., & Gear, A. (2005). Achievement-based rewards and intrinsic motivation: A test of cognitive mediators. *Journal of Educational Psychology*, 97, 641–655.
- Cammilleri, A. P., Tiger, J. H., & Hanley, G. P. (2008). Developing stimulus control of young children's requests to teachers: Classwide applications of multiple schedules. *Journal of Applied Behavior Analysis*, 41, 299–303.
- Campanella, J., & Rovee-Collier, C. (2005). Latent learning and deferred imitation at 3 months. *Infancy*, 7, 243–262.
- Campione, J. C., Shapiro, A. M., & Brown, A. L. (1995). Forms of transfer in a community of learners: Flexible learning and understanding. In A. McKeough, J. Lupart, & A. Marini (Eds.), *Teaching for transfer: Fostering generalization in learning* (pp. 35–68). Mahwah, NJ: Erlbaum.
- Campo, P., Maest, F., Ortiz, T., Capilla, A., Fernandez, S., & Fernandez, A. (2005). Is medial temporal lobe activation specific to encoding long-term memories? *Neuroimage*, 25, 34–42.
- Cann, A., & Ross, D. (1989). Olfactory stimuli as context cues in human memory. *American Journal of Psychology*, 102, 91–102.
- Cao, L. (2010, April-May). *Those who choose to procrastinate: Achievement goal, motivation, study strategy, and test performance among college students*. Paper presented at the annual meeting of the American Educational Research Association, Denver.
- Capon, N., & Kuhn, D. (2004). What's so good about problem-based learning? *Cognition and Instruction*, 22, 61–79.
- Cardelle-Elawar, M. (1992). Effects of teaching metacognitive skills to students with low mathematics ability. *Teaching and Teacher Education*, 8, 109–121.
- Carey, R. G., & Bucher, B. D. (1986). Positive practice overcorrection: Effects of reinforcing correct performance. *Behavior Modification*, 10, 73–92.
- Carey, S. (1985). *Conceptual change in childhood*. Cambridge, MA: MIT Press.
- Carlson, N. R. (1999). *Foundations of physiological psychology*. Boston: Allyn & Bacon.
- Carlson, R., Chandler, P., & Sweller, J. (2003). Learning and understanding science instructional material. *Journal of Educational Psychology*, 95, 629–640.
- Carlson, S. M., Davis, A. C., & Leach, J. C. (2005). Less is more: Executive function and symbolic representation in preschool children. *Psychological Science*, 16, 609–616.
- Carlson, S. M., & Moses, L. J. (2001). Individual differences in inhibitory control and children's theory of mind. *Child Development*, 72, 1032–1053.
- Carmichael, C. A., & Hayes, B. K. (2001). Prior knowledge and exemplar encoding in children's concept acquisition. *Child Development*, 72, 1071–1090.
- Carmichael, L., Hogan, H. P., & Walters, A. A. (1932). An experimental study of the effect of language on the reproduction of visually perceived form. *Journal of Experimental Psychology*, 15, 73–86.
- Carnagey, N. L., Anderson, C. A., & Bartholow, B. D. (2007). Media violence and social neuroscience: New questions and new opportunities. *Current Directions in Psychological Science*, 16, 178–182.
- Carney, R. N., & Levin, J. R. (1994). Combining mnemonic strategies to remember who painted what when. *Contemporary Educational Psychology*, 19, 323–339.
- Carney, R. N., & Levin, J. R. (2000). Mnemonic instruction, with a focus on transfer. *Journal of Educational Psychology*, 92, 783–790.
- Carney, R. N., & Levin, J. R. (2002). Pictorial illustrations still improve students' learning from text. *Educational Psychology Review*, 14, 5–26.
- Carney, R. N., & Levin, J. R. (2011). Delayed mnemonic benefits for a combined pegword-keyword strategy, time after time, rhyme after rhyme. *Applied Cognitive Psychology*, 25, 204–211.
- Carney, R. N., Levin, J. R., & Stackhouse, T. L. (1997). The face-name mnemonic strategy from a different perspective. *Contemporary Educational Psychology*, 22, 399–412.
- Carpenter, M., Nagell, K., & Tomasello, M. (1998). Social cognition, joint attention, and communicative competence from 9 to 15 months of age. *Monographs of the Society for Research in Child Development*, 63 (Serial No. 255). Chicago: University of Chicago Press.
- Carpenter, P. A., & Just, M. A. (1986). Cognitive processes in reading. In J. Orasanu (Ed.), *Reading comprehension: From research to practice* (pp. 11–29). Hillsdale, NJ: Erlbaum.
- Carpenter, S. K., Pashler, H., & Cepeda, N. J. (2009). Using tests to enhance 8th grade students' retention of U.S. history facts. *Applied Cognitive Psychology*, 23, 760–771.
- Carpenter, T. P., & Moser, J. M. (1984). The acquisition of addition and subtraction concepts in grades one through three. *Journal for Research in Mathematics Education*, 15, 179–202.
- Carr, M. (2010). The importance of metacognition for conceptual change and strategy use in mathematics. In H. S. Waters & W. Schneider (Eds.), *Metacognition, strategy use, and instruction* (pp. 176–197). New York: Guilford Press.
- Carr, M., & Biddlecomb, B. (1998). Metacognition in mathematics from a constructivist perspective. In D. J. Hacker, J. Dunlosky, & A. C. Graesser (Eds.), *Metacognition in educational theory and practice* (pp. 69–91). Mahwah, NJ: Erlbaum.
- Carr, M., & Jessup, D. (1997). Gender differences in first grade mathematics strategy use: Social, metacognitive, and attributional differences. *Journal of Educational Psychology*, 89, 318–328.
- Carraher, T. N., Carraher, D. W., & Schliemann, A. D. (1985). Mathematics in the streets and in the schools. *British Journal of Developmental Psychology*, 3, 21–29.
- Carrasco, R. L. (1981). Expanded awareness of student performance: A case study in applied ethnographic monitoring in a bilingual classroom. In H. T. Trueba, G. P. Guthrie, & K. H. Au (Eds.), *Culture and the bilingual classroom*:



- Studies in classroom ethnography* (pp. 153–177). Rowley, MA: Newbury House.
- Carroll, J. B. (1989). The Carroll model: A 25-year retrospective and prospective view. *Educational Researcher*, 18(1), 26–31.
- Carroll, M., & Perfect, T. J. (2002). Students' experiences of unconscious plagiarism: Did I beget or forget? In T. J. Perfect & B. L. Schwartz (Eds.), *Applied metacognition* (pp. 146–166). Cambridge, England: Cambridge University Press.
- Carter, M., & Driscoll, C. (2007). A conceptual examination of setting events. *Educational Psychology*, 27, 655–673.
- Carter, R., Williams, S., & Silverman, W. K. (2008). Cognitive and emotional facets of test anxiety in African American school children. *Cognition and Emotion*, 22, 539–551.
- Carver, C. S., & Scheier, M. F. (1990). Origins and functions of positive and negative affect: A control-process view. *Psychological Review*, 97, 19–35.
- Carver, C. S., & Scheier, M. F. (2005). Engagement, disengagement, coping, and catastrophe. In A. Elliot & C. Dweck (Eds.), *Handbook of competence and motivation* (pp. 527–547). New York: Guilford Press.
- Carver, R. P. (1971). *Sense and nonsense in speed reading*. Silver Springs, MD: Revrac.
- Carver, R. P. (1990). *Reading rate: A review of research and theory*. San Diego, CA: Academic Press.
- Case, R. (1985). *Intellectual development: Birth to adulthood*. Orlando, FL: Academic Press.
- Case, R. (1991). *The mind's staircase: Exploring the conceptual underpinnings of children's thought and knowledge*. Hillsdale, NJ: Erlbaum.
- Case, R., & Mueller, M. P. (2001). Differentiation, integration, and covariance mapping as fundamental processes in cognitive and neurological growth. In J. L. McClelland & R. S. Siegler (Eds.), *Mechanisms of cognitive development: Behavioral and neural perspectives* (pp. 185–219). Mahwah, NJ: Erlbaum.
- Case, R., & Okamoto, Y., in collaboration with Griffin, S., McKeough, A., Bleiker, C., Henderson, B., & Stephenson, K. M. (1996). The role of central conceptual structures in the development of children's thought. *Monographs of the Society for Research in Child Development*, 61(1–2, Serial No. 246).
- Case, R., Okamoto, Y., Henderson, B., & McKeough, A. (1993). Individual variability and consistency in cognitive development: New evidence for the existence of central conceptual structures. In R. Case & W. Edelman (Eds.), *The new structuralism in cognitive development: Theory and research on individual pathways*. Basel, Switzerland: Karger.
- Cassady, J. C. (Ed.) (2010a). *Anxiety in schools: The causes, consequences, and solutions for academic anxieties*. New York: Peter Lang.
- Cassady, J. C. (2010b). Test anxiety: Contemporary theories and implications for learning. In J. C. Cassady (Ed.), *Anxiety in schools: The causes, consequences, and solutions for academic anxieties* (pp. 7–26). New York: Peter Lang.
- Cassady, J. C., & Johnson, R. E. (2002). Cognitive test anxiety and academic performance. *Contemporary Educational Psychology*, 27, 270–295.
- Castagno, A. E., & Brayboy, B. M. J. (2008). Culturally responsive schooling for Indigenous youth: A review of the literature. *Review of Educational Research*, 78, 941–993.
- Castro-Caldas, A., Miranda, P. C., Carmo, I., Reis, A., Leote, F., Ribeiro, C., & Ducla-Soares, E. (1999). Influence of learning to read and write on the morphology of the corpus callosum. *European Journal of Neurology*, 6, 23–28.
- Catania, A. C., & Reynolds, G. S. (1968). A quantitative analysis of the responding maintained by interval schedules of reinforcement. *Journal of the Experimental Analysis of Behavior*, 11, 327–383.
- Catsambis, S. (2005). The gender gap in mathematics: Merely a step function? In A. M. Gallagher & J. C. Kaufman (Eds.), *Gender differences in mathematics: An integrative psychological approach* (pp. 220–245). Cambridge, England: Cambridge University Press.
- Cazden, C. B. (2001). *Classroom discourse: The language of teaching and learning* (2nd ed.). Portsmouth, NH: Heinemann.
- Cepeda, N. J., Vul, E., Rohrer, D., Wixted, J. T., & Pashler, H. (2008). Spacing effects in learning: A temporal ridge of optimal retention. *Psychological Science*, 19, 1095–1102.
- Cermak, L. S. (1993). Automatic versus controlled processing and the implicit task performance of amnesic patients. In P. Graf & M. E. J. Masson (Eds.), *Implicit memory: New directions in cognition, development, and neuropsychology* (pp. 287–301). Hillsdale, NJ: Erlbaum.
- Cermak, L. S., & Craik, F. I. M. (Eds.) (1979). *Levels of processing in human memory*. Hillsdale, NJ: Erlbaum.
- Certo, J. L., Cauley, K. M., & Chafin, C. (2003). Students' perspectives on their high school experience. *Adolescence*, 38, 705–724.
- Chabran, M. (2003). Listening to talk from and about students on accountability. In M. Carnoy, R. Elmore, & L. S. Siskin (Eds.), *The new accountability: High schools and high-stakes testing* (pp. 129–145). New York: Routledge Falmer.
- Chalmers, D. J. (1996). *The conscious mind: In search of a fundamental theory*. New York: Oxford University Press.
- Chambers, D., & Reisberg, D. (1985). Can mental images be ambiguous? *Journal of Experimental Psychology: Human Perception and Performance*, 11, 317–328.
- Chambliss, M. J. (1994). Why do readers fail to change their beliefs after reading persuasive text? In R. Garner & P. A. Alexander (Eds.), *Beliefs about text and instruction with text* (pp. 76–89). Hillsdale, NJ: Erlbaum.
- Chambliss, M. J., Calfee, R. C., & Wong, I. (1990, April). *Structure and content in science textbooks: Where is the design?* Paper presented at the annual meeting of the American Educational Research Association, Boston.
- Chambliss, M. J., & Garner, R. (1996). Do adults change their minds after reading persuasive text? *Written Communication*, 13, 291–313.
- Champagne, A. B., & Bunce, D. M. (1991). Learning-theory-based science teaching. In S. M. Glynn, R. H. Yeany, & B. K. Britton (Eds.), *The psychology of learning science* (pp. 21–41). Hillsdale, NJ: Erlbaum.
- Champagne, A. B., Klopfer, L. E., & Gunstone, R. F. (1982). Cognitive research and the design of science instruction. *Educational Psychologist*, 17, 31–53.
- Chan, C., Burtis, J., & Bereiter, C. (1997). Knowledge building as a mediator of conflict in conceptual change. *Cognition and Instruction*, 15, 1–40.
- Chan, C. K. K., Burtis, P. J., Scardamalia, M., & Bereiter, C. (1992). Constructive activity in learning from text. *American Educational Research Journal*, 29, 97–118.
- Chan, J. C. K., Thomas, A. K., & Bulevich, J. B. (2009). Recalling a witnessed event increases eyewitness suggestibility: The reversed testing effect. *Psychological Science*, 20, 66–73.
- Chang, M.-L., & Davis, H. A. (2009). Understanding the role of teacher appraisals in shaping the dynamics of their relationships with students: Deconstructing teachers' judgments of disruptive behavior/students. In P. Schutz & M. Zembylas (Eds.), *Advances in teacher emotion research: The impact of teachers' lives* (pp. 95–125). New York: Springer.
- Chapell, M. S., Blanding, Z. B., Silverstein, M. E., Takahashi, M., Newman, B., Gubi, A., & McCann, N. (2005). Test anxiety and academic performance in undergraduate and graduate students. *Journal of Educational Psychology*, 97, 268–274.
- Chapman, M. (1988). *Constructive evolution: Origins and development of Piaget's thought*. Cambridge, England: Cambridge University Press.
- Charness, N., Tuffiash, M., & Jastrzemski, T. (2004). Motivation, emotion, and expert skill acquisition. In D. Y. Dai & R. J. Sternberg (Eds.), *Motivation, emotion, and cognition: Integrative perspectives on intellectual functioning and development* (pp. 299–319). Mahwah, NJ: Erlbaum.
- Chen, J., & Morris, D. (2008, March). *Sources of science self-efficacy beliefs among high school students in different tracking levels*. Paper presented at the annual meeting of the American Educational Research Association, New York.
- Chen, J. A., & Pajares, F. (2010). Implicit theories of ability of Grade 6 science students: Relation to epistemological beliefs and academic motivation and achievement in science. *Contemporary Educational Psychology*, 35, 75–87.
- Chen, L. H., Wu, C.-H., Kee, Y. H., Linn, M.-S., & Shui, S.-H. (2009). Fear of failure, 2 x 2 achievement goal and self-handicapping: An examination of the hierarchical model of achievement motivation in physical education. *Contemporary Educational Psychology*, 34, 298–305.
- Chen, Z. (1999). Schema induction in children's analogical problem solving. *Journal of Educational Psychology*, 91, 703–715.
- Chen, Z., Sanchez, R. P., & Campbell, T. (1997). From beyond to within their grasp: The rudiments of analogical problem solving in 10- and 13-month-olds. *Developmental Psychology*, 33, 790–801.

- Cheng, P. W. (1985). Restructuring versus automaticity: Alternative accounts of skill acquisition. *Psychological Review*, 92, 414–423.
- Cherry, E. C. (1953). Some experiments on the recognition of speech, with one and with two ears. *Journal of the Acoustical Society of America*, 25, 975–979.
- Cheyne, J. A., & Walters, R. H. (1970). Punishment and prohibition: Some origins of self-control. In T. M. Newcomb (Ed.), *New directions in psychology* (Vol. 4, pp. 281–366). New York: Holt, Rinehart & Winston.
- Chi, M. T. H. (1978). Knowledge structures and memory development. In R. S. Siegler (Ed.), *Children's thinking: What develops?* (pp. 73–96). Hillsdale, NJ: Erlbaum.
- Chi, M. T. H. (2008). Three types of conceptual change: Belief revision, mental model transformation, and categorical shift. In S. Vosniadou (Ed.), *International handbook on conceptual change* (pp. 61–82). New York: Routledge.
- Chi, M. T. H., & Glaser, R. (1985). Problem-solving ability. In R. J. Sternberg (Ed.), *Human abilities: An information-processing approach* (pp. 227–257). New York: Freeman.
- Chi, M. T. H., Glaser, R., & Farr, M. J. (Eds.) (1988). *The nature of expertise*. Hillsdale, NJ: Erlbaum.
- Chinn, C. A. (1998). A critique of social constructivist explanations of knowledge change. In B. Guzzetti & C. Hynd (Eds.), *Perspectives on conceptual change: Multiple ways to understand knowing and learning in a complex world* (pp. 77–115). Mahwah, NJ: Erlbaum.
- Chinn, C. A. (2006). Learning to argue. In A. M. O'Donnell, C. E. Hemelo-Silver, & G. Erkens (Eds.), *Collaborative learning, reasoning, and technology* (pp. 355–383). Mahwah, NJ: Erlbaum.
- Chinn, C. A., Anderson, R. C., & Waggoner, M. A. (2001). Patterns of discourse in two kinds of literature discussion. *Reading Research Quarterly*, 36, 378–411.
- Chinn, C. A., & Brewer, W. F. (1993). The role of anomalous data in knowledge acquisition: A theoretical framework and implications for science instruction. *Review of Educational Research*, 63, 1–49.
- Chinn, C. A., & Malhotra, B. A. (2002). Children's responses to anomalous scientific data: How is conceptual change impeded? *Journal of Educational Psychology*, 94, 327–343.
- Chipman, S. F., Krantz, D. H., & Silver, R. (1992). Mathematics anxiety and science careers among able college women. *Psychological Science*, 3, 292–295.
- Chiu, C.-Y., Leung, A. K.-Y., & Kwan, L. (2007). Language, cognition, and culture: Beyond the Whorfian hypothesis. In S. Kitayama & D. Cohen (Eds.), *Handbook of cultural psychology* (pp. 668–688). New York: Guilford Press.
- Chomsky, N. (1957). *Syntactic structures*. The Hague: Mouton.
- Chomsky, N. (2006). *Language and mind* (3rd ed.). Cambridge, England: Cambridge University Press.
- Chouinard, M. M. (2007). Children's questions: A mechanism for cognitive development. *Monographs of the Society for Research in Child Development*, 72 (1, Serial No. 286).
- Christie, J. F., & Johnsen, E. P. (1983). The role of play in social-intellectual development. *Review of Educational Research*, 53, 93–115.
- Church, M. A., Elliot, A. J., & Gable, S. L. (2001). Perceptions of classroom environment, achievement goals, and achievement outcomes. *Journal of Educational Psychology*, 93, 43–54.
- Church, R. M. (1993). Human models of animal behavior. *Psychological Science*, 4, 170–173.
- Ciani, K. D., Easter, M. A., Summers, J. J., & Posada, M. L. (2009). Cognitive biases in the interpretation of autonomic arousal: A test of the construal bias hypothesis. *Contemporary Educational Psychology*, 34, 9–17.
- Cimpian, A., Arce, H.-M. C., Markman, E. M., & Dweck, C. S. (2007). Subtle linguistic cues affect children's motivation. *Psychological Science*, 18, 314–316.
- Cizek, G. J. (2003). *Detecting and preventing classroom cheating: Promoting integrity in assessment*. Thousand Oaks, CA: Corwin.
- Clancey, W. J. (1997). *Situated cognition: On human knowledge and computer representations*. Cambridge, England: Cambridge University Press.
- Clancey, W. J. (2009). Scientific antecedents of situated cognition. In P. Robbins & M. Aydede (Eds.), *The Cambridge handbook of situated cognition* (pp. 11–34). Cambridge, England: Cambridge University Press.
- Clani, K. D., Middleton, M. J., Summers, J. J., & Sheldon, K. M. (2010). Buffering against performance classroom goal structures: The importance of autonomy support and classroom community. *Contemporary Educational Psychology*, 35, 88–99.
- Clark, A.-M., Anderson, R. C., Kuo, L., Kim, I., Archodidou, A., & Nguyen-Jahiel, K. (2003). Collaborative reasoning: Expanding ways for children to talk and think in school. *Educational Psychology Review*, 15, 181–198.
- Clark, D. B. (2006). Longitudinal conceptual change in students' understanding of thermal equilibrium: An examination of the process of conceptual restructuring. *Cognition and Instruction*, 24, 467–563.
- Clark, D. C. (1971). Teaching concepts in the classroom: A set of teaching prescriptions derived from experimental research. *Journal of Educational Psychology*, 62, 253–278.
- Clark, J. M., & Paivio, A. (1991). Dual coding theory and education. *Educational Psychology Review*, 3, 149–210.
- Clark, R. E., Feldon, D. F., van Merriënboer, J. J. G., Yates, K. A., & Early, S. (2008). Cognitive task analysis. In J. M. Spector, M. D. Merrill, J. van Merriënboer, & M. P. Driscoll (Eds.), *Handbook of research on educational communications and technology* (3rd ed., pp. 577–593). New York: Erlbaum.
- Clarke, H. F., Dalley, J. W., Crofts, H. S., Robbins, T. W., & Roberts, A. C. (2004). Cognitive inflexibility after prefrontal serotonin depletion. *Science*, 304, 878–880.
- Clayton, M. C., & Helms, B. P. (2009). Increasing seat belt use on a college campus: An evaluation of two prompting procedures. *Journal of Applied Behavior Analysis*, 42, 161–164.
- Clement, J. (2008). The role of explanatory models in teaching for conceptual change. In S. Vosniadou (Ed.), *International handbook on conceptual change* (pp. 417–452). New York: Routledge.
- Clifford, M. M. (1990). Students need challenge, not easy success. *Educational Leadership*, 48 (1), 22–26.
- Clore, G. L., Gasper, K., & Garvin, E. (2001). Affect as information. In J. P. Forgas (Ed.), *Handbook of affect and social cognition* (pp. 121–144). Mahwah, NJ: Erlbaum.
- Coates, B., & Hartup, W. W. (1969). Age and verbalization in observational learning. *Developmental Psychology*, 1, 556–562.
- Cobb, P., Wood, T., Yackel, E., Nicholls, J., Wheatley, G., Trigatti, B., & Perlwitz, M. (1991). Assessment of a problem centered second-grade mathematics project. *Journal for Research in Mathematics Education*, 22, 3–29.
- Cobb, P., & Yackel, E. (1996). Constructivist, emergent, and sociocultural perspectives in the context of developmental research. *Educational Psychologist*, 31, 175–190.
- Cobb, P., Yackel, E., & Wood, T. (1989). Young children's emotional acts while engaged in mathematical problem solving. In D. B. McLeod & V. M. Adams (Eds.), *Affect and mathematical problem solving: A new perspective* (pp. 117–148). New York: Springer-Verlag.
- Cofer, C. (1971). Properties of verbal materials and verbal learning. In J. Kling & L. Riggs (Eds.), *Woodworth and Schlosberg's experimental psychology* (pp. 847–903). New York: Holt, Rinehart & Winston.
- Cognition and Technology Group at Vanderbilt (1990). Anchored instruction and its relationship to situated cognition. *Educational Researcher*, 19 (6), 2–10.
- Cohen, E. G. (1994). Restructuring the classroom: Conditions for productive small groups. *Review of Educational Research*, 64, 1–35.
- Cohen, G. (2000). Hierarchical models in cognition: Do they have psychological reality? *European Journal of Cognitive Psychology*, 12 (1), 1–36.
- Cohen, G. D. (2005). *The mature mind: The positive power of the aging brain*. New York: Basic Books.
- Cohen, L. B., & Cashon, C. H. (2006). Infant cognition. In W. Damon & R. M. Lerner (Series Eds.), D. Kuhn, & R. Siegler (Vol. Eds.), *Handbook of child psychology: Vol. 2. Cognition, perception, and language* (6th ed., pp. 214–251). New York: Wiley.
- Cohen, R. L. (1989). Memory for action events: The power of enactment. *Educational Psychology Review*, 1, 57–80.
- Cole, D. A., Maxwell, S. E., Martin, J. M., Peeke, L. G., Seroczynski, A. D., Tram, J. M., et al. (2001). The development of multiple domains of child and adolescent self-concept: A cohort sequential longitudinal design. *Child Development*, 72, 1723–1746.
- Cole, M. (1990). Cognitive development and formal schooling: The evidence from cross-cultural research. In L. C. Moll (Ed.), *Vygotsky and education* (pp. 89–110). New York: Cambridge University Press.

- Cole, M. (2006). Culture and cognitive development in phylogenetic, historical and ontogenetic perspective. In W. Damon & R. M. Lerner (Series Eds.), D., Kuhn, & R. Siegler (Vol. Eds.), *Handbook of child psychology: Vol. 2. Cognition, perception, and language* (6th ed., pp. 636–683).
- Cole, M., & Cagigas, X. E. (2010). Cognition. In M. H. Bornstein (Ed.), *Handbook of cultural developmental science* (pp. 127–142). New York: Psychology Press.
- Cole, M., & Hatano, G. (2007). Cultural-historical activity theory: Integrating phylogeny, cultural history, and ontogenesis in cultural psychology. In S. Kitayama & D. Cohen (Eds.), *Handbook of cultural psychology* (pp. 109–135). New York: Guilford Press.
- Cole, M., & Scribner, S. (1978). Introduction. In L. S. Vygotsky, *Mind in society: The development of higher psychological processes* (M. Cole, V. John-Steiner, S. Scribner, & E. Soubberman, Eds., pp. 1–14). Cambridge, MA: Harvard University Press.
- Collie, R., & Hayne, H. (1999). Deferred imitation by 6- and 9-month-old infants: More evidence for declarative memory. *Developmental Psychology*, *35*, 83–90.
- Collier, G., Hirsh, E., & Hamlin, P. H. (1972). The ecological determinants of reinforcement in the rat. *Physiology and Behavior*, *9*, 705–716.
- Collins, A. (2006). Cognitive apprenticeship. In R. K. Sawyer (Ed.), *The Cambridge handbook of the learning sciences* (pp. 47–60). Cambridge, England: Cambridge University Press.
- Collins, A., Brown, J. S., & Newman, S. E. (1989). Cognitive apprenticeship: Teaching the crafts of reading, writing, and mathematics. In L. B. Resnick (Ed.), *Knowing, learning, and instruction: Essays in honor of Robert Glaser* (pp. 453–494). Hillsdale, NJ: Erlbaum.
- Collins, A. M., & Loftus, E. F. (1975). A spreading-activation theory of semantic processing. *Psychological Review*, *82*, 407–428.
- Collins, A. M., & Quillian, M. R. (1969). Retrieval time from semantic memory. *Journal of Verbal Learning and Verbal Behavior*, *8*, 240–247.
- Collins, A. M., & Quillian, M. R. (1972). How to make a language user. In E. Tulving & W. Donaldson (Eds.), *Organization of memory* (pp. 309–351). New York: Academic Press.
- Coltheart, M., Lea, C. D., & Thompson, K. (1974). In defense of iconic memory. *Quarterly Journal of Experimental Psychology*, *26*, 633–641.
- Colwill, R. M. (1993). An associative analysis of instrumental learning. *Current Directions in Psychological Science*, *2*, 111–116.
- Coman, A., Manier, D., & Hirst, W. (2009). Forgetting the unforgettable through conversation: Socially shared retrieval-induced forgetting of September 11 memories. *Psychological Science*, *20*, 627–633.
- Combs, A. W., Richards, A. C., & Richards, F. (1976). *Perceptual psychology: A humanistic approach to the study of persons*. New York: Harper & Row.
- Conklin, C. A. (2006). Environments as cues to smoke: Implications for human extinction-based research and treatment. *Experimental and Clinical Psychopharmacology*, *14*, 12–19.
- Conklin, H. M., & Iacono, W. G. (2002). Schizophrenia: A neurodevelopmental perspective. *Current Directions in Psychological Science*, *11*, 33–37.
- Connell, J. P., & Wellborn, J. G. (1991). Competence, autonomy, and relatedness: A motivational analysis of self-system processes. In M. R. Gunnar & L. A. Sroufe (Eds.), *Self processes and development: The Minnesota Symposia on Child Psychology* (Vol. 23, pp. 43–77). Hillsdale, NJ: Erlbaum.
- Conrad, N. J. (2008). From reading to spelling and spelling to reading: Transfer goes both ways. *Journal of Educational Psychology*, *100*, 869–878.
- Conrad, R. (1964). Acoustic confusions in immediate memory. *British Journal of Psychology*, *55*, 75–84.
- Conyers, C., Miltenberger, R., Maki, A., Barenz, R., Jurgens, M., Sailer, A., Haugen, M., & Kopp, B. (2004). A comparison of response cost and differential reinforcement of other behavior to reduce disruptive behavior in a preschool classroom. *Journal of Applied Behavior Analysis*, *37*, 411–415.
- Cook, R. G., & Smith, J. D. (2006). Stages of abstraction and exemplar memorization in pigeon category learning. *Psychological Science*, *17*, 1059–1067.
- Cooney, J. B. (1991). Reflections on the origin of mathematical intuition and some implications for instruction. *Learning and Individual Differences*, *3*, 83–107.
- Cooper, G., & Sweller, J. (1987). Effects of schema acquisition and rule automation on mathematical problem-solving transfer. *Journal of Educational Psychology*, *79*, 347–362.
- Cooper, H. (1989). Synthesis of research on homework. *Educational Leadership*, *47* (3), 85–91.
- Cooper, L. A., & Shepard, R. N. (1973). The time required to prepare for a rotated stimulus. *Memory and Cognition*, *1*, 246–250.
- Coplan, R. J., & Arbeau, K. A. (2009). Peer interactions and play in early childhood. In K. H. Rubin, W. M. Bukowski, & B. Laursen (Eds.), *Handbook of peer interactions, relationships, and groups* (pp. 143–161). New York: Guilford Press.
- Corbett, H. D., & Wilson, B. (1988). Raising the stakes in statewide mandatory minimum competency testing. *Politics of Education Association Yearbook*, 27–39.
- Corkill, A. J. (1992). Advance organizers: Facilitators of recall. *Educational Psychology Review*, *4*, 33–67.
- Corkill, A. J., Bouchard, L., & Bendixen, L. D. (2002, April). *Epistemic beliefs as a measure of dispositions: Comparing preservice and practicing teachers*. Paper presented at the annual meeting of the American Educational Research Association, New Orleans, LA.
- Cormier, S. M. (1987). The structural processes underlying transfer of training. In S. M. Cormier & J. D. Hagman (Eds.), *Transfer of learning: Contemporary research and applications* (pp. 152–182). San Diego, CA: Academic Press.
- Cormier, S. M., & Hagman, J. D. (1987a). Introduction. In S. M. Cormier & J. D. Hagman (Eds.), *Transfer of learning: Contemporary research and applications* (pp. 1–8). San Diego, CA: Academic Press.
- Cormier, S. M., & Hagman, J. D. (Eds.) (1987b). *Transfer of learning: Contemporary research and applications*. San Diego, CA: Academic Press.
- Corno, L. (1996). Homework is a complicated thing. *Educational Researcher*, *25* (8), 27–30.
- Corno, L., Cronbach, L. J., Kupermintz, H., Lohman, D. F., Mandinach, E. B., Porteu, A. W., & Talbert, J. E. (2002). *Remaking the concept of aptitude: Extending the legacy of Richard E. Snow*. Mahwah, NJ: Erlbaum.
- Corno, L., & Mandinach, E. B. (2004). What we have learned about student engagement in the past twenty years. In D. M. McNeerney & S. Van Etten (Eds.), *Big theories revisited* (pp. 299–328). Greenwich, CT: Information Age.
- Corno, L., & Rohrkemper, M. M. (1985). The intrinsic motivation to learn in classrooms. In C. Ames & R. Ames (Eds.), *Research on motivation in education: Vol. 2. The classroom milieu* (pp. 53–90). Orlando, FL: Academic Press.
- Cornoldi, C. (2010). Metacognition, intelligence, and academic performance. In H. S. Waters & W. Schneider (Eds.), *Metacognition, strategy use, and instruction* (pp. 257–277). New York: Guilford Press.
- Corpus, J. H., McClintic-Gilbert, M. S., & Hayenga, A. O. (2009). Within-year changes in children's intrinsic and extrinsic motivational orientations: Contextual predictors and academic outcomes. *Contemporary Educational Psychology*, *34*, 154–166.
- Cothern, N. B., Konopak, B. C., & Willis, E. L. (1990). Using readers' imagery of literary characters to study text meaning construction. *Reading Research and Instruction*, *30*, 15–29.
- Covington, M. V. (1992). *Making the grade: A self-worth perspective on motivation and school reform*. Cambridge, England: Cambridge University Press.
- Covington, M. V. (2000). Intrinsic versus extrinsic motivation in schools: A reconciliation. *Current Directions in Psychological Science*, *9*, 22–25.
- Covington, M. V. (2004). Self-worth theory goes to college: Or do our motivation theories motivate? In D. M. McNeerney & S. Van Etten (Eds.), *Big theories revisited* (pp. 91–114). Greenwich, CT: Information Age.
- Covington, M. V., & Beery, R. M. (1976). *Self-worth and school learning*. New York: Holt, Rinehart & Winston.
- Covington, M. V., & Mueller, K. J. (2001). Intrinsic versus extrinsic motivation: An approach/avoidance reformulation. *Educational Psychology Review*, *13*, 157–176.
- Covington, M. V., & Omelich, C. (1979). Effort: The double-edged sword in school achievement. *Journal of Educational Psychology*, *71*, 169–182.
- Covington, M. V., & Omelich, C. L. (1991). Need achievement revisited: Verification of Atkinson's original 2 x 2 model. In C. D. Spielberger, I. G. Sarason, Z. Kulcsar, & G. L. Van Heck (Eds.),

- Stress and emotion* (Vol. 14, pp. 85–105). New York: Hemisphere.
- Cowan, N. (1995). *Attention and memory: An integrated framework*. New York: Oxford University Press.
- Cowan, N. (2007). What infants can tell us about working memory development. In L. M. Oakes & P. J. Bauer (Eds.), *Short- and long-term memory in infancy and early childhood: Taking the first steps toward remembering* (pp. 126–150). New York: Oxford University Press.
- Cowan, N. (2010). The magical mystery four: How is working memory capacity limited, and why? *Current Directions in Psychological Science*, *19*, 51–57.
- Cowan, N., Chen, Z., & Rouders, J. N. (2004). Constant capacity in an immediate serial-recall task: A logical sequel to Miller (1956). *Psychological Science*, *15*, 634–640.
- Cowan, N., Nugent, L. D., Elliott, E. M., & Saults, J. S. (2000). Persistence of memory for ignored looking of digits: Areas of developmental constancy and change. *Journal of Experimental Child Psychology*, *76*, 151–172.
- Cowan, N., Saults, J. S., & Morey, C. C. (2006). Development of working memory for verbal-spatial associations. *Journal of Memory and Language*, *55*, 274–289.
- Cowan, N., Wood, N. L., Nugent, L. D., & Treisman, M. (1997). There are two word-length effects in verbal short-term memory: Opposed effects of duration and complexity. *Psychological Science*, *8*, 290–295.
- Cox, B. D. (1997). The rediscovery of the active learner in adaptive contexts: A developmental-historical analysis of transfer of training. *Educational Psychologist*, *32*, 41–55.
- Cox, M. G., & Geller, E. S. (2010). Prompting safety belt use: Comparative impact on the target behavior and relevant body language. *Journal of Applied Behavior Analysis*, *43*, 321–325.
- Craft, M. A., Alberg, S. R., & Heward, W. L. (1998). Teaching elementary students with developmental disabilities to recruit teacher attention in a general education classroom: Effects on teacher praise and academic productivity. *Journal of Applied Behavior Analysis*, *31*, 399–415.
- Craik, F. I. M. (2006). Distinctiveness and memory: Comments and a point of view. In R. R. Hunt & J. B. Worthen (Eds.), *Distinctiveness and memory* (pp. 425–442). Oxford, England: Oxford University Press.
- Craik, F. I. M., & Lockhart, R. S. (1972). Levels of processing: A framework for memory research. *Journal of Verbal Learning and Verbal Behavior*, *11*, 671–684.
- Craik, F. I. M., & Tulving, E. (1975). Depth of processing and the retention of words in episodic memory. *Journal of Experimental Psychology: General*, *104*, 268–294.
- Craik, F. I. M., & Watkins, M. J. (1973). The role of rehearsal in short-term memory. *Journal of Verbal Learning and Verbal Behavior*, *12*, 598–607.
- Crawley, A. M., Anderson, D. R., Wilder, A., Williams, M., & Santomero, A. (1999). Effects of repeated exposures to a single episode of the television program *Blue's Clues* on the viewing behaviors and comprehension of preschool children. *Journal of Educational Psychology*, *91*, 630–637.
- Credé, M., & Kuncel, N. R. (2008). Study habits, skills, and attitudes: The third pillar supporting collegiate academic performance. *Perspectives on Psychological Science*, *3*, 425–453.
- Crespi, L. P. (1942). Quantitative variation of incentive and performance in the white rat. *American Journal of Psychology*, *55*, 467–517.
- Crick, N. R., & Dodge, K. A. (1996). Social information-processing mechanisms in reactive and proactive aggression. *Child Development*, *67*, 993–1002.
- Critchfield, T. S., Haley, R., Sabo, B., Colbert, J., & Macropolis, G. (2003). A half century of scalloping in the work habits of the United States Congress. *Journal of Applied Behavior Analysis*, *36*, 465–486.
- Critchfield, T. S., & Kollins, S. H. (2001). Temporal discounting: Basic research and the analysis of socially important behavior. *Journal of Applied Behavior Analysis*, *34*, 101–122.
- Crocker, J., Karpinski, A., Quinn, D. M., & Chase, S. K. (2003). When grades determine self-worth: Consequences of contingent self-worth for male and female engineering and psychology majors. *Journal of Personality and Social Psychology*, *85*, 507–516.
- Cromley, J. G., Snyder, L. E., Luciw, U. A., & Tanaka, J. C. (2008, March). *Testing the fit of the DIME model of reading comprehension with biology text*. Paper presented at the annual meeting of the American Educational Research Association, New York.
- Cromley, J. G., Snyder-Hogan, L. E., & Luciw-Dubas, U. A. (2010a). Cognitive activities in complex science text and diagrams. *Contemporary Educational Psychology*, *35*, 59–74.
- Cromley, J. G., Snyder-Hogan, L. E., & Luciw-Dubas, U. A. (2010b). Reading comprehension of scientific text: A domain-specific test of the direct and inferential mediation model of reading comprehension. *Journal of Educational Psychology*, *102*, 687–700.
- Crone, D. A., & Horner, R. H. (2003). *Building positive behavior support systems in schools: Functional behavioral assessment*. New York: Guilford Press.
- Croninger, R. G., & Valli, L. (2009). "Where is the action?" Challenges to studying the teaching of reading in elementary classrooms. *Educational Researcher*, *38*, 100–108.
- Crosbie, J., & Kelly, G. (1994). Effects of imposed postfeedback delays in programmed instruction. *Journal of Applied Behavior Analysis*, *27*, 483–491.
- Crowder, N. A., & Martin, G. (1961). *Trigonometry*. Garden City, NY: Doubleday.
- Crowder, R. G. (1993). Short-term memory: Where do we stand? *Memory and Cognition*, *21*, 142–145.
- Crowder, R. G., & Wagner, R. K. (1992). *The psychology of reading: An introduction* (2nd ed.). New York: Oxford University Press.
- Crowley, K., & Jacobs, M. (2002). Building islands of expertise in everyday family activity. In G. Leinhardt, K. Crowley, & K. Knutson (Eds.), *Learning conversations in museums* (pp. 333–356). Mahwah, NJ: Erlbaum.
- Crowley, K., & Siegler, R. S. (1999). Explanation and generalization in young children's strategy learning. *Child Development*, *70*, 304–316.
- Crowne, D. P., & Marlowe, D. (1964). *The approval motive: Studies in evaluative dependence*. New York: Wiley.
- Csikszentmihalyi, M. (1990). *Flow: The psychology of optimal experience*. New York: Harper & Row.
- Csikszentmihalyi, M., Abuhamdeh, S., & Nakamura, J. (2005). Flow. In A. J. Elliot & C. S. Dweck (Eds.), *Handbook of competence and motivation* (pp. 598–608). New York: Guilford Press.
- Csikszentmihalyi, M., & Nakamura, J. (1989). The dynamics of intrinsic motivation: A study of adolescents. In C. Ames & R. Ames (Eds.), *Research on motivation in education: Vol. 3. Goals and cognitions* (pp. 45–71). Orlando, FL: Academic Press.
- Curtis, K. A., & Graham, S. (1991, April). *Altering beliefs about the importance of strategy: An attributional intervention*. Paper presented at the annual meeting of the American Educational Research Association, Chicago.
- Curtiss, S. (1977). *Genie: A psycholinguistic study of a modern-day "wild child."* New York: Academic Press.
- Cushing, L. S., & Kennedy, C. H. (1997). Academic effects of providing peer support in general education classrooms on students without disabilities. *Journal of Applied Behavior Analysis*, *30*, 139–151.
- Cuvo, A. J. (1975). Developmental differences in rehearsal and free recall. *Journal of Experimental Child Psychology*, *19*, 65–78.
- Dack, C., McHugh, L., & Reed, P. (2009). Generalization of causal efficacy judgments after evaluative learning. *Learning and Behavior*, *37*, 336–348.
- Dahan, D. (2010). The time course of interpretation in speech comprehension. *Current Directions in Psychological Science*, *19*, 121–126.
- Dahlin, B., & Watkins, D. (2000). The role of repetition in the processes of memorizing and understanding: A comparison of the views of Western and Chinese secondary students in Hong Kong. *British Journal of Educational Psychology*, *70*, 65–84.
- Dai, D. Y. (2002, April). *Effects of need for cognition and reader beliefs on the comprehension of narrative text*. Paper presented at the annual meeting of the American Educational Research Association, New Orleans, LA.
- Dai, D. Y. (2005, April). Introductory remarks. In D. Y. Dai (Chair), *Beyond cognitivism: Where are we now?* Symposium presented at the annual meeting of the American Educational Research Association, Montreal.
- Dai, D. Y., & Sternberg, R. J. (2004). Beyond cognitivism: Toward an integrated understanding of intellectual functioning and development. In D. Y. Dai & R. J. Sternberg (Eds.), *Motivation, emotion, and cognition: Integrative perspectives on intellectual functioning and development* (pp. 3–38). Mahwah, NJ: Erlbaum.
- d'Ailly, H. (2003). Children's autonomy and perceived control in learning: A model of

- motivation and achievement in Taiwan. *Journal of Educational Psychology*, 95, 84–96.
- Dallett, K. M. (1964). Implicit mediators and magnitude of primary reinforcement. *Journal of Verbal Learning and Verbal Behavior*, 3, 209–214.
- Damasio, A. R. (1994). *Descartes' error: Emotion, reason, and the human brain*. New York: Avon Books.
- D'Amato, M. R. (1955). Secondary reinforcement and magnitude of primary reinforcement. *Journal of Comparative and Physiological Psychology*, 48, 378–380.
- Damisch, L., Stoberock, B., & Mussweiler, T. (2010). Keep your fingers crossed! How superstition improves performance. *Psychological Science*, 21, 1014–1020.
- Daneman, M. (1987). Reading and working memory. In J. R. Beech & A. M. Colley (Eds.), *Cognitive approaches to reading* (pp. 57–86). Chichester, England: Wiley.
- Daniels, L. M., Haynes, T. L., Stupnisky, R. H., Perry, R. P., Newall, N. E., & Pekrun, R. (2008). Individual differences in achievement goal: A longitudinal study of cognitive, emotional, and achievement outcomes. *Contemporary Educational Psychology*, 33, 584–608.
- Danner, F. (2008, March). *The effects of perceptions of classroom assessment practices and academic press on classroom mastery goals and high school students' self-reported cheating*. Paper presented at the annual meeting of the American Educational Research Association, New York.
- Dansereau, D. F. (1988). Cooperative learning strategies. In C. E. Weinstein, E. T. Goetz, & P. A. Alexander (Eds.), *Learning and study strategies: Issues in assessment, instruction, and evaluation* (pp. 103–120). San Diego, CA: Academic Press.
- Dansereau, D. F. (1995). Derived structural schemas and the transfer of knowledge. In A. McKeough, J. Lupart, & A. Marini (Eds.), *Teaching for transfer: Fostering generalization in learning* (pp. 93–122). Mahwah, NJ: Erlbaum.
- Darley, J. M., & Gross, P. H. (1983). A hypothesis-confirming bias in labeling effects. *Journal of Personality and Social Psychology*, 44, 20–33.
- Darling-Hammond, L., & Bransford, J. (Eds.) (2005). *Preparing teachers for a changing world: What teachers should learn and be able to do*. San Francisco: Jossey-Bass/Wiley.
- Darwin, C. J., Turvey, M. T., & Crowder, R. G. (1972). An auditory analogue of the Sperling partial report procedure: Evidence for brief auditory storage. *Cognitive Psychology*, 3, 255–267.
- Davachi, L., & Dobbins, I. G. (2008). Declarative memory. *Current Directions in Psychological Science*, 17, 112–118.
- Davidson, J. E., & Sternberg, R. J. (1998). Smart problem solving: How metacognition helps. In D. J. Hacker, J. Dunlosky, & A. C. Graesser (Eds.), *Metacognition in educational theory and practice* (pp. 47–68). Mahwah, NJ: Erlbaum.
- Davidson, J. E., & Sternberg, R. J. (2003). *The psychology of problem solving*. Cambridge, England: Cambridge University Press.
- Davies, C., & Uttal, D. H. (2007). Map use and the development of spatial cognition. In J. M. Plumert & J. P. Spencer (Eds.), *The emerging spatial mind* (pp. 219–247). New York: Oxford University Press.
- Davis, C. A., & Fox, J. (1999). Evaluating environmental arrangements as setting events: Review and implications for measurement. *Journal of Behavioral Education*, 9 (2), 77–92.
- Davis, G. A. (1966). Current status of research and theory in human problem solving. *Psychological Bulletin*, 66, 36–54.
- Davis, G. A., & Thomas, M. A. (1989). *Effective schools and effective teachers*. Boston: Allyn & Bacon.
- Davis, H. A. (2003). Conceptualizing the role and influence of student-teacher relationships on children's social and cognitive development. *Educational Psychologist*, 38, 207–234.
- Davis, L. E., Ajzen, I., Saunders, J., & Williams, T. (2002). The decision of African American students to complete high school: An application of the theory of planned behavior. *Journal of Educational Psychology*, 94, 810–819.
- Davis, L. L., & O'Neill, R. E. (2004). Use of response cards with a group of students with learning disabilities including those for whom English is a second language. *Journal of Applied Behavior Analysis*, 37, 219–222.
- Davis-Kean, P. E., Huesmann, R., Jager, J., Collins, W. A., Bates, J. E., & Lansford, J. E. (2008). Changes in the relation of self-efficacy beliefs and behaviors across development. *Child Development*, 79, 1257–1269.
- DeBacker, T. K., & Crowson, H. M. (2006). Influences on cognitive engagement and achievement: Personal epistemology and achievement motives. *British Journal of Educational Psychology*, 76, 535–551.
- DeBacker, T. K., & Crowson, H. M. (2008). Measuring need for closure in classroom learners. *Contemporary Educational Psychology*, 33, 711–732.
- DeBacker, T. K., & Crowson, H. M. (2009). The influence of need for closure on learning and teaching. *Educational Psychology Review*, 21, 303–323.
- de Boer, H., Bosker, R. J., & van der Werf, M. P. C. (2010). Sustainability of teacher expectation bias effects on long-term student performance. *Journal of Educational Psychology*, 102, 168–179.
- de Bruin, A., Whittingham, J., Hillebrand, C., & Rikers, R. (2003, April). *The effect of self-explanations and anticipations on acquiring chess skill in novices*. Paper presented at the annual meeting of the American Educational Research Association, Chicago.
- DeCasper, A. J., & Spence, M. J. (1986). Prenatal maternal speech influences newborns' perception of speech sounds. *Infant Behavior and Development*, 9, 133–150.
- deCharms, R. (1972). Personal causation training in the schools. *Journal of Applied Social Psychology*, 2, 95–113.
- Deci, E. L. (1971). Effects of externally mediated rewards on intrinsic motivation. *Journal of Personality and Social Psychology*, 18, 105–115.
- Deci, E. L. (1992). The relation of interest to the motivation of behavior: A self-determination theory perspective. In K. A. Renninger, S. Hidi, & A. Krapp (Eds.), *The role of interest in learning and development* (pp. 43–70). Hillsdale, NJ: Erlbaum.
- Deci, E. L., Koestner, R., & Ryan, R. M. (2001). Extrinsic rewards and intrinsic motivation in education: Reconsidered once again. *Review of Educational Research*, 71, 1–27.
- Deci, E. L., & Moller, A. C. (2005). The concept of competence: A starting place for understanding intrinsic motivation and self-determined extrinsic motivation. In A. J. Elliot & C. S. Dweck (Eds.), *Handbook of competence and motivation* (pp. 579–597). New York: Guilford Press.
- Deci, E. L., & Ryan, R. M. (1985). *Intrinsic motivation and self-determination in human behavior*. New York: Plenum Press.
- Deci, E. L., & Ryan, R. M. (1987). The support of autonomy and the control of behavior. *Journal of Personality and Social Psychology*, 53, 1024–1037.
- Deci, E. L., & Ryan, R. M. (1992). The initiation and regulation of intrinsically motivated learning and achievement. In A. K. Boggiano & T. S. Pittman (Eds.), *Achievement and motivation: A social-developmental perspective* (pp. 9–36). Cambridge, England: Cambridge University Press.
- Deci, E. L., & Ryan, R. M. (1995). Human autonomy: The basis for true self-esteem. In M. H. Kernis (Ed.), *Efficacy, agency, and self-esteem* (pp. 31–49). New York: Plenum Press.
- De Corte, E. (2003). Transfer as the productive use of acquired knowledge, skills, and motivations. *Current Directions in Psychological Science*, 12, 142–146.
- De Corte, E., Greer, B., & Verschaffel, L. (1996). Mathematics teaching and learning. In D. C. Berliner & R. C. Calfee (Eds.), *Handbook of educational psychology* (pp. 491–549). New York: Macmillan.
- De Corte, E., Op't Eynde, P., & Verschaffel, L. (2002). "Knowing what to believe": The relevance of students' mathematical beliefs for mathematics education. In B. K. Hofer & P. R. Pintrich (Eds.), *Personal epistemology: The psychology of beliefs about knowledge and knowing* (pp. 297–320). Mahwah, NJ: Erlbaum.
- Dee-Lucas, D., & Larkin, J. H. (1991). Equations in scientific proofs: Effects on comprehension. *American Educational Research Journal*, 28, 661–682.
- DeGrandpre, R. J. (2000). A science of meaning: Can behaviorism bring meaning to psychological science? *American Psychologist*, 55, pp. 721–739.
- de Jong, T., & van Joolingen, W. R. (1998). Scientific discovery learning with computer simulations of conceptual domains. *Review of Educational Research*, 68, 179–201.
- Delaney, P. F., Sahakyan, L., Kelley, C. M., & Zimmerman, C. A. (2010). Remembering to forget: The amnesic effect of daydreaming. *Psychological Science*, 21, 1036–1042.
- Delclos, V. R., & Harrington, C. (1991). Effects of strategy monitoring and proactive instruction on children's problem-solving performance. *Journal of Educational Psychology*, 83, 35–42.

- deLeeuw, N., & Chi, M. T. H. (2003). Self-explanation: Enriching a situation model or repairing a domain model? In G. M. Sinatra & P. R. Pintrich (Eds.), *Intentional conceptual change* (pp. 55–78). Mahwah, NJ: Erlbaum.
- Delgado-Gaitan, C. (1994). Socializing young children in Mexican-American families: An intergenerational perspective. In P. M. Greenfield & R. R. Cocking (Eds.), *Cross-cultural roots of minority child development* (pp. 55–86). Mahwah, NJ: Erlbaum.
- De Lisi, R., & Golbeck, S. L. (1999). Implications of Piagetian theory for peer learning. In A. M. O'Donnell & A. King (Eds.), *Cognitive perspectives on peer learning* (pp. 3–37). Mahwah, NJ: Erlbaum.
- DeLoache, J. S. (1995). Early understanding and use of symbols: The model model. *Current Directions in Psychological Science*, 4, 109–113.
- Delval, J. (1994). Stages in the child's construction of social knowledge. In M. Carretero & J. F. Voss (Eds.), *Cognitive and instructional processes in history and the social sciences* (pp. 77–102). Mahwah, NJ: Erlbaum.
- Demetriou, A., Christou, C., Spanoudis, G., & Platsidou, M. (2002). The development of mental processing: Efficiency, working memory, and thinking. *Monographs of the Society for Research in Child Development*, 67 (1, Serial No. 268).
- Demetriou, A., & Kazi, S. (2001). *Unity and modularity in the mind and the self*. London: Routledge.
- Dempster, F. N. (1991). Synthesis of research on reviews and tests. *Educational Leadership*, 48 (7), 71–76.
- Dempster, F. N. (1992). The rise and fall of the inhibitory mechanism: Toward a unified theory of cognitive development and aging. *Developmental Review*, 12, 45–75.
- Dempster, F. N., & Corkill, A. J. (1999). Interference and inhibition in cognition and behavior: Unifying themes for educational psychology. *Educational Psychology Review*, 11, 1–88.
- Dempster, F. N., & Rohwer, W. D. (1974). Component analysis of the elaborative encoding effect in paired-associate learning. *Journal of Experimental Psychology*, 103, 400–408.
- Dennen, V. P., & Burner, K. J. (2008). The cognitive apprenticeship model in educational practice. In J. M. Spector, M. D. Merrill, J. van Merriënboer, & M. P. Driscoll (Eds.), *Handbook of research on educational communications and technology* (3rd ed., pp. 425–439). New York: Erlbaum.
- Derry, S. J. (1996). Cognitive schema theory in the constructivist debate. *Educational Psychologist*, 31, 163–174.
- Derry, S. J. (2006). eStep as a case of theory-based Web course design. In A. M. O'Donnell, C. E. Hmelo-Silver, & G. Erkens (Eds.), *Collaborative learning, reasoning, and technology* (pp. 171–196). Mahwah, NJ: Erlbaum.
- Derry, S. J., DuRussel, L. A., & O'Donnell, A. M. (1998). Individual and distributed cognitions in interdisciplinary teamwork: A developing case study and emerging theory. *Educational Psychology Review*, 10, 25–56.
- Derry, S. J., Levin, J. R., Osana, H. P., & Jones, M. S. (1998). Developing middle school students' statistical reasoning abilities through simulation gaming. In S. P. Lajoie (Ed.), *Reflections on statistics: Learning, teaching, and assessment in grades K–12* (pp. 175–195). Mahwah, NJ: Erlbaum.
- Desoete, A., Roeyers, H., & De Clercq, A. (2003). Can offline metacognition enhance mathematical problem solving? *Journal of Educational Psychology*, 95, 188–200.
- Deutsch, M. (1993). Educating for a peaceful world. *American Psychologist*, 48, 510–517.
- DeVries, R. (1969). Constancy of generic identity in the years three to six. *Monographs of the Society for Research in Child Development*, 34 (Whole No. 127).
- Dewhurst, S. A., & Conway, M. A. (1994). Pictures, images, and recollective experience. *Journal of Experimental Psychology: Learning, Memory, and Cognition*, 20, 1088–1098.
- Diamond, A., Barnett, W. S., Thomas, J., & Munro, S. (2007). Preschool program improves cognitive control. *Science*, 318, 1387–1388.
- Diamond, M., & Hopson, J. (1998). *Magic trees of the mind*. New York: Dutton.
- Dias, M. G. B. B., Roazzi, A., O'Brien, D. P., & Harris, P. L. (2005). Logical reasoning and fantasy contexts: Eliminating differences between children with and without experience in school. *Revista Interamericana de Psicologia*, 39, 13–22.
- Diaz, R. M., Neal, C. J., & Amaya-Williams, M. (1990). The social origins of self-regulation. In L. C. Moll (Ed.), *Vygotsky and education: Instructional implications and applications of sociohistorical psychology* (pp. 127–154). Cambridge, England: Cambridge University Press.
- Dickhäuser, O., & Meyer, W.-U. (2006). Gender differences in young children's math ability attributions. *Psychology Science*, 48 (1), 3–16.
- Diekman, A. B., Brown, E. R., Johnston, A. M., & Clark, E. K. (2010). Seeking congruity between goals and roles: A new look at why women opt out of science, technology, engineering, and mathematics careers. *Psychological Science*, 21, 1051–1057.
- Diesendruck, G., & Bloom, P. (2003). How specific is the shape bias? *Child Development*, 74, 168–178.
- Dijksterhuis, A., & Nordgren, L. F. (2006). A theory of unconscious thought. *Perspectives on Psychological Science*, 1, 95–109.
- Dijkstra, P., Kuyper, H., van der Werf, G., Buunk, A. P., & van der Zee, Y. G. (2008). Social comparison in the classroom: A review. *Review of Educational Research*, 78, 828–879.
- DiMartino, J., & Castaneda, A. (2007). Assessing applied skills. *Educational Leadership*, 64, 38–42.
- Dinges, D. F., Whitehouse, W. G., Orne, E. C., Powell, J. W., Orne, M. T., & Erdelyi, M. H. (1992). Evaluating hypnotic memory enhancement (hypernesia and reminiscence) using multitrial forced recall. *Journal of Experimental Psychology: Learning, Memory, and Cognition*, 18, 1139–1147.
- Dirix, C. E. H., Nijhuis, J. G., Jongma, H. W., & Hornstra, G. (2009). Aspects of fetal learning and memory. *Child Development*, 80, 1251–1258.
- diSessa, A. A. (1996). What do “just plain folk” know about physics? In D. R. Olson & N. Torrance (Eds.), *The handbook of education and human development: New models of learning, teaching, and schooling* (pp. 709–730). Cambridge, MA: Blackwell.
- diSessa, A. A. (2006). A history of conceptual change research. In R. K. Sawyer (Ed.), *The Cambridge handbook of the learning sciences* (pp. 265–281). Cambridge, England: Cambridge University Press.
- diSessa, A. A. (2007). An interactional analysis of clinical interviewing. *Cognition and Instruction*, 25, 523–565.
- diSessa, A. A. (2008). A bird's-eye view of the “pieces” vs. “coherence” controversy (from the “pieces” side of the fence). In S. Vosniadou (Ed.), *International handbook on conceptual change* (pp. 35–60). New York: Routledge.
- diSessa, A. A., Elby, A., & Hammer, D. (2003). J's epistemological stance and strategies. In G. M. Sinatra & P. R. Pintrich (Eds.), *Intentional conceptual change* (pp. 237–290). Mahwah, NJ: Erlbaum.
- Di Vesta, F. J., & Gray, S. G. (1972). Listening and notetaking. *Journal of Educational Psychology*, 63, 8–14.
- Di Vesta, F. J., & Ingersoll, G. M. (1969). Influence of pronounceability, articulation, and test mode on paired-associate learning by the study-recall procedure. *Journal of Experimental Psychology*, 79, 104–108.
- Di Vesta, F. J., & Pevely, S. T. (1984). The effects of encoding variability, processing activity and rule example sequences on the transfer of conceptual rules. *Journal of Educational Psychology*, 76, 108–119.
- Dix, T., Stewart, A. D., Gershoff, E. T., & Day, W. H. (2007). Autonomy and children's reactions to being controlled: Evidence that both compliance and defiance may be positive markers in early development. *Child Development*, 78, 1204–1221.
- Dixon, F. A., Dungan, D. E., & Young, A. (2003, April). *An empirical typology of perfectionism in students who attend a Christian liberal arts university*. Paper presented at the annual meeting of the American Educational Research Association, Chicago.
- Dixon, J. A., & Kelley, E. (2007). Theory revision and redescription. *Current Directions in Psychological Science*, 16, 111–115.
- Dixon, M. R., & Cummings, A. (2001). Self-control in children with autism: Response allocation during delays to reinforcement. *Journal of Applied Behavior Analysis*, 34, 491–495.
- Dixon, M. R., Rehfeldt, R. A., & Randich, L. (2003). Enhancing tolerance to delayed reinforcers: The role of intervening activities. *Journal of Applied Behavior Analysis*, 36, 263–266.
- Do, S. L., & Schallert, D. L. (2004). Emotions and classroom talk: Toward a model of the role of affect in students' experiences of classroom

- discussions. *Journal of Educational Psychology*, 96, 619–634.
- Dodge, K. A., Asher, S. R., & Parkhurst, J. T. (1989). Social life as a goal-coordination task. In C. Ames & R. Ames (Eds.), *Research on motivation in education: Vol. 3. Goals and cognitions* (pp. 107–138). San Diego, CA: Academic Press.
- Doidge, N. (2007). *The brain that changes itself: Stories of personal triumph from the frontiers of brain science*. New York: Penguin.
- Dole, J. A., Duffy, G. G., Roehler, L. R., & Pearson, P. D. (1991). Moving from the old to the new: Research on reading comprehension instruction. *Review of Educational Research*, 61, 239–264.
- Dolezal, D. N., & Kurtz, P. F. (2010). Evaluation of combined-antecedent variables on functional analysis results and treatment of problem behavior in a school setting. *Journal of Applied Behavior Analysis*, 43, 309–314.
- Dollard, J. C., Doob, L., Miller, N., Mowrer, O., & Sears, R. (1939). *Frustration and aggression*. New Haven, CT: Yale University Press.
- Dominowski, R. L. (1998). Verbalization and problem solving. In D. J. Hacker, J. Dunlosky, & A. C. Graesser (Eds.), *Metacognition in educational theory and practice* (pp. 25–45). Mahwah, NJ: Erlbaum.
- Donahoe, J., & Vegas, R. (2004). Pavlovian conditioning: The CS-UR relation. *Journal of Experimental Psychology: Animal Behavior Processes*, 30, 17–33.
- Donaldson, M. (1978). *Children's minds*. New York: W. W. Norton.
- Donnelly, C. M., & McDaniel, M. A. (1993). Use of analogy in learning scientific concepts. *Journal of Experimental Psychology: Learning, Memory, and Cognition*, 19, 975–987.
- Doolling, D. J., & Christiaansen, R. E. (1977). Episodic and semantic aspects of memory for prose. *Journal of Experimental Psychology: Human Learning and Memory*, 3, 428–436.
- Dorris, M. (1989). *The broken cord*. New York: Harper & Row.
- Dotterer, A. M., McHale, S. M., & Crouter, A. C. (2009). The development and correlates of academic interests from childhood through adolescence. *Journal of Educational Psychology*, 101, 509–519.
- Doupe, A., & Kuhl, P. (1999). Birdsong and human speech: Common themes and mechanisms. *Annual Review of Neuroscience*, 22, 567–631.
- Dowaliby, F. J., & Schumer, H. (1973). Teacher-centered versus student-centered mode of college classroom instruction as related to manifest anxiety. *Journal of Educational Psychology*, 64, 125–132.
- Downing, P. E. (2000). Interactions between visual working memory and selective attention. *Psychological Science*, 11, 467–473.
- Downs, R. M., & Stea, D. (1977). *Maps in minds*. New York: Harper & Row.
- Dowson, M., & McInerney, D. M. (2001). Psychological parameters of students' social and work avoidance goals: A qualitative investigation. *Journal of Educational Psychology*, 93, 35–42.
- Doyle, W. (1983). Academic work. *Review of Educational Research*, 53, 159–199.
- Doyle, W. (1986). Classroom organization and management. In M. C. Wittrock (Ed.), *Handbook of research on teaching* (3rd ed., pp. 392–431). New York: Macmillan.
- Doyle, W. (1990). Classroom management techniques. In O. C. Moles (Ed.), *Student discipline strategies: Research and practice* (pp. 113–127). Albany: State University of New York Press.
- Draganski, B., Gaser, C., Busch, V., Schuierer, G., Bogdahn, U., & May, A. (2004). Changes in grey matter induced by training. *Nature*, 427, 311–312.
- Dreikurs, R. (1998). *Maintaining sanity in the classroom: Classroom management techniques* (2nd ed.). Bristol, PA: Hemisphere.
- Drevno, G. E., Kimball, J. W., Possi, M. K., Heward, W. L., Gardner, R., III, & Barbeta, P. M. (1994). Effects of active student responding during error correction on the acquisition, maintenance, and generalization of science vocabulary by elementary students: A systematic replication. *Journal of Applied Behavior Analysis*, 27, 179–180.
- Driver, R., Asoko, H., Leach, J., Mortimer, E., & Scott, P. (1994). Constructing scientific knowledge in the classroom. *Educational Researcher*, 23 (7), 5–12.
- Duckworth, A. L., & Seligman, M. E. P. (2005). Self-discipline outdoes IQ in predicting academic performance of adolescents. *Psychological Science*, 16, 939–944.
- Duell, O. K. (1994). Extended wait time and university student achievement. *American Educational Research Journal*, 31, 397–414.
- Dufresne, A., & Kobasigawa, A. (1989). Children's spontaneous allocation of study time: Differential and sufficient aspects. *Journal of Experimental Child Psychology*, 47, 274–296.
- Duit, R. (1990, April). *On the role of analogies, similes, and metaphors in learning science*. Paper presented at the annual meeting of the American Educational Research Association, Boston.
- DuNann, D. G., & Weber, S. J. (1976). Short- and long-term effects of contingency managed instruction on low, medium, and high GPA students. *Journal of Applied Behavior Analysis*, 9, 375–376.
- Duncker, K. (1945). On problem solving. *Psychological Monographs*, 58 (Whole No. 270).
- Dunlap, G., dePerczel, M., Clarke, S., Wilson, D., Wright, S., White, R., & Gomez, A. (1994). Choice making to promote adaptive behavior for students with emotional and behavioral challenges. *Journal of Applied Behavior Analysis*, 27, 505–518.
- Dunlosky, J., & Lipko, A. R. (2007). Metacomprehension: A brief history and how to improve its accuracy. *Current Directions in Psychological Science*, 16, 228–232.
- Dunlosky, J., Rawson, K. A., & McDonald, S. L. (2002). Influence of practice tests on the accuracy of predicting memory performance for paired associates, sentences, and text material. In T. J. Perfect & B. L. Schwartz (Eds.), *Applied metacognition* (pp. 68–92). Cambridge, England: Cambridge University Press.
- Dunn, C. S. (1983). The influence of instructional methods on concept learning. *Science Education*, 67, 647–656.
- Dunning, D., Heath, C., & Suls, J. M. (2004). Flawed self-assessment: Implications for health, education, and the workplace. *Psychological Science in the Public Interest*, 5, 69–106.
- Dunning, D., Johnson, K., Ehrlinger, J., & Kruger, J. (2003). Why people fail to recognize their own incompetence. *Current Directions in Psychological Science*, 12, 83–87.
- DuPaul, G. J., Ervin, R. A., Hook, C. L., & McGoey, K. E. (1998). Peer tutoring for children with attention deficit hyperactivity disorder: Effects on classroom behavior and academic performance. *Journal of Applied Behavior Analysis*, 31, 579–592.
- DuPaul, G., & Hoff, K. (1998). Reducing disruptive behavior in general education classrooms: The use of self-management strategies. *School Psychology Review*, 27, 290–304.
- Durik, A. M., & Harackiewicz, J. M. (2007). Different strokes for different folks: How individual interest moderates the effects of situational factors on task interest. *Journal of Educational Psychology*, 99, 597–610.
- Durik, A. M., Vida, M., & Eccles, J. S. (2006). Task values and ability beliefs as predictors of high school literacy choices: A developmental analysis. *Journal of Educational Psychology*, 98, 382–393.
- Dweck, C. S. (1986). Motivational processes affecting learning. *American Psychologist*, 41, 1040–1048.
- Dweck, C. S. (2000). *Self-theories: Their role in motivation, personality, and development*. Philadelphia: Psychology Press.
- Dweck, C. S., & Elliott, E. S. (1983). Achievement motivation. In E. M. Hetherington (Ed.), *Handbook of child psychology: Vol. 4. Socialization, personality, and social development* (4th ed., pp. 643–691). New York: Wiley.
- Dweck, C. S., Goetz, T. E., & Strauss, N. L. (1980). Sex differences in learned helplessness: IV. An experimental and naturalistic study of failure generalization and its mediators. *Journal of Personality and Social Psychology*, 38, 441–452.
- Dweck, C. S., & Leggett, E. L. (1988). A social-cognitive approach to motivation and personality. *Psychological Review*, 95, 256–273.
- Dweck, C. S., Mangels, J. A., & Good, C. (2004). Motivational effects on attention, cognition, and performance. In D. Y. Dai & R. J. Sternberg (Eds.), *Motivation, emotion, and cognition: Integrative perspectives on intellectual functioning and development* (pp. 41–55). Mahwah, NJ: Erlbaum.
- Dweck, C. S., & Molden, D. C. (2005). Self-theories: Their impact on competence motivation and acquisition. In A. J. Elliot & C. S. Dweck (Eds.), *Handbook of competence and motivation* (pp. 122–140). New York: Guilford Press.
- Eacott, M. J. (1999). Memory for the events of early childhood. *Current Directions in Psychological Science*, 8, 46–49.

- Eagly, A. H., Kulesa, P., Chen, S., & Chaiken, S. (2001). Do attitudes affect memory? Tests of the congeniality hypothesis. *Current Directions in Psychological Science*, 10, 5-9.
- Eaton, J. F., Anderson, C. W., & Smith, E. L. (1984). Students' misconceptions interfere with science learning: Case studies of fifth-grade students. *Elementary School Journal*, 84, 365-379.
- Ebbinghaus, H. (1913). *Memory: A contribution to experimental psychology* (H. A. Ruger & C. E. Bussenius, Trans.). New York: Teachers College. (Original work published 1885)
- Eccles, J. S. (2005). Subjective task value and the Eccles et al. model of achievement-related choices. In A. J. Elliot & C. S. Dweck (Eds.), *Handbook of competence and motivation* (pp. 105-121). New York: Guilford Press.
- Eccles, J. S. (2007). Families, schools, and developing achievement-related motivations and engagement. In J. E. Grusec & P. D. Hastings (Eds.), *Handbook of socialization: Theory and research* (pp. 665-691). New York: Guilford Press.
- Eccles, J. (2009). Who am I and what am I going to do with my life? Personal and collective identities as motivators of action. *Educational Psychologist*, 44, 78-89.
- Eccles, J. S., & Jacobs, J. E. (1986). Social forces shape math attitudes and performance. *Signs: Journal of Women in Culture and Society*, 11, 367-380.
- Eccles, J. S., & Midgley, C. (1989). Stage-environment fit: Developmentally appropriate classrooms for young adolescents. In C. Ames & R. Ames (Eds.), *Research on motivation in education: Vol. 3. Goals and cognition* (pp. 139-186). New York: Academic Press.
- Eccles, J. S., & Wigfield, A. (1985). Teacher expectations and student motivation. In J. B. Dusek (Ed.), *Teacher expectancies* (pp. 185-217). Hillsdale, NJ: Erlbaum.
- Eccles, J. S., Wigfield, A., & Schiefele, U. (1998). Motivation to succeed. In W. Damon (Editor-in-Chief) and N. Eisenberg (Volume Editor), *Handbook of child psychology* (5th ed., Vol. 3, pp. 1017-1095). New York: Wiley.
- Echevarria, M. (2003). Anomalies as a catalyst for middle school students' knowledge construction and scientific reasoning during science inquiry. *Journal of Educational Psychology*, 95, 357-374.
- Ecott, C. L., & Critchfield, T. S. (2004). Noncontingent reinforcement, alternative reinforcement, and the matching law: A laboratory demonstration. *Journal of Applied Behavior Analysis*, 37, 249-265.
- Edelson, D. C., & Reiser, B. J. (2006). Making authentic practices accessible to learners. In R. K. Sawyer (Ed.), *The Cambridge handbook of the learning sciences* (pp. 335-354). Cambridge, England: Cambridge University Press.
- Edens, K. M., & McCormick, C. B. (2000). How do adolescents process advertisements? The influence of ad characteristics, processing objective, and gender. *Contemporary Educational Psychology*, 25, 450-463.
- Edens, K. M., & Potter, E. F. (2001). Promoting conceptual understanding through pictorial representation. *Studies in Art Education*, 42, 214-233.
- Edmonds, M. S., Vaughn, S., Wexler, J., Reutebuch, C., Cable, A., Tackett, K. K., et al. (2009). A synthesis of reading interventions and effects of reading comprehension outcomes for older struggling students. *Review of Educational Research*, 79, 262-300.
- Edwards, K., & Bryan, T. S. (1997). Judgmental biases produced by instructions to disregard: The (paradoxical) case of emotional information. *Personality and Social Psychology Bulletin*, 23, 849-864.
- Eeds, M., & Wells, D. (1989). Grand conversations: An explanation of meaning construction in literature study groups. *Research in the Teaching of English*, 23, 4-29.
- Eelen, P., & Vervliet, B. (2006). Fear conditioning and clinical implications: What can we learn from the past? In M. G. Craske, D. Hermans, & D. Vansteenwegen (Eds.), *Fear and learning: From basic processes to clinical implications* (pp. 17-35). Washington, DC: American Psychological Association.
- Eich, R. (1995). Searching for mood dependent memory. *Psychological Science*, 6, 67-75.
- Eid, M., & Diener, E. (2001). Norms for experiencing emotions in different cultures: Inter- and intrainational differences. *Journal of Personality and Social Psychology*, 81, 869-885.
- Eilam, B. (2001). Primary strategies for promoting homework performance. *American Educational Research Journal*, 38, 691-725.
- Einstein, G. O., & McDaniel, M. A. (2005). Prospective memory: Multiple retrieval processes. *Current Directions in Psychological Science*, 14, 286-290.
- Eisenberger, R. (1992). Learned industriousness. *Psychological Review*, 99, 248-267.
- Eisenberger, R., & Cameron, J. (1996). Detrimental effects of reward: Reality or myth? *American Psychologist*, 51, 1153-1166.
- Eisner, E. W. (1994). *Cognition and curriculum reconsidered*. New York: Teachers College Press.
- Eitam, B., Hassin, R. R., & Schul, Y. (2008). Nonconscious goal pursuit in novel environments: The case of implicit learning. *Psychological Science*, 19, 261-267.
- Elbert, T., Pantev, C., Wienbruch, C., Rockstroh, B., & Taub, E. (1995). Increased cortical representation of the fingers of the left hand in string players. *Science*, 270, 305-307.
- Elder, A. D. (2002). Characterizing fifth grade students' epistemological beliefs in science. In B. K. Hofer & P. R. Pintrich (Eds.), *Personal epistemology: The psychology of beliefs about knowledge and knowing* (pp. 347-363). Mahwah, NJ: Erlbaum.
- Ellenwood, S., & Ryan, K. (1991). Literature and morality: An experimental curriculum. In W. M. Kurtines & J. L. Gewirtz (Eds.), *Moral behavior and development: Vol. 3. Application*. Mahwah, NJ: Erlbaum.
- Elliot, A. J. (1999). Approach and avoidance motivation and achievement goals. *Educational Psychologist*, 34, 169-189.
- Elliot, A. J. (2005). A conceptual history of the achievement goal construct. In A. J. Elliot & C. S. Dweck (Eds.), *Handbook of competence and motivation* (pp. 52-72). New York: Guilford Press.
- Elliot, A. J., Chirkov, V. I., Kim, Y., & Sheldon, K. M. (2001). A cross-cultural analysis of avoidance (relative to approach) personal goals. *Psychological Science*, 12, 505-510.
- Elliot, A. J., & McGregor, H. A. (2000, April). Approach and avoidance goals and autonomous-controlled regulation: Empirical and conceptual relations. In A. Assor (Chair), *Self-determination theory and achievement goal theory: Convergences, divergences, and educational implications*. Symposium conducted at the annual meeting of the American Educational Research Association, New Orleans.
- Elliot, A. J., & Murayama, K. (2008). On the measurement of achievement goals: Critique, illustration, and application. *Journal of Educational Psychology*, 100, 613-628.
- Elliot, A. J., Shell, M. M., Henry, K. B., & Maier, M. A. (2005). Achievement goals, performance contingencies, and performance attainment: An experimental test. *Journal of Educational Psychology*, 97, 630-640.
- Elliot, A. J., & Thrash, T. M. (2001). Achievement goals and the hierarchical model of achievement motivation. *Educational Psychology Review*, 13, 139-156.
- Elliott, D. J. (1995). *Music matters: A new philosophy of music education*. New York: Oxford University Press.
- Elliott, R., & Vasta, R. (1970). The modeling of sharing: Effects associated with vicarious reinforcement, symbolization, age, and generalization. *Journal of Experimental Child Psychology*, 10, 8-15.
- Ellis, H. C., & Hunt, R. R. (1983). *Fundamentals of human memory and cognition* (3rd ed.). Dubuque, IA: Wm. C. Brown.
- Ellis, J., Fitzsimmons, S., & Small-McGinley, J. (2010). Encouraging the discouraged: Students' views for elementary classrooms. In G. S. Goodman (Ed.), *Educational psychology reader: The art and science of how people learn* (pp. 251-272). New York: Peter Lang.
- Ellis, N. C. (Ed.) (1994). *Implicit and explicit learning of languages*. London: Academic Press.
- Ellis, S., Mendel, R., & Nir, M. (2006). Learning from successful and failed experience: The moderating role of kind of after-event review. *Journal of Applied Psychology*, 91, 669-680.
- Ellis, S., & Rogoff, B. (1986). Problem solving in children's management of instruction. In E. C. Mueller & C. R. Cooper (Eds.), *Process and outcome in peer relationships* (pp. 301-325). Orlando, FL: Academic Press.
- Embry, D. (2002). The Good Behavior Game: A best practice candidate as a universal behavioral vaccine. *Clinical Child and Family Psychology Review*, 5, 273-297.
- Emery, N. J., & Clayton, N. S. (2004). The mentality of crows: Convergent evolution of intelligence in corvids and apes. *Science*, 306, 1903-1907.
- Emmer, E. T. (1987). Classroom management and discipline. In V. Richardson-Koehler



- (Ed.), *Educators' handbook: A research perspective* (pp. 233–258). White Plains, NY: Longman.
- Emmer, E. T. (1994, April). *Teacher emotions and classroom management*. Paper presented at the annual meeting of the American Educational Research Association, New Orleans, LA.
- Empson, S. B. (1999). Equal sharing and shared meaning: The development of fraction concepts in a first-grade classroom. *Cognition and Instruction, 17*, 283–342.
- Emshoff, J. G., Redd, W. H., & Davidson, W. S. (1976). Generalization training and the transfer of treatment effects with delinquent adolescents. *Journal of Behavior Therapy and Experimental Psychiatry, 7*, 141–144.
- Engle, R. A. (2006). Framing interactions to foster generative learning: A situative explanation of transfer in a community of learners classroom. *Journal of the Learning Sciences, 15*, 451–498.
- Engle, R. A., & Conant, F. R. (2002). Guiding principles for fostering productive disciplinary engagement: Explaining an emergent argument in a community of learners classroom. *Cognition and Instruction, 20*, 399–483.
- Engle, R. W. (2002). Working memory capacity as executive attention. *Current Directions in Psychological Science, 11*, 19–23.
- English, H. B., Welborn, E. L., & Killian, C. D. (1934). Studies in substance memorization. *Journal of General Psychology, 11*, 233–260.
- English, L. D. (Ed.) (1997). *Mathematical reasoning: Analogies, metaphors, and images*. Mahwah, NJ: Erlbaum.
- Epstein, H. (1978). Growth spurts during brain development: Implications for educational policy and practice. In J. Chall & A. Mirsky (Eds.), *Education and the brain: The 77th yearbook of the National Society for the Study of Education, Part II* (pp. 343–370). Chicago: University of Chicago Press.
- Epstein, J. L. (1989). Family structures and student motivation. In R. E. Ames & C. Ames (Eds.), *Research on motivation in education: Vol. 3. Goals and cognitions* (pp. 259–295). New York: Academic Press.
- Epstein, R. (1991). Skinner, creativity, and the problem of spontaneous behavior. *Psychological Science, 2*, 362–370.
- Epstein, T. (2000). Adolescents' perspectives on racial diversity in U.S. history: Case studies from an urban classroom. *American Educational Research Journal, 37*, 185–214.
- Erdelyi, M. H. (2010). The ups and downs of memory. *American Psychologist, 65*, 623–633.
- Ericsson, K. A. (1996). *The road to excellence: The acquisition of expert performance in the arts and science, sports, and games*. Mahwah, NJ: Erlbaum.
- Ericsson, K. A. (2003). The acquisition of expert performance as problem solving. In J. E. Davidson & R. J. Sternberg (Eds.), *The psychology of problem solving* (pp. 31–83). Cambridge, England: Cambridge University Press.
- Esmonde, I. (2009). Ideas and identities: Supporting equity in cooperative mathematics learning. *Review of Educational Research, 79*, 1008–1043.
- Estes, D., Chandler, M., Horvath, K. J., & Backus, D. W. (2003). American and British college students' epistemological beliefs about research on psychological and biological development. *Applied Developmental Psychology, 23*, 625–642.
- Estes, W. K. (1969). New perspectives on some old issues in association theory. In N. J. Mackintosh & W. K. Honig (Eds.), *Fundamental issues in associative learning* (pp. 162–189). Halifax, Canada: Dalhousie University Press.
- Evans, E. M. (2008). Conceptual change and evolutionary biology: A developmental analysis. In S. Vosniadou (Ed.), *International handbook on conceptual change* (pp. 263–294). New York: Routledge.
- Evertson, C. M., & Weinstein, C. S. (2006). Classroom management as a field of inquiry. In C. M. Evertson & C. S. Weinstein (Eds.), *Handbook of classroom management: Research, practice, and contemporary issues* (pp. 3–15). Mahwah, NJ: Erlbaum.
- Eysenck, M. W., & Keane, M. T. (1990). *Cognitive psychology: A student's handbook*. Hove, England: Erlbaum.
- Fahrmeier, E. D. (1978). The development of concrete operations among the Hausa. *Journal of Cross-Cultural Psychology, 9*, 23–44.
- Fantino, E., Preston, R. A., & Dunn, R. (1993). Delay reduction: Current status. *Journal of Experimental Analysis of Behavior, 60*, 159–169.
- Fantuzzo, J. W., King, J., & Heller, L. R. (1992). Effects of reciprocal peer tutoring on mathematics and school adjustment: A component analysis. *Journal of Educational Psychology, 84*, 331–339.
- Farran, D. C. (2001). Critical periods and early intervention. In D. B. Bailey, Jr., J. T. Bruer, E. J. Symons, & J. W. Lichtman (Eds.), *Critical thinking about critical periods* (pp. 233–266). Baltimore: Paul H. Brookes.
- Farrar, M. J., & Goodman, G. S. (1992). Developmental changes in event memory. *Child Development, 63*, 173–187.
- Fashola, O. S., Drum, P. A., Mayer, R. E., & Kang, S. (1996). A cognitive theory of orthographic transitioning: Predictable errors in how Spanish-speaking children spell English words. *American Educational Research Journal, 33*, 825–843.
- Faust, G. W., & Anderson, R. C. (1967). Effects of incidental material in a programmed Russian vocabulary lesson. *Journal of Educational Psychology, 58*, 3–10.
- Feather, N. T. (1982). *Expectations and actions: Expectancy-value models in psychology*. Hillsdale, NJ: Erlbaum.
- Feinberg, M., & Willer, R. (2011). Apocalypse soon? Dire messages reduce belief in global warming by contradicting just-world beliefs. *Psychological Science, 22*, 34–38.
- Feinman, S. (1992). *Social referencing and the social construction of reality in infancy*. New York: Plenum Press.
- Feldman, J. (2003). The simplicity principle in human concept learning. *Current Directions in Psychological Science, 12*, 227–232.
- Feltz, D. L., Chaase, M. A., Moritz, S. E., & Sullivan, P. J. (1999). A conceptual model of coaching efficacy: Preliminary investigation and instrument development. *Journal of Educational Psychology, 91*, 765–776.
- Feltz, D. L., Landers, D. M., & Becker, B. J. (1988). A revised meta-analysis of the mental practice literature on motor skill performance. In D. Druckman & J. A. Swets (Eds.), *Enhancing human performance: Issues, theories, and techniques* (pp. 1–65). Washington, DC: National Academy Press.
- Fenning, P. A., & Bohanon, H. (2006). Schoolwide discipline policies: An analysis of discipline codes of conduct. In C. M. Evertson & C. S. Weinstein (Eds.), *Handbook of classroom management: Research, practice, and contemporary issues* (pp. 1021–1039). Mahwah, NJ: Erlbaum.
- Ferguson, E. L., & Hegarty, M. (1995). Learning with real machines or diagrams: Application of knowledge to real-world problems. *Cognition and Instruction, 13*, 129–160.
- Ferrari, M., & Elik, N. (2003). Influences on intentional conceptual change. In G. M. Sinatra & P. R. Pintrich (Eds.), *Intentional conceptual change* (pp. 21–54). Mahwah, NJ: Erlbaum.
- Ferretti, R. P., Lewis, W. E., & Andrews-Weckerly, S. (2009). Do goals affect the structure of students' argumentative writing strategies? *Journal of Educational Psychology, 101*, 577–589.
- Ferster, C. B., & Skinner, B. F. (1957). *Schedules of reinforcement*. Englewood Cliffs, NJ: Prentice Hall.
- Féry, Y.-A., & Morizot, P. (2000). Kinesthetic and visual image in modeling closed motor skills: The example of the tennis serve. *Perceptual and Motor Skills, 90*, 707–722.
- Feucht, F. C. (2010). Epistemic climate in elementary classrooms. In L. D. Bendixen & F. C. Feucht (Eds.), *Personal epistemology in the classroom: Theory, research, and educational implications* (pp. 55–93). New York: Cambridge University Press.
- Feuerstein, R. (1979). *The dynamic assessment of retarded performers: The Learning Potential Assessment Device, theory, instruments, and techniques*. Baltimore: University Park Press.
- Feuerstein, R. (1980). *Instrumental enrichment: An intervention program for cognitive modifiability*. Baltimore: University Park Press.
- Fiedler, K. (2008). Language: A toolbox for sharing and influencing social reality. *Perspectives on Psychological Science, 3*, 38–47.
- Field, D. (1987). A review of preschool conservation training: An analysis of analyses. *Developmental Review, 7*, 210–251.
- Field, T. F., Woodson, R., Greenberg, R., & Cohen, D. (1982). Discrimination and imitation of facial expressions by neonates. *Science, 218* (8), 179–181.
- Finke, R. A., & Bettle, J. (1996). *Chaotic cognition: Principles and applications*. Mahwah, NJ: Erlbaum.
- Fischer, K. W., & Bidell, T. (1991). Constraining nativist inferences about cognitive capacities. In S. Carey & R. Gelman (Eds.), *The epigenesis of mind: Essays on biology and cognition* (pp. 199–236). Hillsdale, NJ: Erlbaum.

- Fischer, K. W., & Bidell, T. R. (2006). Dynamic development of action, thought, and emotion. In R. M. Lerner (Ed.), *Handbook of child psychology. Vol. 1: Theoretical models of human development* (6th ed., pp. 319–399). New York: Wiley.
- Fischer, K. W., & Daley, S. G. (2007). Connecting cognitive science and neuroscience to education: Potentials and pitfalls in inferring executive processes. In L. Meltzer (Ed.), *Executive function in education: From theory to practice* (pp. 55–72). New York: Guilford Press.
- Fischer, K. W., & Immordino-Yang, M. H. (2002). Cognitive development and education: From dynamic general structure to specific learning and teaching. In E. Lagemann (Ed.), *Traditions of scholarship in education* (pp. 1–55). Chicago: Spencer Foundation.
- Fischer, K. W., Knight, C. C., & Van Parys, M. (1993). Analyzing diversity in developmental pathways: Methods and concepts. In R. Case & W. Edelman (Eds.), *The new structuralism in cognitive development: Theory and research on individual pathways* (pp. 33–56). Basel, Switzerland: Karger.
- Fisher, W. W., & Mazur, J. E. (1997). Basic and applied research on choice responding. *Journal of Applied Behavior Analysis, 30*, 387–410.
- Fiske, A. P., & Fiske, S. T. (2007). Social relationships in our species and cultures. In S. Kitayama & D. Cohen (Eds.), *Handbook of cultural psychology* (pp. 283–306). New York: Guilford Press.
- Fiske, D. W., & Maddi, S. R. (1961). *Functions of varied experience*. Homewood, IL: Dorsey.
- Fitzsimmons, G. M., & Finkel, E. J. (2010). Interpersonal influences on self-regulation. *Current Directions in Psychological Science, 19*, 101–105.
- Fivush, R., Haden, C., & Reese, E. (1996). Remembering, recounting, and reminiscing: The development of autobiographical memory in social context. In D. C. Rubin (Ed.), *Remembering our past: Studies in autobiographical memory* (pp. 341–359). Cambridge, England: Cambridge University Press.
- Fivush, R., Haden, C. A., & Reese, E. (2006). Elaborating on elaborations: Role of maternal reminiscing style in cognitive and socioemotional development. *Child Development, 77*, 1568–1588.
- Fivush, R., & Nelson, K. (2004). Culture and language in the emergence of autobiographical memory. *Psychological Science, 15*, 573–577.
- Flaherty, C. F. (1985). *Animal learning and cognition*. New York: Alfred Knopf.
- Flaherty, C. F., Uzwiak, A. J., Levine, J., Smith, M., Hall, P., & Schuler, R. (1980). Apparent hypoglycemic conditioned responses with exogenous insulin as the unconditioned stimulus. *Animal Learning and Behavior, 8*, 382–386.
- Flavell, J. H. (1963). *The developmental psychology of Jean Piaget*. New York: Van Nostrand Reinhold.
- Flavell, J. H. (1994). Cognitive development: Past, present, and future. In R. D. Parke, P. A. Ornstein, J. J. Rieser, & C. Zahn-Waxler (Eds.), *A century of developmental psychology* (pp. 569–587). Washington, DC: American Psychological Association.
- Flavell, J. H. (2000). Development of children's knowledge about the mental world. *International Journal of Behavioral Development, 24* (1), 15–23.
- Flavell, J. H., Friedrichs, A. G., & Hoyt, J. D. (1970). Developmental changes in memorization processes. *Cognitive Psychology, 1*, 324–340.
- Flavell, J. H., Green, F. L., & Flavell, E. R. (2000). Development of children's awareness of their own thoughts. *Journal of Cognitive Development, 1*, 97–112.
- Flavell, J. H., Miller, P. H., & Miller, S. A. (2002). *Cognitive development* (4th ed.). Upper Saddle River, NJ: Prentice Hall.
- Flege, J. E., Munro, M. J., & MacKay, I. R. A. (1995). Effects of age of second-language learning on the production of English consonants. *Speech Communication, 16* (1), 1–26.
- Fletcher, K. L., & Bray, N. W. (1996). External memory strategy use in preschool children. *Merrill-Palmer Quarterly, 42*, 379–396.
- Fletcher, K. L., & Cassidy, J. C. (2010). Overcoming academic anxieties: Promoting effective coping and self-regulation strategies. In J. C. Cassidy (Ed.), *Anxiety in schools: The causes, consequences, and solutions for academic anxieties* (pp. 177–200). New York: Peter Lang.
- Fletcher-Flinn, C. M., & Gravatt, B. (1995). The efficacy of computer-assisted instruction (CAD): A meta-analysis. *Journal of Educational Computing Research, 12*, 219–242.
- Flieller, A. (1999). Comparison of the development of formal thought in adolescent cohorts aged 10 to 15 years (1967–1996 and 1972–1993). *Developmental Psychology, 35*, 1048–1058.
- Flink, C., Boggiano, A. K., Main, D. S., Barrett, M., & Katz, P. A. (1992). Children's achievement-related behaviors: The role of extrinsic and intrinsic motivational orientations. In A. K. Boggiano & T. S. Pittman (Eds.), *Achievement and motivation: A social-developmental perspective* (pp. 189–214). Cambridge, England: Cambridge University Press.
- Flood, W. A., Wilder, D. A., Flood, A. L., & Masuda, A. (2002). Peer-mediated reinforcement plus prompting as treatment for off-task behavior in children with attention deficit hyperactivity disorder. *Journal of Applied Behavior Analysis, 35*, 199–204.
- Flower, L. S., & Hayes, J. R. (1981). A cognitive process theory of writing. *College Composition and Communication, 32*, 365–387.
- Flowerday, T., Schraw, G., & Stevens, J. (2004). The role of choice and interest in reader engagement. *Journal of Experimental Education, 72*, 93–114.
- Flum, H., & Kaplan, A. (2006). Exploratory orientation as an educational goal. *Educational Psychologist, 41*, 99–110.
- Foley, M. A., Harris, J., & Herman, S. (1994). Developmental comparisons of the ability to discriminate between memories for symbolic play enactments. *Developmental Psychology, 30*, 206–217.
- Foo, P., Warren, W. H., Duchon, A., & Tarr, M. J. (2005). Do humans integrate routes into a cognitive map? Map- versus landmark-based navigation of novel shortcuts. *Journal of Experimental Psychology: Learning, Memory, and Cognition, 31*, 195–215.
- Foos, P. W., & Fisher, R. P. (1988). Using tests as learning opportunities. *Journal of Educational Psychology, 80*, 179–183.
- Footo, A. L., & Crystal, J. D. (2007). Metacognition in the rat. *Current Biology, 17*, 551–555.
- Ford, M. E. (1996). Motivational opportunities and obstacles associated with social responsibility and caring behavior in school contexts. In J. Juvonen & K. R. Wentzel (Eds.), *Social motivation: Understanding children's school adjustment* (pp. 126–153). Cambridge, England: Cambridge University Press.
- Ford, M. E., & Nichols, C. W. (1991). Using goal assessments to identify motivational patterns and facilitate behavioral regulation and achievement. In M. Maehr & P. R. Pintrich (Eds.), *Advances in motivation and achievement: Vol. 7. Goals and self-regulatory processes* (pp. 51–84). Greenwich, CT: JAI Press.
- Ford, M. E., & Smith, P. R. (2007). Thriving with social purpose: An integrative approach to the development of optimal human functioning. *Educational Psychologist, 42*, 153–171.
- Forgas, J. P. (2000). The role of affect in social cognition. In J. Forgas (Ed.), *Feeling and thinking: The role of affect in social cognition* (pp. 1–28). New York: Cambridge University Press.
- Forgas, J. P. (2008). Affect and cognition. *Perspectives on Psychological Science, 3*, 94–101.
- Försterling, F., & Morgenstern, M. (2002). Accuracy of self-assessment and task performance: Does it pay to know the truth? *Journal of Educational Psychology, 94*, 576–585.
- Forsyth, J. P., & Eifert, G. H. (1998). Phobic anxiety and panic: An integrative behavioral account of their origin and treatment. In J. J. Plaud & G. H. Eifert (Eds.), *From behavior theory to behavior therapy* (pp. 38–67). Boston: Allyn & Bacon.
- Forte, E. (2010). Examining the assumptions underlying the NCLB federal accountability policy on school improvement. *Journal of Educational Psychology, 102*, 76–88.
- Foster-Johnson, L., Ferro, J., & Dunlap, G. (1994). Preferred curriculum activities and reduced problem behaviors in students with intellectual disabilities. *Journal of Applied Behavior Analysis, 27*, 493–504.
- Fowler, J. W., & Peterson, P. L. (1981). Increasing reading persistence and altering attributional style of learned helpless children. *Journal of Educational Psychology, 73*, 251–260.
- Fowler, S. A., & Baer, D. M. (1981). "Do I have to be good all day?" The timing of delayed

- reinforcement as a factor in generalization. *Journal of Applied Behavior Analysis*, 14, 13–24.
- Fox, E. (2009). The role of reader characteristics in processing and learning from informational text. *Review of Educational Research*, 79, 197–261.
- Fox, E. J. (2004). The personalized system of instruction: A flexible and effective approach to mastery learning. In D. J. Moran & R. W. Malott (Eds.), *Evidence-based educational methods* (pp. 201–221). San Diego, CA: Elsevier.
- Foxx, R. M., & Azrin, N. H. (1973). The elimination of autistic self-stimulatory behavior by overcorrection. *Journal of Applied Behavior Analysis*, 6, 1–14.
- Foxx, R. M., & Bechtel, D. R. (1983). Overcorrection: A review and analysis. In S. Axelrod & J. Apsche (Eds.), *The effects of punishment on human behavior* (pp. 133–220). New York: Academic Press.
- Frankel, F., & Simmons, J. Q. (1985). Behavioral treatment approaches to pathological unsocialized physical aggression in young children. *Journal of Child Psychiatry*, 26, 525–551.
- Frazier, B. N., Gelman, S. A., & Wellman, H. M. (2009). Preschoolers' search for explanatory information within adult-child conversation. *Child Development*, 80, 1592–1611.
- Frederiksen, J. R., & Collins, A. (1989). A systems approach to educational testing. *Educational Researcher*, 18 (9), 27–32.
- Frederiksen, N. (1984a). Implications of cognitive theory for instruction in problem-solving. *Review of Educational Research*, 54, 363–407.
- Frederiksen, N. (1984b). The real test bias: Influences of testing on teaching and learning. *American Psychologist*, 39, 193–202.
- Fredricks, J. A., Alfeld, C., & Eccles, J. (2010). Developing and fostering passion in academic and nonacademic domains. *Gifted Child Quarterly*, 54, 18–30.
- Fredricks, J. A., Blumenfeld, P. C., & Paris, A. H. (2004). School engagement: Potential of the concept, state of the evidence. *Review of Educational Research*, 74, 59–109.
- Fredrickson, B. (2009). *Positivity: Groundbreaking research reveals how to embrace the hidden strength of positive emotions, overcome negativity, and thrive*. New York: Crown Publishing.
- Freeman, K. E., Gutman, L. M., & Midgley, C. (2002). Can achievement goal theory enhance our understanding of the motivation and performance of African American young adolescents? In C. Midgley (Ed.), *Goals, goal structures, and patterns of adaptive learning* (pp. 175–204). Mahwah, NJ: Erlbaum.
- French, E. G. (1955). Some characteristics of achievement motivation. *Journal of Experimental Psychology*, 50, 232–236.
- French, E. G. (1956). Motivation as a variable in work partner selection. *Journal of Abnormal and Social Psychology*, 53, 96–99.
- Frensch, P. A., & Rüniger, D. (2003). Implicit learning. *Current Directions in Psychological Science*, 12, 13–18.
- Frenzel, A. C., Goetz, T., Lüdtke, O., Pekrun, R., & Sutton, R. E. (2009). Emotional transmission in the classroom: Exploring the relationship between teacher and student enjoyment. *Journal of Educational Psychology*, 101, 705–716.
- Freud, S. (1922). *Beyond the pleasure principle*. London: International Psychoanalytic Press.
- Freud, S. (1949). Instincts and their vicissitudes. In *Collected papers of Sigmund Freud* (Vol. 4, pp. 60–83) (J. Riviere, Trans.). London: Hogarth Press. (Original work published 1915)
- Freud, S. (1957). Repression. In J. Strachey (Ed.), *The standard edition of the complete psychological works of Sigmund Freud* (Vol. 14, pp. 146–158). London: Hogarth Press. (Original work published 1915)
- Freund, L. (1990). Maternal regulation of children's problem solving behavior and its impact on children's performance. *Child Development*, 61, 113–126.
- Friedman, N. P., Haberstick, B. C., Willcutt, E. G., Miyake, A., Young, S. E., Corley, R. P., et al. (2007). Greater attention problems during childhood predict poorer executive functioning in late adolescence. *Psychological Science*, 18, 893–900.
- Friedrich, L. K., & Stein, A. H. (1973). Aggressive and pro-social television programs and the natural behavior of preschool children. *Society for Research in Child Development Monographs*, 38 (Whole No. 151).
- Fries, S., Dietz, F., & Schmid, S. (2008). Motivational interference in learning: The impact of leisure alternatives on subsequent self-regulation. *Contemporary Educational Psychology*, 33, 119–133.
- Friman, P. C., & Poling, A. (1995). Making life easier with effort: Basic findings and applied research on response effort. *Journal of Applied Behavior Analysis*, 28, 583–590.
- Frith, U. (1978). From print to meaning and from print to sound, or how to read without knowing how to spell. *Visible Language*, 12, 43–54.
- Frith, U. (1980). Unexpected spelling problems. In U. Frith (Ed.), *Cognitive processes in spelling* (pp. 495–515). London: Academic Press.
- Frost, J. L., Shin, D., & Jacobs, P. J. (1998). Physical environments and children's play. In O. N. Saracho & B. Spodek (Eds.), *Multiple perspectives on play in early childhood education*. Albany: State University of New York Press.
- Fry, A. E., & Hale, S. (1996). Processing speed, working memory, and fluid intelligence. *Psychological Science*, 7, 237–241.
- Fuchs, D., Fuchs, L. S., Mathes, P. G., & Simmons, D. C. (1997). Peer-assisted learning strategies: Making classrooms more responsive to diversity. *American Educational Research Journal*, 34, 174–206.
- Fuchs, L. S., Compton, D. L., Fuchs, D., Hollenbeck, K. N., Craddock, C. F., & Hamlett, C. L. (2008). Dynamic assessment of algebraic learning in predicting third graders' development of mathematical problem solving. *Journal of Educational Psychology*, 100, 829–850.
- Fuchs, L. S., Fuchs, D., Karns, K., Hamlett, C. L., Dutka, S., & Katarzoff, M. (1996). The relation between student ability and the quality and effectiveness of explanations. *American Educational Research Journal*, 33, 631–664.
- Fuchs, L. S., Fuchs, D., Prentice, K., Burch, M., Hamlett, C. L., Owen, R., et al. (2003a). Enhancing third-grade students' mathematical problem solving with self-regulated learning strategies. *Journal of Educational Psychology*, 95, 306–315.
- Fuchs, L. S., Fuchs, D., Prentice, K., Burch, M., Hamlett, C. L., Owen, R., et al. (2003b). Explicitly teaching for transfer: Effects on third-grade students' mathematical problem solving. *Journal of Educational Psychology*, 95, 295–305.
- Fuchs, L. S., Fuchs, D., Prentice, K., Hamlett, C. L., Finelli, R., & Courey, S. J. (2004). Enhancing mathematical problem solving among third-grade students with schema-based instruction. *Journal of Educational Psychology*, 96, 635–647.
- Fuycyo, V., & Bushell, D., Jr. (1998). Using number line procedures and peer tutoring to improve the mathematics computation of low-performing first graders. *Journal of Applied Behavior Analysis*, 31, 417–430.
- Fujimura, N. (2001). Facilitating children's proportional reasoning: A model of reasoning processes and effects of intervention on strategy change. *Journal of Educational Psychology*, 93, 589–603.
- Fukkink, R. G., & de Gloppe, K. (1998). Effects of instruction in deriving word meanings from context: A meta-analysis. *Review of Educational Research*, 68, 450–469.
- Fuller, M. L. (2001). Multicultural concerns and classroom management. In C. A. Grant & M. L. Gomez, *Campus and classroom: Making schooling multicultural* (2nd ed., pp. 109–134). Upper Saddle River, NJ: Merrill/Prentice Hall.
- Furnham, A. (2003). Belief in a just world: Research progress over the past decade. *Personality and Individual Differences*, 34, 795–817.
- Furrer, C., & Skinner, E. (2003). Sense of relatedness as a factor in children's academic engagement and performance. *Journal of Educational Psychology*, 95, 148–162.
- Fuson, K. C., & Willis, G. B. (1989). Second graders' use of schematic drawings in solving addition and subtraction word problems. *Journal of Educational Psychology*, 81, 514–520.
- Gabriele, A. J. (2007). The influence of achievement goals on the constructive activity of low achievers during collaborative problem solving. *British Journal of Educational Psychology*, 77, 1221–141.
- Gabriele, A. J., & Montecinos, C. (2001). Collaborating with a skilled peer: The influence of achievement goals and perceptions of partner's competence on the participation and learning of low-achieving students. *Journal of Experimental Education*, 69, 152–178.
- Gabrieli, J. D. E., Keane, M. M., Zarella, M. M., & Poldrack, R. A. (1997). Preservation of implicit memory for new associations in global amnesia. *Psychological Science*, 8, 326–329.
- Gagné, E. D. (1985). *The cognitive psychology of school learning*. Boston: Little, Brown.

- Gagné, R. M. (1983). Some issues in the psychology of mathematics instruction. *Journal of Research in Mathematics Education*, 14 (1), 7–18.
- Gagné, R. M. (1985). *The conditions of learning and theory of instruction* (4th ed.). New York: Holt, Rinehart & Winston.
- Gagné, R. M., & Driscoll, M. P. (1988). *Essentials of learning for instruction* (2nd ed.). Englewood Cliffs, NJ: Prentice Hall.
- Gallimore, R., & Tharp, R. (1990). Teaching mind in society: Teaching, schooling, and literate discourse. In L. C. Moll (Ed.), *Vygotsky and education: Instructional implications and applications of sociohistorical psychology* (pp. 175–205). Cambridge, England: Cambridge University Press.
- Gallini, J. (2000, April). *An investigation of self-regulation developments in early adolescence: A comparison between non at-risk and at-risk students*. Paper presented at the annual meeting of the American Educational Research Association, New Orleans, LA.
- Gallistel, C. R., & Gibbon, J. (2001). Computational versus associative models of simple conditioning. *Current Directions in Psychological Science*, 10, 146–150.
- Garb, J. L., & Stunkard, A. J. (1974). Taste aversions in man. *American Journal of Psychiatry*, 131, 1204–1207.
- García, J., & Koelling, R. A. (1966). The relation of cue to consequence in avoidance learning. *Psychonomic Science*, 4, 123–124.
- García, S. M., & Tor, A. (2009). The N-effect: More competitors, less competition. *Psychological Science*, 20, 871–877.
- García-Mira, R., & Real, J. E. (2005). Environmental perception and cognitive maps. *International Journal of Psychology*, 40, 1–2.
- García-Palacios, A., Hoffman, H., Carlin, A., Furness, T. A., III, & Botella, C. (2002). Virtual reality in the treatment of spider phobia: A controlled study. *Behaviour Research and Therapy*, 40, 983–993.
- Gardner, A. W., Wacker, D. P., & Boelter, E. W. (2009). An evaluation of the interaction between quality of attention and negative reinforcement with children who display escape-maintained problem behavior. *Journal of Applied Behavior Analysis*, 42, 343–348.
- Gardner, H. (2000). *The disciplined mind: Beyond facts and standardized tests, the K–12 education that every child deserves*. New York: Penguin Books.
- Gardner, H., Torff, B., & Hatch, T. (1996). The age of innocence reconsidered: Preserving the best of the progressive traditions in psychology and education. In D. R. Olson & N. Torrance (Eds.), *The handbook of education and human development: New models of learning, teaching, and schooling* (pp. 28–55). Cambridge, MA: Blackwell.
- Gardner, M. (1978). *Aha! Insight*. New York: Scientific American.
- Garner, R. (1998). Epilogue: Choosing to learn or not-learn in school. *Educational Psychology Review*, 10, 227–237.
- Garner, R., Alexander, P. A., Gillingham, M. G., Kulikowich, J. M., & Brown, R. (1991). Interest and learning from text. *American Educational Research Journal*, 28, 643–659.
- Garry, M., & Gerrie, M. P. (2005). When photographs create false memories. *Current Directions in Psychological Science*, 14, 321–325.
- Gaskins, S. (1999). Children's daily lives in a Mayan village: A case study of culturally constructed roles and activities. In A. Göncü (Ed.), *Children's engagement in the world: Sociocultural perspectives* (pp. 25–61). Cambridge, England: Cambridge University Press.
- Gasper, K. L. (1980). The student perspective. *Teaching Political Science*, 7, 470–471.
- Gathercole, S. E., & Hitch, G. J. (1993). Developmental changes in short-term memory: A revised working memory perspective. In A. F. Collins, S. E. Gathercole, M. A. Conway, & P. E. Morris (Eds.), *Theories of memory* (pp. 189–209). Hove, England: Erlbaum.
- Gaudry, E., & Spielberger, C. D. (Eds.) (1971). *Anxiety and educational achievement*. Sydney, Australia: Wiley.
- Gauvain, M. (1999). Everyday opportunities for the development of planning skills: Sociocultural and family influences. In A. Göncü (Ed.), *Children's engagement in the world: Sociocultural perspectives* (pp. 173–201). Cambridge, England: Cambridge University Press.
- Gauvain, M. (2001). *The social context of cognitive development*. New York: Guilford Press.
- Gayford, C. (1992). Patterns of group behavior in open-ended problem solving in science classes of 15-year-old students in England. *Internal Journal of Science Education*, 14, 41–49.
- Gaynor, J., & Millham, J. (1976). Student performance and evaluation under variant teaching and testing methods in a large college course. *Journal of Educational Psychology*, 68, 312–317.
- Geary, D. C. (1994). *Children's mathematical development: Research and practical applications*. Washington, DC: American Psychological Association.
- Geary, D. C. (1998). What is the function of mind and brain? *Educational Psychology Review*, 10, 377–387.
- Geary, D. C. (2006). Development of mathematical understanding. In W. Damon & R. M. Lerner (Series Eds.), D. Kuhn, & R. Siegler (Vol. Eds.), *Handbook of child psychology: Vol. 2. Cognition, perception, and language* (6th ed., pp. 777–810). New York: Wiley.
- Geary, D. C. (2008). An evolutionarily informed education science. *Educational Psychologist*, 43, 179–195.
- Geckeler, A. S., Libby, M. E., Graff, R. B., & Ahearn, W. H. (2000). Effects of reinforcer choice measured in single-operant and concurrent-schedule procedures. *Journal of Applied Behavior Analysis*, 33, 347–351.
- Gehlbach, H., Brown, S. W., Ioannou, A., Boyer, M. A., Hudson, N., Niv-Solomon, A., et al. (2008). Increasing interest in social studies: Social perspective taking and self-efficacy in stimulating stimulations. *Contemporary Educational Psychology*, 33, 894–914.
- Geiger, K. B., LeBlanc, L. A., Dillon, C. M., & Bates, S. L. (2010). An evaluation of preference for video and in vivo modeling. *Journal of Applied Behavior Analysis*, 43, 279–283.
- Gelman, S. A. (2003). *The essential child: Origins of essentialism in everyday thought*. New York: Oxford University Press.
- Gelman, S. A., & Kalish, C. W. (2006). Conceptual development. In W. Damon & R. M. Lerner (Series Eds.), D. Kuhn, & R. Siegler (Vol. Eds.), *Handbook of child psychology: Vol. 2. Cognition, perception, and language* (6th ed., pp. 687–733). New York: Wiley.
- Gelman, S. A., & Koenig, M. A. (2003). Theory-based categorization in early childhood. In D. H. Rakison & L. M. Oakes (Eds.), *Early category and concept development: Making sense of the blooming, buzzing confusion* (pp. 330–359). Oxford, England: Oxford University Press.
- Gentile, J. R., & Lalley, J. P. (2003). *Standards and mastery learning: Aligning teaching assessment to all children can learn*. Thousand Oaks, CA: Corwin.
- Gentry, M., Gable, R. K., & Rizza, M. G. (2002). Students' perceptions of classroom activities: Are there grade-level and gender differences? *Journal of Educational Psychology*, 94, 539–544.
- Geraerts, E., Lindsay, D. S., Merckelbach, H., Jelicic, M., Raymaekers, L., Arnold, M. M., et al. (2009). Cognitive mechanisms underlying recovered-memory experiences of childhood sexual abuse. *Psychological Science*, 20, 92–98.
- Gerjets, P., & Scheiter, K. (2003). Goal configurations and processing strategies as moderators between instructional design and cognitive load: Evidence from hypertext-based instruction. *Educational Psychologist*, 38, 33–41.
- Gershkoff-Stowe, L., & Smith, L. B. (2004). Shape and the first hundred nouns. *Child Development*, 75, 1098–1114.
- Gerst, M. S. (1971). Symbolic coding processes in observational learning. *Journal of Personality and Social Psychology*, 19, 7–17.
- Ghetti, S. (2008). Rejection of false events in childhood: A metamemory account. *Current Directions in Psychological Science*, 17, 16–20.
- Ghetti, S., & Alexander, K. W. (2004). "If it happened, I would remember it": Strategic use of event memorability in the rejection of false autobiographical events. *Child Development*, 75, 542–561.
- Giaconia, R. M. (1988). Teacher questioning and wait-time (Doctoral dissertation, Stanford University, 1988). *Dissertation Abstracts International*, 49, 462A.
- Giancarlo, C. A., & Facione, P. A. (2001). A look across four years at the disposition toward critical thinking among undergraduate students. *Journal of General Education*, 50, 29–55.
- Gick, M. L., & Holyoak, K. J. (1980). Analogical problem solving. *Cognitive Psychology*, 12, 306–355.
- Gick, M. L., & Holyoak, K. J. (1987). The cognitive basis of knowledge transfer. In S. M. Cormier & J. D. Hagman (Eds.), *Transfer of*

- learning: *Contemporary research and applications* (pp. 9–46). San Diego, CA: Academic Press.
- Giedd, J. N., Blumenthal, J., Jeffries, N. O., Rajapakse, J. C., Vaituzis, A. C., Liu, H., Berry, Y. C., Tobin, M., Nelson, J., & Castellanos, F. X. (1999a). Development of the human corpus callosum during childhood and adolescence: A longitudinal MRI study. *Progress in Neuro-Psychopharmacology and Biological Psychiatry*, 23, 571–588.
- Giedd, J. N., Jeffries, N. O., Blumenthal, J., Castellanos, F. X., Vaituzis, A. C., Fernandez, T., Hamburger, S. D., Liu, H., Nelson, J., Bedwell, J., Tran, L., Lenane, M., Nicolson, R., & Rapoport, J. L. (1999b). Childhood-onset schizophrenia: Progressive brain changes during adolescence. *Biological Psychiatry*, 46, 892–898.
- Gijbels, D., Dochy, F., Van den Bossche, P., & Segers, M. (2005). Effects of problem-based learning: A meta-analysis from the angle of assessment. *Review of Educational Research*, 75, 27–61.
- Gil, L., Bråten, I., Vidal-Abarca, E., & Strømso, H. I. (2010). Summary versus argument tasks when working with multiple documents: Which is better for whom? *Contemporary Educational Psychology*, 35, 157–173.
- Gil, M., De Marco, R. J., & Menzel, R. (2007). Learning reward expectations in honeybees. *Learning and Memory*, 14, 491–496.
- Giles, J. W., Gopnik, A., & Heyman, G. D. (2002). Source monitoring reduces the suggestibility of preschool children. *Psychological Science*, 13, 288–291.
- Gillies, R. M. (2003). The behaviors, interactions, and perceptions of junior high school students during small-group learning. *Journal of Educational Psychology*, 95, 137–147.
- Gillies, R. M., & Ashman, A. F. (1998). Behavior and interactions of children in cooperative groups in lower and middle elementary grades. *Journal of Educational Psychology*, 90, 746–757.
- Gilman, R., Heubner, E. S., & Furlong, M. J. (Eds.) (2009). *Handbook of positive psychology in schools*. New York: Routledge.
- Gilstrap, L. L., & Ceci, S. J. (2005). Reconceptualizing children's suggestibility: Bidirectional and temporal properties. *Child Development*, 76, 40–53.
- Ginsburg, H. P., Cannon, J., Eisenband, J., & Pappas, S. (2006). Mathematical thinking and learning. In K. McCartney & D. Phillips (Eds.), *Blackwell handbook of early childhood development* (pp. 208–229). Malden, MA: Blackwell.
- Ginsburg, H. P., Lee, J. S., & Boyd, J. S. (2008). Mathematics education for young children: What it is and how to promote it. *Social Policy Report*, 22 (1) (Society for Research in Child Development).
- Ginsburg-Block, M. D., Rohrbeck, C. A., & Fantuzzo, J. W. (2006). A meta-analytic review of social, self-concept, and behavioral outcomes of peer-assisted learning. *Journal of Educational Psychology*, 98, 732–749.
- Giroto, V., & Light, P. (1993). The pragmatic bases of children's reasoning. In P. Light & G. Butterworth (Eds.), *Context and cognition: Ways of learning and knowing* (pp. 134–156). Hillsdale, NJ: Erlbaum.
- Gladwell, M. (2002). *The tipping point*. New York: Little, Brown.
- Gladwell, M. (2005). *Blink*. New York: Little, Brown.
- Glanzer, M., & Cunitz, A. R. (1966). Two storage mechanisms in free recall. *Journal of Verbal Learning and Verbal Behavior*, 5, 351–360.
- Glass, A. L., & Holyoak, K. J. (1975). Alternative conceptions of semantic memory. *Cognition*, 3, 313–339.
- Glass, A. L., Holyoak, K. J., & Santa, J. L. (1979). *Cognition*. Reading, MA: Addison-Wesley.
- Gleitman, H. (1985). Some trends in the study of cognition. In S. Koch & D. E. Leary (Eds.), *A century of psychology as science* (pp. 420–436). New York: McGraw-Hill.
- Glenberg, A. (1976). Monotonic and nonmonotonic lag effects in paired-associate and recognition memory paradigms. *Journal of Verbal Learning and Verbal Behavior*, 15, 1–16.
- Glenberg, A. M., Gutierrez, T., Levin, J. R., Japuntich, S., & Kaschak, M. P. (2004). Activity and imagined activity can enhance young children's reading comprehension. *Journal of Educational Psychology*, 96, 424–436.
- Glucksberg, S. (1962). The influence of strength of drive on functional fixedness and perceptual recognition. *Journal of Experimental Psychology*, 63, 36–41.
- Glucksberg, S., & Weisberg, R. W. (1966). Verbal behavior and problem solving: Some effects of labeling in a functional fixedness problem. *Journal of Experimental Psychology*, 71, 659–664.
- Glynn, S. M., & Di Vesta, F. J. (1977). Outline and hierarchical organization as aids for study and retrieval. *Journal of Educational Psychology*, 69, 89–95.
- Glynn, S. M., Yeany, R. H., & Britton, B. K. (Eds.) (1991). *The psychology of learning science*. Hillsdale, NJ: Erlbaum.
- Goddard, R. D. (2001). Collective efficacy: A neglected construct in the study of schools and student achievement. *Journal of Educational Psychology*, 93, 467–476.
- Goddard, R. D., Hoy, W. K., & Woolfolk Hoy, A. (2000). Collective teacher efficacy: Its meaning, measure, and impact on student achievement. *American Educational Research Journal*, 37, 479–507.
- Godden, D. R., & Baddeley, A. D. (1975). Context-dependent memory in two natural environments: On land and underwater. *British Journal of Psychology*, 66, 325–332.
- Goel, V., Tierney, M., Sheesley, L., Bartolo, A., Vartanian, O., & Grafman, J. (2007). Hemispheric specialization in human prefrontal cortex for resolving certain and uncertain inferences. *Cerebral Cortex*, 17, 2245–2250.
- Goetz, T., Frenzel, A. C., Hall, N. C., & Pekrun, R. (2008). Antecedents of academic emotions: Testing the internal/external frame of reference model for academic enjoyment. *Contemporary Educational Psychology*, 33, 9–33.
- Goetz, T., Frenzel, A. C., Pekrun, R., Hall, N. C., & Lüdtke, O. (2007). Between- and within-domain relations of students' academic emotions. *Journal of Educational Psychology*, 99, 715–733.
- Gold, J. M., Murray, R. F., Sekuler, A. B., Bennett, P. J., & Sekuler, R. (2005). Visual memory decay is deterministic. *Psychological Science*, 16, 769–774.
- Goldenberg, C. (1992). The limits of expectations: A case for case knowledge about teacher expectancy effects. *American Educational Research Journal*, 29, 517–544.
- Goldin-Meadow, S. (2006). Talking and thinking with our hands. *Current Directions in Psychological Science*, 15, 34–39.
- Goldin-Meadow, S. (2009). How gesture promotes learning through childhood. *Child Development Perspectives*, 3, 106–111.
- Goldin-Meadow, S., Cook, S. W., & Mitchell, Z. A. (2009). Gesturing gives children new ideas about math. *Psychological Science*, 20, 267–272.
- Goldman-Rakic, P. S. (1986). Setting the stage: Neural development before birth. In S. L. Friedman, K. A. Klivington, & R. W. Peterson (Eds.), *The brain, cognition, and education* (pp. 233–258). Orlando, FL: Academic Press.
- Goldman-Rakic, P. S. (1992). Working memory and the mind. *Scientific American*, 90, 111–117.
- Goldstein, N. E., Arnold, D. H., Rosenberg, J. L., Stowe, R. M., & Ortiz, C. (2001). Contagion of aggression in day care classrooms as a function of peer and teacher responses. *Journal of Educational Psychology*, 93, 708–719.
- Goldstone, R. L., & Johansen, M. K. (2003). Final commentary: Conceptual development from origins to asymptotes. In D. H. Rakison & L. M. Oakes (Eds.), *Early category and concept development: Making sense of the blooming, buzzing confusion* (pp. 403–418). Oxford, England: Oxford University Press.
- Golinkoff, R. M., & Hirsh-Pasek, K. (2006). Baby wordsmith: From associationistic to social sophisticate. *Current Directions in Psychological Science*, 15, 30–33.
- Gollwitzer, P. M., & Bargh, J. A. (2005). Automaticity in goal pursuit. In A. J. Elliot & C. S. Dweck (Eds.), *Handbook of competence and motivation* (pp. 624–646). New York: Guilford Press.
- Gonsalves, B., Reber, P. J., Gitelman, D. R., Parrish, T. B., Mesulam, M.-M., & Paller, K. A. (2004). Neural evidence that vivid imagining can lead to false remembering. *Psychological Science*, 15, 655–660.
- Good, T. L., & Brophy, J. E. (1994). *Looking in classrooms* (6th ed.). New York: HarperCollins.
- Good, T. L., McCaslin, M. M., & Reys, B. J. (1992). Investigating work groups to promote problem solving in mathematics. In J. Brophy (Ed.), *Advances in research on teaching: Vol. 3. Planning and managing learning tasks and activities* (pp. 115–160). Greenwich, CT: JAI Press.
- Good, T. L., & Nichols, S. L. (2001). Expectancy effects in the classroom: A special focus on improving the reading performance of minority

- students in first-grade classrooms. *Educational Psychologist*, 36, 113–126.
- Goodman, C. S., & Tessier-Lavigne, M. (1997). Molecular mechanisms of axon guidance and target recognition. In W. M. Cowan, T. M. Jessell, & S. L. Zipursky (Eds.), *Molecular and cellular approaches to neural development* (pp. 108–137). New York: Oxford University Press.
- Goodman, G. S., Ghetti, S., Quas, J. A., Edelstein, R. S., Alexander, K. W., Redlich, A. D., Cordon, I. M., & Jones, D. P. H. (2003). A prospective study of memory for child sexual abuse: New findings relevant to the repressed-memory controversy. *Psychological Science*, 14, 113–118.
- Goodman, G. S., & Quas, J. A. (2008). Repeated interviews and children's memory: It's more than just how many. *Current Directions in Psychological Science*, 17, 386–390.
- Gootman, M. E. (1998). Effective in-house suspension. *Educational Leadership*, 56 (1), 39–41.
- Gopnik, M. (Ed.) (1997). *The inheritance and innateness of grammars*. New York: Oxford University Press.
- Gorman, A. M. (1961). Recognition memory for nouns as a function of abstractness and frequency. *Journal of Experimental Psychology*, 61, 23–29.
- Goswami, U., & Pauen, S. (2005). The effects of a "family" analogy on class inclusion reasoning by young children. *Swiss Journal of Psychology*, 64 (2), 115–124.
- Gottfried, A. E. (1990). Academic intrinsic motivation in young elementary school children. *Journal of Educational Psychology*, 82, 525–538.
- Gottfried, A. E., Fleming, J. S., & Gottfried, A. W. (2001). Continuity of academic intrinsic motivation from childhood through late adolescence: A longitudinal study. *Journal of Educational Psychology*, 93, 3–13.
- Gould, E., Beylin, A., Tanapat, P., Reeves, A., & Shors, T. J. (1999). Learning enhances adult neurogenesis in the hippocampal formation. *Nature Neuroscience*, 2, 260–265.
- Grabe, M. (1986). Attentional processes in education. In G. D. Pyle & T. Andre (Eds.), *Cognitive classroom learning: Understanding, thinking, and problem solving* (pp. 49–82). Orlando, FL: Academic Press.
- Grace, D. M., David, B. J., & Ryan, M. K. (2008). Investigating preschoolers' categorical thinking about gender through imitation, attention, and the use of self-categories. *Child Development*, 79, 1928–1941.
- Graesser, A. C., & Bower, G. H. (Eds.) (1990). *Inferences and text comprehension. The psychology of learning and motivation: Advances in research and theory* (Vol. 25). Orlando: Academic Press.
- Graesser, A. C., McNamara, D. S., & VanLehn, K. (2005). Scaffolding deep comprehension strategies through Point&Query, AutoTutor, and iSTART. *Educational Psychologist*, 40, 225–234.
- Graesser, A. C., & Person, N. K. (1994). Question asking during tutoring. *American Educational Research Journal*, 31, 104–137.
- Graf, P., & Masson, M. E. J. (Eds.) (1993). *Implicit memory: New directions in cognition, development, and neuropsychology*. Hillsdale, NJ: Erlbaum.
- Graham, S. (1989). Motivation in Afro-Americans. In G. L. Berry & J. K. Asamen (Eds.), *Black students: Psychosocial issues and academic achievement* (pp. 40–68). Newbury Park, CA: Sage.
- Graham, S. (1990). Communicating low ability in the classroom: Bad things good teachers sometimes do. In S. Graham & V. S. Folkes (Eds.), *Attribution theory: Applications to achievement, mental health, and interpersonal conflict* (pp. 17–36). Hillsdale, NJ: Erlbaum.
- Graham, S. (1991). A review of attribution theory in achievement contexts. *Educational Psychology Review*, 3, 5–39.
- Graham, S. (1994). Classroom motivation from an attributional perspective. In H. F. O'Neil, Jr., & M. Drillings (Eds.), *Motivation: Theory and research* (pp. 31–48). Hillsdale, NJ: Erlbaum.
- Graham, S. (1997). Using attribution theory to understand social and academic motivation in African American youth. *Educational Psychologist*, 32, 21–34.
- Graham, S. (2006). Writing. In P. A. Alexander & P. H. Winne (Eds.), *Handbook of educational psychology* (2nd ed., pp. 457–478). Mahwah, NJ: Erlbaum.
- Graham, S., & Barker, G. (1990). The downside of help: An attributional-developmental analysis of helping behavior as a low ability cue. *Journal of Educational Psychology*, 82, 7–14.
- Graham, S., & Golen, S. (1991). Motivational influences on cognition: Task involvement, ego involvement, and depth of information processing. *Journal of Educational Psychology*, 83, 187–194.
- Graham, S., & Weiner, B. (1996). Theories and principles of motivation. In D. C. Berliner & R. C. Calfee (Eds.), *Handbook of educational psychology* (pp. 63–84). New York: Macmillan.
- Grant, H., & Dweck, C. S. (2001). Cross-cultural response to failure: Considering outcome attributions with different goals. In F. Salili, C.-Y. Chiu, & Y.-Y. Hong (Eds.), *Student motivation: The culture and context of learning* (pp. 203–219). New York: Kluwer/Plenum Press.
- Grant, H., & Dweck, C. S. (2003). Clarifying achievement goals and their impact. *Journal of Personality and Social Psychology*, 85, 541–553.
- Grauvogel-MacAleese, A. N., & Wallace, M. D. (2010). Use of peer-mediated intervention in children with attention deficit hyperactivity disorder. *Journal of Applied Behavior Analysis*, 43, 547–551.
- Gray, J. A., & Wedderburn, A. A. I. (1960). Grouping strategies with simultaneous stimuli. *Quarterly Journal of Experimental Psychology*, 12, 180–184.
- Gray, W. D., & Orasanu, J. M. (1987). Transfer of cognitive skills. In S. M. Cormier & J. D. Hagman (Eds.), *Transfer of learning: Contemporary research and applications* (pp. 184–215). San Diego, CA: Academic Press.
- Green, L., Fry, A. F., & Myerson, J. (1994). Discounting of delayed rewards: A life-span comparison. *Psychological Science*, 5, 33–36.
- Green, L., & Rachlin, H. (1977). Pigeon's preferences for stimulus information: Effects of amount of information. *Journal of the Experimental Analysis of Behavior*, 27, 255–263.
- Greene, B. A., & Royer, J. M. (1994). A developmental review of response time data that support a cognitive components model of reading. *Educational Psychology Review*, 6, 141–172.
- Greene, J. A., & Azevedo, R. (2009). A macro-level analysis of SRL processes and their relations to the acquisition of a sophisticated mental model of a complex system. *Contemporary Educational Psychology*, 34, 18–29.
- Greene, J. A., Torney-Purta, J., & Azevedo, R. (2010). Empirical evidence regarding relations among a model of epistemic and ontological cognition, academic performance, and educational level. *Journal of Educational Psychology*, 102, 234–255.
- Greene, R. L. (1986). Sources of recency effects in free recall. *Psychological Bulletin*, 99, 221–228.
- Greene, S., & Ackerman, J. M. (1995). Expanding the constructivist metaphor: A rhetorical perspective on literacy research and practice. *Review of Educational Research*, 65, 383–420.
- Greeno, J. G. (1991). A view of mathematical problem solving in school. In M. U. Smith (Ed.), *Toward a unified theory of problem solving: Views from the content domains* (pp. 69–98). Hillsdale, NJ: Erlbaum.
- Greeno, J. G. (2006). Learning in activity. In R. K. Sawyer (Ed.), *The Cambridge handbook of the learning sciences* (pp. 79–96). Cambridge, England: Cambridge University Press.
- Greeno, J. G., Collins, A. M., & Resnick, L. B. (1996). Cognition and learning. In D. C. Berliner & R. C. Calfee (Eds.), *Handbook of educational psychology* (pp. 15–46). New York: Macmillan.
- Greeno, J. G., Moore, J. L., & Smith, D. R. (1993). Transfer of situated learning. In D. K. Detterman & R. J. Sternberg (Eds.), *Transfer on trial: Intelligence, cognition, and instruction* (pp. 99–167). Norwood, NJ: Ablex.
- Greenough, W. T., Black, J. E., & Wallace, C. S. (1987). Experience and brain development. *Child Development*, 58, 539–559.
- Greenspoon, J., & Ranyard, R. (1957). Stimulus conditions and retroactive inhibition. *Journal of Experimental Psychology*, 53, 55–59.
- Greenwood, C. R., Carta, J. J., & Hall, R. V. (1988). The use of peer tutoring strategies in classroom management and educational instruction. *School Psychology Review*, 17, 258–275.
- Greer, R. D. (1983). Contingencies of the science and technology of teaching and pre-behavioristic research practices in education. *Educational Researcher*, 12 (1), 3–9.
- Gregoire, M. (2003). Is it a challenge or a threat? A dual-process model of teachers' cognition and appraisal processes during conceptual

- change. *Educational Psychology Review*, 15, 147–179.
- Gregory, A., Skiba, R. J., & Noguera, P. A. (2010). The achievement gap and the discipline gap: Two sides of the same coin? *Educational Researcher*, 39, 59–68.
- Greif, M. L., Kemler Nelson, D. G., Keil, F. C., & Gutierrez, F. (2006). What do children want to know about animals and artifacts? Domain-specific requests for information. *Psychological Science*, 17, 455–459.
- Greiner, J. M., & Karoly, P. (1976). Effects of self-control training on study activity and academic performance: An analysis of self-monitoring, self-reward, and systematic planning components. *Journal of Counseling Psychology*, 23, 495–502.
- Gresalfi, M. S. (2009). Taking up opportunities to learn: Constructing dispositions in mathematics classrooms. *Journal of the Learning Sciences*, 18, 327–369.
- Griffin, M. M., & Griffin, B. W. (1994, April). *Some can get there from here: Situated learning, cognitive style, and map skills*. Paper presented at the annual meeting of the American Educational Research Association, New Orleans, LA.
- Griffin, S. A., Case, R., & Capodilupo, A. (1995). Teaching for understanding: The importance of the central conceptual structures in the elementary mathematics curriculum. In A. McKeough, J. Lupart, & A. Marini (Eds.), *Teaching for transfer: Fostering generalization in learning* (pp. 123–151). Mahwah, NJ: Erlbaum.
- Grolnick, W. S., & Ryan, R. M. (1987). Autonomy in children's learning: An experimental and individual difference investigation. *Journal of Personality and Social Psychology*, 52, 890–898.
- Groninger, L. D. (1971). Mnemonic imagery and forgetting. *Psychonomic Science*, 23, 161–163.
- Gronlund, N. E., & Brookhart, S. M. (2009). *Gronlund's writing instructional objectives* (8th ed.). Upper Saddle River, NJ: Pearson/Merrill/Prentice Hall.
- Gross, T. F., & Mastenbrook, M. (1980). Examination of the effects of state anxiety on problem-solving efficiency under high and low memory conditions. *Journal of Educational Psychology*, 72, 605–609.
- Grossheinrich, N., Kademann, S., Bruder, J., Bartling, J., & von Suchodoletz, W. (2010). Auditory sensory memory and language abilities in former late talkers: A mismatch negativity study. *Psychophysiology*, 47, 822–830.
- Grossman, P. L. (1990). *The making of a teacher: Teacher knowledge and teacher education*. New York: Teachers College Press.
- Grofschedl, J., & Harms, U. (2010, April–May). *Fostering students' understanding of cell biology by using concept mapping and metacognitive prompting*. Paper presented at the annual meeting of the American Educational Research Association, Denver.
- Guberman, S. R., Rahm, J., & Menk, D. W. (1998). Transforming cultural practices: Illustrations from children's game play. *Anthropology and Education Quarterly*, 29, 419–445.
- Guerra, N. G., Huesmann, L. R., & Spindler, A. (2003). Community violence exposure, social cognition, and aggression among urban elementary school children. *Child Development*, 74, 1561–1576.
- Guevremont, D. C., Osnes, P. G., & Stokes, T. F. (1988). The functional role of preschoolers' verbalization in the generalization of self-instructional training. *Journal of Applied Behavior Analysis*, 21, 45–55.
- Gunnoe, M. L., & Mariner, C. L. (1997). Toward a developmental-contextual model of the effects of parental spanking on children's aggression. *Archives of Pediatrics and Adolescent Medicine*, 151, 768–775.
- Guskey, T. R. (1985). *Implementing mastery learning*. Belmont, CA: Wadsworth.
- Gustafsson, J., & Undheim, J. O. (1996). Individual differences in cognitive functions. In D. C. Berliner & R. C. Calfee (Eds.), *Handbook of educational psychology* (pp. 186–242). New York: Macmillan.
- Guthrie, E. R. (1935). *The psychology of learning*. New York: Harper & Row.
- Guzzetti, B. J., Snyder, T. E., Glass, G. V., & Gamas, W. S. (1993). Promoting conceptual change in science: A comparative meta-analysis of instructional interventions from reading education and science education. *Reading Research Quarterly*, 28, 117–159.
- Hacker, D. J. (1998a). Definitions and empirical foundations. In D. J. Hacker, J. Dunlosky, & A. C. Graesser (Eds.), *Metacognition in educational theory and practice* (pp. 1–23). Mahwah, NJ: Erlbaum.
- Hacker, D. J. (1998b). Self-regulated comprehension during normal reading. In D. J. Hacker, J. Dunlosky, & A. C. Graesser (Eds.), *Metacognition in educational theory and practice* (pp. 165–191). Mahwah, NJ: Erlbaum.
- Hacker, D. J., & Bol, L. (2004). Metacognitive theory: Considering the social-cognitive influences. In D. M. McNeerney & S. Van Etten (Eds.), *Big theories revisited* (pp. 275–297). Greenwich, CT: Information Age.
- Hacker, D. J., Bol, L., Horgan, D. D., & Rakow, E. A. (2009b). Test prediction and performance in a classroom context. *Journal of Educational Psychology*, 92, 160–170.
- Hacker, D. J., Dunlosky, J., & Graesser, A. C. (2009a). A growing sense of "agency." In D. J. Hacker, J. Dunlosky, & A. C. Graesser (Eds.), *Handbook of metacognition in education* (pp. 1–4). New York: Routledge.
- Hacker, D. J., Dunlosky, J., & Graesser, A. C. (Eds.) (2009b). *Handbook of metacognition in education*. New York: Routledge.
- Hacker, D. J., & Tenet, A. (2002). Implementing reciprocal teaching in the classroom: Overcoming obstacles and making modifications. *Journal of Educational Psychology*, 94, 699–718.
- Hadjoannou, X. (2007). Bringing the background to the foreground: What do classroom environments that support authentic discussions look like? *American Educational Research Journal*, 44, 370–399.
- Haenen, J. (1996). Piotr Gal'perin's criticism and extension of Lev Vygotsky's work. *Journal of Russian and East European Psychology*, 34 (2), 54–60.
- Haenen, J., Schrijnemakers, H., & Stufkens, J. (2003). Sociocultural theory and the practice of teaching historical concepts. In A. Kozulin, B. Gindis, V. S. Ageyev, & S. M. Miller (Eds.), *Vygotsky's educational theory in cultural context* (pp. 246–266). Cambridge, England: Cambridge University Press.
- Haerle, F. (2004, April). *Personal epistemologies of elementary school students: Their beliefs about knowledge and knowing*. Paper presented at the American Educational Research Association, San Diego, CA.
- Hagger, M. S., Chatzisarantis, N. L. D., Barkoukis, V., Wang, C. K. J., & Baranowski, J. (2005). Perceived autonomy support in physical education and leisure-time physical activity: A cross-cultural evaluation of the trans-contextual model. *Journal of Educational Psychology*, 97, 376–390.
- Haier, R. J. (2001). PET studies of learning and individual differences. In J. L. McClelland & R. S. Siegler (Eds.), *Mechanisms of cognitive development: Behavioral and neural perspectives* (pp. 123–145). Mahwah, NJ: Erlbaum.
- Hale-Benson, J. E. (1986). *Black children: Their roots, culture, and learning styles*. Baltimore: Johns Hopkins University Press.
- Halford, G. S., & Andrews, G. (2006). Reasoning and problem solving. In W. Damon & R. M. Lerner (Series Eds.), D. Kuhn, & R. Siegler (Vol. Eds.), *Handbook of child psychology: Vol. 2. Cognition, perception, and language* (6th ed., pp. 557–608). New York: Wiley.
- Hall, J. F. (1966). *The psychology of learning*. Philadelphia: J. B. Lippincott.
- Hall, J. F. (1971). *Verbal learning and retention*. Philadelphia: J. B. Lippincott.
- Hall, N. C., Chipperfield, J. G., Perry, R. P., Ruthig, J. C., & Goetz, T. (2006). Primary and secondary control in academic development: Gender-specific implications for stress and health in college students. *Anxiety, Stress, and Coping: An International Journal*, 19, 189–210.
- Hall, N. C., Goetz, T., Haynes, T. L., Stupnisky, R. H., & Chipperfield, J. G. (2006, April). *Self-regulation of primary and secondary control: Optimizing control striving in an academic achievement setting*. Paper presented at the annual meeting of the American Educational Research Association, San Francisco.
- Hall, N. C., Hladkyj, S., Perry, R. P., & Ruthig, J. C. (2004). The role of attributional retraining and elaborative learning in college students' academic development. *Journal of Social Psychology*, 144, 591–612.
- Hall, N. C., Hladkyj, S., Ruthig, J. C., Pekrun, R. H., & Perry, R. P. (2002, April). *The role of action control in moderating primary versus secondary control strategy use in college students*. Paper presented at the annual meeting of the American Educational Research Association, New Orleans, LA.
- Hall, N. C., Hladkyj, S., Taylor, J. R., & Perry, R. P. (2000, April). *Primary and secondary control: Empirical links to academic motivation, achievement, and failure*. Paper presented at the annual

- meeting of the American Educational Research Association, New Orleans, LA.
- Hall, N. C., Perry, R. P., Goetz, T., Ruthig, J. C., Stupnisky, R. H., & Newall, N. E. (2007). Attributional retraining and elaborative learning: Improving academic development through writing-based interventions. *Learning and Individual Differences, 17*, 280–290.
- Hall, N. C., Perry, R. P., Ruthig, J. C., Hladkyj, S., & Chipperfield, J. C. (2006). Primary and secondary control in achievement settings: A longitudinal field study of academic motivation, emotions, and performance. *Journal of Applied Social Psychology, 36*, 1430–1470.
- Hall, R. V., Axelrod, S., Foundopoulos, M., Shellman, J., Campbell, R. A., & Cranston, S. S. (1971). The effective use of punishment to modify behavior in the classroom. *Educational Technology, 11* (4), 24–26. Reprinted in K. D. O’Leary & S. O’Leary (Eds.) (1972). *Classroom management: The successful use of behavior modification*. New York: Pergamon.
- Hall, V. C., & Edmondson, B. (1992). Relative importance of aptitude and prior domain knowledge on immediate and delayed posttests. *Journal of Educational Psychology, 84*, 219–223.
- Hallén, O., Scheja, M., & Haglund, L. (2008). The contextual use of knowledge: An intentional approach to meaning making and conceptual change. In S. Vosniadou (Ed.), *International handbook on conceptual change* (pp. 509–532). New York: Routledge.
- Hallenbeck, M. J. (2002). Taking charge: Adolescents with learning disabilities assume responsibility for their own writing. *Learning Disability Quarterly, 25*, 227–246.
- Haller, E. P., Child, D. A., & Walberg, H. J. (1988). Can comprehension be taught? A quantitative synthesis of “metacognitive” studies. *Educational Researcher, 17* (9), 5–8.
- Halpern, D. F. (1997). *Critical thinking across the curriculum: A brief edition of thought and knowledge*. Mahwah, NJ: Erlbaum.
- Halpern, D. F. (1998). Teaching critical thinking for transfer across domains: Dispositions, skills, structure, training, and metacognitive monitoring. *American Psychologist, 53*, 449–455.
- Halpern, D. F. (2008). Is intelligence critical thinking? Why we need a new definition of intelligence. In P. C. Kyllonen, R. D. Roberts, & L. Stankov (Eds.), *Extending intelligence: Enhancement and new constructs* (pp. 349–370). New York: Erlbaum/Taylor & Francis.
- Halpin, G., & Halpin, G. (1982). Experimental investigations of the effects of study and testing on student learning, retention, and ratings of instruction. *Journal of Educational Psychology, 74*, 32–38.
- Hambrick, D. Z., & Engle, R. W. (2003). The role of working memory in problem solving. In J. E. Davidson & R. J. Sternberg (Eds.), *The psychology of problem solving* (pp. 176–206). Cambridge, England: Cambridge University Press.
- Hamman, D., Berthelot, J., Saia, J., & Crowley, E. (2000). Teachers’ coaching of learning and its relation to students’ strategic learning. *Journal of Educational Psychology, 92*, 342–348.
- Hamman, D., Shell, D. F., Droesch, D., Husman, J., Handwerk, M., Park, Y., et al. (1995, April). *Middle school readers’ on-line cognitive processes: Influence of subject-matter knowledge and interest during reading*. Paper presented at the annual meeting of the American Educational Research Association, San Francisco.
- Hammer, D. (1994). Epistemological beliefs in introductory physics. *Cognition and Instruction, 12*, 151–183.
- Hammer, D. (1997). Discovery learning and discovery teaching. *Cognition and Instruction, 15*, 485–529.
- Hammer, D., & Elby, A. (2002). On the form of a personal epistemology. In B. K. Hofer & P. R. Pintrich (Eds.), *Personal epistemology: The psychology of beliefs about knowledge and knowing* (pp. 169–190). Mahwah, NJ: Erlbaum.
- Hampson, S. E. (2008). Mechanisms by which childhood personality traits influence adult well-being. *Current Directions in Psychological Science, 17*, 264–268.
- Hanna, A., & Remington, R. (1996). The representation of color and form in long-term memory. *Memory and Cognition, 24*, 322–330.
- Hansen, J., & Pearson, P. D. (1983). An instructional study: Improving the inferential comprehension of good and poor fourth-grade readers. *Journal of Educational Psychology, 75*, 821–829.
- Harackiewicz, J. M., Barron, K. E., Tauer, J. M., Carter, S. M., & Elliot, A. J. (2000). Short-term and long-term consequences of achievement goals: Predicting interest and performance over time. *Journal of Educational Psychology, 92*, 316–330.
- Harackiewicz, J. M., Durik, A. M., Barron, K. E., Linnenbrink-Garcia, L., & Tauer, J. M. (2008). The role of achievement goals in the development of interest: Reciprocal relations between achievement goals, interest, and performance. *Journal of Educational Psychology, 100*, 105–122.
- Hardré, P. L., Crowson, H. M., DeBacker, T. K., & White, D. (2007). Predicting the motivation of rural high school students. *Journal of Experimental Education, 75*, 247–269.
- Hardré, P. L., & Reeve, J. (2003). A motivational model of rural students’ intentions to persist in, versus drop out of, high school. *Journal of Educational Psychology, 95*, 347–356.
- Hardy, I., Jonen, A., Möller, K., & Stern, E. (2006). Effects of instructional support within constructivist learning environments for elementary school students’ understanding of “floating and sinking.” *Journal of Educational Psychology, 98*, 307–326.
- Hareli, S., & Weiner, B. (2002). Social emotions and personality inferences: A scaffold for a new direction in the study of achievement motivation. *Educational Psychologist, 37*, 183–193.
- Haring, N. G., & Liberty, K. A. (1990). Matching strategies with performance in facilitating generalization. *Focus on Exceptional Children, 22* (8), 1–16.
- Harlow, H. F. (1949). The formation of learning sets. *Psychological Review, 56*, 51–65.
- Harlow, H. F. (1950). Analysis of discrimination learning by monkeys. *Journal of Experimental Psychology, 40*, 26–39.
- Harlow, H. F. (1959). Learning set and error factor theory. In S. Koch (Ed.), *Psychology: A study of science* (Vol. 2, pp. 492–537). New York: McGraw-Hill.
- Harlow, H. F., & Zimmerman, R. R. (1959). Affectional responses in the infant monkey. *Science, 130*, 421–432.
- Harmon-Jones, E. (2001). The role of affect in cognitive-dissonance processes. In J. P. Forgas (Ed.), *Handbook of affect and social cognition* (pp. 237–255). Mahwah, NJ: Erlbaum.
- Harris, J. A., Miniussi, C., Harris, I. M., & Diamond, M. E. (2002). Transient storage of a tactile memory trace in primary somatosensory cortex. *Journal of Neuroscience, 22*, 8720–8725.
- Harris, K. R. (1986). Self-monitoring of attentional behavior versus self-monitoring of productivity: Effects of on-task behavior and academic response rate among learning disabled children. *Journal of Applied Behavior Analysis, 19*, 417–423.
- Harris, K. R., & Alexander, P. A. (1998). Integrated, constructivist education: Challenge and reality. *Educational Psychology Review, 10*, 115–127.
- Harris, K. R., Graham, S., Brindle, M., & Sandmel, K. (2009). Metacognition and children’s writing. In D. J. Hacker, J. Dunlosky, & A. C. Graesser (Eds.), *Handbook of metacognition in education* (pp. 131–153). New York: Routledge.
- Harris, K. R., Santangelo, T., & Graham, S. (2010). Metacognition and strategies instruction in writing. In H. S. Waters & W. Schneider (Eds.), *Metacognition, strategy use, and instruction* (pp. 226–256). New York: Guilford Press.
- Harris, P. L. (2006). Social cognition. In W. Damon & R. M. Lerner (Series Eds.), D. Kuhn, & R. Siegler (Vol. Eds.), *Handbook of child psychology: Vol. 2. Cognition, perception, and language* (6th ed., pp. 811–858). New York: Wiley.
- Harris, R. J. (1977). Comprehension of pragmatic implications in advertising. *Journal of Applied Psychology, 62*, 603–608.
- Harter, S. (1990). Causes, correlates, and the functional role of global self-worth: A lifespan perspective. In R. J. Sternberg & J. Kolligian, Jr. (Eds.), *Competence considered* (pp. 67–97). New Haven, CT: Yale University Press.
- Harter, S. (1992). The relationship between perceived competence, affect, and motivational orientation within the classroom: Processes and patterns of change. In A. K. Boggiano & T. S. Pittman (Eds.), *Achievement and motivation: A social-developmental perspective* (pp. 77–114). Cambridge, England: Cambridge University Press.
- Harter, S. (1996). Teacher and classmate influences on scholastic motivation, self-esteem,



- and level of voice in adolescents. In J. Juvonen & K. Wentzel (Eds.), *Social motivation: Understanding children's school adjustment* (pp. 11–42). New York: Cambridge University Press.
- Harter, S. (1999). *The construction of the self: A developmental perspective*. New York: Guilford Press.
- Harter, S., Stocker, C., & Robinson, N. S. (1996). The perceived directionality of the link between approval and self-worth: The liabilities of a looking glass self-orientation among young adolescents. *Journal of Research on Adolescence, 6*, 285–308.
- Harter, S., Whitesell, N. R., & Kowalski, P. (1992). Individual differences in the effects of educational transitions on young adolescents' perceptions of competence and motivational orientation. *American Educational Research Journal, 29*, 777–807.
- Hartley, J., Bartlett, S., & Branthwaite, A. (1980). Underlining can make a difference—sometimes. *Journal of Educational Research, 73*, 218–224.
- Hartley, J., & Trueman, M. (1982). The effects of summaries on the recall of information from prose: Five experimental studies. *Human Learning, 1*, 63–82.
- Hartley, K., & Bendixen, L. D. (2001). Educational research in the Internet age: Examining the role of individual characteristics. *Educational Researcher, 30* (9), 22–26.
- Hartmann, W. K., Miller, R., & Lee, P. (1984). *Out of the cradle: Exploring the frontiers beyond earth*. New York: Workman.
- Hartup, W. W. (1983). Peer relations. In P. H. Mussen (Series Ed.) & E. M. Hetherington (Vol. Ed.), *Handbook of child psychology: Vol. 4. Socialization, personality, and social development* (pp. 103–196). New York: Wiley.
- Haseman, A. L. (1999, April). *Cross talk: How students' epistemological beliefs impact the learning process in a constructivist course*. Paper presented at the annual meeting of the American Educational Research Association, Montreal.
- Hasher, L., & Zacks, R. T. (1984). Automatic processing of fundamental information. *American Psychologist, 39*, 1372–1388.
- Hasher, L., Zacks, R. T., & May, C. P. (1999). Inhibitory control, circadian arousal, and age. In D. Gopher & A. Koriati (Eds.), *Attention and performance XVII: Cognitive regulation of performance: Interaction of theory and application* (pp. 653–675). Cambridge, MA: MIT Press.
- Haskell, R. E. (2001). *Transfer of learning: Cognition, instruction, and reasoning*. San Diego, CA: Academic Press.
- Hatano, G., & Inagaki, K. (1991). Sharing cognition through collective comprehension activity. In L. B. Resnick, J. M. Levine, & S. D. Teasley (Eds.), *Perspectives on socially shared cognition* (pp. 331–348). Washington, DC: American Psychological Association.
- Hatano, G., & Inagaki, K. (1993). Desituating cognition through the construction of conceptual knowledge. In P. Light & G. Butterworth (Eds.), *Context and cognition: Ways of learning and knowing* (pp. 115–133). Hillsdale, NJ: Erlbaum.
- Hatano, G., & Inagaki, K. (2003). When is conceptual change intended? A cognitive-sociocultural view. In G. M. Sinatra & P. R. Pintrich (Eds.), *Intentional conceptual change* (pp. 407–427). Mahwah, NJ: Erlbaum.
- Hattie, J. (2008). Processes of integrating, developing, and processing self information. In H. W. Marsh, R. G. Craven, & D. M. McInerney (Eds.), *Self-processes, learning, and enabling human potential* (pp. 51–85). Charlotte, NC: Information Age.
- Hattie, J. A. C. (2009). *Visible learning: A synthesis of over 800 meta-analyses relating to achievement*. London: Routledge.
- Hattie, J., Biggs, J., & Purdie, N. (1996). Effects of learning skills interventions on student learning: A meta-analysis. *Review of Educational Research, 66*, 99–136.
- Hattie, J., & Timperley, H. (2007). The power of feedback. *Review of Educational Research, 77*, 81–112.
- Haugwitz, M., Sumfleth, E., & Sandmann, A. (2010, April–May). *The influence of cognitive mapping on achievement in biology: Considering cognitive abilities as moderator*. Paper presented at the annual meeting of the American Educational Research Association, Denver.
- Hay, I., Ashman, A. E., van Kraayenoord, C. E., & Stewart, A. L. (1999). Identification of self-verification in the formation of children's academic self-concept. *Journal of Educational Psychology, 91*, 225–229.
- Hayes, D. A., & Henk, W. A. (1986). Understanding and remembering complex prose augmented by analogic and pictorial illustration. *Journal of Reading Behavior, 18*, 63–78.
- Hayes, K. J., & Hayes, C. (1952). Imitation in a home-raised chimpanzee. *Journal of Comparative and Physiological Psychology, 45*, 450–459.
- Hayes, S. C., Rosenfarb, I., Wulfert, E., Munt, E. D., Korn, Z., & Zettle, R. D. (1985). Self-reinforcement effects: An artifact of social standard setting? *Journal of Applied Behavior Analysis, 18*, 201–214.
- Hayes-Roth, B., & Thorndyke, P. W. (1979). Integration of knowledge from text. *Journal of Verbal Learning and Verbal Behavior, 18*, 91–108.
- Hayne, H., Barr, R., & Herbert, J. (2003). The effect of prior practice on memory reactivation and generalization. *Child Development, 74*, 1615–1627.
- Haywood, H. C., & Lidz, C. S. (2007). *Dynamic assessment in practice: Clinical and educational applications*. Cambridge, England: Cambridge University Press.
- Head, L. S., & Gross, A. M. (2009). Systematic desensitization. In W. T. O'Donohue & J. E. Fisher (Eds.), *General principles and empirically supported techniques of cognitive behavior therapy* (pp. 640–647). Hoboken, NJ: Wiley.
- Heal, N. A., Hanley, G. P., & Layer, S. A. (2009). An evaluation of the relative efficacy of and children's preferences for teaching strategies that differ in amount of teacher directedness. *Journal of Applied Behavior Analysis, 42*, 123–143.
- Healey, M. K., Campbell, K. L., Hasher, L., & Osher, L. (2010). Direct evidence for the role of inhibition in resolving interference in memory. *Psychological Science, 21*, 1464–1470.
- Heatherington, T. F., Macrae, C. N., & Kelley, W. M. (2004). What the social brain sciences can tell us about the self. *Current Directions in Psychological Science, 13*, 190–193.
- Hebb, D. O. (1955). Drives and the c. n. s. (conceptual nervous system). *Psychological Review, 62*, 243–254.
- Hecht, S. A., & Vagi, K. J. (2010). Sources of group and individual differences in emerging fraction skills. *Journal of Educational Psychology, 102*, 843–859.
- Heck, A., Collins, J., & Peterson, L. (2001). Decreasing children's risk taking on the playground. *Journal of Applied Behavior Analysis, 34*, 349–352.
- Hegarty, M., & Kozhevnikov, M. (1999). Types of visual-spatial representations and mathematical problem solving. *Journal of Educational Psychology, 91*, 684–689.
- Heil, M., Rösler, F., & Hennighausen, E. (1994). Dynamics of activation in long-term memory: The retrieval of verbal, pictorial, spatial, and color information. *Journal of Experimental Psychology: Learning, Memory, and Cognition, 20*, 169–184.
- Heindel, P., & Kose, G. (1990). The effects of motoric action and organization on children's memory. *Journal of Experimental Child Psychology, 50*, 416–428.
- Heine, S. J. (2007). Culture and motivation: What motivates people to act in the ways that they do? In S. Kitayama & D. Cohen (Eds.), *Handbook of cultural psychology* (pp. 714–733). New York: Guilford Press.
- Helmke, A. (1989). Affective student characteristics and cognitive development: Problems, pitfalls, perspectives. *International Journal of Educational Research, 13*, 915–932.
- Hembree, R. (1988). Correlates, causes, effects, and treatment of test anxiety. *Review of Educational Research, 58*, 47–77.
- Hemmings, A. B. (2004). *Coming of age in U.S. high schools: Economic, kinship, religious, and political crosscurrents*. Mahwah, NJ: Erlbaum.
- Hemphill, L., & Snow, C. (1996). Language and literacy development: Discontinuities and differences. In D. R. Olson & N. Torrance (Eds.), *The handbook of education and human development: New models of learning, teaching, and schooling* (pp. 173–201). Cambridge, MA: Blackwell.
- Henderlong, J., & Lepper, M. R. (2000, April). *The effects of praise on children's motivation: Person, product, and process feedback*. Paper presented at the annual meeting of the American Educational Research Association, New Orleans, LA.
- Hennessey, B. A. (1995). Social, environmental, and developmental issues and creativity. *Educational Psychology Review, 7*, 163–183.
- Hennessey, B. A., & Amabile, T. M. (1987). *Creativity and learning*. Washington, DC: National Education Association.
- Hennessey, M. G. (2003). Metacognitive aspects of students' reflective discourse: Implications

- for intentional conceptual change teaching and learning. In G. M. Sinatra & P. R. Pintrich (Eds.), *Intentional conceptual change* (pp. 103–132). Mahwah, NJ: Erlbaum.
- Heppner, W. L., Kernis, M. H., Nezelek, J. B., Foster, J., Lakey, C. E., & Goldman, B. M. (2008). Within-person relationships among daily self-esteem, need satisfaction, and authenticity. *Psychological Science, 19*, 1140–1145.
- Herbert, J. J., & Harsh, C. M. (1944). Observational learning by cats. *Journal of Comparative Psychology, 37*, 81–95.
- Heron, W. (1957). The pathology of boredom. *Scientific American, 196* (1), 52–56.
- Herrenkohl, L. R., & Guerra, M. R. (1998). Participant structures, scientific discourse, and student engagement in fourth grade. *Cognition and Instruction, 16*, 431–473.
- Herrnstein, R. J. (1977). The evolution of behaviorism. *American Psychologist, 32*, 593–603.
- Heuer, F., & Reisberg, D. (1990). Vivid memories of emotional events: The accuracy of remembered minutiae. *Memory and Cognition, 18*, 496–506.
- Heuer, F., & Reisberg, D. (1992). Emotion, arousal, and memory for detail. In S. Christianson (Ed.), *Handbook of emotion and memory* (pp. 151–180). Hillsdale, NJ: Erlbaum.
- Hewitt, J., Brett, C., Scardamalia, M., Frecker, K., & Webb, J. (1995, April). *Schools for thought: Transforming classrooms into learning communities*. Paper presented at the annual meeting of the American Educational Research Association, San Francisco.
- Hewitt, J., & Scardamalia, M. (1998). Design principles for distributed knowledge building processes. *Educational Psychology Review, 10*, 75–96.
- Heyman, G. D. (2008). Children's critical thinking when learning from others. *Current Directions in Psychological Science, 17*, 344–347.
- Heyman, G. D., Fu, G., & Lee, K. (2007). Evaluating claims people make about themselves: The development of skepticism. *Child Development, 78*, 367–375.
- Heyman, G. D., Gee, C. L., & Giles, J. W. (2003). Preschool children's reasoning about ability. *Child Development, 74*, 516–534.
- Hickey, D. T. (1997). Motivation and contemporary socio-constructivist instructional perspectives. *Educational Psychologist, 32*, 175–193.
- Hickey, D. T., & Granade, J. B. (2004). The influence of sociocultural theory on our theories of engagement and motivation. In D. M. McNeerney & S. Van Etten (Eds.), *Big theories revisited* (pp. 223–247). Greenwich, CT: Information Age.
- Hidi, S., & Harackiewicz, J. M. (2000). Motivating the academically unmotivated: A critical issue for the 21st century. *Review of Educational Research, 70*, 151–179.
- Hidi, S., & Renninger, K. A. (2006). The four-phase model of interest development. *Educational Psychologist, 41*, 111–127.
- Hidi, S., Renninger, K. A., & Krapp, A. (2004). Interest, a motivational variable that combines affecting and cognitive functioning. In D. Y. Dai & R. J. Sternberg (Eds.), *Motivation, emotion, and cognition: Integrative perspectives on intellectual functioning and development* (pp. 89–115). Mahwah, NJ: Erlbaum.
- Hidi, S., Weiss, J., Berndorff, D., & Nolan, J. (1998). The role of gender, instruction, and a cooperative learning technique in science education across formal and informal settings. In L. Hoffman, A. Krapp, K. Renninger, & J. Baumert (Eds.), *Interest and learning: Proceedings of the Secon Conference on interest and gender* (pp. 215–227). Kiel, Germany: IPN.
- Hiebert, J., Carpenter, T. P., Fennema, E., Fuson, K., Human, P., Murray, H., Olivier, A., & Wearne, D. (1996). Problem solving as a basis for reform in curriculum and instruction: The case of mathematics. *Educational Researcher, 25* (4), 12–21.
- Hiebert, J., Carpenter, T. P., Fennema, E., Fuson, K. C., Wearne, D., Murray, H., Olivier, A., & Human, P. (1997). *Making sense: Teaching and learning mathematics with understanding*. Portsmouth, NH: Heinemann.
- Hiebert, J., & Wearne, D. (1992). Links between teaching and learning place value with understanding in first grade. *Journal for Research in Mathematics Education, 23*, 98–122.
- Hiebert, J., & Wearne, D. (1993). Instructional tasks, classroom discourse, and students' learning in second-grade arithmetic. *American Educational Research Journal, 30*, 393–425.
- Hiebert, J., & Wearne, D. (1996). Instruction, understanding, and skill in multidigit addition and subtraction. *Cognition and Instruction, 14*, 251–283.
- Higgins, A. T., & Turnure, J. E. (1984). Distractibility and concentration of attention in children's development. *Child Development, 55*, 1799–1810.
- Hill, C. A. (1987). Affiliation motivation: People who need people . . . but in different ways. *Journal of Personality and Social Psychology, 52*, 1008–1018.
- Hill, K. T. (1984). Debilitating motivation and testing: A major educational problem, possible solutions, and policy applications. In R. Ames & C. Ames (Eds.), *Research on motivation in education: Vol. 1. Student motivation* (pp. 245–274). New York: Academic Press.
- Hill, K. T., & Wigfield, A. (1984). Test anxiety: A major educational problem and what can be done about it. *Elementary School Journal, 85*, 105–126.
- Hills, T. T., Maouene, M., Maouene, J., Sheya, A., & Smith, L. (2009). Longitudinal analysis of early semantic networks: Preferential attachment or preferential acquisition? *Psychological Science, 20*, 729–739.
- Hilt, L. M. (2005, April). *The effects of attribution retraining on class performance, achievement motivation, and attributional style in high school students*. Poster presented at the biennial meeting of the Society for Research in Child Development, Atlanta, GA.
- Hinkley, J. W., McNeerney, D. M., & Marsh, H. W. (2001, April). *The multifaceted structure of school achievement motivation: A case for social goals*. Paper presented at the annual meeting of the American Educational Research Association, Seattle, WA.
- Hinnant, J. B., O'Brien, M., & Ghazarian, S. R. (2009). The longitudinal relations of teacher expectations to achievement in the early school years. *Journal of Educational Psychology, 101*, 662–670.
- Hiroto, D. S., & Seligman, M. E. P. (1975). Generality of learned helplessness in man. *Journal of Personality and Social Psychology, 31*, 311–327.
- Hirsch, E. D., Jr. (1996). *The schools we need and why we don't have them*. New York: Doubleday.
- Hirstein, W. (2005). *Brain fiction: Self-deception and the riddle of confabulation*. Cambridge, MA: MIT Press/Bradford.
- Hmelo-Silver, C. E. (2004). Problem-based learning: What and how do students learn? *Educational Psychology Review, 16*, 235–266.
- Hmelo-Silver, C. E. (2006). Design principles for scaffolding technology-based inquiry. In A. M. O'Donnell, C. E. Hmelo-Silver, & G. Erkens (Eds.), *Collaborative learning, reasoning, and technology* (pp. 147–170). Mahwah, NJ: Erlbaum.
- Hmelo-Silver, C. E., Duncan, R. G., & Chinn, C. A. (2007). Scaffolding and achievement in problem-based and inquiry learning: A response to Kirschner, Sweller, and Clark (2006). *Educational Psychologist, 42*, 99–107.
- Hofer, B. K. (2000). Dimensionality and disciplinary differences in personal epistemology. *Contemporary Educational Psychology, 25*, 378–405.
- Hofer, B. K. (2004). Epistemological understanding as a metacognitive process: Thinking aloud during online searching. *Educational Psychologist, 39*, 43–55.
- Hofer, B. K., & Pintrich, P. R. (1997). The development of epistemological theories: Beliefs about knowledge and knowing and their relation to learning. *Review of Educational Research, 67*, 88–140.
- Hofer, M. (2010). Adolescents' development of individual interests: A product of multiple goal regulation? *Educational Psychologist, 45*, 149–166.
- Hoffman, B. (2010). "I think I can, but I'm afraid to try": The role of self-efficacy beliefs and mathematics anxiety in mathematics problem-solving efficiency. *Learning and Individual Differences, 20*, 276–283.
- Hoffman, B., & Spataru, A. (2008). The influence of self-efficacy and metacognitive prompting on math problem-solving efficiency. *Contemporary Educational Psychology, 33*, 875–893.
- Hoffman, M. L. (1975). Altruistic behavior and the parent-child relationship. *Journal of Personality and Social Psychology, 31*, 937–943.
- Hoffman, M. L. (2000). *Empathy and moral development: Implications for caring and justice*. New York: Cambridge University Press.
- Hofman, R., & van Oostendorp, H. (1999). Cognitive effects of a structured overview in a hypertext. *British Journal of Educational Technology, 30*, 129–140.
- Hogan, D. M., & Tudge, J. R. H. (1999). Implications of Vygotsky's theory for peer

- learning. In A. M. O'Donnell & A. King (Eds.), *Cognitive perspectives on peer learning* (pp. 39–65). Mahwah, NJ: Erlbaum.
- Hogan, K. (1997, March). *Relating students' personal frameworks for science learning to their cognition in collaborative contexts*. Paper presented at the annual meeting of the American Educational Research Association, Chicago.
- Hogan, K., Nastasi, B. K., & Pressley, M. (2000). Discourse patterns and collaborative scientific reasoning in peer and teacher-guided discussions. *Cognition and Instruction, 17*, 379–432.
- Hokoda, A., & Fincham, F. D. (1995). Origins of children's helplessness and mastery achievement patterns in the family. *Journal of Educational Psychology, 87*, 375–385.
- Holland, R. W., Hendriks, M., & Aarts, H. (2005). Smells like clean spirit: Nonconscious effects of scent on cognition and behavior. *Psychological Science, 16*, 689–693.
- Holley, C. D., & Dansereau, D. F. (1984). *Spatial learning strategies: Techniques, applications, and related issues*. Orlando, FL: Academic Press.
- Holliday, B. G. (1985). Towards a model of teacher-child transactional processes affecting black children's academic achievement. In M. B. Spencer, G. K. Brookins, & W. R. Allen (Eds.), *Beginnings: The social and affective development of black children* (pp. 117–130). Hillsdale, NJ: Erlbaum.
- Holliday, R. E. (2003). Reducing misinformation effects in children with cognitive interviews: Dissociating recollection and familiarity. *Child Development, 74*, 728–751.
- Hollis, K. L. (1997). Contemporary research on Pavlovian conditioning: A "new" functional analysis. *American Psychologist, 52*, 956–965.
- Holt-Reynolds, D. (1992). Personal history-based beliefs as relevant prior knowledge in course work. *American Educational Research Journal, 29*, 325–349.
- Holyoak, K. J., & Koh, K. (1987). Surface and structural similarity in analogical transfer. *Memory and Cognition, 15*, 332–340.
- Hom, A., & Battistich, V. (1995, April). *Students' sense of school community as a factor in reducing drug use and delinquency*. Paper presented at the annual meeting of the American Educational Research Association, San Francisco.
- Homme, L. E., deBaca, P. C., Devine, J. V., Steinhorst, R., & Rickert, E. J. (1963). Use of the Premack principle in controlling the behavior of nursery school children. *Journal of the Experimental Analysis of Behavior, 6*, 544.
- Hong, E., O'Neil, H. F., & Feldon, D. (2005). Gender effects on mathematics achievement: Mediating role of state and trait self-regulation. In A. M. Gallagher & J. C. Kaufman (Eds.), *Gender differences in mathematics: An integrative psychological approach* (pp. 264–293). Cambridge, England: Cambridge University Press.
- Hopf, T., & Ayres, J. (1992). Coping with public speaking anxiety: An examination of various combinations of systematic desensitization, skills training, and visualization. *Journal of Applied Communication Research, 20*, 183–198.
- Horgan, D. (1990, April). *Students' predictions of test grades: Calibration and metacognition*. Paper presented at the annual meeting of the American Educational Research Association, Boston.
- Horn, J. L. (2008). Spearman, g, expertise, and the nature of human cognitive capability. In P. C. Kyllonen, R. D. Roberts, & L. Stankov (Eds.), *Extending intelligence: Enhancement and new constructs* (pp. 185–230). New York: Erlbaum/Taylor & Francis.
- Horowitz, F. D., Darling-Hammond, L., & Bransford, J. (with Comer, J., Rosebrock, K., Austin, K., & Rust, F.) (2005). Educating teachers for developmentally appropriate practice. In L. Darling-Hammond & J. Bransford (Eds.), *Preparing teachers for a changing world: What teachers should learn and be able to do* (pp. 88–125). San Francisco: Jossey-Bass/Wiley.
- Horst, J. S., Oakes, L. M., & Madole, K. L. (2005). What does it look like and what can it do? Category structure influences how infants categorize. *Child Development, 76*, 614–631.
- Horwitz, E. K., Tallon, M., & Luo, H. (2010). Foreign language anxiety. In J. C. Cassady (Ed.), *Anxiety in schools: The causes, consequences, and solutions for academic anxieties* (pp. 95–115). New York: Peter Lang.
- Howard, D. V. (1983). *Cognitive psychology: Memory, language, and thought*. New York: Macmillan.
- Howe, C., Tolmie, A., Greer, K., & Mackenzie, M. (1995). Peer collaboration and conceptual growth in physics: Task influences on children's understanding of heating and cooling. *Cognition and Instruction, 13*, 483–503.
- Howe, M. L. (2003). Memories from the cradle. *Current Directions in Psychological Science, 12*, 62–65.
- Howe, M. L., & O'Sullivan, J. T. (1990). The development of strategic memory: Coordinating knowledge, metamemory, and resources. In D. F. Bjorklund (Ed.), *Children's strategies: Contemporary views of cognitive development* (pp. 129–155). Hillsdale, NJ: Erlbaum.
- Howie, J. D. (2002, April). *Effects of audience, gender, and achievement level on adolescent students' communicated attributions and affect in response to academic success and failure*. Paper presented at the annual meeting of the American Educational Research Association, New Orleans, FL.
- Hsee, C. K., Yang, A. X., & Wang, L. (2010). Idleness aversion and the need for justifiable busyness. *Psychological Science, 21*, 926–930.
- Hsieh, P.-H. P., & Schallert, D. L. (2008). Implications from self-efficacy and attribution theories for an understanding of undergraduates' motivation in a foreign language course. *Contemporary Educational Psychology, 33*, 513–532.
- Hu, P., Stylos-Allan, M., & Walker, M. P. (2006). Sleep facilitates consolidation of emotional declarative memory. *Psychological Science, 17*, 891–898.
- Hubbs-Tait, L., Nation, J. R., Krebs, N. F., & Bellinger, D. C. (2005). Neurotoxicants, micronutrients, and social environments: Individual and combined effects on children's development. *Psychological Science in the Public Interest, 6*, 57–121.
- Hubel, D. H., Wiesel, T. N., & Levay, S. (1977). Plasticity of ocular dominance columns in monkey striate cortex. *Philosophical Transactions of the Royal Society of London, B* 278, 307–409.
- Hudson, T. (1983). Correspondences and numerical differences between disjoint sets. *Child Development, 54*, 84–90.
- Hudspeth, W. J. (1985). Developmental neuropsychology: Functional implications of quantitative EEG maturation [Abstract]. *Journal of Clinical and Experimental Neuropsychology, 7*, 606.
- Huey, E. D., Krueger, F., & Grafman, J. (2006). Representations in the human prefrontal cortex. *Current Directions in Psychological Science, 15*, 167–171.
- Huff, J. A. (1988). Personalized behavior modification: An in-school suspension program that teaches students how to change. *School Counselor, 35*, 210–214.
- Huff, N. C., & LaBar, K. S. (2010). Generalization and specialization of conditioning learning. In M. T. Banich & D. Caccamise (Eds.), *Generalization of knowledge: Multidisciplinary perspectives* (pp. 3–29). New York: Psychology Press.
- Hufton, N., Elliott, J., & Illushin, L. (2002). Achievement motivation across cultures: Some puzzles and their implications for future research. *New Directions for Child and Adolescent Development, 96*, 65–85.
- Hughes, J. N. (1988). *Cognitive behavior therapy with children in schools*. New York: Pergamon.
- Hull, C. L. (1920). Quantitative aspects of the evolution of concepts: An experimental study. *Psychological Monographs, 28* (Whole No. 123).
- Hull, C. L. (1938). The goal-gradient hypothesis applied to some "field-force" problems in the behavior of young children. *Psychological Review, 45*, 271–299.
- Hull, C. L. (1943). *Principles of behavior: An introduction to behavior theory*. New York: Appleton-Century-Crofts.
- Hull, C. L. (1951). *Essentials of behavior*. New Haven, CT: Yale University Press.
- Hull, C. L. (1952). *A behavior system: An introduction to behavior theory concerning the individual organism*. New Haven, CT: Yale University Press.
- Hulleman, C. S., Godes, O., Hendricks, B. L., & Harackiewicz, J. M. (2010). Enhancing interest and performance with a utility value intervention. *Journal of Educational Psychology, 102*, 880–895.
- Humphreys, L. G. (1939). Acquisition and extinction of verbal expectations in a situation analogous to conditioning. *Journal of Experimental Psychology, 25*, 294–301.
- Hundert, J. (1976). The effectiveness of reinforcement, response cost, and mixed programs on classroom behaviors. *Journal of Applied Behavior Analysis, 9*, 107.
- Hung, W., Jonassen, D. H., & Liu, R. (2008). Problem-based learning. In J. M. Spector, M.

- D. Merrill, J. van Merriënboer, & M. P. Driscoll (Eds.), *Handbook of research on educational communications and technology* (3rd ed., pp. 485–506). New York: Erlbaum.
- Hunt, R. R., & Worthen, J. B. (Eds.) (2006). *Distinctiveness and memory*. Oxford, England: Oxford University Press.
- Hursh, D. (2007). Assessing No Child Left Behind and the rise of neoliberal education policies. *American Educational Research Journal*, 44, 493–518.
- Husman, J., & Freeman, B. (1999, April). *The effect of perceptions of instrumentality on intrinsic motivation*. Paper presented at the annual meeting of the American Educational Research Association, Montreal.
- Huston, A. C. (1983). Sex-typing. In E. M. Hetherington (Ed.), *Handbook of child psychology: Vol. 4. Socialization, personality, and social development* (4th ed., pp. 387–467). New York: Wiley.
- Huston, A. C., Watkins, B. A., & Kunkel, D. (1989). Public policy and children's television. *American Psychologist*, 44, 424–433.
- Hutt, S. J., Tyler, S., Hutt, C., & Christopherson, H. (1989). Play, exploration, and learning: A natural history of the pre-school. London: Routledge.
- Huttenlocher, J., & Lourenco, S. F. (2007). Using spatial categories to reason about location. In J. M. Plumert & J. P. Spencer (Eds.), *The emerging spatial mind* (pp. 3–24). New York: Oxford University Press.
- Huttenlocher, P. R. (1979). Synaptic density in human frontal cortex—Developmental changes and effects of aging. *Brain Research*, 163, 195–205.
- Huttenlocher, P. R. (1990). Morphometric study of human cerebral cortex development. *Neuropsychologia*, 28, 517–527.
- Huttenlocher, P. R. (1993). Morphometric study of human cerebral cortex development. In M. H. Johnson (Ed.), *Brain development and cognition: A reader* (pp. 117–128). Cambridge, MA: Blackwell.
- Huttenlocher, P. R., & Dabholkar, A. S. (1997). Regional differences in synaptogenesis in human cerebral cortex. *Journal of Comparative Neurology*, 387, 167–178.
- Hyde, K. L., Lerch, J., Norton, A., Forgeard, M., Winner, E., Evans, A. C., et al. (2009). Musical training shapes structural brain development. *Journal of Neuroscience*, 29, 3019–3025.
- Hyde, T. S., & Jenkins, J. J. (1969). Differential effects of incidental tasks on the organization of recall of a list of highly associated words. *Journal of Experimental Psychology*, 82, 472–481.
- Hyman, I., Mahon, M., Cohen, I., Snook, P., Britton, G., & Lurkis, L. (2004). Student alienation syndrome: The other side of school violence. In J. C. Conoley & A. P. Goldstein (Eds.), *School violence intervention* (2nd ed., pp. 483–506). New York: Guilford Press.
- Hymel, S., Comfort, C., Schonert-Reichl, K., & McDougall, P. (1996). Academic failure and school dropout: The influence of peers. In J. Juvonen & K. R. Wentzel (Eds.), *Social motivation: Understanding children's school adjustment* (pp. 313–345). Cambridge, England: Cambridge University Press.
- Hynd, C. (1998a). Conceptual change in a high school physics class. In B. Guzzetti & C. Hynd (Eds.), *Perspectives on conceptual change: Multiple ways to understand knowing and learning in a complex world* (pp. 27–36). Mahwah, NJ: Erlbaum.
- Hynd, C. (1998b). Observing learning from different perspectives: What does it mean for Barry and his understanding of gravity? In B. Guzzetti & C. Hynd (Eds.), *Perspectives on conceptual change: Multiple ways to understand knowing and learning in a complex world* (pp. 235–244). Mahwah, NJ: Erlbaum.
- Hynd, C. (2003). Conceptual change in response to persuasive messages. In G. M. Sinatra & P. R. Pintrich (Eds.), *Intentional conceptual change* (pp. 291–315). Mahwah, NJ: Erlbaum.
- Iacoboni, M., & Woods, R. P. (1999). Cortical mechanisms of human imitation. *Science*, 286, 2526–2528.
- Igoa, C. (1995). *The inner world of the immigrant child*. Mahwah, NJ: Erlbaum.
- Immordino-Yang, M. H., & Sylvan, L. (2010). Admiration for virtue: Neuroscientific perspectives on a motivating emotion. *Contemporary Educational Psychology*, 35, 110–115.
- Inagaki, K., & Hatano, G. (2006). Young children's conception of the biological world. *Current Directions in Psychological Science*, 15, 177–181.
- Inagaki, K., & Hatano, G. (2008). Conceptual change in naive biology. In S. Vosniadou (Ed.), *International handbook on conceptual change* (pp. 240–262). New York: Routledge.
- Inglehart, M., Brown, D. R., & Vida, M. (1994). Competition, achievement, and gender: A stress theoretical analysis. In P. R. Pintrich, D. R. Brown, & C. E. Weinstein (Eds.), *Student motivation, cognition, and learning: Essays in honor of Wilbert J. McKeachie* (pp. 311–329). Hillsdale, NJ: Erlbaum.
- Inglis, A., & Biemiller, A. (1997, March). *Fostering self-direction in mathematics: A cross-age tutoring program that enhances math problem solving*. Paper presented at the annual meeting of the American Educational Research Association, Chicago.
- Inhelder, B., & Piaget, J. (1958). *The growth of logical thinking from childhood to adolescence* (A. Parsons & S. Milgram, Trans.). New York: Basic Books.
- Intons-Peterson, M. J., Russell, W., & Dressel, S. (1992). The role of pitch in auditory imagery. *Journal of Experimental Psychology: Human Perception and Performance*, 18, 233–240.
- Inzlicht, M., & Ben-Zeev, T. (2003). Do high-achieving female students underperform in private? The implications of threatening environments on intellectual processing. *Journal of Educational Psychology*, 95, 796–805.
- Irwin, D. E. (1996). Integrating information across saccadic eye movements. *Current Directions in Psychological Science*, 5, 94–100.
- Isaacowitz, D. M. (2006). Motivated gaze: The view from the gazer. *Current Directions in Psychological Science*, 15, 68–72.
- Isaacson, R. L. (1964). Relation between achievement, test anxiety, and curricular choices. *Journal of Abnormal and Social Psychology*, 68, 447–452.
- Ito, T. A., & Cacioppo, J. T. (2001). Affect and attitudes: A social neuroscience approach. In J. P. Forgas (Ed.), *Handbook of affect and social cognition* (pp. 50–74). Mahwah, NJ: Erlbaum.
- Iwata, B. A., & Bailey, J. S. (1974). Reward versus cost token systems: An analysis of the effects on student and teacher. *Journal of Applied Behavior Analysis*, 7, 567–576.
- Iwata, B. A., Pace, G. M., Cowdery, G. E., & Miltenberger, R. G. (1994). What makes extinction work: An analysis of procedural form and function. *Journal of Applied Behavior Analysis*, 27, 131–144.
- Iyengar, S. S., & Lepper, M. R. (1999). Rethinking the value of choice: A cultural perspective on intrinsic motivation. *Journal of Personality and Social Psychology*, 76, 349–366.
- Jacob, B. A. (2003). Accountability, incentives, and behavior: The impact of high-stakes testing in the Chicago Public Schools. *Education Next*, 3 (1). Retrieved March 10, 2004, from <http://www.educationnext.org/unabridged/20031/jacob.pdf>.
- Jacobs, J. E., Davis-Kean, P., Bleeker, M., Eccles, J. S., & Malanchuk, O. (2005). "I can, but I don't want to": The impact of parents, interests, and activities on gender differences in math. In A. M. Gallagher & J. C. Kaufman (Eds.), *Gender differences in mathematics: An integrative psychological approach* (pp. 246–263). Cambridge, England: Cambridge University Press.
- Jacobs, J. E., Lanza, S., Osgood, D. W., Eccles, J. S., & Wigfield, A. (2002). Changes in children's self-competence and values: Gender and domain differences across grades one through twelve. *Child Development*, 73, 509–527.
- Jacobsen, L. K., Giedd, J. N., Berquin, P. C., Krain, A. L., Hamburger, S. D., Kumra, S., & Rapoport, J. L. (1997a). Quantitative morphology of the cerebellum and fourth ventricle in childhood-onset schizophrenia. *American Journal of Psychiatry*, 154, 1663–1669.
- Jacobsen, L. K., Giedd, J. N., Castellanos, F. X., Vaituzis, A. C., Hamburger, S. D., Kumra, S., Lenane, M. C., & Rapoport, J. L. (1997b). Progressive reduction of temporal lobe structures in childhood-onset schizophrenia. *American Journal of Psychiatry*, 155, 678–685.
- Jacoby, K. (2008). *Shadows at dawn: A borderlands massacre and the violence of history*. New York: Penguin.
- Jaeggi, S. M., Buschkuhl, M., Jonides, J., & Perrig, W. (2008). Improving fluid intelligence with training on working memory. *Proceedings of the National Academy of Sciences, USA*, 105, 6829–6833.
- Jagacinski, C. M., Kumar, S., & Boe, J. L. (2003, April). *The 2 x 2 structure of achievement goal orientations: Applications in the college classroom*. Paper presented at the annual meeting of the American Educational Research Association, Chicago.
- Jagacinski, C. M., Kumar, S., Lam, H., & Lustenberger, D. E. (2008, March). *An exploratory*

- study of work avoidance in the college classroom. Paper presented at the annual meeting of the American Educational Research Association, New York.
- Jagacinski, C. M., & Nicholls, J. (1984). Conceptions of ability and related affects in task involvement and ego involvement. *Journal of Educational Psychology, 76*, 909–919.
- Jagacinski, C. M., & Nicholls, J. (1987). Competence and affect in task involvement and ego involvement: The impact of social comparison information. *Journal of Educational Psychology, 79*, 107–114.
- Jagacinski, C. M., & Nicholls, J. G. (1990). Reducing effort to protect perceived ability: "They'd do it but I wouldn't." *Journal of Educational Psychology, 82*, 15–21.
- Jain, S., & Dowson, M. (2009). Mathematics anxiety as a function of multidimensional self-regulation and self-efficacy. *Contemporary Educational Psychology, 34*, 240–249.
- James, W. (1890). *Principles of psychology*. New York: Holt.
- Jameson, M. M. (2010). Math anxiety: Theoretical perspectives on potential influences and outcomes. In J. C. Cassady (Ed.), *Anxiety in schools: The causes, consequences, and solutions for academic anxieties* (pp. 45–58). New York: Peter Lang.
- Jang, H. (2008). Supporting students' motivation, engagement, and learning during an uninteresting activity. *Journal of Educational Psychology, 100*, 798–811.
- Jang, H., Reeve, J., & Deci, E. L. (2010). Engaging students in learning activities: It is not autonomy support or structure but autonomy support and structure. *Journal of Educational Psychology, 102*, 588–600.
- Jara, E., Vila, J., & Maldonado, A. (2006). Second-order conditioning of human causal learning. *Learning and Motivation, 37*, 230–246.
- Jarmolowicz, D. P., Hayashi, Y., & Pipkin, C. S. P. (2010). Temporal patterns of behavior from the scheduling of psychology quizzes. *Journal of Applied Behavior Analysis, 43*, 297–301.
- Jegede, O. J., & Olajide, J. O. (1995). Wait-time, classroom discourse, and the influence of sociocultural factors in science teaching. *Science Education, 79*, 233–249.
- Jenkins, J. J., & Russell, W. A. (1952). Associative clustering during recall. *Journal of Abnormal and Social Psychology, 47*, 818–821.
- Jenlink, C. L. (1994, April). *Music: A lifeline for the self-esteem of at-risk students*. Paper presented at the annual meeting of the American Educational Research Association, New Orleans, LA.
- Jetton, T. L., & Dole, J. A. (Eds.) (2004). *Adolescent literacy research and practice*. New York: Guilford Press.
- Jiang, B. (2010). English language learners: Understanding their needs. In G. S. Goodman (Ed.), *Educational psychology reader: The art and science of how people learn* (pp. 179–194). New York: Peter Lang.
- Johnson, B. M., Miltenberger, R. G., Knudson, P., Emego-Helm, K., Kelso, P., Jostad, C., & Langley, L. (2006). A preliminary evaluation of two behavioral skills training procedures for teaching abduction-prevention skills to schoolchildren. *Journal of Applied Behavior Analysis, 39*, 25–34.
- Johnson, D. W., & Johnson, R. T. (1985). Motivational processes in cooperative, competitive, and individualistic learning situations. In C. Ames & R. Ames (Eds.), *Research on motivation in education: Vol. 2. The classroom milieu* (pp. 249–286). Orlando, FL: Academic Press.
- Johnson, D. W., & Johnson, R. T. (1991). *Learning together and alone: Cooperative, competitive, and individualistic learning* (3rd ed.). Upper Saddle River, NJ: Prentice Hall.
- Johnson, D. W., & Johnson, R. T. (2009a). An educational psychology success story: Social interdependence theory and cooperative learning. *Educational Researcher, 38*, 365–379.
- Johnson, D. W., & Johnson, R. T. (2009b). Energizing learning: The instructional power of conflict. *Educational Researcher, 38*, 37–51.
- Johnson, K. E., Alexander, J. M., Spencer, S., Leibham, M. E., & Neitzel, C. (2004). Factors associated with the early emergence of intense interests within conceptual domains. *Cognitive Development, 19*, 325–343.
- Johnson, M. K. (2006). Memory and reality. *American Psychologist, 61*, 760–771.
- Johnson, M. K., Bransford, J. D., & Solomon, S. K. (1973). Memory for tacit implications of sentences. *Journal of Experimental Psychology, 98*, 203–205.
- Johnson, R. L., Penny, J. A., & Gordon, B. (2009). *Assessing performance: Designing, scoring, and validating performance tasks*. New York: Guilford Press.
- Johnson, R. S., Mims-Cox, J. S., & Doyle-Nichols, A. (2006). *Developing portfolios in education: A guide to reflection, inquiry, and assessment*. Thousand Oaks, CA: Sage.
- Johnson, S. K., & Anderson, M. C. (2004). The role of inhibitory control in forgetting semantic knowledge. *Psychological Science, 15*, 448–453.
- Johnson-Glenberg, M. C. (2000). Training reading comprehension in adequate decoders/poor comprehenders: Verbal versus visual strategies. *Journal of Educational Psychology, 92*, 772–782.
- John-Steiner, V., & Mahn, H. (1996). Sociocultural approaches to learning and development: A Vygotskian framework. *Educational Psychologist, 31*, 191–206.
- Johnston, J. C., McCann, R. S., & Remington, R. W. (1995). Chronometric evidence for two types of attention. *Psychological Science, 6*, 365–369.
- Jonassen, D. H., Hannum, W. H., & Tessmer, M. (1989). *Handbook of task analysis procedures*. New York: Praeger.
- Jonassen, D. H., Hartley, J., & Trueman, M. (1986). The effects of learner-generated versus text-provided headings on immediate and delayed recall and comprehension: An exploratory study. *Human Learning, 5*, 139–150.
- Jones, E. E., & Berglas, S. (1978). Control of attributions about the self through self-handicapping strategies: The appeal of alcohol and the role of underachievement. *Personality and Social Psychology Bulletin, 4*, 200–206.
- Jones, H. E., & English, H. B. (1926). Notional vs. rote memory. *American Journal of Psychology, 37*, 602–603.
- Jones, K. M., Drew, H. A., & Weber, N. L. (2000). Noncontingent peer attention as treatment for disruptive classroom behavior. *Journal of Applied Behavior Analysis, 33*, 343–346.
- Jones, M. C. (1924). The elimination of children's fears. *Journal of Experimental Psychology, 7*, 382–390.
- Jones, M. S., Levin, M. E., Levin, J. R., & Beitzel, B. D. (2000). Can vocabulary-learning strategies and pair-learning formats be profitably combined? *Journal of Educational Psychology, 92*, 256–262.
- Jones, S. S. (2007). Imitation in infancy: The development of mimicry. *Psychological Science, 18*, 593–599.
- Jones, V. (1996). Classroom management. In J. Sikula, T. J. Buttery, & E. Guyton (Eds.), *Handbook of research on teacher education* (2nd ed., pp. 503–521). New York: Macmillan.
- Jonides, J., Lacey, S. C., & Nee, D. E. (2005). Processes of working memory in mind and brain. *Current Directions in Psychological Science, 14*, 2–5.
- Jordan, A. B. (2003). Children remember prosocial program lessons but how much are they learning? *Applied Developmental Psychology, 24*, 341–345.
- Joseph, J. E., Liu, X., Jiang, Y., Lynam, D., & Kelly, T. H. (2009). Neural correlates of emotional reactivity in sensation seeking. *Psychological Science, 20*, 215–223.
- Josephs, R. A., Newman, M. L., Brown, R. P., & Beer, J. M. (2003). Status, testosterone, and human intellectual performance: Stereotype threat as status concern. *Psychological Science, 14*, 158–163.
- Judd, C. H. (1932). *Autobiography*. In C. Murchison (Ed.), *History of psychology in autobiography* (Vol. 2). Worcester, MA: Clark University Press.
- Jussim, L., Eccles, J., & Madon, S. (1996). Social perception, social stereotypes, and teacher expectations: Accuracy and the quest for the powerful self-fulfilling prophecy. In M. P. Zanna (Ed.), *Advances in experimental social psychology* (Vol. 28, pp. 281–388). New York: Academic Press.
- Just, M. A., Carpenter, P. A., Keller, T. A., Emery, L., Zajac, H., & Thulborn, K. R. (2001). Interdependence of nonoverlapping cortical systems in dual cognitive tasks. *NeuroImage, 14*, 417–426.
- Juvonen, J. (1996). Self-presentation tactics promoting teacher and peer approval: The function of excuses and other clever explanations. In J. Juvonen & K. R. Wentzel (Eds.), *Social motivation: Understanding children's school adjustment* (pp. 43–65). Cambridge, England: Cambridge University Press.
- Juvonen, J. (2000). The social functions of attributional face-saving tactics among early adolescents. *Educational Psychology Review, 12*, 15–32.

- Juvonen, J., & Weiner, B. (1993). An attributional analysis of students' interactions: The social consequences of perceived responsibility. *Educational Psychology Review*, 5, 325–345.
- Kağıtçıbaşı, Ç[İJO3]. (2007). *Family, self, and human development across cultures: Theory and applications* (2nd ed.). Mahwah, NJ: Erlbaum.
- Kahl, B., & Woloshyn, V. E. (1994). Using elaborative interrogation to facilitate acquisition of factual information in cooperative learning settings: One good strategy deserves another. *Applied Cognitive Psychology*, 8, 465–478.
- Kahne, J. E., & Sporte, S. E. (2008). Developing citizens: The impact of civic learning opportunities on students' commitment to civic participation. *American Educational Research Journal*, 45, 738–766.
- Kail, R. (1990). *The development of memory in children* (3rd ed.). New York: Freeman.
- Kaiser, M. K., McCloskey, M., & Proffitt, D. R. (1986). Development of intuitive theories of motion: Curvilinear motion in the absence of external forces. *Developmental Psychology*, 22, 67–71.
- Kamins, M. L., & Dweck, C. S. (1999). Person versus process praise and criticism: Implications for contingent self-worth and coping. *Developmental Psychology*, 35, 835–847.
- Kane, M. J., Brown, L. H., McVay, J. C., Silvia, P. J., Myin-Germeys, I., & Kwapil, T. R. (2007). For whom the mind wanders, and when: An experience-sampling study of working memory and executive control in daily life. *Psychological Science*, 18, 614–621.
- Kanekar, S. (1976). Observational learning of attitudes: A behavioral analysis. *European Journal of Social Psychology*, 6, 5–24.
- Kang, M. J., Hsu, M., Krajchich, I. M., Loewenstein, G., McClure, S. M., Wang, J. T.-Y., et al. (2009). The wick in the candle of learning: Epistemic curiosity activates reward circuitry and enhances memory. *Psychological Science*, 20, 963–973.
- Kang, S. H. K., McDermott, K. B., & Roediger, H. L. (2007). Test format and corrective feedback modulate the effect of testing on memory retention. *European Journal of Cognitive Psychology*, 19, 528–558.
- Kaplan, A., & Flum, H. (2009). Motivation and identity: The relations of action and development in educational contexts—An introduction to the special issue. *Educational Psychologist*, 44, 73–77.
- Kaplan, A., Middleton, M. J., Urdan, T., & Midgley, C. (2002). Achievement goals and goal structures. In C. Midgley (Ed.), *Goals, goal structures, and patterns of adaptive learning* (pp. 21–53). Mahwah, NJ: Erlbaum.
- Kaplan, A., & Midgley, C. (1999). The relationship between perceptions of the classroom goal structure and early adolescents' affect in school: The mediating role of coping strategies. *Learning and Individual Differences*, 11, 187–212.
- Kaplan, S., & Berman, M. G. (2010). Directed attention as a common resource for executive functioning and self-regulation. *Perspectives on Psychological Science*, 5, 43–57.
- Kapur, M. (2008). Productive failure. *Cognition and Instruction*, 26, 379–424.
- Kapur, S., Craik, F. I. M., Tulving, E., Wilson, A. A., Houle, S., & Brown, G. M. (1994). Neuroanatomical correlates of encoding in episodic memory: Levels of processing effect. *Proceedings of National Academy of Sciences, USA*, 91, 2008–2011.
- Karabernick, S. A., & Sharma, R. (1994). Seeking academic assistance as a strategic learning resource. In P. R. Pintrich, D. R. Brown, & C. E. Weinstein (Eds.), *Student motivation, cognition, and learning: Essays in honor of Wilbert J. McKeachie* (pp. 189–212). Hillsdale, NJ: Erlbaum.
- Karau, S. J., & Williams, K. D. (1995). Social loafing: Research findings, implications, and future directions. *Current Directions in Psychological Science*, 4, 134–140.
- Kardash, C. A. M., & Amlund, J. T. (1991). Self-reported learning strategies and learning from expository text. *Contemporary Educational Psychology*, 16, 117–138.
- Kardash, C. A. M., & Howell, K. L. (2000). Effects of epistemological beliefs and topic-specific beliefs on undergraduates' cognitive and strategic processing of dual-positional text. *Journal of Educational Psychology*, 92, 524–535.
- Kardash, C. A. M., Royer, J. M., & Greene, B. A. (1988). Effects of schemata on both encoding and retrieval of information from prose. *Journal of Educational Psychology*, 80, 324–329.
- Kardash, C. A. M., & Scholes, R. J. (1996). Effects of pre-existing beliefs, epistemological beliefs, and need for cognition on interpretation of controversial issues. *Journal of Educational Psychology*, 88, 260–271.
- Kardash, C. A. M., & Sinatra, G. M. (2003, April). *Epistemological beliefs and dispositions: Are we measuring the same construct?* Paper presented at the annual meeting of the American Educational Research Association, Chicago.
- Karl, S. R., & Varma, S. (2010, April–May). *The conflict between decimal numbers and whole numbers*. Paper presented at the annual meeting of the American Educational Research Association, Denver.
- Karpicke, J. D., & Roediger, H. L., III (2008). The critical importance of retrieval for learning. *Science*, 319, 966–968.
- Karpov, Y. V., & Haywood, H. C. (1998). Two ways to elaborate Vygotsky's concept of mediation: Implications for instruction. *American Psychologist*, 53, 27–36.
- Katagiri, M. (1987). Contingencies in avoidance learning in goldfish. *Annual of Animal Psychology*, 36 (2), 77–87.
- Kauffman, S. (1995). *At home in the universe: The search for laws of self-organization and complexity*. New York: Oxford University Press.
- Kaufman, A., Baron, A., & Kopp, R. E. (1966). Some effects of instructions on human operant behavior. *Psychonomic Monograph Supplements*, 1, 243–250.
- Kazdin, A. E. (1972). Response cost: The removal of conditional reinforcers for therapeutic change. *Behavior Therapy*, 3, 533–546.
- Kazdin, A. E., & Benjet, C. (2003). Spanking children: Evidence and issues. *Current Directions in Psychological Science*, 12, 99–103.
- Keil, F. C. (1986). The acquisition of natural kind and artifact terms. In W. Demopolous & A. Marras (Eds.), *Language learning and concept acquisition* (pp. 133–153). Norwood, NJ: Ablex.
- Keil, F. C. (1987). Conceptual development and category structure. In U. Neisser (Ed.), *Concepts and conceptual development: Ecological and intellectual factors in categorization* (pp. 175–200). Cambridge, England: Cambridge University Press.
- Keil, F. C. (1989). *Concepts, kinds, and cognitive development*. Cambridge, MA: MIT Press.
- Keil, F. C. (1994). The birth and nurturance of concepts by domains: The origins of concepts of living things. In L. A. Hirschfeld & S. A. Gelman (Eds.), *Mapping the mind: Domain specificity in cognition and culture* (pp. 234–254). Cambridge, England: Cambridge University Press.
- Keil, F. C., & Newman, G. E. (2008). Two tales of conceptual change: What changes and what remains the same. In S. Vosniadou (Ed.), *International handbook on conceptual change* (pp. 83–101). New York: Routledge.
- Keil, F. C., & Silberstein, C. S. (1996). Schooling and the acquisition of theoretical knowledge. In D. R. Olson & N. Torrance (Eds.), *The handbook of education and human development: New models of learning, teaching, and schooling* (pp. 621–645). Cambridge, MA: Blackwell.
- Keith, N., & Frese, M. (2005). Self-regulation in error management training: Emotion control and metacognition as mediators of performance effects. *Journal of Applied Psychology*, 90, 677–691.
- Kelmen, D. (1999). Why are rocks pointy? Children's preference for teleological explanations of the natural world. *Developmental Psychology*, 35, 1440–1452.
- Kelmen, D. (2004). Are children "intuitive theists"? Reasoning about purpose and design in nature. *Psychological Science*, 15, 295–301.
- Keller, F. S. (1968). Goodbye teacher. *Journal of Applied Behavior Analysis*, 1, 79–89.
- Keller, F. S. (1974). An international venture in behavior modification. In F. S. Keller & E. Ribes-Inesta (Eds.), *Behavior modification: Applications to education* (pp. 143–155). New York: Academic Press.
- Kelley, M. L., & Carper, L. B. (1988). Home-based reinforcement procedures. In J. C. Witt, S. N. Elliott, & F. M. Gresham (Eds.), *Handbook of behavior therapy in education* (pp. 419–438). New York: Plenum Press.
- Kelly, S. W., Burton, A. M., Kato, T., & Akamatsu, S. (2001). Incidental learning of real-world regularities. *Psychological Science*, 12, 86–89.
- Kember, D. (2001). Beliefs about knowledge and the process of teaching and learning as a factor in adjusting to study in higher education. *Studies in Higher Education*, 26, 205–221.
- Kemler Nelson, D. G., Egan, L. C., & Holt, M. B. (2004). When children ask, "What is it?" what do they want to know about artifacts? *Psychological Science*, 15, 384–389.

- Kendeou, P., & van den Broek, P. (2005). The effects of readers' misconceptions on comprehension of scientific text. *Journal of Educational Psychology, 97*, 235–245.
- Kendler, T. S. (1961). Concept formation. *Annual Review of Psychology, 13*, 447–472.
- Kendler, T. S., & Kendler, H. H. (1959). Reversal and nonreversal shifts in kindergarten children. *Journal of Experimental Psychology, 58*, 56–60.
- Kenrick, D. T., Griskevicius, V., Neuberg, S. L., & Schaller, M. (2010). Renovating the pyramid of needs: Contemporary extensions built upon ancient foundations. *Perspectives on Psychological Science, 5*, 292–314.
- Kensinger, E. A. (2007). Negative emotion enhances memory accuracy: Behavioral and neuroimaging evidence. *Current Directions in Psychological Science, 16*, 213–218.
- Kermani, H., & Moallem, M. (1997, March). *Cross-age tutoring: Exploring features and processes of peer-mediated learning*. Paper presented at the annual meeting of the American Educational Research Association, Chicago.
- Kesebir, S., Graham, J., & Oishi, S. (2010). A theory of human needs should be human-centered, not animal-centered: Commentary on Kenrick et al. (2010). *Perspectives on Psychological Science, 5*, 315–319.
- Kesebir, S., & Oishi, S. (2010). A spontaneous self-reference effect in memory: Why some birthdays are harder to remember than others. *Psychological Science, 21*, 1525–1531.
- Kiefer, S. M., & Ryan, A. M. (2008). Striving for social dominance over peers: The implications for academic adjustment during early adolescence. *Journal of Educational Psychology, 100*, 417–428.
- Kiewra, K. A. (1985). Investigating notetaking and review: A depth of processing alternative. *Educational Psychologist, 20*, 23–32.
- Kiewra, K. A. (1989). A review of note-taking: The encoding-storage paradigm and beyond. *Educational Psychology Review, 1*, 147–172.
- Kiewra, K. A., DuBois, N. F., Christian, D., McShane, A., Meyerhoffer, M., & Roskelly, D. (1988, April). *Theoretical and practical aspects of taking, reviewing, and borrowing conventional, skeletal, or matrix lecture notes*. Paper presented at the annual meeting of the American Educational Research Association, New Orleans, LA.
- Killeen, P. R. (2001). The four causes of behavior. *Current Directions in Psychological Science, 10*, 136–140.
- Kim, S.-I., Lee, M.-J., Chung, M., & Bong, M. (2010). Comparison of brain activation during norm-referenced versus criterion-referenced feedback: The role of perceived competence and performance-approach goals. *Contemporary Educational Psychology, 35*, 141–152.
- Kimberg, D. Y., D'Esposito, M., & Farah, M. J. (1997). Cognitive functions in the prefrontal cortex—Working memory and executive control. *Current Directions in Psychological Science, 6*, 185–192.
- Kimble, G. A. (2000). Behaviorism and unity in psychology. *Current Directions in Psychological Science, 9*, 208–212.
- Kincheloe, J. L. (2009). No short cuts in urban education: Metropedagogy and diversity. In S. R. Steinberg (Ed.), *Diversity and multiculturalism: A reader* (pp. 379–409). New York: Peter Lang.
- King, A. (1992). Comparison of self-questioning, summarizing, and notetaking-review as strategies for learning from lectures. *American Educational Research Journal, 29*, 303–323.
- King, A. (1994). Guiding knowledge construction in the classroom: Effects of teaching children how to question and how to explain. *American Educational Research Journal, 31*, 338–368.
- King, A. (1997). ASK to THINK—TEL WHY: A model of transactive peer tutoring for scaffolding higher level complex learning. *Educational Psychologist, 32*, 221–235.
- King, A. (1999). Discourse patterns for mediating peer learning. In A. M. O'Donnell & A. King (Eds.), *Cognitive perspectives on peer learning* (pp. 87–115). Mahwah, NJ: Erlbaum.
- King, A., Staffieri, A., & Adalgais, A. (1998). Mutual peer tutoring: Effects of structuring tutorial interaction to scaffold peer learning. *Journal of Educational Psychology, 90*, 134–152.
- King, N. J., & Ollendick, T. H. (1989). Children's anxiety and phobic disorders in school settings: Classification, assessment, and intervention issues. *Review of Educational Research, 59*, 431–470.
- King, P. M., & Kitchener, K. S. (1994). *Developing reflective judgment: Understanding and promoting intellectual growth and critical thinking in adolescents and adults*. San Francisco: Jossey-Bass.
- King, P. M., & Kitchener, K. S. (2002). The reflective judgment model: Twenty years of research on epistemic cognition. In B. K. Hofer & P. R. Pintrich (Eds.), *Personal epistemology: The psychology of beliefs about knowledge and knowing* (pp. 37–61). Mahwah, NJ: Erlbaum.
- King, P. M., & Kitchener, K. S. (2004). Reflective judgment: Theory and research on the development of epistemic assumptions through adulthood. *Educational Psychologist, 39*, 5–18.
- Kingstone, A., Smilek, D., Ristic, J., Friesen, C. K., & Eastwood, J. D. (2003). Attention, researchers! It is time to take a look at the real world. *Current Directions in Psychological Science, 12*, 176–180.
- Kinnick, V. (1990). The effect of concept teaching in preparing nursing students for clinical practice. *Journal of Nursing Education, 29*, 362–366.
- Kintsch, W. (1977). Reading comprehension as a function of text structure. In A. S. Reber & D. L. Scarborough (Eds.), *Toward a psychology of reading* (pp. 227–256). New York: Wiley.
- Kintsch, W. (1980). Learning from text, levels of comprehension, or: Why anyone would read a story anyway. *Poetics, 9*, 87–98.
- Kintsch, W. (1998). *Comprehension: A paradigm for cognition*. Cambridge, England: Cambridge University Press.
- Kintsch, W., & van Dijk, T. A. (1978). Toward a model of text comprehension and production. *Psychological Review, 85*, 363–394.
- Kirkland, M. C. (1971). The effect of tests on students and schools. *Review of Educational Research, 41*, 303–350.
- Kirschner, F., Paas, F., & Kirschner, P. A. (2009). A cognitive load approach to collaborative learning: United brains for complex tasks. *Educational Psychology Review, 21*, 31–42.
- Kirschner, P. A., Sweller, J., & Clark, R. E. (2006). Why minimal guidance during instruction does not work: An analysis of the failure of constructivist, discovery, problem-based, experiential, and inquiry-based teaching. *Educational Psychologist, 41*, 75–86.
- Kirsh, D. (2009). Problem solving and situated cognition. In P. Robbins & M. Aydede (Eds.), *The Cambridge handbook of situated cognition* (pp. 264–306). Cambridge, England: Cambridge University Press.
- Kitsantas, A., Zimmerman, B. J., & Cleary, T. (2000). The role of observation and emulation in the development of athletic self-regulation. *Journal of Educational Psychology, 92*, 811–817.
- Klaczynski, P. A. (2001). Analytic and heuristic processing influences on adolescent reasoning and decision-making. *Child Development, 72*, 844–861.
- Kladopoulos, C. N., & McComas, J. J. (2001). The effects of form training on foul-shooting performance in members of a women's college basketball team. *Journal of Applied Behavior Analysis, 34*, 329–332.
- Klahr, D. (2001). Time matters in cognitive development. In J. L. McClelland & R. S. Siegler (Eds.), *Mechanisms of cognitive development: Behavioral and neural perspectives* (pp. 291–301). Mahwah, NJ: Erlbaum.
- Klahr, D., & Chen, Z. (2003). Overcoming the positive-capture strategy in young children: Learning about indeterminacy. *Child Development, 74*, 1275–1296.
- Klassen, R. M., & Lynch, S. L. (2007). Self-efficacy from the perspective of adolescents with LD and their specialist teachers. *Journal of Learning Disabilities, 40*, 494–507.
- Klassen, R. M., & Usher, E. L. (2010). Self-efficacy in educational settings: Recent research and emerging directions. In S. Karabenick & T. C. Urdan (Eds.), *Advances in motivation and achievement: Vol. 16A. The decade ahead: Theoretical perspectives on motivation and achievement* (pp. 1–33). Bingley, England: Emerald Group Publishing.
- Klatzky, R. L. (1975). *Human memory*. San Francisco: Freeman.
- Klauda, S. L., & Guthrie, J. T. (2008). Relationships of three components of reading fluency to reading comprehension. *Journal of Educational Psychology, 100*, 310–321.
- Klein, S. B. (1987). *Learning: Principles and applications*. New York: McGraw-Hill.
- Klinger, E. (1975). Consequences of commitment to and disengagement from incentives. *Psychological Review, 82*, 1–25.
- Klinger, E. (1977). *Meaning and void: Inner experience and the incentives in people's lives*. Minneapolis: University of Minnesota Press.
- Klinnert, M. D. (1984). The regulation of infant behavior by maternal facial expression. *Infant Behavior and Development, 7*, 447–465.

- Klannert, M. D., Emde, R. N., Butterfield, P., & Campos, J. J. (1986). Social referencing: The infant's use of emotional signals from a friendly adult with mother present. *Developmental Psychology*, 22, 427-434.
- Kluger, A. N., & DeNisi, A. (1998). Feedback interventions: Toward the understanding of a double-edged sword. *Current Directions in Psychological Science*, 7, 67-72.
- Knutson, J. S., Simmons, D. C., Good, R., III, & McDonagh, S. H. (2004). Specially designed assessment and instruction for children who have not responded adequately to reading intervention. *Assessment for Effective Intervention*, 29 (4), 47-58.
- Koedinger, K., Alevan, V., Roll, I., & Baker, R. (2009). *In vivo* experiments on whether supporting metacognition in intelligent tutoring systems yields robust learning. In D. J. Hacker, J. Dunlosky, & A. C. Graesser (Eds.), *Handbook of metacognition in education* (pp. 383-412). New York: Routledge.
- Koegel, L. K., Koegel, R. L., & Dunlap, G. (Eds.). (1996). *Positive behavioral support: Including people with difficult behavior in the community*. Baltimore: Paul H. Brookes.
- Koestner, R., Ryan, R. M., Bernieri, E., & Holt, K. (1984). Setting limits on children's behavior: The differential effects of controlling vs. informational styles on intrinsic motivation and creativity. *Journal of Personality*, 52, 233-248.
- Koffka, K. (1935). *Principles of Gestalt psychology*. New York: Harcourt, Brace.
- Koger, S. M., Schettler, T., & Weiss, B. (2005). Environmental toxins and developmental disabilities: A challenge for psychologists. *American Psychologist*, 60, 243-255.
- Köhler, W. (1925). *The mentality of apes*. London: Routledge & Kegan Paul.
- Köhler, W. (1929). *Gestalt psychology*. New York: Liveright.
- Köhler, W. (1947). *Gestalt psychology: An introduction to new concepts in modern psychology*. New York: Liveright.
- Köhler, W. (1959). Gestalt psychology today. *American Psychologist*, 14, 727-734.
- Kolb, B., Gibb, R., & Robinson, T. E. (2003). Brain plasticity and behavior. *Current Directions in Psychological Science*, 12, 1-5.
- Koltko-Rivera, M. E. (2004). The psychology of worldviews. *Review of General Psychology*, 8, 3-58.
- Konkle, T., Brady, T. F., Alvarez, G. A., & Oliva, A. (2010). Scene memory is more detailed than you think: The role of categories in visual long-term memory. *Psychological Science*, 21, 1551-1556.
- Koo, B. K. K., Blaser, S., Harwood-Nash, D., Becker, L. E., & Murphy, E. G. (1992). Magnetic resonance imaging evaluation of delayed myelination in Down syndrome: A case report and review of the literature. *Journal of Child Neurology*, 7, 417-421.
- Koob, A. (2009). *The root of thought*. Upper Saddle River, NJ: Pearson.
- Koriat, A., & Goldsmith, M. (1996). Monitoring and control processes in the strategic regulation of memory accuracy. *Psychological Review*, 103, 490-517.
- Kornell, N. (2009). Metacognition in human and animals. *Current Directions in Psychological Science*, 18, 11-15.
- Kornell, N., & Bjork, R. A. (2008). Optimizing self-regulated study: The benefits—and costs—of dropping flashcards. *Memory*, 16, 125-136.
- Kornell, N., Castell, A. D., Eich, T. S., & Bjork, R. A. (2010). Spacing as the friend of both memory and induction in young and old adults. *Psychology and Aging*, 25, 498-503.
- Kornell, N., Son, L. K., & Terrace, H. S. (2007). Transfer of metacognitive skills and hint seeking in monkeys. *Psychological Science*, 18, 64-71.
- Korzybski, A. (1933). *Science and sanity: An introduction to non-Aristotelian systems and general semantics*. Lancaster, PA: International Non-Aristotelian Library.
- Koschmann, T., & LeBaron, C. (2002). Learner articulation as interactional achievement: Studying the conversation of gesture. *Cognition and Instruction*, 20, 249-282.
- Kosslyn, S. M. (1985). Mental imagery ability. In R. J. Sternberg (Ed.), *Human abilities: An information-processing approach* (pp. 151-172). New York: Freeman.
- Kosslyn, S. M. (1994). *Image and brain: The resolution of the imagery debate*. Cambridge, MA: MIT Press.
- Kosslyn, S. M., Margolis, J. A., Barrett, A. M., Goldknopf, E. J., & Daly, P. F. (1990). Age differences in imagery ability. *Child Development*, 61, 995-1010.
- Kounios, J., & Beeman, M. (2009). The *Aha!* moment: The cognitive neuroscience of insight. *Current Directions in Psychological Science*, 18, 210-216.
- Kowalski, P. S., Taylor, A. K., & Guggia, A. E. (April, 2004). *Ability, effort, and refutational text as factors influencing change in students' psychological misconceptions*. Paper presented at the American Educational Research Association, San Diego, CA.
- Kozulin, A. (1986). Vygotsky in context. In A. S. Vygotsky, *Thought and language* (rev. ed., pp. xi-lvi; A. Kozulin, Ed. and Trans.). Cambridge, MA: MIT Press.
- Kozulin, A., & Falik, L. (1995). Dynamic cognitive assessment of the child. *Current Directions in Psychological Science*, 4, 192-196.
- Krajcik, J. S. (1991). Developing students' understanding of chemical concepts. In S. M. Glynn, R. H. Yeany, & B. K. Britton (Eds.), *The psychology of learning science* (pp. 117-147). Hillsdale, NJ: Erlbaum.
- Krajcik, J. S., & Blumenfeld, P. C. (2006). In R. Sawyer (Ed.), *The Cambridge handbook of the learning sciences* (pp. 317-333). New York: Cambridge University Press.
- Kramarski, B., & Mevarech, Z. R. (2003). Enhancing mathematical reasoning in the classroom: The effects of cooperative learning and metacognitive training. *American Educational Research Journal*, 40, 281-310.
- Kramarski, B., & Michalsky, T. (2009). Investigating preservice teachers' professional growth in self-regulated learning environments. *Journal of Educational Psychology*, 101, 161-175.
- Krampen, G. (1987). Differential effects of teacher comments. *Journal of Educational Psychology*, 79, 137-146.
- Krapp, A., Hidi, S., & Renninger, K. A. (1992). Interest, learning, and development. In K. A. Renninger, S. Hidi, & A. Krapp (Eds.), *The role of interest in learning and development* (pp. 3-25). Hillsdale, NJ: Erlbaum.
- Krathwohl, D. R. (1994). Reflections on the taxonomy: Its past, present, and future. In L. W. Anderson & L. A. Sosniak (Eds.), *Bloom's taxonomy: A forty-year perspective. Ninety-third yearbook of the National Society for the Study of Education, Part II* (pp. 181-202). Chicago: National Society for the Study of Education.
- Krauss, R. M. (1998). Why do we gesture when we speak? *Current Directions in Psychological Science*, 7, 54-60.
- Kray, J., Eenshuistra, R., Kerstner, H., Weidema, M., & Hommel, B. (2006). Language and action control: The acquisition of action goals in early childhood. *Psychological Science*, 17, 737-741.
- Kremen, W. S., Jacobsen, K. C., Xian, H., Eisen, S. A., Eaves, L. J., Tsuang, M. T., et al. (2007). *Neuropsychology*, 21, 569-580.
- Krendl, A. C., Richeson, J. A., Kelley, W. M., & Heatherton, T. F. (2008). The negative consequences of threat: A functional magnetic resonance imaging investigation of the neural mechanisms underlying women's underperformance in math. *Psychological Science*, 19, 168-175.
- Kritch, K. M., & Bostrow, D. E. (1998). Degree of constructed-response interaction in computer-based programmed instruction. *Journal of Applied Behavior Analysis*, 31, 387-398.
- Krueger, W. C. F. (1929). The effect of overlearning on retention. *Journal of Experimental Psychology*, 12, 71-78.
- Kruglanski, A. W., & Webster, D. M. (1996). Motivated closing of the mind: Seizing and freeing. *Psychological Review*, 103, 263-283.
- Krumboltz, J. D., & Krumboltz, H. B. (1972). *Changing children's behavior*. Englewood Cliffs, NJ: Prentice Hall.
- Kruschke, J. K. (2003). Attention in learning. *Current Directions in Psychological Science*, 12, 171-175.
- Ku, Y.-M., Chan, W.-C., Wu, Y.-C., & Chen, Y.-H. (2008, March). *Improving children's comprehension of science text: Effects of adjunct questions and notetaking*. Paper presented at the annual meeting of the American Educational Research Association, New York.
- Kuhara-Kojima, K., & Hatano, G. (1991). Contribution of content knowledge and learning ability to the learning of facts. *Journal of Educational Psychology*, 83, 253-263.
- Kuhl, J. (1987). Action control: The maintenance of motivational states. In F. Halisch & J. Kuhl (Eds.), *Motivation, intention, and volition* (pp. 279-291). Berlin, Germany: Springer-Verlag.
- Kuhl, P. K., Conboy, B. T., Padden, D., Nelson, T., & Pruitt, J. (2005). Early speech perception and later language development: Implications for the "critical period." *Language Learning and Development*, 1, 237-264.



- Kuhl, P. K., Tsao, F.-M., & Liu, H.-M. (2003). Foreign-language experience in infancy: Effects of short-term exposure and social interaction on phonetic learning. *Proceedings of the National Academy of Sciences*, *100*, 9096–9101.
- Kuhl, P. K., Williams, K. A., & Lacerda, F. (1992). Linguistic experience alters phonetic perceptions in infants by 6 months of age. *Science*, *255*, 606–608.
- Kuhn, D. (1997). Constraints or guideposts? Developmental psychology and science education. *Review of Educational Research*, *67*, 141–150.
- Kuhn, D. (2000). Metacognitive development. *Current Directions in Psychological Science*, *9*, 178–181.
- Kuhn, D. (2001a). How do people know? *Psychological Science*, *12*, 1–8.
- Kuhn, D. (2001b). Why development does (and does not) occur: Evidence from the domain of inductive reasoning. In J. L. McClelland & R. S. Siegler (Eds.), *Mechanisms of cognitive development: Behavioral and neural perspectives* (pp. 221–249). Mahwah, NJ: Erlbaum.
- Kuhn, D. (2006). Do cognitive changes accompany developments in the adolescent brain? *Perspectives on Psychological Science*, *1*, 59–67.
- Kuhn, D. (2009). The importance of learning about knowing: Creating a foundation for development of intellectual values. *Child Development Perspectives*, *3*, 112–117.
- Kuhn, D., Daniels, S., & Krishnan, A. (2003, April). *Epistemology and intellectual values as core metacognitive constructs*. Paper presented at the annual meeting of the American Educational Research Association, Chicago.
- Kuhn, D., & Franklin, S. (2006). The second decade: What develops (and how)? In W. Damon & R. M. Lerner (Series Eds.), D. Kuhn, & R. Siegler (Vol. Eds.), *Handbook of child psychology: Vol. 2. Cognition, perception, and language* (6th ed., pp. 953–993). New York: Wiley.
- Kuhn, D., & Park, S.-H. (2005). Epistemological understanding and the development of intellectual values. *International Journal of Educational Research*, *43*, 111–124.
- Kuhn, D., & Pease, M. (2008). What needs to develop in the development of inquiry skills? *Cognition and Instruction*, *26*, 512–599.
- Kuhn, D., & Pease, M. (2010). The dual components of developing strategy use: Production and inhibition. In H. S. Waters & W. Schneider (Eds.), *Metacognition, strategy use, and instruction* (pp. 135–159). New York: Guilford Press.
- Kuhn, D., Shaw, V., & Felton, M. (1997). Effects of dyadic interaction on argumentative reasoning. *Cognition and Instruction*, *15*, 287–315.
- Kuhn, D., & Udell, W. (2003). The development of argument skills. *Child Development*, *74*, 1245–1260.
- Kuhn, D., & Weinstock, M. (2002). What is epistemological thinking and why does it matter? In B. K. Hofer & P. R. Pintrich (Eds.), *Personal epistemology: The psychology of beliefs about knowledge and knowing* (pp. 121–144). Mahwah, NJ: Erlbaum.
- Kuhn, T. (1970). *The structure of scientific revolutions* (2nd ed.). Chicago: University of Chicago Press.
- Kuklinski, M. R., & Weinstein, R. S. (2001). Classroom and developmental differences in a path model of teacher expectancy effects. *Child Development*, *72*, 1554–1578.
- Kulik, C. C., Kulik, J. A., & Bangert-Drowns, R. L. (1990). Effectiveness of mastery learning programs: A meta-analysis. *Review of Educational Research*, *60*, 265–299.
- Kulik, C. C., Kulik, J. A., & Shwalb, B. J. (1983). College programs for high-risk and disadvantaged students: A meta-analysis of findings. *Review of Educational Research*, *53*, 397–414.
- Kulik, C. C., Schwalb, B. J., & Kulik, J. A. (1982). Programmed instruction in secondary education: A meta-analysis of evaluation findings. *Journal of Educational Research*, *75* (3), 133–138.
- Kulik, J. A., Cohen, P. A., & Ebeling, B. J. (1980). Effectiveness of programmed instruction in higher education: A meta-analysis of findings. *Educational Evaluation and Policy Analysis*, *2* (6), 51–64.
- Kulik, J. A., & Kulik, C. C. (1988). Timing of feedback and verbal learning. *Review of Educational Research*, *58*, 79–97.
- Kulik, J. A., Kulik, C. C., & Cohen, P. A. (1979). A meta-analysis of outcome studies of Keller's Personalized System of Instruction. *American Psychologist*, *34*, 307–318.
- Kunda, Z. (1990). The case for motivated reasoning. *Psychological Bulletin*, *108*, 480–498.
- Kunzinger, E. L., III. (1985). A short-term longitudinal study of memorial development during early grade school. *Developmental Psychology*, *21*, 642–646.
- Kupersmidt, J. B., Buchele, K. S., Voegler, M. E., & Sedikides, C. (1996). Social self-discrepancy: A theory relating peer relations problems and school maladjustment. In J. Juvonen & K. R. Wentzel (Eds.), *Social motivation: Understanding children's school adjustment* (pp. 66–97). Cambridge, England: Cambridge University Press.
- LaBerge, D., & Samuels, S. J. (1974). Toward a theory of automatic information processing in reading. *Cognitive Psychology*, *6*, 293–323.
- Lackaye, T. D., & Margalit, M. (2006). Comparisons of achievement, effort, and self-perceptions among students with learning disabilities and their peers from different achievement groups. *Journal of Learning Disabilities*, *39*, 432–446.
- Ladd, G. W., & Dinella, L. M. (2009). Continuity and change in early school engagement: Predictive of children's achievement trajectories from first to eighth grade? *Journal of Educational Psychology*, *101*, 190–206.
- La Guardia, J. G., (2009). Developing who I am: A self-determination theory approach to the establishment of healthy identities. *Educational Psychologist*, *44*, 90–104.
- Lakoff, G., & Núñez, R. E. (1997). The metaphorical structure of mathematics: Sketching out cognitive foundations for a mind-based mathematics. In L. D. English (Ed.), *Mathematical reasoning: Analogies, metaphors, and images* (pp. 21–89). Mahwah, NJ: Erlbaum.
- Lambert, M. C., Cartledge, G., Heward, W. L., & Lo, Y.-Y. (2006). Effects of response cards on disruptive behavior and academic responding during math lessons by fourth-grade urban students. *Journal of Positive Behavioral Interventions*, *8*, 88–99.
- Lampert, M. (1990). When the problem is not the question and the solution is not the answer: Mathematical knowing and teaching. *American Educational Research Journal*, *17*, 29–63.
- Lampert, M., Rittenhouse, P., & Crumbaugh, C. (1996). Agreeing to disagree: Developing sociable mathematical discourse. In D. R. Olson & N. Torrance (Eds.), *The handbook of education and human development: New models of learning, teaching, and schooling* (pp. 731–764). Cambridge, MA: Blackwell.
- Lampinen, J. M., Copeland, S. M., & Neuschatz, J. S. (2001). Recollections of things schematic: Room schemas revisited. *Journal of Experimental Psychology: Learning, Memory, and Cognition*, *27*, 1211–1222.
- Lan, W. Y., Repman, J., Bradley, L., & Weller, H. (1994, April). *Immediate and lasting effects of criterion and payoff on academic risk taking*. Paper presented at the annual meeting of the American Educational Research Association, New Orleans, LA.
- Landauer, T. K. (1962). Rate of implicit speech. *Perceptual and Motor Skills*, *15*, 646.
- Landrum, T. J., & Kauffman, J. M. (2006). Behavioral approaches to classroom management. In C. M. Evertson & C. S. Weinstein (Eds.), *Handbook of classroom management: Research, practice, and contemporary issues* (pp. 47–71). Mahwah, NJ: Erlbaum.
- Lane, K., Falk, K., & Wehby, J. (2006). Classroom management in special education classrooms and resource rooms. In C. M. Evertson & C. S. Weinstein (Eds.), *Handbook of classroom management: Research, practice, and contemporary issues* (pp. 439–460). Mahwah, NJ: Erlbaum.
- Lane, S. M., Matthews, R. C., Sallas, B., Prattini, R., & Sun, R. (2008). Facilitative interactions of model- and experience-based processes: Implications for type and flexibility of representation. *Memory and Cognition*, *36*, 157–169.
- Lane, S. M., & Schooler, J. W. (2004). Skimming the surface: Verbal overshadowing of analogical retrieval. *Psychological Science*, *15*, 715–719.
- Lange, G., & Pierce, S. H. (1992). Memory-strategy learning and maintenance in pre-school children. *Developmental Psychology*, *28*, 453–462.
- Langer, E. J. (1997). *The power of mindful learning*. Reading, MA: Addison-Wesley.
- Langer, E. J. (2000). Mindful learning. *Current Directions in Psychological Science*, *9*, 220–223.
- Lansford, J. E., Chang, L., Dodge, K. A., Malone, P. S., Oburu, P., Palmérus, K., et al. (2005).

- Physical discipline and children's adjustment: Cultural normativeness as a moderator. *Child Development*, 76, 1234–1246.
- Lapan, R. T., Tucker, B., Kim, S.-K., & Kosciulek, J. F. (2003). Preparing rural adolescents for post-high school transitions. *Journal of Counseling and Development*, 81, 329–342.
- Laraway, S., Snycerski, S., Michael, J., & Poling, A. (2003). Motivating operations and terms to describe them: Some further refinements. *Journal of Applied Behavior Analysis*, 36, 407–414.
- Larson, R. W. (2000). Toward a psychology of positive youth development. *American Psychologist*, 55, pp. 170–183.
- Larson, R. W., Clore, G. L., & Wood, G. A. (1999). The emotions of romantic relationships: Do they wreak havoc on adolescents? In W. Furman, B. B. Brown, & C. Feiring (Eds.), *The development of romantic relationships in adolescence* (pp. 19–49). Cambridge, England: Cambridge University Press.
- Lassiter, G. D. (2002). Illusory causation in the courtroom. *Current Directions in Psychological Science*, 11, 204–208.
- Lau, S., & Nie, Y. (2008). Interplay between personal goals and classroom goal structures in predicting student outcomes: A multilevel analysis of person-context interactions. *Journal of Educational Psychology*, 100, 15–29.
- Lave, J. (1988). *Cognition in practice: Mind, mathematics, and culture in everyday life*. Cambridge, England: Cambridge University Press.
- Lave, J. (1991). Situating learning in communities of practice. In L. B. Resnick, J. M. Levine, & S. D. Teasley (Eds.), *Perspectives on socially shared cognition* (pp. 63–82). Washington, DC: American Psychological Association.
- Lave, J. (1993). Word problems: A microcosm of theories of learning. In P. Light & G. Butterworth (Eds.), *Context and cognition: Ways of learning and knowing* (pp. 7–92). Hillsdale, NJ: Erlbaum.
- Lave, J., & Wenger, E. (1991). *Situated learning: Legitimate peripheral participation*. Cambridge, England: Cambridge University Press.
- Lawson, M. J., & Chinnappan, M. (1994). Generative activity during geometry problem solving: Comparison of the performance of high-achieving and low-achieving high school students. *Cognition and Instruction*, 12, 61–93.
- Lazarus, R. S. (1991). *Emotion and adaptation*. New York: Oxford University Press.
- Leach, J. T., & Scott, P. H. (2008). Teaching for conceptual understanding: An approach drawing on individual and sociocultural perspectives. In S. Vosniadou (Ed.), *International handbook on conceptual change* (pp. 647–675). New York: Routledge.
- Leaper, C., & Friedman, C. K. (2007). The socialization of gender. In J. E. Grusec & P. D. Hastings (Eds.), *Handbook of socialization: Theory and research* (pp. 561–587). New York: Guilford Press.
- Learning Technology Center at Vanderbilt (1996). *Jasper in the Classroom* [videodisc]. Mahwah, NJ: Erlbaum.
- LeBlanc, L. A., Coates, A. M., Daneshvar, S., Charlop-Christy, M. H., Morris, C., & Lancaster, B. M. (2003). Using video modeling and reinforcement to teach perspective-taking skills to children with autism. *Journal of Applied Behavior Analysis*, 36, 253–257.
- LeDoux, J. (1998). *The emotional brain*. London: Weidenfeld and Nicholson.
- LeDoux, J. (2003). The emotional brain, fear, and the amygdala. *Cellular and Molecular Neurobiology*, 23, 727–738.
- Lee, J., & Shute, V. J. (2010). Personal and social-contextual factors in K–12 academic performance: An integrative perspective on student learning. *Educational Psychologist*, 45, 185–202.
- Lee, J. L. C., Everitt, B. J., & Thomas, K. L. (2004). Independent cellular processes for hippocampal memory consolidation and reconsolidation. *Science*, 304, 839–843.
- Lee, J. Q., McInerney, D. M., Liem, G. A. D., & Ortega, Y. P. (2010). The relationship between future goals and achievement goal orientations: An intrinsic–extrinsic motivation perspective. *Contemporary Educational Psychology*, 35, 264–279.
- Lee, K., Ng, E. L., & Ng, S. F. (2009). The contributions of working memory and executive function to problem representation and solution generation in algebraic word problems. *Journal of Educational Psychology*, 101, 373–387.
- Lee, M., Lee, K., & Bong, M. (2010, April–May). “Why do you study?” Students’ spontaneous responses to an open-ended question. Paper presented at the annual meeting of the American Educational Research Association, Denver.
- Lee, O. (1991, April). *Motivation to learn subject matter content: The case of science*. Paper presented at the annual meeting of the American Educational Research Association, Chicago.
- Lee, O. (1999). Science knowledge, world views, and information sources in social and cultural contexts: Making sense after a natural disaster. *American Educational Research Journal*, 36, 187–219.
- Lee, O., & Anderson, C. W. (1991, April). *Student motivation in middle school science classrooms*. Paper presented at the annual meeting of the American Educational Research Association, Chicago.
- Lee, O., & Anderson, C. W. (1993). Task engagement and conceptual change in middle school science classrooms. *American Educational Research Journal*, 30, 585–610.
- Lee, S. (1985). Children's acquisition of conditional logic structure: Teachable? *Contemporary Educational Psychology*, 10, 14–27.
- Lee, V. R. (2010, April–May). *Misconstruals or more? The interactions of orbit diagrams and explanations of the seasons*. Paper presented at the annual meeting of the American Educational Research Association, Denver.
- LeFevre, J., Bisanz, J., & Mrkonjic, J. (1988). Cognitive arithmetic: Evidence for obligatory activation of arithmetic facts. *Memory and Cognition*, 16, 45–53.
- Leff, R. (1969). Effects of punishment intensity and consistency on the internalization of behavioral suppression in children. *Developmental Psychology*, 1, 345–356.
- Leherissey, B. L., O'Neil, H. F., Jr., & Hansen, D. N. (1971). Effects of memory support on state anxiety and performance in computer-assisted learning. *Journal of Educational Psychology*, 62, 413–420.
- Lehman, D. R., & Nisbett, R. E. (1990). A longitudinal study of the effects of undergraduate training on reasoning. *Developmental Psychology*, 26, 952–960.
- Lehmann, M., & Hasselhorn, M. (2007). Variable memory strategy use in children's adaptive intratask learning behavior: Developmental changes and working memory influences in free recall. *Child Development*, 78, 1068–1082.
- Leibham, M. E., Alexander, J. M., Johnson, K. E., Neitzel, C. L., & Reis-Henrie, F. P. (2005). Parenting behaviors associated with the maintenance of preschoolers' interests: A prospective longitudinal study. *Journal of Applied Developmental Psychology*, 26, 397–414.
- Leichtman, M. D., & Ceci, S. J. (1995). The effects of stereotypes and suggestions on preschoolers' reports. *Developmental Psychology*, 31, 568–578.
- Leichtman, M. D., Pillemer, D. B., Wang, Q., Koreishi, A., & Han, J. J. (2000). When Baby Maisy came to school: Mothers' interview styles and preschoolers' event memories. *Cognitive Development*, 15, 99–114.
- Leinhardt, G. (1992). What research on learning tells us about teaching. *Educational Leadership*, 49 (7), 20–25.
- Leinhardt, G. (1994). History: A time to be mindful. In G. Leinhardt, I. L. Beck, & C. Stainton (Eds.), *Teaching and learning in history* (pp. 209–255). Hillsdale, NJ: Erlbaum.
- Lejuez, C. W., Schaal, D. W., & O'Donnell, J. (1998). Behavioral pharmacology and the treatment of substance abuse. In J. J. Plaud & G. H. Eifert (Eds.), *From behavior theory to behavior therapy* (pp. 116–135). Boston: Allyn & Bacon.
- Lennon, R., Ormrod, J. E., Burger, S. F., & Warren, E. (1990, October). *Belief systems of teacher education majors and their possible influences on future classroom performance*. Paper presented at the annual meeting of the Northern Rocky Mountain Educational Research Association, Greeley, CO.
- Lenroot, R. K., & Giedd, J. N. (2007). The structural development of the human brain as measured longitudinally with magnetic resonance imaging. In D. Coch, K. W. Fischer, & G. Dawson (Eds.), *Human behavior, learning, and the developing brain: Typical development* (pp. 50–73). New York: Guilford Press.
- Leon, J. A., & Pepe, H. J. (1983). Self-instructional training: Cognitive behavior modification for remediating arithmetic deficits. *Exceptional Children*, 50, 54–60.
- Lepper, M. R. (1981). Intrinsic and extrinsic motivation in children: Detrimental effects of superfluous social controls. In W. A. Collins (Ed.), *Minnesota Symposia on Child Psychology* (Vol. 14, pp. 155–214). Hillsdale, NJ: Erlbaum.
- Lepper, M. R., Aspinwall, L. G., Mumme, D. L., & Chabey, R. W. (1990). Self-perception and

- social-perception processes in tutoring: Subtle social control strategies of expert tutors. In J. M. Olson & M. P. Zanna (Eds.), *Self-inference processes: The Ontario Symposium* (pp. 217–238). Hillsdale, NJ: Erlbaum.
- Lepper, M. R., Corpus, J. H., & Iyengar, S. S. (2005). Intrinsic and extrinsic motivational orientations in the classroom: Age differences and academic correlates. *Journal of Educational Psychology, 97*, 184–196.
- Lepper, M. R., Greene, D., & Nisbett, R. E. (1973). Understanding children's intrinsic interest with extrinsic reward: A test of the "overjustification" hypothesis. *Journal of Personality and Social Psychology, 28*, 129–137.
- Lepper, M. R., & Hodell, M. (1989). Intrinsic motivation in the classroom. In C. Ames & R. Ames (Eds.), *Research on motivation in education: Vol. 3. Goals and cognitions* (pp. 73–105). San Diego, CA: Academic Press.
- Lerman, D. C., & Iwata, B. A. (1995). Prevalence of the extinction burst and its attenuation during treatment. *Journal of Applied Behavior Analysis, 28*, 93–94.
- Lerman, D. C., Iwata, B. A., & Wallace, M. D. (1999). Side effects of extinction: Prevalence of bursting and aggression during the treatment of self-injurious behavior. *Journal of Applied Behavior Analysis, 32*, 1–8.
- Lerman, D. C., Kelley, M. E., Vorndran, C. M., Kuhn, S. A. C., & LaRue, R. H., Jr. (2002). Reinforcement magnitude and responding during treatment with differential reinforcement. *Journal of Applied Behavior Analysis, 35*, 29–48.
- Lerman, D. C., & Vorndran, C. M. (2002). On the status of knowledge for using punishment: Implications for treating behavior disorders. *Journal of Applied Behavior Analysis, 35*, 431–464.
- Lervåg, A., & Hulme, C. (2009). Rapid automatized naming (RAN) taps a mechanism that places constraints on the development of early reading fluency. *Psychological Science, 20*, 1040–1048.
- Lesgold, A. M., & Lajoie, S. (1991). Complex problem-solving in electronics. In R. J. Sternberg & P. A. Frensch (Eds.), *Complex problem solving: Principles and mechanisms* (pp. 287–316). Hillsdale, NJ: Erlbaum.
- Lester, F. K., Jr. (1985). Methodological considerations in research on mathematical problem-solving instruction. In E. A. Silver (Ed.), *Teaching and learning mathematical problem solving: Multiple research perspectives* (pp. 41–70). Hillsdale, NJ: Erlbaum.
- Leu, D. J., O'Byrne, W. I., Zawilinski, L., McVerry, J. G., & Everett-Cacopardo, H. (2009). Expanding the new literacies conversation. *Educational Researcher, 38*, 264–269.
- Leuner, B., Mendolia-Loffredo, S., Kozorovitskiy, Y., Samburg, D., Gould, E., & Shors, T. J. (2004). Learning enhances the survival of new neurons beyond the time when the hippocampus is required for memory. *Journal of Neuroscience, 24*, 7477–7481.
- Levy, S., Wiesel, T. N., & Hubel, D. H. (1980). The development of ocular dominance columns in normal and visually deprived monkeys. *Journal of Comparative Neurology, 19*, 11–51.
- Levin, J. R., & Mayer, R. E. (1993). Understanding illustrations in text. In B. K. Britton, A. Woodward, & M. Binkley (Eds.), *Learning from textbooks: Theory and practice* (pp. 95–113). Hillsdale, NJ: Erlbaum.
- Levine, M. (1966). Hypothesis behavior by humans during discrimination learning. *Journal of Experimental Psychology, 71*, 331–338.
- Levtstik, L. S. (1993). Building a sense of history in a first-grade classroom. In J. Brophy (Ed.), *Advances in research on teaching: Vol. 4. Case studies of teaching and learning in social studies* (pp. 1–31). Greenwich, CT: JAI Press.
- Levy, I., Kaplan, A., & Patrick, H. (2004). Early adolescents' achievement goals, social status, and attitudes towards cooperation with peers. *Social Psychology of Education, 7*, 127–159.
- Lewis, M., & Sullivan, M. W. (2005). The development of self-conscious emotions. In A. J. Elliot & C. S. Dweck (Eds.), *Handbook of competence and motivation* (pp. 185–201). New York: Guilford Press.
- Lewis, T. J., Newcomer, L. L., Trussell, R., & Richter, M. (2006). Schoolwide positive behavior support: Building systems to develop and maintain appropriate social behavior. In C. M. Everton & C. S. Weinstein (Eds.), *Handbook of classroom management: Research, practice, and contemporary issues* (pp. 833–854). Mahwah, NJ: Erlbaum.
- Li, J. (2003). U.S. and Chinese beliefs about learning. *Journal of Educational Psychology, 95*, 258–267.
- Li, J. (2005). Mind or virtue: Western and Chinese beliefs about learning. *Current Directions in Psychological Science, 14*, 190–194.
- Li, J., & Fischer, K. W. (2004). Thought and affect in American and Chinese learners' beliefs about learning. In D. Y. Dai & R. J. Sternberg (Eds.), *Motivation, emotion, and cognition: Integrative perspectives on intellectual functioning and development* (pp. 385–418). Mahwah, NJ: Erlbaum.
- Liao, Y. K. (1992). Effects of computer-assisted instruction on cognitive outcomes: A meta-analysis. *Journal of Research on Computing in Education, 24*, 367–380.
- Liben, L. S., & Myers, L. J. (2007). Developmental changes in children's understanding of maps: What, when, and how? In J. M. Plumert & J. P. Spencer (Eds.), *The emerging spatial mind* (pp. 193–218). New York: Oxford University Press.
- Lichtman, J. W. (2001). Developmental neurobiology overview: Synapses, circuits, and plasticity. In D. B. Bailey, Jr., J. T. Bruer, F. J. Symons, & J. W. Lichtman (Eds.), *Critical thinking about critical periods* (pp. 27–42). Baltimore: Paul H. Brookes.
- Lidz, C. S., & Gindis, B. (2003). Dynamic assessment of the evolving cognitive functions in children. In A. Kozulin, B. Gindis, V. S. Ageyev, & S. M. Miller (Eds.), *Vygotsky's educational theory in cultural context* (pp. 99–116). Cambridge, England: Cambridge University Press.
- Liem, A. D., Lau, S., & Nie, Y. (2008). The role of self-efficacy, task value, and achievement goals in predicting learning strategies, task disengagement, peer relationship, and achievement outcome. *Contemporary Educational Psychology, 33*, 486–512.
- Lien, M.-C., Ruthruff, E., & Johnston, J. C. (2006). Attentional limitations in doing two tasks at once: The search for exceptions. *Current Directions in Psychological Science, 15*, 89–93.
- Light, P., & Butterworth, G. (Eds.) (1993). *Context and cognition: Ways of learning and knowing*. Hillsdale, NJ: Erlbaum.
- Lightfoot, D. (1999). *The development of language: Acquisition, change, and evolution*. Malden, MA: Blackwell.
- Lillard, A. S. (1997). Other folks' theories of mind and behavior. *Psychological Science, 8*, 268–274.
- Lillard, A. S. (1998). Ethnopsychologies: Cultural variations in theories of mind. *Psychological Bulletin, 123*, 3–33.
- Lima, S. D. (1993). Word-initial letter sequences and reading. *Current Directions in Psychological Science, 2*, 139–142.
- Lin, S.-P., & Hong, H.-Y. (2010, April–May). *Facilitating epistemological belief change among college students in a knowledge building environment*. Paper presented at the annual meeting of the American Educational Research Association, Denver.
- Lin, X. D., & Lehman, J. (1999). Supporting learning of variable control in a computer-based biology environment: Effects of prompted college students to reflect on their own thinking. *Journal of Research in Science Teaching, 36*, 837–858.
- Linderholm, T., & van den Broek, P. (2002). The effects of reading purpose and working memory capacity on the processing of expository text. *Journal of Educational Psychology, 94*, 778–784.
- Lindsay, P. H., & Norman, D. A. (1977). *Human information processing*. New York: Academic Press.
- Linn, M. C. (2008). Teaching for conceptual change: Distinguish or extinguish ideas. In S. Vosniadou (Ed.), *International handbook on conceptual change* (pp. 694–722). New York: Routledge.
- Linn, M. C., Clement, C., Pulos, S., & Sullivan, P. (1989). Scientific reasoning during adolescence: The influence of instruction in science knowledge and reasoning strategies. *Journal of Research in Science Teaching, 26*, 171–187.
- Linn, M. C., & Muilenburg, L. (1996). Creating lifelong science learners: What models form a firm foundation? *Educational Researcher, 25* (5), 18–24.
- Linn, M. C., Songer, N. B., & Eylon, B. (1996). Shifts and convergences in science learning and instruction. In D. C. Berliner & R. C. Calfee (Eds.), *Handbook of educational psychology* (pp. 438–490). New York: Macmillan.
- Linn, R. L. (2000). Assessments and accountability. *Educational Researcher, 29* (2), 4–16.
- Linn, R. L. (2003). Accountability: Responsibility and reasonable expectations. *Educational Researcher, 32*, 3–13.
- Linnenbrink, E. A. (2005). The dilemma of performance-approach goals: The use of multiple

- goal contexts to promote students' motivation and learning. *Journal of Educational Psychology*, 97, 197–213.
- Linnenbrink, E. A., & Pintrich, P. R. (2002). Achievement goal theory and affect: An asymmetrical bidirectional model. *Educational Psychologist*, 37, 69–78.
- Linnenbrink, E. A., & Pintrich, P. R. (2003). Achievement goals and intentional conceptual change. In G. M. Sinatra & P. R. Pintrich (Eds.), *Intentional conceptual change* (pp. 347–374). Mahwah, NJ: Erlbaum.
- Linnenbrink, E. A., & Pintrich, P. R. (2004). Role of affect in cognitive processing in academic contexts. In D. Y. Dai & R. J. Sternberg (Eds.), *Motivation, emotion, and cognition: Integrative perspectives on intellectual functioning and development* (pp. 57–87). Mahwah, NJ: Erlbaum.
- Lippa, R. A. (2002). *Gender, nature, and nurture*. Mahwah, NJ: Erlbaum.
- Lipsitt, L. P., & Kaye, H. (1964). Conditioned sucking in the human newborn. *Psychonomic Science*, 1, 29–30.
- Lipson, M. Y. (1983). The influence of religious affiliation on children's memory for text information. *Reading Research Quarterly*, 18, 448–457.
- Liskowski, U., Schäfer, M., Carpenter, M., & Tomasello, M. (2009). Prelinguistic infants, but not chimpanzees, communicate about absent entities. *Psychological Science*, 20, 654–660.
- Liu, J., Golinkoff, R. M., & Sak, K. (2001). One cow does not an animal make: Young children can extend novel words at the superordinate level. *Child Development*, 72, 1674–1694.
- Locke, E. A., & Latham, G. P. (2002). Building a practically useful theory of goal setting and task motivation: A 35-year odyssey. *American Psychologist*, 57, 705–717.
- Locke, E. A., & Latham, G. P. (2006). New directions in goal-setting theory. *Current Directions in Psychological Science*, 15, 265–268.
- Lockee, B. B., Larson, M. B., Burton, J. K., & Moore, D. M. (2008). Programmed technologies. In J. M. Spector, M. D. Merrill, J. van Merriënboer, & M. P. Driscoll (Eds.), *Handbook of research on educational communications and technology* (3rd ed., pp. 187–197). New York: Erlbaum.
- Lockhart, K. L., Chang, B., & Story, T. (2002). Young children's beliefs about the stability of traits: Protective optimism? *Child Development*, 73, 1408–1430.
- Lodewyk, K. R., & Winne, P. H. (2005). Relations among the structure of learning tasks, achievement, and changes in self-efficacy in secondary students. *Journal of Educational Psychology*, 97, 3–12.
- Loftus, E. F. (1991). Made in memory: Distortions in recollection after misleading information. In G. H. Bower (Ed.), *The psychology of learning and motivation: Advances in research and theory* (Vol. 27, pp. 187–215). San Diego, CA: Academic Press.
- Loftus, E. F. (1992). When a lie becomes memory's truth: Memory distortion after exposure to misinformation. *Current Directions in Psychological Science*, 1, 121–123.
- Loftus, E. F. (1993). The reality of repressed memories. *American Psychologist*, 48, 518–537.
- Loftus, E. F. (2003). Make-believe memories. *American Psychologist*, 58, 867–873.
- Loftus, E. F. (2004). Memories of things unseen. *Current Directions in Psychological Science*, 13, 145–147.
- Loftus, E. F., & Loftus, G. R. (1980). On the permanence of stored information in the human brain. *American Psychologist*, 35, 409–42.
- Loftus, E. F., & Palmer, J. C. (1974). Reconstruction of automobile destruction: An example of the interaction between language and memory. *Journal of Verbal Learning and Verbal Behavior*, 13, 585–589.
- Loftus, G. R., & Loftus, E. F. (1976). *Human memory: The processing of information*. New York: Wiley.
- Logue, A. W. (1979). Taste aversion and the generality of the laws of learning. *Psychological Bulletin*, 86, 276–296.
- Loranger, A. L. (1994). The study strategies of successful and unsuccessful high school students. *Journal of Reading Behavior*, 26, 347–360.
- Lorayne, H., & Lucas, J. (1974). *The memory book*. New York: Stein and Day.
- Lorch, R. F., Jr., Lorch, E. P., Calderhead, W. J., Dunlap, E. E., Hodell, E. C., & Freer, B. D. (2010). Learning the control of variables strategy in higher and lower achieving classrooms: Contributions of explicit instruction and experimentation. *Journal of Educational Psychology*, 102, 90–101.
- Lorch, R. F., Jr., Lorch, E. P., & Inman, W. E. (1993). Effects of signaling topic structure on text recall. *Journal of Educational Psychology*, 85, 281–290.
- Losh, S. C. (2003). On the application of social cognition and social location to creating causal explanatory structures. *Educational Research Quarterly*, 26(3), 17–33.
- Losh, S. C., Tavani, C. M., Njoroge, R., Wilke, R., & McAuley, M. (2003). What does education really do? Educational dimensions and pseudoscience support in the American general public, 1979–2001. *Skeptical Inquirer*, 27(5), 30–35.
- Lotan, R. A. (2006). Managing groupwork in heterogeneous classrooms. In C. M. Evertson & C. S. Weinstein (Eds.), *Handbook of classroom management: Research, practice, and contemporary issues* (pp. 525–539). Mahwah, NJ: Erlbaum.
- Lou, Y., Abrami, P. C., & d'Apollonia, S. (2001). Small group and individual learning with technology: A meta-analysis. *Review of Educational Research*, 71, 449–521.
- Lou, Y., Abrami, P. C., Spence, J. C., Poulsen, C., Chambers, B., & d'Apollonia, S. (1996). Within-class grouping: A meta-analysis. *Review of Educational Research*, 66, 423–458.
- Lovell, K. (1979). Intellectual growth and the school curriculum. In F. B. Murray (Ed.), *The impact of Piagetian theory: On education, philosophy, psychiatry, and psychology*. Baltimore: University Park Press.
- Lovitt, T. C., Guppy, T. E., & Blattner, J. E. (1969). The use of free-time contingency with fourth graders to increase spelling accuracy. *Behaviour Research and Therapy*, 7, 151–156.
- Lu, Z.-L., & Sperling, G. (2003). Measuring sensory memory: Magnetoencephalography habituation and psychophysics. In Z.-L. Lu & L. Kaufman (Eds.), *Magnetic source imaging of the human brain* (pp. 319–342). Mahwah, NJ: Erlbaum.
- Lu, Z.-L., Williamson, S. J., & Kaufman, L. (1992). Physiological measurements predict the lifetime for human auditory memory of a tone. *Science*, 258, 1668–1670.
- Luchins, A. S. (1942). Mechanization in problem solving: The effect of Einstellung. *Psychological Monographs*, 54 (Whole No. 248).
- Luchins, A. S., & Luchins, E. H. (1950). New experimental attempts at preventing mechanization in problem solving. *Journal of General Psychology*, 42, 279–297.
- Luciana, M., Conklin, H. M., Hooper, C. J., & Yarger, R. S. (2005). The development of non-verbal working memory and executive control processes in adolescents. *Child Development*, 76, 697–712.
- Luczynski, K. C., & Hanley, G. P. (2010). Examining the generality of children's preference for contingent reinforcement via extension to different responses, reinforcers, and schedules. *Journal of Applied Behavior Analysis*, 43, 397–409.
- Ludvig, E. A., & Staddon, J. E. R. (2004). The conditions for temporal tracking under interval schedules of reinforcement. *Journal of Experimental Psychology: Animal Behavior Processes*, 30, 299–316.
- Ludwig, T. D., Gray, T. W., & Rowell, A. (1998). Increasing recycling in academic buildings: A systematic replication. *Journal of Applied Behavior Analysis*, 31, 683–686.
- Luna, B., & Sweeney, J. A. (2004). The emergence of collaborative brain function: fMRI studies of the development of response inhibition. *Annals of the New York Academy of Sciences*, 1021, 296–309.
- Lundeberg, M. A., & Fox, P. W. (1991). Do laboratory findings on test expectancy generalize to classroom outcomes? *Review of Educational Research*, 61, 94–106.
- Luque, M. L. (2003). The role of domain-specific knowledge in intentional conceptual change. In G. M. Sinatra & P. R. Pintrich (Eds.), *Intentional conceptual change* (pp. 133–170). Mahwah, NJ: Erlbaum.
- Lustig, C., Konkel, A., & Jacoby, L. L. (2004). Which route to recovery? Controlled retrieval and accessibility bias in retroactive interference. *Psychological Science*, 15, 729–735.
- Luyben, P. D., Hipworth, K., & Pappas, T. (2003). Effects of CAI on the academic performance and attitudes of college students. *Teaching of Psychology*, 30, 154–158.
- Lynn, S. J., Lock, T. G., Myers, B., & Payne, D. G. (1997). Recalling the unrecallable: Should hypnosis be used to recover memories in psychotherapy? *Current Directions in Psychological Science*, 6, 79–83.
- Lyon, T. D., & Flavell, J. H. (1994). Young children's understanding of "remember" and "forget." *Child Development*, 65, 1357–1371.

- MacAndrew, D. K., Klatzky, R. L., Fiez, J. A., McClelland, J. L., & Becker, J. T. (2002). The phonological-similarity effect differentiates between two working memory tasks. *Psychological Science*, *13*, 465–468.
- MacDonald, S., Uesiliana, K., & Hayne, H. (2000). Cross-cultural and gender differences in childhood amnesia. *Memory*, *8*, 365–376.
- Mace, F. C., Belliore, P. J., & Hutchinson, J. M. (2001). Operant theory and research on self-regulation. In B. Zimmerman & D. Schunk (Eds.), *Learning and academic achievement: Theoretical perspectives* (pp. 39–65). Mahwah, NJ: Erlbaum.
- Mace, F. C., Belliore, P. J., & Shea, M. C. (1989). Operant theory and research on self-regulation. In B. J. Zimmerman & D. H. Schunk (Eds.), *Self-regulated learning and academic achievement: Theory, research, and practice* (pp. 27–50). New York: Springer-Verlag.
- Mace, F. C., Hock, M. L., Lalli, J. S., West, B. J., Belliore, P., Pinter, E., & Brown, D. K. (1988). Behavioral momentum in the treatment of noncompliance. *Journal of Applied Behavior Analysis*, *21*, 123–141.
- Macfarlane, A. (1978). What a baby knows. *Human Nature*, *1*, 74–81.
- Mac Iver, D. J., Reuman, D. A., & Main, S. R. (1995). Social structuring of the school: Studying what is, illuminating what could be. In J. T. Spence, J. M. Darley, & D. J. Foss (Eds.), *Annual review of psychology* (Vol. 46, pp. 375–400). Palo Alto, CA: Annual Review.
- Mac Iver, D., Stipek, D. J., & Daniels, D. (1991). Explaining within-semester changes in student effort in junior high school and senior high school courses. *Journal of Educational Psychology*, *83*, 201–211.
- Mack, A. (2003). Inattention blindness: Looking without seeing. *Current Directions in Psychological Science*, *12*, 180–184.
- MacLeod, C. M. (1988). Forgotten but not gone: Savings for pictures and words in long-term memory. *Journal of Experimental Psychology: Learning, Memory, and Cognition*, *14*, 195–212.
- MacLeod, M. D., & Saunders, J. (2008). Retrieval inhibition and memory distortion: Negative consequences of an adaptive process. *Current Directions in Psychological Science*, *17*, 26–30.
- Madjar, N., Kaplan, A., & Weinstock, M. (2010, April–May). *Intrapersonal and task-based standards in mastery avoidance goals: Are they the same achievement goal?* Paper presented at the annual meeting of the American Educational Research Association, Denver.
- Maehr, M. L. (1984). Meaning and motivation: Toward a theory of personal investment. In R. Ames & C. Ames (Eds.), *Research on motivation in education: Vol. 1. Student motivation* (pp. 115–144). Orlando, FL: Academic Press.
- Maehr, M. L., & Anderman, E. M. (1993). Reinventing schools for early adolescents: Emphasizing task goals. *Elementary School Journal*, *93*, 593–610.
- Maehr, M. L., & McInerney, D. M. (2004). Motivation as personal investment. In D. M. McInerney & S. Van Etten (Eds.), *Big theories revisited* (pp. 61–90). Greenwich, CT: Information Age.
- Maehr, M. L., & Meyer, H. A. (1997). Understanding motivation and schooling: Where we've been, where we are, and where we need to go. *Educational Psychology Review*, *9*, 371–409.
- Mager, R. F. (1962). *Preparing instructional objectives*. Belmont, CA: Fearon.
- Mager, R. F. (1972). *Goal analysis*. Belmont, CA: Fearon.
- Mager, R. F. (1984). *Preparing instructional objectives* (2nd ed.). Belmont, CA: David S. Lake.
- Maguire, E. A., Gadian, D. G., Johnsrude, I. S., Good, C. D., Ashburner, J., Frackowiak, R., et al. (2000). Navigation-related structural change in the hippocampi of taxi drivers. *Proceedings of the National Academy of Sciences, USA*, *97*, 4398–4403.
- Mahoney, M. J., & Thoresen, C. E. (1974). *Self-control: Power to the person*. Monterey, CA: Brooks-Cole.
- Maier, N. R. F. (1945). Reasoning in humans III: The mechanisms of equivalent stimuli and of reasoning. *Journal of Experimental Psychology*, *35*, 349–360.
- Maier, N. R. F., & Janzen, J. C. (1968). Functional values as aids and distractors in problem solving. *Psychological Reports*, *22*, 1021–1034.
- Maier, S. F., & Seligman, M. E. P. (1976). Learned helplessness: Theory and evidence. *Journal of Experimental Psychology: General*, *105*, 3–46.
- Maki, R. H. (1998). Test predictions over text material. In D. J. Hacker, J. Dunlosky, & A. C. Graesser (Eds.), *Metacognition in educational theory and practice* (pp. 117–144). Mahwah, NJ: Erlbaum.
- Mandler, J. M. (2003). Conceptual categorization. In D. H. Rakison & L. M. Oakes (Eds.), *Early category and concept development: Making sense of the blooming, buzzing confusion* (pp. 103–131). Oxford, England: Oxford University Press.
- Mandler, J. M. (2007). On the origins of the conceptual system. *American Psychologist*, *62*, 741–751.
- Mandler, J. M., & Johnson, N. S. (1976). Some of the thousand words a picture is worth. *Journal of Experimental Psychology: Human Learning and Memory*, *2*, 529–540.
- Mandler, J. M., & Parker, R. E. (1976). Memory for descriptive and spatial information in complex pictures. *Journal of Experimental Psychology: Human Learning and Memory*, *2*, 38–48.
- Mandler, J. M., & Ritchey, G. H. (1977). Long-term memory for pictures. *Journal of Experimental Psychology: Human Learning and Memory*, *3*, 386–396.
- Marachi, R., Friedel, J., & Midgley, C. (2001, April). "I sometimes annoy my teacher during math": Relations between student perceptions of the teacher and disruptive behavior in the classroom. Paper presented at the annual meeting of the American Educational Research Association, Seattle, WA.
- Marcia, J. E. (1980). Identity in adolescence. In J. Adelson (Ed.), *Handbook of adolescent psychology* (pp. 159–187). New York: Wiley.
- Marcus, G. (2008). *Kluge: The haphazard construction of the human mind*. Boston: Houghton Mifflin.
- Mareschal, D., Johnson, M. H., Sirois, S., Spratling, M. W., Thomas, M. S. C., & Westermann, G. (2007). *Neuroconstructivism: Vol. 1. How the brain constructs cognition*. Oxford, England: Oxford University Press.
- Marian, V., & Neisser, U. (2000). Language-dependent recall of autobiographical memories. *Journal of Experimental Psychology: General*, *129*, 361–368.
- Markman, E. M. (1977). Realizing that you don't understand: A preliminary investigation. *Child Development*, *48*, 986–992.
- Markus, H. R., & Hamedani, M. G. (2007). Sociocultural psychology: The dynamic interdependence among self systems and social systems. In S. Kitayama & D. Cohen (Eds.), *Handbook of cultural psychology* (pp. 3–39). New York: Guilford Press.
- Marley, S. C., Szabo, Z., Levin, J. R., & Glenberg, A. M. (2008, March). *Activity, observed activity, and children's recall of orally presented narrative passages*. Paper presented at the annual meeting of the American Educational Research Association, New York.
- Marmolejo, E. K., Wilder, D. A., & Bradley, L. (2004). A preliminary analysis of the effects of response cards on student performance and participation in an upper division university course. *Journal of Applied Behavior Analysis*, *37*, 405–410.
- Marsh, E. J. (2007). Retelling is not the same as recalling: Implications for memory. *Current Directions in Psychological Science*, *16*, 16–20.
- Marshall, P. J. (2009). Relating psychology and neuroscience. *Perspectives on Psychological Science*, *4*, 113–125.
- Martin, A. J. (2008). Enhancing student motivation and engagement: The effects of a multidimensional intervention. *Contemporary Educational Psychology*, *33*, 239–269.
- Martin, A. J., & Dowson, M. (2009). Interpersonal relationships, motivation, engagement, and achievement: Yields for theory, current issues, and educational practice. *Review of Educational Research*, *79*, 327–365.
- Martin, A. J., Marsh, H. W., & Debus, R. L. (2001). A quadripartite need achievement representation of self-handicapping and defensive pessimism. *American Educational Research Journal*, *38*, 583–610.
- Martin, A. J., Marsh, H. W., Williamson, A., & Debus, R. L. (2003). Self-handicapping, defensive pessimism, and goal orientation: A qualitative study of university students. *Journal of Educational Psychology*, *95*, 617–628.
- Martin, C. L., & Ruble, D. (2004). Children's search for gender cues: Cognitive perspectives on gender development. *Current Directions in Psychological Science*, *13*, 67–70.
- Martin, S. S., Brady, M. P., & Williams, R. E. (1991). Effects of toys on the social behavior of preschool children in integrated and nonintegrated groups: Investigation of a setting event. *Journal of Early Intervention*, *15*, 153–161.
- Martin, T. (2009). A theory of physically distributed learning: How external environments

- and internal states interact in mathematics learning. *Child Development Perspectives*, 3, 140–144.
- Martínez, P., Bannan-Ritland, B., Kitsantas, A., & Baek, J. Y. (2008, March). *The impact of an integrated science reading intervention on elementary children's misconceptions regarding slow geomorphological changes caused by water*. Paper presented at the annual meeting of the American Educational Research Association, New York.
- Marton, F., & Booth, S. (1997). *Learning and awareness*. Mahwah, NJ: Erlbaum.
- Marzano, R. J., & Kendall, J. S. (2007). *The new taxonomy of educational objectives* (2nd ed.). Thousand Oaks, CA: Corwin.
- Maslow, A. H. (1943). A theory of human motivation. *Psychological Review*, 50, 514–539.
- Maslow, A. H. (1959). *New knowledge in human values*. New York: Harper & Row.
- Maslow, A. H. (1973). Theory of human motivation. In R. J. Lowry (Ed.), *Dominance, self-esteem, self-actualization: Germinal papers of A. H. Maslow*. Monterey, CA: Brooks-Cole.
- Maslow, A. H. (1987). *Motivation and personality* (3rd ed.). New York: Harper & Row.
- Mason, L. (2003). Personal epistemologies and intentional conceptual change. In G. M. Sinatra & P. R. Pintrich (Eds.), *Intentional conceptual change* (pp. 199–236). Mahwah, NJ: Erlbaum.
- Mason, L., Gava, M., & Boldrin, A. (2008). On warm conceptual change: The interplay of text, epistemological beliefs, and topic interest. *Journal of Educational Psychology*, 100, 291–309.
- Massimini, M., Ferrarelli, F., Huber, R., Esser, S. K., & Tononi, G. (2005). Breakdown of cortical effective connectivity during sleep. *Science*, 310, 1768–1769.
- Mast, V. K., Fagen, J. W., Rovee-Collier, C. K., & Sullivan, M. W. (1984). Immediate and long-term memory for reinforcement context: The development of learned expectancies in early infancy. *Child Development*, 51, 700–707.
- Masters, J., Russell, M. K., Humez, A., Driscoll, M. J., Wing, R. E., & Nikula, J. (2010, April–May). *The impact of collaborative, scaffolded learning in K–12 schools: A meta-analysis*. Paper presented at the annual meeting of the American Educational Research Association, Denver.
- Mastropieri, M. A., & Scruggs, T. E. (1989). Constructing more meaningful relationships: Mnemonic instruction for special populations. *Educational Psychology Review*, 1, 83–111.
- Mastropieri, M. A., & Scruggs, T. E. (1992). Science for students with disabilities. *Review of Educational Research*, 62, 377–411.
- Masur, E. F., McIntyre, C. W., & Flavell, J. H. (1973). Developmental changes in apportionment of study time among items in a multitrial free recall task. *Journal of Experimental Child Psychology*, 15, 237–246.
- Mathan, S. A., & Koedinger, K. R. (2005). Fostering the intelligent novice: Learning from errors with metacognitive tutoring. *Educational Psychologist*, 40, 257–265.
- Mathes, P. G., Torgesen, J. K., & Allor, J. H. (2001). The effects of peer-assisted literacy strategies for first-grade readers with and without additional computer-assisted instruction. *American Educational Research Journal*, 38, 371–410.
- Matlin, M. W. (2004, April 22). *"But I thought I got an A!"*. *Metacognition and the college student*. Invited address presented in the Department of Psychology, University of New Hampshire, Durham.
- Matthews, G., Zeidner, M., & Roberts, R. D. (2006). Models of personality and affect for education: A review and synthesis. In P. A. Alexander & P. H. Winne (Eds.), *Handbook of educational psychology* (2nd ed., pp. 163–186). Mahwah, NJ: Erlbaum.
- Maurer, D., Lewis, T. L., Brent, H. P., & Levin, A. V. (1999). Rapid improvement in the acuity of infants after visual input. *Science*, 286, 108–110.
- Maus, G. W., & Nijhawan, R. (2008). Motion extrapolation into the blind spot. *Psychological Science*, 19, 1087–1091.
- Maxwell, D., Jarrett, O. S., & Dickerson, C. (1998, April). *Are we forgetting the children's needs? Recess through the children's eyes*. Paper presented at the annual meeting of the American Educational Research Association, San Diego, CA.
- May, D. B., & Etkina, E. (2002). College physics students' epistemological self-reflection and its relationship to conceptual learning. *Physics Education Research: A Supplement to the American Journal of Physics*, 70, 1249–1258.
- Mayer, R. E. (1979). Can advance organizers influence meaningful learning? *Review of Educational Research*, 49, 371–383.
- Mayer, R. E. (1982). Memory for algebra story problems. *Journal of Educational Psychology*, 74, 199–216.
- Mayer, R. E. (1984). Aids to text comprehension. *Educational Psychologist*, 19, 30–42.
- Mayer, R. E. (1987). *Educational psychology: A cognitive approach*. Boston: Little, Brown.
- Mayer, R. E. (1992). *Thinking, problem solving, cognition* (2nd ed.). New York: Freeman.
- Mayer, R. E. (1996). Learning strategies for making sense out of expository text: The SOI model for guiding three cognitive processes in knowledge construction. *Educational Psychology Review*, 8, 357–371.
- Mayer, R. E. (2003). The promise of multimedia learning: Using the same instructional design methods across different media. *Learning and Instruction*, 13, 125–139.
- Mayer, R. E. (2004). Should there be a three-strikes rule against pure discovery learning? *American Psychologist*, 59, 14–19.
- Mayer, R. E. (2008). Applying the science of learning: Evidence-based principles for the design of multimedia instruction. *American Psychologist*, 63, 760–769.
- Mayer, R. E. (2010a). Fostering scientific reasoning with multimedia instruction. In H. S. Waters & W. Schneider (Eds.), *Metacognition, strategy use, and instruction* (pp. 160–175). New York: Guilford Press.
- Mayer, R. E. (2010b). Merlin C. Wittrock's enduring contributions to the science of learning. *Educational Psychologist*, 45, 46–50.
- Mayer, R. E., & Bromage, B. (1980). Different recall protocols for technical texts due to advance organizers. *Journal of Educational Psychology*, 72, 209–225.
- Mayer, R. E., & Greeno, J. G. (1972). Structural differences between learning outcomes produced by different instructional methods. *Journal of Educational Psychology*, 63, 165–173.
- Mayer, R. E., & Massa, L. J. (2003). Three facets of visual and verbal learners: Cognitive ability, cognitive style, and learning preference. *Journal of Educational Psychology*, 95, 833–846.
- Mayer, R. E., Moreno, R., Boire, M., & Vagge, S. (1999). Maximizing constructivist learning from multimedia communications by minimizing cognitive load. *Journal of Educational Psychology*, 91, 638–643.
- Mayer, R. E., & Wittrock, M. C. (1996). Problem-solving transfer. In D. C. Berliner & R. C. Calfee (Eds.), *Handbook of educational psychology* (pp. 47–62). New York: Macmillan.
- Mayer, R. E., & Wittrock, M. C. (2006). Problem solving. In P. A. Alexander & P. H. Winne (Eds.), *Handbook of educational psychology* (2nd ed., pp. 287–303). Mahwah, NJ: Erlbaum.
- Mayfield, K. H., & Chase, P. N. (2002). The effects of cumulative practice on mathematics problem solving. *Journal of Applied Behavior Analysis*, 35, 105–123.
- Maynard, A. E., & Greenfield, P. M. (2003). Implicit cognitive development in cultural tools and children: Lessons from Maya Mexico. *Cognitive Development*, 18, 489–510.
- Mazur, J. E. (1993). Predicting the strength of a conditioned reinforcer: Effects of delay and uncertainty. *Current Directions in Psychological Science*, 2, 70–74.
- Mazzoni, G., & Kirsch, I. (2002). Autobiographical memories and beliefs: A preliminary metacognitive model. In T. J. Perfect & B. L. Schwartz (Eds.), *Applied metacognition* (pp. 121–145). Cambridge, England: Cambridge University Press.
- Mazzoni, G., & Memon, A. (2003). Imagination can create false autobiographical memories. *Psychological Science*, 14, 186–188.
- Mazzoni, G., Scoboria, A., & Harvey, L. (2010). Nonbelieved memories. *Psychological Science*, 21, 1334–1340.
- McAllister, W. R., & McAllister, D. E. (1965). Variables influencing the conditioning and the measurement of acquired fear. In W. F. Prokasy (Ed.), *Classical conditioning*. New York: Appleton-Century-Crofts.
- McAndrew, D. A. (1983). Underlining and note-taking: Some suggestions from research. *Journal of Reading*, 27, 103–108.
- McAshan, H. H. (1979). *Competency-based education and behavioral objectives*. Englewood Cliffs, NJ: Educational Technology.
- McCall, R. B., & Plemons, B. W. (2001). The concept of critical periods and their implications for early childhood services. In

- D. B. Bailey, Jr., J. T. Bruer, F. J. Symons, & J. W. Lichtman (Eds.), *Critical thinking about critical periods* (pp. 267–287). Baltimore: Paul H. Brookes.
- McCallin, R. C., Ormrod, J. E., & Cochran, K. C. (1997, March). *Algorithmic and heuristic learning sets and their relationship to cognitive structure*. Paper presented at the annual meeting of the American Educational Research Association, Chicago.
- McCallum, R. S., & Bracken, B. A. (1993). Interpersonal relations between school children and their peers, parents, and teachers. *Educational Psychology Review*, 5, 155–176.
- McCaslin, M., & Good, T. L. (1996). The informal curriculum. In D. C. Berliner & R. C. Calfee (Eds.), *Handbook of educational psychology* (pp. 622–670). New York: Macmillan.
- McCaslin, M., & Hickey, D. T. (2001). Self-regulated learning and academic achievement: A Vygotskian view. In B. Zimmerman & D. Schunk (Eds.), *Self-regulated learning and academic achievement: Theory, research, and practice* (2nd ed., pp. 227–252). Mahwah, NJ: Erlbaum.
- McCauley, R. N. (1987). The role of theories in a theory of concepts. In U. Neisser (Ed.), *Concepts and conceptual development: Ecological and intellectual factors in categorization* (pp. 288–309). Cambridge, England: Cambridge University Press.
- McClelland, D. C. (1984). *Motives, personality, and society: Selected papers*. New York: Praeger.
- McClelland, D. C., Atkinson, J. W., Clark, R. A., & Lowell, E. L. (1953). *The achievement motive*. New York: Appleton-Century-Crofts.
- McClelland, J. L. (2001). Failures to learn and their remediation: A Hebbian account. In J. L. McClelland & R. S. Siegler (Eds.), *Mechanisms of cognitive development: Behavioral and neural perspectives* (pp. 97–121). Mahwah, NJ: Erlbaum.
- McClelland, J. L., & Rumelhart, D. E. (1986). *Parallel distributed processing* (Vol. 2). Cambridge, MA: MIT Press.
- McClowry, S. G. (1998). The science and art of using temperament as the basis for intervention. *School Psychology Review*, 27, 551–563.
- McCombs, B. L. (1988). Motivational skills training: Combining metacognitive, cognitive, and affective learning strategies. In C. E. Weinstein, E. T. Goetz, & P. A. Alexander (Eds.), *Learning and study strategies: Issues in assessment, instruction, and evaluation* (pp. 141–169). San Diego, CA: Harcourt Brace Jovanovich.
- McCombs, B. L. (1996). Alternative perspectives for motivation. In L. Baker, P. Afllerbach, & D. Reinking (Eds.), *Developing engaged readers in school and home communities* (pp. 67–87). Hillsdale, NJ: Erlbaum.
- McCrary, J. W., & Hunter, W. S. (1953). Serial position curves in verbal learning. *Science*, 117, 131–134.
- McCrudden, M. T., Magliano, J. P., & Schraw, G. (2010). Exploring how relevance instructions affect personal reading intentions, reading goals and text processing: A mixed methods study. *Contemporary Educational Psychology*, 35, 229–241.
- McCrudden, M. T., & Schraw, G. (2007). Relevance and goal-focusing in text processing. *Educational Psychology Review*, 19, 113–139.
- McCrudden, M. T., Schraw, G., & Hartley, K. (2006). The effect of general relevance instructions on shallow and deeper learning and reading time. *Journal of Experimental Education*, 74, 293–310.
- McCrudden, M. T., Schraw, G., & Kambe, G. (2005). The effect of relevance instructions on reading time and learning. *Journal of Educational Psychology*, 97, 88–102.
- McCutchen, D. (1996). A capacity theory of writing: Working memory in composition. *Educational Psychology Review*, 8, 299–325.
- McDaniel, M. A., Anderson, J. L., Derbish, M. H., & Morrisette, N. (2007). Testing the testing effect in the classroom. *European Journal of Cognitive Psychology*, 19, 494–513.
- McDaniel, M. A., & Einstein, G. O. (1989). Material-appropriate processing: A contextualist approach to reading and studying strategies. *Educational Psychology Review*, 1, 113–145.
- McDaniel, M. A., & Masson, M. E. J. (1985). Altering memory representations through retrieval. *Journal of Experimental Psychology: Learning, Memory, and Cognition*, 11, 371–385.
- McDaniel, M. A., & Schlager, M. S. (1990). Discovery learning and transfer of problem-solving skills. *Cognition and Instruction*, 7, 129–159.
- McDaniel, M. A., Waddill, P. J., & Einstein, G. O. (1988). A contextual account of the generation effect: A three-factor theory. *Journal of Memory and Language*, 27, 521–536.
- McDaniel, M. A., Waddill, P. J., Finstad, K., & Bourg, T. (2000). The effects of text-based interest on attention and recall. *Journal of Educational Psychology*, 92, 492–502.
- McDannald, M., & Schoenbaum, G. (2009). Toward a model of impaired reality testing in rats. *Schizophrenia Bulletin*, 35, 664–667.
- McDevitt, T. M., Sheehan, E. P., Cooney, J. B., Smith, H. V., & Walker, I. (1994). Conceptions of listening, learning processes, and epistemologies held by American, Irish, and Australian university students. *Learning and Individual Differences*, 6, 231–256.
- McDevitt, T. M., Spivey, N., Sheehan, E. P., Lennon, R., & Story, R. (1990). Children's beliefs about listening: Is it enough to be still and quiet? *Child Development*, 55, 810–820.
- McDonald, R. V., & Siegel, S. (2004). The potential role of drug onset cues in drug dependence and withdrawal. *Experimental and Clinical Psychopharmacology*, 12, 23–26.
- McDowell, C., & Keenan, M. (2001). Developing fluency and endurance in a child diagnosed with attention deficit hyperactivity disorder. *Journal of Applied Behavior Analysis*, 34, 345–348.
- McGee, K. D., Knight, S. L., & Boudah, D. J. (2001, April). *Using reciprocal teaching in secondary inclusive English classroom instruction*. Paper presented at the annual meeting of the American Educational Research Association, Seattle, WA.
- McGee, L. M. (1992). An exploration of meaning construction in first graders' grand conversations. In C. K. Kinzer & D. J. Leu (Eds.), *Literacy research, theory, and practice: Views from many perspectives* (pp. 177–186). Chicago: National Reading Conference.
- McGeoch, J. A. (1942). *The psychology of human learning*. New York: David McKay.
- McGill, P. (1999). Establishing operations: Implications for the assessment, treatment, and prevention of problem behavior. *Journal of Applied Behavior Analysis*, 32, 393–418.
- McGinnis, M. A., Houchins-Juárez, N., McDaniel, J. L., & Kennedy, C. H. (2010). Abolishing and establishing operation analyses of social attention as positive reinforcement for problem behavior. *Journal of Applied Behavior Analysis*, 43, 119–123.
- McGovern, M. L., Davis, A., & Ogbu, J. U. (2008). The Minority Achievement Committee: Students leading students to greater success in school. In J. U. Ogbu (Ed.), *Minority status, oppositional culture, and schooling* (pp. 560–573). New York: Routledge.
- McGregor, H. A., & Elliot, A. J. (2002). Achievement goals as predictors of achievement-relevant processes prior to task engagement. *Journal of Educational Psychology*, 94, 381–395.
- McGuigan, F., & Salmon, K. (2004). The time to talk: The influence of the timing of adult-child talk on children's event memory. *Child Development*, 75, 669–686.
- McKenzie, H. S., Clark, M., Wolf, M. M., Kothera, R., & Benson, C. (1968). Behavior modification of children with learning disabilities using grades as tokens and allowances as back up reinforcers. *Exceptional Children*, 34, 745–752.
- McKeown, M. G., & Beck, I. L. (1990). The assessment and characterization of young learners' knowledge of a topic in history. *American Educational Research Journal*, 27, 688–726.
- McKeown, M. G., & Beck, I. L. (2009). The role of metacognition in understanding and supporting reading comprehension. In D. J. Hacker, J. Dunlosky, & A. C. Graesser (Eds.), *Handbook of metacognition in education* (pp. 7–25). New York: Routledge.
- McKerchar, P. M., & Thompson, R. H. (2004). A descriptive analysis of potential reinforcement contingencies in the preschool classroom. *Journal of Applied Behavior Analysis*, 37, 431–444.
- McKown, C., & Weinstein, R. S. (2003). The development and consequences of stereotype consciousness in middle childhood. *Child Development*, 74, 498–515.
- McLoyd, V. C. (1998). Socioeconomic disadvantage and child development. *American Psychologist*, 53, 185–204.
- McMillan, J. H. (2010). The practical implications of educational aims and contexts for formative assessment. In H. L. Andrade &

- G. J. Cizek (Eds.), *Handbook of formative assessment* (pp. 41–58). New York: Routledge.
- McNally, R. J. (2003). Recovering memories of trauma: A view from the laboratory. *Current Directions in Psychological Science*, 12, 32–35.
- McNamara, D. S., & Healy, A. F. (1995). A generation advantage for multiplication skill training and nonword vocabulary acquisition. In A. F. Healy & L. E. Bourne, Jr. (Eds.), *Learning and memory of knowledge and skills: Durability and specificity* (pp. 132–167). Thousand Oaks, CA: Sage.
- McNamara, D. S., & Magliano, J. P. (2009). Self-explanation and metacognition: The dynamics of reading. In D. J. Hacker, J. Dunlosky, & A. C. Graesser (Eds.), *Handbook of metacognition in education* (pp. 60–81). New York: Routledge.
- McNeil, N. M., & Jarvin, L. (2007). When theories don't add up: Disentangling the manipulative debate. *Theory into Practice*, 46, 309–316.
- McNeil, N. M., & Uttal, D. H. (2009). Rethinking the use of concrete materials in learning: Perspectives from development and education. *Child Development Perspectives*, 3, 137–139.
- Medin, D. L. (1989). Concepts and conceptual structure. *American Psychologist*, 44, 1469–1481.
- Medin, D. L. (2005, August). *Role of culture and expertise in cognition*. Invited address presented at the annual meeting of the American Psychological Association, Washington, DC.
- Medin, D. L., Unsworth, S. J., & Hirschfeld, L. (2007). Culture, categorization, and reasoning. In S. Kitayama & D. Cohen (Eds.), *Handbook of cultural psychology* (pp. 615–644). New York: Guilford Press.
- Meece, J. L. (1994). The role of motivation in self-regulated learning. In D. H. Schunk & B. J. Zimmerman (Eds.), *Self-regulation of learning and performance: Issues and educational applications* (pp. 25–44). Hillsdale, NJ: Erlbaum.
- Meece, J. L., Wigfield, A., & Eccles, J. S. (1990). Predictors of math anxiety and its influence on young adolescents' course enrollment intentions and performance in mathematics. *Journal of Educational Psychology*, 82, 60–70.
- Meehl, P. E. (1950). On the circularity of the law of effect. *Psychological Bulletin*, 47, 52–75.
- Meichenbaum, D. (1977). *Cognitive-behavior modification: An integrative approach*. New York: Plenum Press.
- Meichenbaum, D. (1985). Teaching thinking: A cognitive-behavioral perspective. In S. F. Chipman, J. W. Segal, & R. Glaser (Eds.), *Thinking and learning skills: Vol. 2. Research and open questions* (pp. 407–426). Hillsdale, NJ: Erlbaum.
- Meinz, E. J., & Hambrick, D. Z. (2010). Deliberate practice is necessary but not sufficient to explain individual differences in piano sight-reading skill: The role of working memory capacity. *Psychological Science*, 21, 914–919.
- Mellers, B. A., & McGraw, A. P. (2001). Anticipated emotions as guides to choice. *Current Directions in Psychological Science*, 10, 210–214.
- Mellers, B. A., Schwartz, A., Ho, K., & Ritov, H. (1997). Decision affect theory: Emotional reactions to the outcomes of risky options. *Psychological Science*, 8, 423–429.
- Meloth, M. S., & Deering, P. D. (1992). Effects of two cooperative conditions on peer-group discussions, reading comprehension, and metacognition. *Contemporary Educational Psychology*, 17, 175–193.
- Meloth, M. S., & Deering, P. D. (1994). Task talk and task awareness under different cooperative learning conditions. *American Educational Research Journal*, 31, 138–165.
- Meloth, M. S., & Deering, P. D. (1999). The role of the teacher in promoting cognitive processing during collaborative learning. In A. M. O'Donnell & A. King (Eds.), *Cognitive perspectives on peer learning* (pp. 235–255). Mahwah, NJ: Erlbaum.
- Melton, A. W., & Irwin, J. M. (1940). The influence of degree of interpolated learning on retroactive inhibition and the overt transfer of specific responses. *American Journal of Psychology*, 53, 173–203.
- Meltzer, L. (Ed.) (2007). *Executive function in education: From theory to practice*. New York: Guilford Press.
- Meltzer, L., & Krishnan, K. (2007). Executive function difficulties and learning disabilities: Understandings and misunderstandings. In L. Meltzer (Ed.), *Executive function in education: From theory to practice* (pp. 77–105). New York: Guilford Press.
- Meltzer, L., Pollica, L. S., & Barzillai, M. (2007). Executive function in the classroom: Embedding strategy instruction into daily teaching practices. In L. Meltzer (Ed.), *Executive function in education: From theory to practice* (pp. 165–193). New York: Guilford Press.
- Meltzoff, A. N., & Moore, M. K. (1977). Imitation of facial and manual gestures by human neonates. *Science*, 198, 75–78.
- Mergendoller, J. R., Markham, T., Ravitz, J., & Larmer, J. (2006). Pervasive management of project based learning: Teachers as guides and facilitators. In C. M. Evertson & C. S. Weinstein (Eds.), *Handbook of classroom management: Research, practice, and contemporary issues* (pp. 583–615). Mahwah, NJ: Erlbaum.
- Merrill, M. D., & Tennyson, R. D. (1977). *Concept teaching: An instructional design guide*. Englewood Cliffs, NJ: Educational Technology.
- Mervis, C. B., Pani, J. R., & Pani, A. M. (2003). Transaction of child cognitive-linguistic abilities and adult input in the acquisition of lexical categories at the basic and subordinate levels. In D. H. Rakison & L. M. Oakes (Eds.), *Early category and concept development: Making sense of the blooming, buzzing confusion* (pp. 242–274). New York: Oxford University Press.
- Merzenich, M. M. (2001). Cortical plasticity contributing to child development. In J. L. McClelland & R. S. Siegler (Eds.), *Mechanisms of cognitive development: Behavioral and neural perspectives* (pp. 67–95). Mahwah, NJ: Erlbaum.
- Mesquita, B., & Leu, J. (2007). The cultural psychology of emotion. In S. Kitayama & D. Cohen (Eds.), *Handbook of cultural psychology* (pp. 734–759). New York: Guilford Press.
- Metcalfe, J. (2009). Metacognitive judgments and control of study. *Current Directions in Psychological Science*, 18, 159–163.
- Metz, K. E. (1995). Reassessment of developmental constraints on children's science instruction. *Review of Educational Research*, 65, 93–127.
- Metz, K. E. (1997). On the complex relation between cognitive developmental research and children's science curricula. *Review of Educational Research*, 67, 151–163.
- Metz, K. E. (2004). Children's understanding of scientific inquiry: Their conceptualizations of uncertainty in investigations of their own design. *Cognition and Instruction*, 22, 291–290.
- Meyer, D. K., & Turner, J. C. (2006). Reconceptualizing emotion and motivation to learn in classroom contexts. *Educational Psychology Review*, 18, 377–390.
- Meyer, K. A. (1999). Functional analysis and treatment of problem behavior exhibited by elementary school children. *Journal of Applied Behavior Analysis*, 32, 229–232.
- Meyer, L. H., Weir, K. F., McClure, J., & Walkey, F. (2008, March). *The relationship of motivation orientations to future achievement in secondary school*. Paper presented at the annual meeting of the American Educational Research Association, New York.
- Mezulis, M. H., Abramson, L. Y., Hyde, J. S., & Hankin, B. L. (2004). Is there a universal positivity bias in attributions? A meta-analytic review of individual, developmental, and cultural differences in the self-serving attributional bias. *Psychological Bulletin*, 130, 711–747.
- Michael, J. (1993). Establishing operations. *The Behavior Analyst*, 16, 191–206.
- Michael, J. (2000). Implications and refinements of the establishing operation concept. *Journal of Applied Behavior Analysis*, 33, 401–410.
- Middleton, M. J., & Midgley, C. (1997). Avoiding the demonstration of lack of ability: An under-explored aspect of goal theory. *Journal of Educational Psychology*, 89, 710–718.
- Middleton, M. J., & Midgley, C. (2002). Beyond motivation: Middle school students' perceptions of press for understanding in math. *Contemporary Educational Psychology*, 27, 373–391.
- Midgley, C. (1993). Motivation and middle level schools. In M. Maehr & P. R. Pintrich (Eds.), *Advances in motivation and achievement* (Vol. 8, pp. 217–274). Greenwich, CT: JAI Press.
- Midgley, C. (Ed.) (2002). *Goals, goal structures, and patterns of adaptive learning*. Mahwah, NJ: Erlbaum.
- Midgley, C., Kaplan, A., & Middleton, M. (2001). Performance-approach goals: Good for what, for whom, under what circumstances,



- and at what cost? *Journal of Educational Psychology*, 93, 77–86.
- Midgley, C., Kaplan, A., Middleton, M., Maehr, M., Urdan, T., Anderman, L., Anderman, E., & Roeser, R. (1998). The development and validation of scales assessing students' achievement goal orientations. *Contemporary Educational Psychology*, 23, 113–131.
- Mikulincer, M. (1994). *Human learned helplessness: A coping perspective*. New York: Plenum Press.
- Milbrath, C., & Siegel, B. (1996). Perspective taking in the drawings of a talented autistic child. *Visual Arts Research*, 22, 56–75.
- Miller, D. L., & Kelley, M. L. (1994). The use of goal setting and contingency contracting for improving children's homework performance. *Journal of Applied Behavior Analysis*, 27, 73–84.
- Miller, G. A. (1956). The magical number seven, plus or minus two: Some limits on our capacity for processing information. *Psychological Review*, 63, 81–97.
- Miller, G. A., Galanter, E., & Pribram, K. H. (1960). *Plans and the structure of behavior*. New York: Holt, Rinehart & Winston.
- Miller, J. G. (1997). A cultural-psychology perspective on intelligence. In R. J. Sternberg & E. L. Grigorenko (Eds.), *Intelligence, heredity, and environment* (pp. 269–302). Cambridge, England: Cambridge University Press.
- Miller, N. E. (1948). Studies of fear as an acquirable drive: I. Fear as motivation and fear-reduction as reinforcement in the learning of new responses. *Journal of Experimental Psychology*, 38, 89–101.
- Miller, N. E., & Dollard, J. C. (1941). *Social learning and imitation*. New Haven, CT: Yale University Press.
- Miller, P. J., Fung, H., & Koven, M. (2007). Narrative reverberations: How participation in narrative practices co-creates persons and cultures. In S. Kitayama & D. Cohen (Eds.), *Handbook of cultural psychology* (pp. 595–614). New York: Guilford Press.
- Miller, R. B., & Brickman, S. J. (2004). A model of future-oriented motivation and self-regulation. *Educational Psychology Review*, 16, 9–33.
- Miller, R. B., Greene, B. A., & Dillon, C. L. (2010, April–May). *Perceived instrumentality, achievement goals, and deep processing: Direct or mediated effects?* Paper presented at the annual meeting of the American Educational Research Association, Denver.
- Miller, R. R., & Barnet, R. C. (1993). The role of time in elementary associations. *Current Directions in Psychological Science*, 2, 106–111.
- Miller, S., Heafner, T., & Massey, D. (2009). High-school teachers' attempts to promote self-regulated learning: "I may learn from you, yet how do I do it?" *Urban Review*, 41, 121–140.
- Miller, S. D., & Meece, J. L. (1997). Enhancing elementary students' motivation to read and write: A classroom intervention study. *Journal of Educational Research*, 90, 286–300.
- Miller, S. M. (2003). How literature discussion shapes thinking: ZPDs for teaching/learning habits of the heart and mind. In A. Kozulin, B. Gindis, V. S. Ageyev, & S. M. Miller (Eds.), *Vygotsky's educational theory in cultural context* (pp. 289–316). Cambridge, England: Cambridge University Press.
- Millroy, W. L. (1991). An ethnographic study of the mathematical ideas of a group of carpenters. *Learning and Individual Differences*, 3, 1–25.
- Mills, D. L., & Sheehan, E. A. (2007). Experience and developmental changes in the organization of language-relevant brain activity. In D. Coch, K. W. Fischer, & G. Dawson (Eds.), *Human behavior, learning, and the developing brain: Typical development* (pp. 183–218). New York: Guilford Press.
- Mineka, S., & Zinbarg, R. (2006). A contemporary learning theory perspective on the etiology of anxiety disorders: It's not what you thought it was. *American Psychologist*, 61, 10–26.
- Minogue, J., & Jones, M. G. (2006). Haptics in education: Exploring an untapped sensory modality. *Review of Educational Research*, 76, 317–348.
- Minsky, M. (2006). *The emotion machine: Commonsense thinking, artificial intelligence, and the future of the human mind*. New York: Simon & Schuster.
- Minstrell, J., & Stimpson, V. (1996). A classroom environment for learning: Guiding students' reconstruction of understanding and reasoning. In L. Schauble & R. Glaser (Eds.), *Innovations in learning: New environments for education* (pp. 175–202). Mahwah, NJ: Erlbaum.
- Mintrop, H., & Sunderman, G. L. (2009). Predictable failure of federal sanctions-driven accountability for school improvement—And why we may retain it anyway. *Educational Researcher*, 38, 353–364.
- Mintzes, J. J., Trowbridge, J. E., Arnaudin, M. W., & Wandersee, J. H. (1991). Children's biology: Studies on conceptual development in the life sciences. In S. M. Glynn, R. H. Yeany, & B. K. Britton (Eds.), *The psychology of learning science* (pp. 179–204). Hillsdale, NJ: Erlbaum.
- Mintzes, J. J., Wandersee, J. H., & Novak, J. D. (1997). Meaningful learning in science: The human constructivist perspective. In G. D. Phye (Ed.), *Handbook of academic learning: Construction of knowledge* (pp. 405–447). San Diego, CA: Academic Press.
- Mitchell, D. B. (2006). Nonconscious priming after 17 years: Invulnerable implicit memory? *Psychological Science*, 17, 925–929.
- Mitchell, J. B. (1989). Current theories on expert and novice thinking: A full faculty considers the implications for legal education. *Journal of Legal Education*, 39, 275–297.
- Mitchell, M. (1993). Situational interest: Its multifaceted structure in the secondary school mathematics classroom. *Journal of Educational Psychology*, 85, 424–436.
- Mitchell, T. V. (2007). Effects of blindness and deafness on the development of spatial perception and cognition. In J. M. Plumert & J. P. Spencer (Eds.), *The emerging spatial mind* (pp. 263–289). New York: Oxford University Press.
- Mithaug, D. K., & Mithaug, D. E. (2003). Effects of teacher-directed versus student-directed instruction on self-management of young children with disabilities. *Journal of Applied Behavior Analysis*, 36, 133–136.
- Miyake, N. (2008). Conceptual change through collaboration. In S. Vosniadou (Ed.), *International handbook on conceptual change* (pp. 453–478). New York: Routledge.
- Moely, B. E. (1977). Organizational factors in the development of memory. In R. V. Kail & J. W. Hagen (Eds.), *Perspectives on the development of memory and cognition* (pp. 203–236). Hillsdale, NJ: Erlbaum.
- Mohatt, G., & Erickson, F. (1981). Cultural differences in teaching styles in an Odawa school: A sociolinguistic approach. In H. T. Trueba, G. P. Guthrie, & K. H. Au (Eds.), *Culture and the bilingual classroom: Studies in classroom ethnography* (pp. 105–119). Rowley, MA: Newbury House.
- Moje, E. B., & Shepardson, D. P. (1998). Social interactions and children's changing understanding of electric circuits: Exploring unequal power relations in "peer"-learning groups. In B. Guzzetti & C. Hynd (Eds.), *Perspectives on conceptual change: Multiple ways to understand knowing and learning in a complex world* (pp. 225–234). Mahwah, NJ: Erlbaum.
- Monte-Sano, C. (2008). Qualities of historical writing instruction: A comparative case study of two teachers' practices. *American Educational Research Journal*, 45, 1045–1079.
- Moon, J. (2008). *Critical thinking: An exploration of theory and practice*. London: Routledge.
- Mooney, C. M. (1957). Age in the development of closure ability in children. *Canadian Journal of Psychology*, 11, 219–226.
- Moran, S., & John-Steiner, V. (2003). Creativity in the making: Vygotsky's contemporary contribution to the dialectic of development and creativity. In R. K. Sawyer, V. John-Steiner, S. Moran, R. J. Sternberg, D. H. Feldman, J. Nakamura, & M. Csikszentmihalyi (Eds.), *Creativity and development* (pp. 61–90). Oxford, England: Oxford University Press.
- Morelli, G. A., & Rothbaum, F. (2007). Situating the child in context: Attachment relationships and self-regulation in different cultures. In S. Kitayama & D. Cohen (Eds.), *Handbook of cultural psychology* (pp. 500–527). New York: Guilford Press.
- Moreno, R. (2006). Learning in high-tech and multimedia environments. *Current Directions in Psychological Science*, 15, 63–67.
- Morgan, M. (1984). Reward-induced decrements and increments in intrinsic motivation. *Review of Educational Research*, 54, 5–30.
- Morgan, M. (1985). Self-monitoring of attained subgoals in private study. *Journal of Educational Psychology*, 77, 623–630.
- Morra, S., Gobbo, C., Marini, Z., & Sheese, R. (2008). *Cognitive development: Neo-Piagetian perspectives*. New York: Erlbaum.
- Morris, C. D., Bransford, J. D., & Franks, J. J. (1977). Levels of processing versus transfer

- appropriate processing. *Journal of Verbal Learning and Verbal Behavior*, 16, 519–533.
- Mosborg, S. (2002). Speaking of history: How adolescents use their knowledge of history in reading the daily news. *Cognition and Instruction*, 20, 323–358.
- Mowrer, O. H. (1938). Preparatory set (expectancy): A determinant in motivation and learning. *Psychological Review*, 45, 62–91.
- Mowrer, O. H. (1939). A stimulus-response analysis and its role as a reinforcing agent. *Psychological Review*, 46, 553–565.
- Mowrer, O. H. (1956). Two-factor learning theory reconsidered, with special reference to secondary reinforcement and the concept of habit. *Psychological Review*, 63, 114–128.
- Mowrer, O. H. (1960). *Learning theory and behavior*. New York: Wiley.
- Mueller, C. M., & Dweck, C. S. (1998). Intelligence praise can undermine motivation and performance. *Journal of Personality and Social Psychology*, 75, 33–52.
- Mueller, M. M., Sterling-Turner, H. E., & Scatone, D. (2001). Functional assessment of hand flapping in a general education classroom. *Journal of Applied Behavior Analysis*, 34, 233–236.
- Muis, K. R. (2004). Personal epistemology and mathematics: A critical review and synthesis of research. *Review of Educational Research*, 74, 317–377.
- Muis, K. R. (2007). The role of epistemic beliefs in self-regulated learning. *Educational Psychologist*, 42, 173–190.
- Muis, K. R., Bendixen, L. D., & Haerle, F. C. (2006). Domain-general and domain-specificity in personal epistemology research: Philosophical and empirical reflections in the development of a theoretical framework. *Educational Psychology Review*, 18, 3–54.
- Muis, K. R., & Franco, G. M. (2009). Epistemic beliefs: Setting the standards for self-regulated learning. *Contemporary Educational Psychology*, 34, 306–318.
- Mullen, M. K., & Yi, S. (1995). The cultural context of talk about the past: Implications for the development of autobiographical memory. *Cognitive Development*, 10, 407–419.
- Mumme, D. L., & Fernald, A. (2003). The infant as onlooker: Learning from emotional reactions observed in a television scenario. *Child Development*, 74, 221–237.
- Mundy, P., & Newell, L. (2007). Attention, joint attention, and social cognition. *Current Directions in Psychological Science*, 16, 269–274.
- Munro, D. W., & Stephenson, J. (2009). The effects of response cards on student and teacher behavior during vocabulary instruction. *Journal of Applied Behavior Analysis*, 42, 795–800.
- Murata, A., Fadiga, L., Fogassi, L., Gallese, V., Raos, V., & Rizzolatti, G. (1997). Object representation in the ventral premotor cortex (area F5) of the monkey. *Journal of Neurophysiology*, 78, 2226–2230.
- Murdock, T. B. (1999). The social context of risk: Status and motivational predictors of alienation in middle school. *Journal of Educational Psychology*, 91, 62–75.
- Murphy, E. S., McSweeney, F. K., Smith, R. G., & McComas, J. J. (2003). Dynamic changes in reinforcer effectiveness: Theoretical, methodological, and practical implications for applied research. *Journal of Applied Behavior Analysis*, 36, 421–438.
- Murphy, P. K. (2007). The eye of the beholder: The interplay of social and cognitive components in change. *Educational Psychologist*, 42, 41–53.
- Murphy, P. K., & Alexander, P. A. (2000). A motivated exploration of motivation terminology. *Contemporary Educational Psychology*, 25, 3–53.
- Murphy, P. K., & Alexander, P. A. (2008). Examining the influence of knowledge, beliefs, and motivation in conceptual change. In S. Vosniadou (Ed.), *Handbook of research on conceptual change* (pp. 583–616). New York: Taylor and Francis.
- Murphy, P. K., & Mason, L. (2006). Changing knowledge and beliefs. In P. A. Alexander & P. H. Winne (Eds.), *Handbook of educational psychology* (2nd ed., pp. 305–324). Mahwah, NJ: Erlbaum.
- Murray, C. B., & Jackson, J. S. (1982/1983). The conditioned failure model of black educational underachievement. *Humboldt Journal of Social Relations*, 10, 276–300.
- Murray, L., de Rosnay, M., Pearson, J., Bergeron, C., Schofield, E., Royal-Lawson, M., et al. (2008). Intergenerational transmission of social anxiety: The role of social referencing processes in infancy. *Child Development*, 79, 1049–1064.
- Mwangi, W., & Sweller, J. (1998). Learning to solve compare word problems: The effect of example format and generating self-explanations. *Cognition and Instruction*, 16, 173–199.
- Myin, E., & O'Regan, J. K. (2009). Situated perception and sensation in vision and other modalities. In P. Robbins & M. Aydede (Eds.), *The Cambridge handbook of situated cognition* (pp. 185–200). Cambridge, England: Cambridge University Press.
- Nadel, L. (2005, August). *Memory, stress, and the brain: In Miller's footsteps*. Invited address presented at the annual meeting of the American Psychological Association, Washington, DC.
- Nadel, L., & Jacobs, W. J. (1998). Traumatic memory is special. *Current Directions in Psychological Science*, 7, 154–157.
- Nairne, J. S., Pandeirada, J. N. S., & Thompson, S. R. (2008). Adaptive memory: The comparative value of survival processing. *Psychological Science*, 19, 176–180.
- Narciss, S. (2008). Feedback strategies for interactive learning tasks. In J. M. Spector, M. D. Merrill, J. van Merriënboer, & M. P. Driscoll (Eds.), *Handbook of research on educational communications and technology* (3rd ed., pp. 125–143). New York: Erlbaum.
- Naumann, J., Richter, T., Flender, J., Christmann, U., & Groeben, N. (2007). Signaling in expository hypertexts compensates for deficits in reading skill. *Journal of Educational Psychology*, 99, 791–807.
- Naveh-Benjamin, M. (1991). A comparison of training programs intended for different types of text-anxious students: Further support for an information-processing model. *Journal of Educational Psychology*, 83, 134–139.
- Nee, D. E., Berman, M. G., Moore, K. S., & Jonides, J. (2008). Neuroscientific evidence about the distinction between short- and long-term memory. *Current Directions in Psychological Science*, 17, 102–106.
- Neisser, U. (1967). *Cognitive psychology*. New York: Appleton-Century-Crofts.
- Neisser, U., & Harsch, N. (1992). Phantom flashbulbs: False recollections of hearing the news about Challenger. In E. Winograd & U. Neisser (Eds.), *Affect and accuracy in recall: Studies of "flashbulb" memories* (pp. 9–31). Cambridge, England: Cambridge University Press.
- Nelson, C. A. (1995). The ontogeny of human memory: A cognitive neuroscience perspective. *Developmental Psychology*, 31, 723–738.
- Nelson, C. A., III, Thomas, K. M., & de Haan, M. (2006). Neural bases of cognitive development. In D. Kuhn, R. Siegler (Vol. Eds.), W. Damon, & R. M. Lerner (Series Eds.), *Handbook of child psychology*. Vol. 2: *Cognition, perception, and language* (6th ed., pp. 3–57). New York: Wiley.
- Nelson, K. (1996). *Language in cognitive development: The emergence of the mediated mind*. Cambridge, England: Cambridge University Press.
- Nelson, K., & Fivush, R. (2004). The emergence of autobiographical memory: A social cultural developmental theory. *Psychological Review*, 111, 486–511.
- Nelson, L. J., & Miller, D. T. (1995). The distinctiveness effect in social categorization: You are what makes you unusual. *Psychological Science*, 6, 246–249.
- Nelson, T. O. (1971). Savings and forgetting from long-term memory. *Journal of Verbal Learning and Verbal Behavior*, 10, 568–576.
- Nelson, T. O. (1977). Repetition and depth of processing. *Journal of Verbal Learning and Verbal Behavior*, 16, 151–171.
- Nelson, T. O. (1978). Detecting small amounts of information in memory: Savings for nonrecognized items. *Journal of Experimental Psychology: Human Learning and Memory*, 4, 453–468.
- Nelson, T. O., & Dunlosky, J. (1991). When people's judgments of learning (JOLs) are extremely accurate at predicting subsequent recall: The "delayed-JOL effect." *Psychological Science*, 2, 267–270.
- Nelson, T. O., & Rothbart, R. (1972). Acoustic savings for items forgotten from long-term memory. *Journal of Experimental Psychology*, 93, 357–360.
- Nenty, H. J., & Ogunu, N. E. (2009). Influence of gender and learned helplessness on some mathematics-related cognitive behaviour of Lesotho senior secondary school students. *Gender and Behaviour*, 7, 2123–2135.
- Nersessian, N. J. (2008). Mental modeling in conceptual change. In S. Vosniadou (Ed.), *International handbook on conceptual change* (pp. 391–416). New York: Routledge.

- Nesbit, J. C., & Adesope, O. O. (2006). Learning with concept and knowledge maps: A meta-analysis. *Review of Educational Research, 76*, 413-448.
- Neumann, P. G. (1974). An attribute frequency model for the abstraction of prototypes. *Memory and Cognition, 2*, 241-248.
- Neumann, P. G. (1977). Visual prototype formation with discontinuous representation of dimensions of variability. *Memory and Cognition, 5*, 187-197.
- Neumann, R. (2000). The causal influences of attributions on emotions: A procedural priming approach. *Psychological Science, 11*, 179-182.
- Neville, H. J., & Bruer, J. T. (2001). Language processing: How experience affects brain organization. In D. B. Bailey, Jr., J. T. Bruer, F. J. Symons, & J. W. Lichtman (Eds.), *Critical thinking about critical periods* (pp. 151-172). Baltimore: Paul H. Brookes.
- Nevin, J. A., Mandell, C., & Atak, J. R. (1983). The analysis of behavioral momentum. *Journal of the Experimental Analysis of Behavior, 39*, 49-59.
- Newberg, N. A., & Sims, R. B. (1996). Contexts that promote success for inner-city students. *Urban Education, 31*, 149-176.
- Newby, T. J., Ertmer, P. A., & Stepich, D. A. (1994, April). *Instructional analogies and the learning of concepts*. Paper presented at the annual meeting of the American Educational Research Association, New Orleans, LA.
- Newcombe, N. S., Drummey, A. B., Fox, N. A., Lie, E., & Ottinger-Albergs, W. (2000). Remembering early childhood: How much, how, and why (or why not). *Current Directions in Psychological Science, 9*, 55-58.
- Newcombe, N. S., & Fox, N. A. (1994). Infantile amnesia: Through a glass darkly. *Child Development, 65*, 31-40.
- Newcombe, N. S., & Huttenlocher, J. (1992). Children's early ability to solve perspective-taking problems. *Developmental Psychology, 28*, 635-643.
- Newell, A., Shaw, J. C., & Simon, H. A. (1958). Elements of a theory of human problem solving. *Psychological Review, 65*, 151-166.
- Newell, A., & Simon, H. A. (1972). *Human problem solving*. Englewood Cliffs, NJ: Prentice Hall.
- Newman, R. S. (1998). Students' help seeking during problem solving: Influences of personal and contextual achievement goals. *Journal of Educational Psychology, 90*, 644-658.
- Newman, R. S. (2008). Adaptive and nonadaptive help seeking with peer harassment: An integrative perspective of coping and self-regulation. *Educational Psychologist, 43*, 1-15.
- Newman, R. S., & Schwager, M. T. (1992). Student perceptions and academic help seeking. In D. Schunk & J. Meece (Eds.), *Student perceptions in the classroom* (pp. 123-146). Hillsdale, NJ: Erlbaum.
- Newman, R. S., & Schwager, M. T. (1995). Students' help seeking during problem solving: Effects of grade, goal, and prior achievement. *American Educational Research Journal, 32*, 352-376.
- Newport, E. L. (1990). Maturation constraints on language learning. *Cognitive Science, 14*, 11-28.
- Newson, J., & Newson, E. (1975). Intersubjectivity and the transmission of culture: On the origins of symbolic functioning. *Bulletin of the British Psychological Society, 28*, 437-446.
- Newstead, S. (2004). The purposes of assessment. *Psychology of Learning and Teaching, 3*, 97-101.
- Nguyen, S. P., & Murphy, G. L. (2003). An apple is more than just a fruit: Cross-classification in children's concepts. *Child Development, 74*, 1783-1806.
- Ni, Y., & Zhou, Y.-D. (2005). Teaching and learning fraction and rational numbers: The origins and implications of whole number bias. *Educational Psychologist, 40*, 27-52.
- NICHD Early Child Care Research Network. (2002). Early child care and children's development prior to school entry: Results from the NICHD study of early child care. *American Educational Research Journal, 39* (1), 133-164.
- Nicholls, J. G. (1984). Conceptions of ability and achievement motivation. In R. Ames & C. Ames (Eds.), *Research on motivation in education: Vol. 1. Student motivation* (pp. 185-218). Orlando, FL: Academic Press.
- Nicholls, J. G. (1990). What is ability and why are we mindful of it? A developmental perspective. In R. J. Sternberg & J. Kolligian (Eds.), *Competence considered* (pp. 11-40). New Haven, CT: Yale University Press.
- Nicholls, J. G. (1992). Students as educational theorists. In D. Schunk & J. L. Meece (Eds.), *Student perception in the classroom* (pp. 267-286). Hillsdale, NJ: Erlbaum.
- Nicholls, J. G., Cobb, P., Yackel, E., Wood, T., & Wheatley, G. (1990). Students' theories of mathematics and their mathematical knowledge: Multiple dimensions of assessment. In G. Kulm (Ed.), *Assessing higher order thinking in mathematics* (pp. 137-154). Washington, DC: American Association for the Advancement of Science.
- Nichols, J. D. (1996). The effects of cooperative learning on student achievement and motivation in a high school geometry class. *Contemporary Educational Psychology, 21*, 467-476.
- Nichols, J. D., Ludwin, W. G., & Iadicola, P. (1999). A darker shade of gray: A year-end analysis of discipline and suspension data. *Equity and Excellence in Education, 32* (1), 43-55.
- Nichols, S. R., Svetlova, M., & Brownell, C. A. (2010). Toddlers' understanding of peers' emotions. *Journal of Genetic Psychology: Research and Theory on Human Development, 171*, 35-53.
- Nickerson, R. S. (1989). New directions in educational assessment. *Educational Researcher, 18* (9), 3-7.
- Nickerson, R. S., & Adams, M. J. (1979). Long-term memory for a common object. *Cognitive Psychology, 1*, 287-307.
- Niederhauser, D. S. (2008). Educational hyper-text. In J. M. Spector, M. D. Merrill, J. van Merriënboer, & M. P. Driscoll (Eds.), *Handbook of research on educational communications and technology* (3rd ed., pp. 199-210). New York: Erlbaum.
- Nielsen, M., & Tomaselli, K. (2010). Overimitation in Kalahari bushman children and the origins of human cultural cognition. *Psychological Science, 21*, 729-736.
- Nietfeld, J. L., & Cao, L. (April, 2004). *The effect of distributed monitoring exercises and feedback on performance and monitoring accuracy*. Paper presented at the American Educational Research Association, San Diego, CA.
- Nikopoulos, C. K., & Keenan, M. (2004). Effects of video modeling on social initiations by children with autism. *Journal of Applied Behavior Analysis, 37*, 93-96.
- Nisbett, R. E. (2009). *Intelligence and how to get it*. New York: W. W. Norton.
- Nisbett, R. E., & Wilson, T. D. (1977). Telling more than we can know: Verbal reports on mental processes. *Psychological Review, 84*, 231-259.
- Nist, S. L., Simpson, M. L., Olejnik, S., & Mealey, D. L. (1991). The relation between self-selected study processes and test performance. *American Educational Research Journal, 28*, 849-874.
- Nokes, J. D., & Dole, J. A. (2004). Helping adolescent readers through explicit strategy instruction. In T. L. Jetton & J. A. Dole (Eds.), *Adolescent literacy research and practice* (pp. 162-182). New York: Guilford Press.
- Nolen, S. B. (1996). Why study? How reasons for learning influence strategy selection. *Educational Psychology Review, 8*, 335-355.
- Nolen, S. B. (2007). Young children's motivation to read and write: Development in social contexts. *Cognition and Instruction, 25*, 219-270.
- Nordgren, J., Janczak, A. M., Hovland, A. L., Ranheim, B., & Horsberg, T. E. (2010). Trace classical conditioning in rainbow trout (*Oncorhynchus mykiss*): What do they learn? *Animal Cognition, 13*, 303-309.
- Norman, D. A. (1969). *Memory and attention: An introduction to human information processing*. New York: Wiley.
- Norman, D. A., & Rumelhart, D. E. (1975). *Explorations in cognition*. San Francisco: Freeman.
- Normandeau, S., & Gobeil, A. (1998). A developmental perspective on children's understanding of causal attributions in achievement-related situations. *International Journal of Behavioral Development, 22*, 611-632.
- Northup, J. (2000). Further evaluation of the accuracy of reinforcer surveys: A systematic replication. *Journal of Applied Behavior Analysis, 33*, 335-338.
- Northup, J., Broussard, C., Jones, K. George, T., Vollmer, T. R., & Herring, M. (1995). The differential effects of teachers and peer attention on the disruptive classroom behavior of three children with a diagnosis of attention deficit hyperactivity disorder. *Journal of Applied Behavior Analysis, 28*, 227-228.

- Novak, J. D. (1998). *Learning, creating, and using knowledge: Concept maps as facilitative tools in schools and corporations*. Mahwah, NJ: Erlbaum.
- Novak, J. D., & Gowin, D. B. (1984). *Learning how to learn*. Cambridge, England: Cambridge University Press.
- Novak, J. D., & Musonda, D. (1991). A twelve-year longitudinal study of science concept learning. *American Educational Research Journal*, 28, 117–153.
- Novick, L. R. (1988). Analogical transfer, problem similarity, and expertise. *Journal of Experimental Psychology: Learning, Memory, and Cognition*, 14, 510–520.
- Nucci, L. P. (2001). *Education in the moral domain*. Cambridge, England: Cambridge University Press.
- Núñez, J. C., González-Pienda, J. A., González-Pumariega, S., Roces, C., Alvarez, L., González, P., et al. (2005). Subgroups of attribution profiles in students with learning disabilities and their relation to self-concept and academic goals. *Learning Disabilities Research and Practice*, 20, 86–97.
- Nussbaum, E. M. (2008). Collaborative discourse, argumentation, and learning: Preface and literature review. *Contemporary Educational Psychology*, 33, 345–359.
- Nuthall, G. (2000). The anatomy of memory in the classroom: Understanding how students acquire memory processes from classroom activities in science and social studies units. *American Educational Research Journal*, 37, 247–304.
- Oakes, L. M., & Bauer, P. J. (Eds.) (2007). *Short- and long-term memory in infancy and early childhood: Taking the first steps toward remembering*. New York: Oxford University Press.
- Oakes, L. M., & Rakison, D. H. (2003). Issues in the early development of concepts and categories: An introduction. In D. H. Rakison & L. M. Oakes (Eds.), *Early category and concept development: Making sense of the blooming, buzzing confusion* (pp. 3–23). Oxford, England: Oxford University Press.
- Oakhill, J. (1993). Children's difficulties in reading comprehension. *Educational Psychology Review*, 5, 223–237.
- Oakhill, J., Cain, K., & Yuill, N. (1998). Individual differences in children's comprehension skill: Toward an integrated model. In C. Hulme & R. M. Joshi (Eds.), *Reading and spelling: Development and disorders* (pp. 343–367). Mahwah, NJ: Erlbaum.
- Oatley, K., & Nundy, S. (1996). Rethinking the role of emotions in education. In D. R. Olson & N. Torrance (Eds.), *The handbook of education and human development: New models of learning, teaching, and schooling* (pp. 257–274). Cambridge, MA: Blackwell.
- Oberheim, N. A., Takano, T., Han, X., He, W., Lin, J. H. C., Wang, F., et al. (2009). Uniquely hominid features of adult human astrocytes. *Journal of Neuroscience*, 29, 3276–3287.
- O'Brien, G. (1999). A connectionist theory of phenomenal experience. *Behavioral and Brain Sciences*, 22, 127–196.
- Odegard, T. N., Cooper, C. M., Lampinen, J. M., Reyna, V. F., & Brainerd, C. J. (2009). Children's eyewitness memory for multiple real-life events. *Child Development*, 80, 1877–1890.
- O'Donnell, A. M. (1999). Structuring dyadic interaction through scripted cooperation. In A. M. O'Donnell & A. King (Eds.), *Cognitive perspectives on peer learning* (pp. 179–196). Mahwah, NJ: Erlbaum.
- O'Donnell, A. M. (2006). The role of peers and group learning. In P. A. Alexander & P. H. Winne (Eds.), *Handbook of educational psychology* (2nd ed., pp. 781–802). Mahwah, NJ: Erlbaum.
- O'Donnell, A. M., Dansereau, D. F., & Hall, R. H. (2002). Knowledge maps as scaffolds for cognitive processing. *Educational Psychology Review*, 14, 71–86.
- O'Donnell, A. M., & King, A. (Eds.) (1999). *Cognitive perspectives on peer learning*. Mahwah, NJ: Erlbaum.
- O'Donnell, A. M., & O'Kelly, J. (1994). Learning from peers: Beyond the rhetoric of positive results. *Educational Psychology Review*, 6, 321–349.
- O'Grady, W. (1997). *Syntactic development*. Chicago: University of Chicago.
- Ohlsson, S. (2009). Resubsumption: A possible mechanism for conceptual change and belief revision. *Educational Psychologist*, 44, 20–40.
- Ohman, A., & Mineka, S. (2003). The malicious serpent: Snakes as a prototypical stimulus for an evolved module of fear. *Current Directions in Psychological Science*, 12, 5–9.
- Olds, J., & Milner, P. (1954). Positive reinforcement produced by electrical stimulation of septal area and other regions of rat brain. *Journal of Comparative and Physiological Psychology*, 47, 419–427.
- Olneck, M. R. (1995). Immigrants and education. In J. A. Banks & C. A. M. Banks (Eds.), *Handbook of research on multicultural education* (pp. 310–330). New York: Macmillan.
- Olson, M. A., & Fazio, R. H. (2001). Implicit attitude formation through classical conditioning. *Psychological Science*, 12, 413–417.
- O'Mara, A. J., Marsh, H. W., Craven, R. G., & Debus, R. L. (2006). Do self-concept interventions make a difference? A synergistic blend of construct validation and meta-analysis. *Educational Psychologist*, 41, 181–206.
- Onosko, J. J. (1996). Exploring issues with students despite the barriers. *Social Education*, 60 (1), 22–27.
- Onosko, J. J., & Newmann, F. M. (1994). Creating more thoughtful learning environments. In J. N. Mangieri & C. C. Block (Eds.), *Creating powerful thinking in teachers and students: Diverse perspectives* (pp. 27–50). Fort Worth, TX: Harcourt Brace.
- Opfer, J. E., & Doumas, L. A. A. (2008). Analogy and conceptual change in childhood. *Behavioral and Brain Sciences*, 31, 723.
- Ormrod, J. E. (1979). Cognitive processes in the solution of three-term series problems. *American Journal of Psychology*, 92, 235–255.
- Ormrod, J. E. (1985). Proofreading *The Cat in the Hat*: Evidence for different reading styles of good and poor spellers. *Psychological Reports*, 57, 863–867.
- Ormrod, J. E. (1986a). Differences between good and poor spellers in reading style and short-term memory. *Visible Language*, 20, 437–447.
- Ormrod, J. E. (1986b). Learning to spell: Three studies at the university level. *Research in the Teaching of English*, 20, 160–173.
- Ormrod, J. E. (1986c). Learning to spell while reading: A follow-up study. *Perceptual and Motor Skills*, 63, 652–654.
- Ormrod, J. E., Ormrod, R. K., Wagner, E. D., & McCallin, R. C. (1988). Reconceptualizing map learning. *American Journal of Psychology*, 101, 425–433.
- Ormrod, J. E., & Wagner, E. D. (1987, October). *Spelling conscience in undergraduate students: Ratings of spelling accuracy and dictionary use*. Paper presented at the annual meeting of the Northern Rocky Mountain Educational Research Association, Park City, UT.
- Ornstein, P. A., Grammer, J. K., & Coffman, J. L. (2010). Teachers' "mnemonic style" and the development of skilled memory. In H. S. Waters & W. Schneider (Eds.), *Metacognition, strategy use, and instruction* (pp. 23–53). New York: Guilford Press.
- Ornstein, P. A., & Haden, C. A. (2001). *Memory development or the development of memory? Current Directions in Psychological Science*, 10, 202–205.
- Ornstein, R. (1997). *The right mind: Making sense of the hemispheres*. San Diego, CA: Harcourt Brace.
- Osborn, A. F. (1963). *Applied imagination* (3rd ed.). New York: Scribner.
- Osborne, J. W., Tillman, D., & Holland, A. (2010). Stereotype threat and anxiety for disadvantaged minorities and women. In J. C. Cassady (Ed.), *Anxiety in schools: The causes, consequences, and solutions for academic anxieties* (pp. 119–136). New York: Peter Lang.
- Osgood, C. E. (1949). The similarity paradox in human learning: A resolution. *Psychological Review*, 56, 132–143.
- Osher, D., Bear, G. G., Sprague, J. R., & Doyle, W. (2010). How can we improve school discipline? *Educational Researcher*, 39, 48–58.
- Oskamp, S. (Ed.) (2000). *Reducing prejudice and discrimination*. Mahwah, NJ: Erlbaum.
- Osterman, K. F. (2000). Students' need for belonging in the school community. *Review of Educational Research*, 70, 323–367.
- Ostrovsky, Y., Andalman, A., & Sinha, P. (2006). Vision following extended congenital blindness. *Psychological Science*, 17, 1009–1014.
- Otero, J. (1998). Influence of knowledge activation and context on comprehension monitoring of science texts. In D. J. Hacker, J. Dunlosky, & A. C. Graesser (Eds.), *Metacognition in educational theory and practice* (pp. 145–164). Mahwah, NJ: Erlbaum.
- Otero, J. (2009). Question generation and anomaly detection in texts. In D. J. Hacker, J. Dunlosky, & A. C. Graesser (Eds.), *Handbook of metacognition in education* (pp. 47–59). New York: Routledge.

- Otero, J., & Kintsch, W. (1992). Failures to detect contradictions in a text: What readers believe versus what they read. *Psychological Science*, 3, 229–235.
- Overmier, J. B. (2002). On learned helplessness. *Integrative Physiological and Behavioral Science*, 37 (1), 4–8.
- Overmier, J. B., & Lawry, J. A. (1979). Pavlovian conditioning and the mediation of behavior. In G. H. Bower (Ed.), *The psychology of learning and motivation* (Vol. 13, pp. 1–55). New York: Academic Press.
- Owens, J., Bower, G. H., & Black, J. B. (1979). The “soap opera” effect in story recall. *Memory and Cognition*, 7, 185–191.
- Owens, R. E., Jr. (1996). *Language development* (4th ed.). Boston: Allyn & Bacon.
- Ozguner, S., & Guthrie, J. T. (2004). Interactions among elaborative interrogation, knowledge, and interest in the process of constructing knowledge from text. *Journal of Educational Psychology*, 96, 437–443.
- Öztekin, I., Davachi, L., & McElree, B. (2010). Are representations in working memory distinct from representations in long-term memory? Neural evidence in support of a single store. *Psychological Science*, 21, 1123–1133.
- Page-Voth, V., & Graham, S. (1999). Effects of goal setting and strategy use on the writing performance and self-efficacy of students with writing and learning problems. *Journal of Educational Psychology*, 91, 230–240.
- Paige, J. M., & Simon, H. A. (1966). Cognitive processes in solving algebra word problems. In B. Kleinmuntz (Ed.), *Problem solving: Research, method and theory* (pp. 51–148). New York: Wiley.
- Paivio, A. (1963). Learning of adjective-noun paired associates as a function of adjective-noun word order and noun abstractness. *Canadian Journal of Psychology*, 17, 370–379.
- Paivio, A. (1971). *Imagery and verbal processes*. New York: Holt, Rinehart & Winston.
- Paivio, A. (1986). *Mental representations: A dual-coding approach*. New York: Oxford University Press.
- Pajares, F. (2009). Toward a positive psychology of academic motivation: The role of self-efficacy beliefs. In R. Gilman, E. S. Huebner, & M. J. Furlong (Eds.), *Handbook of positive psychology in schools* (pp. 149–160). New York: Routledge.
- Palincsar, A. S. (2003). Ann L. Brown: Advancing a theoretical model of learning and instruction. In B. J. Zimmerman & D. H. Schunk (Eds.), *Educational psychology: A century of contributions* (pp. 459–475). Mahwah, NJ: Erlbaum.
- Palincsar, A. S., & Brown, A. L. (1984). Reciprocal teaching of comprehension-fostering and comprehension-monitoring activities. *Cognition and Instruction*, 1, 117–175.
- Palincsar, A. S., & Brown, A. L. (1989). Classroom dialogues to promote self-regulated comprehension. In J. Brophy (Ed.), *Advances in research on teaching* (Vol. 1, pp. 35–71). Greenwich, CT: JAI Press.
- Palincsar, A. S., & Herrenkohl, L. R. (1999). Designing collaborative contexts: Lessons from three research programs. In A. M. O'Donnell & A. King (Eds.), *Cognitive perspectives on peer learning* (pp. 151–177). Mahwah, NJ: Erlbaum.
- Paller, K. A., Voss, J. L., & Westerberg, C. E. (2009). Investigating the awareness of remembering. *Perspectives on Psychological Science*, 4, 185–199.
- Pallock, L., & Surber, J. R. (1997, March). *Effect of topic frequency and importance on recall of text*. Paper presented at the annual meeting of the American Educational Research Association, Chicago.
- Palmer, D. J., & Goetz, E. T. (1988). Selection and use of study strategies: The role of the student's beliefs about self and strategies. In C. E. Weinstein, E. T. Goetz, & P. A. Alexander (Eds.), *Learning and study strategies: Issues in assessment, instruction, and evaluation* (pp. 41–61). San Diego, CA: Academic Press.
- Palmiero, M., Belardinelli, M. O., Nardo, D., Sestieri, C., Di Matteo, R., D'Ausillo, A., et al. (2009). Mental imagery generation in different modalities activates sensory-motor areas. *Cognitive Processing*, 10 (Supplement 2), S268–S271.
- Pansky, A., & Koriat, A. (2004). The basic-level convergence effect in memory distortions. *Psychological Science*, 15, 52–59.
- Papka, M., Ivry, R. B., & Woodruff-Pak, D. S. (1997). Eyeblink classical conditioning and awareness revisited. *Psychological Science*, 8, 404–408.
- Paris, S. G., & Ayres, L. R. (1994). *Becoming reflective students and teachers with portfolios and authentic assessment*. Washington, DC: American Psychological Association.
- Paris, S. G., & Byrnes, J. P. (1989). The constructivist approach to self-regulation and learning in the classroom. In B. J. Zimmerman & D. H. Schunk (Eds.), *Self-regulated learning and academic achievement: Theory, research, and practice* (pp. 169–200). New York: Springer-Verlag.
- Paris, S. G., & Cunningham, A. E. (1996). Children becoming students. In D. C. Berliner & R. C. Calfee (Eds.), *Handbook of educational psychology* (pp. 117–147). New York: Macmillan.
- Paris, S. G., & Lindauer, B. K. (1976). The role of inference in children's comprehension and memory. *Cognitive Psychology*, 8, 217–227.
- Paris, S. G., & Paris, A. H. (2001). Classroom applications of research on self-regulated learning. *Educational Psychologist*, 36, 89–101.
- Paris, S. G., & Turner, J. C. (1994). Situated motivation. In P. R. Pintrich, D. R. Brown, & C. E. Weinstein (Eds.), *Student motivation, cognition, and learning: Essays in honor of Wilbert J. McKeachie* (pp. 213–238). Hillsdale, NJ: Erlbaum.
- Park, L. E., & Maner, J. K. (2009). Does self-threat promote social connection? The role of self-esteem and contingencies of self-worth. *Journal of Personality and Social Psychology*, 96, 203–217.
- Park, O. (1984). Example comparison strategy versus attribute identification strategy in concept learning. *American Educational Research Journal*, 21, 145–162.
- Park, S. W., Bauer, J. J., & Arbuckle, N. B. (2009). Growth motivation attenuates the self-serving attribution. *Journal of Research in Personality*, 43, 914–917.
- Park, S. W., & Sperling, R. A. (2009, April). *Self-regulation of academic procrastinators: A mixed methods study*. Paper presented at the annual meeting of the American Educational Research Association, San Diego, CA.
- Parke, R. D. (1977). Some effects of punishment on children's behavior—revisited. In E. M. Hetherington & R. D. Parke (Eds.), *Contemporary readings in child psychology* (pp. 176–188). New York: McGraw-Hill.
- Parke, R. D., & Deur, J. L. (1972). Schedule of punishment and inhibition of aggression in children. *Developmental Psychology*, 7, 266–269.
- Parke, J. (1995). Age differences in source monitoring of performed and imagined actions on immediate and delayed tests. *Journal of Experimental Child Psychology*, 60, 84–101.
- Parker, S. T., Mitchell, R. W., & Boccia, M. L. (Eds.) (1994). *Self-awareness in animals and humans: Developmental perspectives*. Cambridge, England: Cambridge University Press.
- Parsons, J. E., Kaczala, C. M., & Meece, J. L. (1982). Socialization of achievement attitudes and beliefs: Classroom influences. *Child Development*, 53, 322–339.
- Pascarella, E. T., & Terenzini, P. T. (1991). *How college affects students: Findings and insights from twenty years of research*. San Francisco: Jossey-Bass.
- Pascual-Leone, J. (1970). A mathematical model for the transition rule in Piaget's development stages. *Acta Psychologica*, 32, 301–345.
- Pashler, H. (1992). Attentional limitations in doing two tasks at the same time. *Current Directions in Psychological Science*, 1, 44–48.
- Pashler, H., Rohrer, D., Cepeda, N. J., & Carpenter, S. K. (2007). Enhancing learning and retarding forgetting: Choices and consequences. *Psychonomic Bulletin & Review*, 14, 187–193.
- Patall, E. A., Cooper, H., & Wynn, S. R. (2010). The effectiveness and relative importance of choice in the classroom. *Journal of Educational Psychology*, 102, 896–915.
- Patrick, H., Anderman, L. H., & Ryan, A. M. (2002). Social motivation and the classroom social environment. In C. Midgley (Ed.), *Goals, goal structures, and patterns of adaptive learning* (pp. 85–108). Mahwah, NJ: Erlbaum.
- Patrick, H., Mantzicopoulos, Y., & Samarapungavan, A. (2009). Motivation for learning science in kindergarten: Is there a gender gap and does integrated inquiry and literacy instruction make a difference? *Journal of Research in Science Teaching*, 46, 166–191.
- Patrick, H., & Pintrich, P. R. (2001). Conceptual change in teachers' intuitive conceptions of learning, motivation, and instruction: The role of motivational and epistemological beliefs. In B. Torff & R. J. Sternberg (Eds.), *Understanding*

- and teaching the intuitive mind: Student and teacher learning (pp. 117–143). Mahwah, NJ: Erlbaum.
- Patrick, H., Ryan, A. M., Anderman, L. H., Middleton, M. J., Linnenbrink, L., Hruda, L. Z., Edelin, K., Kaplan, A., & Midgley, C. (1997). *Observing Patterns of Adaptive Learning (OPAL): A scheme for classroom observations*. Ann Arbor, MI: The University of Michigan.
- Patrick, J., Turner, J. C., Meyer, D. K., & Midgley, C. (2003). How teachers establish psychological environments during the first days of school: Associations with avoidance in mathematics. *Teachers College Record*, 105, 1521–1558.
- Pavlov, I. P. (1927). *Conditioned reflexes* (G. V. Anrep, Trans.). London: Oxford University Press.
- Payne, D. G., Neuschatz, J. S., Lampinen, J. M., & Lynn, S. J. (1997). Compelling memory illusions: The qualitative characteristics of false memories. *Current Directions in Psychological Science*, 6, 56–60.
- Payne, J. D., & Kensinger, E. A. (2010). Sleep's role in the consolidation of emotional episodic memories. *Current Directions in Psychological Science*, 19, 290–295.
- Pea, R. D. (1987). Socializing the knowledge transfer problem. *International Journal of Educational Research*, 11, 639–663.
- Pea, R. D. (1993). Practices of distributed intelligence and designs for education. In G. Salomon (Ed.), *Distributed cognitions: Psychological and educational considerations* (pp. 47–87). Cambridge, England: Cambridge University Press.
- Pear, J. J., & Crone-Todd, D. E. (1999). Personalized system of instruction in cyberspace. *Journal of Applied Behavior Analysis*, 32, 205–209.
- Pearson, P. D., Hansen, J., & Gordon, C. (1979). The effect of background knowledge on young children's comprehension of explicit and implicit information. *Journal of Reading Behavior*, 11 (3), 201–209.
- Pekrun, R. (2006). The control-value theory of achievement emotions: Assumptions, corollaries, and implications for educational research and practice. *Educational Psychology Review*, 18, 315–341.
- Pekrun, R., Elliot, A. J., & Maier, M. A. (2009). Achievement goals and achievement emotions: Testing a model of their joint relations with academic performance. *Journal of Educational Psychology*, 101, 115–135.
- Pekrun, R., Goetz, T., Daniels, L. M., Stupnisky, R. H., & Perry, R. P. (2010). Boredom in achievement settings: Exploring control-value antecedents and performance outcomes of a neglected emotion. *Journal of Educational Psychology*, 102, 531–549.
- Pekrun, R., Goetz, T., Titz, W., & Perry, R. P. (2002). Academic emotions in students' self-regulated learning and achievement: A program of qualitative and quantitative research. *Educational Psychologist*, 37, 91–105.
- Péladeau, N., Forget, J., & Gagné, F. (2003). Effect of paced and unpaced practice on skill application and retention: How much is enough? *American Educational Research Journal*, 40, 769–801.
- Pellegrini, A. D. (2009). Research and policy on children's play. *Child Development Perspectives*, 3, 131–136.
- Pellegrini, A. D., & Bohn, C. M. (2005). The role of recess in children's cognitive performance and school adjustment. *Educational Researcher*, 34 (1), 13–19.
- Pellegrini, A. D., Huberty, P. D., & Jones, I. (1995). The effects of recess timing on children's playground and classroom behaviors. *American Educational Research Journal*, 32, 845–864.
- Pellegrini, A. D., & Long, J. D. (2004). Part of the solution and part of the problem: The role of peers in bullying, dominance, and victimization during the transition from primary school through secondary school. In D. L. Espelage & S. M. Swearer (Eds.), *Bullying in American schools: A social-ecological perspective on prevention and intervention* (pp. 107–117). Mahwah, NJ: Erlbaum.
- Penfield, W. (1958). Some mechanisms of consciousness discovered during electrical stimulation of the brain. *Proceedings of the National Academy of Sciences*, 44, 51–66.
- Penfield, W. (1969). Consciousness, memory, and man's conditioned reflexes. In K. Pribram (Ed.), *On the biology of learning* (pp. 129–168). New York: Harcourt, Brace, & World.
- Penfield, W., & Roberts, L. (1959). *Speech and brain-mechanisms*. Princeton, NJ: Princeton University Press.
- Pereira, A. C., Huddleston, D. E., Brickman, A. M., Sosunov, A. A., Hen, R., McKham, G. M., et al. (2007). An in vivo correlate of exercise-induced neurogenesis in the adult dentate gyrus. *Proceedings of the National Academy of Sciences*, 104, 5638–5643.
- Perfect, T. J. (2002). When does eyewitness confidence predict performance? In T. J. Perfect & B. L. Schwartz (Eds.), *Applied metacognition* (pp. 95–120). Cambridge, England: Cambridge University Press.
- Perin, C. T. (1942). Behavior potentiality as a joint function of the amount of training and the degree of hunger at the time of extinction. *Journal of Experimental Psychology*, 30, 93–113.
- Perkins, D. (1992). *Smart schools: From training memories to educating minds*. New York: Free Press/Macmillan.
- Perkins, D. (1995). *Outsmarting IQ: The emerging science of learnable intelligence*. New York: Free Press.
- Perkins, D., & Ritchhart, R. (2004). When is good thinking? In D. Y. Dai & R. J. Sternberg (Eds.), *Motivation, emotion, and cognition: Integrative perspectives on intellectual functioning and development* (pp. 351–384). Mahwah, NJ: Erlbaum.
- Perkins, D. N., & Salomon, G. (1987). Transfer and teaching thinking. In D. N. Perkins, J. Lochhead, & J. Bishop (Eds.), *Thinking: The second international conference* (pp. 285–303). Hillsdale, NJ: Erlbaum.
- Perkins, D. N., & Salomon, G. (1989). Are cognitive skills context-bound? *Educational Researcher*, 18 (1), 16–25.
- Perkins, D. N., & Simmons, R. (1988). Patterns of misunderstanding: An integrative model for science, math, and programming. *Review of Educational Research*, 58, 303–326.
- Perry, A. C., & Fisher, W. W. (2001). Behavioral economic influences on treatments designed to decrease destructive behavior. *Journal of Applied Behavior Analysis*, 34, 211–215.
- Perry, D. G., & Perry, L. C. (1983). Social learning, causal attribution, and moral internalization. In J. Bisanz, G. L. Bisanz, & R. Kail (Eds.), *Learning in children: Progress in cognitive development research* (pp. 105–136). New York: Springer-Verlag.
- Perry, L. K., Samuelson, L. K., Malloy, L. M., & Schiffer, R. N. (in press). Learn locally, think globally: Exemplar variability supports higher-order generalization and word learning. *Psychological Science*.
- Perry, M. (1991). Learning and transfer: Instructional conditions and conceptual change. *Cognitive Development*, 6, 449–468.
- Perry, N. E. (1998). Young children's self-regulated learning and contexts that support it. *Journal of Educational Psychology*, 90, 715–729.
- Perry, N. E., & Winne, P. H. (2004). Motivational messages from home and school: How do they influence young children's engagement in learning? In D. M. McNeerney & S. Van Etten (Eds.), *Big theories revisited* (pp. 199–222). Greenwich, CT: Information Age.
- Perry, N. E., Turner, J. C., & Meyer, D. K. (2006). Classrooms as contexts for motivating learning. In P. A. Alexander & P. H. Winne (Eds.), *Handbook of educational psychology* (2nd ed., pp. 327–348). Mahwah, NJ: Erlbaum.
- Perry, N. E., VandeKamp[O5], K. O., Mercer, L. K., & Nordby, C. J. (2002). Investigating teacher-student interactions that foster self-regulated learning. *Educational Psychologist*, 37, 5–15.
- Perry, W. G., Jr. (1968). *Forms of intellectual and ethical development in the college years*. Cambridge, MA: President and Fellows of Harvard College.
- Peskin, J. (1998). Constructing meaning when reading poetry: An expert-novice study. *Cognition and Instruction*, 16, 235–263.
- Peterson, C. (1990). Explanatory style in the classroom and on the playing field. In S. Graham & V. S. Folkes (Eds.), *Attribution theory: Applications to achievement, mental health, and interpersonal conflict* (pp. 53–75). Hillsdale, NJ: Erlbaum.
- Peterson, C. (2006). *A primer in positive psychology*. New York: Oxford University Press.
- Peterson, C., Maier, S. F., & Seligman, M. E. P. (1993). *Learned helplessness: A theory for the age of personal control*. New York: Oxford University Press.
- Peterson, C., & Park, N. (2010). What happened to self-actualization? Commentary on Kenrick et al. (2010). *Perspectives on Psychological Science*, 5, 320–322.
- Peterson, L. R., & Peterson, M. J. (1959). Short-term retention of individual items. *Journal of Experimental Psychology*, 58, 193–198.

- Peterson, L. R., & Peterson, M. J. (1962). Minimal paired-associate learning. *Journal of Experimental Psychology*, 63, 521–527.
- Peterson, M. A. (1994). Object recognition processes can and do operate before figure-ground organization. *Current Directions in Psychological Science*, 3, 105–111.
- Peterson, M. A., & Gibson, B. S. (1994). Must figure-ground organization precede object recognition? An assumption in peril. *Psychological Science*, 5, 253–259.
- Peterson, P. L. (1992). Revising their thinking: Keisha Coleman and her third-grade mathematics class. In H. H. Marshall (Ed.), *Redefining student learning: Roots of educational change* (pp. 161–176). Norwood, NJ: Ablex.
- Peterson, S. E. (1993). The effects of prior achievement and group outcome on attributions and affect in cooperative tasks. *Contemporary Educational Psychology*, 18, 479–485.
- Petri, H. L. (1991). *Motivation: Theory, research, and applications* (3rd ed.). Belmont, CA: Wadsworth.
- Pettito, A. L. (1985). Division of labor: Procedural learning in teacher-led small groups. *Cognition and Instruction*, 2, 233–270.
- Peverly, S. T., Brobst, K. E., Graham, M., & Shaw, R. (2003). College adults are not good at self-regulation: A study on the relationship of self-regulation, note taking, and test taking. *Journal of Educational Psychology*, 95, 335–346.
- Peverly, S. T., Ramaswamy, V., Brown, C., Sumowski, J., Alidoost, M., & Garner, J. (2007). What predicts skill in lecture note taking? *Journal of Educational Psychology*, 99, 167–180.
- Pezdek, K. (1977). Cross-modality semantic integration of sentence and picture memory. *Journal of Experimental Psychology: Human Learning and Memory*, 3, 515–524.
- Pezdek, K., & Banks, W. P. (Eds.) (1996). *The recovered memory/false memory debate*. San Diego, CA: Academic Press.
- Pezdek, K., Finger, K., & Hodge, D. (1997). Planting false childhood memories: The role of event plausibility. *Psychological Science*, 8, 437–441.
- Pfiffner, L. J., Barkley, R. A., & DuPaul, G. J. (2006). Treatment of ADHD in school settings. In R. A. Barkley, *Attention-deficit hyperactivity disorder: A handbook for diagnosis and treatment* (3rd ed., pp. 547–589). New York: Guilford Press.
- Pfiffner, L. J., & O'Leary, S. G. (1987). The efficacy of all-positive management as a function of the prior use of negative consequences. *Journal of Applied Behavior Analysis*, 20, 265–271.
- Phelan, P., Yu, H. C., & Davidson, A. L. (1994). Navigating the psychosocial pressures of adolescence: The voices and experiences of high school youth. *American Educational Research Journal*, 31, 415–447.
- Phelps, E. A., Ling, S., & Carrasco, M. (2006). Emotion facilitates perception and potentiates the perceptual benefits of attention. *Psychological Science*, 17, 292–299.
- Phelps, E. A., & Sharot, T. (2008). How (and why) emotion enhances the subjective sense of recollection. *Current Directions in Psychological Science*, 17, 147–152.
- Phillips, B. N., Pitcher, G. D., Worsham, M. E., & Miller, S. C. (1980). Test anxiety and the school environment. In I. G. Sarason (Ed.), *Test anxiety: Theory, research, and applications*. Hillsdale, NJ: Erlbaum.
- Phillips, E. L., Phillips, E. A., Fixsen, D. L., & Wolf, M. M. (1971). Achievement place: Modification of the behaviors of predelinquent boys within a token economy. *Journal of Applied Behavior Analysis*, 4, 45–59.
- Phye, G. D. (1997). Learning and remembering: The basis for personal knowledge construction. In G. D. Phye (Ed.), *Handbook of academic learning: Construction of knowledge* (pp. 47–64). San Diego, CA: Academic Press.
- Phye, G. D. (2001). Problem-solving instruction and problem-solving transfer: The correspondence issue. *Journal of Educational Psychology*, 93, 571–578.
- Piaget, J. (1928). *Judgment and reasoning in the child* (M. Warden, Trans.). New York: Harcourt, Brace.
- Piaget, J. (1940). Le mécanisme du développement mental et les lois du groupement des opérations. *Archives de Psychologie*, 28, 215–285.
- Piaget, J. (1952a). *The child's conception of number* (C. Gattegno & F. M. Hodgson, Trans.). London: Routledge & Kegan Paul.
- Piaget, J. (1952b). *The origins of intelligence in children* (M. Cook, Trans.). New York: W. W. Norton.
- Piaget, J. (1959). *The language and thought of the child* (3rd ed.) (M. Gabain, Trans.). New York: Humanities Press.
- Piaget, J. (1960). The definition of stages of development. In J. M. Tanner & B. Inhelder (Eds.), *Discussions on child development: A consideration of the biological, psychological and cultural approaches to the understanding of human development and behavior: Vol. 4. The proceedings of the fourth meeting of the World Health Organization Study Group on the Psychobiological Development of the Child, Geneva, 1956* (pp. 116–135). New York: International Universities Press.
- Piaget, J. (1970). Piaget's theory. In P. H. Mussen (Ed.), *Carmichael's manual of psychology* (pp. 703–732). New York: Wiley.
- Piaget, J. (1971). *Psychology and epistemology: Towards a theory of knowledge* (A. Rosin, Trans.). New York: Viking.
- Piaget, J. (1972). *The principles of genetic epistemology* (W. Mays, Trans.). New York: Basic Books.
- Piaget, J. (1980). *Adaptation and intelligence: Organic selection and phenocopy* (S. Eames, Trans.). Chicago: University of Chicago Press.
- Piaget, J., & Inhelder, B. (1969). *The psychology of the child* (H. Weaver, Trans.). New York: Basic Books.
- Pianko, S. (1979). A description of the composing processes of college freshmen writers. *Research in the Teaching of English*, 13, 5–22.
- Piazza, C. C., Bowman, L. G., Contrucci, S. A., Delia, M. D., Adelini, J. D., & Goh, H.-L. (1999). An evaluation of the properties of attention as reinforcement for destructive and appropriate behavior. *Journal of Applied Behavior Analysis*, 32, 437–449.
- Pichert, J. W., & Anderson, R. C. (1977). Taking different perspectives on a story. *Journal of Educational Psychology*, 69, 309–315.
- Pigott, H. E., Fantuzzo, J. W., & Clement, P. W. (1986). The effects of reciprocal peer tutoring and group contingencies on the academic performance of elementary school children. *Journal of Applied Behavior Analysis*, 19, 93–98.
- Pillow, B. H. (2002). Children's and adults' evaluation of the certainty of deductive inferences, inductive inferences, and guesses. *Child Development*, 73, 779–792.
- Pine, K. J., & Messer, D. J. (2000). The effect of explaining another's actions on children's implicit theories of balance. *Cognition and Instruction*, 18, 35–51.
- Pinker, S. (2007). *The stuff of thought: Language as a window into human nature*. New York: Viking.
- Pintrich, P. R. (2003). A motivational science perspective on the role of student motivation in learning and teaching contexts. *Journal of Educational Psychology*, 95, 667–686.
- Pintrich, P. R., Marx, R. W., & Boyle, R. A. (1993). Beyond cold conceptual change: The role of motivational beliefs and classroom contextual factors in the process of conceptual change. *Review of Educational Research*, 63, 167–199.
- Pintrich, P. R., & Schunk, D. H. (2002). *Motivation in education: Theory, research, and applications* (2nd ed.). Upper Saddle River, NJ: Merrill/Prentice Hall.
- Piontkowski, D., & Calfee, R. (1979). Attention in the classroom. In G. A. Hale & M. Lewis (Eds.), *Attention and cognitive development* (pp. 297–330). New York: Plenum Press.
- Piotrowski, J., & Reason, R. (2000). The national literacy strategy and dyslexia: A comparison of teaching methods and materials. *Support for Learning*, 15 (2), 51–57.
- Pipkin, C. S. P., & Vollmer, T. R. (2009). Applied implications of reinforcement history effects. *Journal of Applied Behavior Analysis*, 42, 83–103.
- Pipkin, C. S., Vollmer, T. R., & Sloman, K. N. (2010). Effects of treatment integrity failures during differential reinforcement of alternative behavior: A translational model. *Journal of Applied Behavior Analysis*, 43, 47–70.
- Plotnik, J. M., de Waal, F. B. M., & Reiss, D. (2006). Self-recognition in an Asian elephant. *Proceedings of the National Academy of Sciences, USA*, 103, 17053–17057.
- Plumert, J. M. (1994). Flexibility in children's use of spatial and categorical organizational strategies in recall. *Developmental Psychology*, 30, 738–747.
- Plunkett, K. (1996). *Connectionism and development: Neural networks and the study of change*. New York: Oxford University Press.
- Poche, C., McCubrey, H., & Munn, T. (1982). The development of correct toothbrushing technique in preschool children. *Journal of Applied Behavior Analysis*, 15, 315–320.
- Poche, C., Yoder, P., & Miltenberger, R. (1988). Teaching self-protection to children using television techniques. *Journal of Applied Behavior Analysis*, 21, 253–261.

- Poling, A. (2010). Progressive-ratio schedules and applied behavior analysis. *Journal of Applied Behavior Analysis*, 43, 347–349.
- Polman, J. L. (2004). Dialogic activity structures for project-based learning environments. *Cognition and Instruction*, 22, 431–466.
- Polya, G. (1957). *How to solve it*. Garden City, NY: Doubleday.
- Pomerantz, E. M., & Saxon, J. L. (2001). Conceptions of ability as stable and self-evaluative processes: A longitudinal examination. *Child Development*, 72, 152–173.
- Poole, D. (1994). Routine testing practices and the linguistic construction of knowledge. *Cognition and Instruction*, 12, 125–150.
- Poortvliet, P. M., & Darnon, C. (2010). Toward a more social understanding of achievement goals: The interpersonal effects of mastery and performance goals. *Current Directions in Psychological Science*, 19, 324–328.
- Popham, W. J. (1995). *Classroom assessment: What teachers need to know*. Boston: Allyn & Bacon.
- Porat, D. A. (2004). *It's not written here, but this is what happened: Students' cultural comprehension of textbook narratives on the Israeli-Arab conflict*. *American Educational Research Journal*, 41, 963–996.
- Porter, A. (1989). A curriculum out of balance: The case of elementary school mathematics. *Educational Researcher*, 18 (5), 9–15.
- Porter, S., & Peace, K. A. (2007). The scars of memory: A prospective, longitudinal investigation of the consistency of traumatic and positive emotional memories in adulthood. *Psychological Science*, 18, 435–441.
- Posner, G. J., & Rudnitsky, A. N. (1986). *Course design: A guide to curriculum development for teachers* (3rd ed.). New York: Longman.
- Posner, G. J., Strike, K. A., Hewson, P. W., & Gertzog, W. A. (1982). Accommodation of a scientific conception: Toward a theory of conceptual change. *Science Education*, 66, 211–227.
- Posner, M. I., & Rothbart, M. K. (2007). *Educating the human brain*. Washington, DC: American Psychological Association.
- Postman, L. (1964). Short-term memory and incidental learning. In A. W. Melton (Ed.), *Categories of human learning* (pp. 145–201). New York: Academic Press.
- Postman, L., & Phillips, L. (1965). Short-term temporal changes in free recall. *Quarterly Journal of Experimental Psychology*, 17, 132–138.
- Postman, L., & Underwood, B. J. (1973). Critical issues in interference theory. *Memory and Cognition*, 1, 19–40.
- Powell, S., & Nelson, B. (1997). Effects of choosing academic assignments on a study with attention deficit hyperactivity disorder. *Journal of Applied Behavior Analysis*, 30, 181–183.
- Prawat, R. S. (1989). Promoting access to knowledge, strategy, and disposition in students: A research synthesis. *Review of Educational Research*, 59, 1–41.
- Prawat, R. S. (1992). From individual differences to learning communities—Our changing focus. *Educational Leadership*, 49 (7), 9–13.
- Prawat, R. S. (1996). Constructivisms, modern and postmodern. *Educational Psychologist*, 31, 215–225.
- Premack, D. (1959). Toward experimental behavior laws: I. Positive reinforcement. *Psychological Review*, 66, 219–233.
- Premack, D. (1963). Rate differential reinforcement in monkey manipulation. *Journal of Experimental Analysis of Behavior*, 6, 81–89.
- Pressley, M. (1977). Imagery and children's learning: Putting the picture in developmental perspective. *Review of Educational Research*, 47, 586–622.
- Pressley, M. (1982). Elaboration and memory development. *Child Development*, 53, 296–309.
- Pressley, M. (with McCormick, C. B.) (1995). *Advanced educational psychology: For educators, researchers, and policymakers*. New York: HarperCollins.
- Pressley, M. (2002). Comprehension strategies instruction: A turn-of-the-century status report. In C. C. Block & M. Pressley (Eds.), *Comprehension instruction: Research-based best practices* (pp. 11–27). New York: Guilford Press.
- Pressley, M., Borkowski, J. G., & Schneider, W. (1987). Cognitive strategies: Good strategy users coordinate metacognition and knowledge. In R. Vasta & G. Whitehurst (Eds.), *Annals of child development* (Vol. 5, pp. 80–129). New York: JAI Press.
- Pressley, M., El-Dinary, P. B., Marks, M. B., Brown, R., & Stein, S. (1992). Good strategy instruction is motivating and interesting. In K. A. Renninger, S. Hidi, & A. Krapp (Eds.), *The role of interest in learning and development* (pp. 333–358). Hillsdale, NJ: Erlbaum.
- Pressley, M., & Harris, K. R. (2006). Cognitive strategies instruction: From basic research to classroom instruction. In P. A. Alexander & P. H. Winne (Eds.), *Handbook of educational psychology* (2nd ed., pp. 265–286). Mahwah, NJ: Erlbaum.
- Pressley, M., Harris, K. R., & Marks, M. B. (1992). But good strategy instructors are constructivists! *Educational Psychology Review*, 4, 3–31.
- Pressley, M., & Hilden, K. (2006). Cognitive strategies: Production deficiencies and successful strategy instruction everywhere. In W. Damon & R. M. Lerner (Series Eds.), D. Kuhn & R. Siegler (Vol. Eds.), *Handbook of child psychology: Vol. 2. Cognition, perception, and language* (6th ed., pp. 511–556). New York: Wiley.
- Pressley, M., Johnson, C. J., Symons, S., McGoldrick, J., & Kurita, J. (1989). Strategies that improve children's memory and comprehension of what is read. *Elementary School Journal*, 90, 3–32.
- Pressley, M., Levin, J. R., & Delaney, H. D. (1982). The mnemonic keyword method. *Review of Educational Research*, 52, 61–91.
- Pressley, M., Levin, J. R., & Ghatala, E. S. (1984). Memory strategy monitoring in adults and children. *Journal of Verbal Learning and Verbal Behavior*, 23, 270–288.
- Pressley, M., Levin, J. R., & Ghatala, E. S. (1988). Strategy-comparison opportunities promote long-term strategy use. *Contemporary Educational Psychology*, 13, 157–168.
- Pressley, M., Ross, K. A., Levin, J. R., & Ghatala, E. S. (1984). The role of strategy utility knowledge in children's strategy decision making. *Journal of Experimental Child Psychology*, 38, 491–504.
- Pressley, M., Wharton-McDonald, R., Rankin, J., El-Dinary, P. B., Brown, R., Afflerbach, P., Mistretta, J., & Yokoi, L. (1997). Elementary reading instruction. In G. D. Pyle (Ed.), *Handbook of academic learning: Construction of knowledge* (pp. 152–198). San Diego, CA: Academic Press.
- Pressley, M., Woloshyn, V., Lysynchuk, L. M., Martin, V., Wood, E., & Willoughby, T. (1990). A primer of research on cognitive strategy instruction: The important issues and how to address them. *Educational Psychology Review*, 2, 1–58.
- Pressley, M., Yokoi, L., Van Meter, P., Van Etten, S., & Freeborn, G. (1997). Some of the reasons why preparing for exams is so hard: What can be done to make it easier? *Educational Psychology Review*, 9, 1–38.
- Price-Williams, D. R., Gordon, W., & Ramirez, M. (1969). Skill and conservation: A study of pottery-making children. *Developmental Psychology*, 1, 769.
- Prince, S. E., Tsukiura, T., & Cabeza, R. (2007). Distinguishing the neural correlates of episodic memory encoding and semantic memory retrieval. *Psychological Science*, 18, 144–151.
- Principe, G. F., Kanaya, T., Ceci, S. J., & Singh, M. (2006). Believing is seeing: How rumors can engender false memories in preschoolers. *Psychological Science*, 17, 243–248.
- Prinz, J. (2009). Is consciousness embodied? In P. Robbins & M. Aydede (Eds.), *The Cambridge handbook of situated cognition* (pp. 419–436). Cambridge, England: Cambridge University Press.
- Prior, H., Schwarz, A., & Güntürkün, O. (2008). Mirror-induced behavior in the magpie (*Pica pica*): Evidence of self-recognition. *PLoS Biology* (Public Library of Science), 6 (8), e202. Retrieved from [www.plosbiology.org/article/info:doi/10.1371/journal.pbio.0060202](http://www.plosbiology.org/article/info:doi/10.1371/journal.pbio.0060202).
- Pritchard, R. (1990). The effects of cultural schemata on reading processing strategies. *Reading Research Quarterly*, 25, 273–295.
- Proctor, R. W., & Dutta, A. (1995). *Skill acquisition and human performance*. Thousand Oaks, CA: Sage.
- Prout, H. T. (2009). Positive psychology and students with intellectual disabilities. In R. Gilman, E. S. Huebner, & M. J. Furlong (Eds.), *Handbook of positive psychology in schools* (pp. 371–381). New York: Routledge.
- Pugh, K. J. (2002). Teaching for transformative experiences in science: An investigation of the effectiveness of two instructional elements. *Teachers College Record*, 104, 1101–1137.
- Pugh, K. J., & Bergin, D. A. (2005). The effect of schooling on students' out-of-school experience. *Educational Researcher*, 34 (9), 15–23.



- Pugh, K. J., & Bergin, D. A. (2006). Motivational influences on transfer. *Educational Psychologist, 41*, 147–160.
- Pugh, K. J., Linnenbrink, E. A., Kelly, K. L., Manzey, C., & Stewart, V. C. (2006, April). *Motivation, learning, and transformative experience: A study of deep engagement in science*. Paper presented at the annual meeting of the American Educational Research Association, San Francisco.
- Pugh, K. J., Schmidt, K., & Russell, C. (2010, May). *Fostering transformative experiences in science: A design-based study*. Paper presented at the annual meeting of the American Educational Research Association, Denver.
- Pulos, S., & Linn, M. C. (1981). Generality of the controlling variables scheme in early adolescence. *Journal of Early Adolescence, 1*, 26–37.
- Puntambekar, S., & Hübscher, R. (2005). Tools for scaffolding students in a complex learning environment: What have we gained and what have we missed? *Educational Psychologist, 40*, 1–12.
- Purdie, N., & Hattie, J. (1996). Cultural differences in the use of strategies for self-regulated learning. *American Educational Research Journal, 33*, 845–871.
- Putwain, D. W. (2007). Test anxiety in UK schoolchildren: Prevalence and demographic patterns. *British Journal of Educational Psychology, 77*, 579–593.
- Qian, G., & Pan, J. (2002). A comparison of epistemological beliefs and learning from science text between American and Chinese high school students. In B. K. Hofer & P. R. Pintrich (Eds.), *Personal epistemology: The psychology of beliefs about knowledge and knowing* (pp. 365–385). Mahwah, NJ: Erlbaum.
- Qin, Z., Johnson, D. W., & Johnson, R. T. (1995). Cooperative versus competitive efforts and problem solving. *Review of Educational Research, 65*, 129–143.
- Quartz, S. R., & Sejnowski, T. J. (1997). The neural basis of cognitive development: A constructivist manifesto. *Behavioral and Brain Sciences, 20*, 537–596.
- Quinn, P. C. (2003). Concepts are not just for objects: Categorization of spatial relation information by young infants. In D. H. Rakison & L. M. Oakes (Eds.), *Early category and concept development: Making sense of the blooming, buzzing confusion* (pp. 50–76). Oxford, England: Oxford University Press.
- Quinn, P. C. (2007). On the infant's prelinguistic conception of spatial relations: Three developmental trends and their implications for spatial language learning. In J. M. Plumert & J. P. Spencer (Eds.), *The emerging spatial mind* (pp. 117–141). New York: Oxford University Press.
- Quinn, P. C., & Bhatt, R. S. (2006). Are some Gestalt principles deployed more readily than others during early development? The case of lightness versus form similarity. *Journal of Experimental Psychology: Human Perception and Performance, 32*, 1221–1230.
- Quinn, P. C., Bhatt, R. S., Brush, D., Grimes, A., & Sharpnack, H. (2002). Development of form similarity as a Gestalt grouping principles in infancy. *Psychological Science, 13*, 320–328.
- Quintana, C., Zhang, M., & Krajcik, J. (2005). A framework for supporting metacognitive aspects of online inquiry through software-based scaffolding. *Educational Psychologist, 40*, 235–244.
- Rachlin, H. (1991). *Introduction to modern behaviorism* (3rd ed.). New York: Freeman.
- Rachlin, H. (1995). The value of temporal patterns in behavior. *Current Directions in Psychological Science, 4*, 188–192.
- Radel, R., Sarrazin, P., Legrain, P., & Wild, T. C. (2010). Social contagion of motivation between teacher and student: Analyzing underlying processes. *Journal of Educational Psychology, 102*, 577–587.
- Radke-Yarrow, M., Zahn-Waxler, C., & Chapman, M. (1983). Children's prosocial dispositions and behavior. In E. M. Hetherington (Ed.), *Handbook of child psychology: Vol. 4. Socialization, personality, and social development* (pp. 469–545). New York: Wiley.
- Radziszewska, B., & Rogoff, B. (1988). Influence of adult and peer collaborators on children's planning skills. *Developmental Psychology, 24*, 840–848.
- Radziszewska, B., & Rogoff, B. (1991). Children's guided participation in planning imaginary errands with skilled adult or peer partners. *Developmental Psychology, 27*, 381–389.
- Rahm, J., & Downey, J. (2002). "A scientist can be anyone!": Oral histories of scientists can make "real science" accessible to youth. *Learning House, 75*, 253–257.
- Raine, A., Reynolds, C., & Venables, P. H. (2002). Stimulation seeking and intelligence: A prospective longitudinal study. *Journal of Personality and Social Psychology, 82*, 663–674.
- Rakison, D. H. (2003). Parts, motion, and the development of the animate-inanimate distinction in infancy. In D. H. Rakison & L. M. Oakes (Eds.), *Early category and concept development: Making sense of the blooming, buzzing confusion* (pp. 159–192). Oxford, England: Oxford University Press.
- Rakison, D. H., & Lypyan, G. (2008). Developing object concepts in infancy: An associative learning perspective. *Monographs of the Society for Research in Child Development, 73* (1, Serial No. 289).
- Ramsay, C. M., & Sperling, R. A. (2010). Designating reader perspective to increase comprehension and interest. *Contemporary Educational Psychology, 35*, 215–227.
- Rapport, M. D., Murphy, H. A., & Bailey, J. S. (1982). Ritalin vs. response cost in the control of hyperactive children: A within-subject comparison. *Journal of Applied Behavior Analysis, 15*, 205–216.
- Rasch, B., & Born, J. (2008). Reactivation and consolidation of memory during sleep. *Current Directions in Psychological Science, 17*, 188–192.
- Ratcliff, R. (1990). Connectionist models of recognition memory: Constraints imposed by learning and forgetting functions. *Psychological Review, 97*, 285–308.
- Ratcliff, R. A., & McKoon, G. (1981). Does activation really spread? *Psychological Review, 88*, 454–462.
- Ratelle, C. F., Guay, F., Vallerand, R. J., Larose, S., & Senécal, C. (2007). Autonomous, controlled, and amotivated types of academic motivation: A person-oriented analysis. *Journal of Educational Psychology, 99*, 734–746.
- Ratey, J. J. (2001). *A user's guide to the brain: Perception, attention, and the four theaters of the brain*. New York: Vintage Books.
- Ratey, J. J., & Grandin, T. (1992). Defense behavior and coping in an autistic savant: The story of Temple Grandin. PhD. *Psychiatry: Interpersonal and Biological Processes, 55*, 382–391.
- Ratner, H. H. (1984). Memory demands and the development of young children's memory. *Child Development, 55*, 2173–2191.
- Raudenbush, S. W. (1984). Magnitude of teacher expectancy effects on pupil IQ as a function of credibility induction: A synthesis of findings from 18 experiments. *Journal of Educational Psychology, 76*, 85–97.
- Raudenbush, S. W. (2009). The Brown legacy and the O'Connor challenge: Transforming schools in the images of children's potential. *Educational Researcher, 38*, 169–180.
- Rawson, K. A., & Kintsch, W. (2005). Rereading effects depend on time of test. *Journal of Educational Psychology, 97*, 70–80.
- Rawson, K. A., & Middleton, E. L. (2009). Memory-based processing as a mechanism of automaticity in text comprehension. *Journal of Experimental Psychology: Learning, Memory, and Cognition, 35*, 353–370.
- Rawsthorne, J., & Elliot, A. J. (1999). Achievement goals and intrinsic motivation: A meta-analytic review. *Personality and Social Psychology Review, 3*, 326–344.
- Ray, W. J., Odenwald, M., Neuner, F., Schauer, M., Ruf, M., Wienbruch, C., Rockstroh, B., & Elbert, T. (2006). Decoupling neural networks from reality: Dissociative experiences in torture victims are reflected in abnormal brain waves in left frontal cortex. *Psychological Science, 17*, 825–829.
- Rayner, K., Foorman, B. R., Perfetti, C. A., Pesetsky, D., & Seidenberg, M. S. (2001). How psychological science informs the teaching of reading. *Psychological Science in the Public Interest, 2*, 31–74.
- Rayport, S. G. (1992). Cellular and molecular biology of the neuron. In S. C. Yudofsky & R. E. Hales (Eds.), *The American psychiatric press textbook of neuropsychiatry* (2nd ed., pp. 3–28). Washington, DC: American Psychiatric Press.
- Reason, J., & Mycielska, K. (1982). *Absent-minded? The psychology of mental lapses and everyday errors*. Upper Saddle River, NJ: Prentice Hall.
- Reber, A. S. (1993). *Implicit learning and tacit knowledge: An essay on the cognitive unconscious*. New York: Oxford University Press.
- Reder, L. M., & Ross, B. H. (1983). Integrated knowledge in different tasks: Positive and

- negative fan effects. *Journal of Experimental Psychology: Human Learning and Memory*, 8, 55–72.
- Reed, S. (1974). Structural descriptions and the limitations of visual images. *Memory and Cognition*, 2, 329–336.
- Reed, S. K. (1993). A schema-based theory of transfer. In D. K. Detterman & R. J. Sternberg (Eds.), *Transfer on trial: Intelligence, cognition, and instruction* (pp. 39–67). Norwood, NJ: Ablex.
- Reese, H. W., & Lipsitt, L. P. (1970). *Experimental child psychology*. New York: Academic Press.
- Reeve, J. (2006). Extrinsic rewards and inner motivation. In C. M. Evertson & C. S. Weinstein (Eds.), *Handbook of classroom management: Research, practice, and contemporary issues* (pp. 645–664.). Mahwah, NJ: Erlbaum.
- Reeve, J. (2009). Why teachers adopt a controlling motivating style toward students and how they can become more autonomy supportive. *Educational Psychologist*, 44, 159–175.
- Reeve, J., Deci, E. L., & Ryan, R. M. (2004). Self-determination theory: A dialectical framework for understanding sociocultural influences on student motivation. In D. M. McNeerney & S. Van Etten (Eds.), *Big theories revisited* (pp. 31–60). Greenwich, CT: Information Age.
- Reeve, J., Nix, G., & Hamm, D. (2003). Testing models of the experience of self-determination in intrinsic motivation and the conundrum of choice. *Journal of Educational Psychology*, 95, 375–392.
- Régner, I., Escribe, C., & Dupeyrat, C. (2007). Evidence of social comparison in mastery goals in natural academic settings. *Journal of Educational Psychology*, 99, 575–583.
- Regner, I., Smeding, A., Gimmig, D., Thinus-Blanc, C., Montail, J.-M., & Huguet, P. (2010). Individual differences in working memory moderate stereotype-threat effects. *Psychological Science*, 21, 1646–1648.
- Reichle, E. D., Reineberg, A. E., & Schooler, J. W. (2010). Eye movements during mindless reading. *Psychological Science*, 21, 1300–1310.
- Reid, R., Trout, A. L., & Schartz, M. (2005). Self-regulation interventions for children with attention deficit/hyperactivity disorder. *Exceptional Children*, 71, 361–377.
- Reimann, P., & Schult, T. J. (1996). Turning examples into cases: Acquiring knowledge structures for analogical problem solving. *Educational Psychologist*, 31, 123–132.
- Reiner, M., Slotta, J. D., Chi, M. T. H., & Resnick, L. B. (2000). Naive physics reasoning: A commitment to substance-based conceptions. *Cognition and Instruction*, 18, 1–34.
- Reinking, D., & Leu, D. J. (Chairs) (2008, March). *Understanding Internet reading comprehension and its development among adolescents at risk of dropping out of school*. Poster session presented at the annual meeting of the American Educational Research Association, New York.
- Reisberg, D. (Ed.) (1992). *Auditory imagery*. Hillsdale, NJ: Erlbaum.
- Reisberg, D. (1997). *Cognition: Exploring the science of the mind*. New York: W. W. Norton.
- Reiser, R. A., & Sullivan, H. J. (1977). Effects of self-pacing and instructor-pacing in a PSI course. *Journal of Educational Research*, 71, 8–12.
- Reissland, N. (1988). Neonatal imitation in the first hour of life: Observations in rural Nepal. *Developmental Psychology*, 24, 464–469.
- Reiter, S. N. (1994). Teaching dialogically: Its relationship to critical thinking in college students. In P. R. Pintrich, D. R. Brown, & C. E. Weinstein (Eds.), *Student motivation, cognition, and learning: Essays in honor of Wilbert J. McKeachie* (pp. 275–310). Hillsdale, NJ: Erlbaum.
- Reitman, J. S. (1974). Without surreptitious rehearsal, information in short-term memory decays. *Journal of Verbal Learning and Verbal Behavior*, 13, 365–377.
- Reitman, W. R. (1964). Heuristic decision procedures, open constraints, and the structure of ill-defined problems. In M. W. Shelley & G. L. Bryan (Eds.), *Human judgments and optimality* (pp. 282–315). New York: Wiley.
- Renkl, A., & Atkinson, R. K. (2003). Structuring the transition from example study to problem solving in cognitive skill acquisition: A cognitive load perspective. *Educational Psychologist*, 38, 15–22.
- Renkl, A., Mandl, H., & Gruber, H. (1996). Inert knowledge: Analyses and remedies. *Educational Psychologist*, 31, 115–121.
- Renninger, K. A. (2009). Interest and identity development in instruction: An inductive model. *Educational Psychologist*, 44, 105–118.
- Renninger, K. A., Hidi, S., & Krapp, A. (Eds.) (1992). *The role of interest in learning and development*. Hillsdale, NJ: Erlbaum.
- Repacholi, B. M., & Meltzoff, A. N. (2007). Emotional eavesdropping: Infants selectively respond to indirect emotional signals. *Child Development*, 78, 503–521.
- Repetti, R., Taylor, S. E., & Saxbe, D. (2007). The influence of early socialization experiences on development of biological systems. In J. E. Grusec & P. D. Hastings (Eds.), *Handbook of socialization: Theory and research* (pp. 124–152). New York: Guilford Press.
- Rescorla, R. A. (1988). Pavlovian conditioning: It's not what you think it is. *American Psychologist*, 43, 151–160.
- Resnick, L. B. (1987). *Education and learning to think*. Washington, DC: National Academy Press.
- Resnick, L. B. (1989). Developing mathematical knowledge. *American Psychologist*, 44, 162–169.
- Resnick, L. B., Bill, V. L., Lesgold, S. B., & Leer, M. N. (1991). Thinking in arithmetic class. In B. Means, C. Chelemer, & M. S. Knapp (Eds.), *Teaching advanced skills to at-risk students: Views from research and practice* (pp. 27–53). San Francisco: Jossey-Bass.
- Reyna, C. (2000). Lazy, dumb, or industrious: When stereotypes convey attribution information in the classroom. *Educational Psychology Review*, 12, 85–110.
- Reyna, C., & Weiner, B. (2001). Justice and utility in the classroom: An attributional analysis of the goals of teachers' punishment and intervention strategies. *Journal of Educational Psychology*, 93, 309–319.
- Reyna, V. F., & Farley, F. (2006). Risk and rationality in adolescent decision making: Implications for theory, practice, and public policy. *Psychological Science in the Public Interest*, 7 (1), 1–44.
- Reynolds, G. S. (1975). *A primer of operant conditioning* (rev. ed.). Glenview, IL: Scott, Foresman.
- Reynolds, R. E., & Shirey, L. L. (1988). The role of attention in studying and learning. In C. E. Weinstein, E. T. Goetz, & P. A. Alexander (Eds.), *Learning and study strategies: Issues in assessment, instruction, and evaluation* (pp. 77–100). San Diego, CA: Academic Press.
- Reynolds, R. E., Sinatra, G. M., & Jetton, T. L. (1996). Views of knowledge acquisition and representation: A continuum from experience centered to mind centered. *Educational Psychologist*, 31, 93–104.
- Reynolds, R. E., Taylor, M. A., Steffensen, M. S., Shirey, L. L., & Anderson, R. C. (1982). Cultural schemata and reading comprehension. *Reading Research Quarterly*, 17, 353–366.
- Reznick, S. (2007). Working memory in infants and toddlers. In L. M. Oakes & P. J. Bauer (Eds.), *Short- and long-term memory in infancy and early childhood: Taking the first steps toward remembering* (pp. 3–26). New York: Oxford University Press.
- Rhodewalt, F., & Vohs, K. D. (2005). Defensive strategies, motivation, and the self: A self-regulatory process view. In A. J. Elliot & C. S. Dweck (Eds.), *Handbook of competence and motivation* (pp. 548–565). New York: Guilford Press.
- Ricciardi, J. N., Luiselli, J. K., & Camare, M. (2006). Shaping approach responses as intervention for specific phobia in a child with autism. *Journal of Applied Behavior Analysis*, 39, 445–448.
- Ricco, R., Pierce, S. S., & Medina, C. (2010). Epistemic beliefs and achievement motivation in early adolescence. *Journal of Early Adolescence*, 30, 305–340.
- Richards, J. M., & Gross, J. J. (2000). Emotion regulation and memory: The cognitive costs of keeping one's cool. *Journal of Personality and Social Psychology*, 79, 410–424.
- Richardson, R., & Hayne, H. (2007). You can't take it with you: The translation of memory across development. *Current Directions in Psychological Science*, 16, 223–227.
- Richardson, V. (2003). Preservice teachers' beliefs. In J. Raths & A. C. McAninch (Eds.), *Teacher beliefs and classroom performance: The impact of teacher education* (pp. 1–22). Greenwich, CT: Information Age.
- Rickard, J. F., Body, S., Zhang, Z., Bradshaw, C. M., & Szabadi, E. (2009). Effect of reinforcer magnitude on performance maintained by progressive-ratio schedules. *Journal of the Experimental Analysis of Behavior*, 91, 75–87.
- Riding, R. J., & Calvey, I. (1981). The assessment of verbal-imagery learning styles and their effect on the recall of concrete and abstract prose passages by 11-year-old children. *British Journal of Psychology*, 72, 59–64.

- Riggs, J. M. (1992). Self-handicapping and achievement. In A. K. Boggiano & T. S. Pittman (Eds.), *Achievement and motivation: A social-developmental perspective* (pp. 244–267). Cambridge, England: Cambridge University Press.
- Rimm, D. C., & Masters, J. C. (1974). *Behavior therapy: Techniques and empirical findings*. New York: Academic Press.
- Rinehart, S. D., Stahl, S. A., & Erickson, L. G. (1986). Some effects of summarization training on reading and studying. *Reading Research Quarterly*, 21, 422–438.
- Ringdahl, J. E., Winborn, L. C., Andelman, M. S., & Kitsukawa, K. (2002). The effects of non-contingently available alternative stimuli on functional analysis outcomes. *Journal of Applied Behavior Analysis*, 35, 407–410.
- Rips, L. J., Shoben, E. J., & Smith, E. E. (1973). Semantic distance and the verification of semantic relations. *Journal of Verbal Learning and Verbal Behavior*, 12, 1–20.
- Rittle-Johnson, B. (2006). Promoting transfer: Effects of self-explanation and direct instruction. *Child Development*, 77, 1–15.
- Rittle-Johnson, B., & Koedinger, K. R. (2005). Designing knowledge scaffolds to support mathematical problem solving. *Cognition and Instruction*, 23, 313–349.
- Rittle-Johnson, B., Siegler, R. S., & Alibali, M. W. (2001). Developing conceptual understanding and procedural skill in mathematics: An iterative process. *Journal of Educational Psychology*, 93, 346–362.
- Rittle-Johnson, B., & Star, J. R. (2009). Compared with what? The effects of different comparisons on conceptual knowledge and procedural flexibility for equation solving. *Journal of Educational Psychology*, 101, 529–544.
- Ritts, V., Patterson, M. L., & Tubbs, M. E. (1992). Expectations, impressions, and judgments of physically attractive students: A review. *Review of Educational Research*, 62, 413–426.
- Robbins, P., & Aydede, M. (Eds.) (2009a). *The Cambridge handbook of situated cognition*. Cambridge, England: Cambridge University Press.
- Robbins, P., & Aydede, M. (2009b). A short primer on situated cognition. In P. Robbins & M. Aydede (Eds.), *The Cambridge handbook of situated cognition* (pp. 3–10). Cambridge, England: Cambridge University Press.
- Roberts, G. C., Treasure, D. C., & Kavussanu, M. (1997). Motivation in physical activity contexts: An achievement goal perspective. *Advances in Motivation and Achievement*, 10, 413–447.
- Robertson, J. S. (2000). Is attribution training a worthwhile classroom intervention for K–12 students with learning difficulties? *Educational Psychology Review*, 12, 111–134.
- Robins, R. W., Gosling, S. D., & Craik, K. H. (1999). An empirical analysis of trends in psychology. *American Psychologist*, 54, 117–128.
- Robinson, D. H., & Kiewra, K. A. (1995). Visual argument: Graphic organizers are superior to outlines in improving learning from text. *Journal of Educational Psychology*, 87, 455–467.
- Robinson, D. R., Schofield, J. W., & Steers-Wentzell, K. L. (2005). Peer and cross-age tutoring in math: Outcomes and their design implications. *Educational Psychology Review*, 17, 327–362.
- Robinson, E. J., & Whitcombe, E. L. (2003). Children's suggestibility in relation to their understanding about sources of knowledge. *Child Development*, 74, 48–62.
- Robinson, N. M., & Robinson, H. B. (1961). A method for the study of instrumental avoidance conditioning with children. *Journal of Comparative and Physiological Psychology*, 54, 20–23.
- Robinson, S. L., & Griesemer, S. M. R. (2006). Helping individual students with problem behavior. In C. M. Evertson & C. S. Weinstein (Eds.), *Handbook of classroom management: Research, practice, and contemporary issues* (pp. 787–802). Mahwah, NJ: Erlbaum.
- Rodriguez, N. M., Thompson, R. H., & Baynham, T. Y. (2010). Assessment of the relative effects of attention and escape on noncompliance. *Journal of Applied Behavior Analysis*, 43, 143–147.
- Roediger, H. L., III (1990). Implicit memory: Retention without remembering. *American Psychologist*, 45, 1043–1056.
- Roediger, H. L. (2004, March). What happened to behaviorism? *APS Observer*, 17 (3), 5, 40–42.
- Roediger, H. L., & Crowder, R. G. (1976). A serial position effect in recall of United States presidents. *Bulletin of the Psychonomic Society*, 8, 275–278.
- Roediger, H. L., III, & Karpicke, J. D. (2006). Test-enhanced learning: Taking memory tests improves long-term retention. *Psychological Science*, 17, 249–255.
- Roediger, H. L., III, & McDermott, K. B. (2000). Tricks of memory. *Current Directions in Psychological Science*, 9, 123–127.
- Roeser, R. W., Eccles, J. S., & Sameroff, A. J. (2000). School as a context of early adolescents' academic social-emotional development: A summary of research findings. *Elementary School Journal*, 100, 443–471.
- Roeser, R. W., Marachi, R., & Gehlbach, H. (2002). A goal theory perspective on teachers' professional identities and the contexts of teaching. In C. Midgley (Ed.), *Goals, goal structures, and patterns of adaptive learning* (pp. 205–241). Mahwah, NJ: Erlbaum.
- Rogers, C. R. (1951). *Client-centered therapy: Its current practice, implication, and theory*. Boston: Houghton Mifflin.
- Rogers, C. R. (1961). *On becoming a person: A therapist's view of psychotherapy*. Boston: Houghton Mifflin.
- Rogers, T. B., Kuiper, N. A., & Kirker, W. S. (1977). Self-reference and the encoding of personal information. *Journal of Personality and Social Psychology*, 35, 677–688.
- Rogers, T. T., & McClelland, J. L. (2004). *Semantic cognition: A parallel distributed processing approach*. Cambridge, MA: MIT Press.
- Rogoff, B. (1990). *Apprenticeship in thinking: Cognitive development in social context*. New York: Oxford University Press.
- Rogoff, B. (1991). Social interaction as apprenticeship in thinking: Guidance and participation in spatial planning. In L. B. Resnick, J. M. Levine, & S. D. Teasley (Eds.), *Perspectives on socially shared cognition* (pp. 349–364). Washington, DC: American Psychological Association.
- Rogoff, B. (1994, April). *Developing understanding of the idea of communities of learners*. Paper presented at the annual meeting of the American Educational Research Association, New Orleans, LA.
- Rogoff, B. (2003). *The cultural nature of human development*. Oxford, England: Oxford University Press.
- Rogoff, B., Matusov, E., & White, C. (1996). Models of teaching and learning: Participation in a community of learners. In D. R. Olson & N. Torrance (Eds.), *The handbook of education and human development: New models of learning, teaching, and schooling* (pp. 388–414). Cambridge, MA: Blackwell.
- Rogoff, B., Mistry, J., Göncü, A., & Mosier, C. (1993). Guided participation in cultural activity by toddlers and caregivers. *Monographs of the Society for Research in Child Development*, 58 (8, Serial No. 236).
- Rogoff, B., Moore, L., Najafi, B., Dexter, A., Correa-Chávez, M., & Solis, J. (2007). Children's development of cultural repertoires through participation in everyday routines and practices. In J. E. Grusec & P. D. Hastings (Eds.), *Handbook of socialization: Theory and research* (pp. 490–515). New York: Guilford Press.
- Rohrbeck, C. A., Ginsburg-Block, M. D., Fantuzzo, J. W., & Miller, T. R. (2003). Peer-assisted learning interventions with elementary school students: A meta-analytic review. *Journal of Educational Psychology*, 95, 240–257.
- Rohrer, D., & Pashler, H. (2007). Increasing retention without increasing study time. *Current Directions in Psychological Science*, 16, 183–186.
- Rohrer, D., & Pashler, H. (2010). Recent research on human learning challenges conventional instructional strategies. *Educational Researcher*, 39, 406–412.
- Román, P., Soriano, M. F., Gómez-Ariza, C. J., & Bajo, M. T. (2009). Retrieval-induced forgetting and executive control. *Psychological Science*, 20, 1053–1058.
- Romaniuk, C., Miltenberger, R., Conyers, C., Jenner, N., Jurgens, M., & Ringenberg, C. (2002). The influence of activity choice on problem behaviors maintained by escape versus attention. *Journal of Applied Behavior Analysis* 35, 349–362.
- Rommetveit, R. (1985). Language acquisition as increasing linguistic structuring of experience and symbolic behavior control. In J. V. Wertsch (Ed.), *Culture, communication, and cognition: Vygotskian perspectives* (pp. 183–204). Cambridge, England: Cambridge University Press.
- Rortvedt, A. K., & Miltenberger, R. G. (1994). Analysis of a high-probability instructional sequence and time-out in the treatment of

- child noncompliance. *Journal of Applied Behavior Analysis*, 27, 327–330.
- Rosales-Ruiz, J., & Baer, D. M. (1997). Behavioral cusps: A developmental and pragmatic concept for behavior analysis. *Journal of Applied Behavior Analysis*, 30, 533–544.
- Rosch, E. H. (1973). Natural categories. *Cognitive Psychology*, 4, 328–350.
- Rosch, E. H. (1978). Principles of categorization. In E. Rosch & B. Lloyd (Eds.), *Cognition and categorization* (pp. 27–48). Hillsdale, NJ: Erlbaum.
- Rosch, E. H., Mervis, C. B., Gray, W. D., Johnson, D. M., & Boyes-Braem, P. (1976). Basic objects in natural categories. *Cognitive Psychology*, 8, 382–439.
- Roscoe, R. D., & Chi, M. T. H. (2007). Understanding tutor learning: Knowledge-building and knowledge-telling in peer tutors' explanations and questions. *Review of Educational Research*, 77, 534–574.
- Rose, S. A., Feldman, J. F., & Jankowski, J. J. (2007). Developmental aspects of visual recognition memory in infancy. In L. M. Oakes & P. J. Bauer (Eds.), *Short- and long-term memory in infancy and early childhood: Taking the first steps toward remembering* (pp. 153–178). New York: Oxford University Press.
- Rose, S. C., & Thornburg, K. R. (1984). Mastery motivation and need for approval in young children: Effects of age, sex, and reinforcement condition. *Educational Research Quarterly*, 9 (1), 34–42.
- Rosenberg, E. L. (1998). Levels of analysis and the organization of affect. *Review of General Psychology*, 2, 247–270.
- Rosenshine, B., & Meister, C. (1992). The use of scaffolds for teaching higher-level cognitive strategies. *Educational Leadership*, 49 (7), 26–33.
- Rosenshine, B., & Meister, C. (1994). Reciprocal teaching: A review of the research. *Review of Educational Research*, 64, 479–530.
- Rosenshine, B., Meister, C., & Chapman, S. (1996). Teaching students to generate questions: A review of the intervention studies. *Review of Educational Research*, 66, 181–221.
- Rosenthal, R. (1994). Interpersonal expectancy effects: A 30-year perspective. *Current Directions in Psychological Science*, 3, 176–179.
- Rosenthal, R. (2002). Covert communication in classrooms, clinics, courtrooms, and cubicles. *American Psychologist*, 57, 839–849.
- Rosenthal, T. L., Alford, G. S., & Rasp, L. M. (1972). Concept attainment, generalization, and retention through observation and verbal coding. *Journal of Experimental Child Psychology*, 13, 183–194.
- Rosenthal, T. L., & Bandura, A. (1978). Psychological modeling: Theory and practice. In S. L. Garfield & A. E. Begia (Eds.), *Handbook of psychotherapy and behavior change: An empirical analysis* (2nd ed., pp. 621–658). New York: Wiley.
- Rosenthal, T. L., & Zimmerman, B. J. (1978). *Social learning and cognition*. New York: Academic Press.
- Ross, B. H., & Spalding, T. L. (1994). Concepts and categories. In R. J. Sternberg (Ed.), *Handbook of perception and cognition* (Vol. 12, pp. 119–148). New York: Academic Press.
- Roth, K. (1990). Developing meaningful conceptual understanding in science. In B. F. Jones & L. Idol (Eds.), *Dimensions of thinking and cognitive instruction* (pp. 139–175). Hillsdale, NJ: Erlbaum.
- Roth, K. (2002). Talking to understand science. In J. Brophy (Ed.), *Social constructivist teaching: Affordances and constraints* (pp. 197–262). New York: Elsevier.
- Roth, K., & Anderson, C. (1988). Promoting conceptual change learning from science textbooks. In P. Ramsden (Ed.), *Improving learning: New perspectives* (pp. 109–141). London: Kogan Page.
- Roth, W., & Bowen, G. M. (1995). Knowing and interacting: A study of culture, practices, and resources in a grade 8 open-inquiry science classroom guided by a cognitive apprenticeship metaphor. *Cognition and Instruction*, 13, 73–128.
- Roth, W.-M. (2001). Gestures: Their role in teaching and learning. *Review of Educational Research*, 71, 365–392.
- Rothbaum, E., & Trommsdorff, G. (2007). Do roots and wings complement or oppose one another? The socialization of relatedness and autonomy in cultural context. In J. E. Grusec & P. D. Hastings (Eds.), *Handbook of socialization: Theory and research* (pp. 461–489). New York: Guilford Press.
- Rothbaum, E., Weisz, J. R., & Snyder, S. S. (1982). Changing the world and changing the self: A two-process model of perceived control. *Journal of Personality and Social Psychology*, 42, 5–37.
- Rouder, J. N., & Ratcliff, R. (2006). Comparing exemplar- and rule-based theories of categorization. *Current Directions in Psychological Science*, 15, 9–13.
- Rovee-Collier, C. (1993). The capacity for long-term memory in infancy. *Current Directions in Psychological Science*, 2, 130–135.
- Rovee-Collier, C. (1999). The development of infant memory. *Current Directions in Psychological Science*, 8, 80–85.
- Rowe, M. B. (1974). Wait-time and rewards as instructional variables, their influence on language, logic, and fate control: Part I. Wait time. *Journal of Research in Science Teaching*, 11, 81–94.
- Rowe, M. B. (1987). Wait time: Slowing down may be a way of speeding up. *American Educator*, 11 (1), 38–43, 47.
- Rubin, D. C. (1992). Constraints on memory. In E. Winograd & U. Neisser (Eds.), *Affect and accuracy in recall: Studies of "flashbulb" memories* (pp. 265–273). Cambridge, England: Cambridge University Press.
- Rubin, D. C. (2006). The basic-systems model of episodic memory. *Perspectives on Psychological Science*, 1, 277–311.
- Rubinyi, S. (2007). *Natural genius: The gifts of Asperger's syndrome*. London: Jessica Kingsley Publications.
- Rueckl, J. G., & Seidenberg, M. S. (2009). Computational modeling and the neural bases of reading and reading disorders. In K. Pugh & P. McCardle (Eds.), *How children learn to read: Current issues and new directions in the integration of cognition, neurobiology and genetics of reading and dyslexia research and practice* (pp. 101–133). New York: Psychology Press.
- Rueda, R., & Moll, L. C. (1994). A sociocultural perspective on motivation. In H. F. O'Neil, Jr., & M. Drillings (Eds.), *Motivation: Theory and research* (pp. 117–137). Hillsdale, NJ: Erlbaum.
- Ruef, M. B., Higgins, C., Glaeser, B., & Patnode, M. (1998). Positive behavioral support: Strategies for teachers. *Intervention in School and Clinic*, 34 (1), 21–32.
- Rueger, D. B., & Liberman, R. P. (1984). Behavioral family therapy for delinquent substance-abusing adolescents. *Journal of Drug Abuse*, 14, 403–418.
- Ruffman, T., Perner, J., Olson, D. R., & Doherty, M. (1993). Reflecting on scientific thinking: Children's understanding of the hypothesis-evidence relation. *Child Development*, 64, 1617–1636.
- Rumelhart, D. E., & McClelland, J. L. (1986). *Parallel distributed processing* (Vol. 1). Cambridge, MA: MIT Press.
- Rumelhart, D. E., & Ortony, A. (1977). The representation of knowledge in memory. In R. C. Anderson, R. J. Spiro, & W. E. Montague (Eds.), *Schooling and the acquisition of knowledge* (pp. 99–136). Hillsdale, NJ: Erlbaum.
- Rummel, N., Levin, J. R., & Woodward, M. M. (2003). Do pictorial mnemonic text-learning aids give students something worth writing about? *Journal of Educational Psychology*, 95, 327–334.
- Runco, M. A., & Chand, I. (1995). Cognition and creativity. *Educational Psychology Review*, 7, 243–267.
- Rundus, D. (1971). Analysis of rehearsal processes in free recall. *Journal of Experimental Psychology*, 89, 63–77.
- Rundus, D., & Atkinson, R. C. (1971). Rehearsal processes in free recall: A procedure for direct observation. *Journal of Verbal Learning and Verbal Behavior*, 9, 99–105.
- Rusch, F., & Close, D. (1976). Overcorrection: A procedural evaluation. *AAESPH Review*, 1, 32–45.
- Rushton, J. P. (1980). *Altruism, socialization, and society*. Englewood Cliffs, NJ: Prentice Hall.
- Rushton, J. P. (1982). Social learning theory and the development of prosocial behavior. In N. Eisenberg (Ed.), *The development of prosocial behavior* (pp. 77–105). New York: Academic Press.
- Ryan, A. M., Hicks, L., & Midgley, C. (1997). Social goals, academic goals, and avoiding seeking help in the classroom. *Journal of Early Adolescence*, 17, 152–171.
- Ryan, A. M., & Patrick, H. (2001). The classroom social environment and changes in adolescents' motivation and engagement during middle school. *American Educational Research Journal*, 38, 437–460.

- Ryan, A. M., Pintrich, P. R., & Midgley, C. (2001). Avoiding seeking help in the classroom: Who and why? *Educational Psychology Review*, 13, 93–114.
- Ryan, A. M., & Shim, S. S. (2008). An exploration of young adolescents' social achievement goals and social adjustment in middle school. *Journal of Educational Psychology*, 100, 672–687.
- Ryan, C. S., & Hemmes, N. S. (2005). Effects of the contingency for homework submission on homework submission and quiz performance in a college course. *Journal of Applied Behavior Analysis*, 38, 79–88.
- Ryan, K. E., Ryan, A. M., Arbutnot, K., & Samuels, M. (2007). Students' motivation for standardized math exams. *Educational Researcher*, 36 (1), 5–13.
- Ryan, R. M., & Brown, K. W. (2005). Legislating competence: High-stakes testing policies and their relations with psychological theories and research. In A. J. Elliot & C. S. Dweck (Eds.), *Handbook of competence and motivation* (pp. 354–372). New York: Guilford Press.
- Ryan, R. M., Connell, J. P., & Grolnick, W. S. (1992). When achievement is not intrinsically motivated: A theory of internalization and self-regulation in school. In A. K. Boggiano & T. S. Pittman (Eds.), *Achievement and motivation: A social-developmental perspective* (pp. 167–188). Cambridge, England: Cambridge University Press.
- Ryan, R. M., & Deci, E. L. (2000). Self-determination theory and the facilitation of intrinsic motivation, social development, and well-being. *American Psychologist*, 55, 68–78.
- Ryan, R. M., Mims, V., & Koestner, R. (1983). Relation of reward contingency and interpersonal context to intrinsic motivation: A review and test using cognitive evaluation theory. *Journal of Personality and Social Psychology*, 45, 736–750.
- Ryan, S., Ormond, T., Imwold, C., & Rotunda, R. J. (2002). The effects of a public address system on the off-task behavior of elementary physical education students. *Journal of Applied Behavior Analysis*, 35, 305–308.
- Sadoski, M., & Paivio, A. (2001). *Imagery and text: A dual coding theory of reading and writing*. Mahwah, NJ: Erlbaum.
- Saffran, J. R. (2003). Statistical language learning: Mechanisms and constraints. *Current Directions in Psychological Science*, 12, 110–114.
- Saljo, R., & Wyndham, J. (1992). Solving everyday problems in the formal setting: An empirical study of the school as context for thought. In S. Chaiklin & J. Lave (Eds.), *Understanding practice* (pp. 327–342). New York: Cambridge University Press.
- Salomon, G. (1993). No distribution without individuals' cognition: A dynamic interactional view. In G. Salomon (Ed.), *Distributed cognitions: Psychological and educational considerations* (pp. 111–138). Cambridge, England: Cambridge University Press.
- Salomon, G. (1994). *Interaction of media, cognition, and learning*. Hillsdale, NJ: Erlbaum. (Originally published 1979)
- Salthouse, T. A. (1991). Mediation of adult age differences in cognition by reductions in working memory and speed of processing. *Psychological Science*, 2, 179–183.
- Salthouse, T. A. (2006). Mental exercise and mental aging: Evaluating the validity of the "use it or lose it" hypothesis. *Perspectives on Psychological Science*, 1, 68–87.
- Saltz, E. (1971). *The cognitive bases of human learning*. Homewood, IL: Dorsey.
- Samarova, E. I., Bravarenko, N. I., Korshunova, T. A., Gulyaeva, N. V., Palotás, A., & Balaban, P. M. (2005). Effect of  $\beta$ -amyloid peptide on behavior and synaptic plasticity in terrestrial snail. *Brain Research Bulletin*, 67, 40–45.
- Samuel, A. L. (1963). Some studies in machine learning using the game of checkers. In E. A. Feigenbaum & J. Feldman (Eds.), *Computers and thought* (pp. 71–105). New York: McGraw-Hill.
- Samuels, S. J. (1967). Attentional processes in reading: The effect of pictures in the acquisition of reading responses. *Journal of Educational Psychology*, 58, 337–342.
- Samuels, S. J. (1970). Effects of pictures on learning to read, comprehension and attitudes. *Review of Educational Research*, 40, 397–407.
- Samuels, S. J., & Turnure, J. E. (1974). Attention and reading achievement in first-grade boys and girls. *Journal of Educational Psychology*, 66, 29–32.
- Sansone, C., & Smith, J. (2002). Interest and self-regulation: The relation between having to and wanting to. In C. Sansone & J. Harackiewicz (Eds.), *Intrinsic and extrinsic motivation: The search for optimal motivation and performance* (pp. 341–372). San Diego, CA: Academic Press.
- Sansone, C., Weir, C., Harpster, L., & Morgan, C. (1992). Once a boring task always a boring task? Interest as a self-regulatory mechanism. *Journal of Personality and Social Psychology*, 63, 379–390.
- Sapolsky, R. M. (1999). Glucocorticoids, stress, and their adverse neurological effects: Relevance to aging. *Experimental Gerontology*, 34, 721–732.
- Saracho, O. N., & B. Spodek, B. (Eds.) (1998). *Multiple perspectives on play in early childhood education*. Albany: State University of New York Press.
- Sarama, J., & Clements, D. H. (2009). "Concrete" computer manipulatives in mathematics education. *Child Development Perspectives*, 3, 145–150.
- Sarason, I. G. (Ed.) (1980). *Test anxiety: Theory, research, and applications*. Hillsdale, NJ: Erlbaum.
- Sasso, G. M., & Rude, H. A. (1987). Unprogrammed effects of training high-status peers to interact with severely handicapped children. *Journal of Applied Behavior Analysis*, 20, 35–44.
- Savani, K., Markus, H. R., Naidu, N. V. R., Kumar, S., & Berlia, N. (2010). What counts as a choice? U.S. Americans are more likely than Indians to construe actions as choices. *Psychological Science*, 21, 391–398.
- Saville, B. K., Zinn, T. E., Neef, N. A., Van Norman, R., & Ferreri, S. J. (2006). A comparison of interteaching and lecture in the college classroom. *Journal of Applied Behavior Analysis* 39, 49–61.
- Sawyer, R. J., Graham, S., & Harris, K. R. (1992). Direct teaching, strategy instruction, and strategy instruction with explicit self-regulation: Effects on the composition skills and self-efficacy of students with learning disabilities. *Journal of Educational Psychology*, 84, 340–352.
- Sawyer, R. K. (2006). Introduction: The new science of learning. In R. K. Sawyer (Ed.), *The Cambridge handbook of the learning sciences* (pp. 1–16). Cambridge, England: Cambridge University Press.
- Sawyer, R. K., & Greeno, J. G. (2009). Situativity and learning. In P. Robbins & M. Aydede (Eds.), *The Cambridge handbook of situated cognition* (pp. 347–367). Cambridge, England: Cambridge University Press.
- Scandura, J. M. (1974). Role of higher order rules in problem solving. *Journal of Experimental Psychology*, 102, 984–991.
- Scardamalia, M., & Bereiter, C. (1985). Fostering the development of self-regulation in children's knowledge processing. In S. F. Chipman, J. W. Segal, & R. Glaser (Eds.), *Thinking and learning skills: Vol. 2. Research and open questions* (pp. 65–80). Hillsdale, NJ: Erlbaum.
- Scardamalia, M., & Bereiter, C. (2006). Knowledge building: Theory, pedagogy, and technology. In R. K. Sawyer (Ed.), *The Cambridge handbook of the learning sciences* (pp. 97–115). Cambridge, England: Cambridge University Press.
- Secevak, J. J., Moore, P. J., & Kirby, J. R. (1993). Training students to use maps to increase text recall. *Contemporary Educational Psychology*, 18, 401–413.
- Schab, F. (1990). Odors and the remembrance of things past. *Journal of Experimental Psychology: Learning, Memory, and Cognition*, 16, 648–655.
- Schacter, D. L. (1989). Memory. In M. I. Posner (Ed.), *Foundations of cognitive science* (pp. 683–725). Cambridge, MA: MIT Press.
- Schacter, D. L. (1999). The seven sins of memory: Insights from psychology and neuroscience. *American Psychologist*, 54, 182–203.
- Schank, R. C., & Abelson, R. P. (1977). *Scripts, plans, goals, and understanding: An inquiry into human knowledge structures*. Hillsdale, NJ: Erlbaum.
- Schauble, L. (1990). Belief revision in children: The role of prior knowledge and strategies for generating evidence. *Journal of Experimental Child Psychology*, 49, 31–57.
- Schellings, G. L. M., Van Hout-Wolters, B., & Vermunt, J. D. (1996). Individual differences in adapting to three different tasks of selecting information from texts. *Contemporary Educational Psychology*, 21, 423–446.
- Schiller, D., Monfils, M.-H., Raaij, C. M., Johnson, D. C., LeDoux, J. E., & Phelps, E. A. (2010). Preventing the return of fear in humans using reconsolidation update mechanisms. *Nature*, 463 (7277), 49–53.

- Schimmöeller, M. A. (1998, April). *Influence of private speech on the writing behaviors of young children: Four case studies*. Paper presented at the annual meeting of the American Educational Research Association, San Diego, CA.
- Schliemann, A. D., & Carraher, D. W. (1993). Proportional reasoning in and out of school. In P. Light & G. Butterworth (Eds.), *Context and cognition: Ways of learning and knowing* (pp. 47–73). Hillsdale, NJ: Erlbaum.
- Schloss, P. J., & Smith, M. A. (1994). *Applied behavior analysis in the classroom*. Boston: Allyn & Bacon.
- Schmader, T. (2010). Stereotype threat deconstructed. *Current Directions in Psychological Science*, 19, 14–18.
- Schmidt, H. G., van der Molen, H. T., te Winkel, W. W. R., & Wijnen, W. H. F. W. (2009). Constructivist, problem-based learning does work: A meta-analysis of curricular comparisons involving a single medical school. *Educational Psychologist*, 44, 227–249.
- Schmidt, R. A., & Bjork, R. A. (1992). New conceptualizations of practice: Common principles in three paradigms suggest new concepts for training. *Psychological Science*, 3, 207–217.
- Schmidt, R. A., & Young, D. E. (1987). Transfer of movement control in motor skill learning. In S. M. Cormier & J. D. Hagman (Eds.), *Transfer of learning: Contemporary research and applications* (pp. 47–79). San Diego, CA: Academic Press.
- Schmidt, W. H. (2008, Spring). What's missing from math standards? *American Educator*. Retrieved March 3, 2008, from [http://www.aft.org/pubs-reports/american\\_educator/issues/spring2008/schmidt.htm](http://www.aft.org/pubs-reports/american_educator/issues/spring2008/schmidt.htm).
- Schmolck, H., Buffalo, E. A., & Squire, L. R. (2000). Memory distortions develop over time: Recollections of the O. J. Simpson trial verdict after 15 and 32 months. *Psychological Science*, 11, 39–45.
- Schneider, W. (1993). Domain-specific knowledge and memory performance in children. *Educational Psychology Review*, 5, 257–273.
- Schneider, W. (2010). Metacognition and memory development in childhood and adolescence. In H. S. Waters & W. Schneider (Eds.), *Metacognition, strategy use, and instruction* (pp. 54–81). New York: Guilford Press.
- Schneider, W., Körköl, J., & Weinert, F. E. (1990). Expert knowledge, general abilities, and text processing. In W. Schneider & F. E. Weinert (Eds.), *Interactions among aptitudes, strategies, and knowledge in cognitive performance* (pp. 235–251). New York: Springer-Verlag.
- Schneider, W., & Lockl, K. (2002). The development of metacognitive knowledge in children and adolescents. In T. J. Perfect & B. L. Schwartz (Eds.), *Applied metacognition* (pp. 224–257). Cambridge, England: Cambridge University Press.
- Schneider, W., & Pressley, M. (1989). *Memory development between 2 and 20*. New York: Springer-Verlag.
- Schneider, W., & Shiffrin, R. M. (1977). Controlled and automatic human information processing: I. Detection, search, and attention. *Psychological Review*, 84, 1–66.
- Schoenfeld, A. H. (1979). Explicit heuristic training as a variable in problem solving performance. *Journal for Research in Mathematics Education*, 10, 173–187.
- Schoenfeld, A. H. (1982). Measures of problem-solving performance and problem-solving instruction. *Journal for Research in Mathematics Education*, 13, 31–49.
- Schoenfeld, A. H. (1985). Metacognitive and epistemological issues in mathematical understanding. In E. A. Silver (Ed.), *Teaching and learning mathematical problem solving: Multiple research perspectives* (pp. 361–380). Hillsdale, NJ: Erlbaum.
- Schoenfeld, A. H. (1988). When good teaching leads to bad results: The disasters of “well-taught” mathematics courses. *Educational Psychologist*, 23, 145–166.
- Schoenfeld, A. H. (1992). Learning to think mathematically: Problem solving, metacognition, and sense-making in mathematics. In D. A. Grouws (Ed.), *Handbook of research on mathematics teaching and learning* (pp. 334–370). New York: Macmillan.
- Schoenfeld, A. H., & Herrmann, D. J. (1982). Problem perception and knowledge structure in expert and novice mathematical problem solvers. *Journal of Experimental Psychology: Learning, Memory, and Cognition*, 8, 484–494.
- Schommer, M. (1990). Effects of beliefs about the nature of knowledge on comprehension. *Journal of Educational Psychology*, 82, 498–504.
- Schommer, M. (1994a). An emerging conceptualization of epistemological beliefs and their role in learning. In R. Garner & P. A. Alexander (Eds.), *Beliefs about text and instruction with text* (pp. 25–40). Hillsdale, NJ: Erlbaum.
- Schommer, M. (1994b). Synthesizing epistemological belief research: Tentative understandings and provocative confusions. *Educational Psychology Review*, 6, 293–319.
- Schommer, M., Calvert, C., Gariglietti, G., & Bajaj, A. (1997). The development of epistemological beliefs among secondary students: A longitudinal study. *Journal of Educational Psychology*, 89, 37–40.
- Schommer-Aikins, M. (2002). An evolving theoretical framework for an epistemological belief system. In B. K. Hofer & P. R. Pintrich (Eds.), *Personal epistemology: The psychology of beliefs about knowledge and knowing* (pp. 103–118). Mahwah, NJ: Erlbaum.
- Schommer-Aikins, M. (2004). Explaining the epistemological belief system: Introducing the embedded systemic model and coordinated research approach. *Educational Psychologist*, 39, 19–29.
- Schommer-Aikins, M., Duell, O. K., & Hutter, R. (2005). Epistemological beliefs, mathematical problem-solving beliefs, and academic performance of middle school students. *Elementary School Journal*, 105, 289–304.
- Schommer-Aikins, M., & Easter, M. (2005, April). *Ways of knowing: Similar epistemological beliefs but different strategic emphasis*. Paper presented at the annual meeting of the American Educational Research Association, Montreal.
- Schommer-Aikins, M., & Easter, M. (2008). Epistemological beliefs' contributions to study strategies of Asian Americans and European Americans. *Journal of Educational Psychology*, 100, 920–929.
- Schommer-Aikins, M., Hopkins, L., Anderson, C., & Drouhard, B. (2005, April). *Epistemological beliefs and need for cognition of traditional and non-traditional students*. Paper presented at the annual meeting of the American Educational Research Association, Montreal.
- Schooler, J. W. (2001). Discovering memories of abuse in the light of meta-awareness. *Journal of Aggression, Maltreatment, and Trauma*, 4, 105–136.
- Schraw, G. (2006). Knowledge: Structures and processes. In P. A. Alexander & P. H. Winne (Eds.), *Handbook of educational psychology* (2nd ed., pp. 245–263). Mahwah, NJ: Erlbaum.
- Schraw, G., Bendixen, L. D., & Dunkle, M. E. (2002). Development and validation of the Epistemic Belief Inventory (EBI). In B. K. Hofer & P. R. Pintrich (Eds.), *Personal epistemology: The psychology of beliefs about knowledge and knowing* (pp. 261–275). Mahwah, NJ: Erlbaum.
- Schraw, G., & Bruning, R. (1995, April). *Reader beliefs and reading comprehension*. Paper presented at the annual meeting of the American Educational Research Association, San Francisco.
- Schraw, G., Dunkle, M. E., & Bendixen, L. D. (1995). Cognitive processes in well-defined and ill-defined problem solving. *Applied Cognitive Psychology*, 9, 523–538.
- Schraw, G., Flowerday, T., & Lehman, S. (2001). Increasing situational interest in the classroom. *Educational Psychology Review*, 13, 211–224.
- Schraw, G., & Lehman, S. (2001). Situational interest: A review of the literature and directions for future research. *Educational Psychology Review*, 13, 23–52.
- Schraw, G., & Moshman, D. (1995). Metacognitive theories. *Educational Psychology Review*, 7, 351–371.
- Schraw, G., Potenza, M. T., & Nebelsick-Gullet, L. (1993). Constraints on the calibration of performance. *Contemporary Educational Psychology*, 18, 455–463.
- Schroth, M. L. (1992). The effects of delay of feedback on a delayed concept formation transfer task. *Contemporary Educational Psychology*, 17, 78–82.
- Schult, C. A. (2002). Children's understanding of the distinction between intentions and desires. *Child Development*, 73, 1727–1747.
- Schultheiss, O. C., & Brunstein, J. C. (2005). An implicit motive perspective on competence. In A. J. Elliot & C. S. Dweck (Eds.), *Handbook of competence and motivation* (pp. 31–51). New York: Guilford Press.
- Schultz, K., & Lochhead, J. (1991). A view from physics. In M. U. Smith (Ed.), *Toward a unified theory of problem solving: Views from the content domains* (pp. 99–114). Hillsdale, NJ: Erlbaum.
- Schulz, L. E., Hooppell, C., & Jenkins, A. C. (2008). Judicious imitation: Children differentially

- imitate deterministically and probabilistically effective actions. *Child Development*, 79, 395–410.
- Schumacher, E. H., Seymour, T. L., Glass, J. M., Fencsik, D. E., Lauber, E. J., Kieras, D. E., et al. (2001). Virtually perfect time sharing in dual-task performance: Uncorking the central cognitive bottleneck. *Psychological Science*, 12, 101–108.
- Schunk, D. H. (1981). Modeling and attributional effects on children's achievement: A self-efficacy analysis. *Journal of Educational Psychology*, 73, 93–105.
- Schunk, D. H. (1987). Peer models and children's behavioral change. *Review of Educational Research*, 57, 149–174.
- Schunk, D. H. (1989a). Self-efficacy and achievement behaviors. *Educational Psychology Review*, 1, 173–208.
- Schunk, D. H. (1989b). Self-efficacy and cognitive skill learning. In C. Ames & R. Ames (Eds.), *Research on motivation in education: Vol. 3. Goals and cognitions* (pp. 13–44). San Diego, CA: Academic Press.
- Schunk, D. H. (1989c). Social cognitive theory and self-regulated learning. In B. J. Zimmerman & D. H. Schunk (Eds.), *Self-regulated learning and academic achievement: Theory, research, and practice* (pp. 83–110). New York: Springer-Verlag.
- Schunk, D. H. (1990, April). *Socialization and the development of self-regulated learning: The role of attributions*. Paper presented at the annual meeting of the American Educational Research Association, Boston.
- Schunk, D. H. (1995). Inherent details of self-regulated learning include student perceptions. *Educational Psychologist*, 30, 213–216.
- Schunk, D. H. (1998). Teaching elementary students to self-regulate practice of mathematical skills with modeling. In D. H. Schunk & B. J. Zimmerman (Eds.), *Self-regulated learning: From teaching to self-reflective practice* (pp. 137–159). New York: Guilford Press.
- Schunk, D. H., & Hanson, A. R. (1985). Peer models: Influence on children's self-efficacy and achievement. *Journal of Educational Psychology*, 77, 313–322.
- Schunk, D. H., Hanson, A. R., & Cox, P. D. (1987). Peer-model attributes and children's achievement behaviors. *Journal of Educational Psychology*, 79, 54–61.
- Schunk, D. H., & Pajares, F. (2004). Self-efficacy in education revisited: Empirical and applied evidence. In D. M. McInerney & S. Van Etten (Eds.), *Big theories revisited* (pp. 115–138). Greenwich, CT: Information Age.
- Schunk, D. H., & Pajares, F. (2005). Competence perceptions and academic functioning. In A. J. Elliot & C. S. Dweck (Eds.), *Handbook of competence and motivation* (pp. 85–104). New York: Guilford Press.
- Schunk, D. H., & Swartz, C. W. (1993). Goals and progress feedback: Effects on self-efficacy and writing achievement. *Contemporary Educational Psychology*, 18, 337–354.
- Schunk, D. H., & Zimmerman, B. J. (1997). Social origins of self-regulatory competence. *Educational Psychologist*, 32, 195–208.
- Schunk, D. H., & Zimmerman, B. J. (2006). Competence and control beliefs: Distinguishing the means and ends. In P. A. Alexander & P. H. Winne (Eds.), *Handbook of educational psychology* (2nd ed., pp. 349–367). Mahwah, NJ: Erlbaum.
- Schupp, H. T., Junghöfer, M., Weike, A. I., & Hamm, A. O. (2003). Emotional facilitation of sensory processing in the visual cortex. *Psychological Science*, 14, 7–13.
- Schutz, P. A. (1994). Goals as the transactive point between motivation and cognition. In P. R. Pintrich, D. R. Brown, & C. E. Weinstein (Eds.), *Student motivation, cognition, and learning: Essays in honor of Wilbert J. McKeachie* (pp. 113–133). Hillsdale, NJ: Erlbaum.
- Schwaborn, A., Mayer, R. E., Thillmann, H., Leopold, C., & Leutner, D. (2010). Drawing as a generative activity and drawing as a prognostic activity. *Journal of Educational Psychology*, 102, 872–879.
- Schwartz, B., & Reisberg, D. (1991). *Learning and memory*. New York: W. W. Norton.
- Schwartz, D. L., & Heiser, J. (2006). Spatial representations and imagery in learning. In R. K. Sawyer (Ed.), *The Cambridge handbook of the learning sciences* (pp. 283–298). Cambridge, England: Cambridge University Press.
- Schwartz, D. L., & Martin, T. (2004). Inventing to prepare for future learning: The hidden efficiency of encouraging original student production in statistics instruction. *Cognition and Instruction*, 22, 129–184.
- Schwarz, B. B., Neuman, Y., & Biezuner, S. (2000). Two wrongs may make a right . . . if they argue together! *Cognition and Instruction*, 18, 461–494.
- Schwarz, N., & Skurnik, I. (2003). Feeling and thinking: Implications for problem solving. In J. E. Davidson & R. J. Sternberg (Eds.), *The psychology of problem solving* (pp. 263–290). Cambridge, England: Cambridge University Press.
- Schwebel, A. I., & Cherlin, D. L. (1972). Physical and social distancing in teacher-pupil relationships. *Journal of Educational Psychology*, 63, 543–550.
- Schweinhart, L. J., Montie, J., Xiang, Z., Barnett, W. S., Belfield, C. R., & Nores, M. (2005). *Lifetime effects: The High/Scope Perry Preschool Study through age 40*. Ypsilanti, MI: High/Scope Foundation.
- Schweininle, A., Meyer, D. K., & Turner, J. C. (2006). Striking the right balance: Students' motivation and affect in elementary mathematics. *Journal of Educational Research*, 99, 271–293.
- Seamon, J. G., Luo, C. R., & Gallo, D. A. (1998). Creating false memories of words with or without recognition of list items: Evidence for nonconscious processes. *Psychological Science*, 9, 20–26.
- Sedikides, C., & Gregg, A. P. (2008). Self-enhancement: Food for thought. *Perspectives on Psychological Science*, 3, 102–116.
- Seligman, M. E. P. (1975). *Helplessness*. San Francisco: Freeman.
- Seligman, M. E. P. (1991). *Learned optimism*. New York: Alfred Knopf.
- Seligman, M. E. P., & Maier, S. F. (1967). Failure to escape traumatic shock. *Journal of Experimental Psychology*, 74, 1–9.
- Semb, G. B., & Ellis, J. A. (1994). Knowledge taught in school: What is remembered? *Review of Educational Research*, 64, 253–286.
- Semb, G. B., Ellis, J. A., & Araujo, J. (1993). Long-term memory for knowledge learned in school. *Journal of Educational Psychology*, 85, 305–316.
- Senko, C., & Harackiewicz, J. M. (2005). Regulation of achievement goals: The role of competence feedback. *Journal of Educational Psychology*, 97, 320–336.
- Senko, C., & Miles, K. M. (2008). Pursuing their own learning agenda: How mastery-oriented students jeopardize their class performance. *Contemporary Educational Psychology*, 33, 561–583.
- Serences, J. T., Ester, E. F., Vogel, E. K., & Awh, E. (2009). Stimulus-specific delay activity in human primary visual cortex. *Psychological Science*, 20, 207–214.
- Sergeant, J. (1996). A theory of attention: An information processing perspective. In G. R. Lyon & N. A. Krasnegor (Eds.), *Attention, memory, and executive function* (pp. 57–69). Baltimore: Paul H. Brookes.
- Serra, M. J., & Metcalfe, J. (2009). Effective implementation of metacognition. In D. J. Hacker, J. Dunlosky, & A. C. Graesser (Eds.), *Handbook of metacognition in education* (pp. 278–298). New York: Routledge.
- Sfard, A. (1997). Commentary: On metaphorical roots of conceptual growth. In L. D. English (Ed.), *Mathematical reasoning: Analogies, metaphors, and images* (pp. 339–371). Mahwah, NJ: Erlbaum.
- Sfard, A. (1998). On two metaphors for learning and the dangers of choosing just one. *Educational Researcher*, 27 (2), 4–13.
- Shabani, D. B., Carr, J. E., & Petrusdotir, A. I. (2009). A laboratory model for studying response-class hierarchies. *Journal of Applied Behavior Analysis*, 42, 105–121.
- Shah, J. Y. (2005). The automatic pursuit and management of goals. *Current Directions in Psychological Science*, 14, 10–13.
- Shah, P., & Hoefner, J. (2002). Review of graph comprehension research: Implications for instruction. *Educational Psychology Review*, 14, 47–69.
- Shah, P., & Miyake, A. (1996). The separability of working memory resources for spatial thinking and language processing: An individual differences approach. *Journal of Experimental Psychology: General*, 125, 4–27.
- Shanahan, C. (2004). Teaching science through literacy. In T. L. Jetton & J. A. Dole (Eds.), *Adolescent literacy research and practice* (pp. 75–93). New York: Guilford Press.
- Shanahan, T. (2004). Overcoming the dominance of communication: Writing to think and to learn. In T. L. Jetton & J. A. Dole (Eds.), *Adolescent literacy research and practice* (pp. 59–74). New York: Guilford Press.
- Shapiro, A. M. (2004). How including prior knowledge as a subject variable may change

- outcomes of learning research. *American Educational Research Journal*, 41, 159–189.
- Shapley, K. S. (1994, April). *Metacognition, motivation, and learning: A study of middle school students' use and development of self-regulated learning strategies*. Paper presented at the annual meeting of the American Educational Research Association, New Orleans, LA.
- Sheffield, F. D. (1966a). A drive-induction theory of reinforcement. In R. N. Haber (Ed.), *Current research in motivation* (pp. 98–111). New York: Holt, Rinehart & Winston.
- Sheffield, F. D. (1966b). New evidence on the drive-induction theory of reinforcement. In R. N. Haber (Ed.), *Current research in motivation* (pp. 111–122). New York: Holt, Rinehart & Winston.
- Shepard, L., Hammerness, K., Darling-Hammond, L., & Rust, F. (with Snowden, J. B., Gordon, E., Gutierrez, C., & Pacheco, A.) (2005). Assessment. In L. Darling-Hammond & J. Bransford (Eds.), *Preparing teachers for a changing world: What teachers should learn and be able to do* (pp. 275–326). San Francisco: Jossey-Bass/Wiley.
- Shepard, R. N., & Metzler, J. (1971). Mental rotation of three-dimensional objects. *Science*, 171, 701–703.
- Shepperd, J. A., & McNulty, J. K. (2002). The affective consequences of expected and unexpected outcomes. *Psychological Science*, 13, 85–88.
- Sherman, D. K., & Cohen, G. L. (2002). Accepting threatening information: Self-affirmation and the reduction of defensive biases. *Current Directions in Psychological Science*, 11, 119–123.
- Sherman, J., & Bisanz, J. (2009). Equivalence in symbolic and nonsymbolic contexts: Benefits of solving problems with manipulatives. *Journal of Educational Psychology*, 101, 88–100.
- Sherman, J. W., & Bessenoff, G. R. (1999). Stereotypes as source-monitoring cues: On the interaction between episodic and semantic memory. *Psychological Science*, 10, 106–110.
- Shernoff, D. J., & Csikszentmihalyi, M. (2009). Flow in schools: Cultivating engaged learners and optimal learning environments. In R. Gilman, E. S. Huebner, & M. J. Furlong (Eds.), *Handbook of positive psychology in schools* (pp. 131–145). New York: Routledge.
- Shernoff, D. J., & Hoogstra, L. A. (2001). Continuing motivation beyond the high school classroom. In M. Michaelson & J. Nakamura (Eds.), *Supportive frameworks for youth engagement* (pp. 73–87). San Francisco: Jossey-Bass.
- Shiffrin, R. M., & Schneider, W. (1977). Controlled and automatic human information processing: II. Perceptual learning, automatic attending, and a general theory. *Psychological Review*, 84, 127–190.
- Shim, S. S., Ryan, A. M., & Anderson, C. J. (2008). Achievement goals and achievement during early adolescence: Examining time-varying predictor and outcome variables in growth-curve analysis. *Journal of Educational Psychology*, 100, 655–671.
- Shimmerlick, S. M., & Nolan, J. D. (1976). Reorganization and the recall of prose. *Journal of Educational Psychology*, 68, 779–786.
- Shimoff, E., Catania, A. C., & Matthews, B. A. (1981). Uninstructed human responding: Sensitivity of low-rate performance to schedule contingencies. *Journal of the Experimental Analysis of Behavior*, 36, 207–220.
- Shulman, H. G. (1971). Similarity effects in short-term memory. *Psychological Bulletin*, 75, 399–415.
- Shulman, H. G. (1972). Semantic confusion errors in short-term memory. *Journal of Verbal Learning and Verbal Behavior*, 11, 221–227.
- Shute, V. J. (2008). Focus on formative feedback. *Review of Educational Research*, 78, 153–189.
- Shymansky, J. A., Hedges, L. V., & Woodworth, G. (1990). A reassessment of the effects of inquiry-based science curricula of the 60s on student performance. *Journal of Research in Science Teaching*, 27, 127–144.
- Sideridis, G. D. (2005). Goal orientation, academic achievement, and depression: Evidence in favor of a revised goal theory framework. *Journal of Educational Psychology*, 97, 366–375.
- Siegel, D. J. (1999). *The developing mind: How relationships and the brain interact to shape who we are*. New York: Guilford Press.
- Siegel, S. (1975). Evidence from rats that morphine tolerance is learned response. *Journal of Comparative and Physiological Psychology*, 89, 498–506.
- Siegel, S. (1979). The role of conditioning in drug tolerance and addiction. In J. D. Keehn (Ed.), *Psychopathology in animals: Research and treatment implications* (pp. 143–168). New York: Academic Press.
- Siegel, S. (2005). Drug tolerance, drug addiction, and drug anticipation. *Current Directions in Psychological Science*, 14, 296–300.
- Siegel, S., & Andrews, J. M. (1962). Magnitude of reinforcement and choice behavior in children. *Journal of Experimental Psychology*, 63, 337–341.
- Siegel, S., Baptista, M. A. S., Kim, J. A., McDonald, R. V., & Weise-Kelly, L. (2000). Pavlovian psychopharmacology: The associative basis of tolerance. *Experimental and Clinical Psychopharmacology*, 10, 162–183.
- Siegler, R. S., & Alibali, M. W. (2005). *Children's thinking* (4th ed.). Upper Saddle River, NJ: Prentice Hall.
- Siegler, R. S., & Chen, Z. (2008). Differentiation and integration: Guiding principles for analyzing cognitive change. *Developmental Science*, 11, 433–448.
- Siegler, R. S., & Jenkins, E. (1989). *How children discover new strategies*. Hillsdale, NJ: Erlbaum.
- Siegler, R. S., & Lin, X. (2010). Self-explanations promote children's learning. In H. S. Waters & W. Schneider (Eds.), *Metacognition, strategy use, and instruction* (pp. 85–112). New York: Guilford Press.
- Sigman, M., & Whaley, S. E. (1998). The role of nutrition in the development of intelligence. In U. Neisser (Ed.), *The rising curve: Long-term gains in IQ and related measures* (pp. 155–182). Washington, DC: American Psychological Association.
- Silver, E. A. (Ed.) (1985). *Teaching and learning mathematical problem solving: Multiple research perspectives*. Hillsdale, NJ: Erlbaum.
- Silver, E. A., & Kenney, P. A. (1995). Sources of assessment information for instructional guidance in mathematics. In T. Romberg (Ed.), *Reform in school mathematics and authentic assessment* (pp. 38–86). Albany: State University of New York Press.
- Silver, E. A., Shapiro, L. J., & Deutsch, A. (1993). Sense making and the solution of division problems involving remainders: An examination of middle school students' solution processes and their interpretations of solutions. *Journal of Research in Mathematics Education*, 24, 117–135.
- Silverman, K., Preston, K. L., Stitzer, M. L., & Schuster, C. R. (1999). Efficacy and versatility of voucher-based reinforcement in drug abuse treatment. In S. T. Higgins & K. Silverman (Eds.), *Motivating behavior change among illicit-drug abusers: Research on contingency management interventions* (pp. 163–181). Washington, DC: American Psychological Association.
- Silverman, W. K., & Kearney, C. A. (1991). The nature and treatment of childhood anxiety. *Educational Psychology Review*, 3, 335–361.
- Silvia, P. J. (2008). Interest—The curious emotion. *Current Directions in Psychological Science*, 17, 57–60.
- Simcock, G., & Hayne, H. (2002). Breaking the barrier? Children fail to translate their preverbal memories into language. *Psychological Science*, 13, 225–231.
- Simon, H. A. (1973). The structure of ill-structured problems. *Artificial Intelligence*, 4, 181–201.
- Simon, H. A. (1974). How big is a chunk? *Science*, 183, 482–488.
- Simon, H. A. (1980). Problem solving and education. In D. T. Tuma & F. Reif (Eds.), *Problem-solving and education: Issues in teaching and research* (pp. 81–96). Hillsdale, NJ: Erlbaum.
- Simon, S. J., Ayllon, T., & Milan, M. A. (1982). Behavioral compensation: Contrastlike effects in the classroom. *Behavior Modification*, 6, 407–420.
- Simons, J., Vansteenkiste, M., Lens, W., & Lacante, M. (2004). Placing motivation and future time perspective theory in a temporal perspective. *Educational Psychology Review*, 16, 121–139.
- Sinatra, G. M., & Mason, L. (2008). Beyond knowledge: Learner characteristics influencing conceptual change. In S. Vosniadou (Ed.), *International handbook on conceptual change* (pp. 560–582). New York: Routledge.
- Sinatra, G. M., & Pintrich, P. R. (Eds.) (2003a). *Intentional conceptual change*. Mahwah, NJ: Erlbaum.
- Sinatra, G. M., & Pintrich, P. R. (2003b). The role of intentions in conceptual change learning. In G. M. Sinatra & P. R. Pintrich (Eds.), *Intentional conceptual change* (pp. 1–18). Mahwah, NJ: Erlbaum.
- Sinatra, G. M., Southerland, S. A., McConaughy, E., & Demastes, J. (2003). Intentions and beliefs



- in students' understanding and acceptance of biological evolution. *Journal of Research on Science Teaching*, 40, 510–528.
- Singley, M. K., & Anderson, J. R. (1989). *The transfer of cognitive skill*. Cambridge, MA: Harvard University Press.
- Sins, P. H. M., van Joolingen, W. R., Savelsbergh, E. R., & van Hout-Wolters, B. (2008). Motivation and performance within a collaborative computer-based modeling task: Relations between students' achievement goal orientation, self-efficacy, cognitive processing, and achievement. *Contemporary Educational Psychology*, 33, 58–77.
- Siskin, L. S. (2003). When an irresistible force meets an immovable object: Core lessons about high schools and accountability. In M. Carnoy, R. Elmore, & L. S. Siskin (Eds.), *The new accountability: High schools and high-stakes testing* (pp. 175–194). New York: Routledge Falmer.
- Sizer, T. R. (2004). *Horace's compromise: The dilemma of the American high school*. Boston: Houghton Mifflin.
- Skaalvik, E. M. (1997). Self-enhancing and self-defeating ego orientation: Relations with task avoidance orientation, achievement, self-perceptions, and anxiety. *Journal of Educational Psychology*, 89, 71–81.
- Skaalvik, E. M., & Skaalvik, S. (2008). Teacher self-efficacy: Conceptual analysis and relations with teacher burnout and perceived school context. In H. W. Marsh, R. G. Craven, & D. M. McInerney (Eds.), *Self-processes, learning, and enabling human potential* (pp. 223–247). Charlotte, NC: Information Age.
- Skaalvik, E. M., & Valas, H. (2001, April). *Student help seeking: Relations with academic self-concept and goal-orientation*. Paper presented at the annual meeting of the American Educational Research Association, Seattle, WA.
- Skiba, R., & Raison, J. (1990). Relationship between the use of timeout and academic achievement. *Exceptional Children*, 57, 36–46.
- Skinner, B. F. (1938). *The behavior of organisms: An experimental analysis*. Englewood Cliffs, NJ: Prentice Hall.
- Skinner, B. F. (1948). Superstition in the pigeon. *Journal of Experimental Psychology*, 38, 168–172.
- Skinner, B. F. (1953). *Science and human behavior*. New York: Macmillan.
- Skinner, B. F. (1954). The science of learning and the art of teaching. *Harvard Educational Review*, 24, 86–97.
- Skinner, B. F. (1958). Reinforcement today. *American Psychologist*, 13, 94–99.
- Skinner, B. F. (1966a). An operant analysis of problem solving. In B. Kleinmuntz (Ed.), *Problem solving: Research, method and theory* (pp. 225–257). New York: Wiley.
- Skinner, B. F. (1966b). What is the experimental analysis of behavior? *Journal of the Experimental Analysis of Behavior*, 9, 213–218.
- Skinner, B. F. (1968). *The technology of teaching*. New York: Appleton-Century-Crofts.
- Skinner, B. F. (1971). *Beyond freedom and dignity*. New York: Alfred Knopf.
- Skinner, B. F. (1973). The free and happy student. *Phi Delta Kappan*, 55, 13–16.
- Skinner, B. F. (1989). The origins of cognitive thought. *American Psychologist*, 44, 13–18.
- Skinner, B. F., & Epstein, R. (1982). *Skinner for the classroom*. Champaign, IL: Research Press.
- Skinner, E., Furrer, C., Marchand, G., & Kindermann, T. (2008). Engagement and disaffection in the classroom: Part of a larger motivational dynamic? *Journal of Educational Psychology*, 100, 765–781.
- Skinner, E. A. (1995). *Perceived control, motivation, and coping*. Thousand Oaks, CA: Sage.
- Slater, A., Mattock, A., & Brown, E. (1990). Size constancy at birth: Newborn infants' responses to retinal and real size. *Journal of Experimental Child Psychology*, 49, 314–322.
- Slater, W. H. (2004). Teaching English from a literacy perspective: The goal of high literacy for all students. In T. L. Jetton & J. A. Dole (Eds.), *Adolescent literacy research and practice* (pp. 40–58). New York: Guilford Press.
- Slavin, R. E. (1983a). *Cooperative learning*. New York: Longman.
- Slavin, R. E. (1983b). When does cooperative learning increase student achievement? *Psychological Bulletin*, 94, 429–445.
- Slavin, R. E. (1990a). *Cooperative learning: Theory, research, and practice*. Upper Saddle River, NJ: Prentice Hall.
- Slavin, R. E. (1990b). Mastery learning re-considered. *Review of Educational Research*, 60, 300–302.
- Slavin, R. E., Hurley, E. A., & Chamberlain, A. (2003). Cooperative learning and achievement: Theory and research. In W. Reynolds & G. Miller (Eds.), *Handbook of psychology: Vol. 7. Educational psychology* (pp. 177–198). New York: Wiley.
- Sligte, I. G., Scholte, H. S., & Lamme, V. A. F. (2009). V4 activity predicts the strength of visual short-term memory representations. *Journal of Neuroscience*, 29, 7432–7438.
- Slotta, J. D., & Chi, M. T. H. (2006). Helping students understand challenging topics in science through ontology training. *Cognition and Instruction*, 24, 261–289.
- Sloutsky, V. M., Lo, Y.-F., & Fisher, A. V. (2001). How much does a shared name make things similar? Linguistic labels, similarity, and the development of inductive inference. *Child Development*, 72, 1695–1709.
- Slusher, M. P., & Anderson, C. A. (1996). Using causal persuasive arguments to change beliefs and teach new information: The mediating role of explanation availability and evaluation bias in the acceptance of knowledge. *Journal of Educational Psychology*, 88, 110–122.
- Smiley, P. A., Coulson, S. L., Greene, J. K., & Bono, K. L. (2010). Performance concern, contingent self-worth, and responses to repeated achievement failure in second graders. *Social Development*, 19, 779–798.
- Smith, B. L., & MacGregor, J. T. (1992). What is collaborative learning? In A. Goodsell, M. Maher, & V. Tinto (Eds.), *Collaborative learning: A sourcebook for higher education* (pp. 9–22). University Park: National Center on Postsecondary Teaching, Learning, and Assessment, The Pennsylvania State University.
- Smith, C. A., & Kirby, L. D. (2001). Affect and cognitive appraisal processes. In J. P. Forgas (Ed.), *Handbook of affect and social cognition* (pp. 75–92). Mahwah, NJ: Erlbaum.
- Smith, C. L. (2007). Bootstrapping processes in the development of students' commonsense matter theories: Using analogical mappings, thought experiments, and learning to measure to promote conceptual restructuring. *Cognition and Instruction*, 25, 337–398.
- Smith, C. L., Maclin, D., Grosslight, L., & Davis, H. (1997). Teaching for understanding: A study of students' preinstruction theories of matter and a comparison of the effectiveness of two approaches to teaching about matter and density. *Cognition and Instruction*, 15, 317–393.
- Smith, E. E. (2000). Neural bases of human working memory. *Current Directions in Psychological Science*, 9, 45–49.
- Smith, E. E., Shoben, E. J., & Rips, L. J. (1974). Structure and process in semantic memory: A feature model of semantic decisions. *Psychological Review*, 81, 214–241.
- Smith, E. R., & Conroy, F. R. (2009). The social context of cognition. In P. Robbins & M. Aydede (Eds.), *The Cambridge handbook of situated cognition* (pp. 454–466). Cambridge, England: Cambridge University Press.
- Smith, P. K., & Dutton, S. (1979). Play and training on direct and innovative problem-solving. *Child Development*, 50, 830–836.
- Smith, R. E., & Smoll, F. L. (1997). Coaching the coaches: Youth sports as a scientific and applied behavioral setting. *Current Directions in Psychological Science*, 6 (1), 16–21.
- Smith, S. M., & Moynan, S. C. (2008). Forgetting and recovering the unforgettable. *Psychological Science*, 19, 462–468.
- Smith, S. M., Glenberg, A., & Bjork, R. A. (1978). Environmental context and human memory. *Memory and Cognition*, 6, 342–353.
- Sneider, C., & Pulos, S. (1983). Children's cosmographies: Understanding the earth's shape and gravity. *Science Education*, 67, 205–221.
- Snow, R. E. (1989). Aptitude-treatment interaction as a framework for research on individual differences in learning. In P. L. Ackerman, R. J. Sternberg, & R. Glaser (Eds.), *Learning and individual differences: Advances in theory and research* (pp. 13–59). New York: Freeman.
- Snow, R. E., Corno, L., & Jackson, D., III (1996). Individual differences in affective and conative functions. In D. C. Berliner & R. C. Calfee (Eds.), *Handbook of educational psychology* (pp. 243–310). New York: Macmillan.
- Snowdon, D. (2001). *Aging with grace: What the nun study teaches us about leading longer, healthier, and more meaningful lives*. New York: Bantam Books.
- Snowman, J. (1986). Learning tactics and strategies. In G. D. Pyle & T. Andre (Eds.), *Cognitive classroom learning: Understanding, thinking, and problem solving* (pp. 243–275). Orlando, FL: Academic Press.

- Snyder, C. R., Shorey, H. S., Cheavens, J., Pulvers, K. M., Adams, V. H., III, & Wiklund, C. (2002). Hope and academic success in college. *Journal of Educational Psychology, 94*, 820–826.
- Snyder, K. A. (2007). Neural mechanisms of attention and memory in preferential looking tasks. In L. M. Oakes & P. J. Bauer (Eds.), *Short- and long-term memory in infancy and early childhood: Taking the first steps toward remembering* (pp. 179–208). New York: Oxford University Press.
- Snyder, M., & Swann, W. B. (1978). Behavioral confirmation in social interaction: From social perception to social reality. *Journal of Experimental Social Psychology, 14*, 148–162.
- Sokal, R. R. (1974). Classification: Purposes, principles, progress, prospects. *Science, 185* (4157), 1115–1123.
- Solnick, J. V., Rincover, A., & Peterson, C. R. (1977). Some determinants of the reinforcing and punishing effects of timeout. *Journal of Applied Behavior Analysis, 10*, 415–424.
- Solomon, P., Kubzansky, P. E., Leiderman, P. H., Mendelson, J. H., Trumbull, R., & Wexler, D. (1961). *Sensory deprivation: A symposium held at Harvard Medical School*. Cambridge, MA: Harvard University Press.
- SooHoo, S., Takemoto, K. Y., & McCullagh, P. (2004). A comparison of modeling and imagery on the performance of a motor skill. *Journal of Sport Behavior, 27*, 349–366.
- Southerland, S. A., & Sinatra, G. M. (2003). Learning about biological evolution: A special case of intentional conceptual change. In G. M. Sinatra & P. R. Pintrich (Eds.), *Intentional conceptual change* (pp. 317–345). Mahwah, NJ: Erlbaum.
- Sowell, E. R., & Jernigan, T. L. (1998). Further MRI evidence of late brain maturation: Limbic volume increases and changing asymmetries during childhood and adolescence. *Developmental Neuropsychology, 14*, 599–617.
- Sowell, E. R., Thompson, P. M., Holmes, C. J., Jernigan, T. L., & Toga, A. W. (1999). *In vivo* evidence for post-adolescent brain maturation in frontal and striatal regions. *Nature Neuroscience, 2*, 859–861.
- Spaulding, C. L. (1992). *Motivation in the classroom*. New York: McGraw-Hill.
- Speer, N. K., Reynolds, J. R., Swallow, K. M., & Zacks, J. M. (2009). Reading stories activates neural representations of visual and motor experiences. *Psychological Science, 20*, 989–999.
- Spelke, E. S. (1994). Initial knowledge: Six suggestions. *Cognition, 50*, 431–445.
- Spelke, E. S. (2000). Core knowledge. *American Psychologist, 55*, 1233–1243.
- Spelke, E. S., Breinlinger, K., Macomber, J., & Jacobson, K. (1992). Origins of knowledge. *Psychological Review, 99*, 605–632.
- Spelke, E. S., Hirst, W., & Neisser, U. (1976). The skills of divided attention. *Cognition, 4*, 215–230.
- Spence, I., Wong, P., Rusan, M., & Rastegar, N. (2006). How color enhances visual memory for natural scenes. *Psychological Science, 17*, 1–6.
- Spence, K. W. (1956). *Behavior theory and conditioning*. New Haven, CT: Yale University Press.
- Sperling, G. (1960). The information available in brief visual presentations. *Psychological Monographs, 74* (Whole No. 498).
- Sperling, G. (1967). Successive approximations to a model for short-term memory. *Acta Psychologica, 27*, 285–292.
- Spielberger, C. D. (1966). The effects of anxiety on complex learning in academic achievement. In C. D. Spielberger (Ed.), *Anxiety and behavior* (pp. 361–398). New York: Academic Press.
- Spielberger, C. D., & DeNike, L. D. (1966). Descriptive behaviorism versus cognitive theory in verbal operant conditioning. *Psychological Review, 73*, 306–326.
- Spilich, G. J., Vesonder, G. T., Chiesi, H. L., & Voss, J. F. (1979). Text processing of domain-related information for individuals with high and low domain knowledge. *Journal of Verbal Learning and Verbal Behavior, 18*, 275–290.
- Spires, H. A., & Donley, J. (1998). Prior knowledge activation: Inducing engagement with informational texts. *Journal of Educational Psychology, 90*, 249–260.
- Spires, H. A., Donley, J., & Penrose, A. M. (1990, April). *Prior knowledge activation: Inducing text engagement in reading to learn*. Paper presented at the annual meeting of the American Educational Research Association, Boston.
- Spivey, N. N. (1997). *The constructivist metaphor: Reading, writing, and the making of meaning*. San Diego, CA: Academic Press.
- Spörer, N., & Brunstein, J. C. (2009). Fostering the reading comprehension of secondary school students through peer-assisted learning: Effects on strategy knowledge, strategy use, and task performance. *Contemporary Educational Psychology, 34*, 289–297.
- Sporer, S. (1991). Deep-deeper-deepest? Encoding strategies and the recognition of human faces. *Journal of Experimental Psychology: Learning, Memory, and Cognition, 17*, 323–333.
- Spunt, R. P., Falk, E. B., & Lieberman, M. D. (2010). Dissociable neural systems support retrieval of how and why action knowledge. *Psychological Science, 21*, 1593–1598.
- Squire, L. R. (1987). *Memory and brain*. Oxford, England: Oxford University Press.
- Squire, L. R., & Alvarez, P. (1998). Retrograde amnesia and memory consolidation: A neurobiological perspective. In L. R. Squire & S. M. Kosslyn (Eds.), *Findings and current opinion in cognitive neuroscience* (pp. 75–84). Cambridge, MA: MIT Press.
- Sran, S. K., & Borrero, J. C. (2010). Assessing the value of choice in a token system. *Journal of Applied Behavior Analysis, 43*, 553–557.
- Stacey, K. (1992). Mathematical problem solving in groups: Are two heads better than one? *Journal of Mathematical Behavior, 11*, 261–275.
- Staddon, J. E. R., & Higa, J. J. (1991). Temporal learning. In G. H. Bower (Ed.), *The psychology of learning and motivation: Advances in research and theory* (Vol. 27, pp. 265–294). San Diego, CA: Academic Press.
- Stahl, G., Koschmann, T., & Suthers, D. D. (2006). Computer-supported collaborative learning. In R. K. Sawyer (Ed.), *The Cambridge handbook of the learning sciences* (pp. 409–425). Cambridge, England: Cambridge University Press.
- Stahl, S. A., & Shanahan, C. (2004). Learning to think like a historian: Disciplinary knowledge through critical analysis of multiple documents. In T. L. Jetton & J. A. Dole (Eds.), *Adolescent literacy research and practice* (pp. 94–115). New York: Guilford Press.
- Standage, M., Duda, J. L., & Ntoumanis, N. (2003). A model of contextual motivation in physical education: Using constructs from self-determination and achievement goal theories to predict physical activity intentions. *Journal of Educational Psychology, 95*, 97–110.
- Stanovich, K. E. (1999). *Who is rational? Studies of individual differences in reasoning*. Mahwah, NJ: Erlbaum.
- Starr, E. J., & Lovett, S. B. (2000). The ability to distinguish between comprehension and memory: Failing to succeed. *Journal of Educational Psychology, 92*, 761–771.
- Stazyk, E. H., Ashcraft, M. H., & Hamann, M. S. (1982). A network approach to mental multiplication. *Journal of Experimental Psychology: Learning, Memory, and Cognition, 8*, 320–335.
- Steele, C. (1997). A threat in the air: How stereotypes shape intellectual identity and performance. *American Psychologist, 52*, 613–629.
- Stefanou, C. R., Perencevich, K. C., DiCintio, M., & Turner, J. C. (2004). Supporting autonomy in the classroom: Ways teachers encourage student decision making and ownership. *Educational Psychology, 39*, 97–110.
- Steffensen, M. S., Joag-Dev, C., & Anderson, R. C. (1979). A cross-cultural perspective on reading comprehension. *Reading Research Quarterly, 15*, 10–29.
- Stein, B. S. (1978). Depth of processing reexamined: The effects of the precision of encoding and test appropriateness. *Journal of Verbal Learning and Verbal Behavior, 17*, 165–174.
- Stein, B. S. (1989). Memory and creativity. In J. A. Glover, R. R. Ronning, & C. R. Reynolds (Eds.), *Handbook of creativity* (pp. 163–176). New York: Plenum Press.
- Stein, B. S., & Bransford, J. D. (1979). Constraints on effective elaboration: Effects of precision and subject generation. *Journal of Verbal Learning and Verbal Behavior, 18*, 769–777.
- Stein, B. S., Bransford, J. D., Franks, J. J., Owings, R. A., Vye, N. J., & McGraw, W. (1982). Differences in the precision of self-generated elaborations. *Journal of Experimental Psychology: General, 111*, 399–405.
- Steinberg, L. (2009). Should the science of adolescent brain development inform public policy? *American Psychologist, 64*, 739–750.
- Steinberg, L., Graham, S., O'Brien, L., Woolard, J., Cauffman, E., & Banich, M. (2009). Age differences in future orientation and delay discounting. *Child Development, 80*, 28–44.
- Stensvold, M. S., & Wilson, J. T. (1990). The interaction of verbal ability with concept mapping in learning from a chemistry laboratory activity. *Science Education, 74*, 473–480.

- Stepans, J. (1991). Developmental patterns in students' understanding of physics concepts. In S. M. Glynn, R. H. Yeany, & B. K. Britton (Eds.), *The psychology of learning science* (pp. 89–115). Hillsdale, NJ: Erlbaum.
- Stephan, W. G., & Stephan, C. W. (2000). An integrated threat theory of prejudice. In S. Oskamp (Ed.), *Reducing prejudice and discrimination* (pp. 23–45). Mahwah, NJ: Erlbaum.
- Stephens, C. E., Pear, J. J., Wray, L. D., & Jackson, G. C. (1975). Some effects of reinforcement schedules in teaching picture names to retarded children. *Journal of Applied Behavior Analysis*, 8, 435–447.
- Stepich, D. A., & Newby, T. J. (1988). Analogical instruction within the information processing paradigm: Effective means to facilitate learning. *Instructional Science*, 17, 129–144.
- Sternberg, R. J. (2003). *Wisdom, intelligence, and creativity synthesized*. Cambridge, England: Cambridge University Press.
- Sternberg, R. J. (2005). Intelligence, competence, and expertise. In A. J. Elliot & C. S. Dweck (Eds.), *Handbook of competence and motivation* (pp. 15–30). New York: Guilford Press.
- Sternberg, R. J., Forsythe, G. B., Hedlund, J., Horvath, J. A., Wagner, R. K., Williams, W. M., Snook, S. A., & Grigorenko, E. L. (2000). *Practical intelligence in everyday life*. Cambridge, England: Cambridge University Press.
- Sternberg, R. J., & Frensch, P. A. (1993). Mechanisms of transfer. In D. K. Detterman & R. J. Sternberg (Eds.), *Transfer on trial: Intelligence, cognition, and instruction* (pp. 25–38). Norwood, NJ: Ablex.
- Sternberg, S. (1966). High-speed scanning in human memory. *Science*, 153, 652–654.
- Stevens, R. J., & Slavin, R. E. (1995). The cooperative elementary school: Effects of students' achievement, attitudes, and social relations. *American Educational Research Journal*, 32, 321–351.
- Stevenson, H. C., & Fantuzzo, J. W. (1986). The generality and social validity of a competency-based self-control training intervention for underachieving students. *Journal of Applied Behavior Analysis* 19, 269–276.
- Stevenson, H. W., Chen, C., & Uttal, D. H. (1990). Beliefs and achievement: A study of black, white, and Hispanic children. *Child Development*, 61, 508–523.
- Stiggins, R. (2008). *An introduction to student-involved assessment for learning* (5th ed.). Upper Saddle River, NJ: Merrill/Pearson.
- Stiles, J., & Thal, D. (1993). Linguistic and spatial cognitive development following early focal brain injury: Patterns of deficit and recovery. In M. Johnson (Ed.), *Brain development and cognition* (pp. 643–664). Oxford, England: Blackwell.
- Stipek, D. J. (1993). *Motivation to learn: From theory to practice* (2nd ed.). Boston: Allyn & Bacon.
- Stipek, D. J. (1996). Motivation and instruction. In D. C. Berliner & R. C. Calfee (Eds.), *Handbook of educational psychology* (pp. 85–113). New York: Macmillan.
- Stipek, D. J., & Gralinski, J. H. (1991). Gender differences in children's achievement-related beliefs and emotional responses to success and failure in mathematics. *Journal of Educational Psychology*, 83, 361–371.
- Stipek, D. J., & Gralinski, J. H. (1996). Children's beliefs about intelligence and school performance. *Journal of Educational Psychology*, 88, 397–407.
- Stodolsky, S. S., Salk, S., & Glaessner, B. (1991). Student views about learning math and social studies. *American Educational Research Journal*, 28, 89–116.
- Stokes, J. V., Luiselli, J. K., & Reed, D. D. (2010). A behavioral intervention for teaching tacking skills to high school football athletes. *Journal of Applied Behavior Analysis*, 43, 509–512.
- Stokes, J. V., Luiselli, J. K., Reed, D. D., & Fleming, R. K. (2010). Behavioral coaching to improve offensive line pass-blocking skills of high school football athletes. *Journal of Applied Behavior Analysis*, 43, 463–472.
- Stokes, S. A., Pierroutsakos, S. L., & Einstein, G. (2007, March). *Remembering to remember: Strategic and spontaneous processes in children's prospective memory*. Paper presented at the biennial meeting of the Society for Research in Child Development, Boston.
- Stokes, T. F., & Baer, D. M. (1977). An implicit technology of generalization. *Journal of Applied Behavior Analysis* 10, 349–367.
- Stone, J. R., III, Alfeld, C., & Pearson, D. (2008). Rigor and relevance: Enhancing high school students' math skills through career and technical education. *American Educational Research Journal*, 45, 767–795.
- Stone, N. J. (2000). Exploring the relationship between calibration and self-regulated learning. *Educational Psychology Review*, 12, 437–475.
- Storm, B. C., & Angello, G. (2010). Overcoming fixation: Creative problem solving and retrieval-induced forgetting. *Psychological Science*, 21, 1263–1265.
- Straus, M. A. (2000a). The benefits of never spanking: New and more definitive evidence. In M. A. Straus, *Beating the devil out of them: Corporal punishment by American families and its effects on children* (pp. 193–214). New Brunswick, NJ: Transaction.
- Straus, M. A. (2000b). Corporal punishment by parents: The cradle of violence in the family and society. *The Virginia Journal of Social Policy & the Law*, 8 (1), 7–60.
- Strayer, D. L., & Drews, F. A. (2007). Cell-phone-induced driver distraction. *Current Directions in Psychological Science*, 16, 128–131.
- Strayer, D. L., & Johnston, W. A. (2001). Driven to distraction: Dual-task studies of simulated driving and conversing on a cellular telephone. *Psychological Science*, 12, 462–466.
- Strick, M., Dijksterhuis, A., & van Baaren, R. B. (2010). Unconscious-thought effects take place off-line, not on-line. *Psychological Science*, 21, 484–488.
- Stright, A. D., Neitzel, C., Sears, K. G., & Hoke-Sinex, L. (2001). Instruction begins in the home: Relations between parental instruction and children's self-regulation in the classroom. *Journal of Educational Psychology*, 93, 456–466.
- Strike, K. A., & Posner, G. J. (1992). A revisionist theory of conceptual change. In R. A. Duschl & R. J. Hamilton (Eds.), *Philosophy of science, cognitive psychology, and educational theory and practice* (pp. 147–176). Albany: State University of New York Press.
- Strozer, J. R. (1994). *Language acquisition after puberty*. Washington, DC: Georgetown University Press.
- Stull, A. T., & Mayer, R. E. (2007). Learning by doing versus learning by viewing: Three experimental comparisons of learner-generated versus author-provided graphic organizers. *Journal of Educational Psychology*, 99, 808–820.
- Stupnisky, R. H., Perry, R. P., Hall, N. C., & van Winkel, L. M. (2006, April). *A test of Weiner's precursors to causal search in a college classroom setting*. Paper presented at the annual meeting of the American Educational Research Association, San Francisco.
- Suárez, L. D., Smal, L., & Delorenzi, A. (2010). Updating contextual information during consolidation as result of a new memory trace. *Neurobiology of Learning and Memory*, 93, 561–571.
- Sue, S., & Chin, R. (1983). The mental health of Chinese-American children: Stressors and resources. In G. J. Powell (Ed.), *The psychosocial development of minority children* (pp. 385–397). New York: Brunner/Mazel.
- Suina, J. H., & Smolkin, L. B. (1994). From natal culture to school culture to dominant society culture: Supporting transitions for Pueblo Indian students. In P. M. Greenfield & R. R. Cocking (Eds.), *Cross-cultural roots of minority child development* (pp. 115–130). Hillsdale, NJ: Erlbaum.
- Sullivan, J. R., & Conoley, J. C. (2004). Academic and instructional interventions with aggressive students. In J. C. Conoley & A. P. Goldstein (Eds.), *School violence intervention* (2nd ed., pp. 235–255). New York: Guilford Press.
- Sullivan, J. S. (1989). Planning, implementing, and maintaining an effective in-school suspension program. *Clearing House*, 62, 409–410.
- Sullivan, R. C. (1994). Autism: Definitions past and present. *Journal of Vocational Rehabilitation*, 4, 4–9.
- Sun-Alperin, M. K., & Wang, M. (2008). Spanish-speaking children's spelling errors with English vowel sounds that are represented by different graphemes in English and Spanish words. *Contemporary Educational Psychology*, 33, 932–948.
- Surber, J. R. (2001). Effect of topic label repetition and importance on reading time and recall of text. *Journal of Educational Psychology*, 93, 279–287.
- Sussman, D. M. (1981). PSI: Variations on a theme. In S. W. Bijou & R. Ruiz (Eds.), *Behavior modification: Contributions to education* (pp. 63–96). Hillsdale, NJ: Erlbaum.
- Swan, K., Mitrani, M., Guerrero, F., Cheung, M., & Schoener, J. (1990, April). *Perceived locus of*

- control and computer-based instruction. Paper presented at the annual meeting of the American Educational Research Association, Boston.
- Swanson, H. L., Cooney, J. B., & O'Shaughnessy, T. E. (1998). Learning disabilities and memory. In B. Y. L. Wong (Ed.), *Learning about learning disabilities* (2nd ed., pp. 107–162). San Diego, CA: Academic Press.
- Swanson, H. L., Jerman, O., & Zheng, X. (2008). Growth in working memory and mathematical problem solving in children at risk and not at risk for serious math difficulties. *Journal of Educational Psychology, 100*, 333–379.
- Swanson, H. L., & Lussier, C. M. (2001). A selective synthesis of the experimental literature on dynamic assessment. *Review of Educational Research, 71*, 321–363.
- Swanson, H. L., O'Connor, J. E., & Cooney, J. B. (1990). An information processing analysis of expert and novice teachers' problem solving. *American Educational Research Journal, 27*, 533–556.
- Sweller, J. (1994). Cognitive load theory, learning difficulty, and instructional design. *Learning and Instruction, 4*, 295–312.
- Sweller, J. (2008). Human cognitive architecture. In J. M. Spector, M. D. Merrill, J. van Merriënboer, & M. P. Driscoll (Eds.), *Handbook of research on educational communications and technology* (3rd ed., pp. 369–381). New York: Erlbaum.
- Sweller, J., & Levine, M. (1982). Effects of goal specificity on means-end analysis and learning. *Journal of Experimental Psychology: Learning, Memory, and Cognition, 8*, 463–474.
- Swenson, L. C. (1980). *Theories of learning: Traditional perspectives/contemporary developments*. Belmont, CA: Wadsworth.
- Talarico, J. M., LaBar, K. S., & Rubin, D. C. (2004). Emotional intensity predicts autobiographical memory experience. *Memory & Cognition, 32*, 1118–1132.
- Talarico, J. M., & Rubin, D. C. (2003). Confidence, not consistency, characterizes flashbulb memories. *Psychological Science, 14*, 455–461.
- Talimi, D., Grady, C. L., Goshen-Gottstein, Y., & Moscovitch, M. (2005). Neuroimaging the serial position curve: A test of single-store versus dual-store models. *Psychological Science, 16*, 716–723.
- Tamburrini, J. (1982). Some educational implications of Piaget's theory. In S. Modgil and C. Modgil (Eds.), *Jean Piaget: Consensus and controversy* (pp. 309–325). New York: Praeger.
- Tamir, M. (2009). What do people want to feel and why? Pleasure and utility in emotion regulation. *Current Directions in Psychological Science, 18*, 101–105.
- Tang, J.-C., Kennedy, C. H., Koppekin, A., & Caruso, M. (2002). Functional analysis of stereotypical ear covering in a child with autism. *Journal of Applied Behavior Analysis, 35*, 95–98.
- Tarver, S. G. (1992). Direct Instruction. In W. Stainback & S. Stainback (Eds.), *Controversial issues confronting special education* (2nd ed., pp. 143–165). Boston: Allyn & Bacon.
- Tate, W. F. (1995). Returning to the root: A culturally relevant approach to mathematics pedagogy. *Theory into Practice, 34*, 166–173.
- Taub, J., & Pearrow, M. (2006). Resilience through violence prevention in schools. In S. Goldstein & R. B. Brooks (Eds.), *Handbook of resilience in children* (pp. 357–371). New York: Springer.
- Taylor, J. C., & Romanczyk, R. G. (1994). Generating hypotheses about the function of student problem behavior by observing teacher behavior. *Journal of Applied Behavior Analysis, 27*, 251–265.
- Taylor, M., Esbensen, B. M., & Bennett, R. T. (1994). Children's understanding of knowledge acquisition: The tendency for children to report they have always known what they have just learned. *Child Development, 65*, 1581–1604.
- Teasley, S. D., & Roschelle, J. (1993). Constructing a joint problem space: The computer as a tool for sharing information. In S. P. Lajoie & S. J. Derry (Eds.), *Computers as cognitive tools* (pp. 229–258). Hillsdale, NJ: Erlbaum.
- Tennyson, R. D., & Cocchiarella, M. J. (1986). An empirically based instructional design theory for teaching concepts. *Review of Educational Research, 56*, 40–71.
- Tennyson, R. D., Youngers, J., & Suebsonthi, P. (1983). Concept learning by children using instructional presentation forms for prototype formation and classification-skill development. *Journal of Educational Psychology, 75*, 280–291.
- Thapar, A., & Greene, R. (1993). Evidence against a short-term store account of long-term recency effects. *Memory and Cognition, 21*, 329–337.
- Tharp, R. G. (1989). Psychocultural variables and constants: Effects on teaching and learning in schools. *American Psychologist, 44*, 349–359.
- Théberge, C. L. (1994, April). *Small-group vs. whole-class discussion: Gaining the floor in science lessons*. Paper presented at the annual meeting of the American Educational Research Association, New Orleans, LA.
- Thelen, E., & Smith, L. B. (1998). Dynamic systems theories. In W. Damon (Ed.-in-chief) and R. M. Lerner (Vol. Ed.), *Handbook of child psychology: Vol. 1. Theoretical models of human development* (5th ed., pp. 563–634). New York: Wiley.
- Thiagarajan, S. (1989). Interactive lectures: Seven more strategies. *Performance and Instruction, 28* (2), 35–37.
- Thiede, K. W., Anderson, M. C. M., & Theriault, D. (2003). Accuracy of metacognitive monitoring affects learning of texts. *Journal of Educational Psychology, 95*, 66–73.
- Thiede, K. W., Griffin, T. D., Wiley, J., & Redford, J. S. (2009). Metacognitive monitoring during and after reading. In D. J. Hacker, J. Dunlosky, & A. C. Graesser (Eds.), *Handbook of metacognition in education* (pp. 85–106). New York: Routledge.
- Thomas, J. G., Milner, H. R., & Haberlandt, K. F. (2003). Forward and backward recall: Different response time patterns, same retrieval order. *Psychological Science, 14*, 169–174.
- Thomas, J. W. (1993a). Expectations and effort: Course demands, students' study practices, and academic achievement. In T. M. Tomlinson (Ed.), *Motivating students to learn: Overcoming barriers to high achievement* (pp. 139–176). Berkeley, CA: McCutchan.
- Thomas, J. W. (1993b). Promoting independent learning in the middle grades: The role of instructional support practice. *Elementary School Journal, 93*, 575–591.
- Thomas, J. W., Bol, L., Warkentin, R. W., Wilson, M., Strage, A., & Rohwer, W. D., Jr. (1993). Interrelationships among students' study abilities, self-concept of academic ability, and achievement as a function of characteristics of high-school biology courses. *Applied Cognitive Psychology, 7*, 499–532.
- Thomas, M. S. C., & Johnson, M. H. (2008). New advances in understanding sensitive periods in brain development. *Current Directions in Psychological Science, 17*, 1–5.
- Thomas, R. M. (2005). *High-stakes testing: Coping with collateral damage*. Mahwah, NJ: Erlbaum.
- Thompson, A. G., & Thompson, P. W. (1989). Affect and problem solving in an elementary school mathematics classroom. In D. B. McLeod & V. M. Adams (Eds.), *Affect and mathematical problem solving: A new perspective* (pp. 162–176). New York: Springer-Verlag.
- Thompson, R., Emmorey, K., & Gollan, T. H. (2005). "Tip of the fingers" experience by deaf signers: Insights into the organization of a sign-based lexicon. *Psychological Science, 16*, 856–860.
- Thompson, R. A., & Nelson, C. A. (2001). Developmental science and the media: Early brain development. *American Psychologist, 56*, 5–15.
- Thompson, W. L., & Kosslyn, S. M. (2000). Neural systems activated during visual mental imagery: A review and meta-analysis. In A. W. Toga & J. C. Mazziotta (Eds.), *Brain mapping: The systems* (pp. 535–560). San Diego, CA: Academic Press.
- Thomson, D. M. (1988). Context and false recognition. In G. M. Davies & D. M. Thomson (Eds.), *Memory in context: Context in memory* (pp. 285–304). Chichester, England: Wiley.
- Thorndike, E. L. (1898). Animal intelligence: An experimental study of the associative processes in animals. *Psychological Review Monograph Supplement, 2* (8).
- Thorndike, E. L. (1911). *Animal intelligence*. New York: Macmillan.
- Thorndike, E. L. (1913). *Educational psychology: The psychology of learning* (Vol. 2). New York: Teachers College Press.
- Thorndike, E. L. (1924). Mental discipline in high school studies. *Journal of Educational Psychology, 15*, 1–22, 83–98.
- Thorndike, E. L. (1932a). *The fundamentals of learning*. New York: Teachers College Press.
- Thorndike, E. L. (1932b). Reward and punishment in animal learning. *Comparative Psychology Monograph, 8* (39).

- Thorndike, E. L. (1935). *The psychology of wants, interests, and attitudes*. New York: Appleton-Century-Crofts.
- Thorndike, E. L., & Woodworth, R. S. (1901). The influence of improvement in one mental function upon the efficiency of other functions. *Psychological Review*, 8, 247–261, 384–395, 553–564.
- Thorndike-Christ, T. (2008, March). *Profiles in failure: The etiology of maladaptive beliefs about mathematics*. Paper presented at the annual meeting of the American Educational Research Association, New York.
- Thyne, J. M. (1963). *The psychology of learning and techniques of teaching*. London: University of London Press.
- Tiger, J. H., Hanley, G. P., & Hernandez, E. (2006). An evaluation of the value of choice with preschool children. *Journal of Applied Behavior Analysis*, 39, 1–16.
- Timberlake, W., & Lucas, G. A. (1989). Behavior systems and learning: From misbehavior to general principles. In S. B. Klein & R. R. Mowrer (Eds.), *Contemporary learning theories: Instrumental conditioning theory and the impact of biological constraints on learning* (pp. 237–275). Mahwah, NJ: Erlbaum.
- Tirosh, D., & Graeber, A. O. (1990). Evoking cognitive conflict to explore preservice teachers' thinking about division. *Journal for Research in Mathematics Education*, 21, 98–108.
- Tobias, S. (1980). Anxiety and instruction. In I. G. Sarason (Ed.), *Test anxiety: Theory, research, and applications* (pp. 289–309). Hillsdale, NJ: Erlbaum.
- Tobias, S., & Everson, H. T. (2009). The importance of knowing what you know: A knowledge monitoring framework for studying metacognition in education. In D. J. Hacker, J. Dunlosky, & A. C. Graesser (Eds.), *Handbook of metacognition in education* (pp. 107–127). New York: Routledge.
- Tobin, K. (1987). The role of wait time in higher cognitive level learning. *Review of Educational Research*, 57, 69–95.
- Tobin, K., & Tippins, D. (1993). Constructivism as a reference for teaching and learning. In K. Tobin (Ed.), *The practice of constructivism in science education* (pp. 39–50). Washington, DC: American Association for the Advancement of Science.
- Tollefson, N. (2000). Classroom applications of cognitive theories of motivation. *Educational Psychology Review*, 12, 63–83.
- Tolman, E. C. (1932). *Purposive behavior in animals and men*. New York: Century.
- Tolman, E. C. (1938). The determiners of behavior at a choice point. *Psychological Review*, 45, 1–41.
- Tolman, E. C. (1942). *Drives toward war*. New York: Appleton-Century.
- Tolman, E. C. (1959). Principles of purposive behavior. In S. Koch (Ed.), *Psychology: A study of a science* (Vol. 2, pp. 92–157). New York: McGraw-Hill.
- Tolman, E. C., & Honzik, C. H. (1930). Introduction and removal of reward, and maze performance in rats. *University of California Publications in Psychology*, 4, 257–275.
- Tolman, E. C., Ritchie, B. F., & Kalish, D. (1946). Studies in spatial learning: I. Orientation and the short-cut. *Journal of Experimental Psychology*, 36, 13–24.
- Tomasello, M., & Herrmann, E. (2010). Ape and human cognition: What's the difference? *Current Directions in Psychological Science*, 19, 3–8.
- Tomback, R. M., Williams, A. Y., & Wentzel, K. R. (2005, April). *Young adolescents' concerns about the transition to high school*. Poster presented at the annual meeting of the American Educational Research Association, Montreal.
- Tomlinson, C. A., & McTighe, J. (2006). *Integrating Differentiated Instruction and Understanding by Design*. Alexandria, VA: Association for Supervision and Curriculum Development.
- Tomporowski, P. D., Davis, C. L., Miller, P. H., & Naglieri, J. A. (2008). Exercise and children's intelligence, cognition, and academic achievement. *Educational Psychology Review*, 20, 111–131.
- Toplak, M. E., & Stanovich, K. E. (2002). The domain specificity and generality of disjunctive searching for a generalizable critical thinking skill. *Journal of Educational Psychology*, 94, 197–209.
- Torney-Purta, J. (1994). Dimensions of adolescents' reasoning about political and historical issues: Ontological switches, developmental processes, and situated learning. In M. Carretero & J. F. Voss (Eds.), *Cognitive and instructional processes in history and the social sciences* (pp. 103–122). Mahwah, NJ: Erlbaum.
- Tossman, I., Kaplan, A., & Assor, A. (2008). Academic achievement goal structures and young adolescents' biased preferences for peers as cooperation partners: A longitudinal study. *Revue Internationale de Psychologie Sociale*, 21 (1/2), 181–215.
- Tourniaire, E., & Pulos, S. (1985). Proportional reasoning: A review of the literature. *Educational Studies in Mathematics*, 16, 181–204.
- Trachtenberg, J. T., Chen, B. E., Knott, G. W., Feng, G., Sanes, J. R., Welker, E., et al. (2002). Long-term in vivo imaging of experience-dependent synaptic plasticity in adult cortex. *Nature*, 420, 788–794.
- Trautwein, U., Lüdtke, O., Kastens, C., & Köller, O. (2006). Effort on homework in grades 5–9: Development, motivational antecedents, and the association with effort on classwork. *Child Development*, 77, 1094–1111.
- Trautwein, U., Lüdtke, O., Schnyder, I., & Niggli, A. (2006). Predicting homework effort: Support for a domain-specific, multilevel homework model. *Journal of Educational Psychology*, 98, 438–456.
- Treisman, A. M. (1964). Verbal cues, language and meaning in selective attention. *American Journal of Psychology*, 77, 215–216.
- Trenholme, I. A., & Baron, A. (1975). Intermediate and delayed punishment of human behavior by loss of reinforcement. *Learning and Motivation*, 6, 62–79.
- Trevarthen, C. (1980). The foundations of intersubjectivity: Development of interpersonal and cooperative understandings in infants. In D. R. Olson (Ed.), *The social foundations of language and thought* (pp. 316–342). New York: W. W. Norton.
- Trevarthen, C., & Hubley, P. (1978). Secondary intersubjectivity: Confidence, confiding and acts of meaning in the first year. In A. Lock (Ed.), *Action, gesture, and symbol: The emergence of language* (pp. 183–229). London: Academic Press.
- Trosclair-Lasserre, N. M., Lerman, D. C., Call, N. A., Addison, L. R., & Kodak, T. (2008). Reinforcement magnitude: An evaluation of preference and reinforcer efficacy. *Journal of Applied Behavior Analysis*, 41, 203–220.
- Tryon, G. S. (1980). The measurement and treatment of test anxiety. *Review of Educational Research*, 50, 343–372.
- Tsai, J. L. (2007). Ideal affect: Cultural causes and behavioral consequences. *Perspectives on Psychological Science*, 2, 242–259.
- Tschannen-Moran, M., Woolfolk Hoy, A., & Hoy, W. K. (1998). Teacher efficacy: Its meaning and measure. *Review of Educational Research*, 68, 202–248.
- Tudor, R. M. (1995). Isolating the effects of active responding in computer-based instruction. *Journal of Applied Behavior Analysis*, 28, 343–344.
- Tulving, E. (1962). Subjective organization in free recall of "unrelated" words. *Psychological Review*, 69, 344–354.
- Tulving, E. (1968). Theoretical issues in free recall. In T. R. Dixon & D. L. Horton (Eds.), *Verbal behavior and general behavior theory* (pp. 2–36). Englewood Cliffs, NJ: Prentice Hall.
- Tulving, E. (1975). Euphoric processes in recall and recognition. In J. Brown (Ed.), *Recall and recognition* (pp. 37–73). London: Wiley.
- Tulving, E. (1983). *Elements of episodic memory*. Oxford, England: Oxford University Press.
- Tulving, E., & Thomson, D. M. (1971). Retrieval processes in recognition memory: Effects of associative context. *Journal of Experimental Psychology*, 87, 116–124.
- Tulving, E., & Thomson, D. M. (1973). Encoding specificity and retrieval processes in episodic memory. *Psychological Review*, 80, 352–373.
- Tunstall, P., & Gipps, C. (1996). Teacher feedback to young children in formative assessment: A typology. *British Educational Research Journal*, 22, 389–404.
- Turkkan, C. G. (2001). Creating curriculum with children. In B. Rogoff, C. G. Turkkanis, & L. Bartlett (Eds.), *Learning together: Children and adults in a school community* (pp. 91–102). New York: Oxford University Press.
- Turnbull, C. M. (1961). *The forest people*. New York: Simon & Schuster.
- Turner, J. C. (1995). The influence of classroom contexts on young children's motivation for literacy. *Reading Research Quarterly*, 30, 410–441.
- Turner, J. C., Meyer, D. K., Cox, K. E., Logan, C., DiCintio, M., & Thomas, C. T. (1998). Creating contexts for involvement in mathematics. *Journal of Educational Psychology*, 90, 730–745.
- Turner, J. C., & Patrick, H. (2008). How does motivation develop and why does it change?

- Reframing motivation research. *Educational Psychologist*, 43, 119–131.
- Turner, J. C., Warzon, K. B., & Christensen, A. (2011). Motivating mathematics learning: Changes in teachers' practices and beliefs during a nine-month collaboration. *American Educational Research Journal*, 48, 718–762.
- Turner, J. E., Husman, J., & Schallert, D. L. (2002). The importance of students' goals in their emotional experience of academic failure: Investigating the precursors and consequences of shame. *Educational Psychologist*, 37, 79–89.
- Turner, L. A., & Johnson, B. (2003). A model of mastery motivation for at-risk preschoolers. *Journal of Educational Psychology*, 95, 495–505.
- Turnure, J., Buium, N., & Thurlow, M. (1976). The effectiveness of interrogatives for promoting verbal elaboration productivity in young children. *Child Development*, 47, 851–855.
- Turvey, M. T., & Kravetz, S. (1970). Retrieval from iconic memory with shape as the selection criterion. *Perception and Psychophysics*, 8, 171–172.
- Tversky, B. (1981). Distortions in memory for maps. *Cognitive Psychology*, 13, 407–433.
- Tweed, R. G., & Lehman, D. R. (2002). Learning considered within a cultural context. *American Psychologist*, 57, 89–99.
- Tyler, K. M., Uqdaq, A. L., Dillihunt, M. L., Beatty-Hazelbaker, R., Connor, T., Gadson, N., et al. (2008). Cultural discontinuity: Toward a quantitative investigation of a major hypothesis in education. *Educational Researcher*, 37, 280–297.
- Tzuril, D. (2000). Dynamic assessment of young children: Educational and intervention perspectives. *Educational Psychology Review*, 12, 385–435.
- Underwood, B. J. (1948). "Spontaneous recovery" of verbal associations. *Journal of Experimental Psychology*, 38, 429–439.
- Underwood, B. J. (1954). Studies of distributed practice: XII. Retention following varying degrees of original learning. *Journal of Experimental Psychology*, 47, 294–300.
- Underwood, B. J. (1957). Interference and forgetting. *Psychological Review*, 64, 49–60.
- Underwood, B. J. (1961). Ten years of massed practice on distributed practice. *Psychological Review*, 68, 229–247.
- Underwood, B. J. (1983). *Attributes of memory*. Glenview, IL: Scott, Foresman.
- Underwood, B. J., & Erlebacher, A. H. (1965). Studies of coding in verbal behavior. *Psychological Monographs*, 79 (Whole No. 606).
- Underwood, B. J., Kapelak, S., & Malmi, R. (1976). The spacing effect: Additions to the theoretical and empirical puzzles. *Memory and Cognition*, 4, 391–400.
- Underwood, B. J., & Schulz, R. W. (1960). *Meaningfulness and verbal learning*. Philadelphia: J. B. Lippincott.
- Unsworth, N., Heitz, R. P., & Parks, N. A. (2008). The importance of temporal distinctiveness for forgetting over the short term. *Psychological Science*, 19, 1078–1081.
- Urbach, T. P., Windmann, S. S., Payne, D. G., & Kutas, M. (2005). Mismaking memories: Neural precursors of memory illusions in electrical brain activity. *Psychological Science*, 16, 19–24.
- Urduan, T. (2004). Predictors of academic self-handicapping and achievement: Examining achievement goals, classroom goal structures, and culture. *Journal of Educational Psychology*, 96, 251–264.
- Urduan, T. C., & Maehr, M. L. (1995). Beyond a two-goal theory of motivation and achievement: A case for social goals. *Review of Educational Research*, 65, 213–243.
- Urduan, T., & Mestas, M. (2006). The goals behind performance goals. *Journal of Educational Psychology*, 98, 354–365.
- Urduan, T. C., & Midgley, C. (2001). Academic self-handicapping: What we know, what more there is to learn. *Educational Psychology Review*, 13, 115–138.
- Urduan, T., Ryan, A. M., Anderman, E. M., & Gheen, M. H. (2002). Goals, goal structures, and avoidance behaviors. In C. Midgley (Ed.), *Goals, goal structures, and patterns of adaptive learning* (pp. 55–83). Mahwah, NJ: Erlbaum.
- Urduan, T., & Turner, J. C. (2005). Competence motivation in the classroom. In A. J. Elliot & C. S. Dweck (Eds.), *Handbook of competence and motivation* (pp. 297–317). New York: Guilford Press.
- Usher, E. L. (2009). Sources of middle school students' self-efficacy in mathematics: A qualitative investigation. *American Educational Research Journal*, 46, 275–314.
- Usher, E. L., & Pajares, F. (2008). Sources of self-efficacy in school: Critical review of the literature and future directions. *Review of Educational Research*, 78, 751–796.
- Valentine, J. C., DuBois, D. L., & Cooper, H. (2004). The relation between self-beliefs and academic achievement: A meta-analytic review. *Educational Psychologist*, 39, 111–133.
- Vallet, G., Brunel, L., & Versace, R. (2010). The perceptual nature of the cross-modal priming effect: Arguments in favor of a sensory-based conception of memory. *Experimental Psychology*, 57, 376–382.
- van den Broek, P., Bauer, P. J., & Bourg, T. (Eds.) (1997). *Developmental spans in event comprehension and representation: Bridging fictional and actual events*. Mahwah, NJ: Erlbaum.
- van Dijk, T. A., & Kintsch, W. (1983). *Strategies of discourse comprehension*. New York: Academic Press.
- Van Dooren, W., De Bock, D., Hessels, A., Janssens, D., & Verschaffel, L. (2005). Not everything is proportional: Effects of age and problem type on propensities for overgeneralization. *Cognition and Instruction*, 23, 57–86.
- van Drie, J., van Boxtel, C., & van der Linden, J. (2006). Historical reasoning in a computer-supported collaborative learning environment. In A. M. O'Donnell, C. E. Hmelo-Silver, & G. Erkens (Eds.), *Collaborative learning, reasoning, and technology* (pp. 265–296). Mahwah, NJ: Erlbaum.
- van Garderen, D. (2004). Reciprocal teaching as a comprehension strategy for understanding mathematical word problems. *Reading and Writing Quarterly*, 20, 225–229.
- Van Houten, R., Nau, P., MacKenzie-Keating, S., Sameoto, D., & Colavecchia, B. (1982). An analysis of some variables influencing the effectiveness of reprimands. *Journal of Applied Behavior Analysis* 15, 65–83.
- van Kraayenoord, C. E., & Paris, S. G. (1997). Children's self-appraisal of their work samples and academic progress. *Elementary School Journal*, 97, 523–537.
- van Laar, C. (2000). The paradox of low academic achievement but high self-esteem in African American students: An attributional account. *Educational Psychology Review*, 12, 33–61.
- Van Leijenhorst, L., Crone, E. A., & Van der Molen, M. W. (2007). Developmental trends for object and spatial working memory: A psychophysiological analysis. *Child Development*, 78, 987–1000.
- van Merriënboer, J. J. G., & Kester, L. (2008). Whole-task models in education. In J. M. Spector, M. D. Merrill, J. van Merriënboer, & M. P. Driscoll (Eds.), *Handbook of research on educational communications and technology* (3rd ed., pp. 441–456). New York: Erlbaum.
- van Merriënboer, J. J. G., & Sweller, J. (2005). Cognitive load theory and complex learning: Recent developments and future directions. *Educational Psychology Review*, 17, 147–177.
- Van Meter, P. (2001). Drawing construction as a strategy for learning from text. *Journal of Educational Psychology*, 93, 129–140.
- Van Meter, P., Yokoi, L., & Pressley, M. (1994). College students' theory of notetaking derived from their perceptions of notetaking. *Journal of Educational Psychology*, 86, 323–338.
- Van Patten, J. R., Chao, C. L., & Reigeluth, C. M. (1986). A review of strategies for sequencing and synthesizing information. *Review of Educational Research*, 56, 437–472.
- Van Rossum, E. J., & Schenk, S. M. (1984). The relationship between learning conception, study strategy and learning outcome. *British Journal of Educational Psychology*, 54, 73–83.
- van Veen, V., & Carter, C. S. (2006). Conflict and cognitive control in the brain. *Current Directions in Psychological Science*, 15, 237–240.
- VanSledright, B., & Brophy, J. (1992). Storytelling, imagination, and fanciful elaboration in children's historical reconstructions. *American Educational Research Journal*, 29, 837–859.
- vanSledright, B., & Limón, M. (2006). Learning and teaching social studies: A review of cognitive research in history and geography. In P. A. Alexander & P. H. Winne (Eds.), *Handbook of educational psychology* (2nd ed., pp. 545–570). Mahwah, NJ: Erlbaum.
- Vansteenkiste, M., Lens, W., & Deci, E. L. (2006). Intrinsic versus extrinsic goal contents in self-determination theory: Another look at the quality of academic motivation. *Educational Psychologist*, 41, 19–31.
- Vansteenkiste, M., Zhou, M., Lens, W., & Soenens, B. (2005). Experiences of autonomy

- and control among Chinese learners: Vitalizing or immobilizing? *Journal of Educational Psychology*, 97, 468–483.
- Vansteenkoven, D., Crombez, G., Baeyens, F., Hermans, D., & Eelen, P. (2000). Pre-extinction of sensory preconditioned electrodermal activity. *Quarterly Journal of Experimental Psychology B: Comparative and Physiological Psychology*, 53B, 359–371.
- Varma, S., McCandliss, B. D., & Schwartz, D. L. (2008). Scientific and pragmatic challenges for bridging education and neuroscience. *Educational Researcher*, 37 (3), 140–152.
- Vaughn, B. J., & Horner, R. H. (1997). Identifying instructional tasks that occasion problem behaviors and assessing the effects of student versus teacher choice among these tasks. *Journal of Applied Behavior Analysis* 30, 299–312.
- Vecera, S. P., Vogel, E. K., & Woodman, G. F. (2002). Lower region: A new cue for figure-ground assignment. *Journal of Experimental Psychology: General*, 131, 194–205.
- Veenman, S. (1984). Perceived problems of beginning teachers. *Review of Educational Research*, 54, 143–178.
- Vekiri, I. (2002). What is the value of graphical displays in learning? *Educational Psychology Review*, 14, 261–312.
- Verdi, M. P., & Kulhavy, R. W. (2002). Learning with maps and texts: An overview. *Educational Psychology Review*, 14, 27–46.
- Vergauwe, E., Barrouillet, P., & Camos, V. (2010). Do mental processes share a domain-general resource? *Psychological Science*, 21, 384–390.
- Verkhratsky, A., & Butt, A. (2007). *Glial neurobiology*. Chichester, England: Wiley.
- Vermeer, H. J., Boekaerts, M., & Seegers, G. (2000). Motivational and gender differences: Sixth-grade students' mathematical problem-solving behavior. *Journal of Educational Psychology*, 92, 308–315.
- Vernon, M. D. (1969). *Human motivation*. Cambridge, England: Cambridge University Press.
- Veroff, J., McClelland, L., & Ruhland, D. (1975). Varieties of achievement motivation. In M. T. S. Mednick, S. S. Tangri, & L. W. Hoffman (Eds.), *Women and achievement: Social and motivational analyses*. New York: Halsted.
- Viken, R. J., & McFall, R. M. (1994). Paradox lost: Implications of contemporary reinforcement theory for behavior therapy. *Current Directions in Psychological Science*, 3, 121–125.
- Vintere, P., Hemmes, N. S., Brown, B. L., & Poulson, C. L. (2004). Gross-motor skill acquisition by preschool dance students under self-instruction procedures. *Journal of Applied Behavior Analysis*, 37, 305–322.
- Vladescu, J. C., & Kodak, T. (2010). A review of recent studies on differential reinforcement during skill acquisition in early intervention. *Journal of Applied Behavior Analysis*, 43, 351–355.
- Volet, S. (1999). Learning across cultures: Appropriateness of knowledge transfer. *International Journal of Educational Research*, 31, 625–643.
- Volet, S., Vaura, M., & Salonen, P. (2009). Self- and social regulation in learning contexts: An integrative perspective. *Educational Psychologist*, 44, 215–226.
- Vollmer, T. R., & Hackenberg, T. D. (2001). Reinforcement contingencies and social reinforcement: Some reciprocal relations between basic and applied research. *Journal of Applied Behavior Analysis*, 34, 241–253.
- Vollmer, T. R., Roane, H. S., Ringdahl, J. E., & Marcus, B. A. (1999). Evaluating treatment challenges with differential reinforcement of alternative behavior. *Journal of Applied Behavior Analysis*, 32, 9–23.
- von Glasersfeld, E. (1995). A constructivist approach to teaching. In L. P. Steffe & J. Gale (Eds.), *Constructivism in education* (pp. 3–15). Mahwah, NJ: Erlbaum.
- Vosniadou, S. (1991). Conceptual development in astronomy. In S. M. Glynn, R. H. Yeany, & B. K. Britton (Eds.), *The psychology of learning science* (pp. 149–177). Hillsdale, NJ: Erlbaum.
- Vosniadou, S. (1994). Universal and culture-specific properties of children's mental models of the earth. In L. A. Hirschfeld & S. A. Gelman (Eds.), *Mapping the mind: Domain specificity in cognition and culture* (pp. 412–430). Cambridge, England: Cambridge University Press.
- Vosniadou, S. (2007). The cognitive-situative divide and the problem of conceptual change. *Educational Psychologist*, 42, 55–66.
- Vosniadou, S. (Ed.) (2008). *International handbook on conceptual change*. New York: Routledge.
- Vosniadou, S., & Brewer, W. F. (1987). Theories of knowledge restructuring in development. *Review of Educational Research*, 57, 51–67.
- Vosniadou, S., Vamvakoussi, X., & Skopeliti, I. (2008). The framework theory approach to the problem of conceptual change. In S. Vosniadou (Ed.), *International handbook on conceptual change* (pp. 3–34). New York: Routledge.
- Voss, J. F. (1987). Learning and transfer in subject-matter learning: A problem-solving model. *International Journal of Educational Research*, 11, 607–622.
- Voss, J. F., Greene, T. R., Post, T. A., & Penner, B. D. (1983). Problem-solving skill in the social sciences. In G. H. Bower (Ed.), *The psychology of learning and motivation* (Vol. 17, pp. 165–213). New York: Academic Press.
- Voss, J. F., Tyler, S. W., & Yengo, L. A. (1983). Individual differences in the solving of social science problems. In R. F. Dillon & R. R. Schmeck (Eds.), *Individual differences in cognition* (pp. 205–232). New York: Academic Press.
- Voss, J. F., Wolfe, C. R., Lawrence, J. A., & Engle, R. A. (1991). From representation to decision: An analysis of problem solving in international relations. In R. J. Sternberg & P. A. Frensch (Eds.), *Complex problem solving: Principles and mechanisms* (pp. 119–158). Hillsdale, NJ: Erlbaum.
- Vygotsky, L. S. (1978). *Mind in society: The development of higher psychological processes*. Cambridge, MA: Harvard University Press.
- Vygotsky, L. S. (1986). *Thought and language* (rev. ed.; A. Kozulin, Ed. and Trans.). Cambridge, MA: MIT Press. (Original work published 1934)
- Vygotsky, L. S. (1987a). *The collected works of L. S. Vygotsky* (R. W. Rieber & A. S. Carton, Eds.). New York: Plenum Press.
- Vygotsky, L. S. (1987b). Thinking and speech (N. Minick, Trans.). In R. W. Rieber & A. S. Carton (Eds.), *The collected works of L. S. Vygotsky* (Vol. 1, pp. 39–285). New York: Plenum Press.
- Vygotsky, L. S. (1997). *Educational psychology*. Boca Raton, FL: St. Lucie Press.
- Wade, S. E. (1992). How interest affects learning from text. In K. A. Renninger, S. Hidi, & A. Krapp (Eds.), *The role of interest in learning and development* (pp. 255–277). Hillsdale, NJ: Erlbaum.
- Wade-Stein, D., & Kintsch, E. (2004). Summary Street: Interactive computer support for writing. *Cognition and Instruction*, 22, 333–362.
- Wagner, J. F. (2006). Transfer in pieces. *Cognition and Instruction*, 24, 1–71.
- Wagner, R. K. (1996). From simple structure to complex function: Major trends in the development of theories, models, and measurements of memory. In G. R. Lyon & N. A. Krasnegor (Eds.), *Attention, memory, and executive function* (pp. 139–156). Baltimore: Paul H. Brookes.
- Wahler, R. G., Vigilante, V. A., & Strand, P. S. (2004). Generalization in a child's oppositional behavior across home and school settings. *Journal of Applied Behavior Analysis*, 37, 43–51.
- Wai, J., Lubinski, D., & Benbow, C. P. (2009). Spatial ability for STEM domains: Aligning over 50 years of cumulative psychological knowledge solidifies its importance. *Journal of Educational Psychology*, 101, 817–835.
- Waldmann, M. R., Hagmayer, Y., & Blaisdell, A. P. (2006). Beyond the information given: Causal models in learning and reasoning. *Current Directions in Psychological Science*, 15, 307–311.
- Walker, E., Shapiro, D., Esterberg, M., & Trotman, H. (2010). Neurodevelopment and schizophrenia: Broadening the focus. *Current Directions in Psychological Science*, 19, 204–208.
- Walker, E. F. (2002). Adolescent neurodevelopment and psychopathology. *Current Directions in Psychological Science*, 11, 24–28.
- Walker, J. E., & Shea, T. M. (1995). *Behavior management: A practical approach for educators* (6th ed.). Englewood Cliffs, NJ: Merrill/Prentice Hall.
- Walker, M. P. (2005). A refined model of sleep and the time course of memory formation. *Behavioral and Brain Sciences*, 28, 51–104.
- Walkington, C., Sherman, M., & Petrosino, A. (2010, April–May). "Playing the game" of story problems: Situated cognition in algebra problem-solving. Paper presented at the annual meeting of the American Educational Research Association, Denver.
- Wallas, G. (1926). *The art of thought*. New York: Harcourt Brace Jovanovich.

- Waller, R. D., & Higbee, T. S. (2010). The effects of fixed-time escape on inappropriate and appropriate classroom behavior. *Journal of Applied Behavior Analysis, 43*, 149–153.
- Walls, T. A., & Little, T. D. (2005). Relations among personal agency, motivation, and school adjustment in early adolescence. *Journal of Educational Psychology, 97*, 23–31.
- Walshaw, M., & Anthony, G. (2008). The teacher's role in classroom discourse: A review of recent research into mathematics classrooms. *Review of Educational Research, 78*, 516–551.
- Walters, G. C., & Grusec, J. E. (1977). *Punishment*. San Francisco: Freeman.
- Walters, R. H., & Parke, R. D. (1964). Influence of response consequences to a social model on resistance to deviation. *Journal of Experimental Child Psychology, 1*, 269–280.
- Walters, R. H., & Thomas, E. L. (1963). Enhancement of punitiveness by visual and audiovisual displays. *Canadian Journal of Psychology, 17*, 244–255.
- Walters, R. H., Thomas, E. L., & Acker, W. (1962). Enhancement of punitive behavior by audio-visual displays. *Science, 136*, 872–873.
- Walton, G. E., & Bower, T. G. R. (1993). Newborns form "prototypes" in less than 1 minute. *Psychological Science, 4*, 203–205.
- Walton, G. M., & Spencer, S. J. (2009). Latent ability: Grades and test scores systematically underestimate intellectual ability of negatively stereotyped students. *Psychological Science, 20*, 1132–1139.
- Wang, A. Y., & Thomas, M. H. (2000). Looking for long-term mnemonic effects on serial recall: The legacy of Simonides. *American Journal of Psychology, 113*, 331–340.
- Wang, J., & Lin, E. (2005). Comparative studies on U.S. and Chinese mathematics learning and the implications for standards-based mathematics teaching reform. *Educational Researcher, 34* (5), 3–13.
- Wang, M.-T., & Holcombe, R. (2010). Adolescents' perceptions of school environment, engagement, and academic achievement in middle school. *American Educational Research Journal, 47*, 633–662.
- Wang, Q., & Ross, M. (2007). Culture and memory. In S. Kitayama & D. Cohen (Eds.), *Handbook of cultural psychology* (pp. 645–667). New York: Guilford Press.
- Wannarka, R., & Ruhl, K. (2008). Seating arrangements that promote positive academic and behavioural outcomes: A review of empirical research. *Support for Learning, 23* (2), 89–93.
- Want, S. C., & Harris, P. L. (2001). Learning from other people's mistakes: Causal understanding in learning to use a tool. *Child Development, 72*, 431–443.
- Ward, T. B., Vela, E., & Haas, S. D. (1990). Children and adults learn family-resemblance categories analytically. *Child Development, 61*, 593–605.
- Warren, J. S., Bohanon-Edmonson, H. M., Turnbull, A. P., Sailor, W., Wickham, D., Griggs, P., et al. (2006). School-wide positive behavior support: Addressing behavior problems that impeded student learning. *Educational Psychology Review, 18*, 187–198.
- Wartella, E., Caplovitz, A. G., & Lee, J. H. (2004). From Baby Einstein to Leapfrog, from Doom to The Sims, from instant messaging to Internet chat rooms: Public interest in the role of interactive media in children's lives. *Social Policy Report: Giving Child and Youth Development Knowledge Away, 18* (4), 3–19.
- Was, C. A. (2010). The persistence of content-specific memory operations: Priming effects following a 24-h delay. *Psychonomic Bulletin and Review, 17*, 362–368.
- Wasserman, E. A. (1993). Comparative cognition: Toward a general understanding of cognition in behavior. *Psychological Science, 4*, 156–161.
- Waters, H. S. (1982). Memory development in adolescence: Relationships between metamemory, strategy use, and performance. *Journal of Experimental Child Psychology, 33*, 183–195.
- Waters, H. S., & Kunnmann, T. W. (2010). Metacognition and strategy discovery in early childhood. In H. S. Waters & W. Schneider (Eds.), *Metacognition, strategy use, and instruction* (pp. 3–22). New York: Guilford Press.
- Watkins, M. J., & Watkins, O. C. (1974). Processing of recency items for free-recall. *Journal of Experimental Psychology, 102*, 488–493.
- Watson, J. B. (1925). *Behaviorism*. New York: W. W. Norton.
- Watson, J. B., & Rayner, R. (1920). Conditioned emotional reactions. *Journal of Experimental Psychology, 3*, 1–14.
- Watson, M., & Battistich, V. (2006). Building and sustaining caring communities. In C. M. Everton & C. S. Weinstein (Eds.), *Handbook of classroom management: Research, practice, and contemporary issues* (pp. 253–279). Mahwah, NJ: Erlbaum.
- Watts, G. H., & Anderson, R. C. (1971). Effects of three types of inserted questions on learning from prose. *Journal of Educational Psychology, 62*, 387–394.
- Weaver, C. A., III, & Kelemen, W. L. (1997). Judgments of learning at delays: Shifts in response patterns or increased metamemory accuracy? *Psychological Science, 8*, 318–321.
- Webb, N. M. (1989). Peer interaction and learning in small groups. *International Journal of Educational Research, 13*, 21–39.
- Webb, N. M., & Farivar, S. (1994). Promoting helping behavior in cooperative small groups in middle school mathematics. *American Educational Research Journal, 31*, 369–395.
- Webb, N. M., & Farivar, S. (1999). Developing productive group interaction in middle school mathematics. In A. M. O'Donnell & A. King (Eds.), *Cognitive perspectives on peer learning* (pp. 117–149). Mahwah, NJ: Erlbaum.
- Webb, N. M., & Mastergeorge, A. M. (2003). The development of students' helping behavior and learning in peer-directed small groups. *Cognition and Instruction, 21*, 361–428.
- Webb, N. M., Nemer, K. M., Chizhik, A. W., & Sugrue, B. (1998). Equity issues in collaborative group assessment: Group composition and performance. *American Educational Research Journal, 35*, 607–651.
- Webb, N. M., Nemer, K. M., & Zuniga, S. (2002). Short circuits or superconductors? Effects of group composition on high-achieving students' science assessment performance. *American Educational Research Journal, 39*, 943–989.
- Webb, N. M., & Palincsar, A. S. (1996). Group processes in the classroom. In D. C. Berliner & R. C. Calfee (Eds.), *Handbook of educational psychology* (pp. 841–873). New York: Macmillan.
- Webber, J., & Plotts, C. A. (2008). *Emotional and behavioral disorders: Theory and practice* (5th ed.). Boston: Allyn & Bacon.
- Webber, J., Scheuermann, B., McCall, C., & Coleman, M. (1993). Research on self-monitoring as a behavior management technique in special education classrooms: A descriptive review. *Remedial and Special Education, 14* (2), 38–56.
- Weiner, B. (1984). Principles for a theory of student motivation and their application within an attributional framework. In R. Ames & C. Ames (Eds.), *Research on motivation in education: Vol. 1. Student motivation* (pp. 15–38). Orlando, FL: Academic Press.
- Weiner, B. (1986). *An attributional theory of motivation and emotion*. New York: Springer-Verlag.
- Weiner, B. (1994). Ability versus effort revisited: The moral determinants of achievement evaluation and achievement as a moral system. *Educational Psychologist, 29*, 163–172.
- Weiner, B. (1995). *Judgments of responsibility: Foundations for a theory of social conduct*. New York: Guilford Press.
- Weiner, B. (2000). Intrapersonal and interpersonal theories of motivation from an attributional perspective. *Educational Psychology Review, 12*, 1–14.
- Weiner, B. (2004). Attribution theory revisited: Transforming cultural plurality into theoretical unity. In D. M. McNeerney & S. Van Etten (Eds.), *Big theories revisited* (pp. 13–29). Greenwich, CT: Information Age.
- Weiner, B. (2005). Motivation from an attribution perspective and the social psychology of perceived competence. In A. J. Elliot & C. S. Dweck (Eds.), *Handbook of competence and motivation* (pp. 73–84). New York: Guilford Press.
- Weinert, F. E., & Helmke, A. (1995). Learning from wise Mother Nature or Big Brother Instructor: The wrong choice as seen from an educational perspective. *Educational Psychologist, 30*, 135–142.
- Weinraub, M., Clemens, L. P., Sockloff, A., Ethridge, T., Gracely, E., & Myers, B. (1984). The development of sex role stereotypes in the third year: Relationships to gender labeling, gender identity, sex-typed toy preference, and family characteristics. *Child Development, 55*, 1493–1503.
- Weinstein, C. E., Goetz, E. T., & Alexander, P. A. (Eds.) (1988). *Learning and study strategies: Issues in assessment, instruction, and evaluation*. San Diego, CA: Academic Press.
- Weinstein, R. S. (2002). *Reaching higher: The power of expectations in schooling*. Cambridge, MA: Harvard University Press.
- Weinstein, R. S., Madison, S. M., & Kuklinski, M. R. (1995). Raising expectations in schooling:



- Obstacles and opportunities for change. *American Educational Research Journal*, 32, 121–159.
- Weissberg, R. W., DiCamillo, M., & Phillips, D. (1979). Transferring old associations to new situations: A nonautomatic process. *Journal of Verbal Learning and Verbal Behavior*, 17, 219–228.
- Weisgram, E. S., Bigler, R. S., & Liben, L. S. (2010). Gender, values, and occupational interests among children, adolescents, and adults. *Child Development*, 81, 778–796.
- Weiss, M. R., & Klint, K. A. (1987). "Show and tell" in the gymnasium: An investigation of developmental differences in modeling and verbal rehearsal of motor skills. *Research Quarterly for Exercise and Sport*, 58, 234–241.
- Weisz, J. R. (1986). Understanding the developing understanding of control. In M. Perlmutter (Ed.), *Cognitive perspectives on children's social and behavioral development*. Minnesota Symposia on Child Psychology (Vol. 18, pp. 219–278). Hillsdale, NJ: Erlbaum.
- Weisz, J. R., & Cameron, A. M. (1985). Individual differences in the student's sense of control. In C. Ames & R. Ames (Eds.), *Research on motivation in education: Vol. 2. The classroom milieu* (pp. 93–140). Orlando, FL: Academic Press.
- Welch, G. J. (1985). Contingency contracting with a delinquent and his family. *Journal of Behavior Therapy and Experimental Psychiatry*, 16, 253–259.
- Welder, A. N., & Graham, S. A. (2001). The influence of shape similarity and shared labels on infants' inductive inferences about nonobvious object properties. *Child Development*, 72, 1653–1673.
- Wellman, H. M. (1990). *The child's theory of mind*. Cambridge, MA: MIT Press.
- Wellman, H. M., & Gelman, S. A. (1992). Cognitive development: Foundational theories of core domains. In M. R. Rosenzweig & L. W. Porter (Eds.), *Annual review of psychology* (Vol. 43, pp. 337–375). Palo Alto, CA: Annual Reviews.
- Wellman, H. M., & Hickling, A. K. (1994). The mind's "I": Children's conception of the mind as an active agent. *Child Development*, 65, 1564–1580.
- Wells, G. L., Olson, E. A., & Charman, S. D. (2002). The confidence of eyewitnesses in their identifications from lineups. *Current Directions in Psychological Science*, 11, 151–154.
- Wenger, E. (1998). *Communities of practice: Learning, meaning, and identity*. Cambridge, England: Cambridge University Press.
- Wentzel, K. R. (1999). Social-motivational processes and interpersonal relationships: Implications for understanding motivation at school. *Journal of Educational Psychology*, 91, 76–97.
- Wentzel, K. R., Battle, A., Russell, S. L., & Looney, L. B. (2010). Social supports from teachers and peers as predictors of academic and social motivation. *Contemporary Educational Psychology*, 35, 193–202.
- Wentzel, K. R., & Wigfield, A. (1998). Academic and social motivational influences on students' academic performance. *Educational Psychology Review*, 10, 155–175.
- Wertheimer, M. (1912). Experimentelle Studien über das Sehen von Bewegung. *Zeitschrift für Psychologie*, 61, 161–265.
- Wertheimer, M. (1959). *Productive thinking* (Enl. ed., M. Wertheimer, Ed.). New York: Harper.
- Wertsch, J. V. (1984). The zone of proximal development: Some conceptual issues. *Children's learning in the zone of proximal development: New directions for child development* (No. 23). San Francisco: Jossey-Bass.
- Wessa, M., & Flor, H. (2007). Failure of extinction of fear responses in posttraumatic stress disorder: Evidence from second-order conditioning. *American Journal of Psychiatry*, 164, 1684–1692.
- West, R. F., Toplak, M. E., & Stanovich, K. E. (2008). Heuristics and biases as measures of critical thinking: Associations with cognitive ability and thinking dispositions. *Journal of Educational Psychology*, 100, 930–941.
- Wheeler, J. J., & Richey, D. D. (2010). *Behavior management: Principles and practices of positive behavioral supports* (2nd ed.). Columbus, OH: Merrill/Pearson.
- Whitaker Sena, J. D., Lowe, P. A., & Lee, S. W. (2007). Significant predictors of test anxiety among students with and without learning disabilities. *Journal of Learning Disabilities*, 40, 360–376.
- White, A. G., & Bailey, J. S. (1990). Reducing disruptive behaviors of elementary physical education students with sit and watch. *Journal of Applied Behavior Analysis*, 23, 353–359.
- White, B. Y., & Frederiksen, J. (2005). A theoretical framework and approach for fostering metacognitive development. *Educational Psychologist*, 40, 211–223.
- White, R. (1959). Motivation reconsidered: The concept of competence. *Psychological Review*, 66, 297–333.
- Whitehead, A. N. (1929). *The aims of education and other essays*. New York: Macmillan.
- Whitlock, C. (1966). Note on reading acquisition: An extension of laboratory principles. *Journal of Experimental Child Psychology*, 3, 83–85.
- Whitten, S., & Graesser, A. C. (2003). Comprehension of text in problem solving. In J. E. Davidson & R. J. Sternberg (Eds.), *The psychology of problem solving* (pp. 207–229). Cambridge, England: Cambridge University Press.
- Wickelgren, W. A. (1973). The long and the short of memory. *Psychological Bulletin*, 80, 425–438.
- Wickelgren, W. A. (1974). *How to solve problems: Elements of a theory of problems and problem solving*. San Francisco: Freeman.
- Wicker, B., Keysers, C., Plailly, J., Royet, J.-P., Gallese, V., & Rizzolatti, G. (2003). Both of us disgusted in My insula: The common neural basis of seeing and feeling disgust. *Neuron*, 40, 655–664.
- Wigfield, A. (1994). Expectancy-value theory of achievement motivation: A developmental perspective. *Educational Psychology Review*, 6, 49–78.
- Wigfield, A., Byrnes, J. P., & Eccles, J. S. (2006). Development during early and middle adolescence. In P. A. Alexander & P. H. Winne (Eds.), *Handbook of educational psychology* (2nd ed., pp. 87–113). Mahwah, NJ: Erlbaum.
- Wigfield, A., & Eccles, J. (1992). The development of achievement task values: A theoretical analysis. *Developmental Review*, 12, 265–310.
- Wigfield, A., & Eccles, J. (2000). Expectancy-value theory of achievement motivation. *Contemporary Educational Psychology*, 25, 68–81.
- Wigfield, A., & Eccles, J. (2002). The development of competence beliefs, expectancies for success, and achievement values from childhood to adolescence. In A. Wigfield & J. Eccles (Eds.), *Development of achievement motivation* (pp. 91–120). San Diego, CA: Academic Press.
- Wigfield, A., Eccles, J. S., Mac Iver, D., Reuman, D., & Midgley, C. (1991). Transitions at early adolescence: Changes in children's domain-specific self-perceptions and general self-esteem across the transition to junior high school. *Developmental Psychology*, 27, 552–565.
- Wigfield, A., Eccles, J. S., & Pintrich, P. R. (1996). Development between the ages of 11 and 25. In D. C. Berliner & R. C. Calfee (Eds.), *Handbook of educational psychology* (pp. 148–185). New York: Macmillan.
- Wigfield, A., & Meece, J. L. (1988). Math anxiety in elementary and secondary school students. *Journal of Educational Psychology*, 80, 210–216.
- Wigfield, A., Tonks, S., & Eccles, J. S. (2004). Expectancy value theory in cross-cultural perspective. In D. M. McNerney & S. Van Etten (Eds.), *Big theories revisited* (pp. 165–198). Greenwich, CT: Information Age.
- Wiggins, G., & McTighe, J. (2005). *Understanding by Design* (2nd ed.). Alexandria, VA: Association for Supervision and Curriculum Development.
- Wiggins, J. S. (1996). *The Five-Factor Model of personality: Theoretical dimensions*. New York: Guilford.
- Wiley, J., & Bailey, J. (2006). Effects of collaboration and argumentation on learning from Web pages. In A. M. O'Donnell, C. E. Hmelo-Silver, & G. Erkens (Eds.), *Collaborative learning, reasoning, and technology* (pp. 297–321). Mahwah, NJ: Erlbaum.
- Wiley, J., Goldman, S. R., Graesser, A. C., Sanchez, C. A., Ash, I. K., & Hemmerich, J. A. (2009). Source evaluation, comprehension, and learning in Internet science inquiry tasks. *American Educational Research Journal*, 46, 1060–1106.
- Wiley, J., & Voss, J. F. (1999). Constructing arguments from multiple sources: Tasks that promote understanding and not just memory for text. *Journal of Educational Psychology*, 91, 301–311.
- Willatts, P. (1990). Development of problem solving strategies in infancy. In D. F. Bjorklund (Ed.), *Children's strategies: Contemporary views of cognitive development* (pp. 23–66). Hillsdale, NJ: Erlbaum.
- Willems, R. M., Hagoort, P., & Casasanto, D. (2010). Body-specific representations of

- action verbs: Neural evidence from right- and left-handers. *Psychological Science*, 21, 67–74.
- Williams, D. (1996). *Autism: An inside-out approach*. London: Jessica Kingsley Publishers.
- Williams, J. P., & Atkins, J. G. (2009). The role of metacognition in teaching reading comprehension to primary students. In D. J. Hacker, J. Dunlosky, & A. C. Graesser (Eds.), *Handbook of metacognition in education* (pp. 26–43). New York: Routledge.
- Williams, J. P., Stafford, K. B., Lauer, K. D., Hall, K. M., & Pollini, S. (2009). Embedding reading comprehension training in content-area instruction. *Journal of Educational Psychology*, 101, 1–20.
- Williams, S. B. (1938). Resistance to extinction as a function of the number of reinforcement ds. *Journal of Experimental Psychology*, 23, 506–522.
- Williams, S. M. (2010, April–May). *The impact of collaborative, scaffolded learning in K–12 schools: A meta-analysis*. Paper presented at the annual meeting of the American Educational Research Association, Denver.
- Williams, T., & Williams, K. (2010). Self-efficacy and performance in mathematics: Reciprocal determinism in 33 nations. *Journal of Educational Psychology*, 102, 453–456.
- Willingham, D. B. (1999). The neural basis of motor-skill learning. *Current Directions in Psychological Science*, 8, 178–182.
- Willingham, D. B., & Goedert-Eschmann, K. (1999). The relation between implicit and explicit learning: Evidence for parallel development. *Psychological Science*, 10, 531–534.
- Willingham, D. T. (2004). *Cognition: The thinking animal* (2nd ed.). Upper Saddle River, NJ: Prentice Hall.
- Wilson, B. L., & Corbett, H. D. (2001). *Listening to urban kids: School reform and the teachers they want*. Albany: State University of New York Press.
- Wilson, P. T., & Anderson, R. C. (1986). What they don't know will hurt them: The role of prior knowledge in comprehension. In J. Orasanu (Ed.), *Reading comprehension: From research to practice* (pp. 31–48). Hillsdale, NJ: Erlbaum.
- Wilson, T. D., & Gilbert, D. T. (2008). Explaining away: A model of affective adaptation. *Perspectives on Psychological Science*, 3, 370–386.
- Windschitl, M. (2002). Framing constructivism in practice as the negotiation of dilemmas: An analysis of the conceptual, pedagogical, cultural, and political challenges facing teachers. *Review of Educational Research*, 72, 131–175.
- Wine, J. D. (1980). Cognitive-attentional theory of test anxiety. In I. G. Sarason (Ed.), *Test anxiety: Theory, research, and applications* (pp. 349–385). Hillsdale, NJ: Erlbaum.
- Winer, G. A., & Cottrell, J. E. (1996). Does anything leave the eye when we see? Extramission beliefs of children and adults. *Current Directions in Psychological Science*, 5, 137–142.
- Winer, G. A., Cottrell, J. E., Gregg, V., Fournier, J. S., & Bica, L. A. (2002). Fundamentally misunderstanding visual perception: Adults' belief in visual emissions. *American Psychologist*, 57, 417–424.
- Wingfield, A., & Byrnes, D. L. (1981). *The psychology of human memory*. New York: Academic Press.
- Winik, M. (1994). *Telling*. New York: Random House.
- Winkielman, P., & Berridge, K. C. (2004). Unconscious emotion. *Current Directions in Psychological Science*, 13, 120–123.
- Winn, W. (1991). Learning from maps and diagrams. *Educational Psychology Review*, 3, 211–247.
- Winn, W. (2002). Current trends in educational technology research: The study of learning environments. *Educational Psychology Review*, 14, 331–351.
- Winne, P. H. (1995). Inherent details in self-regulated learning. *Educational Psychologist*, 30, 173–187.
- Winne, P. H., & Hadwin, A. F. (1998). Studying as self-regulated learning. In D. J. Hacker, J. Dunlosky, & A. C. Graesser (Eds.), *Metacognition in educational theory and practice* (pp. 277–304). Mahwah, NJ: Erlbaum.
- Winne, P. H., & Stockley, D. B. (1998). Computing technologies as sites for developing self-regulated learning. In D. H. Schunk & B. J. Zimmerman (Eds.), *Self-regulated learning: From teaching to self-reflective practice* (pp. 106–136). New York: Guilford Press.
- Winsler, A., & Naglieri, J. (2003). Overt and covert verbal problem-solving strategies: Developmental trends in use, awareness, and relations with task performance in children aged 5 to 17. *Child Development*, 74, 659–678.
- Winters, F. I., Greene, J. A., & Costich, C. M. (2008). Self-regulation of learning within computer-based learning environments: A critical analysis. *Educational Psychology Review*, 20, 429–444.
- Wiser, M., & Smith, C. L. (2008). Learning and teaching about matter in grades K–8: When should the atomic-molecular theory be introduced? In S. Vosniadou (Ed.), *International handbook on conceptual change* (pp. 205–231). New York: Routledge.
- Wisner Fries, A. B., & Pollak, S. D. (2007). Emotion processing and the developing brain. In D. Coch, K. W. Fischer, & G. Dawson (Eds.), *Human behavior, learning, and the developing brain: Typical development* (pp. 329–361). New York: Guilford Press.
- Witkow, M. R., & Fuligni, A. J. (2007). Achievement goals and daily school experiences among adolescents with Asian, Latino, and European American backgrounds. *Journal of Educational Psychology*, 99, 584–596.
- Wittenbaum, G. M., & Park, E. S. (2001). The collective preference for shared information. *Current Directions in Psychological Science*, 10, 70–73.
- Witrock, M. C. (1974). Learning as a generative process. *Educational Psychologist*, 11, 87–95.
- Witrock, M. C., & Alesandrini, K. (1990). Generation of summaries and analogies and analytic and holistic abilities. *American Educational Research Journal*, 27, 489–502.
- Wixson, K. K. (1984). Level of importance of post-questions and children's learning from text. *American Educational Research Journal*, 21, 419–433.
- Wixted, J. T. (2005). A theory about why we forget what we once knew. *Current Directions in Psychological Science*, 14, 6–9.
- Wixted, J. T., & Ebbesen, E. B. (1991). On the form of forgetting. *Psychological Science*, 2, 409–415.
- Woloshyn, V. E., Pressley, M., & Schneider, W. (1992). Elaborative-interrogation and prior-knowledge effects on learning of facts. *Journal of Educational Psychology*, 84, 115–124.
- Wolpe, J. (1969). *The practice of behavior therapy*. Oxford, England: Pergamon Press.
- Wolpe, J., & Plaud, J. J. (1997). Pavlov's contributions to behavior therapy: The obvious and the not so obvious. *American Psychologist*, 52, 966–972.
- Wolters, C. A. (2000). The relation between high school students' motivational regulation and their use of learning strategies, effort, and classroom performance. *Learning and Individual Differences*, 3, 281–299.
- Wolters, C. A. (2003a). Regulation of motivation: Evaluating an underemphasized aspect of self-regulated learning. *Educational Psychologist*, 38, 189–205.
- Wolters, C. A. (2003b). Understanding procrastination from a self-regulated learning perspective. *Journal of Educational Psychology*, 95, 179–187.
- Wolters, C. A. (2004). Advancing achievement goal theory: Using goal structures and goal orientations to predict students' motivation, cognition, and achievement. *Journal of Educational Psychology*, 96, 236–250.
- Wolters, C. A., & Rosenthal, H. (2000). The relation between students' motivational beliefs and their use of motivational regulation strategies. *International Journal of Educational Research*, 33, 801–820.
- Wong, B. Y. L. (1985). Self-questioning instructional research: A review. *Review of Educational Research*, 55, 227–268.
- Wong, B. Y. L., Hoskyn, M., Jai, D., Ellis, P., & Watson, K. (2008). The comparative efficacy of two approaches to teaching sixth graders opinion essay writing. *Contemporary Educational Psychology*, 33, 757–784.
- Wood, D., Bruner, J. S., & Ross, G. (1976). The role of tutoring in problem-solving. *Journal of Child Psychology and Psychiatry*, 17, 89–100.
- Wood, E., Motz, M., & Willoughby, T. (1998). Examining students' retrospective memories of strategy development. *Journal of Educational Psychology*, 90, 698–704.
- Wood, E., Willoughby, T., Bolger, A., & Younger, J. (1993). Effectiveness of elaboration strategies for grade school children as a function of academic achievement. *Journal of Experimental Child Psychology*, 56, 240–253.
- Wood, P., & Kardash, C. A. M. (2002). Critical elements in the design and analysis of studies of epistemology. In B. K. Hofer & P. R. Pintrich

- (Eds.), *Personal epistemology: The psychology of beliefs about knowledge and knowing* (pp. 231–260). Mahwah, NJ: Erlbaum.
- Woodman, G. F., Vogel, E. K., & Luck, S. J. (2001). Visual search remains efficient when visual working memory is full. *Psychological Science*, *12*, 219–224.
- Woods, D. W., & Miltenberger, R. G. (1995). Habit reversal: A review of applications and variations. *Journal of Behavior Therapy and Experimental Psychiatry*, *26*, 123–131.
- Woodworth, R. S. (1918). *Dynamic psychology*. New York: Columbia University Press.
- Woolfolk, A. E., & Brooks, D. M. (1985). The influence of teachers' nonverbal behaviors on students' perceptions and performances. *Elementary School Journal*, *85*, 513–528.
- Wright, R. (1994). *The moral animal: The new science of evolutionary psychology*. New York: Pantheon Books.
- Wynn, K., & Chiang, W. (1998). Limits to infants' knowledge of objects: The case of magical appearance. *Psychological Science*, *9*, 448–455.
- Xu, J. (2008). Models of secondary school students' interest in homework: A multilevel analysis. *American Educational Research Journal*, *45*, 1180–1205.
- Yarmey, A. D. (1973). I recognize your face but I can't remember your name: Further evidence on the tip-of-the-tongue phenomenon. *Memory and Cognition*, *1*, 287–290.
- Yerkes, R. M., & Dodson, J. D. (1908). The relation of strength of stimulus to rapidity of habit-formation. *Journal of Comparative Neurology and Psychology*, *18*, 459–482.
- Younger, B. A. (2003). Parsing objects into categories: Infants' perception and use of correlated attributes. In D. H. Rakison & L. M. Oakes (Eds.), *Early category and concept development: Making sense of the blooming, buzzing confusion* (pp. 77–102). Oxford, England: Oxford University Press.
- Zacks, R. T., Hasher, L., & Hock, H. S. (1986). Inevitability and automaticity: A response to Fisk. *American Psychologist*, *41*, 216–218.
- Zahorik, J. A. (1994, April). *Making things interesting*. Paper presented at the annual meeting of the American Educational Research Association, New Orleans, LA.
- Zajonc, R. B. (1980). Feeling and thinking: Preferences need no inferences. *American Psychologist*, *35*, 151–175.
- Zajonc, R. B. (2000). Feeling and thinking: Closing the debate on the primacy of affect. In J. P. Forgas (Ed.), *Feeling and thinking: The role of affect in social cognition* (pp. 31–58). New York: Cambridge University Press.
- Zajonc, R. B. (2001). Mere exposure: A gateway to the subliminal. *Current Directions in Psychological Science*, *10*, 224–228.
- Zaragoza, M. S., & Mitchell, K. J. (1996). Repeated exposure to suggestion and the creation of false memories. *Psychological Science*, *7*, 294–300.
- Zaragoza, M. S., Payment, K. E., Ackil, J. K., Drivdahl, S. B., & Beck, M. (2001). Interviewing witnesses: Forced confabulation and confirmatory feedback increase false memories. *Psychological Science*, *12*, 473–477.
- Zechmeister, E. B., & Nyberg, S. E. (1982). *Human memory: An introduction to research and theory*. Monterey, CA: Brooks-Cole.
- Zeelenberg, R. (2005). Encoding specificity manipulations do affect retrieval from memory. *Acta Psychologica*, *119*, 107–121.
- Zeidner, M. (1998). *Test anxiety: The state of the art*. New York: Plenum Press.
- Zeidner, M., & Matthews, G. (2005). Evaluation anxiety: Current theory and research. In A. J. Elliot & C. S. Dweck (Eds.), *Handbook of competence and motivation* (pp. 141–163). New York: Guilford Press.
- Zelazo, P. D., Müller, U., Frye, D., & Marcovitch, S. (2003). The development of executive function in early childhood. *Monographs of the Society for Research in Child Development*, *68* (3), Serial No. 274.
- Zentall, T. R. (2003). Imitation by animals: How do they do it? *Current Directions in Psychological Science*, *12*, 91–95.
- Zhang, J., Scardamalia, M., Reeve, R., & Messina, R. (2009). Designs for collective cognitive responsibility in knowledge-building communities. *Journal of the Learning Sciences*, *18*, 7–44.
- Zhang, W., & Luck, S. J. (2009). Sudden death and gradual decay in visual working memory. *Psychological Science*, *20*, 423–428.
- Zhao, Q., & Linderholm, T. (2008). Adult meta-comprehension: Judgment processes and accuracy constraints. *Educational Psychology Review*, *20*, 191–206.
- Zhong, C.-B., Dijksterhuis, A., & Galinsky, A. D. (2008). The merits of unconscious thought in creativity. *Psychological Science*, *19*, 912–918.
- Ziegler, D. I., Kistner, J. A., Castro, R., & Robertson, B. (2001). Longitudinal study of young children's responses to challenging achievement situations. *Child Development*, *72*, 609–624.
- Ziegler, S. G. (1987). Effects of stimulus cueing on the acquisition of groundstrokes by beginning tennis players. *Journal of Applied Behavior Analysis*, *20*, 405–411.
- Zigler, E. (2003). Forty years of believing in magic is enough. *Social Policy Report*, *17* (1), 10.
- Zimmerman, B. J. (1981). Social learning theory and cognitive constructivism. In I. E. Sigel, D. M. Brodzinsky, & R. M. Golinkoff (Eds.), *New directions in Piagetian theory and practice* (pp. 39–49). Hillsdale, NJ: Erlbaum.
- Zimmerman, B. J. (1989). Models of self-regulated learning and academic achievement. In B. J. Zimmerman & D. H. Schunk (Eds.), *Self-regulated learning and academic achievement: Theory, research, and practice* (pp. 1–25). New York: Springer-Verlag.
- Zimmerman, B. J. (1994, April). *From modeling to self-efficacy: A social cognitive view of students' development of motivation to self-regulate*. Paper presented at the annual meeting of the American Educational Research Association, New Orleans, LA.
- Zimmerman, B. J. (1998). Developing self-fulfilling cycles of academic regulation: An analysis of exemplary instructional models. In D. H. Schunk & B. J. Zimmerman (Eds.), *Self-regulated learning: From teaching to self-reflective practice* (pp. 1–19). New York: Guilford Press.
- Zimmerman, B. J. (2004). Sociocultural influence and students' development of academic self-regulation: A social-cognitive perspective. In D. M. McNeerney & S. Van Etten (Eds.), *Big theories revisited* (pp. 139–164). Greenwich, CT: Information Age.
- Zimmerman, B. J. (2008). In search of self-regulated learning: A personal quest. In H. W. Marsh, R. G. Craven, & D. M. McNeerney (Eds.), *Self-processes, learning, and enabling human potential* (pp. 171–191). Charlotte, NC: Information Age.
- Zimmerman, B. J. (2010). Self-efficacy: An essential motive to learn. In G. S. Goodman (Ed.), *Educational psychology reader: The art and science of how people learn* (pp. 223–230). New York: Peter Lang.
- Zimmerman, B. J., & Bandura, A. (1994). Impact of self-regulatory influences on writing course attainment. *American Educational Research Journal*, *31*, 845–862.
- Zimmerman, B. J., & Campillo, M. (2003). Motivating self-regulated problem solvers. In J. E. Davidson & R. J. Sternberg (Eds.), *The psychology of problem solving* (pp. 233–262). Cambridge, England: Cambridge University Press.
- Zimmerman, B. J., & Kitsantas, A. (1997). Developmental phases in self-regulation: Shifting from process to outcome goals. *Journal of Educational Psychology*, *89*, 29–36.
- Zimmerman, B. J., & Kitsantas, A. (1999). Acquiring writing revision skill: Shifting from process to outcome self-regulatory goals. *Journal of Educational Psychology*, *91*, 241–250.
- Zimmerman, B. J., & Kitsantas, A. (2002). Acquiring writing revision and self-regulatory skill through observation and emulation. *Journal of Educational Psychology*, *94*, 660–668.
- Zimmerman, B. J., & Kitsantas, A. (2005). The hidden dimension of personal competence: Self-regulated learning and practice. In A. J. Elliot & C. S. Dweck (Eds.), *Handbook of competence and motivation* (pp. 509–526). New York: Guilford Press.
- Zimmerman, B. J., & Moylan, A. R. (2009). Self-regulation: Where metacognition and motivation intersect. In D. J. Hacker, J. Dunlosky, & A. C. Graesser (Eds.), *Handbook of metacognition in education* (pp. 299–315). New York: Routledge.
- Zimmerman, B. J., & Risemberg, R. (1997). Self-regulatory dimensions of academic learning and motivation. In G. D. Pyle (Ed.), *Handbook of academic learning: Construction of knowledge* (pp. 106–125). San Diego, CA: Academic Press.
- Zimmerman, B. J., & Schunk, D. H. (2003). Albert Bandura: The scholar and his contributions to educational psychology. In B. J. Zimmerman & D. H. Schunk (Eds.), *Educational psychology: A century of contributions* (pp. 431–457). Mahwah, NJ: Erlbaum.
- Zimmerman, B. J., & Schunk, D. H. (2004). Self-regulating intellectual processes and

- outcomes: A social cognitive perspective. In D. Y. Dai & R. J. Sternberg (Eds.), *Motivation, emotion, and cognition: Integrative perspectives on intellectual functioning and development* (pp. 323–349). Mahwah, NJ: Erlbaum.
- Zirin, G. (1974). How to make a boring thing more boring. *Child Development, 45*, 232–236.
- Zirpoli, T. J., & Melloy, K. J. (2001). *Behavior management: Applications for teachers*. Upper Saddle River, NJ: Merrill/Prentice Hall.
- Zohar, A., & Aharon-Kraversky, S. (2005). Exploring the effects of cognitive conflict and direct teaching for students of different academic levels. *Journal of Research in Science Teaching, 42*, 829–855.
- Zola-Morgan, S. M., & Squire, L. R. (1990). The primate hippocampal formation: Evidence for a time-limited role in memory storage. *Science, 250*, 288–290.
- Zook, K. B. (1991). Effects of analogical processes on learning and misrepresentation. *Educational Psychology Review, 3*, 41–72.
- Zook, K. B., & Di Vesta, F. J. (1991). Instructional analogies and conceptual misrepresentations. *Journal of Educational Psychology, 83*, 246–252.
- Zuckerman, M. (1994). *Behavioural expressions and biosocial bases of sensation seeking*. Cambridge, England: Cambridge University Press.
- Zuriff, G. E. (1985). *Behaviorism: A conceptual reconstruction*. New York: Columbia University Press.

# Name Index

- Aarts, H., 270  
Abaied, J., 443  
Abelson, R. P., 244  
Ablard, K. E., 470  
Abrami, P. C., 341, 423  
Abrams, R. A., 163, 186  
Abramson, L. Y., 435, 484  
Abuhamdeh, S., 428  
Acker, W., 120  
Ackerman, J. M., 207, 364  
Ackerman, P. L., 198, 201  
Ackil, J. K., 275  
Adams, M. J., 209  
Adamson, L. B., 327, 328  
Addison, L. R., 76  
Adelgais, A., 343  
Adesope, O. O., 200  
Adkins, D. R., 22  
Adolphs, R., 20  
Adrián, J. E., 373  
Afflerbach, P., 354, 355n, 385  
Aharon-Kraversky, S., 301, 308, 309  
Ahearn, W. H., 98, 457  
Ainley, M., 182, 464  
Ajzen, I., 480  
Akamatsu, S., 224, 269  
Alampay, D. A., 188  
Alberg, S. R., 85  
Alberto, P. A., 60, 61, 87, 95, 134  
Alderman, K., 493  
Alesandrini, K., 364  
Aleven, V., 357, 385, 488  
Alexander, J. M., 259, 397, 463, 464  
Alexander, K. W., 273, 274  
Alexander, L., 215  
Alexander, P. A., 154, 156, 213, 248, 252, 254, 259, 260, 358, 363, 374, 376, 377, 379, 382, 383, 464, 468n, 471  
Alfassi, M., 340  
Alfeld, C., 415, 471  
Alford, G. S., 115  
Alibali, M. W., 177, 235, 247, 262, 302, 358, 382, 410  
Alleman, J., 103, 211, 249, 262, 283, 384, 414, 492, 498  
Allen, J., 499  
Allen, K. D., 88  
Allor, J. H., 345  
Alloway, T. P., 169  
Altmann, E. M., 276  
Alvarez, G. A., 168, 197  
Alvarez, P., 29  
Alvero, A. M., 74  
Amabile, T. M., 437, 438, 455, 456  
Amaya-Williams, M., 133n  
American Psychological Association Zero Tolerance Task Force, 62  
Ames, C., 46, 494, 497  
Ames, R., 488  
Amlund, J. T., 373, 384  
Amrein, A. L., 102  
Amsterlaw, J., 422  
Anand, P., 492  
Andalman, A., 25  
Andelman, M. S., 76  
Anderman, E. M., 432, 436, 447, 448, 460, 466, 469, 470, 471, 472, 474, 494, 498, 499  
Anderman, L. H., 442, 459, 468n, 470, 471, 472, 474, 498, 499  
Anderson, C., 249, 258, 446  
Anderson, C. A., 123, 255  
Anderson, C. J., 470  
Anderson, C. W., 204, 256, 427  
Anderson, D. R., 124, 419  
Anderson, J. L., 283  
Anderson, J. R., 156, 167, 174, 176, 179, 192, 196, 198, 199, 208, 209, 217, 223, 226, 227, 232, 268, 277, 278, 279, 280, 333, 396, 397, 398  
Anderson, L. W., 103, 223, 283, 284  
Anderson, M. C., 222, 278  
Anderson, M. C. M., 357  
Anderson, P., 44  
Anderson, R. C., 7, 124, 163, 203, 212, 243, 244, 245, 278, 279, 423  
Anderson, V., 364  
Andrade, H. L., 357, 386  
Andre, T., 238, 256, 336, 386, 492  
Andres, M., 226, 228  
Andrews, G., 261, 301, 302, 320  
Andrews, J. M., 76  
Andrews-Weckerly, S., 423  
Andriessen, J., 335, 336, 348, 349  
Andrzejewski, C. E., 499  
Angello, G., 277, 407  
Anthony, G., 336  
Anzai, Y., 404, 408, 413  
Appel, J. B., 82, 89  
Apperly, I. A., 300  
Applebee, A. N., 331, 335, 336  
Araujo, J., 108, 215, 269, 326  
Arbeau, K. A., 357  
Arbuckle, N. B., 484  
Arbuthnot, K., 103, 468n  
Arce, H.-M. C., 482  
Archambault, I., 466  
Ardoin, S. P., 75  
Ariely, D., 356  
Arlin, M., 108  
Armbruster, B. B., 213  
Arnaud, M. W., 253  
Arnold, D. H., 123  
Aron, A. R., 168n, 171  
Aronfreed, J., 89, 91  
Aronson, E., 342  
Aronson, J., 454  
Arrigo, J. M., 277, 278n  
Artman, L., 302  
Ash, D., 322  
Ash, I. K., 408  
Ashcraft, M. H., 268, 272, 453, 454  
Asher, S. R., 475  
Ashman, A. F., 342, 436  
Ashton, P., 496  
Asoko, H., 253  
Aspinwall, L. G., 345  
Assor, A., 129, 436, 470, 491  
Asterhan, C. S. C., 335  
Aston, J. W., 377  
Astutii, R., 251  
Atak, J. R., 75  
Atance, C. M., 83  
Atkins, J. G., 383  
Atkinson, J. W., 76, 443, 443-444, 444  
Atkinson, R., 160  
Atkinson, R. C., 163, 176, 191, 369  
Atkinson, R. K., 195, 207, 359-360, 412, 415, 418  
Au, W., 102  
Aulls, M. W., 283  
Austin, G., 141, 239  
Austin, J., 74  
Austin, J. L., 87, 108  
Ausubel, D. P., 141, 200, 213, 229, 231, 390  
Avni-Babad, D., 137  
Awh, E., 169, 170n  
Axelrod, S., 59, 90  
Aydede, M., 331  
Ayllon, T., 82  
Ayoub, C. C., 24  
Ayres, J., 44  
Ayres, L. R., 357, 386, 456  
Azevedo, R., 355, 357, 376, 385  
Azrin, N. H., 55, 59, 89  
Babrad, E., 137, 495  
Baccus, J. R., 42  
Bachevalier, J., 177, 223  
Bachicha, D. L., 125  
Backus, D. W., 376  
Baddeley, A. D., 168, 168n, 169, 170, 172, 173, 175, 179, 269  
Badets, A., 226  
Baek, J. Y., 249, 366  
Baer, D. M., 86, 95, 119n  
Baeyens, F., 38  
Bahrack, A. S., 208  
Bahrack, H. P., 208, 275  
Bahrack, L. E., 163, 208  
Bahrack, P. E., 208  
Bailey, J., 336  
Bailey, J. S., 60  
Baillargeon, R., 27, 28, 247, 300  
Bajaj, A., 377  
Bajo, M. T., 277  
Bakeman, R., 328  
Baker, J., 137  
Baker, L., 45, 354, 355, 359, 364, 383  
Baker, R., 385  
Balch, W., 270  
Baldwin, C. L., 162  
Baldwin, D. A., 164, 328  
Baldwin, M. W., 42  
Bandalos, D. L., 201, 213, 470

- Bandura, A., 31, 81, 111, 112, 113, 114, 115, 116, 117, 118, 119, 120, 121, 122, 123, 124, 125, 127, 128, 129, 130, 131, 132, 133, 357, 431, 437, 441n, 467, 479, 493  
 Bangert-Drowns, R. L., 108, 423  
 Banich, M. T., 168, 171  
 Bankert, E., 423  
 Banko, K. M., 439  
 Banks, W. P., 278  
 Bannan-Ritland, B., 249, 366  
 Bao, X., 438  
 Baptista, M. A. S., 42  
 Barab, S. A., 332  
 Barad, M., 35  
 Baranowski, J., 437  
 Barbaranelli, C., 128  
 Barbey, A., 224  
 Barbizet, J., 29  
 Barch, D. M., 16  
 Barchfield, P., 301  
 Bargai, N., 487  
 Bargh, J. A., 177, 467  
 Barker, G., 483  
 Barkley, R. A., 60, 164, 166, 182  
 Barkoukis, V., 437  
 Barnett, R. C., 38  
 Barnett, J. E., 362  
 Barnett, S. M., 392, 396, 397, 398  
 Barnett, W. S., 318  
 Baron, A., 91, 119  
 Baron, J. B., 286, 459  
 Barr, R., 126  
 Barrett, A. M., 197  
 Barrett, M., 428  
 Barrish, H. H., 96, 97  
 Barron, B., 341  
 Barron, K. E., 463, 464  
 Barrouillet, P., 200  
 Barsalou, L. W., 222, 224, 228  
 Bartholow, B. D., 123  
 Bartlett, F. C., 189, 190, 204  
 Bartlett, M., 443  
 Bartlett, S., 213  
 Bartling, J., 162  
 Barton, K. C., 310, 311  
 Barzillai, M., 384  
 Bassok, M., 225, 392, 396, 397, 398, 407, 412, 413  
 Bates, S. L., 123  
 Batsche, C., 122  
 Battistich, V., 346, 459  
 Battle, A., 459  
 Bauer, J. J., 484  
 Bauer, P. J., 22, 23, 24, 29, 199, 222, 222n, 266, 274, 280, 332  
 Bauml, K.-H., 277, 448–449  
 Baumrind, D., 61  
 Bavelier, D., 26, 27  
 Baxter Magolda, M. B., 376, 377  
 Baynham, T. Y., 54  
 Bear, G. G., 99  
 Bear, P., 135, 217  
 Beauregard, M., 177, 223  
 Bebkco, J. M., 300, 320  
 Bechtel, D. R., 59  
 Beck, I. L., 211, 212, 256, 337, 355, 384  
 Beck, M., 275  
 Beck, S. R., 300  
 Becker, B. J., 199  
 Becker, J. T., 170n  
 Becker, L. E., 24  
 Becker, M., 428  
 Bédard, J., 259, 408, 418  
 Beeman, M., 408  
 Beeman, M. J., 20, 21  
 Beer, J. M., 455  
 Beery, R. M., 480  
 Behr, M., 390  
 Behrmann, M., 197, 224  
 Beilock, S. L., 198, 199, 209, 217, 268, 452, 453  
 Beitzel, B. D., 197, 369  
 Bekker, M. J., 97  
 Belenky, M., 377  
 Bellfiore, P. J., 75, 132, 134, 135, 384, 386  
 Bell, M. A., 22  
 Bell, N., 309  
 Bell, P., 335  
 Bellezza, F. S., 167  
 Bellinger, D. C., 24  
 Bem, S. L., 122  
 Bembenutty, H., 129, 356, 445, 446  
 Benbow, C. P., 225  
 Bendixen, L. D., 335, 375, 376, 379, 380, 386, 409, 453  
 Benes, F. M., 24, 449n  
 Benjet, C., 61  
 Benner, A. D., 453  
 Bennett, P. J., 162  
 Bennett, R. E., 206  
 Bennett, R. T., 373  
 Ben-Shakhar, G., 487  
 Benson, C., 98  
 Benton, D., 24  
 Benton, S. L., 207, 325, 360, 362, 363  
 Benware, C., 326, 440  
 Ben-Yehudah, G., 169  
 Ben-Zeev, T., 454  
 Berardi-Coletta, B., 410  
 Bereiter, C., 156, 325, 336, 347, 349, 354, 374, 380, 396, 420  
 Berg, C. A., 404  
 Berger, R., 342  
 Bergin, D. A., 396, 427, 492  
 Berglas, S., 436  
 Bergman, E. T., 279  
 Berk, L. E., 316  
 Berkeley, S., 496  
 Berkowitz, L., 82, 431  
 Berlia, N., 442  
 Berliner, D. C., 102, 108  
 Berlyne, D. E., 182, 432  
 Berman, M. G., 164, 176, 191, 357  
 Berndorff, D., 492  
 Berndt, T. J., 443  
 Bernieri, F., 438  
 Berninger, V. W., 210  
 Bernstein, D. M., 273  
 Bernstein, J. H., 168  
 Berntsen, D., 266, 278, 449  
 Berridge, K. C., 450  
 Bersh, P. J., 53–54  
 Berthelot, J., 381  
 Berthold, K., 410  
 Berti, A. E., 211  
 Besner, D., 235  
 Bessenoff, G. R., 206  
 Best, R. M., 241, 242  
 Bettle, J., 493  
 Beyer, B. K., 421  
 Beylin, A., 28  
 Bhatt, R. S., 146, 236  
 Bialystok, E., 25  
 Bica, L. A., 204, 252  
 Biddlecomb, B., 199, 335, 414, 416  
 Bidell, T., 302, 303–304  
 Bielaczyc, K., 347, 348  
 Biemiller, A., 215, 326, 345, 346  
 Biezuner, S., 335  
 Biggs, J., 383  
 Bigler, R. S., 474  
 Bilalic, M., 407  
 Bill, V. L., 417  
 Bilodeau, I. M., 417  
 Binder, L. M., 86  
 Birch, D., 444  
 Birch, H. G., 405  
 Birdsong, D., 25  
 Birnbaum, J. C., 210  
 Bisanz, J., 210, 308  
 Bivens, J. A., 316  
 Bjork, R. A., 191, 208, 218, 238, 242, 269, 356, 365, 397, 398  
 Bjorklund, D. F., 154, 173, 314, 373, 375  
 Black, J. B., 195, 244  
 Black, J. E., 26  
 Blackwell, L. S., 381, 478, 480, 496  
 Blaisdell, A. P., 247  
 Blanchard, F. A., 122  
 Blanchette, I., 448  
 Blaser, E., 161  
 Blaser, S., 24  
 Blatt, S. J., 467  
 Blattner, J. E., 96  
 Blazevski, J. L., 488  
 Bleiker, C., 305  
 Block, J. H., 107  
 Blok, H., 106  
 Bloom, B. S., 103, 104, 106, 283  
 Bloom, L., 30  
 Bloom, P., 240  
 Blouin, A. M., 35  
 Blumenfeld, P. C., 333, 342, 427, 471  
 Boccia, M. L., 7  
 Bodrova, E., 358  
 Body, S., 67  
 Boe, J. L., 468n  
 Boekaerts, M., 473, 475, 484  
 Boelter, E. W., 56, 82  
 Boggiano, A. K., 428, 434, 437, 438  
 Bohanon, H., 62  
 Bohn, C. M., 62, 182, 458  
 Boiler, K., 35  
 Boire, M., 200  
 Bol, L., 335, 365  
 Boldrin, A., 256, 378  
 Bolger, A., 201  
 Bong, M., 128, 139, 436, 471, 472, 497  
 Bono, K. L., 436  
 Booth, J. R., 20  
 Booth, S., 155, 376  
 Booth-LaForce, C., 206  
 Borkowski, J. G., 374, 382, 479, 481  
 Born, D. G., 108  
 Born, J., 28, 199  
 Borrero, J. C., 98  
 Bortfeld, H., 25  
 Bosker, R. J., 495  
 Bostrow, D. E., 106  
 Botella, C., 44  
 Bouchard, L., 379  
 Bouchey, H. A., 119  
 Boudah, D. J., 340  
 Bourbeau, P. E., 95  
 Bourg, T., 332, 463  
 Bourne, L. E., Jr., 237, 242, 269, 407  
 Bousfield, W. A., 151  
 Bouton, M. E., 39, 41, 43, 270n  
 Bowen, G. M., 324  
 Bower, G. H., 53, 54, 171, 193, 194, 195, 196, 231, 244, 269, 354, 368, 371, 372, 448, 449, 449n

- Bower, J. E., 441  
 Bower, T. G. R., 237  
 Bowers, F. E., 54  
 Bowers, J. S., 235  
 Bowman, K., 270  
 Bowman, L. G., 83  
 Boyanton, D., 78, 91  
 Boyatzis, R. E., 442, 443  
 Boyd, J. S., 300  
 Boyer, E., 122  
 Boyes-Braem, P., 243  
 Boyle, R. A., 255, 427  
 Braaksma, M. A. H., 122, 123  
 Bracken, B. A., 119, 459  
 Bradley, L., 182, 498  
 Bradshaw, C. M., 67  
 Bradshaw, C. P., 96  
 Brady, M. P., 74  
 Brady, T. F., 197  
 Brainerd, C. J., 146n, 227, 270, 272, 273, 276, 278, 279, 300, 301, 320  
 Braisby, N., 241  
 Bransford, J. D., 153, 154, 179, 192, 194, 195, 196, 334, 396, 398, 416, 419, 420  
 Branthwaite, A., 213  
 Bråten, I., 364  
 Bray, N. W., 383  
 Brayboy, B. M. J., 127n, 285  
 Breinlinger, K., 27  
 Breitmyer, B. B., 162  
 Brendgen, M., 61  
 Brenner, M. E., 419  
 Brent, H. P., 25  
 Bressler, S. L., 21  
 Brett, C., 349  
 Brewer, W. F., 244, 245n, 248, 249, 252, 271  
 Brickman, S. J., 466, 493  
 Briggs, L. J., 152  
 Brindle, M., 493  
 Britner, S. L., 453  
 Britton, B. K., 195, 248  
 Broadbent, D. E., 165  
 Broadhurst, P. L., 450  
 Brobst, K. E., 360  
 Broekkamp, H., 363  
 Bromage, B., 215  
 Bronfenbrenner, U., 30  
 Bronson, M. B., 357  
 Brooke, R. R., 85  
 Brookhart, S. M., 101, 102, 460  
 Brooks, D. M., 74  
 Brooks, L. W., 390, 397  
 Brooks-Gunn, J., 30  
 Brophy, J. E., 81, 103, 109, 182, 211, 249, 262, 281, 283, 348, 384, 414, 428, 456, 458, 460, 465n, 471, 472, 473, 490, 492, 493, 495, 496, 497, 498  
 Brothers, K. J., 84  
 Brown, A., 265, 364  
 Brown, A. L., 338, 340, 346, 347, 354, 355, 363, 364, 412  
 Brown, B., 474  
 Brown, B. B., 441  
 Brown, B. L., 122, 125, 217  
 Brown, D. E., 204, 212, 214, 245, 258  
 Brown, D. R., 497  
 Brown, E., 27  
 Brown, E. R., 474  
 Brown, I., 487  
 Brown, J., 270  
 Brown, J. S., 324, 325, 331, 384, 395, 419  
 Brown, K. W., 102  
 Brown, M. C., 308  
 Brown, R., 33, 213, 265, 363, 384  
 Brown, R. P., 455  
 Brown, S. I., 416  
 Brown, W. H., 74  
 Brownell, C. A., 328  
 Bruder, J., 162  
 Bruer, J. T., 22, 23, 25, 26, 29, 30  
 Brunel, L., 180  
 Bruner, J., 141  
 Bruner, J. S., 141, 211, 216, 239, 261, 323  
 Bruning, R. H., 336, 378  
 Brunstein, J. C., 331, 345, 427, 475  
 Brush, D., 146  
 Bryan, J. H., 124  
 Bryan, T. S., 448  
 Buchele, K. S., 442  
 Bucher, B. D., 60, 92  
 Buckner, R. L., 222  
 Buehl, M. M., 376, 377, 379  
 Buffalo, E. A., 271  
 Bufford, R. K., 108  
 Bugelski, B. R., 151, 152, 188, 367, 368  
 Buium, N., 178  
 Bukowski, W. M., 61  
 Bulevich, J. B., 272  
 Bulgren, J. A., 213, 372  
 Bullock, M., 301  
 Bunce, D. M., 309  
 Burger, S. F., 248  
 Burgess, K. B., 206  
 Burhans, K. K., 486  
 Burke, J. E., 374, 382  
 Burke, L., 300, 320  
 Burner, K. J., 325  
 Burnett, P., 54, 458  
 Burnett, R. E., 207  
 Burtis, J., 354  
 Burtis, P. J., 374  
 Burton, A. M., 224, 269  
 Burton, J. K., 106  
 Burwell, R. A., 443  
 Buschke, H., 151  
 Buschkuhl, M., 393  
 Bushell, D., Jr., 345  
 Bussey, K., 122  
 Butcher, K. R., 216, 217  
 Butler, A. C., 248, 286  
 Butler, D. L., 357, 379, 381, 387  
 Butler, R., 129, 488, 494, 495  
 Butt, A., 28  
 Butterfield, P., 328  
 Butterworth, G., 324, 395  
 Buyer, L. S., 410  
 Byrne, B. M., 128n  
 Byrnes, D. L., 162  
 Byrnes, J. P., 20, 22, 23, 24, 26, 29, 30, 42n, 223, 248, 276, 310, 363, 436, 481  
 Cabeza, R., 222  
 Cacioppo, J. T., 29, 357, 445, 446, 449-450  
 Cadinu, M., 454  
 Cagigas, X. E., 244  
 Cahan, S., 302  
 Cahill, L., 20, 448  
 Cain, C. K., 35  
 Cain, K., 200  
 Calderone, K. S., 404  
 Calfee, R. C., 141, 182, 209, 211, 269, 334, 337  
 Calin-Jageman, R. J., 415  
 Call, N. A., 76  
 Calvert, C., 377  
 Calvey, I., 197  
 Camare, M., 43  
 Cameron, A. M., 477  
 Cameron, J., 81, 109, 428, 437, 439, 457  
 Cammilleri, A. P., 75  
 Camos, V., 200  
 Campanella, J., 42  
 Campbell, K. L., 276  
 Campbell, R. A., 59, 90  
 Campbell, T., 411  
 Campillo, M., 409  
 Campione, J. C., 346, 347  
 Campo, P., 179  
 Campos, J. J., 328  
 Cann, A., 270  
 Cannon, J., 300  
 Cao, L., 387, 470, 473  
 Caplovitz, A. G., 123  
 Capodilupo, A., 304  
 Capon, N., 420  
 Caprara, G. V., 128  
 Cardelle-Elawar, M., 417  
 Carey, R. G., 60, 92  
 Carey, S., 238, 251  
 Carlin, A., 44  
 Carlson, N. R., 24  
 Carlson, R., 216  
 Carlson, S. M., 168, 171  
 Carlyon, W. D., 54  
 Carmichael, C. A., 242  
 Carmichael, L., 197, 198, 228, 270  
 Carnagey, N. L., 123  
 Carney, R. N., 215, 217, 250, 368, 369, 370  
 Carpenter, M., 300, 327  
 Carpenter, P. A., 382  
 Carpenter, S. K., 208, 283, 286  
 Carpenter, T. P., 409  
 Carper, L. B., 83  
 Carr, J. E., 401, 484  
 Carr, M., 484  
 Carr, T. H., 198, 199, 209, 217, 452, 453  
 Carraher, D. W., 301, 302, 331, 454  
 Carraher, T. N., 331  
 Carrasco, M., 448  
 Carrasco, R. L., 495  
 Carroll, D. J., 300  
 Carroll, J. B., 106  
 Carroll, M., 274  
 Carta, J. J., 344  
 Carter, C. S., 168n  
 Carter, M., 74  
 Carter, R., 450, 454  
 Carter, S. M., 464  
 Cartledge, G., 182  
 Caruso, M., 93, 94  
 Carver, C. S., 448, 487  
 Carver, L. J., 29  
 Carver, R. P., 190  
 Casasanto, D., 226  
 Case, R., 302, 303, 304, 305, 306, 311  
 Cashon, C. H., 300, 302  
 Cassady, J. C., 44, 45, 452, 453, 454, 458, 460, 473, 489  
 Castagno, A. E., 127n, 285  
 Castaneda, A., 287  
 Castell, A. D., 208  
 Castro, R., 486  
 Castro-Caldas, A., 24  
 Catania, A. C., 69, 70  
 Catrambone, R., 415  
 Catsambis, S., 497  
 Cauley, K. M., 137, 459  
 Cavanagh, P., 168  
 Cazden, C. B., 348  
 Ceci, S. J., 272, 275, 392, 396, 397, 398  
 Cepeda, N. J., 208, 283, 286  
 Cermak, L. S., 7, 177, 223  
 Certo, J. L., 137, 459  
 Cerullo, F., 206

- Chaase, M. A., 82  
 Chabey, R. W., 345  
 Chabrán, M., 103, 454  
 Chafin, C., 137, 459  
 Chaiken, S., 257  
 Chalmers, D. J., 30  
 Chamberlain, A., 341  
 Chambers, D., 197, 225  
 Chambliss, M. J., 211, 252, 253  
 Champagne, A. B., 253, 309  
 Chan, C., 354, 378, 386  
 Chan, C. K. K., 374  
 Chan, J. C. K., 272  
 Chan, W.-C., 182, 362  
 Chand, I., 411  
 Chandler, M., 376  
 Chandler, P., 216  
 Chang, B., 486  
 Chang, M.-L., 483  
 Chao, C. I., 360  
 Chapell, M. S., 454  
 Chapman, M., 124, 293, 300, 301, 302  
 Chapman, S., 366  
 Charman, S. D., 275  
 Charness, N., 198  
 Chase, P. N., 416  
 Chase, S. K., 436  
 Chatzisarantis, N. L. D., 437  
 Chen, C., 129  
 Chen, J., 129, 130  
 Chen, J. A., 379, 478, 480  
 Chen, L. H., 470, 471  
 Chen, S., 257  
 Chen, T.-H., 182, 362  
 Chen, Z., 168, 301, 348, 397, 411, 416  
 Cheng, P. W., 209  
 Cherlin, D. L., 182  
 Cherry, E. C., 165  
 Cheung, M., 456  
 Cheyne, J. A., 91  
 Chi, M. T. H., 202, 207, 215, 217, 231, 244, 248, 249, 255, 256, 259, 326, 344, 345, 404, 408, 411, 418  
 Chiang, W., 247  
 Chiarello, C., 20, 21  
 Chiesi, H. L., 202  
 Child, D. A., 383  
 Chin, C. A., 248  
 Chin, R., 477, 484  
 Chinn, C. A., 252, 256, 333, 335, 420, 423  
 Chinnappan, M., 408  
 Chipman, S. F., 454  
 Chipperfield, J. C., 441  
 Chipperfield, J. G., 441  
 Chirkov, V. I., 472  
 Chiu, C.-Y., 227  
 Chizhik, A. W., 341  
 Cho, B.-Y., 354, 355n, 385  
 Chomsky, N., 27, 141, 224  
 Chouinard, M. M., 309, 464  
 Christ, S. E., 163  
 Christensen, A., 482  
 Christiaansen, R. E., 279  
 Christie, J. F., 415  
 Christmann, U., 215  
 Christopherson, H., 307  
 Christou, C., 171  
 Chung, M., 497  
 Church, M. A., 213, 471, 472  
 Church, R. M., 33  
 Ciani, K. D., 130  
 Cimpian, A., 482  
 Cizek, G. J., 92  
 Clancey, W. J., 156  
 Clani, K. D., 456, 457, 494  
 Clark, A.-M., 331, 335, 337  
 Clark, D. B., 252, 255, 258  
 Clark, D. C., 242  
 Clark, E. K., 474  
 Clark, J. M., 197, 225n, 227  
 Clark, M., 98  
 Clark, M. C., 194, 372  
 Clark, R. A., 443-444  
 Clark, R. E., 107, 128, 176, 415  
 Clarke, H. F., 16  
 Clayton, M. C., 74  
 Clayton, N. S., 7, 315n  
 Cleary, T., 131, 199  
 Clement, C., 302  
 Clement, J., 250, 255  
 Clement, P. W., 97  
 Clemente, R. A., 373  
 Clements, D. H., 301, 308  
 Clifford, M. M., 498  
 Clinchy, B., 377  
 Clore, G. L., 443, 449  
 Close, D., 59  
 Close, D. E., 95  
 Coates, B., 125  
 Cobb, P., 336, 337, 452, 473  
 Cocchiarella, M. J., 241, 242, 243  
 Cochran, K. C., 359  
 Cofer, C., 150  
 Coffman, J. L., 353  
 Cognition and Technology Group at Vanderbilt, 420  
 Cohen, D., 27  
 Cohen, E. G., 336, 341, 342, 344  
 Cohen, G., 276  
 Cohen, G. D., 24  
 Cohen, G. L., 253, 257, 435  
 Cohen, L. B., 300, 302  
 Cohen, P. A., 106, 108  
 Cohen, R. L., 125, 126  
 Colavecchia, B., 59  
 Colbert, J., 69  
 Cole, D. A., 436  
 Cole, M., 28, 244, 251, 302, 313-314, 315, 315n  
 Coleman, M., 135  
 Collie, R., 280  
 Collier, G., 67  
 Collins, A., 286, 287, 323, 324, 324n, 325, 331, 347, 348, 384, 395, 419  
 Collins, A. M., 179, 196, 229, 230, 231, 267, 268, 332  
 Collins, J., 97  
 Coltheart, M., 161  
 Colwill, R. M., 75  
 Coman, A., 273  
 Combs, A. W., 452  
 Comfort, C., 459  
 Conant, F. R., 347, 348  
 Conboy, B. T., 26  
 Conklin, C. A., 42  
 Conklin, H. M., 24, 168  
 Connell, J. P., 129, 434, 441, 442, 490  
 Conoley, J. C., 344, 346  
 Conrad, N. J., 390  
 Conrad, R., 169  
 Conrey, F. R., 252, 331  
 Conway, M. A., 197  
 Conyers, C., 58, 60, 88  
 Cook, R. G., 237, 238  
 Cook, S. W., 226  
 Cooney, J. B., 169, 377, 404, 414  
 Cooper, C. M., 279  
 Cooper, G., 403  
 Cooper, H., 62, 129, 438  
 Cooper, L. A., 170  
 Copeland, S. M., 244, 279  
 Coplan, R. J., 357  
 Corbett, H. D., 286, 381  
 Corkill, A. J., 215, 276, 379  
 Cormier, S. M., 395, 396, 397, 398  
 Corno, L., 62, 109, 357, 495, 498  
 Cornoldi, C., 356n, 380, 384  
 Corpus, J. H., 428, 429  
 Costich, C. M., 382  
 Cothern, N. B., 197  
 Cottrell, J. E., 204, 249, 252, 253  
 Coulson, S. L., 436  
 Covington, M. V., 109, 435, 436, 444, 453, 457, 460, 472, 475, 480, 488, 497  
 Cowan, N., 161, 162, 163, 166, 167, 168, 169, 171, 173, 183  
 Cowan, P. A., 61  
 Cowdery, G. E., 87  
 Cox, B. D., 398, 415  
 Cox, M. G., 74  
 Cox, P. D., 131  
 Coyle, T. R., 173  
 Craft, M. A., 85  
 Craik, F. I. M., 7, 163, 164, 177, 179, 191, 192, 193  
 Craik, K. H., 141  
 Cranston, S. S., 59, 90  
 Craven, J., 300, 320  
 Craven, R. G., 128n  
 Crawley, A. M., 419  
 Créde, M., 382  
 Crespi, L. P., 76, 430  
 Crick, N. R., 206  
 Critchfield, T. S., 52, 69, 87  
 Crocker, J., 436  
 Crofts, H. S., 16  
 Crombez, G., 38  
 Cromley, J. G., 200, 201, 354  
 Crone, D. A., 94  
 Crone, E. A., 169  
 Crone-Todd, D. E., 108  
 Croninger, R. G., 215  
 Crosbie, J., 106  
 Crouter, A. C., 491  
 Crowder, N. A., 105  
 Crowder, R. G., 148, 162, 175, 190  
 Crowley, E., 381  
 Crowley, K., 321, 410  
 Crowne, D. P., 443  
 Crown, H. M., 378, 445, 445n, 446, 456, 470  
 Crumbaugh, C., 337, 375, 419  
 Crystal, J. D., 354n  
 Csikszentmihalyi, M., 428, 429, 448, 452, 464, 497  
 Cummings, A., 86  
 Cunitz, A. R., 175  
 Cunningham, A. E., 486  
 Curtis, K. A., 479  
 Curtiss, S., 25  
 Cushing, L. S., 346  
 Cuvo, A. J., 192  
 Dabholkar, A. S., 23  
 Dack, C., 70  
 Dahan, D., 162  
 Dahlin, B., 377  
 Dai, D. Y., 445, 446, 448  
 d'Ailly, H., 437  
 Daley, S. G., 303, 304  
 Dallett, K. M., 152  
 Dalley, J. W., 16  
 Damasio, A. R., 20, 447, 448  
 D'Amato, M. R., 54  
 Damisch, L., 63n  
 Daneman, M., 200  
 Daniels, D., 437, 465  
 Daniels, L. M., 181, 432, 457, 469, 471, 497  
 Daniels, S., 377, 423  
 Danner, F., 471



- Dansereau, D. F., 215, 243, 244, 245, 342, 360, 390, 397  
 d'Apollonia, S., 341  
 Darley, J. M., 206  
 Darling-Hammond, L., 211, 286, 334, 420, 440  
 Darnon, C., 470  
 Darwin, C. J., 162  
 Daugherty, M., 154  
 Davachi, L., 29, 175, 222, 266, 276  
 David, B. J., 122  
 Davidson, A. L., 453  
 Davidson, J. E., 408  
 Davidson, W. S., 95  
 Davies, C., 332  
 Davis, A., 384  
 Davis, A. C., 168  
 Davis, C. A., 74  
 Davis, C. L., 458  
 Davis, G. A., 61, 401  
 Davis, H., 298n  
 Davis, H. A., 442, 443, 457, 483  
 Davis, L. E., 480  
 Davis, L. L., 182  
 Davis, M. L., 108  
 Davis-Kean, P. E., 129, 465  
 Day, J. D., 364  
 Day, W. H., 437  
 deBaca, P. C., 55  
 DeBacker, T. K., 378, 445, 445n, 446, 456, 470  
 De Bock, D., 300  
 de Boer, H., 495  
 DeBoer, T., 22, 199  
 de Bruin, A., 207  
 Debus, R. L., 128n, 435, 497  
 DeCasper, A. J., 279  
 deCharms, R., 437  
 Deci, E. L., 81, 326, 434, 436, 437, 438, 439, 440, 441, 456, 457, 458, 477, 490, 491, 496, 498  
 De Clerq, A., 417  
 De Corte, E., 249, 325, 376, 396, 404, 409, 413, 416  
 Dee-Lucas, D., 213  
 Deering, P. D., 343, 344  
 de Gloppe, K., 242  
 DeGrandpre, R. J., 33  
 de Haan, M., 22, 223, 280  
 de Jong, T., 308  
 de Koning, E., 473  
 Delaney, H. D., 369  
 Delaney, P. F., 181  
 Delclos, V. R., 408  
 de Leeuw, N., 207, 215, 217, 256  
 Delgado-Gaitan, C., 423  
 De Lisi, R., 309  
 DeLoache, J. S., 227  
 Delorenzi, A., 146n  
 Delval, J., 249  
 De Marco, R. J., 75  
 Demastes, J., 257  
 Demetriou, A., 171, 383  
 Dempster, F. N., 23, 208, 209, 276, 286, 371, 460  
 DeNike, L. D., 116  
 DeNisi, A., 208, 493  
 Dennen, V. P., 325  
 Dennison, R., 360  
 Derbish, M. H., 283  
 Derry, S. J., 156, 207, 243, 253, 336, 348, 412, 423, 459  
 Deshler, D. D., 213, 372  
 Desoete, A., 417  
 D'Esposito, M., 168n  
 Deur, J. L., 91  
 Deutsch, A., 414  
 Deutsch, M., 337, 342  
 Devine, J. V., 55  
 DeVries, R., 241  
 deWaal, F. B. M., 7  
 Dewey, J., 6  
 Dewhurst, S. A., 197  
 Diamond, A., 318  
 Diamond, M., 22, 23  
 Diamond, M. E., 169  
 Dias, M. G. B. B., 302  
 Diaz, R. M., 133n  
 DiCamillo, M., 407  
 DiCintio, M., 438, 491  
 Dickerson, C., 62  
 Dickhäuser, O., 484  
 Diekmann, A. B., 474  
 Diener, E., 447  
 Diesendruck, G., 240  
 Dietz, F., 357  
 Dijksterhuis, A., 177, 408  
 Dijkstra, P., 130  
 Dillon, C. L., 465  
 Dillon, C. M., 123  
 DiMartino, J., 287  
 Dinella, L. M., 427  
 Dinges, D. F., 278  
 Dirix, C. E. H., 279  
 diSessa, A. A., 248, 249, 253, 255, 300, 309, 356n, 376, 380  
 Di Vesta, F. J., 150, 213, 215, 360, 362, 392, 397  
 Dix, T., 437  
 Dixon, F. A., 139, 467  
 Dixon, J. A., 252  
 Dixon, M. R., 86  
 Do, S. L., 336  
 Dobbins, I. G., 29, 222, 266, 276  
 Dochy, F., 420  
 Dockrell, J. E., 241  
 Dodge, K. A., 206, 475  
 Dodge, T., 332  
 Dodson, J. D., 450, 451  
 Doherty, M., 301  
 Doidge, N., 21  
 Dole, J. A., 205, 213, 354, 363, 365, 381, 383, 384  
 Dolezal, D. N., 56  
 Dollard, J. C., 6, 112, 113, 431  
 Dominowski, R. L., 217, 242, 269, 407, 408, 410  
 Donahoe, J., 53  
 Donaldson, M., 300  
 Donely, J., 212  
 Donlosky, J., 366  
 Donnelly, C. M., 213  
 Donohew, L., 432  
 Doob, L., 431  
 Dooling, D. J., 279  
 Dorris, M., 24  
 Dotterer, A. M., 491  
 Doumas, L. A. A., 235  
 Doupe, A., 25  
 Dowaliby, F. J., 109  
 Downey, J., 138  
 Downing, P. E., 167  
 Downs, R. M., 144  
 Dowson, M., 441, 447, 453, 473, 474  
 Doyle, W., 61, 99, 182, 415, 441  
 Doyle-Nichols, A., 287  
 Draganski, B., 24  
 Dreikurs, R., 59  
 Dressel, S., 176  
 Drevno, G. E., 44  
 Drew, H. A., 93n  
 Drews, F. A., 167  
 Driscoll, C., 74  
 Driscoll, M. P., 183  
 Drivdahl, S. B., 275  
 Driver, R., 253  
 Drouhard, B., 446  
 Drum, P. A., 390  
 Drummey, A. B., 280  
 DuBois, D. L., 129  
 Dubois-Gerchak, K., 135, 217  
 Duchon, A., 144  
 Duckworth, A. L., 356  
 Duda, J. L., 437  
 Dueck, A., 193  
 Duell, O. K., 285n, 376  
 Duffy, G. G., 205, 354  
 Dufrense, A., 374  
 Duguid, P., 331, 395  
 Duit, R., 213  
 DuNann, D. G., 108  
 Duncan, R. G., 333, 420  
 Duncker, K., 405, 406  
 Dungan, D. E., 139, 467  
 Dunkle, M. E., 376, 409  
 Dunlap, G., 94, 438  
 Dunlap, K., 337  
 Dunlosky, J., 154, 364, 365, 366, 374, 380, 386, 387  
 Dunn, C. S., 242  
 Dunn, R., 54  
 Dunning, D., 139, 365, 374  
 DuPaul, G., 135  
 DuPaul, G. J., 60, 182, 346  
 Duperyat, C., 468  
 Durik, A. M., 463, 464, 465  
 DuRussel, L. A., 336  
 Dutta, A., 208, 259  
 Dutton, S., 415  
 Dweck, C. S., 379, 381, 436, 443, 456, 465, 468, 470, 472, 477, 478, 479, 480, 481, 482, 483n, 484, 485, 486, 487, 488, 494, 495, 496, 498  
 Eacott, M. J., 222n, 280, 321  
 Eagly, A. H., 257  
 Early, S., 107  
 Easter, M., 377, 378  
 Easter, M. A., 130  
 Eastwood, J. D., 164, 327  
 Eaton, J. F., 204  
 Ebbesen, E. B., 176  
 Ebeling, B. J., 106  
 Eccles, J. S., 84, 128, 139, 436, 441, 442, 443, 445, 474, 480, 481, 484, 485, 486, 495  
 Echevarria, M., 256  
 Echols, K., 412  
 Ecott, C. L., 87  
 Edelson, D. C., 332, 333  
 Edens, K. M., 197, 216  
 Edmonds, M. S., 383  
 Edmondson, B., 202  
 Edwards, K., 448  
 Eeds, M., 336  
 Eelen, P., 38, 72  
 Eenshuistra, R., 227  
 Egan, L. C., 241  
 Ehle, C. T., 55  
 Ehrlinger, J., 139  
 Eich, R., 449  
 Eich, T. S., 208  
 Eicher, S. A., 441  
 Eid, M., 447  
 Eifert, G. H., 41  
 Eilam, B., 386  
 Einstein, G., 278  
 Einstein, G. O., 195, 196, 213, 278, 359, 382  
 Eisenband, J., 300  
 Eisenberger, R., 445, 457, 498  
 Eisner, E. W., 234, 260, 416  
 Eitam, B., 467  
 Ekstrand, D. R., 242  
 Elbert, T., 24, 25

- Elby, A., 253, 376  
 Elder, A. D., 376  
 El-Dinary, P. B., 384, 387  
 Elik, N., 261, 492  
 Eliot, E. M., 162  
 Ellenwood, S., 138  
 Elliot, A. J., 213, 464, 468,  
 468n, 470, 471, 472, 473  
 Elliot, D. J., 324  
 Elliot, E. S., 465, 472, 498  
 Elliott, J., 169, 466  
 Elliott, R., 124  
 Ellis, H. C., 243  
 Ellis, J., 91  
 Ellis, J. A., 108, 215, 269,  
 275, 326  
 Ellis, N. C., 224  
 Ellis, P., 325  
 Ellis, S., 336, 496  
 Embry, D., 96, 109  
 Emde, R. N., 328  
 Emery, N. J., 7, 315n  
 Emmer, E. T., 74, 422  
 Emmorey, K., 265  
 Empson, S. B., 300  
 Emshoff, J. G., 95  
 Engle, R. A., 347, 348, 396,  
 399, 400n, 404, 415  
 Engle, R. W., 154, 171,  
 402  
 Englehart, M. B., 103, 104,  
 283  
 English, H. B., 152  
 English, L. D., 411, 412  
 Epel, E., 441  
 Epstein, H., 293  
 Epstein, J. L., 498, 499  
 Epstein, R., 34, 50, 211  
 Epstein, T., 251  
 Erdelyi, M. H., 278  
 Ericsson, K. A., 198  
 Erikson, F., 285  
 Erikson, L. G., 364  
 Erlebacher, A. H., 152  
 Ertner, P. A., 214  
 Ervin, R. A., 346  
 Esbensen, B. M., 373  
 Escribe, C., 468  
 Esmonde, I., 341, 342, 348  
 Ester, E. F., 169  
 Esterberg, M., 16  
 Estes, D., 376  
 Estes, W. K., 33  
 Etkina, E., 384  
 Evans, E. M., 204, 251,  
 254, 256  
 Everett-Cacopardo, H., 355  
 Everitt, B. J., 28  
 Everson, H. T., 473  
 Evertson, C. M., 78  
 Eylon, B., 341, 376  
 Eysenck, M. W., 176,  
 206, 276
- Facione, P. A., 445  
 Fagen, J. W., 76  
 Fahrmeier, E. D., 302  
 Falik, L., 327  
 Falk, E. B., 226, 331  
 Falk, K., 75, 456  
 Fantino, E., 54  
 Fantuzzo, J. W., 97, 135,  
 341, 342  
 Farah, M. J., 168n  
 Farivar, S., 342, 343  
 Farley, F., 52  
 Farr, M. J., 404  
 Farran, D. C., 30  
 Farrar, M. J., 245  
 Fashola, O. S., 390  
 Faust, G. W., 7, 163  
 Fazio, R. H., 37, 40  
 Feather, N. T., 84, 443, 444,  
 465  
 Feinberg, M., 253, 257  
 Feinman, S., 328  
 Feinstein, J. A., 445  
 Feldman, J., 241  
 Feldman, J. F., 237  
 Feldon, D., 450  
 Feldon, D. E., 107  
 Felton, M., 257, 336  
 Feltz, D. L., 82, 199  
 Fenning, P. A., 62  
 Ferguson, E. L., 207  
 Fernald, A., 122  
 Ferrari, M., 261, 492  
 Ferreri, S. J., 335  
 Ferretti, R. P., 423  
 Ferro, J., 438  
 Ferster, C. B., 67  
 Féry, Y.-A., 198  
 Feucht, F. C., 379  
 Feuerstein, R., 327  
 Fiedler, K., 320  
 Field, D., 301  
 Field, T. F., 27  
 Fiez, J. A., 169, 170n  
 Finchman, F. D., 487  
 Finger, K., 273  
 Finke, R. A., 493  
 Finkel, E. J., 132  
 Finney, S. J., 201, 470  
 Finstad, K., 463  
 Fischer, F., 357, 488  
 Fischer, K. W., 302, 303–304,  
 483  
 Fisher, A. V., 261  
 Fisher, R. P., 286, 420  
 Fisher, W. W., 83, 84, 98  
 Fiske, A. P., 441, 467, 474  
 Fiske, D. W., 450  
 Fiske, S. T., 441, 467, 474  
 Fitzsimmons, G. M., 132  
 Fitzsimmons, S., 91  
 Fivush, R., 207, 274, 280,  
 321, 328, 329, 332
- Fixsen, D. L., 60  
 Flaherty, C. F., 42, 76  
 Flavell, E. R., 373  
 Flavell, J. H., 227, 245, 290,  
 295n, 300, 302, 373, 374,  
 375  
 Flege, J. E., 25  
 Fleming, J. S., 455  
 Fleming, R. K., 217  
 Flender, J., 215  
 Fletcher, K. L., 383, 453,  
 458, 473, 489  
 Fletcher-Flinn, C. M., 106  
 Flieller, A., 301, 302  
 Flink, C., 428  
 Flood, A. L., 51  
 Flood, W. A., 51, 54  
 Flor, H., 40, 43  
 Flower, L. S., 210  
 Flowerday, T., 456, 464  
 Flum, H., 307, 446, 455, 471  
 Flynn, M., 443  
 Fogel, V., 122  
 Foley, M. A., 273  
 Foo, P., 144  
 Foorman, B. R., 21, 176, 235  
 Foos, P. W., 286, 420  
 Foote, A. L., 354n  
 Ford, M. E., 441, 465, 467,  
 474  
 Forgas, J. P., 446n, 449, 449n  
 Forget, J., 208  
 Försterling, F., 129  
 Forsyth, J. P., 41  
 Forte, E., 103  
 Foster-Johnson, L., 438  
 Foundopolous, M., 59, 90  
 Fournier, J. S., 204, 252  
 Fowler, J. W., 496  
 Fowler, S. A., 86  
 Fox, E., 201, 354, 355  
 Fox, E. J., 107, 108  
 Fox, J., 74  
 Fox, J. J., 74  
 Fox, N. A., 224, 280  
 Fox, P. W., 286  
 Foux, R. M., 59  
 Franco, G. M., 196, 359,  
 378, 379, 423, 471  
 Frankel, F., 88  
 Frankiewicz, R., 215  
 Franklin, S., 31, 301, 302,  
 422, 445  
 Franks, J. J., 153, 154, 179,  
 194, 419  
 Frazier, B. N., 464  
 Frecker, K., 349  
 Frederiksen, J., 308, 385  
 Frederiksen, J. R., 286, 287  
 Frederiksen, N., 286, 414,  
 415, 417, 418, 460  
 Fredricks, J. A., 427, 458,  
 471, 497
- Fredrickson, B., 449  
 Freebern, G., 363  
 Freeman, B., 445, 446, 493  
 Freeman, K. E., 472  
 French, E. G., 443, 444  
 Frensch, P. A., 177, 223, 396,  
 415, 417, 420  
 Frenzel, A. C., 447, 453, 455  
 Frese, M., 218  
 Freud, S., 278, 429  
 Freund, L., 329  
 Friedel, J., 495  
 Friedman, C. K., 121, 122  
 Friedman, N. P., 168  
 Friedrich, L. K., 124  
 Friedrichs, A. G., 373  
 Fries, S., 357  
 Friesen, C. K., 164, 327  
 Friman, P. C., 54, 84  
 Frith, U., 205  
 Frost, J. L., 74  
 Fry, A. F., 52, 86, 169  
 Frye, D., 168  
 Fu, G., 423  
 Fuchs, D., 326, 345, 346  
 Fuchs, L. S., 326, 327, 345,  
 403, 415, 417  
 Fuego, V., 345  
 Fujimura, N., 301  
 Fulkink, R. G., 242  
 Fuligni, A. J., 468n  
 Fuller, F., 210  
 Fuller, M. L., 83  
 Fung, H., 328  
 Furlong, M. J., 432  
 Furness, T. A., III, 44  
 Furnham, A., 251  
 Furrer, C., 437, 442  
 Furst, E. J., 103, 104, 283  
 Fuson, K. C., 413
- Gable, R. K., 491  
 Gable, S. L., 213, 471  
 Gabriele, A. J., 470  
 Gabrieli, J. D. E., 223  
 Gagné, E. D., 182, 194, 226,  
 232  
 Gagné, F., 208  
 Gagné, R. M., 183, 208, 210,  
 241, 242  
 Galanter, E., 368  
 Galinsky, A. D., 408  
 Gallimore, R., 323  
 Gallini, J., 473  
 Gallistel, C. R., 38  
 Gallo, D. A., 273  
 Gamas, W. S., 256  
 Gamoran, A., 331  
 Ganz, L., 162  
 Garb, J. L., 37  
 Garcia, J., 38  
 Garcia, S. M., 496  
 García-Mira, R., 144

- Garcia-Palacios, A., 44  
 Gardner, A. W., 56, 82  
 Gardner, H., 30, 249  
 Gardner, M., 404  
 Gariglietti, G., 377  
 Garner, R., 213, 253, 363, 473  
 Garry, M., 216, 273  
 Garvin, E., 449  
 Gaskins, S., 324  
 Gasper, K., 449  
 Gasper, K. L., 108  
 Gathercole, S. E., 169, 173, 192, 374  
 Gaudry, E., 460  
 Gauvain, M., 156, 164, 274, 320, 321, 326, 327, 328, 329, 333  
 Gava, M., 256, 378  
 Gayford, C., 341  
 Gaynor, J., 460  
 Gear, A., 439  
 Geary, D. C., 409, 411, 416, 464, 476  
 Geckeler, A. S., 98, 457  
 Gee, C. L., 481  
 Gehlbach, H., 131, 348, 459  
 Geiger, K. B., 123  
 Geller, E. S., 74  
 Gelman, S. A., 239, 241, 243, 245, 246, 247, 262, 464  
 Gentile, J. R., 106, 109  
 Gentry, M., 491  
 Geraerts, E., 278  
 Gerjets, P., 415, 416  
 Gerrie, M. P., 216, 273  
 Gershkoff-Stowe, L., 240  
 Gershoff, E. T., 437  
 Gerst, M. S., 125  
 Gertzog, W. A., 256  
 Geske, J. A., 201, 470  
 Ghatala, E. S., 382, 385  
 Ghazarian, S. R., 495  
 Gheen, M. H., 436, 494  
 Ghatti, S., 273, 274  
 Ghezzi, P. M., 86  
 Giaconia, R. M., 285  
 Giancarlo, C. A., 445  
 Gibb, R., 24  
 Gibbon, J., 38  
 Gibson, B. S., 167n  
 Gick, M. L., 397, 398, 407, 411, 412, 413  
 Giedd, J. N., 22, 23  
 Gijbels, D., 420  
 Gil, L., 364  
 Gil, M., 75  
 Gilbert, D. T., 435  
 Giles, J. W., 274, 481  
 Gillies, R. M., 342  
 Gillingham, M. G., 213, 363  
 Gilman, R., 432  
 Gilstrap, L. L., 275  
 Gindis, B., 327  
 Ginsburg, H. P., 300, 307  
 Ginsburg-Block, M. D., 341, 342, 344  
 Gipps, C., 130  
 Girotto, V., 302  
 Gladwell, M., 419, 452  
 Glaeser, B., 92, 94  
 Glaessner, B., 128, 212, 448  
 Glanzer, M., 175  
 Glaser, R., 404, 411, 418  
 Glass, A. L., 238, 399  
 Glass, G. V., 256  
 Gleitman, H., 206  
 Glenberg, A., 149, 269  
 Glenberg, A. M., 197, 207, 308  
 Glucksberg, S., 406, 407  
 Glynn, S. M., 215, 248  
 Gobbo, C., 300  
 Gobeil, A., 481  
 Gobet, F., 407  
 Goddard, R. D., 131  
 Godden, D. R., 269  
 Godes, O., 492  
 Goedert-Eschmann, K., 198, 199  
 Goel, V., 20  
 Goetz, E. T., 203, 382, 383, 387, 480  
 Goetz, T., 181, 432, 441, 447, 448, 453, 455, 497  
 Goetz, T. E., 465  
 Gogate, L. J., 163  
 Golbeck, S. L., 309  
 Gold, J. M., 162  
 Goldberger, N. R., 377  
 Goldenberg, C., 496  
 Goldin-Meadow, S., 225, 226  
 Goldknopf, E. J., 197  
 Goldman-Rakic, P. S., 16, 22, 170n  
 Goldsmith, M., 274  
 Goldstein, N. E., 123  
 Goldstone, R. L., 241, 261  
 Golen, S., 497  
 Golinkoff, R. M., 236, 241, 328  
 Gollan, T. H., 265  
 Gollwitzer, P. M., 467  
 Gómez-Ariza, C. J., 277  
 Göncü, A., 320  
 Gonsalves, B., 273  
 Good, C., 470  
 Good, R., III, 106  
 Good, T. L., 81, 83, 333, 341, 358, 387, 456, 475, 495  
 Goodman, C. S., 15, 16  
 Goodman, G. S., 245, 275, 278  
 Goodnow, J., 141, 239  
 Gootman, M. E., 60  
 Gopnik, A., 274  
 Gopnik, M., 27  
 Gordon, B., 287, 420  
 Gordon, C., 201  
 Gordon, W., 302  
 Goshen-Gottstein, Y., 176  
 Gosling, S. D., 141  
 Goss, P. H., 206  
 Goswami, U., 300  
 Gottesman, R. L., 206  
 Gottfried, A. E., 428, 455  
 Gottfried, A. W., 455  
 Gould, E., 28  
 Grabe, M., 182  
 Grace, D. M., 122  
 Grady, C. L., 176  
 Graeber, A. O., 249, 390  
 Graesser, A. C., 154, 195, 196, 346, 354, 364, 380, 385, 403  
 Graf, P., 223  
 Graff, R. B., 98, 457  
 Grafman, J., 29  
 Graham, J., 434  
 Graham, M., 360  
 Graham, S., 123, 210, 358, 453, 455, 478, 479, 480, 483, 484, 486, 493, 495, 496, 497  
 Graham, S. A., 261  
 Gralinski, J. H., 478, 484  
 Grammer, J. K., 353  
 Granade, J. B., 466  
 Grandin, T., 225n  
 Grant, H., 468, 470, 472, 483n  
 Grauvogel-MacAleese, A. N., 54  
 Gravatt, B., 106  
 Gray, J. A., 165  
 Gray, S. G., 360  
 Gray, T. W., 84  
 Gray, W. D., 243, 276, 392  
 Green, B. L., 373  
 Green, C., 278  
 Green, F. L., 373  
 Green, L., 52, 54, 86  
 Greenberg, R., 27  
 Greene, B. A., 210, 245, 465  
 Greene, D., 81  
 Greene, J. A., 357, 376, 377, 379, 382  
 Greene, J. K., 436  
 Greene, R., 175  
 Greene, R. L., 175, 176  
 Greene, S., 207, 364  
 Greene, T. R., 404  
 Greenfield, P. M., 302  
 Greeno, J. A., 357  
 Greeno, J. G., 156, 196, 327, 331, 332, 395, 397, 414  
 Greenough, W. T., 26  
 Greenspoon, J., 417  
 Greenwood, C. R., 344  
 Greer, B., 249, 325, 404  
 Greer, K., 255  
 Greer, R. D., 109  
 Gregg, A. P., 435, 458, 484  
 Gregg, V., 204, 252  
 Gregoire, M., 253, 256  
 Gregory, A., 62  
 Greif, M. L., 247  
 Greiner, J. M., 135  
 Gresalfi, M. S., 459  
 Griesemer, S. M. R., 97, 98  
 Griesinger, T., 436, 471  
 Griffin, B. W., 333  
 Griffin, M. M., 333  
 Griffin, S. A., 304, 305, 311  
 Griffin, T. D., 365  
 Grimes, A., 146  
 Griskevicius, V., 434  
 Groeben, N., 215  
 Grolnick, W. S., 440, 490  
 Groninger, L. D., 368  
 Gronlund, N. E., 101, 102  
 Gross, A. M., 44  
 Gross, J. J., 489  
 Gross, T. F., 407  
 Grossen, M., 309  
 Grossheinrich, N., 162  
 Grosslight, L., 298n  
 Grossman, P. L., 379  
 Großschedl, J., 384  
 Gruber, H., 390  
 Grusec, J. E., 58, 82, 91  
 Guay, F., 491  
 Guberman, S. R., 326  
 Guerra, M. R., 337  
 Guerra, N. G., 123  
 Guerrero, F., 456  
 Guevremont, D. C., 134  
 Guggia, A. E., 256  
 Gülgöz, S., 195  
 Gunnoe, M. L., 61  
 Gunstone, R. F., 253  
 Güntürkün, O., 7  
 Guppy, T. E., 96  
 Guskey, T. R., 107  
 Gustafsson, J., 109  
 Guthrie, E. R., 45  
 Guthrie, J. T., 210, 343  
 Gutierrez, F., 247  
 Gutierrez, T., 207  
 Gutman, L. M., 472  
 Guzzetti, B. J., 256  
 Haas, S. D., 237  
 Haberlandt, K. F., 172  
 Hackenberg, T. D., 53, 53n  
 Hacker, D. J., 154, 335, 340, 354, 356n, 364, 365, 374, 380  
 Haden, C. A., 207, 280, 321, 327, 332

- Hadjioannou, X., 337  
 Haenen, J., 321, 376  
 Haerle, E., 377  
 Haerle, F. C., 375  
 Hagger, M. S., 437  
 Haglund, L., 245n  
 Hagman, J. D., 396, 397, 398  
 Hagmayer, Y., 247  
 Hagoort, P., 226  
 Hagopian, L. P., 83  
 Haier, R. J., 23  
 Hale, S., 169  
 Hale-Benson, J. E., 495  
 Haley, R., 69  
 Halford, G. S., 261, 301, 302, 320  
 Hall, J. E., 148, 150, 152, 394  
 Hall, K. M., 364  
 Hall, N. C., 196, 441, 447, 453, 476, 487, 496  
 Hall, R. H., 215  
 Hall, V. C., 202  
 Halldén, O., 245n  
 Hallenbeck, M. J., 487  
 Haller, E. P., 383  
 Halpern, D. F., 348, 411, 421, 422, 423, 424, 445, 459  
 Halpin, G., 286, 460  
 Hamann, M. S., 272  
 Hambrick, D. Z., 154, 198, 402  
 Hamedani, M. G., 331, 332  
 Hamlin, P. H., 67  
 Hamm, A. O., 449n  
 Hamm, D., 438  
 Hamman, D., 381  
 Hammer, D., 204, 212, 214, 245, 253, 258, 308, 376, 378  
 Hammerness, K., 211, 286, 440  
 Hampson, S. E., 445  
 Han, J. J., 274  
 Hanesian, H., 200, 231, 390  
 Hankin, B. L., 435, 484  
 Hanley, G. P., 67, 75, 98, 211, 457  
 Hanna, A., 267  
 Hannum, W. H., 107  
 Hansen, D. N., 407, 460  
 Hansen, J., 201, 212  
 Hanson, A. R., 123, 130, 131  
 Harackiewicz, J. M., 428, 429, 457, 463, 464, 469, 470, 471, 492, 494  
 Hardré, P. L., 437, 456, 470  
 Hardwin, A. F., 356  
 Hardy, I., 308  
 Harel, G., 390  
 Hareli, S., 479, 483, 484  
 Haring, N. G., 95  
 Harlow, H., 396  
 Harlow, H. F., 53  
 Harmon-Jones, E., 447, 453  
 Harms, U., 384  
 Harpster, L., 489  
 Harrington, C., 408  
 Harris, I. M., 169  
 Harris, J., 273  
 Harris, J. A., 169  
 Harris, K. R., 123, 134, 156, 210, 358, 383, 493  
 Harris, P. L., 121, 302, 373  
 Harris, R. J., 421  
 Harsch, N., 271, 273  
 Harsh, C. M., 112  
 Harter, S., 119, 128n, 435, 436, 437, 439, 443, 454, 490  
 Hartley, J., 213, 218, 364  
 Hartley, K., 191, 379  
 Hartman, W. K., 214  
 Hartup, W. W., 125, 472  
 Harvey, L., 274  
 Harwood-Nash, D., 24  
 Haseaman, A. L., 378  
 Hasher, L., 168, 177, 276  
 Haskell, R. E., 200, 249, 390, 393, 395, 396, 397, 399, 414, 415  
 Hasselhorn, M., 192, 374, 383  
 Hassin, R. R., 467  
 Hatano, G., 28, 202, 245, 245n, 251, 254, 256, 257, 309, 315n, 335, 337, 341, 380, 440  
 Hatch, T., 249  
 Hattie, J., 55, 83, 130, 286, 378, 383, 385, 436  
 Hattie, J. A. C., 108, 201, 495  
 Haugwitz, M., 360  
 Hay, I., 436  
 Hayashi, Y., 69  
 Hayenga, A. O., 428  
 Hayes, B. K., 242  
 Hayes, C., 112  
 Hayes, D. A., 214  
 Hayes, J. R., 210  
 Hayes, K. J., 112  
 Hayes, S. C., 135  
 Hayes-Roth, B., 200  
 Hayne, H., 126, 280, 329  
 Haynes, T. L., 441  
 Haywood, H. C., 320, 327, 334  
 Head, L. S., 44  
 Heafner, T., 384  
 Heal, N. A., 211  
 Healey, M. K., 276  
 Healy, A. F., 196, 269, 407  
 Heath, C., 365  
 Heatherton, T. F., 165, 193, 454  
 Hebb, D. O., 450  
 Hecht, S. A., 210, 414  
 Heck, A., 97  
 Hedges, L. V., 415  
 Hegarty, M., 207, 411  
 Heil, M., 228  
 Heindel, P., 207  
 Heine, S. J., 442  
 Heiser, J., 225  
 Heitz, R. P., 176  
 Heller, L. R., 342  
 Helmke, A., 109, 211  
 Helms, B. P., 74  
 Hembree, R., 454  
 Hemmes, N. S., 122, 125, 217, 428, 457  
 Hemmings, A. B., 474  
 Hemphill, L., 329  
 Henderlong, J., 482  
 Henderson, B., 304, 305  
 Hendricks, B. L., 492  
 Hendriks, M., 270  
 Henk, W. A., 214  
 Hennessey, B. A., 428, 437, 438, 439, 455, 456  
 Hennessey, M. G., 256, 309, 355  
 Hennighausen, E., 228  
 Henry, K. B., 473  
 Heppner, W. L., 436  
 Herbert, J., 126  
 Herbert, J. J., 112  
 Herman, S., 273  
 Hermans, D., 38  
 Hernandez, E., 98, 457  
 Heron, W., 431  
 Herrenkohl, L. R., 337, 338, 340n  
 Herrmann, D. J., 404, 417  
 Herrmann, E., 7  
 Herrnstein, R. J., 33  
 Hessels, A., 300  
 Heuer, F., 448  
 Heward, W. L., 85, 182  
 Hewitt, J., 349, 350  
 Hewson, P. W., 256  
 Heyman, G. D., 274, 423, 481  
 Hickey, D. T., 332, 358, 466  
 Hickling, A. K., 373  
 Hicks, L., 488  
 Hidi, S., 182, 364, 428, 429, 448, 457, 463, 464, 469, 471, 492, 497  
 Hiebert, J., 262, 334, 336, 414, 415, 417, 418, 419  
 Higa, J. J., 66  
 Higbee, T. S., 87  
 Higgins, A. T., 182  
 Higgins, C., 92, 94  
 Hilden, K., 374, 381, 382, 385  
 Hilgard, E. R., 53  
 Hill, C. A., 442  
 Hill, K. T., 460  
 Hill, W. H., 103, 104, 283  
 Hillebrand, C., 207  
 Hills, T. T., 231  
 Hilt, L. M., 496  
 Hinckley, J. W., 474  
 Hinnant, J. B., 495  
 Hipworth, K., 106  
 Hiroto, D. S., 487  
 Hirsch, E. D., Jr., 103, 262  
 Hirschfeld, L., 238  
 Hirsh, E., 67  
 Hirsh-Pasek, K., 241, 328  
 Hirst, W., 167, 273  
 Hirstein, W., 275  
 Hitch, G. J., 173, 192, 374  
 Hladkyj, S., 196, 441, 487  
 Hmelo-Silver, C. E., 333, 420  
 Ho, K., 117  
 Hock, H. S., 177  
 Hodell, M., 439, 492  
 Hodge, D., 273  
 Hodges, L. F., 44  
 Hoefner, J., 217  
 Hofer, B. K., 375, 376, 377, 378, 379, 386  
 Hofer, M., 164, 457, 462, 463, 464, 475, 492  
 Hoff, K., 135  
 Hoffman, B., 407, 409, 417, 453  
 Hoffman, H., 44  
 Hoffman, M. L., 91  
 Hofman, R., 215  
 Hogan, D. M., 336, 341  
 Hogan, H. P., 197, 198, 228, 270  
 Hogan, K., 335, 336, 337, 378  
 Hoke-Sinex, L., 357  
 Hokoda, A., 487  
 Holcombe, R., 427, 455, 457, 494, 497  
 Holland, A., 455  
 Holland, R. W., 270  
 Holley, C. D., 360  
 Holliday, B. G., 484  
 Holliday, R. E., 275  
 Holmes, C. J., 24  
 Holt, K., 438  
 Holt, L. E., 453  
 Holt, M. B., 241  
 Holt-Reynolds, D., 204  
 Holyoak, K. J., 238, 397, 398, 399, 407, 411, 412, 413  
 Hom, A., 346  
 Homme, L. E., 55  
 Hommel, B., 227  
 Hong, E., 450  
 Hong, H.-Y., 349  
 Honzik, C. H., 142

- Hoogstra, L. A., 470  
 Hook, C. L., 346  
 Hoopell, C., 121  
 Hooper, C. J., 168  
 Hopkins, L., 446  
 Hopson, J., 22, 23  
 Horgan, D. D., 365, 482  
 Horn, J. L., 175, 259  
 Horner, R. H., 94, 438  
 Hornstra, G., 279  
 Hornyak, R. S., 132, 384, 386  
 Horowitz, F. D., 334  
 Horsberg, T. E., 36  
 Horst, J. S., 237, 238  
 Horvath, K. J., 376  
 Horwitz, E. K., 453  
 Hoskyn, M., 325  
 Houchins-Juárez, N., 51  
 Hovland, A. L., 36  
 Howard, D. V., 161  
 Howe, C., 255, 256  
 Howe, M. L., 222n, 375  
 Howell, K. L., 378, 379  
 Howie, J. D., 485  
 Hoy, W. K., 131, 496  
 Hoyt, J. D., 373  
 Hruda, L. Z., 442, 499  
 Hsee, C. K., 432  
 Hsieh, P.-H. P., 479  
 Hu, P., 200  
 Hubbs-Tait, L., 24  
 Hubel, D. H., 25  
 Huberty, P. D., 62  
 Hubley, P., 327  
 Hübscher, R., 323  
 Hudson, T., 403  
 Hudspeth, W. J., 293  
 Huebner, E. S., 432  
 Huesmann, L. R., 123  
 Huey, E. D., 29  
 Huff, J. A., 60  
 Huff, N. C., 39, 40  
 Hufton, N., 466  
 Hughes, J. N., 134  
 Hull, C., 429  
 Hull, C. L., 33, 238, 401, 429  
 Hulleman, C. S., 492  
 Hulme, C., 210  
 Humphreys, L. G., 42  
 Hundert, J., 98  
 Hung, W., 419, 420  
 Hunt, R. R., 196, 243, 276  
 Hunter, W. S., 148  
 Hurley, E. A., 341  
 Hursh, D., 102, 103  
 Husman, J., 445, 446, 488, 493  
 Huston, A. C., 122, 124  
 Hutchinson, J. M., 135  
 Hutt, C., 307  
 Hutt, S. J., 307  
 Huttenlocher, J., 245, 300  
 Huttenlocher, P. R., 22, 23  
 Hutter, R., 376  
 Hyde, J. S., 435, 484  
 Hyde, K. L., 24  
 Hyde, T. S., 7, 178, 179  
 Hyman, I., 61  
 Hymel, S., 459  
 Hynd, C., 249, 253, 254, 256, 347, 429, 437  
 Iacoboni, M., 27  
 Iacono, W. G., 24  
 Iadicola, P., 60  
 Ialongo, N. S., 96  
 Igoa, C., 85  
 Illushin, L., 466  
 Immordino-Yang, M. H., 304, 427  
 Imwold, C., 55  
 Inagaki, K., 245, 245n, 254, 256, 257, 309, 335, 337, 341, 380, 440  
 Ingersoll, G. M., 150  
 Inglehart, M., 497  
 Inglis, A., 215, 326, 345  
 Inhelder, B., 290  
 Inman, W. E., 213  
 Inouye, D. K., 487  
 Intons-Peterson, M. J., 176  
 Inzlicht, M., 454  
 Irwin, D. E., 186  
 Irwin, J. M., 150, 276  
 Isaacowitz, D. M., 447  
 Isaacson, R. L., 444  
 Ito, T. A., 449-450  
 Ivry, R. B., 42  
 Iwata, B. A., 60, 65, 87  
 Iyengar, S. S., 429, 438  
 Jackson, D., III, 495  
 Jackson, G. C., 67  
 Jackson, J. S., 479  
 Jacob, B. A., 102  
 Jacobs, J. E., 454, 465, 466  
 Jacobs, M., 321  
 Jacobs, P. J., 74  
 Jacobs, W. J., 277-278, 450  
 Jacobsen, L. K., 24  
 Jacobson, K., 27  
 Jacoby, K., 251  
 Jacoby, L. L., 276  
 Jaeggi, S. M., 393  
 Jagacinski, C. M., 468n, 470, 473, 480  
 Jai, D., 325  
 Jain, S., 453  
 James, W., 159, 393, 393n  
 Jameson, M. M., 435, 453, 454  
 Janczak, A. M., 36  
 Jang, H., 456, 457  
 Jankowski, J. J., 237  
 Janssens, D., 300  
 Janzen, J. C., 405  
 Japuntich, S., 207  
 Jara, E., 41  
 Jarmolowicz, D. P., 69  
 Jarrett, O. S., 62  
 Jarvin, L., 308  
 Jarvis, W. B. G., 445  
 Jastrzembski, T., 198  
 Jeffrey, R. W., 125  
 Jegede, O. J., 285  
 Jenkins, A. C., 121  
 Jenkins, E., 410  
 Jenkins, J. J., 7, 151, 178, 179  
 Jenlink, C. L., 459  
 Jerman, O., 402  
 Jernigan, T. L., 23, 24  
 Jessup, D., 484  
 Jetton, T. L., 213, 245, 363, 382, 383  
 Jiang, B., 83  
 Jiang, Y., 431  
 Joag-Dev, C., 244  
 Johansen, M. K., 241, 261  
 Johnsen, E. P., 415  
 Johnson, B., 471, 472  
 Johnson, B. M., 95  
 Johnson, C. J., 197  
 Johnson, D. M., 243  
 Johnson, D. W., 46, 309, 335, 336, 337, 340, 340n, 341, 342, 343, 344, 419, 496  
 Johnson, J. M., 259, 397  
 Johnson, K., 139  
 Johnson, K. E., 463, 464  
 Johnson, M. H., 20, 25, 26  
 Johnson, M. K., 192, 195, 274, 275  
 Johnson, N. S., 228  
 Johnson, R. E., 454  
 Johnson, R. L., 287, 420  
 Johnson, R. S., 287  
 Johnson, R. T., 46, 309, 335, 336, 337, 340, 340n, 341, 342, 343, 344, 419, 496  
 Johnson, S. K., 222  
 Johnson-Glenberg, M. C., 340  
 John-Steiner, V., 321  
 Johnston, A. M., 474  
 Johnston, J. C., 166, 167  
 Johnston, W. A., 167  
 Jonassen, D. H., 107, 364, 419  
 Jonen, A., 308  
 Jones, E. E., 436  
 Jones, H. E., 152  
 Jones, I., 62  
 Jones, K. M., 93n  
 Jones, M. C., 43  
 Jones, M. G., 224  
 Jones, M. S., 197, 369, 423, 459  
 Jones, S. S., 119  
 Jones, V., 78  
 Jongasma, H. W., 279  
 Jonides, J., 170n, 176, 393  
 Jordan, A. B., 124  
 Joseph, J. E., 431  
 Josephs, R. A., 455  
 Judd, C. H., 397  
 Junghöffer, M., 449n  
 Jussim, L., 495  
 Just, M. A., 170, 382  
 Juvonen, J., 441, 443, 472, 484, 485  
 Kaczala, C. M., 59  
 Kademmann, S., 162  
 Kağıtçıbaşı, Ç., 423  
 Kahl, B., 343  
 Kahne, J. E., 333  
 Kail, R., 374  
 Kaiser, M. K., 205  
 Kaldy, Z., 161  
 Kalish, C. W., 239, 241, 243, 246, 247  
 Kalish, D., 143, 144  
 Kambe, G., 102, 182  
 Kamins, M. L., 487  
 Kanaya, T., 272  
 Kane, M. J., 181, 412  
 Kanekar, S., 40  
 Kang, M. J., 445  
 Kang, S., 390  
 Kang, S. H. K., 286  
 Kapelak, S., 149  
 Kaplan, A., 307, 336, 446, 455, 468n, 470, 471, 472, 474, 491  
 Kaplan, S., 164, 191, 357  
 Kapur, M., 419  
 Kapur, S., 178  
 Karabenick, S. A., 129, 356, 357, 445, 446, 488n  
 Karau, S. J., 344  
 Kardash, C. A. M., 245, 373, 376, 378, 379, 384, 423, 424, 445  
 Karl, S. R., 390  
 Karlin, M. B., 193  
 Karoly, P., 135  
 Karpicke, J. D., 286  
 Karpinski, A., 436  
 Karpov, Y. V., 320  
 Kaschak, M. P., 207  
 Kastens, C., 356, 445  
 Kastman, L. M., 207  
 Katagiri, M., 72  
 Kato, T., 224, 269  
 Katz, P. A., 428, 438  
 Kauffman, J. M., 59, 60, 61, 82, 87, 88, 89, 91, 92, 95  
 Kauffman, S., 281

NI-10 NAME INDEX

- Kaufman, A., 119  
 Kaufman, L., 162  
 Kavussanu, M., 472  
 Kaye, H., 35  
 Kazdin, A. E., 60, 61  
 Kazi, S., 383  
 Keane, M. M., 223  
 Keane, M. T., 176, 206, 276  
 Kearney, C. A., 44  
 Kee, Y. H., 470, 471  
 Keefe, K., 443  
 Keenan, M., 44, 122, 124  
 Keil, F. C., 236, 241, 246, 247, 253  
 Kelemen, D., 249  
 Kelemen, W. L., 366  
 Kellam, S. G., 96  
 Keller, F. S., 107  
 Kelley, C. M., 181  
 Kelley, E., 252  
 Kelley, K., 464  
 Kelley, M. E., 88  
 Kelley, M. L., 83, 85  
 Kelley, W. M., 165, 193, 454  
 Kelly, G., 106  
 Kelly, K. L., 396, 470  
 Kelly, S. W., 224, 269  
 Kelly, T. H., 431  
 Kember, D., 378  
 Kemler Nelson, D. G., 241, 247  
 Kendall, J. S., 103, 284, 284n  
 Kendeou, P., 204, 252, 253  
 Kandler, H. H., 239  
 Kandler, T. S., 238, 239  
 Kennedy, C. H., 51, 93, 94, 346  
 Kenney, P. A., 287  
 Kenrick, D. T., 434, 434n  
 Kensinger, E. A., 28, 200, 227, 448  
 Kermani, H., 345  
 Kerstner, H., 227  
 Kesebir, S., 193, 434  
 Kester, L., 198, 217, 390, 397  
 Kidd, E., 152, 368  
 Kiefer, S. M., 474  
 Kiesner, J., 454  
 Kiewra, K. A., 195, 360, 362, 363  
 Kileen, P. R., 210  
 Killian, C. D., 152  
 Kim, J. A., 42  
 Kim, S.-I., 497  
 Kim, S.-K., 474  
 Kim, Y., 472  
 Kimberg, D. Y., 168n  
 Kimble, G. A., 33  
 Kincheloe, J. L., 347, 482, 495  
 Kindermann, T., 437  
 King, A., 215, 250, 335, 343, 364, 366  
 King, J., 342  
 King, N. J., 453  
 King, P. M., 376, 378, 379, 386, 409, 423, 446  
 Kingstone, A., 164, 327  
 Kinnick, V., 242, 243  
 Kintsch, E., 364  
 Kintsch, W., 200, 208, 227, 358, 364, 380  
 Kirby, J. R., 360  
 Kirby, L. D., 449  
 Kirker, W. S., 193  
 Kirkland, M. C., 452, 460  
 Kirkwood, H., 169  
 Kirsch, L., 273, 274  
 Kirschner, F. L., 334  
 Kirschner, P. A., 176, 182, 334, 415, 420  
 Kirsh, D., 331, 395, 409, 413, 418  
 Kistner, J. A., 486  
 Kitchener, K. S., 376, 378, 379, 386, 409, 423, 446  
 Kitsantas, A., 129, 131, 133n, 199, 217, 249, 366, 493  
 Kitsukawa, K., 76  
 Klaczynski, P. A., 301, 302  
 Kladopoulos, C. N., 55, 208  
 Klahr, D., 300, 348  
 Klassen, R. M., 130, 131, 382  
 Klatzky, R. L., 170n, 191  
 Klauda, S. L., 210  
 Klein, S. B., 40, 41, 70  
 Klinger, E., 431  
 Klinnert, M. D., 328  
 Klint, K. A., 125, 199  
 Klopfer, L. E., 253  
 Kluger, A. N., 208, 493  
 Knight, C. C., 304  
 Knight, S. L., 340  
 Knighton, B., 103, 211, 249, 262, 283, 384, 492  
 Knutson, J. S., 106, 108  
 Kobasigawa, A., 374  
 Kodak, T., 76, 88  
 Koedinger, K., 385  
 Koedinger, K. R., 218, 323, 418  
 Koegel, L. K., 94  
 Koegel, R. L., 94  
 Koelling, R. A., 38  
 Koenig, M. A., 247  
 Koerber, C., 443  
 Koestner, R., 81, 438, 439  
 Koffka, K., 144, 146  
 Kogan, J. S., 83  
 Koger, S. M., 24  
 Koh, K., 413  
 Köhler, W., 144, 145, 147, 401  
 Kolb, B., 24  
 Köller, O., 356, 445  
 Kollins, S. H., 52  
 Koltko-Rivera, M. E., 250, 251, 253  
 Konkel, A., 276  
 Konkle, T., 197  
 Konopak, B. C., 197  
 Koo, B. K. K., 24  
 Koob, A., 16, 22, 28  
 Kopp, R. E., 119  
 Koppekin, A., 93, 94  
 Koreishi, A., 274  
 Koriat, A., 274, 276  
 Körkel, J., 202  
 Kornell, N., 208, 238, 242, 354n, 356, 365, 397  
 Kortenbruck, M., 428  
 Korzybski, A., 181  
 Koschmann, T., 225, 348  
 Kosciulek, J. F., 474  
 Kose, G., 207  
 Kosslyn, S. M., 197, 199, 225n, 411  
 Kothera, R., 98  
 Kounios, J., 408  
 Koven, M., 328  
 Kowalski, P., 454  
 Kowalski, P. S., 256  
 Kozhevnikov, M., 411  
 Kozulin, A., 314, 327  
 Krajcik, J., 342, 385  
 Krajcik, J. S., 215, 333, 342  
 Kramarski, B., 357, 417  
 Krampen, G., 286, 497  
 Krantz, D. H., 454  
 Krantz, P. J., 84  
 Krapp, A., 182, 448, 463  
 Kratwohl, D. R., 103, 104, 283  
 Krauss, R. M., 225  
 Kravetz, S., 161  
 Kray, J., 227  
 Krebs, N. F., 24  
 Kremen, W. S., 169  
 Krendl, A. C., 454  
 Krishnan, A., 377, 423  
 Krishnan, K., 383  
 Kritch, K. M., 106  
 Krueger, F., 29  
 Krueger, W. C. F., 149  
 Kruger, J., 139  
 Kruglanski, A. W., 445n  
 Krumboltz, H. B., 88  
 Krumboltz, J. D., 88  
 Kruschke, J. K., 166  
 Ku, Y.-M., 182, 362  
 Kuhara-Kojima, K., 202  
 Kuhbandner, C., 448-449  
 Kuhl, J., 489  
 Kuhl, P., 25  
 Kuhl, P. K., 25, 26  
 Kuhn, D., 31, 199, 257, 301, 302, 308, 310, 335, 336, 341, 348, 357, 375, 376, 377, 379, 381, 382, 386, 420, 422, 423, 424, 445, 446, 459, 465n, 492  
 Kuhn, S. A. C., 88  
 Kuhn, T., 260n  
 Kuiper, N. A., 193  
 Kuklinski, M. R., 495, 496  
 Kulesa, P., 257  
 Kulhavy, R. W., 216  
 Kulik, C. C., 83, 106, 108, 383  
 Kulik, J. A., 83, 106, 108, 383  
 Kulikowich, J. M., 213, 363, 464  
 Kulp, C. A., 453  
 Kumar, S., 442, 468n, 473  
 Kuncel, N. R., 382  
 Kunda, Z., 252  
 Kunkel, D., 124  
 Kosslyn, S. M., 197, 383  
 Kunzinger, E. L., III, 374  
 Kupers, C. J., 132  
 Kupersmidt, J. B., 442  
 Kurita, J., 197  
 Kurtz, P. F., 56  
 Kutas, M., 273  
 Kuyper, H., 130  
 Kwan, L., 227  
 LaBar, K. S., 39, 40, 448  
 LaBerge, D., 210  
 Lacante, M., 445, 465  
 Lacerda, F., 25  
 Lacey, S. C., 170n  
 Lackaye, T. D., 130  
 Ladd, G. W., 427  
 La Guardia, J. G., 491  
 Lajoie, S., 409  
 Lakoff, G., 247  
 Lalley, J. P., 106, 109  
 Lam, H., 473  
 Lam, S., 438  
 Lambert, M. C., 182  
 Lamme, V. A. F., 162  
 Lampert, M., 336, 337, 375, 419  
 Lampinen, J. M., 244, 274, 279  
 Lan, W. Y., 498  
 Landauer, T. K., 172  
 Landers, D. M., 199  
 Landrum, T. J., 59, 60, 61, 82, 87, 88, 89, 91, 92, 95  
 Landsford, J. E., 61  
 Lane, K., 75, 456  
 Lane, S. M., 395, 410  
 Lange, G., 383  
 Langer, E. J., 210, 380n  
 Langer, J. A., 331  
 Lanza, S., 466  
 Lapan, R. T., 474  
 Laraway, S., 76  
 Larkin, J. H., 213

- Larmer, J., 333  
 Larose, S., 491  
 Larson, M. B., 106  
 Larson, R. W., 427, 443, 491  
 LaRue, R. H., Jr., 88  
 Larzelere, R. E., 61  
 Lassiter, G. D., 481  
 Latham, G. P., 466, 470, 475, 489  
 Lau, S., 470, 472  
 Lauer, K. D., 364  
 Lave, J., 324, 324n, 331, 395, 416  
 Lawrence, J. A., 400n, 404  
 Lawry, J. A., 430  
 Lawson, M. J., 408  
 Layer, S. A., 211  
 Lazarus, R. S., 450  
 Lea, C. D., 161  
 Leach, J., 253  
 Leach, J. C., 168  
 Leach, J. T., 156, 327  
 Leaper, C., 121, 122  
 Learning Technology Center at Vanderbilt, 420  
 LeBaron, C., 225  
 LeBlanc, L. A., 122, 123, 217  
 LeDoux, J., 29, 42n  
 Lee, D. L., 75  
 Lee, J., 353, 357, 360, 427  
 Lee, J. H., 123  
 Lee, J. L. C., 28  
 Lee, J. Q., 467, 469  
 Lee, J. S., 300  
 Lee, K., 403, 423, 471  
 Lee, M., 471  
 Lee, M.-J., 497  
 Lee, O., 215, 256, 427, 428  
 Lee, P., 214  
 Lee, S., 301  
 Lee, S. W., 454  
 Lee, V. R., 249, 258  
 Leer, M. N., 417  
 LeFevre, J., 210  
 Leff, R., 91  
 Leggett, E. L., 477, 478  
 Legrain, P., 455  
 Leherissey, B. L., 407, 460  
 Lehman, D. R., 302, 377  
 Lehman, J., 301  
 Lehman, M., 383  
 Lehman, S., 456, 463, 464  
 Lehmann, M., 192, 374  
 Leibham, M. E., 463, 464  
 Leichtman, M. D., 272, 274  
 Leinhardt, G., 203, 336  
 Lejuez, C. W., 53  
 Lennon, R., 248, 374  
 Lenroot, R. K., 22, 23  
 Lens, W., 437, 445, 465  
 Lenz, B. K., 213  
 Leon, J. A., 134  
 Leong, D. J., 358  
 Leopold, C., 216, 397  
 LePage, A., 82  
 Lepper, M. R., 81, 109, 345, 429, 438, 439, 455, 457, 482, 492  
 Lerman, D. C., 58, 65, 76, 82, 88, 89, 91, 92  
 Lervåg, A., 210  
 Lesgold, A. M., 194, 409  
 Lesgold, S. B., 417  
 Lester, F. K., Jr., 402, 409, 413  
 Leu, D. J., 340, 355  
 Leu, J., 447  
 Leuner, B., 28  
 Leung, A. K.-Y., 227  
 Leutner, D., 216, 397  
 Levay, S., 25  
 Levin, A. V., 25  
 Levin, J. R., 197, 207, 215, 217, 250, 368, 369, 370, 382, 385, 423, 459  
 Levin, M. E., 197, 369  
 Levine, M., 239, 411  
 Levstik, L. S., 310, 311, 492  
 Levy, B. J., 278  
 Levy, I., 336, 470, 474  
 Lewis, M., 447  
 Lewis, T. J., 99  
 Lewis, T. L., 25  
 Lewis, W. E., 423  
 Li, J., 377, 474, 483, 484  
 Liao, Y. K., 106  
 Libby, M. E., 98, 457  
 Liben, L. S., 310, 315, 474  
 Liberman, R. P., 85  
 Liberty, K. A., 95  
 Lichtman, J. W., 16, 28  
 Lidz, C. S., 327, 334  
 Lie, E., 280  
 Lieberman, M. D., 226, 331  
 Liem, A. D., 470  
 Liem, G. A. D., 467  
 Lien, M.-C., 167  
 Lightfoot, D., 27  
 Lillard, A. S., 373, 483  
 Lilly, T., 122  
 Lima, S. D., 206  
 Limón, M., 386  
 Lin, E., 129  
 Lin, S.-P., 349  
 Lin, X., 256, 301  
 Lin, X. D., 301  
 Lindauer, B. K., 212  
 Linderhold, T., 365, 374, 386  
 Linderholm, T., 200, 357  
 Lindsay, P. H., 214, 232, 267  
 Ling, S., 448  
 Linn, M. C., 103, 104, 208, 209, 250, 255, 262, 302, 309, 310, 335, 336, 341, 376, 396, 414, 415, 416, 419  
 Linn, M.-S., 470, 471  
 Linn, R. L., 102  
 Linnenbrink, E. A., 253, 396, 442, 446n, 447, 468n, 470, 494, 497, 499  
 Linnenbrink-Garcia, L., 463  
 Lipko, A. R., 365, 366, 374, 386  
 Lippa, R. A., 122n  
 Lipschultz, R. E., 470  
 Lipsitt, L. P., 35  
 Lipson, M. Y., 244  
 Liskowski, U., 300  
 Little, T. D., 491  
 Litwin, G. H., 444  
 Liu, H.-M., 25  
 Liu, J., 236, 238  
 Liu, R., 419  
 Liu, X., 431  
 Lo, Y.-F., 261  
 Lo, Y.-Y., 182  
 Lochead, J., 412, 413  
 Lock, T. G., 278  
 Locke, E. A., 466, 470, 475, 489  
 Lockee, B. B., 106, 107, 109  
 Lockhart, K. L., 486  
 Lockhart, R. S., 177  
 Lockl, K., 374  
 Lodewyk, K. R., 129, 323  
 Loftus, E. F., 162, 179, 195, 268, 269, 270, 271, 272, 273, 275, 276, 278, 407  
 Loftus, G. R., 162, 275, 276  
 Logie, R., 169  
 Logue, A. W., 37, 38  
 Long, J. D., 474  
 Looney, L. B., 459  
 Loranger, A. L., 381  
 Lorayne, H., 369, 370  
 Lorch, E. P., 213  
 Lorch, R. F., Jr., 213, 218, 301, 308  
 Losh, S. C., 248, 251, 423, 483  
 Lotan, R. A., 341, 342  
 Lou, Y., 341, 342, 344  
 Lourenco, S. F., 245  
 Lovell, K., 301  
 Lovett, S. B., 381  
 Lovitt, T. C., 96  
 Lowe, P. A., 454  
 Lowell, E. L., 443-444  
 Lu, Z.-L., 162  
 Lubinski, D., 225  
 Lucas, G. A., 38  
 Lucas, J., 369, 370  
 Luchins, A. S., 406, 416  
 Luchins, E. H., 406, 416  
 Luciana, M., 168  
 Luciw, U. A., 354  
 Luciw-Dubas, U. A., 200, 354  
 Luck, S. J., 167, 171  
 Luczynski, K. C., 67  
 Ludtke, O., 356, 445, 453, 455  
 Ludvig, E. A., 69  
 Ludwig, T. D., 84  
 Ludwin, W. G., 60  
 Luiselli, J. K., 43, 208, 217  
 Lukowski, A. F., 22, 199  
 Luna, B., 24  
 Lundeberg, M. A., 286  
 Luo, C. R., 273  
 Luo, H., 453  
 Lupyan, G., 239  
 Luque, M. L., 253  
 Lussier, C. M., 327  
 Lustenberger, D. E., 473  
 Lustig, C., 276  
 Luyben, P. D., 106  
 Lyle, K. B., 248  
 Lynam, D., 431  
 Lynch, S. L., 130  
 Lynn, S. J., 274, 278  
 Lyon, T. D., 373  
 Maas, A., 454  
 MacAndrew, D. K., 170n  
 MacDonald, S., 329  
 Mace, F. C., 75, 134, 135  
 Macfarlane, A., 35  
 MacGregor, J. T., 340n  
 Mac Iver, D., 437, 441, 465  
 Mac Iver, D. J., 211, 460, 491, 493  
 Mack, A., 165  
 MacKay, I. R. A., 25  
 Mackenzie, M., 255  
 MacKenzie-Keating, S., 59  
 Mackler, K., 45  
 MacLeod, C. M., 275  
 MacLeod, M. D., 277  
 Maclin, D., 298n  
 Macomber, J., 27  
 Macrae, C. N., 165, 193  
 Macropolis, G., 69  
 Maddi, S. R., 450  
 Madison, S. M., 496  
 Madjar, N., 468n  
 Madole, K. L., 237  
 Madon, S., 495  
 Maehr, M. L., 427, 428, 443, 460, 466, 467, 469, 470, 498, 499  
 Mager, R. F., 99, 100  
 Magliano, J. P., 182, 207  
 Maguire, E. A., 26  
 Mahn, H., 321  
 Mahoney, M. J., 136  
 Maier, M. A., 470, 471, 473  
 Maier, N. R. F., 405, 407  
 Maier, S. F., 8, 9, 485, 486  
 Main, D. S., 428, 438  
 Main, S. R., 211, 460, 491

NI-12 NAME INDEX

- Maki, R. H., 365  
 Malanchuk, O., 465  
 Maldonado, A., 41  
 Malhotra, B. A., 256  
 Malloy, L. M., 242  
 Malmi, R., 149  
 Mandell, C., 75  
 Mandinach, E. B., 357  
 Mandl, H., 390  
 Mandler, J. M., 228, 236,  
 239, 241, 247, 261, 300  
 Maner, J. K., 436  
 Mangels, J. A., 470  
 Manier, D., 273  
 Mantzicopoulos, Y., 308  
 Manzey, C., 396, 470  
 Maouene, J., 231  
 Maouene, M., 231  
 Marachi, R., 131, 459, 495  
 Marchand, G., 437  
 Marcia, J. E., 474  
 Marcovitch, S., 168  
 Marcus, B. A., 88  
 Marcus, G., 154, 181, 224n,  
 248, 268, 447, 448  
 Mareschal, D., 16, 155, 331  
 Margalit, M., 130  
 Margolis, J. A., 197  
 Marian, V., 267  
 Mariner, C. L., 61  
 Marini, Z., 300  
 Markham, T., 333  
 Markman, E. M., 374, 482  
 Marks, M. B., 383, 384  
 Markus, H. R., 331, 332, 442  
 Marley, S. C., 197  
 Marlowe, D., 443  
 Marmolejo, E. K., 182  
 Marsh, E. J., 273  
 Marsh, H. W., 128n, 435,  
 474, 497  
 Marshall, P. J., 156, 331  
 Martens, B. K., 75  
 Martin, A. J., 435, 441, 447,  
 459, 497  
 Martin, C. L., 121  
 Martin, G., 105  
 Martin, S. S., 74  
 Martin, T., 331, 415  
 Martinez, P., 249, 366  
 Marton, F., 155, 376  
 Marx, R. W., 255, 342, 427  
 Marzano, R. J., 103, 284,  
 284n  
 Maslow, A., 432  
 Mason, L., 204, 252, 253,  
 256, 257, 335, 378, 380,  
 446, 447, 463, 470  
 Massa, L. J., 218  
 Massey, D., 384  
 Massimini, M., 200  
 Masson, M. E. J., 209, 223  
 Mast, V. K., 76  
 Mastenbrook, M., 407  
 Mastergeorge, A. M., 341  
 Masters, J., 248, 249  
 Masters, J. C., 109  
 Mastropieri, M. A., 368, 383,  
 496  
 Masuda, A., 51  
 Masuda, W. V., 334  
 Masur, E. F., 374  
 Mathan, S. A., 218  
 Mathes, P. G., 326, 345  
 Matlin, M. W., 381  
 Matthews, B. A., 69  
 Matthews, G., 45, 268, 446,  
 453, 454  
 Matthews, R. C., 395  
 Mattock, A., 27  
 Matusov, E., 347  
 Maurer, D., 25  
 Maus, G. W., 185  
 Maxmell, D., 62  
 May, C. P., 168  
 May, D. B., 384  
 Mayer, R. E., 155, 182, 192,  
 195, 196, 197, 200, 210,  
 211, 215, 216, 217, 218,  
 245, 250, 283, 308, 363,  
 364, 371, 390, 393, 396,  
 397, 402, 403, 407, 409,  
 410, 412, 413, 415, 416,  
 417, 418, 419  
 Mayfield, K. H., 416  
 Maynard, A. E., 302  
 Mazur, J. E., 54, 98  
 Mazzoni, G., 273, 274  
 McAllister, D. E., 39  
 McAllister, W. R., 39  
 McAndrew, D. A., 213  
 McArthur, D., 327  
 McAshan, H. H., 102  
 McAuley, M., 248  
 McCall, C., 135  
 McCall, R. B., 22, 27, 29  
 McCallin, R. C., 201, 202,  
 203, 359  
 McCallum, R. S., 119  
 McCandliss, B. D., 30  
 McCann, R. S., 166  
 McCaslin, M., 81, 83, 333,  
 341, 358, 387, 456, 475  
 McCauley, R. N., 247  
 McClannahan, L. E., 84  
 McClelland, D. C., 442, 443–  
 444  
 McClelland, J. L., 170n, 234,  
 235  
 McClelland, L., 444  
 McClintic-Gilbert, M. S., 428  
 McCloskey, M., 205  
 McClowry, S. G., 61  
 McClure, J., 460  
 McComas, J. J., 55, 83, 208  
 McCombs, B. L., 471, 490  
 McConaughy, F., 257  
 McCormick, C. B., 197  
 McCrary, J. W., 148  
 McCrubbrey, H., 122  
 McCrudden, M. T., 102, 182,  
 191, 213, 215  
 McCullagh, P., 122, 199  
 McCutchen, D., 210  
 McDaniel, J. L., 51  
 McDaniel, M. A., 195, 196,  
 209, 213, 278, 283, 359,  
 382, 415, 463  
 McDannald, M., 41  
 McDermott, K. B., 273, 286  
 McDevitt, T. M., 294, 374,  
 377  
 McDonagh, S. H., 106  
 McDonald, R. V., 42  
 McDonald, S. L., 387  
 McDougall, P., 459  
 McDowell, C., 44  
 McElree, B., 175  
 McElvany, N., 428  
 McEvoy, A. P., 488  
 McFall, R. M., 83  
 McGaugh, J. L., 448  
 McGee, K. D., 340  
 McGee, L. M., 336  
 McGeoch, J. A., 150, 276  
 McGill, P., 65, 431  
 McGinnis, M. A., 51  
 McGoey, K. E., 346  
 McGoldrick, J., 197  
 McGovern, M. L., 384  
 McGraw, A. P., 447  
 McGregor, H. A., 470, 471,  
 472  
 McGuigan, F., 207, 329  
 McHale, S. M., 491  
 McHugh, L., 70  
 McInerney, D. M., 427, 441,  
 467, 473, 474  
 McIntyre, C. W., 374  
 McKenzie, H. S., 98  
 McKeough, A., 304, 305  
 McKeown, M. G., 211, 256,  
 337, 355, 384  
 McKerchar, P. M., 54, 56  
 McKoon, G., 180  
 McKown, C., 455  
 McLean, J., 54  
 McLeod, P., 407  
 McLoyd, V. C., 495  
 McMillan, J. H., 386  
 McNally, R. J., 278  
 McNamara, D. S., 196, 207,  
 385  
 McNeil, N. M., 300, 308  
 McNeill, D., 265  
 McNulty, J. K., 448  
 McSweeney, F. K., 83  
 McTighe, J., 101, 101n, 262  
 McVerry, J. G., 355  
 Meachem, J., 54  
 Mealey, D. L., 383  
 Medin, D. L., 238, 246, 251,  
 262  
 Medinilla, C., 379  
 Meece, J. L., 59, 453, 454,  
 470, 493, 496  
 Meehl, P. E., 51  
 Meichenbaum, D., 134, 326  
 Meinz, E. J., 198  
 Meister, C., 340, 364, 366  
 Mellers, B. A., 117, 447  
 Melloy, K. J., 60, 65n, 88  
 Meloth, M. S., 343, 344  
 Melton, A. W., 150, 276  
 Meltzer, L., 383, 384, 386  
 Meltzoff, A. N., 27, 83, 122  
 Memon, A., 273  
 Mendel, R., 496  
 Menck, D. W., 326  
 Menzel, R., 75  
 Mercer, L. K., 387, 498  
 Mergendoller, J. R., 333, 342  
 Merrill, M. D., 242, 243  
 Merrill, M. M., 415, 418  
 Mervis, C. B., 243  
 Merzenich, M. M., 23,  
 26, 28  
 Mesquita, B., 447  
 Messer, D. J., 256  
 Messina, R., 347  
 Mestas, M., 472, 473  
 Metcalfe, J., 356, 366, 386  
 Metz, K. E., 301, 422  
 Metzler, J., 169, 170, 225  
 Mevarech, Z. R., 417  
 Meyer, D. K., 428, 452, 458,  
 459  
 Meyer, H. A., 427  
 Meyer, K. A., 85, 93n  
 Meyer, L. H., 460  
 Meyer, R. D., 259, 397  
 Meyer, W.-U., 484  
 Mezulis, M. H., 435, 484  
 Michael, J., 76, 83, 431  
 Michalsky, T., 357  
 Middleton, E. L., 395  
 Middleton, M. J., 456, 470,  
 471, 494  
 Midgley, C., 435, 441, 453,  
 459, 468, 470, 471, 471n,  
 472, 488, 495  
 Mikulincer, M., 485, 486  
 Milan, M. A., 82  
 Milbrath, C., 225n  
 Miles, K. M., 471  
 Miller, D. L., 83, 85  
 Miller, D. T., 262  
 Miller, G., 168  
 Miller, G. A., 171, 368  
 Miller, J. G., 302  
 Miller, N., 112, 113, 431  
 Miller, N. E., 6, 56



- Miller, P. H., 227, 300, 373, 458  
 Miller, P. J., 328  
 Miller, R., 214  
 Miller, R. B., 465, 466, 493  
 Miller, R. R., 38  
 Miller, S., 384  
 Miller, S. A., 227, 300, 373  
 Miller, S. C., 454  
 Miller, S. D., 493  
 Miller, S. M., 155, 336  
 Miller, T. R., 341  
 Millham, J., 460  
 Millroy, W. L., 331  
 Mills, D. L., 21  
 Milner, H. R., 172  
 Milner, P., 431  
 Miltenberger, R., 122  
 Miltenberger, R. G., 60, 87, 88, 122  
 Mims, V., 439  
 Mims-Cos, J. S., 287  
 Mineka, S., 37, 38, 41, 122, 447  
 Miniussi, C., 169  
 Minogue, J., 224  
 Minsky, M., 81, 154, 449  
 Minstrell, J., 252, 257, 283  
 Mintrop, H., 103  
 Mintzes, J. J., 253, 360  
 Mistry, J., 320  
 Mitchell, D. B., 197, 275  
 Mitchell, J. B., 404  
 Mitchell, K. J., 272  
 Mitchell, M., 464  
 Mitchell, R. W., 7  
 Mitchell, T. V., 26  
 Mitchell, Z. A., 226  
 Mithaug, D. E., 386, 387  
 Mithaug, D. K., 386, 387  
 Mitrani, M., 456  
 Miyake, A., 170  
 Miyake, N., 349  
 Moallem, M., 345  
 Moely, B. E., 374  
 Mohatt, G., 285  
 Mohler, L., 270  
 Moje, E. B., 341  
 Molden, D. C., 379, 478, 479, 480, 484, 488, 495, 496  
 Moll, L. C., 427  
 Moller, A. C., 437, 458, 490, 491, 496  
 Möller, K., 308  
 Montecinos, C., 470  
 Monte-Sano, C., 103, 423  
 Moon, J., 285, 378, 421, 423  
 Mooney, C. M., 186  
 Moore, D. M., 106  
 Moore, J. L., 395  
 Moore, K. S., 176  
 Moore, M. K., 27  
 Moore, P. J., 360  
 Moran, S., 321  
 Morelli, G. A., 377  
 Moreno, R., 200, 308  
 Morey, C. C., 169  
 Morgan, C., 489  
 Morgan, M., 386, 438  
 Morgenstern, M., 129  
 Moritz, S. E., 82  
 Morizot, P., 198  
 Morra, S., 300, 301, 302, 303, 304, 307  
 Morris, C. D., 179  
 Morris, D., 129, 130  
 Morrisette, N., 283  
 Morsella, E., 177  
 Mortimer, E., 253  
 Mosborg, S., 251  
 Moscovitch, M., 176  
 Moser, J. M., 409  
 Moses, L. J., 171  
 Moshman, D., 376, 385  
 Mosier, C., 320  
 Moskowitz, J. T., 441  
 Motz, M., 381  
 Mowrer, O. H., 71, 72, 430, 431  
 Moylan, A. R., 129, 139, 356, 357, 374, 387  
 Moynan, S. C., 278  
 Mrkonjic, J., 210  
 Mueller, C. M., 482  
 Mueller, M. M., 93n  
 Mueller, M. P., 303, 306  
 Muis, K. R., 196, 356, 357, 359, 375, 376, 377, 378, 379, 381, 385, 386, 423, 471  
 Mulienburg, L., 250  
 Mullen, M. K., 329  
 Müller, K. J., 435, 472, 497  
 Müller, U., 168  
 Mumme, D. L., 122, 345  
 Mundy, P., 327  
 Munn, T., 122  
 Munro, D. W., 182  
 Munro, M. J., 25  
 Munro, S., 318  
 Murata, A., 27  
 Murayama, K., 468n  
 Murdock, T. B., 495  
 Murphy, E. G., 24  
 Murphy, E. S., 83  
 Murphy, G. L., 243  
 Murphy, H. A., 60  
 Murphy, K., 248, 254  
 Murphy, P. K., 204, 248, 252, 253, 254, 256, 335, 380, 446  
 Murray, C. B., 479  
 Murray, L., 328  
 Murray, R. F., 162  
 Musonda, D., 212, 360  
 Mussweiler, T., 63n  
 Mwangi, W., 412  
 Mycielska, K., 210  
 Myers, B., 278  
 Myers, L. J., 310, 315  
 Myerson, J., 52, 86  
 Myin, E., 185, 331  
 Nadel, L., 29, 277–278, 280, 450  
 Nagell, K., 327  
 Naglieri, J., 316  
 Naglieri, J. A., 458  
 Naidu, N. V. R., 442  
 Nairne, J. S., 191  
 Nakamura, J., 428  
 Narciss, S., 458  
 Nastasi, B. K., 335  
 Nation, J. R., 24  
 Nau, P., 59  
 Naumann, J., 213, 215, 218  
 Naveh-Benjamin, M., 44, 460  
 Neal, C. J., 133n  
 Nebelsick-Gullet, L., 387  
 Nee, D. E., 170n, 176, 179  
 Neef, N. A., 335  
 Neisser, U., 6, 141, 161, 167, 185, 267, 271, 273  
 Neitzel, C., 357, 463  
 Neitzel, C. L., 464  
 Nelson, B., 438  
 Nelson, C. A., 22, 23, 26, 27, 28, 29, 223, 224n, 280  
 Nelson, C. A., III, 22, 223, 280  
 Nelson, K., 207, 222n, 247, 274, 329, 332  
 Nelson, L. J., 262  
 Nelson, T., 26  
 Nelson, T. O., 176, 179, 191, 275, 366  
 Nemer, K. M., 341  
 Nenty, H. J., 487  
 Nersessian, N. J., 197, 225  
 Nesbit, J. C., 360  
 Neuberger, S. L., 434  
 Neuman, Y., 335  
 Neumann, P. G., 237  
 Neumann, R., 479  
 Neuschatz, J. S., 244, 274, 279  
 Neville, H. J., 22, 26, 27  
 Nevin, J. A., 75  
 Newberg, N. A., 442  
 Newby, T. J., 214  
 Newcombe, N. S., 224, 280, 300  
 Newcomer, L. L., 99  
 Newell, A., 411  
 Newell, L., 327  
 Newman, G. E., 247  
 Newman, M. L., 455  
 Newman, R. S., 357, 470, 471, 488  
 Newman, S. E., 325, 384, 419  
 Newmann, F. M., 445  
 Newport, E. L., 25, 29  
 Newson, E., 327  
 Newson, J., 327  
 Newstead, S., 212, 287  
 Ng, E. L., 403  
 Ng, S. F., 403  
 Nguyen, S. P., 243  
 Ni, Y., 390  
 NICHD Early Child Care Research Network, 30  
 Nicholls, J., 470, 480  
 Nicholls, J. G., 468, 473, 481, 497  
 Nichols, C. W., 474  
 Nichols, J. D., 60, 341  
 Nichols, S. L., 495  
 Nichols, S. R., 328  
 Nickerson, R. S., 209, 287  
 Nie, Y., 470, 472  
 Niederhauser, D. S., 195, 213, 215, 355  
 Nielsen, M., 119  
 Niefeld, J. L., 387  
 Niggli, A., 445  
 Nijhawan, R., 185  
 Nijhuis, J. G., 279  
 Nir, M., 496  
 Nisbett, R. E., 30, 32, 81, 302  
 Nist, S. L., 383  
 Nix, G., 438  
 Njoroge, R., 248  
 Noar, S., 432  
 Noguera, P. A., 62  
 Nokes, J. D., 365, 381, 384  
 Nolan, J., 492  
 Nolan, J. D., 362  
 Nolen, S. B., 356, 455, 464, 466, 470, 473  
 Nordby, C. J., 387, 498  
 Nordgreen, J., 36  
 Nordgren, L. F., 177, 408  
 Norman, D. A., 175, 214, 232, 267  
 Normandeau, S., 481  
 Northrup, J., 74, 83  
 Novak, J. D., 200, 212, 215, 231, 360, 390  
 Novick, L. R., 413  
 Ntoumanis, N., 437  
 Nucci, L. P., 59, 91, 138  
 Nugent, L. D., 162, 171  
 Nundy, S., 449  
 Núñez, J. C., 487  
 Núñez, R. E., 247  
 Nussbaum, E. M., 335, 422, 423, 424, 459  
 Nuthall, G., 200

NI-14 NAME INDEX

- Nyberg, S. E., 176  
 Nystrand, M., 331
- Oakes, L. M., 237, 261, 266, 280, 320  
 Oakhill, J., 200, 355  
 Oatley, K., 449  
 Oberheim, N. A., 16, 28  
 O'Brien, D. P., 302  
 O'Brien, G., 234  
 O'Brien, M., 495  
 O'Byrne, W. I., 355  
 O'Connor, J. E., 404  
 Odegard, T. N., 279  
 O'Donnell, A. M., 215, 250, 326, 336, 341, 342, 344  
 O'Donnell, J., 53  
 Ogbu, J. U., 384  
 O'Grady, W., 27  
 Ogwu, N. E., 487  
 Ohlsson, S., 253  
 Öhman, A., 38, 447  
 Oishi, S., 193, 434  
 Okamoto, Y., 302, 303, 304, 305, 311  
 O'Kelly, J., 341, 342  
 Olajide, J. O., 285  
 Olds, J., 431  
 O'Leary, S. G., 59, 82, 88  
 Olejnik, S., 383  
 Oliva, A., 197  
 Olivier, E., 226  
 Ollendick, T. H., 453  
 Olneck, M. R., 474  
 Olson, D. R., 301  
 Olson, E. A., 275  
 Olson, M. A., 37, 40  
 Olson, R., 74  
 O'Mara, A. J., 128n  
 Omelich, C. L., 444, 480  
 O'Neil, H. F., 450  
 O'Neil, H. F., Jr., 407, 460  
 O'Neil, R. E., 182  
 Onosko, J. J., 337, 338, 445  
 Oostdam, R., 106  
 Opfer, J. E., 235  
 Op't Eynde, P., 376  
 Orasanu, J. M., 392  
 O'Regan, J. K., 185, 331  
 Ormond, T., 55  
 Ormrod, J. E., 201, 202, 203, 205, 248, 294, 359, 403, 411, 487  
 Ormrod, R. K., 201, 202, 203, 214  
 Ornstein, P. A., 327, 353, 374, 383, 384  
 Ornstein, R., 20, 21  
 Ortiga, Y. P., 467  
 Ortiz, C., 123  
 Ortony, A., 243  
 Osana, H. P., 423, 459  
 Osborn, A. F., 411
- Osborne, J. W., 455  
 Osgood, C. E., 150, 394  
 Osgood, D. W., 466  
 O'Shaughnessy, T. E., 169  
 Osher, D., 99  
 Oskamp, S., 262  
 Osnes, P. G., 134  
 Ossher, L., 276  
 Osterman, K. F., 459  
 Ostrovsky, Y., 25  
 O'Sullivan, J. T., 375  
 Otero, J., 256, 364, 366, 386  
 Otter, M. E., 106  
 Ottinger-Albergs, W., 280  
 Overmaat, M., 106  
 Overmier, J. B., 430, 486  
 Owens, J., 195  
 Owens, R. E., 205, 316  
 Ozgungor, S., 343  
 Öztekin, I., 175, 180
- Paas, F., 182, 334  
 Pace, G. M., 87  
 Packer, D. J., 42  
 Padden, D., 26  
 Page-Voth, V., 493  
 Paige, J. M., 413  
 Paivio, A., 150, 197, 225, 225n, 227, 228  
 Pajares, F., 113, 117, 118, 127, 128, 129, 130, 136, 139, 356, 379, 436, 478, 480, 493  
 Palincsar, A. S., 309, 320, 326, 335, 337, 338, 339, 340, 340n, 341, 342, 354, 355, 363  
 Paller, K. A., 168  
 Pallock, L., 363  
 Palmer, D. J., 382, 387, 480  
 Palmer, J. C., 271  
 Palmiero, M., 224  
 Pan, J., 377, 423  
 Pandeirada, J. N. S., 191  
 Pani, A. M., 243  
 Pani, J. R., 243  
 Pansky, A., 276  
 Pantev, C., 24  
 Papka, M., 42  
 Pappas, S., 300  
 Pappas, T., 106  
 Paris, A. H., 357, 383, 385, 386, 427, 494  
 Paris, S. G., 212, 357, 374, 383, 385, 386, 427, 456, 481, 486, 488, 494  
 Park, E. S., 336  
 Park, L. E., 436  
 Park, N., 434  
 Park, O., 242  
 Park, S.-H., 377, 423  
 Park, S. W., 473, 484  
 Parke, R. D., 91, 117
- Parker, J., 273  
 Parker, R. E., 228  
 Parker, S. T., 7  
 Parkhurst, J. T., 475  
 Parks, N. A., 176  
 Parsons, J. E., 59  
 Pascarella, E. T., 301  
 Pascual-Leone, J., 303  
 Pashler, H., 149, 167, 208, 209, 218, 283, 286, 416  
 Pastorelli, C., 128  
 Patall, E. A., 438  
 Patnode, M., 92, 94  
 Patrick, H., 308, 336, 378, 379, 427, 441, 442, 470, 474, 499  
 Patrick, J., 459  
 Patterson, M. L., 206  
 Pauen, S., 300  
 Pavlov, I. P., 34  
 Payment, K. E., 275  
 Payne, D. G., 273, 274, 278  
 Payne, J. D., 28, 200, 227  
 Pea, R. D., 331, 399, 415  
 Peace, K. A., 278  
 Pear, J. J., 67, 108  
 Pearrow, M., 96  
 Pearson, D., 415  
 Pearson, P. D., 201, 205, 212, 354  
 Pease, M., 199, 301, 308, 341, 382  
 Pekrun, R., 181, 432, 438, 447, 448, 449, 453, 455, 458, 470, 471, 479, 489, 497  
 Pekrun, R. H., 487  
 Péleadeau, N., 208  
 Pellegrini, A. D., 62, 182, 318, 415, 458, 474  
 Pelletier, J., 377  
 Penfield, W., 275  
 Penner, B. D., 404  
 Penny, J. A., 287, 420  
 Penrose, A. M., 212  
 Pepe, H. J., 134  
 Pereira, A. C., 24  
 Perencevich, K. C., 438, 491  
 Perfect, T. J., 274, 275  
 Perfetti, C. A., 21, 176, 235  
 Perin, C. T., 430  
 Perkins, D. N., 324, 337, 377, 390, 392, 393, 396, 398, 398n, 408, 414, 415, 416, 445, 459  
 Perner, J., 301  
 Perret-Clermont, A., 309  
 Perrig, W., 393  
 Perry, A. C., 84  
 Perry, D. G., 91  
 Perry, L., 242  
 Perry, L. C., 91  
 Perry, L. K., 242
- Perry, M., 397  
 Perry, N. E., 386, 387, 418, 452, 494, 498  
 Perry, R. P., 181, 196, 432, 441, 447, 476, 487, 497  
 Perry, W. G., 377  
 Person, N. K., 346  
 Pesetsky, D., 21, 176, 235  
 Peskin, J., 259  
 Petersen, S. E., 222  
 Peterson, C., 432, 434, 465n, 485, 486, 487, 498  
 Peterson, C. R., 61  
 Peterson, L., 97  
 Peterson, L. R., 170, 172, 175  
 Peterson, M. A., 167n  
 Peterson, M. J., 170, 172, 175  
 Peterson, N. J., 82, 89  
 Peterson, P. L., 322, 323, 496  
 Peterson, S. E., 341  
 Petri, H. L., 434  
 Petrie, S., 441  
 Petrosino, A., 413  
 Pettito, A. L., 323  
 Petty, R. E., 445  
 Petursdottir, A. I., 401  
 Peverly, S. T., 360, 362, 392, 397  
 Pezdek, K., 228, 273, 277, 278, 278n  
 Piffner, L. J., 59, 60, 82, 88, 182  
 Phelan, P., 453  
 Phelps, E. A., 20, 448  
 Phillips, B. N., 454  
 Phillips, D., 407  
 Phillips, E. A., 60  
 Phillips, E. L., 60  
 Phillips, L., 175  
 Phye, G. D., 156, 218  
 Piaget, J., 6, 11, 290, 291n, 293, 295n, 296, 297, 301, 302, 435  
 Pianko, S., 210  
 Piazza, C. C., 83, 93n  
 Pichert, J. W., 245, 279  
 Pierce, S. H., 383  
 Pierce, S. S., 379  
 Pierce, W. D., 439, 457  
 Pierroutsakos, S. L., 278  
 Pigott, H. E., 97  
 Pillemer, D. B., 274  
 Pillow, B. H., 422  
 Pine, K. J., 256  
 Pimker, S., 26, 213, 228, 261, 315  
 Pintrich, P. R., 59, 130, 139, 253, 255, 256, 335, 375, 376, 377, 378, 379, 380, 427, 428, 434, 443, 446n, 447, 448, 463, 468n, 470, 477, 488  
 Piontkowski, D., 182

- Piotrowski, J., 106  
 Pipkin, C. S., 88  
 Pipkin, C. S. P., 66, 69, 87  
 Pitcher, G. D., 454  
 Pittman, T. S., 434, 437  
 Platsidou, M., 171  
 Plaud, J. J., 44  
 Plemons, B. W., 22, 27, 29  
 Plotnik, J. M., 7  
 Plotts, C. A., 109, 134  
 Plumert, J. M., 374  
 Plunkett, K., 234  
 Poche, C., 122  
 Poldrack, R. A., 223  
 Poling, A., 67, 76, 84  
 Pollak, S. D., 29  
 Pollica, L. S., 384  
 Pollini, S., 364  
 Polman, J. L., 333, 342  
 Polya, G., 401, 402  
 Pomerantz, E. M., 479  
 Poole, D., 287  
 Poortvliet, P. M., 470  
 Popham, W. J., 101  
 Porat, D. A., 204, 252, 253, 254  
 Porter, A., 404, 417  
 Porter, S., 278  
 Posada, M. L., 130  
 Posner, G. J., 101, 253, 256, 379  
 Posner, M. I., 16, 21, 22, 28, 86, 163, 169, 170n, 393  
 Post, T. A., 404  
 Postman, L., 175, 178, 276  
 Potenza, M. T., 387  
 Potter, E. F., 216  
 Poulson, C. L., 122, 125, 217  
 Powell, S., 438  
 Prattini, R., 395  
 Prawat, R. S., 108, 156, 212, 413  
 Premack, D., 54  
 Pressley, M., 156, 197, 205, 211, 335, 343, 358, 363, 369, 374, 381, 382, 383, 384, 385, 387, 479, 481  
 Preston, K. L., 76  
 Preston, R. A., 54  
 Pribham, K. H., 368  
 Price-Williams, D. R., 302  
 Prince, J., 222  
 Principe, G. F., 272  
 Prinz, J., 156, 331  
 Prior, H., 7  
 Pritchard, R., 244  
 Proctor, R. W., 208, 259  
 Proffitt, D. R., 205  
 Prout, H. T., 456  
 Pruitt, J., 26  
 Pugh, K. J., 138, 283, 396, 427, 470, 492  
 Pulos, S., 204, 249, 301, 302, 309, 310, 454  
 Puntambekar, S., 323  
 Purdie, N., 378, 383  
 Putwain, D. W., 454  
 Qian, G., 377, 423  
 Qin, Z., 341, 419  
 Quartz, S. R., 22  
 Quas, J. A., 275  
 Quillian, M. R., 229, 230, 231  
 Quinn, D. M., 436  
 Quinn, P. C., 146, 236, 241  
 Quintana, C., 385  
 Rabinowitz, H. S., 405  
 Rachlin, H., 33, 34, 38, 54, 65, 75, 145, 431  
 Radel, R., 455  
 Radke-Yarrow, M., 124  
 Radziszewska, B., 320, 329, 330, 333  
 Rahm, J., 138, 326  
 Raine, A., 445, 446  
 Raison, J., 60  
 Rakison, D. H., 163, 236, 239, 241, 261, 320  
 Rakow, E. A., 365  
 Ramirez, M., 302  
 Ramsay, C. M., 245  
 Randich, L., 86  
 Ranyard, R., 417  
 Rappolt-Schlichtmann, G., 24  
 Rapport, M. D., 60  
 Rasch, B., 28, 199  
 Rasp, L. M., 115  
 Rastegar, N., 217  
 Ratcliff, R., 235, 238  
 Ratcliff, R. A., 180  
 Ratelle, C. F., 491  
 Ratey, J. J., 225n, 280  
 Ratner, H. H., 328, 415  
 Raudenbush, S. W., 30, 495  
 Ravitz, J., 333  
 Rawson, K. A., 208, 387, 395  
 Rawsthorne, J., 470  
 Ray, W. J., 278  
 Rayner, K., 21, 176, 235  
 Rayner, R., 37  
 Raynor, J. O., 444  
 Rayport, S. G., 22  
 Real, J. E., 144  
 Reason, J., 210  
 Reason, R., 106  
 Reber, A., 91  
 Reber, A. S., 224  
 Redd, W. H., 95  
 Reder, L. M., 156, 195, 217, 333, 396  
 Redford, J. S., 365  
 Reed, D. D., 208, 217  
 Reed, H. B., 152  
 Reed, P., 70  
 Reed, S., 197, 225  
 Reed, S. K., 408  
 Reese, E., 207, 280, 321, 332  
 Reese, H. W., 35  
 Reeve, J., 428, 434, 437, 438, 439, 441, 456, 457, 458, 491, 493  
 Reeve, R., 347  
 Reeves, A., 28  
 Régner, I., 455, 468  
 Rehfeldt, R. A., 86  
 Reichle, E. D., 352n  
 Reid, R., 135  
 Reigeluth, C. M., 360  
 Reimann, P., 412  
 Reineberg, A. E., 352n  
 Reiner, M., 244, 250  
 Reinking, D., 340  
 Reisberg, D., 33, 38, 176, 197, 225, 241, 448  
 Reiser, B. J., 332, 333  
 Reiser, R. A., 108  
 Reis-Henrie, F. P., 464  
 Reiss, D., 7  
 Reissland, N., 27  
 Reiter, S. N., 337  
 Reitman, J. S., 171  
 Reitman, W. R., 418  
 Rellinger, E. A., 410  
 Remington, R., 267  
 Remington, R. W., 166  
 Renkl, A., 207, 390, 410, 412, 415, 418  
 Renninger, K. A., 182, 448, 462, 463, 464, 492, 497  
 Repacholi, B. M., 122  
 Repetti, R., 24  
 Repman, J., 498  
 Rescorla, R. A., 36, 38, 42  
 Resnick, L. B., 196, 244, 332, 403, 414, 417  
 Reuman, D., 441  
 Reuman, D. A., 211, 460, 491  
 Reyna, C., 206, 483  
 Reyna, V. F., 52, 146n, 227, 270, 272, 273, 276, 278, 279  
 Reynolds, C., 445  
 Reynolds, G. S., 70, 71  
 Reynolds, J. R., 197, 224  
 Reynolds, R. E., 191, 203, 244, 245, 363  
 Reys, B. J., 341  
 Reznick, S., 168  
 Rhodewalt, F., 435, 436  
 Ricciardi, J. N., 43  
 Ricco, R., 379  
 Richards, A., 448  
 Richards, A. C., 452  
 Richards, F., 452  
 Richards, J. M., 489  
 Richardson, R., 280  
 Richardson, V., 204  
 Richeson, J. A., 454  
 Richey, D. D., 94  
 Richter, M., 99  
 Richter, T., 215  
 Rickard, J. F., 67  
 Rickert, E. J., 55  
 Riding, R. J., 197  
 Riggs, J. M., 436  
 Rijlaarsdam, G., 122, 363  
 Rikers, R., 207  
 Rimm, D. C., 109  
 Rincover, A., 61  
 Rinehart, S. D., 364  
 Ringdahl, J. E., 76, 88  
 Rips, L. J., 231, 237, 260  
 Risemberg, R., 357, 488  
 Ristic, J., 164, 327  
 Ritchart, R., 337, 377, 445, 459  
 Ritchey, G. H., 228  
 Ritchie, B. F., 143, 144  
 Rittle-Johnson, B., 262  
 Ritov, H., 117  
 Rittenhouse, P., 337, 375, 419  
 Rittle-Johnson, B., 211, 323, 415, 418  
 Ritts, V., 206  
 Rizza, M. G., 491  
 Roane, H. S., 88  
 Roazzi, A., 302  
 Robbins, P., 331  
 Robbins, T. W., 16  
 Roberts, A. C., 16  
 Roberts, G. C., 472  
 Roberts, L., 275  
 Roberts, R. D., 446  
 Robertson, B., 486  
 Robertson, J. S., 496  
 Robins, R. W., 141  
 Robinson, D. H., 360  
 Robinson, D. R., 326, 344, 346  
 Robinson, E. J., 274, 300  
 Robinson, F. G., 141, 213, 229  
 Robinson, H. B., 71  
 Robinson, N. M., 71  
 Robinson, N. S., 443  
 Robinson, S. L., 97, 98  
 Robinson, T. E., 24  
 Rock, D. A., 206  
 Rockstroh, B., 24  
 Rodriguez, N. M., 54  
 Roedel, T. D., 466  
 Roediger, H. L., 78, 148, 223, 248, 273, 279, 286  
 Roehler, L. R., 205, 354  
 Roeser, R. W., 131, 442, 459  
 Roeyers, H., 417  
 Rogers, C. R., 433

NI-16 NAME INDEX

- Rogers, T. B., 193  
 Rogers, T. T., 234  
 Rogoff, B., 302, 320, 321,  
 323, 324, 329, 330, 332,  
 333, 336, 347, 399, 419  
 Rogozinski, J. T., 362  
 Rohrbeck, C. A., 341  
 Rohrer, D., 149, 208, 218,  
 286, 416  
 Rohrkemper, M. M., 498  
 Rohwer, W. D., 371  
 Roll, I., 385  
 Román, P., 277  
 Romanczyk, R. G., 51, 82  
 Romaniuk, C., 56  
 Rommetveit, R., 327  
 Ronning, R. R., 336  
 Rortvedt, A. K., 60  
 Rosabianca, A., 454  
 Rosales-Ruiz, J., 119n  
 Rosch, E. H., 237, 243  
 Roschelle, J., 340n  
 Roscoe, R. D., 215, 326, 344,  
 345  
 Rose, S. A., 237  
 Rose, S. C., 443  
 Rose-Krasnor, L., 206  
 Rosenberg, E. L., 446n  
 Rosenberg, J. L., 123  
 Rosenshine, B., 340, 364,  
 366  
 Rosenthal, H., 357, 489  
 Rosenthal, R., 137, 495  
 Rosenthal, T. L., 111, 115,  
 116, 117, 120, 122  
 Rösler, F., 228  
 Ross, B. H., 195, 238  
 Ross, D., 122, 270, 431  
 Ross, G., 323  
 Ross, K. A., 385  
 Ross, M., 191, 329  
 Ross, S. A., 122, 431  
 Roth, G., 436  
 Roth, K., 249, 256, 258, 324  
 Roth, W., 325  
 Roth, W.-M., 225  
 Rothbart, M. K., 16, 21, 22,  
 28, 86, 163, 169, 170n,  
 393  
 Rothbart, R., 176  
 Rothbaum, B. O., 44  
 Rothbaum, F., 377, 441, 442,  
 487  
 Rotunda, R. J., 55  
 Roudier, J. N., 168, 238  
 Rovee-Collier, C., 42, 76,  
 208, 280  
 Rowe, M. B., 217, 285  
 Rowell, A., 84  
 Royer, J. M., 210, 245  
 Rubin, D. C., 154, 197, 228,  
 243, 271, 448  
 Rubin, K. H., 206  
 Rubinyi, S., 225n  
 Ruble, D., 121  
 Rude, H. A., 121  
 Rudnitsky, A. N., 101  
 Rudolph, K. D., 443  
 Rueckl, J. G., 235  
 Rueda, R., 427  
 Ruef, M. B., 92, 94  
 Rueger, D. B., 85  
 Ruffman, T., 301  
 Ruhl, K., 74  
 Ruhland, D., 444  
 Ruiz, I., 163  
 Rule, D. C., 335, 376, 380,  
 386  
 Rumelhart, D. E., 243  
 Rummel, N., 369  
 Runco, M. A., 411  
 Rundus, D., 191  
 Rüniger, D., 177, 223  
 Rusan, M., 217  
 Rusch, F., 59  
 Rushton, J. P., 124  
 Russell, C., 283  
 Russell, S. L., 459  
 Russell, W., 176  
 Russell, W. A., 151  
 Rust, F., 211, 286, 440  
 Ruthig, J. C., 196, 441, 487  
 Ruthren, A. J., 85  
 Ruthruff, E., 167  
 Ryan, A. M., 103, 436, 441,  
 442, 468n, 470, 474, 488,  
 494  
 Ryan, C. S., 428, 457  
 Ryan, K., 138  
 Ryan, K. E., 103, 468n  
 Ryan, M. K., 122  
 Ryan, R., 490  
 Ryan, R. M., 81, 102, 434,  
 437, 438, 439, 440, 441,  
 456, 477, 490, 491, 498  
 Ryan, S., 55  
 Sabo, B., 69  
 Sadoski, M., 197, 225, 225n,  
 228  
 Saffran, J. R., 239  
 Sahakyan, L., 181  
 Saia, J., 381  
 Sak, K., 236  
 Saljo, R., 395  
 Salk, S., 128, 212, 448  
 Sallas, B., 395  
 Salmon, K., 207, 329  
 Salomon, G., 144, 218, 227,  
 260, 331, 390, 392, 393,  
 398, 398n, 416  
 Salonen, P., 358  
 Salthouse, T. A., 393, 402  
 Saltz, E., 238  
 Samarapungavan, A., 308  
 Samarova, E. I., 36  
 Samenieh, A., 277  
 Sameoto, D., 59  
 Sameroff, A. J., 442  
 Samuel, A. L., 410  
 Samuels, M., 103, 468n  
 Samuels, S. J., 182, 210, 217  
 Samuelson, L. K., 242  
 Sanchez, R. P., 411  
 Sandmann, A., 360  
 Sandmel, K., 493  
 Sansone, C., 443, 489  
 Santa, J. L., 399  
 Santangelo, T., 123, 210  
 Santomero, A., 419  
 Sapolsky, R. M., 28  
 Saracho, O. N., 318  
 Sarama, J., 301, 308  
 Sarason, I. G., 460  
 Sarlo, N., 300, 320  
 Sarrazin, P., 455  
 Sasso, G. M., 121  
 Saults, J. S., 162, 169  
 Saunders, J., 277, 480  
 Saunders, M., 96, 97  
 Savani, K., 442  
 Savelsbergh, E. R., 470  
 Saville, B. K., 335  
 Sawyer, R. J., 123  
 Sawyer, R. K., 103, 156  
 Saxbe, D., 24  
 Saxon, J. L., 479  
 Scandura, J. M., 410  
 Scardamalia, M., 156, 325,  
 347, 349, 374, 380, 420  
 Scattone, D., 93n  
 Scevak, J. J., 360  
 Schaal, D. W., 53  
 Schab, F., 270  
 Schacter, D. L., 170, 205,  
 235, 274, 276, 280  
 Schaeffert, D. L., 488  
 Schäfer, M., 300  
 Schaller, M., 434  
 Schallert, D. L., 203, 336,  
 479  
 Schank, R. C., 244  
 Schartz, M., 135  
 Schauble, L., 301, 308  
 Scheier, M. F., 448, 487  
 Scheiter, K., 415, 416  
 Scheja, M., 245n  
 Schellings, G. L. M., 363  
 Schenk, S. M., 359  
 Scher, D., 45  
 Schettler, T., 24  
 Scheuermann, B., 135  
 Schiller, R. N., 242  
 Schiller, D., 43n  
 Schimmoeller, M. A., 316  
 Schlager, M. S., 415  
 Schliemann, A. D., 301, 302,  
 331, 454  
 Schlosberg, H., 417  
 Schloss, P. J., 60, 95, 100  
 Schmader, T., 454  
 Schmid, S., 357  
 Schmidt, H. G., 420  
 Schmidt, K., 283  
 Schmidt, R. A., 218, 390,  
 397, 398  
 Schmidt, W. H., 104  
 Schmolck, H., 271  
 Schneider, W., 202, 209, 343,  
 365, 374, 382, 479, 481  
 Schnyder, I., 445  
 Schoenbaum, G., 41  
 Schoener, J., 456  
 Schoenfeld, A. H., 353, 376,  
 402, 404, 409, 413, 417,  
 418  
 Schofield, J. W., 326  
 Scholes, R. J., 378, 423, 424,  
 445  
 Schommer, M., 376, 377,  
 378, 379, 386  
 Schommer-Aikins, M., 376,  
 377, 378, 379, 423, 446  
 Schonert-Reichl, K., 459  
 Schooler, J. W., 278, 352n, 410  
 Schooler, L. J., 280  
 Schraw, G., 243, 245, 260,  
 336, 376, 378, 385, 387,  
 409, 456, 463, 464  
 Schrijnemakers, H., 376  
 Schroth, M. L., 387  
 Schul, Y., 467  
 Schult, C. A., 373  
 Schult, T. J., 412  
 Schultheiss, O. C., 427, 475  
 Schultz, K., 412, 413  
 Schultz, R. W., 150  
 Schulz, L. E., 121  
 Schulze, S. K., 464  
 Schumacher, E. H., 167, 170  
 Schumaker, J. B., 213, 372  
 Schumer, H., 109  
 Schunk, D. H., 59, 112, 113,  
 117, 118, 121, 122, 123,  
 127, 128, 129, 130, 131,  
 132, 133n, 134, 136, 139,  
 356, 357, 434, 436, 437,  
 441n, 476, 477, 479, 481,  
 488, 493  
 Schupp, H. T., 449n  
 Schuster, C. R., 76  
 Schutz, P. A., 467, 474  
 Schwab, B. J., 106  
 Schwaborn, A., 216, 217,  
 397  
 Schwartz, A., 7, 117  
 Schwartz, B., 33, 38  
 Schwartz, B. B., 335  
 Schwartz, C. W., 123, 493  
 Schwartz, D. L., 30, 225,  
 396, 398, 415, 416

- Schwartz, N., 449  
 Schwebel, A. I., 182  
 Schweinhart, L. J., 30  
 Schweinle, A., 428  
 Schworm, S., 357, 488  
 Scoboria, A., 274  
 Scott, B., 259, 397  
 Scott, P., 253  
 Scott, P. H., 156, 327  
 Scribner, S., 313–314  
 Scruggs, T. E., 368, 383, 496  
 Seamon, J. G., 273  
 Sears, K. G., 357  
 Sears, R., 431  
 Sedikides, C., 435, 442, 458, 484  
 Seegers, G., 484  
 Segers, M., 420  
 Segmen, J., 152, 368  
 Seidenberg, M. S., 21, 176, 235  
 Sejnowski, T. J., 22  
 Sekuler, A. B., 162  
 Sekuler, R., 162  
 Seligman, M. E. P., 8, 9, 356, 484, 485, 486, 487  
 Semb, G. B., 108, 215, 269, 275, 326  
 Senécal, C., 491  
 Senko, C., 470, 471, 494  
 Serences, J. T., 169  
 Sergeant, J., 167  
 Serra, M. J., 356, 366, 386  
 Sfarid, A., 156, 213  
 Shabani, D. B., 401  
 Shah, J. Y., 467, 475  
 Shah, P., 170, 217  
 Shalev, A. Y., 487  
 Shanahan, C., 256, 424  
 Shanahan, T., 207, 364  
 Shany, M., 326  
 Shapiro, A. M., 200, 347  
 Shapiro, D., 16  
 Shapiro, L. J., 414  
 Shapley, K. S., 387  
 Sharma, R., 357, 488n  
 Sharot, T., 20, 448  
 Sharpnack, H., 146  
 Shaw, J. C., 411  
 Shaw, R., 360  
 Shaw, V., 257, 336  
 Shea, M. C., 134  
 Shea, T. M., 61  
 Sheehan, E. A., 21  
 Sheehan, E. P., 374, 377  
 Sheese, R., 300  
 Sheffield, F. D., 431  
 Sheldon, K. M., 456, 472, 494  
 Shell, M. M., 473  
 Shellman, J., 59, 90  
 Shepard, L., 211, 286, 287, 440  
 Shepard, R. N., 169, 170, 225  
 Shepardson, D. P., 341  
 Sheppard, J. A., 448  
 Sherman, D. K., 253, 257, 435  
 Sherman, J., 308  
 Sherman, J. W., 206  
 Sherman, M., 413  
 Shernoff, D. J., 429, 448, 452, 464, 470, 497  
 Sherwood, R. D., 419  
 Sheya, A., 231  
 Shiffirin, R. M., 160, 163, 176, 191, 209  
 Shim, S. S., 470, 474  
 Shimmerlick, S. M., 362  
 Shimoff, E., 69  
 Shin, D., 74  
 Shirey, L. L., 191, 244, 363  
 Shirk, S. R., 443  
 Shoben, E. J., 231, 237  
 Sholte, H. S., 162  
 Shors, T. J., 28  
 Shui, S.-H., 470, 471  
 Shulman, H. G., 176  
 Shute, V. J., 55, 83, 127, 208, 217, 218, 286, 353, 357, 360, 427, 494  
 Shwalb, B. J., 383  
 Shymansky, J. A., 415  
 Sideridis, G. D., 470  
 Siegel, B., 225n  
 Siegel, D. J., 15, 20, 21, 29, 177, 199, 224n, 275, 279, 448  
 Siegel, S., 42, 76  
 Siegler, R. S., 177, 235, 247, 256, 262, 301, 302, 358, 382, 410  
 Sigman, M., 24  
 Silberstein, C. S., 253  
 Silver, E. A., 287, 414, 419  
 Silver, R., 454  
 Silverman, K., 76  
 Silverman, W. K., 44, 450  
 Silvia, P. J., 462  
 Simcock, G., 280  
 Simmons, D. C., 106, 326  
 Simmons, J. Q., 88  
 Simmons, R., 408  
 Simmons, W. K., 224  
 Simon, H. A., 156, 169, 217, 333, 396, 411, 413, 417, 418  
 Simon, S. J., 82  
 Simons, J., 445, 446, 465, 492  
 Simpson, M. L., 383  
 Sims, R. B., 442  
 Sinatra, G. M., 245, 253, 256, 257, 335, 379, 380, 445, 446, 447, 463, 470  
 Singh, M., 272  
 Singley, M. K., 397  
 Sinha, P., 25  
 Sins, P. H. M., 470  
 Siskin, L. S., 103  
 Sizer, T. R., 262  
 Skaalvik, E. M., 128, 131, 139, 436, 470, 488  
 Skaalvik, S., 131  
 Skiba, R., 60  
 Skiba, R. J., 62  
 Skinner, B. F., 50, 58, 63, 67, 79, 82, 87, 92, 104, 137, 157, 211, 401  
 Skinner, C. H., 75  
 Skinner, E., 437, 438, 442  
 Skinner, E. A., 481  
 Skopeliti, I., 249  
 Skurnik, I., 449  
 Slater, A., 27  
 Slater, W. H., 340  
 Slavin, R. E., 97, 102, 335, 340n, 341, 342, 344  
 Sligte, I. G., 162  
 Sloman, K. N., 88  
 Slotta, J. D., 244, 255  
 Sloutsky, V. M., 261  
 Slusher, M. P., 255  
 Smal, L., 146n  
 Small-McGinley, J., 91  
 Smilek, D., 164, 327  
 Smiley, P. A., 436  
 Smith, B. L., 340n  
 Smith, C. A., 449  
 Smith, C. L., 250, 252, 253, 256, 298n, 309, 335, 337  
 Smith, D. R., 395  
 Smith, E. E., 170, 231, 237  
 Smith, E. L., 204  
 Smith, E. R., 252, 331  
 Smith, H. V., 377  
 Smith, J., 443  
 Smith, J. D., 237, 238  
 Smith, L., 231  
 Smith, L. B., 21, 240  
 Smith, M. A., 60, 95, 100  
 Smith, P. K., 415  
 Smith, P. R., 465, 467, 474  
 Smith, R. E., 55, 82  
 Smith, R. G., 83  
 Smith, S. M., 269, 278  
 Smolkin, L. B., 127n  
 Smoll, F. L., 55, 82  
 Sneider, C., 204, 249  
 Snow, C., 329  
 Snow, R. E., 109, 495  
 Snowdon, D., 393  
 Snowman, J., 358n, 364, 368  
 Snycerski, S., 76  
 Snyder, C. R., 471  
 Snyder, K. A., 164, 191  
 Snyder, L. E., 354  
 Snyder, M., 206  
 Snyder, S. S., 441, 487  
 Snyder, T. E., 256  
 Snyder-Hogan, L. E., 200, 354  
 Sodian, B., 301  
 Soeda, J. M., 87  
 Soenens, B., 437  
 Sokal, R. R., 216  
 Solnick, J. V., 61  
 Soloman, P., 432  
 Solomon, G. E. A., 251  
 Solomon, S. K., 195  
 Soloway, E., 342  
 Son, L. K., 35+n  
 Songer, N. B., 341, 376  
 Soohoo, S., 122, 199, 217  
 Soriano, M. F., 277  
 Southerland, S. A., 253, 256, 257, 380, 445, 446, 470  
 Sowell, E. R., 23, 24  
 Sowers, J., 95  
 Spanoudis, G., 171  
 Spatarium, A., 409, 417  
 Spaulding, C. L., 89, 440, 457, 494, 497, 498  
 Spaulding, T. L., 238  
 Speer, N. K., 197, 224, 226  
 Spelke, E. S., 27, 28, 167, 247  
 Spence, I., 217  
 Spence, K. W., 430  
 Spence, M. J., 279  
 Spencer, S., 463  
 Spencer, S. J., 454  
 Sperling, R., 162  
 Sperling, R. A., 245, 473  
 Spielberger, C. D., 116, 452, 460  
 Spilich, G. J., 202  
 Spindler, A., 123  
 Spires, H. A., 212  
 Spivey, N., 374  
 Spivey, N. N., 364  
 Spodek, B., 318  
 Spörer, N., 331, 345  
 Sporer, S., 228  
 Sporte, S. E., 333  
 Sprague, J. R., 99  
 Springston, F., 171  
 Spunt, R. P., 226, 331  
 Squire, L. R., 29, 176, 271  
 Sran, S. K., 98  
 Stacey, K., 336  
 Stackhouse, T. L., 369  
 Staddon, J. E. R., 66, 69  
 Staffieri, A., 343  
 Stafford, K. B., 364  
 Stahl, E., 357, 488  
 Stahl, G., 348  
 Stahl, S. A., 364, 424  
 Standage, M., 437  
 Stanovich, K. E., 358, 423, 445

NI-18 NAME INDEX

- Star, J. R., 415  
 Starr, E. J., 381  
 Stauber, K. A., 119  
 Stea, D., 144  
 Steele, C. M., 454  
 Steers-Wentzell, K. L., 326  
 Stefanou, C. R., 438, 456, 491  
 Steffensen, M. S., 244  
 Stein, A. H., 124  
 Stein, B. S., 178, 196, 407, 415  
 Stein, S., 384  
 Steinberg, L., 23, 24, 52, 86  
 Steinhorst, R., 55  
 Stennett, B., 195  
 Stensvold, M. S., 360  
 Stepans, J., 248, 254  
 Stephan, C. W., 206  
 Stephan, W. G., 206  
 Stephens, C. E., 67  
 Stephenson, J., 182  
 Stephenson, K. M., 305  
 Stepich, D. A., 214  
 Stern, E., 308  
 Sternber, S., 172  
 Sternberg, R. J., 301, 396, 408, 415, 417, 420, 445, 495  
 Stevens, J., 464  
 Stevens, R. J., 335, 341, 344  
 Stevenson, H. C., 135  
 Stevenson, H. W., 129  
 Stewart, A. D., 437  
 Stewart, A. L., 436  
 Stewart, V. C., 396, 470  
 Stiggins, R., 101, 102  
 Stiles, J., 21  
 Stimpson, V., 252, 257, 283  
 Stimson, M., 195  
 Stipek, D. J., 437, 457, 465, 478, 483, 484, 497, 498  
 Stitzer, M. L., 76  
 Stoberock, B., 63n  
 Stocker, C., 443  
 Stockley, C. B., 357  
 Stodolsky, S. S., 128, 212, 448  
 Stokes, J. V., 208, 217  
 Stokes, S. A., 278  
 Stokes, T. F., 95, 134  
 Stone, J. R., 415  
 Stone, N. J., 365, 424  
 Storm, B. C., 277, 407  
 Story, R., 374  
 Story, T., 486  
 Stowe, R. M., 123  
 Strand, P. S., 82  
 Straus, M. A., 88  
 Strauss, N. L., 465  
 Strayer, D. L., 167  
 Strick, M., 177, 408  
 Stright, A. D., 357  
 Strike, K. A., 253, 256, 379  
 Strømsø, H. I., 364  
 Strozer, J. R., 25  
 Stufkens, J., 376  
 Stull, A. T., 215  
 Stunkard, A. J., 37  
 Stupnisky, R. H., 181, 432, 441, 476, 497  
 Stylos-Allan, M., 200  
 Suárez, L. D., 146n, 416n  
 Sue, S., 477, 484  
 Suebsonthi, P., 242  
 Sugrue, B., 341  
 Suina, J. H., 127n  
 Sullivan, H. J., 108  
 Sullivan, J. R., 344, 346  
 Sullivan, J. S., 60  
 Sullivan, M. W., 76, 447  
 Sullivan, P., 302  
 Sullivan, P. J., 82  
 Sullivan, R. C., 94  
 Suls, J. M., 365  
 Sumfleth, E., 360  
 Summers, J. J., 130, 456, 494  
 Sun, R., 395  
 Sun-Alperin, M. K., 390  
 Sunderman, G. L., 103  
 Surber, J. R., 363  
 Sussman, D. M., 108  
 Suthers, D. D., 348  
 Sutton, R. E., 455  
 Svetlova, M., 328  
 Swallow, K. M., 197, 224  
 Swan, K., 456  
 Swann, W. B., 206  
 Swanson, H. L., 169, 327, 402, 404  
 Sweeney, J. A., 24  
 Sweller, J., 176, 182, 197, 200, 216, 217, 245, 323, 403, 411, 412, 415  
 Swenson, L. C., 108  
 Sylvan, L., 427  
 Symons, S., 197  
 Szabadi, E., 67  
 Szabo, Z., 197  
 Takemoto, K. Y., 122, 199  
 Talarico, J. M., 271, 448  
 Tallon, M., 453  
 Talmi, D., 176  
 Tamburrini, J., 301  
 Tamir, M., 447  
 Tanaka, J. C., 354  
 Tanapat, P., 28  
 Tang, J.-C., 93, 94  
 Tarr, M. J., 144  
 Tarule, J., 377  
 Tarver, S. G., 155  
 Tate, W. F., 333  
 Taub, E., 24  
 Taub, J., 96  
 Tauer, J. M., 463, 464  
 Tavani, C. M., 248  
 Taylor, A. K., 256  
 Taylor, J. C., 51, 82  
 Taylor, J. R., 487  
 Taylor, M., 373  
 Taylor, M. A., 244  
 Taylor, S. E., 24  
 Teasley, S. D., 340n  
 Tenent, A., 340  
 Tennyson, R. D., 241, 242, 243  
 Terenzini, P. T., 301  
 Terrace, H. S., 354n  
 Tessier-Lavigne, M., 15, 16  
 Tessmer, M., 107  
 te Winkel, W. W. R., 420  
 Thal, D., 21  
 Thapar, A., 175  
 Tharp, R., 323  
 Tharp, R. G., 285  
 Théberge, C. L., 337  
 Thelen, E., 21  
 Therriault, D., 357  
 Thiagarajan, S., 243  
 Thiede, K. W., 357, 365, 386  
 Thillmann, H., 216, 397  
 Thoermer, C., 301  
 Thomas, A. K., 272  
 Thomas, E. L., 120  
 Thomas, J., 318  
 Thomas, J. G., 172  
 Thomas, J. W., 382, 460, 498  
 Thomas, K. L., 28  
 Thomas, K. M., 22, 223, 280  
 Thomas, M. A., 61  
 Thomas, M. H., 368  
 Thomas, M. S. C., 20, 25, 26  
 Thomas, R. M., 104, 454  
 Thompson, A. G., 452  
 Thompson, K., 161  
 Thompson, P. M., 24  
 Thompson, P. W., 452  
 Thompson, R., 265  
 Thompson, R. A., 22  
 Thompson, R. H., 54, 56  
 Thompson, S. R., 191  
 Thompson, W. L., 225n  
 Thomson, D. M., 267, 270, 274  
 Thoresen, C. E., 136  
 Thornburg, K. R., 443  
 Thorndike, E., 10, 49, 58, 147, 394, 400  
 Thorndike, E. L., 393  
 Thorndike-Christ, T., 497  
 Thorndyke, P. W., 200  
 Thrash, T. M., 468  
 Thurlow, M., 178  
 Thyne, J. M., 394  
 Tiger, J. H., 75, 98, 457  
 Tillman, D., 455  
 Timberlake, W., 38  
 Timperley, H., 55, 83, 130, 286  
 Tinker, E., 30  
 Tippins, D., 248  
 Titz, W., 447  
 Tobias, S., 453, 473  
 Tobin, K., 248, 285  
 Toga, A. W., 24  
 Tollefson, N., 476  
 Tolman, E. C., 142, 143, 144  
 Tolmie, A., 255  
 Tomaselli, K., 119  
 Tomasello, M., 7, 300, 327  
 Tomback, R. M., 453  
 Tomlinson, C. A., 101, 101n  
 Tomporowski, P. D., 458  
 Tonks, S., 465  
 Toplak, M. E., 423, 445  
 Tor, A., 496  
 Torff, B., 249  
 Torgerson, C., 135, 217  
 Torgesen, J. K., 345  
 Torney-Purta, J., 245, 376  
 Tossman, I., 470  
 Tourniaire, F., 301, 310, 454  
 Trachtenberg, J. T., 28  
 Trautwein, U., 356, 445  
 Treasure, D. C., 472  
 Treisman, A. M., 165  
 Treisman, M., 171  
 Tremblay, R. E., 61  
 Trenholme, I. A., 91  
 Trevarthen, C., 327  
 Treysen, J. C., 244  
 Trommsdorff, G., 442  
 Troclair-Lasserre, N. M., 76  
 Trotman, H., 16  
 Trout, A. L., 135  
 Troutman, A. C., 60, 61, 87, 95, 134  
 Trowbridge, J. E., 253  
 Trueman, M., 218, 364  
 Trussell, R., 99  
 Tryon, G. S., 44, 450  
 Trzesniewski, K. H., 381, 478  
 Tsai, J. L., 447  
 Tsao, F.-M., 25  
 Tschannen-Moran, M., 131, 496  
 Tsukiura, T., 222  
 Tubbs, M. E., 206  
 Tucker, B., 474  
 Tudge, J. R. H., 336, 341  
 Tudor, R. M., 106  
 Tuffiash, M., 198  
 Tulving, E., 151, 179, 222, 267, 270  
 Tunstall, P., 130  
 Turkanis, C. G., 347  
 Turnbull, C., 201  
 Turner, J. C., 427, 455, 456, 482, 492  
 Turner, J. E., 488

- Turner, L. A., 471, 472  
 Turner, T. J., 244  
 Turnure, J., 178  
 Turnure, J. E., 182  
 Tversky, B., 146  
 Tweed, R. G., 377  
 Tyler, K. M., 423  
 Tyler, S., 307  
 Tyler, S. W., 404  
 Tzuril, D., 327
- Udell, W., 335, 348  
 Uesiliana, K., 329  
 Underwood, B. J., 149, 150,  
 152, 270, 276  
 Undheim, J. O., 109  
 Unsworth, N., 176  
 Unsworth, S. J., 238  
 Urbach, T. P., 273  
 Urdan, T., 436, 455, 456,  
 470, 472, 473, 492, 494  
 Urdan, T. C., 435, 443, 467  
 Usher, E. L., 129, 131, 382,  
 460  
 Uttal, D. H., 129, 300, 332
- Vagge, S., 200  
 Vagi, K. J., 210, 414  
 Valas, H., 488  
 Valentine, J. C., 129  
 Vallerand, R. J., 491  
 Vallet, G., 180  
 Valli, L., 215  
 Vamvakoussi, X., 249  
 van Baaren, R. B., 177, 408  
 van Boxtel, C., 336  
 VandeKamp, K. O., 387, 498  
 van den Bergh, H., 122, 363  
 Van den Bossche, P., 420  
 van den Broek, P., 200, 204,  
 252, 253, 332, 357  
 van der Buunk, A. P., 130  
 van der Linden, J., 336  
 van der Molen, H. T., 420  
 Van der Molen, M. W., 169  
 van der Werf, M. P. C., 495  
 van der Zee, Y. G., 130  
 van Dijk, T. A., 200, 227  
 Van Dooren, W., 300  
 van Drie, J., 336  
 Van Etten, S., 363  
 van Garderen, D., 340  
 Van Houten, R., 59  
 Van Hout-Wolters, B., 363,  
 470  
 van Joolingen, W. R., 308, 470  
 van Kraayenoord, C. E., 374  
 van Laar, C., 484  
 VanLehn, K., 385  
 VanLeijenhorst, L., 169  
 van Merriënboer, J. J. G.,  
 107, 182, 198, 217, 323,  
 390, 397
- Van Meter, P., 216, 363, 365,  
 382  
 Van Norman, R., 335  
 van Oostendorp, H., 215  
 Van Parys, M., 304  
 Van Patten, J. R., 360  
 Van Rossum, E. J., 359  
 vanSledright, B., 281, 386  
 Vansteenkiste, M., 437, 438,  
 445, 465, 491  
 Vansteenwegen, D., 38  
 van Veen, V., 168n  
 van Winkel, L. M., 476  
 Vargas, A. U., 75  
 Varma, S., 30, 31, 390  
 Vasta, R., 124  
 Vaughn, B. J., 438  
 Vaughn, L. A., 122  
 Vaura, M., 358  
 Vecera, S. P., 167n  
 Vedder, P., 473  
 Veenmen, S., 78  
 Vegas, R., 53  
 Vekiri, I., 217  
 Vela, E., 237  
 Venables, P. H., 445  
 Verdi, M. P., 216  
 Vergauwe, E., 200  
 Verkhatsky, A., 28  
 Vermeer, H. J., 484  
 Vermunt, J. D., 363  
 Vernon, M. D., 444  
 Veroff, J., 444  
 Versace, R., 180  
 Verschaffel, L., 249, 300,  
 325, 376, 404  
 Vervliet, B., 72  
 Vesonder, G. T., 202  
 Vida, M., 465, 497  
 Vida, M. N., 466  
 Vidal-Abarca, E., 364  
 Vigilante, V. A., 82  
 Viken, R. J., 83  
 Vila, J., 41  
 Villanueva, L., 373  
 Vinas, V., 55  
 Vintere, P., 122, 125, 134,  
 217  
 Vitaro, F., 61  
 Vladescu, J. C., 88  
 Voegler, M. E., 442  
 Vogel, E. K., 167, 167n, 169  
 Vohs, K. D., 435, 436  
 Volet, S., 358, 396  
 Vollmer, T. R., 53, 53n, 66,  
 87, 88  
 von Glaserfeld, E., 247  
 von Suchodoletz, W., 162  
 Vorndran, C. M., 58, 82, 88,  
 89, 91, 92  
 Vosniadou, S., 204, 248, 249,  
 250, 252, 253, 255, 256,  
 258, 331
- Voss, J. F., 196, 202, 397,  
 400n, 404  
 Voss, J. L., 168  
 Vul, E., 208  
 Vye, N. J., 419  
 Vygotsky, L., 6, 7, 11, 314,  
 316, 318, 321, 335, 357
- Waber, D. P., 168  
 Wacker, D. P., 56, 82  
 Waddill, P. J., 196, 463  
 Wade, S. E., 215, 359  
 Wade-Stein, D., 364  
 Waggoner, M. A., 423  
 Wagner, E. D., 201, 202,  
 203, 487  
 Wagner, J. F., 395  
 Wagner, R. K., 176, 190  
 Wahler, R. G., 82  
 Wai, J., 225  
 Walberg, H. J., 383  
 Waldmann, M. R., 247  
 Walker, E., 16  
 Walker, E. F., 23, 24  
 Walker, I., 377  
 Walker, J. E., 61  
 Walker, M. P., 199, 200  
 Walkley, F., 460  
 Walkington, C., 413  
 Wallace, C. S., 26  
 Wallace, M. D., 54, 65  
 Wallace, R., 357, 488  
 Wallas, G., 401, 402, 407  
 Waller, R. D., 87  
 Walls, T. A., 491  
 Walshaw, M., 336  
 Walter, M. I., 416  
 Walters, A. A., 197, 198, 228,  
 270  
 Walters, G. C., 58, 82, 91  
 Walters, R. H., 91, 112, 113,  
 117, 120  
 Walton, G. M., 454  
 Wandersee, J. H., 253, 360  
 Wang, A. Y., 368  
 Wang, C. K. J., 437  
 Wang, J., 129  
 Wang, L., 432  
 Wang, M., 390  
 Wang, M.-T., 427, 455, 457,  
 494, 497  
 Wang, Q., 191, 274, 329  
 Wang, R. H., 368  
 Wannarka, R., 74  
 Wanner, G., 61  
 Want, S. C., 121  
 Ward, T. B., 237  
 Warren, E., 248  
 Warren, J. S., 44, 99  
 Warren, W. H., 144  
 Wartella, E., 123  
 Warzon, K. B., 482  
 Was, C. A., 180
- Wasserman, E. A., 33, 75  
 Wat, A., 337  
 Waters, H. S., 374, 383  
 Waters, J. M., 29  
 Watkins, B. A., 124  
 Watkins, D., 377  
 Watkins, M. J., 191  
 Watkins, O. C., 191  
 Watson, J. B., 33, 37  
 Watson, K., 325  
 Watson, M., 346, 459  
 Watts, G. H., 243  
 Wearne, D., 336, 414  
 Weaver, C. A., III, 366  
 Webb, J., 349  
 Webb, N. M., 309, 320, 326,  
 335, 341, 342, 343  
 Webber, J., 109, 134, 135  
 Weber, N. L., 93n  
 Weber, S. J., 108  
 Webster, D. M., 445n  
 Wedderburn, A. A. I., 165  
 Wehby, J., 75, 456  
 Weidema, M., 227  
 Weike, A. I., 449n  
 Weiner, B., 443, 455, 476,  
 476n, 477, 478, 479, 480,  
 481, 482, 483, 484, 494  
 Weinert, F. E., 202, 211  
 Weinraub, M., 122  
 Weinstein, C. E., 383  
 Weinstein, C. S., 78  
 Weinstein, R. S., 455, 495,  
 496  
 Weinstock, M., 376, 377,  
 424, 468n  
 Weir, C., 489  
 Weir, K. E., 460  
 Weisberg, R. W., 406, 407  
 Weise-Kelly, L., 42  
 Weisgram, E. S., 474  
 Weiss, B., 24  
 Weiss, J., 492  
 Weiss, M. R., 125, 199  
 Weisz, J. R., 441, 477, 487  
 Welborn, E. L., 152  
 Welch, G. J., 85  
 Welder, A. N., 261  
 Wellborn, J. G., 434, 441,  
 442  
 Weller, H., 498  
 Wellman, H. M., 245, 373,  
 464  
 Wells, D., 336  
 Wenger, E., 324, 324n, 331,  
 395, 399  
 Wentzel, K. R., 443, 453,  
 459, 475, 491, 493  
 Wertenbroch, K., 356  
 Wertheimer, M., 144  
 Wertsch, J. V., 321  
 Wessa, M., 40  
 West, R. F., 423, 445

- Westerberg, C. E., 168  
 Westerfield, G., 436, 471  
 Whaley, S. E., 24  
 Wharton-McDonald, R., 156  
 Wheatley, G., 473  
 Wheeler, J. J., 94  
 Whitaker, D., 210  
 Whitaker Sena, J. D., 454  
 Whitcombe, E. L., 274  
 White, A. G., 60  
 White, B. Y., 308, 385  
 White, C., 347  
 White, C. S., 154  
 White, D., 456, 470  
 White, R., 434, 435  
 Whitehead, A. N., 390  
 Whitehurst, G. J., 25  
 Whitesell, N. R., 454  
 Whitfill, J. M., 360  
 Whitlock, C., 67  
 Whitten, S., 403  
 Whittingham, J., 207  
 Wickelgren, W. A., 175, 176,  
 399, 411  
 Wicker, B., 27  
 Wiebe, S. A., 29  
 Wienbruch, C., 24  
 Wiesel, T. N., 25  
 Wigfield, A., 84, 128, 139,  
 436, 441, 443, 445, 453,  
 454, 455, 460, 465, 466,  
 480, 484, 485, 491  
 Wiggins, G., 101n, 262  
 Wiggins, J. S., 445  
 Wijnen, W. H. F. W., 420  
 Wild, T. C., 455  
 Wilder, A., 419  
 Wilder, D. A., 51, 182  
 Wiley, J., 196, 336, 365, 408,  
 424  
 Wilke, R., 248  
 Willats, P., 411  
 Willems, R. M., 226  
 Willer, R., 253, 257  
 Williams, A. Y., 453  
 Williams, D., 94  
 Williams, J. P., 364, 383  
 Williams, K., 120  
 Williams, K. A., 25  
 Williams, K. D., 344  
 Williams, M., 419  
 Williams, R., 215  
 Williams, R. E., 74  
 Williams, S., 450  
 Williams, S. B., 430  
 Williams, S. M., 343  
 Williams, T., 120, 129, 480  
 Williamson, A., 497  
 Williamson, S. J., 162  
 Willingham, D. B., 198, 199  
 Willingham, D. T., 170, 179,  
 276  
 Willis, E. L., 197  
 Willis, G. B., 413  
 Willoughby, T., 201, 381  
 Wilson, B., 286  
 Wilson, B. L., 381  
 Wilson, C. D., 224  
 Wilson, J. T., 360  
 Wilson, P. T., 212, 245  
 Wilson, T. D., 32, 435  
 Winborn, L. C., 76  
 Windmann, S. S., 273  
 Windschitl, M., 256, 336,  
 386, 492  
 Wine, J. D., 453  
 Winer, G. A., 204, 249, 252,  
 253  
 Wingfield, A., 162  
 Winik, M., 273, 274  
 Winkielman, P., 450  
 Winn, W., 216, 217, 348  
 Winne, P. H., 129, 323, 356,  
 357, 379, 381, 387, 418,  
 494  
 Winsler, A., 316  
 Winters, F. I., 382  
 Winzenz, D., 194  
 Wiser, M., 252  
 Wisner Fries, A. B., 29  
 Witherspoon, A. M., 355, 385  
 Witkow, M. R., 468n  
 Wittrock, M. C., 185, 210,  
 364, 393, 396, 397, 403,  
 409, 410, 412, 413, 415,  
 416, 417, 418  
 Wixson, K. K., 283  
 Wixted, J. T., 176, 199, 208,  
 279  
 Wojslawowicz, J. C., 206  
 Wolf, M. M., 60, 96, 97, 98  
 Wolfe, C. D., 22  
 Wolfe, C. R., 400n, 404  
 Wolfe, L. A., 75  
 Woloshyn, V. E., 343, 382  
 Wolpe, J., 44  
 Wolters, C. A., 357, 436,  
 470, 471n, 473, 489, 493  
 Wong, B. Y. L., 325, 366  
 Wong, I., 211  
 Wong, P., 217  
 Wood, D., 323  
 Wood, E., 201, 381  
 Wood, G. A., 443  
 Wood, N. L., 171  
 Wood, P., 376  
 Wood, T., 452, 473  
 Woodman, G. F., 167, 167n  
 Woodruff-Pak, D. S., 42  
 Woods, D. W., 54, 88  
 Woods, R. P., 27  
 Woodson, R., 27  
 Woodward, M. M., 369  
 Woodworth, G., 415  
 Woodworth, R. S., 393, 429  
 Woolfolk, A. E., 74  
 Woolfolk Hoy, A., 131, 496  
 Worsham, M. E., 454  
 Wortham, D., 207, 412  
 Worthen, J. B., 196, 276  
 Wray, L. D., 67  
 Wright, R., 441  
 Wu, C.-H., 470, 471  
 Wu, Y.-C., 182, 362  
 Wundt, W., 6  
 Wyndham, J., 395  
 Wynn, K., 247  
 Wynn, S. R., 438  
 Xu, J., 489  
 Yackel, E., 337, 452, 473  
 Yang, A. X., 432  
 Yarger, R. S., 168  
 Yarmey, A. D., 265  
 Yates, K. A., 107  
 Yengo, L. A., 404  
 Yerkes, R. M., 450, 451  
 Yi, S., 329  
 Yoder, P., 122  
 Yokoi, L., 363  
 Young, A., 139, 467  
 Young, D. E., 390  
 Younger, B. A., 239  
 Younger, J., 201  
 Youngers, J., 242  
 Yu, H. C., 453  
 Yuill, N., 200  
 Zacks, J. M., 197, 224  
 Zacks, R. T., 168, 177  
 Zahn-Waxler, C., 124  
 Zahorik, J. A., 464  
 Zajonc, R. B., 37, 448, 450  
 Zaragoza, M. S., 272, 275  
 Zarella, M. M., 223  
 Zaromb, F. M., 248  
 Zawilinsky, L., 355  
 Zechmeister, E. B., 176  
 Zeelenberg, R., 267  
 Zeidner, M., 45, 268, 446,  
 453, 454, 489  
 Zelazo, P. D., 168  
 Zentall, T. R., 112  
 Zhang, J., 347, 349  
 Zhang, M., 385  
 Zhang, W., 171  
 Zhang, Z., 67  
 Zhao, Q., 365, 374, 386  
 Zheng, X., 402  
 Zhong, C.-B., 408  
 Zhou, M., 437  
 Zhou, T.-D., 390  
 Ziegart, D. I., 486  
 Ziegler, S. G., 134  
 Zigler, E., 30  
 Zimmerman, B. J., 111, 112,  
 115, 116, 117, 118, 120,  
 122, 123, 128, 129, 131,  
 132, 133n, 136, 139, 156,  
 199, 217, 356, 357, 374,  
 382, 387, 409, 437, 441n,  
 467, 480, 484, 488, 489,  
 493  
 Zimmerman, C. A., 181  
 Zimmerman, R. R., 53  
 Zimmerman, R. S., 432  
 Zinbarg, R., 37, 41, 122  
 Zinn, T. E., 335  
 Zirin, G., 181  
 Zirpoli, T. J., 60, 65n, 88  
 Zmuda, J. H., 96  
 Zohar, A., 301, 308, 309  
 Zola-Morgan, S. M., 176  
 Zook, K. B., 213, 215  
 Zuckerman, M., 387, 431  
 Zuniga, S., 341  
 Zuriff, G. E., 32



---

# Subject Index

- ABA. *See* Applied behavior analysis (ABA)
- ABC approach in applied behavior analysis, 93
- Ability goals, 468n
- Abstract concepts, 235–236
- Academic achievement
- achievement goals and, 473
  - affiliation needs and, 443
  - attributions and, 478, 494–496
  - computer-assisted instruction and, 106
  - cooperative learning and, 341
  - epistemic beliefs and, 379
  - feedback and, 56
  - group contingencies and, 97
  - interest and, 463
  - mastery learning and, 108
  - motivation and, 427, 428
  - objectives and, 102–103
  - reinforcers for, 79
  - schoolwide positive behavior support and, 99
  - self-efficacy and, 139
  - self-regulation and, 132–133
  - self-worth and, 436
- Acclimation, 259
- Accommodation, 292, 300
- Achievement goals
- achievement motivation and, 444, 467
  - attributions and, 480
  - effects of, 469–471
  - mastery goals and, 468–472, 480, 493–494, 496–497
  - origins of, 471–473
  - performance goals and, 468–472, 480, 493–494
- Achievement motivation, 443–444, 467
- Acquired drives, 430
- Acrostic, 371n
- Activation
- memory and, 179–180, 268
  - priming and, 180, 205
  - prior knowledge and, 212–213, 214
- Active avoidance learning, 71
- Active responding, 105, 207
- Activity choices, 128
- Activity reinforcers, 54–55, 83
- Actual developmental level, 317, 326–327
- Adaptation
- learning and, 2, 3
  - in Piaget's theory, 292
  - synaptogenesis and, 29
- Addiction, 42
- Adequate yearly progress, 102
- Adjuster neurons, 14n
- Adolescence
- approval needs and, 443
  - brain development, 23–24
  - career goals, 474
  - central conceptual structure for number and, 307
  - conceptual change and, 252
  - conscientiousness, 445
  - critical thinking and, 422–423
  - epistemic beliefs and, 377
  - formal operations stage and, 299, 301–302
  - hands-on experiences and, 307
  - learned helplessness and, 486
  - metacognition and, 373, 374
  - performance goals and, 471, 472
  - relatedness needs, 441
- Adults and adulthood
- adults as models, 114, 120–123, 125, 132, 134, 138–139, 329, 333
  - attention and, 181, 182
  - brain development, 17, 21, 23–24, 293
  - children's interaction with affecting cognitive development, 291, 292, 314–317, 319–322, 323, 324, 326, 328–330, 332–334
  - co-constructed narratives, 329
  - concepts and, 239, 243
  - epistemic beliefs and, 377
  - false memories and, 273
  - formal operations stage and, 301–302
  - guided participation, 324
  - language and, 315
  - learned helplessness and, 486
  - long-term memory and, 230
  - misconceptions and, 248
  - peer-interactive instructional strategies and, 335
  - power of suggestion and, 271–272
  - preoperational stage and, 295, 298–299, 301
  - prior knowledge and, 202, 205, 212
  - repetition and review, 208
  - self-efficacy and, 129, 131
  - self-explanation and, 207
  - sensory register and, 162
  - sociocultural theories and, 332–334
  - verbal learning and, 151
  - visual imagery and, 197
  - working memory and, 169, 170, 173
  - worldviews and, 251
- Advance organizers, 213–215, 217–218
- The Adventures of Jasper Woodbury* (videodisc-based series), 420
- Affect. *See also* Anxiety; Emotion
- defined, 446, 446n
  - interest and, 462
  - learning and cognition, 448–450
  - motivation and, 427, 447, 459–460
  - self-regulation and, 488–489
- Affiliation, need for, 442–443, 459
- Age, and attributions, 481
- Aggression
- drive theory and, 431
  - gender differences and, 122n
  - modeling and, 120, 122, 123
  - operant conditioning and, 51
  - punishment and, 58, 60, 61, 82, 89
  - vicarious reinforcement and, 114–115, 116
- Algorithms, for problem solving, 409–410, 413–415
- Alternative frameworks, 245n
- Altruism, 124
- Ambiguous stimulus, 188, 206
- Amygdala
- brain development, 23
  - classical conditioning and, 42n
  - implicit knowledge and, 224n
  - as part of brain, 20, 20n
  - physiology of learning and, 29
- Analogies
- advance organizers and, 214–215
  - computer analogy, 154, 159
  - conceptual change and, 255
  - prior knowledge and, 213, 214
  - problem solving and, 411–413
- Anchors, and serial learning, 149
- Animal studies
- behaviorism and, 32, 290
  - brain research methods, 17
  - classical conditioning and, 35–36
  - Gestalt psychology and, 145, 147–148
  - Tolman and, 142–144
- Antecedent responses, 73–75
- Antecedent stimuli, 73–75, 93, 94
- Anxiety. *See also* Fears; Test anxiety
- classical conditioning and, 40, 41, 43, 44, 45, 46, 450
  - defined, 450

- Anxiety (*continued*)  
 effects of, 450–453  
 forgetting and, 278  
 instrumental conditioning and, 56, 70, 71, 82, 95, 109  
 learned helplessness and, 486  
 performance goals and, 470  
 problem solving and, 407  
 retrieval and, 268, 453  
 self-efficacy and, 130  
 sources of, 453–455
- Application, and instructional objectives, 100–101
- Applied behavior analysis (ABA)  
 cognitive component added to, 99  
 defined, 92  
 for groups, 96–99  
 for individuals, 92–96
- Apprenticeships, 324–325
- Approach motivation, 427
- Appropriate behaviors, reinforcing, 92
- Appropriation, 317
- Approval, need for, 443, 459
- Archimedes, 412
- Argument analysis, 422
- Argumentation skills  
 community of learners and, 348  
 critical thinking and, 423  
 motivation and, 459  
 peer-interactive instructional strategies and, 335
- Arguments, in proposition, 228
- Arousal  
 inverted U curve of, 450, 451  
 needs and, 431–432, 431n, 458
- Articulation, 325
- Asperger syndrome, 225n
- Assessment, and learning, 285–287  
 and transfer, 420
- Assimilation, 292, 300, 319
- Associate cues, 269, 373
- Association areas, of brain, 19
- Associationistic theories of long-term memory, 229
- Associative bias, defined, 38
- Astrocytes, role in learning, 28
- Attention  
 anxiety and, 453  
 capacity of, 166–167, 182  
 explicit memory and, 181–182  
 factors influencing, 163–165  
 interest and, 463  
 joint attention, 327–328, 332  
 modeling and, 124–125, 127, 137  
 nature of, 165–166  
 note taking and, 360  
 self-regulated learning and, 357  
 social cognitive theory and, 113, 116, 117, 141  
 working memory and, 163–167, 168, 183, 453
- Attitudes, and classical conditioning, 37
- Attributions  
 attribution retraining, 496  
 defined, 476  
 effects of, 478–480  
 explanatory style and, 485–487  
 factors influencing nature of, 480–485  
 learned helplessness and, 9, 485–487  
 motivation and, 475–487  
 of teachers, 494–496
- Auditory cortex, 22
- Authentic activities  
 classroom tasks and, 332–333  
 problem solving and, 419–420  
 retrieval and, 282
- Autism, 109
- Autism spectrum disorders, 124
- Autobiographical memory, 222n
- Automaticity  
 attention and, 167  
 intentional learning and, 380  
 long-term memory storage and, 209–210  
 problem solving and, 402, 408, 416  
 retrieval and, 268, 285  
 working memory and, 303
- Automatic processing, 209–210
- Autonomy, 437, 456–457, 491, 499
- Aversive stimulus, 71, 72, 82
- Avoidance learning, 71–72, 82, 450
- Avoid motivation, 427
- Awareness, and social cognitive theory, 113, 116
- Axons  
 defined, 15  
 myelination, 23  
 prenatal development, 22
- Backup reinforcers, 98
- Backward chaining, 65n
- Backward design, 101n
- Bandura, Albert, 112, 118n, 120, 125, 127
- Base groups, 340
- Baseline period, 58, 86, 89–90, 93–96
- Behavioral changes, and learning, 4, 6, 33, 46, 85–86, 112–113, 152, 153
- Behavioral contrast, 82
- Behavioral cusp, 119n
- Behavioral momentum, 75
- Behavioral objectives, and instructional objectives, 99–100, 101
- Behavior disorders, and applied behavior analysis, 109
- Behavior guidelines, and cooperative learning, 342
- Behaviorism. *See also* Classical conditioning; Instrumental conditioning; Operant conditioning  
 animal studies and, 32, 290  
 basic assumptions of, 32–34  
 behavioral cusp, 119n  
 concept learning and, 238–241  
 defined, 6  
 drive theory and, 429  
 educational implications of, 44–46  
 establishing or motivating operation, 76n  
 limitations of, 152  
 problem solving and, 400–401  
 purposive behaviorism, 142–144, 155  
 transfer theory and, 393–395, 397
- Behavior modification. *See* Applied behavior analysis (ABA)
- Behavior therapy. *See* Applied behavior analysis (ABA)
- Beliefs. *See also* Epistemic beliefs  
 and conceptual change, 252–254, 256
- Benchmarks, and instructional objectives, 101, 103
- Bipolar disorder, 13, 24
- Black box, 33
- Bloom's Taxonomy of Educational Objectives, 103, 104, 283, 284
- Brain development  
 critical periods, 24–27, 30  
 environmental factors in, 24–25, 29–30  
 factors influencing, 24  
 infancy and early childhood, 22–23, 27–28, 30  
 Piaget's stages of cognitive development and, 293  
 prenatal development, 22  
 prewiring, 27–28  
 timing of, 21
- Brain research  
 educational implications of, 29–31  
 methodology, 17–18
- Brainstorming, 410–411
- Brain structures  
 functions of, 16–21  
 interconnectedness of, 21, 28  
 left and right hemispheres, 18–21, 30  
 memory processes and, 160, 176  
 parts of brain, 18–20  
 research on, 17–18  
 as sensory registers, 161  
 visual-spatial encoding and, 170n
- Brain trauma  
 brain research methods and, 17, 18  
 implicit knowledge and, 223  
 retrograde amnesia and, 199  
 working memory and long-term memory in, 176
- Branching programs, 105
- Breaks, and attention, 182
- Bribery, reinforcement characterized as, 79, 80
- Broca's area, 20
- Bullying, 443, 474

- CAI (computer-assisted instruction), 105, 106, 456
- CAL (computer-assisted learning), 106
- Calibration, 364n
- Capacity
  - of attention, 166–167, 182
  - cognitive processing using, 169
  - of long-term memory, 174
  - of sensory register, 161, 168
  - of working memory, 168–169, 182, 183, 185, 190, 198, 303, 374, 383, 395, 402, 413, 416, 418, 420
- Career goals, 474
- Case, Robert, neo-Piagetian cognitive development theory of, 304–307, 311
- CAT (computerized axial tomography), 17
- Cause-and-effect relationships
  - associative bias and, 38
  - attributions and, 476
  - personal theories and, 247
- CBI (computer-based instruction), 106
- Central conceptual structures, 304–305
- Central executive
  - metacognition and, 353, 374
  - transfer and, 393
  - working memory and, 168, 171
- Central nervous system, 14, 15
- Central processor, levels-of-processing model of memory, 177–178
- Cerebellum, 18, 224n
- Cerebral cortex, 18
- Chaining, 64–65
- Challenge, defined, 452
- Challenging tasks
  - distributed cognition and, 331
  - intrinsic motivation and, 456
  - metacognition and, 354
  - motivation and, 497–498
  - self-talk and, 316
  - self-worth and, 435
  - sociocultural theories and, 333
  - Vygotsky and Piaget compared, 319
  - Vygotsky's cognitive development theory and, 317–318, 320, 464
- Choices
  - activity choices, 128
  - attributions and, 480
  - expectancies and values, 465
  - intrinsic motivation and, 456–457
  - self-determination and, 438
- Chunking, 168, 171, 303
- Class discussions, peer-interactive instructional strategies, 336–338, 348
- Classical conditioning
  - avoidance learning and, 72
  - changing undesirable conditioned responses, 42–44
  - cognition in, 41–42
  - common phenomena in, 38–41
  - conditioned response and, 35, 36, 37, 39, 40, 43, 44, 65
  - conditioned stimulus and, 35–44, 65
  - educational implications of, 44–46
  - in human learning, 36–37
  - model of, 35–36
  - operant conditioning contrasted with, 52–53
  - Pavlov and, 34–36, 35n, 38–41
  - secondary reinforcers and, 53–54
  - stimulus discrimination and, 39–40, 74
- Class inclusion, 295–297, 300
- Classroom assessment tasks
  - concept learning and, 243
  - long-term memory storage and, 440
  - motivation and, 460
  - retrieval and, 285–287
  - teacher expectations and, 495–496
  - transfer and, 420
- Classroom climate, and classical conditioning, 45
- Classroom environment, and motivation, 455–460
- Classroom management
  - applied behavior analysis and, 92–99
  - behaviorist principles for, 78–92
  - concerns about using reinforcement and punishment for, 79–82
  - decreasing undesirable behaviors with punishment, 88–92
  - decreasing undesirable behaviors with reinforcement, 86–88
  - increasing desirable behaviors with reinforcement, 82–86
- Classroom practice. *See also* Educational implications; Instructional strategies antecedent stimuli and responses and, 73–75
  - punishment and, 60–62
  - reinforcement and, 51, 56–57, 57n
  - social cognitive theory and, 137–140
  - sociocultural theories and, 332–334
  - theories of learning applied to, 10–11
- Classroom tasks
  - authentic activities and, 332–333
  - competition and, 497
  - learning strategies and, 382
  - motivation and, 455–456, 499
  - multiple goals and, 494
  - performance goals and, 472
- Clinical method
  - defined, 290
  - use of, 295–296, 309–310
- Closure
  - class discussions and, 338
  - constructivism and, 155
  - Gestalt psychology and, 146, 148, 186
- Coaching
  - applied behavioral analysis and, 99
  - apprenticeships and, 325
  - performance goals and, 472
- Cocktail party phenomenon, 165
- Co-constructed narratives, 329
- Cognitive apprenticeships, 324–325
- Cognitive-behavioral interventions, 99
- Cognitive behavior modification, 99
- Cognitive behavior therapy, 99
- Cognitive development
  - adults' interaction with children affecting, 291, 292, 314–317, 319–322, 323, 324, 326, 328–330, 332–334
  - challenging tasks and, 333
  - neo-Piagetian theories of, 302–311
  - Piaget's theory of, 289–299, 300, 301–302, 304, 309, 319, 447
  - Vygotsky's theory of, 156, 211, 289, 313–318, 320, 346, 357, 358, 464, 498
- Cognitive-development theories, defined, 289
- Cognitive dissonance, 255, 447, 453
- Cognitive maps, and purposive behaviorism, 143–144, 155
- Cognitive modeling, 123, 134, 217, 329
- Cognitive processes. *See also* Attention; Expectations; Self-efficacy
  - affect and, 448–450
  - anxiety's effects on, 452–453
  - applied behavioral analysis and, 99
  - behaviorism and, 33, 141
  - capacity used by, 169
  - classical conditioning and, 41–42
  - constructivism and, 155
  - defined, 141
  - developmental psychology and, 141
  - inferences about, 153–154
  - instrumental conditioning and, 75–76
  - motivation and, 427, 462, 475, 491–498
  - nonconscious thinking, 176–177
  - problem solving and, 402–409
  - reinforcement ignoring problems in, 81
  - self-regulation and, 136
  - social cognitive theory and, 113, 116–118, 140
  - students' control of, 157
  - verbal learning and, 141, 148–152, 157, 260
  - Vygotsky's cognitive development theory and, 314
  - working memory and, 167–168
- Cognitive psychology, defined, 6
- Cognitive strategies, collaborative use of, 329–330
- Cognitive structures, 291, 303
- Cognitive tools
  - community of learners and, 347
  - sociocultural theories and, 332
  - Vygotsky's cognitive development theory and, 315, 315n, 317

- Cognitivism  
 affect and, 448, 450  
 computer-assisted instruction and, 106  
 constructivism and, 154–155  
 contextual theories and, 155–156  
 cueing and, 282n  
 defined, 6  
 educational implications of, 157  
 general assumptions of cognitive theories, 152–154  
 information processing theory and, 154  
 integrating cognitive perspectives, 156  
 memory and, 159–160  
 Piaget's cognitive development theory and, 290  
 problem solving and, 401–402  
 social cognitive theory and, 113
- Collaborative learning, 340n
- Collective self-efficacy, 131
- Communities of learners, 346–348, 442
- Comparative organizers, 214
- Competence  
 attributions and, 477, 498  
 challenging tasks and, 497, 498  
 expertise and, 259, 260  
 feedback and, 457–458  
 interest and, 464  
 of models, 121  
 need for, 434–437  
 self-determination and, 439, 440–441  
 self-regulation and, 488
- Competition  
 classical conditioning and, 46  
 performance goals and, 496–497
- Comprehension monitoring  
 metacognition and, 374  
 study strategies and, 364–366
- Computer analogy, and information processing theory, 154, 159
- Computer-assisted instruction (CAI), 104, 105
- Computer-assisted learning (CAL), 106
- Computer-based instruction (CBI), 106
- Computer-based simulations, 308
- Computerized axial tomography (CAT), 17
- Computers  
 distributed cognition and, 331  
 learning strategies and, 384–385  
 summarizing and, 364
- Concept maps  
 promoting long-term memory storage and, 215, 216  
 study strategies and, 359, 360, 362
- Concepts  
 central conceptual structures, 304–305  
 cognitive structures of, 303  
 defined, 235  
 factors facilitating concept learning, 241–243  
 knowledge and, 235–243, 261–262  
 theories of concept learning, 237–241
- Conceptual artifacts, 347
- Conceptual change  
 challenge of, 252–259  
 defined, 252, 252n  
 disequilibrium and, 255–256, 309, 447  
 epistemic beliefs and, 378, 385–386  
 intentional learning and, 380  
 interest and, 463  
 misconceptions and, 215, 252, 253, 254–255, 256, 257–258, 259  
 motivation and, 256–257, 426, 428  
 open-mindedness and, 446  
 peer-interactive instructional strategies and, 335  
 promoting, 254–259, 262  
 self-worth and, 435n
- Conceptual knowledge, 223, 414
- Concrete concepts, 235
- Concrete items, and verbal learning theory, 150
- Concrete operations stage, 297–298, 300–301
- Conditional knowledge, 223
- Conditioned response (CR), classical conditioning, 35, 36, 37, 39, 40, 43, 44, 65
- Conditioned stimulus (CS), classical conditioning, 35–44, 65
- Conditioning, defined, 33
- Confirmation bias, 252, 308
- Connectionism  
 long-term memory organization and, 234–235  
 Thorndike and, 49, 49n, 234
- Conscientiousness, 445
- Consensus seeking, 445
- Consequences  
 applied behavior analysis and, 93  
 identifying reinforcing consequences, 83–84  
 instrumental conditioning and, 48  
 motivation and, 427  
 nonoccurrence of expected consequences, 117–118  
 response-consequence contingencies, 84–85  
 restitution as logical consequence, 59  
 self-regulation and, 489
- Conservation, 296–298, 298n, 300, 301, 302
- Conservation of liquid, 296–297
- Conservation of weight, 297–298, 298n
- Consistency  
 in punishment, 91–92, 137  
 in reinforcement, 66, 104, 137
- Consolidation  
 defined, 28  
 extinction and, 43n  
 forgetting and, 279
- long-term memory storage and, 199–200  
 process of, 28–29
- Constructive criticism, and self-efficacy, 130
- Constructive evaluation of ideas, and class discussions, 336–337
- Constructivism  
 cognitivism and, 154–155  
 forgetting and, 279  
 Gestalt psychology and, 155  
 Piaget's cognitive development theory and, 291  
 radical constructivism, 247n  
 retrieval and, 270–275, 281–282, 287  
 social constructivism, 155, 322, 330–331  
 Vygotsky's cognitive development theory and, 317
- Content domains  
 class discussions, 336  
 critical thinking and, 422  
 epistemic beliefs and, 376–377  
 learned helplessness and, 487  
 learning strategies and, 383  
 neo-Piagetian theories of cognitive development and, 303–304, 311  
 problem solving and, 417  
 transfer and, 394, 395–396
- Contextual cues, 269–270, 270n, 282
- Contextual theories  
 cognitivism and, 155–156  
 expanding framework of, 330–332  
 general implications of, 332–334  
 sociocultural theory and, 156, 289, 313, 330–331  
 transfer and, 395–396
- Contiguity, defined, 38
- Contingency  
 attributions and, 477  
 defined, 38
- Contingency contracts, 84–85
- Contingency management. *See* Applied behavior analysis (ABA)
- Contingent reinforcers, 52
- Contingent self-worth, 436
- Continuous reinforcement, 66, 67, 85
- Contrast effects, 76
- Controllability, and attributions, 477, 478, 482
- Controlled processing, 209
- Controlling circumstances, 441
- Controlling statements, 438–439
- Control processes, defined, 160
- Cooperative group problem solving, 418–419
- Cooperative learning  
 collaborative learning distinguished from, 340n  
 enhancing effectiveness of, 341–344  
 peer-interactive instructional strategies, 340–344, 348

- Coping models, 131, 139  
 Core goals, 467  
 Co-regulated learning, 358  
 Core knowledge, 28, 247  
 Corpus callosum, 20, 23  
 Correlation, 422  
 Correlational features, 237, 241  
 Cortex  
   consolidation and, 28–29  
   hemispheres of, 18–21  
   long-term memory and, 234  
   physiology of learning and, 29  
 Cost-benefit analysis, in behavior changes, 84, 466n  
 Counterconditioning, 43–44  
 Covert strategies, 373, 384  
 Criminal activity, and operant conditioning, 51  
 Critical periods, 24–27, 25n, 30  
 Critical thinking  
   defined, 421  
   as disposition, 445  
   fostering, 423–424  
   instructional objectives and, 101  
   technology-based collaborative learning and, 350  
 Cross-situational generality, 476n  
 Cues and cueing  
   associate cues, 269, 373  
   and behaviorism, 73–74, 282n  
   contextual cues, 269–270, 270n, 282  
   external retrieval cues, 282–283, 282n  
   retrieval cues, 268–270, 282–283, 395, 407  
   situational cues, 481  
   social cues, 164  
 Cultural literacy, 262  
 Culture  
   attributions and, 483–484, 483n  
   choices and, 438  
   critical thinking and, 423  
   epistemic beliefs and, 377  
   expectancies and values, 466  
   help-seeking behavior and, 488n  
   intersubjectivity and, 328  
   performance goals and, 472  
   Piaget's cognitive development theory and, 302  
   self-conscious emotions and, 447  
   social construction of memory and, 329  
   transfer and, 399  
   Vygotsky and Piaget contrasted, 320–321  
   Vygotsky's cognitive development theory and, 315, 317  
 Culture of transfer, 415  
 Cumulative rehearsal, 374  
 Deadlines, effects of, 438  
 Debilitating anxiety, 451–452  
 Decay  
   forgetting and, 276  
   sensory register and, 162  
   transfer and, 398–399  
   working memory and, 171  
 Declarative knowledge  
   action-based encoding and, 226  
   conceptual knowledge and, 223  
   defined, 222  
   forms of, 283  
   instructional strategies and, 217  
   long-term memory and, 174  
   long-term memory storage and, 190, 199  
   transfer and, 390  
 Deficiency needs, 433, 434n  
 Defining features, 237, 241–242  
 Definitions, and concept learning, 242  
 Delayed gratification, 86, 356  
 Delayed imitation, 115  
 Dendrites  
   defined, 15  
   neurotransmitters and, 16  
   prenatal development, 22  
 Depression effect, 76, 81, 143  
 Determinism, 34  
 Differential rate of high responding (DRH), 70  
 Differential rate of low responding (DRL), 70–71  
 Differential reinforcement of alternative behaviors (DRA), 88n  
 Differential reinforcement of incompatible behaviors (DRI), 88n  
 Differential reinforcement of other behaviors (DRO), 87n  
 Differential schedules, 70–71  
 Differentiation  
   brain development, 22  
   classical conditioning and, 39  
   experience-expectant plasticity, 26  
 Discovery learning, 307–308, 320, 415  
 Discriminative stimulus, 73  
 Disequilibrium  
   conceptual change and, 255–256, 309, 447  
   epistemic doubt and, 386  
   Piaget's cognitive development theory and, 292, 309, 319, 447  
 Disinhibition effect, 120  
 Dispositions, 445–446, 459  
 Distractions  
   attention and, 182  
   self-regulation and, 489  
 Distributed cognition, 330, 331, 334  
 Distributed intelligence, 156, 331  
 Distributed learning, 156  
 Distributed practice, 149, 208, 218  
 Dopamine, puberty, 24  
 DRH (differential rate of high responding), 70  
 DRI (differential reinforcement of incompatible behaviors), 88n  
 Drive, defined, 429  
 Drive reduction, and needs, 429–431, 458  
 DRL (differential rate of low responding), 70–71  
 DRO (differential reinforcement of other behaviors), 87n  
 Drug use, and classical conditioning, 42  
 Dual coding theory, 225n  
 Dual-store model of memory  
   attention, 163–167  
   challenges to, 175–177, 181, 250  
   defined, 160  
   development of model, 159–161  
   long-term memory, 173–174  
   rehearsal and, 191  
   sensory register, 161–162  
   working memory, 167–173  
 Duration  
   of long-term memory, 174, 275  
   of sensory register, 161–162  
   of working memory, 170–171  
 Dynamic assessment, 326–327  
 Early childhood  
   brain development, 22–23, 30  
   central conceptual structure for number and, 305–306  
   concept learning and, 239, 241  
   eyewitness testimony and, 272  
   hands-on experiences and, 307  
   learned helplessness and, 486  
   mastery goals and, 472  
   metacognition and, 373, 374  
   preoperational stage and, 300  
   self-determination and, 437  
   social referencing and, 328  
   stimulation seeking and, 445  
 Ebbinghaus, Hermann, 150  
 Echoic memory, 161n  
 Educational implications. *See also* Classroom practice; Instructional strategies  
   of brain research, 29–31  
   of classical conditioning, 44–46  
   of cognitivism, 157  
   of memory, 181–183  
   of social cognitive theory, 137–140  
 EEGs (electroencephalographs), 17, 18  
 Effective stimulus, 163n  
 Effector neurons, 14n  
 Efficacy expectations, and social cognitive theory, 117  
 Effort  
   attributions and, 479–480, 481  
   self-efficacy and, 128  
 Egocentrism, 295, 295n, 299n, 300  
 Ego involvement, 468n  
 Ego orientation, 468n

- Eidetic imagery, 225, 225n
- Elaboration
  - affect and, 448
  - classroom tasks and, 333
  - comprehension monitoring and, 366
  - epistemic beliefs and, 378
  - instructional strategies, 215
  - levels-of-processing model of memory and, 179
  - long-term memory storage and, 195–196
  - meaningful learning compared to, 195n
  - metacognition and, 374, 375
  - note taking and, 362
  - peer-interactive instructional strategies and, 334
  - positive transfer and, 390–391
  - prior knowledge and, 195, 201, 202, 358
  - semantic elaboration, 371n
  - study strategies and, 358–359
- Elaborative interrogation, 343
- Elaborative rehearsal, 191
- Elation effect, 76
- Electrical recording, brain research methods, 17
- Electroencephalographs (EEGs), 17, 18
- Elephant painting, 2–3, 65
- Elicitation, and classical conditioning, 36, 53
- Embodiment, and contextual theories, 156, 330, 331
- Emotion. *See also* Affect
  - attention and, 164
  - self-conscious emotions, 447, 478–479
  - self-regulated learning and, 356
  - transfer and, 396
- Emotionality, component of anxiety, 450
- Emotional responses to events, and attributions, 478–479
- Emotional states, and self-efficacy, 130
- Enactment, and long-term memory storage, 207–208
- Encoding
  - actions and, 225–226
  - information processing theory and, 159
  - knowledge in long-term memory, 224–228, 260
  - long-term memory and, 176
  - meaning and, 227–228
  - note taking and, 360, 362
  - overlapping forms of, 228
  - physical characteristics and, 224–225
  - prior knowledge and, 201
  - problem solving and, 402–407
  - symbols and, 227
  - verbal learning theory and, 151–152
  - visual-spatial encoding, 169–170, 225
  - working memory and, 176
- Encoding specificity, and retrieval, 267–268
- Entity view of intelligence, 478, 478n, 479–480, 495
- Environmental factors
  - applied behavior analysis and, 93, 94
  - attributions and, 477
  - in brain development, 24–25, 29–30
  - epistemic beliefs and, 377
  - internalized motivation and, 491
  - situational interest and, 463
  - social cognitive theory and, 113–115, 118–119, 140
  - Vygotsky's cognitive development theory and, 314
- Environmental interaction, and Piaget's cognitive development theory, 291, 300
- Environmental supports, and contextual theories, 155–156
- Environmental toxins, brain development, 24, 30
- Episodic buffer, 170
- Episodic memory, 222, 260
- Epistemic beliefs
  - content domains and, 376–377
  - critical thinking and, 423
  - defined, 375
  - developmental and cultural differences in, 377
  - dimensions of, 375–376
  - dispositions and, 445, 446
  - effects of, 378–379
  - entity versus incremental views of intelligence, 478n
  - illusion of knowing and, 365
  - learning strategies and, 379, 381, 385–386
  - peer-interactive instructional strategies and, 335
  - problem solving and, 409
  - technology-based collaborative learning and, 350
- Epistemic cognition, 375n
- Epistemic curiosity, 445
- Epistemic doubt, 386
- Epistemology, 289
- Equilibration, 292–293, 300
- Equilibrium, 292–293
- Equipotentiality, defined, 32
- ERPs (event-related potentials), 17
- Errors, Skinner on, 105n
- Escape behaviors, 56, 57, 71, 82, 89
- Establishing operation, 76n
- Esteem needs, 432–433, 434
- Ethics in research, 9n, 37
- Evaluation. *See also* Assessment
  - classroom evaluation, 420
  - cooperative learning and, 344
  - metamnemonic evaluation, 364n
  - and motivation, 499
  - self-determination and, 439–441
  - self-evaluation, 132, 357, 386–387
- Event-related potentials (ERPs), 17
- Exemplars, 238, 242
- Exhaustion method, and stimulus–response habit, 45–46
- Expectancies
  - attributions and, 479
  - career goals and, 474
  - motivation and, 464–466, 489–493
- Expectations
  - contingency contracts and, 84
  - long-term memory storage and, 205–207
  - purposive behaviorism and, 143
  - relatedness needs and, 442
  - self-regulation and, 136
  - social cognitive theory and, 113, 116–118, 139, 141
  - of teachers, 84–85, 109, 131, 285, 457, 458, 459, 494–496
- Expected consequences, 117–118
- Experience-dependent plasticity, 26
- Experience-expectant plasticity, 26
- Experiences
  - behaviorism and, 33
  - brain development and, 24
  - hands-on experiences, 307–308
  - learning and, 4
  - Piaget's cognitive development theory and, 301, 302
  - sociocultural theories and, 332
  - Vygotsky and Piaget contrasted, 320
- Expertise
  - knowledge and, 259–260
  - peer-interactive instructional strategies and, 335
  - technology-based collaborative learning, 349
- Explanatory style, 485–487
- Explicit knowledge
  - affect and, 449
  - implicit knowledge distinguished from, 223–224
  - long-term memory and, 174, 177
  - long-term memory storage and, 190
  - metacognition and, 356, 356n
- Explicit memory, and attention, 181–182
- Exploration, and apprenticeships, 325
- Expository instruction, 211, 415
- Expository organizers, 213–214
- External regulation, 490
- External representations, for problem solving, 413
- External retrieval cues, 282–283, 282n
- External storage, and note taking, 360, 362, 402
- Extinction
  - applied behavioral analysis and, 94, 95
  - classical conditioning and, 38–39, 65

- extinguishing undesirable responses, 42–43, 43n, 86–87, 88
- instrumental conditioning and, 65–66
- reinforcement schedules and, 66–71
- Extinction burst, 65, 87
- Extra classwork, as punishment, 62
- Extrinsic motivation, 428–429, 457
- Extrinsic reinforcers
  - effectiveness of, 83
  - increasing desirable behavior and, 86
  - intrinsic motivation and, 81, 439
  - motivation and, 462
  - positive reinforcement and, 54
  - self-determination and, 456–458
  - work-avoidance goals and, 473
- Eyewitness testimony, 271–272, 275
- Facilitating anxiety, 451–452
- Facilitation effect, 120
- Failure
  - attributions and, 479, 480, 481–483
  - avoidance of, 435, 465
  - classical conditioning and, 37, 40, 45
  - cooperative learning and, 342, 344
  - motive to avoid, 444
  - performance goals and, 472
  - self-efficacy and, 129–130, 131
  - self-worth and, 435–436
  - value in learning from mistakes, 81
- Failure of others, and self-efficacy, 130–131
- Failure to retrieve, and forgetting, 278–279
- False memories, 273
- Familiarity, and reasoning abilities, 309, 310
- Fan effect, 277
- Far transfer, 392, 398
- Fears. *See also* Anxiety
  - anxiety contrasted with, 450
  - classical conditioning and, 37, 38, 39, 40, 42–44
  - phobias, 37, 43n
  - punishments and, 82
- Features, and positive instances, 237
- Feedback
  - enactment and, 208
  - instructional strategies, 218
  - motor reproduction and, 126–127, 127n, 137
  - negative feedback, 55, 458
  - peer tutoring and, 345
  - positive feedback, 55–56, 208, 458
  - self-determination and, 457–458
  - technology-based collaborative learning, 349
- Fetal alcohol syndrome, 24
- FI (fixed interval) schedules, 69
- Figure-ground, 148, 166–167
- Filters, and attention, 165
- Fixed interval (FI) schedules, 69
- Fixed ratio (FR) schedules, 67
- Flashbulb memories, 271, 277, 448
- Flow, defined, 428–429
- Flowcharts, 359–360
- fMRI (functional magnetic resonance imaging), 17
- Folk theories, 245n
- Forebrain
  - attention and, 166n
  - development of, 22
  - parts of, 18–20
- Forgetting
  - construction error and, 279
  - decay and, 276
  - failure to retrieve, 278–279
  - failure to store or consolidate, 279
  - infantile amnesia and, 279–280
  - interference and, 276–277
  - permanence of long-term memory and, 275–276
  - repression and, 277–278
  - verbal learning theory and, 150, 276
- Formal discipline, and transfer, 392–393, 396
- Formal education
  - neo-Piagetian theories of cognitive development and, 304
  - Vygotsky's cognitive development theory and, 314–315
- Formal operations stage, 298–299, 301–302
- Forward chaining, 65n
- Frames
  - programmed instruction and, 104–105
  - retrieval cues, 269, 373
- Free recall, 151
- FR (fixed ratio) schedules, 67
- Frontal lobes
  - affect and, 449n
  - attention and, 166n
  - brain development, 22, 23–24, 293
  - central executive and, 168n
  - memory and, 280
  - neurogenesis and, 28
  - parts of, 19
  - physiology of learning and, 29
  - working memory and, 168n
- Functional analysis, 93, 93n, 94
- Functional behavioral assessment, 93
- Functional fixedness, 405–406
- Functionalism, 6
- Functional magnetic resonance imaging (fMRI), 17
- Future time perspective, 445–446
- Gambler's fallacy, 421
- Gender-appropriate behavior
  - career goals and, 474
  - goals and, 128
  - models and, 121–123
- Gender differences
  - aggression and, 122n
  - attributions and, 484
  - self-efficacy and, 139
  - stereotypes of, 206, 474
- Generalization
  - applied behavioral analysis and, 95
  - classical conditioning and, 39, 74
  - concepts and, 261
  - instrumental conditioning and, 74
  - overgeneralization, 237, 242
  - transfer compared to, 390
  - undergeneralization, 237, 242
- Generalization gradient, 74
- Generalized imitation, 113
- Generalized self-efficacy, 139
- General transfer, 392, 393, 396
- Generation effect, 196
- Gestalt psychology
  - as cognitive learning theory, 141, 144–148
  - constructivism and, 155
  - defined, 6
  - figure-ground and, 148, 166–167
  - law of closure, 146, 148, 186
- Gestures, 225
- Glial cells
  - astrocytes, 28
  - brain development and, 22
  - defined, 14
  - functions of, 16
  - myelin sheath and, 16, 23
- GLOBE Program, 349
- Goal-directed behavior, 294
- Goals. *See also* Achievement goals; Mastery goals; Performance goals
  - attributions and, 480
  - career goals, 474
  - cooperative learning and, 341–342
  - coordinating multiple goals, 475, 494
  - instructional objectives and, 101
  - learning strategies and, 382
  - motivation and, 427, 431, 466–475, 493
  - purposive behaviorism and, 143
  - self-efficacy and, 128
  - self-regulated learning and, 356, 357
  - self-regulation and, 132, 489
  - social goals, 442, 473–474
  - work-avoidance goals, 473, 474
- Good behavior game, 96–97
- Graphic organizers, 359, 360, 365
- Group-based instruction, 211
- Group contingencies, 96–98
- Grouping procedures, and motivation, 499
- Group interactions. *See also* Peer-interactive instructional strategies and personal theories, 250
- Group success and failure
  - cooperative learning and, 342, 344
  - self-efficacy and, 131

- Growth needs, 433  
 Guided participation, 324  
 Guided peer questioning, 343
- Habits, and classical conditioning, 45–46  
 Habits of mind, 445n  
 Habit strength, 429–430  
 Habit times drive, 430  
 Halo effect, 206  
 Hands-on experiences, 307–308  
 Harrison, George, 274  
 Help-seeking behavior, 357, 480, 488, 488n  
 Hemispheres, of brain, 18–21, 30  
 Heredity, and brain development, 24  
 Heterogeneous cooperative groups, 341  
 Heuristics, for problem solving, 410–413, 417  
 Hierarchies  
   long-term memory organization and, 229–231, 233, 234  
   response hierarchies, 401  
 Hierarchy of needs, Maslow's theory of, 432–434, 458  
 Higher-level questions, 283, 285, 340  
 Higher-level skills, and instructional objectives, 101, 103  
 Higher mental functions, 314, 316  
 Higher-order conditioning, and classical conditioning, 40–41, 43  
 High-road transfer, 398n  
 High-stakes tests, 102, 454  
 Hindbrain  
   attention and, 166n  
   development of, 22  
   parts of, 18  
 Hippocampus  
   attention and, 166n  
   brain development, 23  
   explicit knowledge and, 224n  
   memory and, 280  
   neurogenesis and, 28  
   as part of brain, 19–20, 20n  
   physiology of learning and, 29  
 Hormones, puberty, 24  
 Horns effect, 206  
 Hot cognition, 448  
 Humanism, 432  
 Hypercognition, 353n  
 Hypothalamus, 20  
 Hypothesis testing, 422
- Iconic memory, 161n  
 Identical elements, 393–394  
 Identified motivation, 490  
 Identity cues, 269  
 Ill-defined problems, 400, 404, 417–418  
 Illusion of knowing, 365, 481  
 Image management  
   attributions and, 484–485  
   relatedness needs and, 442
- Imitation, and social cognitive theory, 112, 113, 114, 119  
 Immediate reinforcement, and programmed instruction, 105  
 Implicit knowledge  
   affect and, 449  
   conceptual change and, 253  
   explicit knowledge distinguished from, 223–224  
   infancy and, 280  
   long-term memory and, 174, 177  
   metacognition and, 356, 356n  
 Incentive motivation, 430  
 Incentives  
   drive theory and, 430–431  
   social cognitive theory and, 117  
 Incidental learning  
   levels-of-processing model of memory and, 178, 179, 194  
   self-reference effect and, 193–194  
 Incompatible behaviors  
   classical conditioning and, 43, 46  
   reinforcement of, 88, 94  
 Incongruity, and attention, 164  
 Incremental view of intelligence, 478, 478n, 480  
 Incubation, and problem solving, 407–408  
 Individual accountability, and cooperative learning, 344  
 Individual constructivism, 155, 289  
 Individual differences  
   in critical thinking, 423  
   in learning rate, 105  
   in motivation, 442–446  
 Individual interests, 463n  
 Inert knowledge, 390  
 Infancy  
   brain development, 22–23, 27–28, 30  
   classical conditioning model and, 35  
   concept learning and, 239  
   hands-on experiences and, 307  
   joint attention and, 327–328  
   law of similarity and, 146  
   memory and, 279–280  
   organization and, 236  
   sensorimotor stage and, 300  
 Infantile amnesia, 279–280  
 Inferences  
   about cognitive processes, 153–154  
   comprehension monitoring and, 366  
   concepts and, 261  
   instructional strategies, 215  
   meaningful learning and, 359  
   stereotypes and, 262  
 Informal conversations, and Vygotsky's cognitive development theory, 314–315  
 Information processing theory  
   constructivism and, 156  
   defined, 154  
   memory and, 158–159, 289
- neo-Piagetian theories of cognitive development and, 302–303  
 problem solving and, 402  
 sociocultural theory integrated with, 327–330  
 storage and, 159  
 transfer and, 395  
 Inhibition, and forgetting, 276, 277, 278  
 Inhibition effect, 120  
 In-house suspension, 60  
 Inner speech, 316, 319  
 Inquiry learning, 308, 320  
 Insight  
   Gestalt psychology and, 148  
   problem solving and, 401, 408  
 Instructional objectives  
   behavioral objectives, 99–100, 101  
   concept learning and, 241–245  
   current perspectives on, 100–101  
   standards and, 101, 103–104  
   usefulness and effectiveness of objectives, 101–103  
 Instructional strategies. *See also* Classroom practice; Educational implications; Peer-interactive instructional strategies  
   cognitive processes and, 157  
   conceptual change and, 254–259  
   critical thinking and, 423–424  
   learning and study strategies, 382–387  
   long-term memory storage and, 211–218  
   motivation and cognitive processes, 491–498  
   Piagetian and neo-Piagetian theories, 307–311  
   retrieval and, 280–287  
   theories of learning and, 9  
   for transfer and problem solving, 414–420  
 Instrumental conditioning  
   antecedent stimuli and responses in, 73–75  
   applied behavior analysis and, 92–99  
   classroom management and, 79–92  
   cognitive processes and, 75–76  
   common phenomena in, 63–72  
   defined, 48  
   imitation and, 115  
   instructional objectives and, 99–104  
   mastery learning and, 106–109  
   motivation and, 76  
   operant conditioning contrasted with, 57  
   punishments, 48, 49, 57–62  
   reinforcement, 50–57, 117  
   social cognitive theory and, 114  
   Thorndike's research, 48, 49, 58  
 Integrated motivation, 490–491



- Intelligence  
 attributions and, 478  
 distributed intelligence, 156, 331  
 entity view of, 478, 478n, 479–480, 495  
 incremental view of, 478, 478n, 480
- Intelligent tutors, 106
- Intensity, and attention, 164
- Intentionality, 476n
- Intentional learning, 380
- Intention to learn  
 levels-of-processing model of memory and, 178, 179  
 neo-Piagetian theories of cognitive development and, 303
- Interconnectedness  
 of brain structures, 21, 28  
 of long-term memory, 174
- Interests  
 effects of, 463–464  
 factors promoting, 464  
 motivation and, 462–464, 488–489, 491–492
- Interference  
 forgetting and, 276–277  
 sensory register and, 162  
 working memory and, 171
- Intermittent reinforcement  
 reinforcement schedules, 66–71, 85, 87  
 social cognitive theory and, 113
- Internalization, 316, 335, 338, 346, 490n
- Internalized motivation  
 expectancies and values, 466, 489–491  
 promoting, 492–493
- Internal organization  
 long-term memory storage and, 194–195  
 retrieval and, 281  
 study strategies and, 359
- Internal processes, behaviorism's  
 exclusion of study of, 33
- Internet  
 authentic activities and, 420  
 critical thinking and, 422, 424  
 learning strategies and, 385  
 problem solving and, 417  
 reading for learning and, 354  
 technology-based collaborative learning and, 349
- Interneurons, 14, 15
- Interpersonal behaviors, and modeling, 122, 123–124
- Interrater reliability, 93
- Intersubjectivity, 327–328
- Interval schedules, 69–70
- Interventions, and applied behavioral analysis, 94–95
- Intrinsic motivation  
 classroom environment and, 455–456  
 defined, 428  
 expectancies and values, 465  
 extrinsic motivation versus, 428–429  
 extrinsic reinforcers and, 81, 439  
 integrated motivation distinguished from, 490–491  
 interest and, 462  
 relatedness needs and, 442  
 self-determination and, 437–440, 456–457  
 self-regulation and, 488  
 sense of confidence and, 437
- Intrinsic reinforcers, 55–56, 79, 80, 81, 86
- Introjection, 490
- Introspection, 6, 32
- Intuitive epistemology, 375n
- Irrelevant features, 237, 241
- James, William, 159–160, 393
- Jigsaw technique, 342, 347
- Joint attention, 327–328, 332
- Judgment of learning, 364n
- Keller Plan, 107–108
- Keyword method, mnemonics, 369–371, 385
- Knowledge. *See also* Declarative knowledge; Epistemic beliefs; Explicit knowledge; Implicit knowledge; Prior knowledge; Procedural knowledge  
 certainty of, 378  
 concepts and, 235–243, 261–262  
 conceptual change and, 252–259  
 encoding in long-term memory, 224–228, 260  
 expertise and, 259–260  
 generalizations about, 260–262  
 inert knowledge, 390  
 kinds of, 222–224  
 nature of, 221–222  
 organization of, 153  
 personal theories and, 245–250  
 schemas and, 243–246  
 worldviews and, 250–252
- Knowledge base, 408, 415
- Knowledge building, 347
- Knowledge Forum, 348–349
- Knowledge maps, 215
- Language  
 foreign language learning, 148, 223–224  
 long-term memory storage and, 174  
 preoperational stage and, 295  
 verbal learning and, 141, 148–152  
 Vygotsky and Piaget contrasted, 319–320  
 Vygotsky's cognitive development theory and, 315–316
- Language development  
 brain possibly prewired for, 27–28  
 concept learning and, 239–241  
 critical periods, 25  
 memory and, 280
- Latent learning, defined, 143
- Lateral transfer, 391
- Law, defined, 5
- Law of closure, 146, 148, 186
- Law of effect, 49, 50, 58
- Law of Prägnanz, 146
- Law of proximity, 145
- Law of similarity, 146
- Learned helplessness, and attributions, 9, 485–487
- Learned industriousness, 445
- Learner-centered instruction, 211
- Learner-directed instruction  
 conceptual change and, 258–259  
 defined, 211
- Learning. *See also* Cooperative learning; Learning strategies; Mastery learning; Meaningful learning; Rote learning; Self-regulated learning; Serial learning; Theories of learning; Verbal learning  
 assessment of, 4  
 behavioral changes and, 4, 6, 33, 46, 85–86, 112, 152, 153  
 classical conditioning and, 36–37  
 defined, 4, 33  
 forms of, 1  
 importance of, 2–3  
 as internal change, 142–143, 153  
 memory distinguished from, 158–159  
 mental representations and, 4, 33, 152–153, 158  
 physiological basis of, 28–29  
 Piaget's cognitive development theory and, 292  
 reinforcement interfering with, 81  
 self-efficacy for, 129  
 social cognitive theory and, 116
- Learning disabilities, 487
- Learning environments, 9
- Learning goals, 468n
- Learning rate  
 epistemic beliefs and, 379  
 individual differences in, 105
- Learning strategies. *See also* Study strategies  
 attributions and, 480  
 defined, 358, 358n  
 epistemic beliefs and, 379, 381, 385–386  
 expertise and, 259–260  
 ineffective strategy use, 380–382  
 metacognition and, 353, 354, 374  
 promoting effective strategies, 382–387  
 self-regulated learning and, 357
- Learning tactics, 358n
- Legitimate peripheral participation, 324n
- Less-is-more principle, 262, 397
- Level of potential development, 317, 326–327

- Levels-of-processing model of memory, 177–179, 255, 284n
- Limbic system, 19–20, 449n
- Limited processing capacity, 167
- Linear programs, 105
- Little Albert case, 37, 39, 396
- Little Peter case, 43
- Live models, 120
- Locus, and attributions, 476, 477, 478, 482
- Locus of control, 476
- Long-term change, 4
- Long-term memory. *See also* Retrieval  
 affect and, 449, 449n  
 characteristics of, 174  
 concepts and, 235–243  
 defined, 173  
 encoding knowledge in, 224–228, 260  
 fallibility of, 362  
 moving information to, 173  
 organization of, 229–235, 281  
 temporal lobes and, 19  
 working memory compared to, 175–176
- Long-term memory storage  
 characteristics of, 174  
 consolidation and, 199–200  
 constructive nature of, 185–188, 287  
 elaboration and, 195–196  
 enactment and, 207–208  
 expectations and, 205–207  
 factors affecting, 200–210  
 idiosyncratic nature of, 218–219  
 internal organization and, 194–195  
 meaningful learning and, 172, 192–194  
 mechanisms of, 184–185  
 misconceptions and, 204–205  
 nonconscious information in, 176–177  
 prior knowledge and, 200–204  
 procedural knowledge and, 198–199  
 processes of, 188–200  
 promoting, 211–218  
 redundancy in, 260  
 rehearsal and, 191–192  
 repetition and review, 208–211  
 retrieval and, 266  
 selection and, 190–191  
 verbalization and, 207, 329  
 visual imagery and, 196–198, 215–217  
 working memory and, 200
- Love and belongingness needs, 432, 433, 434, 459
- Lower-level questions, 283, 285
- Lower-level skills, 100–101, 286–287
- Lower mental functions, 314
- Low-road transfer, 398n
- Magnetic resonance imaging (MRI), 17
- Maintenance rehearsal, 172–173, 175, 191, 303
- Maslow, Abraham, hierarchy of needs, 432–434, 458
- Massed practice, 149, 208, 218
- Mastery goals, 468–471, 480, 493–494, 496–497
- Mastery learning  
 components of, 106–107  
 defined, 106  
 effectiveness of, 108–109  
 transfer and, 397
- Mastery orientation, 485–486, 487
- Material reinforcers, 54, 55, 79–80, 83
- Mathematics  
 anxiety and, 453–454  
 automaticity and, 210  
 central conceptual structures, 304, 305–307  
 epistemic beliefs and, 376, 409  
 meaningless versus meaningful  
 problem solving and, 413–414  
 negative transfer and, 391  
 transfer and, 395–396
- Meaning  
 construction of, 188  
 encoding and, 227–228  
 long-term memory storage and, 190  
 organization and, 171  
 peer-interactive instructional strategies  
 and, 334  
 propositions and, 227, 233–234  
 social construction of, 321–323  
 verbal learning theory and, 150, 151  
 Vygotsky's cognitive development  
 theory and, 314–315  
 working memory capacity and, 169
- Meaningful learning  
 appropriate use of, 383  
 classroom tasks and, 333  
 conceptual change and, 255  
 elaboration compared to, 195n  
 epistemic beliefs and, 378  
 long-term memory storage and, 172, 192–194  
 metacognition and, 355  
 peer tutoring and, 345  
 positive transfer and, 390–391  
 prior knowledge and, 201  
 problem-solving strategies and,  
 414–415  
 proposition network model and, 233  
 rehearsal and, 191  
 self-determination and, 440  
 study strategies and, 358–359  
 teacher-directed instruction and, 212  
 transfer and, 397, 414
- Meaningful learning set, 213
- Means-ends analysis, 411, 418
- Mediated learning experience, 321–323
- Mediation, and Vygotsky's cognitive  
 development theory, 315
- Medulla, 18
- Memorization, 192
- Memory. *See also* Forgetting; Long-term  
 memory; Retrieval; Working memory  
 activation and, 179–180, 268  
 affect and, 448–450  
 alternative views of, 177–180  
 defined, 158–159  
 dual-store model of, 159–177, 181,  
 191, 250  
 educational implications of, 181–183  
 learning distinguished from, 158–159  
 levels-of-processing model of, 177–179  
 metacognition and, 373–374  
 semantic memory, 222, 260  
 sensory register, 161–162  
 social construction of, 328–329  
 verbal learning theory and, 150
- Memory codes  
 modeling and, 125–126, 137, 159n  
 social cognitive theory and, 116, 227n
- Memory traces, 146
- Mental hoarding, 280
- Mental models, 250
- Mental representations  
 classical conditioning and, 41–42  
 learning and, 4, 33, 152–153, 158
- Mental sets  
 automaticity and, 210, 406  
 encoding and, 404–407  
 problem solving and, 404–407, 416  
 transfer and, 415
- Mental stages, in problem solving, 401–  
 402
- Mental visualization, and verbal learning  
 theory, 150, 152
- Messages from others, and self-efficacy,  
 130
- Metacognition  
 attributions and, 481  
 critical thinking and, 423  
 defined, 352–353  
 development of, 373–375  
 knowledge and, 283  
 problem solving and, 408–409, 417,  
 418  
 self-monitoring and, 274  
 self-reflection and, 133  
 self-regulation and, 136  
 skills of, 353–356  
 transfer and, 396
- Metacomprehension, 364n
- Meta-knowing, 375n
- Metamemory, 353n
- Metamnemonic evaluation, 364n
- Method of loci, mnemonics, 367–368
- Midbrain  
 attention and, 166n  
 development of, 22  
 parts of, 18
- Middle childhood  
 approval needs and, 443

- attributions and, 481
  - brain development, 23–24, 30
  - central conceptual structure for
    - number and, 306
  - concept learning and, 293
  - conceptual change and, 252
  - concrete operations stage and,
    - 300–301
  - hands-on experiences and, 307
  - learned helplessness and, 486
  - metacognition and, 373–374
  - performance goals and, 472
- Mindful learning, 380n
- Mindfulness, 380n
- Min strategy, 409–410
- Mirror neurons, 27, 119
- Misconceptions
  - concept maps and, 360
  - conceptual change and, 215, 252, 253, 254–255, 256, 257–258, 259
  - elaboration and, 215
  - expertise and, 259
  - long-term memory storage and, 204–205
  - peer-interactive instructional strategies and, 336
  - personal theories and, 205, 248, 249
- Misinformation effect, 272
- Missing recess, 62
- Mnemonics
  - appropriate use of, 383
  - promoting use of, 385
  - study strategies and, 366–373
  - superimposed meaningful structure, 269, 371–373
- TARGETS mnemonic for motivational strategies, 498, 499
- verbal mediation, 367
- visual imagery, 197, 367–371
- Models and modeling
  - adults as, 114, 120–123, 125, 132, 134, 138–139, 329, 333
  - applied behavioral analysis and, 99
  - apprenticeships and, 325
  - attention and, 124–125, 127, 137
  - behaviors learned through, 122–124
  - characteristics of effective models, 120–122
  - cognitive modeling, 123, 134, 217, 329
  - community of learners and, 348
  - conditions necessary for, 124–127
  - coping models, 131, 139
  - critical thinking and, 423
  - defined, 112
  - effects of, 120
  - memory codes and, 125–126, 137, 159n
  - motivation and, 127, 137–138, 426, 455
  - peer-interactive instructional strategies and, 335
  - reciprocal teaching and, 340
  - self-efficacy and, 127, 130–131
  - self-regulated learning and, 357
  - self-regulation and, 132
  - social cognitive theory and, 6, 112, 114, 116, 119–127, 137–138
  - teachers as models, 123, 138, 384, 459
- Mood-dependent memory, 449
- Motion, and attention, 163
- Motivating operation, 76n
- Motivation. *See also* Intrinsic motivation
  - affect and, 427, 447, 459–460
  - attributions and, 475–487
  - classroom environment and, 455–460
  - cognitive processes and, 427, 462, 475, 491–498
  - conceptual change and, 256–257, 426, 428
  - defined, 426
  - expectancies and values, 464–466, 489–493
  - extrinsic versus intrinsic, 428–429, 437, 490
  - general effects of, 427–429
  - goals and, 427, 431, 466–475, 493
  - individual differences in, 442–446
  - instrumental conditioning and, 76
  - interests and, 462–464, 488–489, 491–492
  - internalized motivation, 466, 489–493
  - modeling and, 127, 137–138, 426, 455
  - peer-interactive instructional strategies and, 335
  - personalized system of instruction and, 108
  - Piaget's cognitive development theory and, 290
  - positive behavior support and, 95
  - self-regulated learning and, 356, 426
  - self-regulation and, 488–489
  - situated motivation, 427, 455
  - transfer and, 396
- Motivation to learn, 471, 490
- Motive for success ( $M_s$ ), 444
- Motive to avoid failure ( $M_{af}$ ), 444
- Motor neurons, 14–15
- Motor reproduction, modeling and, 126–127, 137, 207
- Multiple baselines, 89–90, 96
- Multiple perspectives, and class
  - discussions, 336
- Multitasking, 200
- Myelination, brain development, 23, 24, 303
- Myelin sheath
  - defined, 15
  - glial cells and, 16, 23
- Naive beliefs, 204n, 254
- Naive conceptions, 204n
- Narratives
  - retrieval and, 273–274
  - social construction of memory and, 328–329
- Near transfer, 391–392
- Need for achievement, 443–444
- Need for affiliation, 442–443
- Need for approval, 443
- Need for arousal, 431–432, 431n, 458
- Need for cognition, 432, 445, 446
- Need for esteem from others,
  - 432–433
- Need for relatedness, 441–442
- Need for self-esteem, 432–433
- Needs
  - arousal and, 431–432, 431n, 458
  - competence and self-worth, 434–437
  - drive reduction and, 429–431
  - individual differences in motivation and, 442–446
  - Maslow's hierarchy of, 432–434, 458, 459
  - relatedness and, 441–442, 458–459, 473–474
  - self-determination and, 437–441
- Negative feedback, 55, 458
- Negative instances, 236, 242
- Negative reinforcement, 56–57, 58, 71, 72
- Negative transfer, 391, 394–395, 417
- Neobehaviorism, 33
- Neo-Piagetian theories of cognitive development
  - Case's theory, 304–307, 311
  - information processing theory and, 302–303
  - instructional strategies based on, 307–311
  - key ideas of, 303–304
- Nervous system
  - central nervous system, 14, 15
  - glial cells, 16
  - neurons, 14–15
  - peripheral nervous system, 14, 15
  - synapses, 16
- Network model, of long-term memory organization, 231–234
- Neurogenesis, 28
- Neuroimaging, brain research
  - methods, 17, 18
- Neurons
  - defined, 14
  - differentiation, 22
  - interconnectedness of brain structures, 21, 28
  - mirror neurons, 27
  - prenatal development, 22
  - roles of, 14–15
- Neurotransmitters
  - defined, 16
  - puberty, 24
- Neutral stimulus (NS), 35, 40, 41, 53

- No Child Left Behind Act of 2001 (NCLB), 102–103
- Nodes, 234
- Nominal stimulus, 163n
- Noncontingent reinforcement, 87
- Nonsense syllables, 150
- Note taking, 360, 362–363, 402
- Novelty, and attention, 164
- Number, central conceptual structures, 304, 305–307
- Nutrition, brain development, 24
- Objectivity, in study of learning, 153
- Object permanence, 294, 300
- Observation
  - self-observation, 132
  - social cognitive theory and, 113, 114, 119, 137
  - unobservable mental processes and, 153–154
- Occipital lobes, 19
- Ontological cognition, 375n
- Open-mindedness, 445, 446
- Operant conditioning
  - classical conditioning contrasted with, 52–53
  - conditions for, 51–52
  - defined, 50
  - instrumental conditioning contrasted with, 57
  - Skinner and, 50–53, 57, 73
- Operations, Piaget's cognitive development theory, 291
- Optical illusions, Gestalt psychology, 144
- Organisms
  - behaviorism and, 32, 33–34
  - defined, 32
- Organization
  - classroom tasks and, 333
  - cognitive learning theories and, 151
  - constructivism and, 154–155
  - external organization, 194
  - Gestalt psychology and, 144, 145, 146, 148
  - internal organization, 194–195, 281, 359
  - of knowledge, 153
  - learning strategies and, 383–384
  - of long-term memory, 229–235, 281
  - metacognition and, 374, 375
  - peer-interactive instructional strategies and, 334
  - Piaget's cognitive development theory and, 291
  - purposive behaviorism and, 143–144
  - study strategies and, 359–360
  - verbal learning theory and, 151
  - working memory and, 171–172
- Others
  - need for esteem from, 432–433
  - success or failure of, 130–131
- verbal and nonverbal messages from, 482–483
- Outcome expectations, and social cognitive theory, 116, 117
- Outcomes, and instructional objectives, 101
- Outlines, 359
- Out-of-school suspension, 62
- Overgeneralization, 237, 242
- Overlearning
  - defined, 149
  - long-term memory storage and, 208
- Overt strategies, 373, 384
- Paired-associate learning, 148, 149–150, 152
- Paradigm shifts, 260n, 408
- Parallel distributed processing (PDP), 234–235
- Parietal lobes
  - attention and, 166n
  - neurogenesis and, 28
  - as part of brain, 19
- Parsimony (conciseness), 34
- Passive avoidance learning, 72
- Patterns, in serial learning, 148–149
- Pavlov, Ivan
  - behaviorism and, 32
  - classical conditioning and, 34–36, 35n, 38–41
- PBS (positive behavior support), 94–95, 98–99
- PDP (parallel distributed processing), 234–235
- Peer-Assisted Learning Strategies (PALS), 345
- Peer-interactive instructional strategies
  - benefits of, 334–335
  - class discussions, 336–338, 348
  - communities of learners, 346–348
  - cooperative learning, 340–344, 348
  - drawbacks of, 335–336
  - learning strategies and, 385
  - peer tutoring, 344–346
  - reciprocal teaching, 338–340
  - technology-based collaborative learning, 348–350
- Peer pressure, 97, 443
- Peer relationships
  - approval needs and, 443
  - attributions and, 481, 485
  - community of learners and, 348
  - cooperative learning and, 341
  - peer-interactive instructional strategies and, 335
  - performance goals and, 472, 493
  - Piaget's cognitive development theory and, 309
  - self-efficacy and, 130–131
  - Vygotsky's cognitive development theory and, 316
  - work-avoidance goals and, 473
- Peer tutoring, 344–346, 344n
- Pegword method, mnemonics, 368–369
- Pendulum problem, 299
- Perception
  - construction in, 185–188
  - encoding and, 224–225
  - Gestalt psychology and, 144
  - self-perceptions, 436
  - social cognitive theory and, 119
  - visual perception, 25
  - Vygotsky and Piaget contrasted, 320
- Performance
  - anxiety's effects on, 450–452
  - attributions and, 478
  - feedback and, 457–458
  - of learned behaviors, 33
  - reinforcement influencing, 143
  - self-efficacy for, 129
- Performance-approach goals, 468–471
- Performance-avoidance goals, 468–470, 472
- Performance goals
  - achievement goals and, 468–472, 480, 493–494
  - competition and, 496–497
  - learned helplessness and, 486
  - relatedness needs and, 442
- Peripheral nervous system, 14, 15
- Persistence
  - achievement needs and, 444
  - attributions and, 479–480
  - mastery orientation and, 486
  - motivation and, 427, 428, 488
  - self-efficacy and, 128
- Personal agency
  - self-regulation and, 131–132, 441n
  - social cognitive theory and, 113
- Personal epistemology, 375n
- Personal interests, 463
- Personalized system of instruction (PSI), 107–109
- Personal significance
  - attention and, 164–165
  - decay and, 276
- Personal theories
  - constructivism and, 155
  - fostering development of, 248, 250
  - knowledge and, 245–250
  - misconceptions and, 205, 248, 249
  - reality versus, 247–248
- Persuasion skills, and community of learners, 348
- PET (positron emission tomography), 17
- Phi phenomenon, 144
- Phobias, and classical conditioning, 37, 43n
- Phonological loop, 170, 173, 175
- Physical punishment, 61, 82, 89
- Physiological needs, 432, 433, 434, 458
- Piaget, Jean

- cognitive development theory of, 289–299, 300, 301–302, 304, 309, 319, 447  
 competence and, 435  
 current perspectives on theory of, 300–302  
 developmental psychology and, 141  
 instructional strategies based on theory of, 307–311  
 key ideas in theory of, 290–293  
 stages of cognitive development, 293–299, 319  
 Vygotsky compared to, 314, 315, 318–321
- PI (programmed instruction), 44, 104–105, 106, 109
- Planning, and self-regulated learning, 356
- Plasticity  
 defined, 24  
 experience-dependent plasticity, 26  
 experience-expectant plasticity, 26
- Play  
 trial and error in, 415  
 Vygotsky's cognitive development theory and, 318
- Pons, 18
- Positive behavior support (PBS), 94–95, 98–99
- Positive feedback, 55–56, 208, 458
- Positive instances, 236–237, 242
- Positive-practice overcorrection, 59–60
- Positive psychology, 432
- Positive reinforcement, 54–56, 57, 83–84, 483
- Positive transfer, 390–391, 394–395, 397, 414
- Positron emission tomography (PET), 17
- Postmortem studies, brain research methods, 17–18
- Postreinforcement pause, 67
- Posttraumatic stress disorder, 43
- Practice. *See also* Classroom practice  
 behaviorism and, 44–45  
 distributed practice, 149, 208, 218  
 long-term memory storage and, 209  
 massed practice, 149, 208, 218  
 positive-practice overcorrection, 59–60  
 stimulus–response connections strengthened by, 149  
 transfer and, 398, 416
- Praise  
 attributions and, 483  
 learned helplessness and, 487  
 as positive reinforcement, 54, 54n, 83–84, 483  
 as secondary reinforcer, 53, 53n, 54
- Pre-aversive stimulus, 71, 72
- Prefrontal cortex, 19
- Premack principle, 54–55, 135
- Prenatal development  
 brain structures, 18, 22  
 environmental factors in, 30
- Preoperational stage, 295–297, 300
- Press for understanding, 471
- Primacy effect, 148, 175
- Primary reinforcers, 53–54
- Priming  
 activation and, 180, 205  
 forgetting and, 277  
 retrieval cues and, 268
- Principles  
 defined, 5  
 perspective on, 10  
 transfer and, 397–398
- Prior knowledge  
 class discussions and, 336  
 elaboration and, 195, 201, 202, 358  
 instructional strategies, 212–213, 214  
 learning strategies and, 382, 383  
 long-term memory and, 173  
 long-term memory storage and, 200–204
- Piaget's cognitive development theory  
 and, 292, 301–302  
 problem solving and, 406, 407  
 transfer and, 395
- Proactive facilitation, 150
- Proactive inhibition, 150
- Probabilistic reasoning, 422
- Problem-based learning (PBL), 333, 419–420
- Problem finding, 416–417
- Problem schemas, 403–404
- Problem solving  
 affect and, 448, 450  
 cognitive factors in, 402–409  
 components of problem, 399–400  
 critical thinking and, 423  
 defined, 399  
 Gestalt psychology and, 144, 147–148  
 ill-defined problems, 400, 404, 417–418  
 instructional strategies and, 414–420  
 meaningless versus meaningful, 413–414  
 strategies for, 409–413  
 theories of, 400–402  
 transfer and, 399  
 trial-and-error behavior and, 49, 147, 400–401, 408  
 working memory and, 177
- Procedural knowledge  
 acquisition of, 198–199  
 defined, 223  
 instructional strategies and, 217  
 long-term memory and, 174, 190  
 productions and, 226  
 taxonomies and, 283  
 transfer and, 390
- Process goals, 493
- Procrastination, 108
- Product goals, 493
- Productions, and action-based encoding, 226, 400
- Proficiencies, and instructional objectives, 101
- Programmed instruction (PI), 44, 104–105, 106, 109
- Project-based learning, 333
- Prompting, 73–74
- Pronunciation, and verbal learning theory, 150
- Proportional thinking, 299, 310
- Propositional network, and long-term memory organization, 232–234
- Propositions, and meaning, 227, 233–234
- Prosocial behavior, 124
- Prospective memory, 278
- Prototypes, 238, 242
- Proximal goals, 493
- Proximity, law of, 145
- PSI (personalized system of instruction), 107–109
- Psychogenic amnesia, 278n
- Psychological punishment, 61–62, 80, 82, 89
- Psychomotor behaviors, modeling and, 122
- Psychosis, 13
- Puberty, brain development, 24
- Public reinforcement, 85
- Punishment, consistency in, 91–92, 137
- Punishment I, 57, 58, 82
- Punishment II, 57, 58, 82
- Punishments  
 applied behavioral analysis and, 94  
 attributions and, 479  
 for classroom management, 88–92  
 concerns about classroom use of, 79–82  
 controlling messages and, 439n  
 cueing and, 73–74  
 defined, 57  
 effective forms of, 58–61  
 immediacy of, 91  
 ineffective forms of, 61–62, 89  
 instrumental conditioning, 48, 49, 57–62  
 negative side effects of, 82  
 response-punishment contingencies, 113, 116  
 severity of, 88, 89  
 social cognitive theory and, 114–115  
 supportive context with, 91  
 suppression effect of, 82  
 threats of, 89  
 vicarious punishment, 114–115, 120
- Purposive behaviorism, 141–144, 155
- Questions. *See also* Teacher questions  
 community of learners and, 347  
 guided-peer questioning, 343  
 higher-level questions, 283, 285, 340  
 lower-level questions, 283, 285  
 peer tutoring and, 345  
 self-questioning, 365–366

- Radical behaviorism, 33n
- Radical constructivism, 247n
- Ratio schedules, 67–68
- Readiness, Vygotsky and Piaget compared, 319
- Reading
  - and automaticity, 209–210
  - for learning, 354
- Real-world contexts, 419–420
- Recency effect, 148, 175–176
- Receptor cells, 14, 15
- Receptor neurons, 14n
- Reciprocal causation, and social cognitive theory, 118–119, 137
- Reciprocal teaching, peer-interactive instructional strategies, 338–340
- Recognition, and motivation, 499
- Redundancy, 191
- Reflection, and apprenticeships, 325
- Reflexes, and sensory neurons, 16–17
- Refutational texts, 256
- Rehearsal
  - long-term memory storage and, 191–192
  - maintenance rehearsal, 172–173, 175, 191, 303
  - metacognition and, 374
  - modeling and, 125
  - social cognitive theory and, 116
- Reinforcement
  - attributions and, 479
  - concerns about classroom use of, 79–82
  - consistency in, 66, 104, 137
  - continuous reinforcement, 66, 67, 85
  - decreasing undesirable behaviors with, 86–92
  - defined, 51
  - forms of, 53–57
  - immediate, 52, 86
  - increasing desirable behaviors with, 82–86
  - instrumental conditioning and, 50–57, 117
  - motivation and, 426
  - negative reinforcement, 56–57, 58, 71, 72
  - of other behaviors, 87–88
  - positive reinforcement, 54–56, 57, 83–84, 483
  - as principle of learning, 5
  - purposive behaviorism and, 143
  - schedules of, 66–71
  - social cognitive theory and, 113–114, 116–117
  - superstitious behavior and, 63
  - vicarious reinforcement, 114–115, 120
- Reinforcement schedules
  - differential schedules, 70–71
  - effects of, 66–71
  - intermittent reinforcement, 66–71, 85, 87
  - interval schedules, 69–70
  - ratio schedules, 67–68
- Reinforcers
  - defined, 51
  - drive reduction and, 429
  - extrinsic reinforcers, 54, 81, 83, 86, 439, 456–458, 462, 473
  - instrumental conditioning and, 48, 49
  - intrinsic reinforcers, 55–56, 79, 80, 81, 86
  - operant conditioning and, 50–53
  - primary reinforcers, 53–54
  - secondary reinforcers, 53–54, 98
  - social reinforcers, 54, 55, 79, 80, 83, 97
  - transituational generality of, 51
- Relatedness, needs and, 441–442, 458–459, 473–474
- Relation, in propositions, 228
- Release from time-out, 60
- Relevancy, of models, 122
- Religion
  - conceptual change and, 253
  - critical thinking and, 423
  - worldviews and, 251
- Repetition
  - instructional strategies, 218
  - long-term memory storage and, 208–211
- Repression, 277–278
- Research
  - brain research, 17–18, 29–31
  - epistemic beliefs and, 376
  - ethical guidelines, 9n, 37
  - on learning, 5
  - methodology of, 6
  - serial learning and, 152
  - theories of learning and, 7–8
- Resilient self-efficacy, 130, 436n, 487
- Respondent conditioning, 35n
- Response-consequence contingencies, 84–85, 92, 116–118, 137, 491
- Response cost, 60
- Response generalization, 74n
- Response hierarchies, 401
- Response-punishment contingencies, 113, 116
- Response-reinforcement contingencies, 96, 109, 113, 116, 119
- Responses (R)
  - antecedent responses, 73–75
  - behaviorism and, 32–33
  - classical conditioning and, 35–43, 52–53
  - extinction and, 42–43, 43n, 86–87, 88
  - operant conditioning and, 50–53
  - problem solving and, 401
  - transfer and, 394–395
- Restitution, 59–60
- Restitutive overcorrection, 59–60
- Restructuring, 148
- Retention
  - modeling and, 125–126, 127, 137
  - social cognitive theory and, 113
- Reticular formation, 18, 166n
- Retrieval. *See also* Forgetting
  - affect and, 448–449, 450
  - anxiety and, 268, 453
  - cautions in, 275
  - constructing new "memories," 272–273
  - constructivism and, 270–275, 281–282, 287
  - duration of long-term memory and, 174
  - effects of subsequently presented information, 271–272
  - information processing theory and, 159
  - instructional strategies and, 280–287
  - problem solving and, 407–408
  - process of, 265, 266–270
  - remembering earlier recollections, 273–274
  - retrieval cues, 268–270, 282–283, 395, 407
  - self-monitoring during, 274
  - teacher questions and, 283, 284–285
  - time for, 284–285
  - working memory and, 172
- Retrieval cues, 268–270, 282–283, 395, 407
- Retrieval-induced forgetting, 277
- Retroactive facilitation, 150
- Retroactive inhibition, 150
- Retrograde amnesia, 199
- Reversal technique, 96
- Review
  - classroom assessments and, 286
  - instructional strategies, 218
  - long-term memory storage and, 208–211
- Revised law of effect, 49
- Rote learning
  - attributions and, 480
  - conceptual change and, 255, 258
  - long-term memory storage and, 192, 212
  - meaningful learning contrasted with, 359
  - retrieval and, 267
  - transfer and, 397
- Saccades, 186, 331
- Safety needs, 432, 433, 434, 458
- Scaffolding
  - apprenticeships and, 325
  - attributions and, 483
  - challenging tasks and, 333
  - community of learners and, 348

- cooperative learning and, 342, 343–344
- forms of, 323
- intrinsic motivation and, 457
- learning strategies, 384–385
- motivation and, 460, 492
- peer tutoring and, 345
- problem solving and, 418
- self-regulated learning and, 358
- summarizing and, 365
- Schemas
  - constructivism and, 155
  - defined, 243
  - knowledge and, 243–246
  - problem schemas, 403–404
  - problem solving and, 415
  - schemas distinguished from, 291n
- Schemes
  - Piaget's cognitive development theory and, 291, 319
  - schemas distinguished from, 291n
- Schizophrenia, 13, 16, 24
- Schoolwide positive behavior support, 98–99
- Scripted cooperation, 342
- Scripts
  - constructivism and, 155
  - defined, 244
  - knowledge and, 244–245
- Secondary control, 441
- Secondary ignorance, 365n
- Secondary reinforcers, 53–54, 98
- Second language learning, 25
- Second-order conditioning, 40, 43
- Selection, long-term memory storage, 190–191
- Selective attention, 182
- Self-actualization needs, 433, 434
- Self-concept, 127
- Self-conscious emotions, 447, 478–479
- Self-constructed knowledge, 196
- Self-control, 133, 133n
- Self-determination
  - attributions and, 477
  - feedback and, 457–458
  - intrinsic motivation and, 437–440, 456–457
  - needs and, 437–441
  - relatedness needs and, 442
  - self-regulation and, 488
- Self-efficacy
  - attributions and, 479
  - behavior affected by, 128–129
  - career goals and, 474
  - conceptual change and, 253
  - cooperative learning and, 341
  - factors in development of, 129–131
  - feedback and, 208
  - interest and, 464
  - mastery goals and, 471
  - modeling and, 127, 130–131
  - motivation and, 460, 464
  - peer tutoring and, 346
  - promoting, 139
  - psychological punishment and, 62
  - resilient self-efficacy, 130, 436n, 487
  - self-regulation and, 136, 441n
  - self-worth distinguished from, 436–437
  - social cognitive theory and, 112, 117, 127–131, 436, 441n
  - superstitious behavior and, 63n
- Self-efficacy for learning, 129, 382
- Self-efficacy for performance, 129
- Self-esteem
  - approval needs and, 443
  - defined, 128
  - need for, 432–433
  - punishment criticized for reducing, 80
- Self-evaluation, 132, 357, 386–387
- Self-explanation, 207, 410
- Self-fulfilling prophecy, 481, 495
- Self-handicapping, 435–436, 443, 444, 480, 497
- Self-imposed stimulus control, 136
- Self-instructions, 134, 227
- Self-management, 133
- Self-monitoring
  - retrieval and, 274
  - self-regulated learning and, 357, 386–387
  - self-regulation and, 134–135
- Self-motivation, 356
- Self-observation, 132
- Self-perceptions, 436
- Self-protective bias, 484
- Self-questioning, 365–366, 386
- Self-reaction, 132–133
- Self-reference effect, 193
- Self-reflection, 133, 357
- Self-regulated comprehension, 364n
- Self-regulated learning
  - attributions and, 480, 489
  - components of, 356–357
  - motivation and, 356, 426
  - roots of, 357–358
  - self-monitoring and, 357, 386–387
  - social cognitive theory and, 136
  - socially regulated learning, 357–358
  - study strategies and, 386
- Self-regulation
  - affect and, 488–489
  - cognitive aspects of, 136
  - discovery learning and, 415
  - elements of, 132–133
  - intentional learning and, 380
  - internalized motivation and, 490–491
  - mastery orientation and, 487
  - motivation and, 488–489
  - peer tutoring and, 346
  - personal agency and, 131–132, 441n
  - problem solving and, 417
  - promoting, 133–136, 139
  - social cognitive theory and, 112, 131–136
  - Vygotsky's cognitive development theory and, 316
- Self-reinforcement, 135
- Self-talk, 316, 319, 489
- Self-worth
  - approval needs and, 443, 459
  - attributions and, 484
  - conceptual change and, 435n
  - need for, 434–437
  - self-conscious emotions and, 447
- Semantic elaboration, 371n
- Semantic memory, 222, 260
- Sensation, and long-term memory storage, 185
- Sensation seekers, 431, 432
- Sense of community, 346
- Sensorimotor stage, 293–295, 300
- Sensory buffer, 161n
- Sensory deprivation, 432
- Sensory neurons
  - function of, 14–15
  - reflexes and, 16–17
- Sensory preconditioning, 41
- Sensory register
  - capacity of, 161, 168
  - characteristics of, 161–162
  - working memory and, 168
- Separation and control of variables, 299, 301, 309
- Sequential presentation, in concept learning, 242
- Serial learning
  - defined, 148
  - forgetting and, 276
  - meaning in, 150
  - organization and, 151
  - patterns in, 148–149
  - research and, 152
- Serial learning curve, 148, 149, 175
- Serotonin, puberty, 24
- Service learning, 333
- Setting events, 74
- Shadowing, 165–166
- Shaping
  - instrumental conditioning and, 63–64, 64n, 85
  - mastery learning and, 106
  - modeling as alternative to, 137–138
  - programmed instruction and, 105, 106
  - self-regulation and, 136
- Short-term memory. *See* Working memory
- Signal learning, 36, 38
- Signals, as instructional strategies, 213, 363
- Signs, Vygotsky's cognitive development theory, 316n
- Similar behaviors, 120

- Similarity  
 constructivism and, 155  
 law of, 146  
 transfer and, 397
- Simplifying, and encoding, 159
- Simultaneous presentation, in concept learning, 242, 243
- Single-photo emission computerized tomography (SPECT), 17
- Situated cognition, 156, 331
- Situated learning  
 contextual theories and, 156, 330, 331  
 problem solving and, 419  
 transfer and, 395–396
- Situated motivation, 427, 455
- Situational cues, 481
- Situational interest, 463–464
- Size, and attention, 163
- Skinner, B. F.  
 behaviorism and, 50, 51  
 on classroom management, 79  
 determinism and, 34  
 instrumental conditioning and, 48  
 operant conditioning and, 50–53, 57, 73  
 programmed instruction, 104–105, 105n  
 respondent conditioning, 35n  
 shaping and, 63–64  
 stimulus discrimination and, 75n  
 superstitious behavior and, 63
- Skinner box, 50, 52, 56, 63, 430
- Sleep, and consolidation, 199
- Small-group discussions, 337
- Social cognitive theory  
 affect and, 448  
 cognitive factors in social learning, 116–118  
 defined, 6, 111  
 educational implications of, 137–140  
 environmental factors and, 113–115, 118–119, 140  
 general principles of, 112–113  
 models and modeling, 6, 112, 114, 116, 119–127, 137–138  
 purposive behaviorism compared to, 143  
 reciprocal causation, 118–119  
 self-efficacy and, 112, 117, 127–131, 436, 441n  
 self-regulation and, 112, 131–136
- Social construction of meaning, 321–323
- Social construction of memory, 328–329
- Social constructivism, 155, 322, 330–331
- Social cues, attention and, 164
- Social goals, 442, 473–474
- Social interaction. *See also* Peer relationships  
 peer-interactive instructional strategies and, 335  
 personalized system of instruction and, 108  
 Piaget's cognitive development theory and, 291–292  
 Vygotsky and Piaget compared, 319  
 Vygotsky and Piaget contrasted, 320  
 Vygotsky's cognitive development theory and, 316
- Social learning theory. *See also* Social cognitive theory  
 behaviorist analysis of, 115  
 defined, 6, 111, 111n  
 development of, 6  
 Socially regulated learning, 357–358
- Social referencing, 164, 328
- Social reinforcers, 54, 55, 79, 80, 83, 97
- Social support, and motivation, 499
- Social thought, central conceptual structures, 304–305
- Sociocognitive conflict, 309, 320, 322, 335
- Sociocultural theory  
 contextual theories and, 156, 289, 313, 330–331  
 defined, 7  
 general implications of, 332–334  
 information processing theory integrated with, 327–330  
 transfer and, 399
- Somas  
 defined, 15  
 neurotransmitters and, 16
- S–O–R theorists, 33
- Source monitoring, 274
- Spacing effect, 208
- Spatial encoding, 225n
- Spatial relationships, central conceptual structures, 304
- Special educational needs, 346, 487
- Specific transfer, 392, 396
- SPECT (single-photo emission computerized tomography), 17
- Speed-reading programs, 190n
- Spontaneous recovery, classical conditioning, 39, 43, 87
- S–R psychology  
 behaviorism as, 33, 254, 289  
 discontent with, 141
- Stability, and attributions, 476–477, 478, 479, 482
- Stages of cognitive development  
 concrete operations stage, 297–298, 300–301  
 formal operations stage, 298–299, 301–302  
 instructional strategies and, 310–311  
 neo-Piagetian theories of cognitive development and, 303–304, 307  
 preoperational stage, 295–297, 300  
 sensorimotor stage, 293–295, 300  
 summary of, 294  
 views on, 302
- Standards  
 ethical standards, 9n, 37  
 instructional objectives and, 101, 103–104  
 self-regulation and, 132
- State anxiety, 450
- Stereotypes  
 expectations and, 206, 495  
 of gender differences, 206, 474  
 inferences and, 262
- Stereotype threat, 454–455, 479
- Stimulation seeking, 432, 445
- Stimuli (S)  
 antecedent stimuli, 73–75, 93, 94  
 behaviorism and, 32–33  
 classical conditioning and, 35–44, 52–53  
 operant conditioning and, 50–53  
 problem solving and, 400–401  
 punishment and, 57–62  
 reinforcement and, 50–57  
 transfer and, 394–395
- Stimulus control, 73, 136
- Stimulus discrimination  
 classical conditioning and, 39–40, 74  
 instrumental conditioning and, 74–75, 75n
- Stimulus generalization, 74n
- Stimulus–response associations  
 concept learning and, 238–239  
 paired-associate learning and, 148  
 serial learning and, 148
- Storage. *See also* Long-term memory storage  
 classroom assessments and, 285–286  
 defined, 159  
 external storage, 360, 362, 402  
 of frequency information, 177  
 sensory register and, 161  
 working memory and, 169–170
- Structuralism, 6
- Structure, Gestalt psychology, 145
- Study strategies. *See also* Learning strategies  
 comprehension monitoring, 364–366  
 defined, 358  
 elaboration, 358–359  
 identifying important information, 363–364  
 meaningful learning, 358–359  
 mnemonics, 366–373  
 note taking, 360, 362–363  
 organization, 359–360  
 personalized system of instruction and, 108  
 promoting effective strategies, 382–387  
 summarizing, 364  
 transfer and, 396
- Success  
 attributions and, 479, 480, 481–483  
 cooperative learning and, 342, 344



- expectancies and values, 465  
 intrinsic motivation and, 455–456  
 motive for, 444  
 self-efficacy and, 129–130, 131, 437  
 self-worth and, 435
- Successive approximations, 63, 94, 137
- Success of others, self-efficacy and,  
 130–131
- Summaries, end-of-lesson summaries,  
 217–218
- Summarizing, study strategies, 364
- Superimposed meaningful structure,  
 mnemonics, 269, 371–373
- Superstitious behavior, 63, 63n, 87
- Suppression effect, of punishments, 82
- Surveillance, 439–440
- Symbolic models, 120–121, 138
- Symbolic thought, 295
- Symbols, and encoding, 227
- Synapses  
 defined, 14  
 experience-dependent plasticity  
 and, 26  
 interconnectedness of brain structures,  
 21, 28  
 long-term memory and, 174n  
 neurotransmitters and, 16
- Synaptic pruning  
 brain development, 23  
 experience-expectant plasticity, 26  
 inevitability of, 29
- Synaptogenesis  
 adaptation and, 29  
 brain development, 22, 24  
 experience-expectant plasticity, 26
- Systematic desensitization, 44, 72
- Tangible reinforcers, 54
- Target behaviors, 92–94, 95, 135
- Targets, and instructional objectives, 101
- TARGETS mnemonic, motivational  
 strategies, 498, 499
- Task analysis, 107
- Task goals, 468n
- Task involvement, 468n
- Task orientation, 468n
- Taxonomies  
 Bloom's Taxonomy of Educational  
 Objectives, 103, 104, 283, 284  
 instructional objectives and, 103  
 retrieval and, 283–284
- Teacher-centered instruction, 211
- Teacher-directed instruction, 211, 217
- Teacher questions  
 attention and, 182  
 misconceptions and, 254, 257–258,  
 283  
 motivation and, 459  
 retrieval and, 283, 284–285  
 wait time, 285
- Teachers. *See also* Instructional strategies
- approval needs of students and, 443  
 epistemic beliefs of, 379  
 expectations of, 84–85, 109, 131, 285,  
 457, 458, 459, 494–496  
 learning strategies and, 381, 382  
 as models, 123, 138, 384, 459  
 students' dispositions and, 446  
 students' needs and, 458–459  
 students' note taking and, 362–363
- Teaching machine, 104
- Teaching skills, acquisition of, 326
- Technology-based collaborative learning,  
 peer-interactive instructional strategies,  
 348–350
- Temporal lobes  
 brain development, 23  
 parts of, 19
- Terminal behaviors  
 applied behavior analysis and, 95  
 instructional objectives and, 99, 101  
 mastery learning and, 106  
 programmed instruction and, 106  
 reinforcement and, 82–83, 84, 86
- Terminal buttons, defined, 15
- Test anxiety  
 causes of, 454–455  
 classical conditioning and, 40, 41,  
 44, 46  
 motivation and, 460  
 performance goals and, 470  
 threshold method and, 46
- Thalamus, 20
- Theories of learning. *See also specific  
 theories*  
 advantages of, 7–9  
 defined, 5  
 evolution of, 5, 6–7, 8, 11, 30  
 integration of, 10, 327–330  
 potential drawbacks, 9
- Theory of mind, 373
- Theory theory, 246–247, 281, 373
- Thorndike, Edward  
 behaviorism and, 32  
 instrumental conditioning and, 48,  
 49, 58  
 problem solving and, 400, 401  
 transfer theory and, 386, 393–394
- Threats, 438, 452
- Threshold method, stimulus–response  
 habit, 46
- Threshold of excitation, defined, 15
- Time lines, 360, 361
- Time on task, 427
- Time-out, 60, 61
- Time schedule, and motivation, 499
- Token economies, 98, 109
- Tolman, Edward Chace  
 cognitive learning theories and, 141,  
 142, 152  
 purposive behaviorism, 142–144, 155
- Trait anxiety, 450, 453–455
- Trait theories, 442
- Transfer  
 critical thinking and, 423  
 defined, 389  
 factors affecting, 397–399  
 instructional strategies and, 414–420  
 theories of, 386, 392–396  
 types of, 390–392
- Transituational generality, 51
- Transposition, Köhler's experiments  
 in, 145
- Treatment plan, applied behavioral  
 analysis, 94–95
- Trial-and-error behavior  
 behaviorism and, 112  
 instrumental conditioning and, 49  
 in play, 415  
 problem solving and, 49, 147,  
 400–401, 408
- Trophic factors, 23, 29
- Truth, and epistemic beliefs,  
 378–379, 423
- Unacceptable behaviors, 90–91, 92
- Unconditioned response (UCR), classical  
 conditioning, 35, 36, 40
- Unconditioned stimulus (UCS), classical  
 conditioning, 35–42, 53, 65
- Undergeneralization, 237, 242
- Universal Grammar, 27
- Values  
 career goals and, 474  
 motivation and, 464–466, 489–493
- Variable interval (VI) schedules, 69–70
- Variable ratio (VR) schedules, 67–68, 95
- Variety, as attention-holding strategy,  
 181–182
- Verbal codes, 227
- Verbal instructions, 121
- Verbalization, and long-term memory  
 storage, 207, 329
- Verbal learning  
 cognitive processes and, 141, 148–152,  
 157, 260  
 factors affecting ease of learning,  
 150–151  
 forgetting and, 150, 276  
 information processing theory  
 and, 289
- Verbal mediation, 367
- Verbal reasoning, 422
- Verbal reprimands, 59
- Verbatim information, learning of, 152
- Vertical transfer, 391
- Vicarious acquisition, 116
- Vicarious punishment, 114–115, 120
- Vicarious reinforcement, 114–115, 120
- Visual aids, long-term memory storage,  
 215–217
- Visual cortex, 22

- Visual imagery
  - encoding and, 224–225, 225n
  - long-term memory storage and, 196–198, 215–217
  - mnemonics, 197, 367–371
  - problem solving and, 411
  - verbal learning theory and, 150, 152, 157
- Visual perception, critical periods in development of, 25
- Visual-spatial encoding, 169–170, 225
- Visuospatial imagery, 225
- Visuospatial sketchpad, 170, 411
- VI (variable interval) schedules, 69–70
- VR (variable ratio) schedules, 67–68, 95
- Vygotsky, Lev
  - challenging activities and, 45
  - cognitive development theory of, 156, 211, 289, 313–318, 319, 320, 346, 357, 358, 464, 498
  - current perspectives on theory of, 321–327
  - developmental psychology and, 141
  - key ideas of, 314–318
  - Piaget compared to, 314, 315, 318–321
- Wait time, 285, 349
- Ways of knowing, 375n
- Well-defined problems, 400
- Wernicke's area, 20
- White matter, 16
- Whole more than sum of parts, Gestalt psychology, 144–145
- Word length effect, 172
- Work-avoidance goals, 473, 474
- Working backward, as problem-solving strategy, 411
- Working memory
  - attention and, 163–167, 168, 183, 453
  - capacity of, 168–169, 182, 183, 185, 190, 198, 303, 374, 383, 395, 402, 413, 416, 418, 420
  - characteristics of, 168–171
  - cognitive processes and, 167–168
  - as conscious mechanism, 176
  - control processes in, 171–173
  - long-term memory compared to, 175–176
  - long-term memory storage and, 200
  - moving information to, 161, 163–167
  - selection and, 190
- Worldviews
  - attributions and, 483
  - conceptual change and, 252, 253
  - knowledge and, 250–252
- Worry, component of anxiety, 450, 453
- Writing, and automaticity, 210
- Yerkes-Dodson law, 451
- Zone of proximal development (ZPD), 317, 319, 323