

Research on Family-School Partnerships

Series Editors: Susan M. Sheridan · Elizabeth Moorman Kim

Susan M. Sheridan

Elizabeth Moorman Kim

Editors

Family-School Partnerships in Context

 Springer

Research on Family-School Partnerships

Volume 3

Series Editors

Susan M. Sheridan

Nebraska Center for Research on Children, Youth, Families and Schools

University of Nebraska-Lincoln

Lincoln, Nebraska, USA

Elizabeth Moorman Kim

Nebraska Center for Research on Children, Youth, Families and Schools

University of Nebraska-Lincoln

Lincoln, Nebraska, USA

More information about this series at <http://www.springer.com/series/11737>

Susan M. Sheridan • Elizabeth Moorman Kim
Editors

Family-School Partnerships in Context

 Springer

Editors

Susan M. Sheridan
Nebraska Center for Research on Children,
Youth, Families and Schools
University of Nebraska-Lincoln
Lincoln, NE, USA

Elizabeth Moorman Kim
Nebraska Center for Research on Children,
Youth, Families and Schools
University of Nebraska-Lincoln
Lincoln, NE, USA

Research on Family-School Partnerships

ISBN 978-3-319-19227-7

ISBN 978-3-319-19228-4 (eBook)

DOI 10.1007/978-3-319-19228-4

Library of Congress Control Number: 2015945572

Springer Cham Heidelberg New York Dordrecht London

© Springer International Publishing Switzerland 2016

This work is subject to copyright. All rights are reserved by the Publisher, whether the whole or part of the material is concerned, specifically the rights of translation, reprinting, reuse of illustrations, recitation, broadcasting, reproduction on microfilms or in any other physical way, and transmission or information storage and retrieval, electronic adaptation, computer software, or by similar or dissimilar methodology now known or hereafter developed.

The use of general descriptive names, registered names, trademarks, service marks, etc. in this publication does not imply, even in the absence of a specific statement, that such names are exempt from the relevant protective laws and regulations and therefore free for general use.

The publisher, the authors and the editors are safe to assume that the advice and information in this book are believed to be true and accurate at the date of publication. Neither the publisher nor the authors or the editors give a warranty, express or implied, with respect to the material contained herein or for any errors or omissions that may have been made.

Printed on acid-free paper

Springer International Publishing AG Switzerland is part of Springer Science+Business Media
(www.springer.com)

*To the families, schools, and communities
who work as partners to ensure supportive,
nurturing environments for children.
It is through these enriching contexts that
children embark on positive developmental
life trajectories, thereby creating a better
future for us all.*

Acknowledgments

The motivation for the writing of this series grew out of a meeting of the Interdisciplinary Alliance for Partnerships Research in 2010. We acknowledge the countless contributions these eminent scholars made to the conceptualization, development, and realization of these volumes. We thank the sponsors of this meeting, the National Science Foundation (#0921266) and the American Educational Research Association. The opinions expressed herein belong to the grantees and do not reflect those of the funding agencies. The editors are indebted to Marj McKinty for her help through all stages of the preparation of these volumes.

Contents

1 Complexities in Field-Based Partnership Research: Exemplars, Challenges, and an Agenda for the Field	1
Susan M. Sheridan, Shannon R. Holmes, Tyler E. Smith, and Amanda L. Moen	
2 Going to Scale with Family-Centered, School-Based Interventions: Challenges and Future Directions	25
Elizabeth A. Stormshak, Kimbree L. Brown, Kevin J. Moore, Thomas Dishion, John Seeley, and Keith Smolkowski	
3 Moving Beyond Monitoring: A District Leadership Approach to School, Family, and Community Partnerships	45
Steven B. Sheldon	
4 Research Issues to Forward a Policy Agenda in Support of Family–School Partnerships	65
Lisa L. Knoche	
5 Testing Statistical Moderation in Research on Home–School Partnerships: Establishing the Boundary Conditions	79
Oi-Man Kwok, MyungHee Im, Jan N. Hughes, Sarah E. Wehrly, and Stephen G. West	
6 Contexts of Family–School Partnerships: A Synthesis	109
Eva N. Patrikakou	
Index	121

Contributors

Kimbree L. Brown University of Oregon, Eugene, OR, USA

Thomas Dishion Arizona State University, Tempe, AZ, USA

Shannon R. Holmes Nebraska Center for Research on Children, Youth, Families and Schools, University of Nebraska-Lincoln, Lincoln, NE, USA

Jan N. Hughes Department of Educational Psychology, Texas A&M University, College Station, TX, USA

MyungHee Im Department of Educational Psychology, Texas A&M University, College Station, TX, USA

Lisa L. Knoche Nebraska Center for Research on Children, Youth, Families and Schools, University of Nebraska-Lincoln, Lincoln, NE, USA

Oi-Man Kwok Department of Educational Psychology, Texas A&M University, College Station, TX, USA

Amanda L. Moen Nebraska Center for Research on Children, Youth, Families and Schools, University of Nebraska-Lincoln, Lincoln, NE, USA

Kevin J. Moore Prevention Science Institute, Eugene, OR, USA

Eva N. Patrikakou DePaul University, Chicago, IL, USA

John Seeley Oregon Research Institute, Eugene, OR, USA

Steven B. Sheldon Johns Hopkins University School of Education, Baltimore, MD, USA

Susan M. Sheridan Nebraska Center for Research on Children, Youth, Families and Schools, University of Nebraska-Lincoln, Lincoln, NE, USA

Tyler E. Smith Nebraska Center for Research on Children, Youth, Families and Schools, University of Nebraska-Lincoln, Lincoln, NE, USA

Keith Smolkowski Oregon Research Institute, Eugene, OR, USA

Elizabeth R. Stormshak University of Oregon, Eugene, OR, USA

Sarah E. Wehrly Department of Educational Psychology, Texas A&M University,
College Station, TX, USA

Stephen G. West Arizona State University, Tempe, AZ, USA

About the Editors

Susan M. Sheridan, Ph.D., is a George Holmes University Professor of Educational Psychology and Director of the Nebraska Center for Research on Children, Youth, Families, and Schools at the University of Nebraska-Lincoln, well known for her research on family–school partnerships and family engagement. She has managed numerous significant federal grants investigating the efficacy of a consultation-based partnership model, which have resulted in several publications and professional presentations. She has received several professional awards and has served in many leadership positions in the fields of school and educational psychology.

Elizabeth Moorman Kim, Ph.D., received her doctorate in Developmental Psychology from the University of Illinois at Urbana-Champaign. She is currently co-principal investigator of a federally funded research project examining the effects of interventions targeting parental involvement in children’s learning and family–school partnerships housed at the Nebraska Center for Research on Children, Youth, Families, and Schools at the University of Nebraska-Lincoln. Her research interests include family–school partnerships, parenting, and children’s motivation and achievement in school.

Chapter 1

Complexities in Field-Based Partnership Research: Exemplars, Challenges, and an Agenda for the Field

Susan M. Sheridan, Shannon R. Holmes, Tyler E. Smith,
and Amanda L. Moen

The benefits of engaging families in children's education are among the most convincing and consistent findings in the educational literature. There is overwhelming research support attesting to the effects of parent involvement and family-school partnership practices to positively advance children's educational trajectories. Trends in the research suggest that family-based educational interventions appear to be most successful when they (a) involve collaborative partnering between families and schools; (b) promote healthy relationships between families and schools, and parents and children; and (c) use evidence-based parent and teacher practices. Two family-school partnership interventions, Getting Ready (Sheridan, Marvin, Knoche, & Edwards, 2008) and Conjoint Behavioral Consultation (CBC; Sheridan & Kratochwill, 2008) exemplify these current trends. In this chapter, we describe our experiences conducting partnership research as we have developed and tested these models over the last 25 years. We first define our approach to partnership intervention research by distinguishing between parental involvement practices and family-school partnerships. We discuss a sample of our research activities associated with Getting Ready and CBC, present a number of challenges we have encountered in the conduct of our partnership research, and propose a research agenda to advance the empirical work on family-school partnerships.

S.M. Sheridan (✉) • S.R. Holmes • T.E. Smith • A.L. Moen
Nebraska Center for Research on Children, Youth, Families and Schools,
University of Nebraska-Lincoln, Lincoln, NE, USA
e-mail: ssheridan2@unl.edu

Definitions

Both parental involvement and family–school partnership programs are predicated on the belief that learning and development are maximized when parents have a meaningful role in children’s education. Despite being distinct approaches, the obvious overlap in the constructs often results in the terms being used interchangeably and synonymously. Distinguishing between parental involvement and family–school partnerships is necessary to describe the approach we embrace in our partnership intervention research.

Parental Involvement

Parental involvement is defined as the dedication of resources, such as time and money, by the parent toward the child’s education (Grolnick & Slowiaczek, 1994). It is generally understood that the term is broad and multidimensional, with several authors offering characterizations that emphasize different aspects of the construct. An early framework (Grolnick & Slowiaczek, 1994) described parental involvement as consisting of behavioral (i.e., parents’ outward demonstration and visible support of school), personal (i.e., affectively conveying the value of school), and cognitive/intellectual (i.e., through the provision of cognitively stimulating materials in the home) components. To account for various settings or sources of support for children’s learning and development, Fantuzzo, Tighe, and Childs (2000) proposed a model of parental involvement that includes school-based involvement (i.e., parental participation in activities in the school setting), home-based involvement (i.e., establishing a supportive learning environment at home), and home–school conferencing (i.e., involving interpersonal interactions and transactions between parents, teachers, and school personnel supporting continuity across settings). Finally, focusing on various activities in which parents can partake, Sheldon and Epstein (2005) defined six categorical practices encompassing parent involvement: parenting, communicating, volunteering, learning at home, decision making, and collaborating with the community.

Family–School Partnerships

Whereas parental involvement models and activities tend to highlight the efforts displayed by parents in ways that support what schools do to promote learning, family–school partnership models are defined as child-focused approaches wherein families and various professionals cooperate, coordinate, and collaborate to increase opportunities and accomplishments related to children’s and adolescents’ social, emotional, behavioral, and academic development (Albright & Weissberg, 2010;

Downer & Myers, 2010; Lines, Miller, & Arthur-Stanley, 2011). Parent involvement models often involve what each system (home and school) does in isolation; family–school partnership models emphasize the bidirectional relationship between families and schools, and intend to enrich student outcomes through cross-system supports and continuities across both home and school settings.

Family–school partnerships are grounded in an ecological-systems theory (Bronfenbrenner, 1979, 1992) positing that children learn and grow within distinct and overlapping systems, and that learning and development are dependent upon reciprocal interactions between that which occurs between the child/family and school/schooling systems (Rimm-Kaufman & Pianta, 2000). Thus, the quality of the intersection between home and school becomes important. Many studies have investigated children’s experiences within the home and school systems in an isolated, unidimensional (school or home) fashion, or have explored unidirectional (school to home) models. We believe that connections and experiences *across* home and school systems provide the groundwork within which children’s developmental trajectories are strengthened (Kim et al., 2012).

Meta-analytic findings have consistently revealed positive associations between parent–school connections and children’s academic success (cf. Fan & Chen, 2001). The positive outcomes of parental involvement are evident across diverse samples, various academic skills and subjects, and differing intervention approaches. For example, the impact of parental involvement on academic achievement has been demonstrated for minority students in urban areas (Jeynes, 2003, 2005), as well as for boys and girls (Jeynes, 2005). Documented positive effects of parent involvement on children’s homework are evident, including an increase in the time students spend on homework and assignment completion (Epstein & Sanders, 2002). Long-term educational achievement has also been influenced by proximal achievement-related outcomes, including homework completion rate and the frequency of homework problems (Patall, Cooper, & Robinson, 2008). Parental promotion of reading and writing has been found to be significantly related to the development of children’s vocabulary, listening comprehension and early literacy skills (Senechal & LeFevre, 2002), and parental involvement in mathematics education improved mathematic achievement scores among students in elementary and secondary schools (Sheldon & Epstein, 2005).

Collaborative approaches characteristic of family–school partnership programs have also demonstrated positive outcomes for children. For example, Barry and Santarelli (2000) found that tantrums across both home and school settings decreased with the use of conjoint strategies. A parent–teacher collaborative team model yielded increased social interaction with peers, student-initiated interactions, student engagement in classroom activities, and academic skills for three students with disabilities (Mortier, Hunt, Desimpel, & Van Hove, 2009). A responsive model that shapes family–school partnerships based on individual decisions (Adolescent Transition Program and Family Check-Up; Connell, Dishion, Yasui, & Kavanagh, 2007) was shown to effect and maintain decreased problem behaviors among adolescents at risk for delinquent behaviors over time in comparison to a randomized matched control group.

Exemplars of Family–School Partnership Interventions

The early years of a child’s life are critical for establishing a healthy developmental trajectory. Early and meaningful experiences within the home, including positive interactions between parents and children, are predictive of important cognitive (e.g., language), social–emotional (e.g., relationship skills), and behavioral (e.g., compliance) outcomes. Furthermore, quality relationships between parents and caregivers are associated with children’s learning and social competence during this pivotal developmental period (Elicker, Wen, Kwon, & Sprague, 2013). Establishing family–school partnerships during early childhood positions parents to develop beneficial and constructive relationships with both their children and their children’s care providers. That is, fostering family–school partnerships during early childhood encourages positive child outcomes and sets the stage for families to feel valued in ways that recognize and support their role in their child’s development and learning.

Much like in early childhood, during elementary school family–school partnerships play a critical role in children’s development and academic success. During these years, partnerships are focused on fostering a positive relationship between family members and educators. Family–school partnerships appear to be most effective when they involve collaborative problem-solving around shared goals, and incorporate evidence-based behavioral interventions (e.g., using positive reinforcement techniques, maximizing structure, and providing clear expectations for children; Guli, 2005). Two family–school partnership models (Getting Ready, CBC) exemplify these ingredients and are being developed and tested within our own research lab. These models, encompassing development from early childhood to elementary age, will be discussed in detail.

The Getting Ready Intervention

The Getting Ready intervention is a partnership-oriented approach to building children’s school readiness (Sheridan et al., 2008). In Getting Ready, early childhood professionals (ECPs) partner with parents using a strengths-based framework to support positive parent–child interactions and foster constructive parent–professional relationships. In particular, the objectives that ECPs promote are (a) parental warmth, sensitivity, and responsiveness; (b) support for the child’s autonomy, and (c) parents’ participation in children’s learning.

Table 1.1 contains the specific strategies used in the Getting Ready intervention. Focused on enhancing school readiness skills for children at developmental or demographic risk, parents learn to observe, interpret, and attend to their child’s strengths and needs through collaboration with their child’s educational caregiver. Parents’ competencies are identified and affirmed as they engage with ECPs as partners. Open questions and communication between parents and ECPs creates

Table 1.1 Getting Ready strategies

Strategy	Definition
Establish parent–child/ parent–professional relationship	Elements of the environment are intentionally and actively arranged to increase the probability of developmentally matched, mutually enjoyable parent–child interaction. Meaningful interaction and conversation are exchanged between the early childhood professional (ECP) and parent conveying support or interest in family activities
Focus parent’s attention on child strengths	Verbal statements are used to comment upon, expand, or question the interaction to draw parents’ attention to particular competencies or actions within the child
Invite and discuss observations about child	The ECP invites the parents’ input regarding the child’s development, likes/dislikes, and supportive strategies
Affirm parent’s competence	Statements are made to recognize and reinforce parent-initiated positive interactions with the child, as well as evidence of child competence as an outcome of effective parenting practices
Provide developmental information	Information about the child’s development and developmental milestones are provided by ECP through verbal labeling or interpreting the child’s emotional, cognitive, language, and/or motor abilities within the context of play and interaction
Identify mutual goals/ expectations	Concerns for the child as seen by the ECP and parent are discussed, and the parent and ECP collaboratively select concerns to focus on and establish goals vis-à-vis those concerns
Brainstorm and make suggestions	This involves both a collaborative and directive process between the ECP and parent, wherein the parent and ECP brainstorm and select strategies that fit into their respective home and classroom settings and daily routines. The ECP makes explicit statements to the parent about behaviors to support the child’s development and/or the parent–child interaction as needed
Model effective strategies	The ECP demonstrates developmentally appropriate strategies for interacting with the child; parent responds by modeling the behavior
Establish home-school plan with goals and practices	Specific goals are stated or reiterated, with a discussion of specific plans that will be used at home and in the classroom to support the child’s development and progress toward those goals

Note: From “Efficacy of the Getting Ready Intervention and the Role of the Parental Depression,” by S. M. Sheridan, L. L. Knoche, C. P. Edwards, K. A. Kupzyk, B. L. Clarke and E. M. Kim (2014) *Early Education and Development*, 25, 746–769. Copyright [2014], Taylor & Francis. Reprinted with permission

opportunities to exchange information while also allowing both parties to report their observations and establish goals for the child. Sharing information across systems facilitates a joint problem-solving and decision-making process that includes brainstorming and suggesting effective and feasible practices for parents and ECPs to use at home and school to assist the child meet developmental expectations and goals. When necessary, ECPs model plans to ensure consistency across settings.

Research Support for Getting Ready

We evaluated the efficacy of the Getting Ready intervention for promoting school readiness among disadvantaged children aged birth to 5 and their families in a longitudinal randomized clinical trial. Participants were involved in the Getting Ready (experimental) or business as usual (comparison) condition based on their ECP's random assignment. The intervention was delivered via teacher use of Getting Ready strategies during 60-min home visits including the parent, ECP, and the child. Teachers who were participating in the intervention were trained in the use of the strategies and received support regarding skill use during bimonthly individual and small group coaching sessions. They were encouraged to use the collaborative and triadic strategies in all of their interactions with parents (e.g., parent-teacher conferences, drop-off and pick up times, and other structured and unstructured communications).

In our first published study, we examined outcomes of Getting Ready on children's social-emotional skills among a sample of 220 Head Start children aged 36-53 months. Fifty one percent of the sample was boys. Approximately 33 % of students were reported by parents to be White/non-Hispanic, 25 % Hispanic/Latino, 18 % Black, 3 % Indian, and 22 % "other" (Sheridan, Knoche, Edwards, Bovaird, & Kupzyk, 2010). We found that Head Start children who participated in Getting Ready exhibited more initiative, demonstrated greater improvements in their attachment, and experienced larger gains in social competence relative to the control group (Sheridan et al., 2010). Further, compared to teacher reports of children in the comparison group, teachers of children in the Getting Ready condition reported significantly greater decreases in children's levels of anxiety/withdrawal. A related study found significantly greater decreases in direct observations of overactivity in parent-child interactions for Head Start children in the Getting Ready condition compared to those in the control group (Sheridan et al., 2014). Interestingly, parental depression moderated the effects of the intervention, such that the greatest increases in positive affect and verbalizations were documented for children in the Getting Ready condition whose parents were depressed at some point during the implementation of the intervention relative to children whose parents were not depressed (Sheridan et al., 2014).

Significant improvements in language and early literacy skills were also found for children participating in the Getting Ready intervention (Sheridan, Knoche, Kupzyk, Edwards, & Marvin, 2011). Teacher reports of language use, reading and writing improved for all children in the study; however, larger gains were reported over time for children in the treatment group compared to those in the control group. Language use, as reported by teachers, increased at a higher rate for experimental group children who had been identified as having developmental concerns, who did not speak English upon entry of preschool and who resided with two adults in the home. Additionally, on a direct measure of expressive language, the greatest rates of improvement were documented for children participating in Getting Ready who had been identified as having developmental concerns and whose parents had at least a high school diploma or GED.

The effectiveness of the Getting Ready intervention on parenting practices has also been demonstrated in a rural Early Head Start sample. Two hundred and thirty-four parents of children aged 2–24 months participated. The mean age of parents was 24.7 years ($SD=5.4$ years), with the majority reporting they were the child's mother. Seventy percent of parents reported speaking primarily English, with the remainder being Spanish speakers. Almost the entire sample (98.7 %) was receiving public assistance (Knoche et al., 2012).

Relative to parents in the control group, parents participating in the Getting Ready intervention demonstrated more warmth and sensitivity in their interactions with their child and greater support for their child's autonomy. In particular, parents in the treatment group used more appropriate directives and provided better guidance and support for learning when interacting with their child whereas parents in the control group demonstrated slight declines in each of the aforementioned behaviors (Knoche et al., 2012).

In addition to positive parent and child outcomes for those participating in Getting Ready, we found differences in Getting Ready and control group teachers' behavior during home visits (Knoche, Sheridan, Edwards, & Osborn, 2010). Head Start ECPs in the treatment group were more likely to affirm parent competencies, use brainstorming activities with parents and establish a positive parent–child interactional context within the home visit. Among ECPs participating in Getting Ready, a positive relationship between the use of Getting Ready strategies and rate of parent–professional interactions was found, as well as a positive relationship between strategy use and overall quality of implementation (Knoche et al., 2010).

In sum, the Getting Ready intervention encourages ECPs intentional use of strategies to promote family–school partnerships. Through the utilization of these strength-based strategies (including affirming parent competence, creating open communication, sharing information, modeling and providing suggestions), positive outcomes for parents, children, and early childhood professionals were seen. Participants in Getting Ready experienced more positive parent–child interactions and parent–professional interactions creating a setting where families are important and play vital roles in their child's development and learning.

Conjoint Behavioral Consultation

CBC (Sheridan & Kratochwill, 2008) is a targeted family–school partnership intervention concerned with ameliorating identified concerns for students for whom challenges, delays, or potential disabilities are implicated. It is defined as an indirect form of service delivery wherein parents, educators, and a school-based consultant address student needs using collaborative problem-solving procedures (Sheridan & Kratochwill, 2008; Sheridan, Kratochwill, & Bergan, 1996). Through four procedurally operationalized stages (needs identification, needs analysis, plan implementation, plan evaluation; see Table 1.2), CBC focuses on providing parents and teachers with a constructive and proactive method to support children's learning and

Table 1.2 Conjoint behavioral consultation stages

Strategy	Definition
Needs identification	Strengths of the child, family, and teacher are explored. Parents and teachers prioritize and behaviorally define concerns (e.g., decreasing inappropriate vocalizations, increasing compliance with group routines). Environmental conditions that may be contributing to problem behaviors (antecedent, consequent, and sequential conditions) are discussed. A procedure for the collection of baseline data across settings is established
Needs analysis	Baseline data collected across home and school settings is discussed. Setting events, ecological variables, and cross-setting conditions that may have influenced the target behavior are identified. Treatment plans that are sensitive to setting-specific variables are collaboratively developed for the home and school by the parents, teachers, and consultant
Plan implementation	Necessary training of implementation is provided to parents and teachers. Treatment plans are monitored across settings for purposes of treatment fidelity. It is determined if there is a need for any immediate revisions to the original plan. Data collection is continued across settings
Plan evaluation	The effectiveness of the plan across settings is discussed. It is determined if shared goals of the consultation have been attained. Strategies and tactics regarding continuation, modification, or termination of the treatment plan across settings are discussed. Any necessary additional interviews are scheduled

behavior. CBC promotes collaborative processes between families and schools by providing direct opportunities for both parents and teachers to participate in educational problem-solving (i.e., goal setting, intervention planning, and evaluation). Furthermore, CBC helps partners across settings (i.e., home, school) take an active role in (a) establishing and defining priorities (i.e., target behaviors) for interventions, (b) exploring conditions across both the home and school environments that influence problem behaviors, (c) learning about and implementing evidence-based strategies (i.e., positive reinforcement techniques, effective commands), and (d) evaluating interventions to determine if behavioral goals have been met (Sheridan & Kratochwill, 1992, 2008).

Empirical Support for CBC

Since its inception, empirical evidence has amassed supporting the efficacy of CBC. Using the *Procedural and Coding Manual of the Task Force on Evidence-Based Interventions in School Psychology* (Kratochwill & Stoiber, 2002), Guli (2005) determined that CBC was an effective evidence-based model to address children's needs across both home and school settings. Single-case research using experimental multiple baseline designs further supports the utility of CBC to address various behavioral (e.g., tantrums across home and school; Barry & Santarelli,

2000), social–emotional (e.g., enhancing play, social initiation; Colton & Sheridan, 1998; Sheridan, Kratochwill, & Elliott, 1990), academic (e.g., math completion; Weiner, Sheridan, & Jenson, 1998) and health (e.g., Type 1 Diabetes; Lasecki, Olympia, Clark, Jenson, & Heathfield, 2008) concerns. Positive outcomes have also been found for different mental health diagnoses (e.g., autism; Ray, Skinner, & Watson, 1999), in medical settings (Sheridan et al., 2009), for children and families of various ethnic groups and cultural backgrounds (Sheridan, Eagle, & Doll, 2006), and across developmental periods (Kratochwill, Elliott, Loitz, Sladeczek, & Carlson, 2003). In fact, in a 4-year synthesis of single-case designs using multiple linear regression we found that a model fitting client age and symptom severity predicted school outcomes relatively well (Sheridan, Eagle, Cowan, & Mickelson, 2001). The study highlighted the importance of addressing severe behavior problems before the middle school years, as younger students (ages 5–7) with higher behavioral severity ratings prior to CBC experienced better outcomes than those experiencing less severe concerns and compared to older children (11 years and older) at all severity levels.

Recently, our research team has been testing the efficacy of CBC using large-scale randomized controlled trials (RCTs) (Sheridan et al., 2012; Sheridan, Ryoo, Garbacz, Kunz, & Chumney, 2013). Participants in a recently completed RCT examining the effects of CBC for early elementary age students (Kindergarten through third grade) included 207 children and their parents and teachers. All students were nominated for CBC by their classroom teacher due to presenting concerns with disruptive behaviors. Approximately 74 % of children were males, with an average age of 7.00 (SD=1.08). An estimated 69 % of children were reported by parents as White/non-Hispanic, 8 % were reported African-American, and 5 % were Hispanic or Latino. Thirty-five percent of participants lived in households with a total income less than 150 % of the poverty threshold (based on 2008 poverty thresholds and household size) and 50 % of children met criteria for free and reduced lunch. Approximately one quarter of children (23 %) lived in a home with only one adult (Sheridan et al., 2013). Ninety percent of parent participants were women with an average age of 34.74 (SD=7.79) years (Sheridan et al., 2013). Twenty-one percent earned a high school diploma (or equivalent) or less (Sheridan et al., 2013).

CBC procedures for collaborative home–school problem-solving were followed as described in Sheridan and Kratochwill (2008). Trained consultants facilitated a series of meetings between teachers and parents. Over approximately eight weeks, a consultant met with 2–3 parents and a teacher for approximately 3–4 conjoint consultation sessions. During each meeting, many steps were taken to ensure that consultants maintained integrity when implementing the CBC process (i.e., objective checklists, independent data collectors, permanent products of treatment plans; Sheridan et al., 2013).

In the first published RCT of CBC, we evaluated the effects of CBC on behavioral outcomes and explored the potential role of parent–teacher relationships as a mediating variable (Sheridan et al., 2012). Specifically, in comparison to a “business-as-usual” control group, we found that children in the CBC group showed

significant improvements in parent and teacher reported social skills and teacher-reported adaptive behaviors. Furthermore, CBC participants reported more positive parent–teacher relationships relative to the control group, and the gains reported in the parent–teacher relationships partially mediated the effects of CBC on several child outcomes.

From the same RCT, we explored the effects of CBC in the home setting. Results revealed that CBC parents reported more communication between home and school and greater competence in problem-solving than control group parents. Furthermore, relative to the comparison group, children in the CBC group showed significant decreases in defiance, noncompliance, tantrums, and arguing at home. Degree of family risk was found to moderate parents' competence in problem-solving and children's total problem behaviors, teasing, and tantrums. Specifically, families with significant levels of disadvantage (i.e., low parental education, low income status, fewer than two adults in the household) were likely to see greater treatment gains than those who were less disadvantaged (Sheridan et al., 2013).

We are currently conducting an RCT evaluating the utility of CBC in Midwestern rural communities. One hundred and thirty-three teachers of students in grades kindergarten through third grade, and a total of 238 students and their parents have participated to date. Dependent variables in the current study include student behavior and academic functioning, parent/teacher beliefs and practices, and the parent–teacher relationship. Parent and teacher rating scales, direct observations of student behavior, and permanent products generated from parents, teachers, and consultants are also being collected. Mediation and moderation variables are also being explored to determine various mechanisms through which CBC exerts its influence within rural contexts.

In sum, CBC serves as a framework for supporting family–school partnerships during the early elementary school years. Across a number of single-case studies, CBC has been found to produce positive effects on behavioral, social, emotional, and academic outcomes for children. Furthermore, CBC has shown positive outcomes across multiple settings (e.g., medical settings) and across cultural and ethnic groups. On a much larger scale, randomized controlled trials are continuing to demonstrate a number of positive effects by utilizing various collaborative strategies between home and school and incorporating evidence-based practices that concentrate on children's social–emotional, behavioral, and academic needs.

Challenges Associated with Field-Based Partnership Intervention Research

Our experiences conducting experimental studies on the efficacy of partnership interventions, including Getting Ready and CBC, have uncovered several unique challenges associated with their execution, interpretation, and translation. Definitional confusions among researchers and within the field, the multidimensional nature of family–school partnership interventions, issues associated with

fidelity assessment, and the co-occurrence of research and practice demands within field settings create important considerations in the conduct of partnerships research.

Lack of Definitional Clarity

In research, the construct of family–school partnerships is often fraught with diffuse meanings, imprecise definitions, and poorly operationalized indicators. When definitions are offered, the match to other definitions in the partnership literature may vary greatly, with different researchers defining partnership in very different ways. In some studies, the term is used in a manner that overlaps with other related research (e.g., parent involvement, parent engagement, parent participation, home support for learning) such that different terms are used interchangeably and synonymously despite very distinct meanings (see Kim & Sheridan, 2014). In still other studies, several terms may be used to describe essentially identical practices. The definitional ambiguity present in the partnership literature diffuses research efforts to discern conclusive findings regarding efficacy, mechanisms of effects, and characteristics among samples or studies that influence outcomes.

From a practice perspective, our own research partners within agencies such as Head Start often invoke their own definition of “partnership” based on experience and exposure. Not surprisingly, it is often associated with actions they ask parents to perform (demonstrating their “involvement”) versus invitations for parents to contribute strengths and ideas as partners. These personal concepts and understandings drive practice, and may be important for us to assess when introducing methods of engaging with families that may differ in fundamental ways. Qualitative interviews with early childhood providers in our Getting Ready research uncovered difficulties experienced by practitioners as they redefined their approach. Personal revelations described their challenges moving from their original definition of parental engagement (oriented toward instructing parents in a one-directional, school to home manner), to a relational, two-way partnership definition (Brown, Knoche, Edwards, & Sheridan, 2009).

Multidimensional Nature of Family–School Partnership Research

It is rare that family–school partnership is a unidimensional activity, and a particular challenge with partnerships research relates to its multidimensional nature. Family–school partnerships often consist of a number of distinct dimensions or components that collectively comprise the intervention. In our own research, multiple types and points of interaction, structured communication practices, opportunities for collaborative decision making, parent and teacher practices in and outside of school, and

a range of other elements comprise what is collectively considered family–school partnership. That is, there are often many elements that together constitute partnerships in practice, and they are implemented in various combinations.

The complexity associated with the practice of family–school partnerships creates research challenges. It is probable that the various components or elements of partnership interventions, including our own, contribute uniquely to the overall effects seen in outcome research. There is generally no consensus on what contributes to specific outcomes observed in partnership intervention trials. That is, the “operative elements” or “active ingredients” of partnership interventions—those components that are responsible for producing desirable outcomes at the student, parent, and teacher levels—have not been empirically determined (Sheridan, Rispoli, & Holmes, 2014). There is a dearth of research on topics related to what really matters in terms of partnership intervention components. Until such information is available, it is likely that discussions of family–school partnerships will remain broad, diffuse, and complex in terms of specification and interpretation.

Relationship Between Research and Practice Contexts

An inherent challenge for all research conducted in the context of highly controlled experimental settings is its difficulty informing specifically what can be expected when implementation moves to more natural, uncontrolled settings. Research on the efficacy of family–school partnership is no exception. There are “common culprits” associated with the conduct of intervention research in highly applied practice settings (see Stormshak et al., [in press](#)). For example, lack of resources or leadership, limited personnel training and support, competing programs and demands, and unexpected events can each preclude the ability of schools to roll out intervention programs effectively. Nuances unique to partnership interventions add layers of challenges that deserve special attention. We have found that culprits associated with recruitment, attrition and mobility, relationships, and fit present unique challenges for implementation in naturalistic school settings.

Recruitment

The focus of family–school partnerships may present challenges with recruitment in intervention research. In our own lab, recruitment challenges are present at both the school and family levels. Schools are increasingly faced with pressures to produce effects to reduce gaps for certain students or groups, and oftentimes the interventions that are most compelling are those targeting school turn-around or remediation of student deficits. Unfortunately, research attesting to the positive indirect effects of parent engagement and partnership programs between school and home is not widely realized among practice communities. We have found that recruitment for our studies that indirectly target student achievement, behaviors, or psychosocial

outcomes through family–school partnerships present a “hard sell” for teachers, administrators, or other personnel responsible for approving research efforts in schools. Relatedly, we have experienced challenges recruiting schools that are faced with opportunities and invitations to implement a number of other competing programs and interventions. Indeed, decisions on what will be adopted by schools are often based on what is perceived as most aligned with immediate goals and priorities (often specific to student achievement) at the least cost (in terms of both monetary and time investments). Unfortunately, family–school partnership interventions may not rise to the top when evaluated on these criteria, at their face value.

At the individual family level, our research has been challenged by the reality that families and students who are at greatest need, and expected to benefit the most, may be the least likely to engage. Despite the encouraging findings of the importance of family–school partnerships for promoting student success, such outcomes are only possible when families participate. In our own CBC research, we have experienced that a number of families invited to participate decline the invitation. Specifically, in our recently completed randomized trial (Sheridan et al., 2012, 2013), 25 % of students ranked by teachers as having the most significant behavioral problems in their classrooms had parents who failed to participate in the intervention. In addition, parents of nearly one-third of students ranked second highest in severity of problems failed to participate. Similar estimates are suggested in a current randomized trial in rural schools, wherein within the first 2 years, 33 % and 39 % of parents of students ranked first or second (respectively) have not provided consent. In this case, parents serve as gatekeepers to services for their children. Because their decisions to accept or decline services determine access for themselves and their children, failure to participate may preclude the ability for children and families to receive the help they sorely need and indirectly widen, rather than close, opportunity and achievement gaps. Unfortunately, little information is available on what drives parents to accept or decline invitations to partner with schools or effective methods to engage them actively in programs to support their child’s positive adjustment.

Attrition and Mobility

Whereas attrition is a common challenge in all applied intervention research, the implications associated with attrition create significant problems in partnership research. Our experiences suggest that retaining parent, teacher, and student triads make conducting partnership research particularly difficult. Most research testing the efficacy of family–school partnerships is concerned with facilitating a significant improvement in student performance, with the student as the unit of analysis. Unique to partnership research, interventions rely on facilitating change in parents and teachers as mediators or conduits of change in students. Thus, the ability to fully test the effects of a partnership intervention on student outcomes relies on the full participation of not one individual, but three individuals who each serve as part of a triad. Attrition at any one of these levels (i.e., student, parent, or teacher)

precludes the inclusion of data associated with the entire triad. Thus, demands for recruitment and retention of triads, not individuals, introduce unique challenges.

Attrition from studies occurs for a wide range of reasons. Certain families are mobile by definition (e.g., military families) or by circumstance (e.g., immigrants, impoverished). Nearly four percent of school age children have one or both parents in the military (Chandra, Martin, Hawkins, & Richardson, 2010) and as a result, experience high rates of school mobility (Kerbow, 1996). Similarly, racial and ethnic minority children living in poverty are more likely to experience recurrent moves (i.e., five or more moves) than their white, middle class counterparts (Murphy, Bandy, & Moore, 2012). This type of residential mobility puts children at risk for behavioral, socioemotional, and academic difficulties (Engel, Gallagher, & Lyle, 2010; Jolleyman & Spencer, 2008). Despite the clear need for partnership practices that address this mobility, most research in the area assumes participants will have long-lasting relationships with schools and teachers; yet, the natural circumstances created by mobility result in interactions between home and school that are often brief and difficult to sustain. Demands for research on partnership practices that generalize across schools, teachers, and parents create certain challenges for researchers.

A related issue is concerned with longevity of family–school partnerships. Partnerships comprise individuals in relationship with one another at a point in time. Research investigating the efficacy of partnership interventions are capable of determining immediate, direct effects for all participants in the triad. However, difficulties arise with efforts associated with evaluating long-term effects of family–school partnerships. Any attempts to assess the maintenance of partnerships are fraught with the reality that new triadic partnerships are formed each academic year. Whereas it is possible to explore the development of new relationships or partnerships, the long-term effects of interventions on a specific partnership dynamic is not possible because students (and thus, their parents) move on. This special case of mobility, albeit a natural one, creates challenges when conducting research that is grounded in specific relationships.

The Relational Context of Partnership Research

By definition, partnerships comprise relationships between people (in this case, parents and educators). Defining an intervention that is characterized in terms of a relationship between parties is challenging, particularly given our call for greater specification. Processes that are unique to particular interactions, relationships or contexts including process elements that allow for informed and responsive adaptations relative to individual partnership needs must be specified when operationalizing partnership variables in experimental research.

Our approach to partnership research has always considered relationships as central, including relationships between ourselves and our field partners. We have

learned that researchers and field staff often have similar goals, but different means for achieving them. Ultimately, they generally share a desire to identify methods for helping students achieve the best of their ability, and to begin closing the opportunity and achievement gap that exists for many children. However, different vantage points encourage them to approach this goal using different methods. Whereas school staff may feel pressured and look for an efficient solution to pressing needs, researchers generally prefer systematic, precise, rigorous implementation, observation, analysis, and interpretation of routinized practices while controlling what is possible. Thus, there is often a disconnect between the needs of researchers for imposing rigorous experimental control, and educational practitioners needing timely solutions and ready information on effective practices for their school context.

Fit

The issue of fit between the partnership program being evaluated in research and the field site within which it is being implemented is an important one. Research addressing interactions between partnership programs and the systems within which they are implemented aims to identify specific contextual variables that may influence uptake and efficacy of partnership interventions. Efforts at determining what works in the field need to also consider “for whom” and “in what context” effects can be expected. Thus, in addition to asking what works, there is a need to consider systemic variables in order to predict (a) whether what fits within natural and applied implementation sites works, and (b) whether what works actually fits.

An issue associated with the identification of interactions between context and intervention pertains to identifying potential levels or dosage of implementation that may be sufficient (just enough), extensive (too much), or indicated (just right). Policy and practice demands from inside and outside of the school system often require selection of programs to be based not only on what is perceived as most effective for meeting the goals of its constituents, but also what is most efficient or least costly. Even when research points to specific partnership practices that may result in positive outcomes for meeting identified needs, schools will not always be positioned to implement a full intervention program. Adoption of a full partnership model with families may be overwhelming to field sites in terms of human, financial, and material resources. Given that a system’s capacity to support an intervention may determine its implementation, it seems important to know the amount of an intervention that will produce desired effects so as not to produce undue pressure or overtax the system’s capacity and resources for little gain or added value. Research that uncovers the specific ingredients of partnership interventions and how they predict desired outcomes will help to discern levels of implementation that produce absolute (indicated), threshold (just enough), and saturation (too much) effects.

Issues of Fidelity in Partnership Research

In any study intending to discover the efficacy of an intervention, specification of the intervention and its implementation are of central importance. Research aiming to test the efficacy of partnerships as interventions on desired outcomes is no different. In both research and practice, our ability to draw valid conclusions regarding the efficacy of an intervention rests on a clear understanding of what constitutes the independent variable (in this case, family–school partnership) and how the intervention was received by its intended consumers or end users.

The study of partnership interventions raises unique challenges associated with fidelity. Researchers investigating family–school partnerships rarely hear practitioners refute that parents are contributors to children’s development. Few of our field partners have voiced opposition to working with families. At the same time, however, several have questioned the need for a formal intervention related to family engagement or partnership saying that they already practice partnerships. We call these individuals “doers.” Because individuals across the research–practice continuum invoke their own personal understandings of parent partnerships (akin to the aforementioned definitional issues), what one person believes to constitute a partnership may vary significantly from another. “Doers” pose a challenge to implementation fidelity because they fail to see different practices as fundamentally and distinctively unique, and may implement practices based on what they already know and believe, and not in a manner consistent with a specified partnership intervention aligned with a particular research protocol.

Equally important is the identification of individual treatment agents who state good intentions to adhere to certain protocols or practices, but over time loosen the integrity with which the intervention is delivered as prescribed. We have often worked with individuals, known as “drifters,” who begin to deviate in systematic or nonsystematic ways to the point that the intervention is no longer being delivered in its true form. The degree of drift that is allowable (i.e., how much deviation is permitted before the efficacy of the partnership intervention suffers) has not been studied in partnership research, but is a necessary consideration as researchers attempt to understand conditions under which treatment effects can be expected. Particularly in light of our discussion on the complexity of many partnership interventions, this issue of drift is salient.

A final issue associated with understanding the role of fidelity on partnership research concerns the multidimensional nature of fidelity itself. Determining whether an intervention is implemented with fidelity requires considerations of multiple intervention dimensions, including adherence, quality, participant responsiveness, dosage, and program differentiation (Dane & Schneider, 1998). Whereas each of these has relevance in partnerships research, little methodological work is available to guide researchers in how to consider the multiple dimensions when interpreting intervention effects.

Research Agenda

The empirical support for family–school partnerships is unequivocal; however, years of conducting experimental research has revealed methodological, theoretical, and contextual issues and associated challenges needing attention to advance the field. At least three related lines of inquiry are crucial to expand the knowledge base for executing family–school partnership research in the field. Taken together, we believe a fruitful research agenda is one that (a) determines the active ingredients that influence family–school partnership outcomes; (b) embraces translational models that account for the unique contextual realities of implementing partnership programs in applied settings; and (c) conceptualizes, measures, and analyzes fidelity within family–school partnership research.

Specification of Family–School Partnerships

Definitions of family–school partnerships have long suffered from disparate meanings that impede efforts to determine conclusive findings regarding the effects of partnership programs. There is a clear need to resolve definitional ambiguities, yet partnership practices are often contextually responsive and multidimensional. The complexity associated with partnerships makes it difficult to develop an agreed upon universal definition. As a result, a promising line of research is needed to empirically derive the operative features of partnership interventions and determine the active ingredients of family–school partnerships that are responsible for outcomes at the student, parent, and teacher levels. Such research would facilitate a shared understanding of the critical features of family–school partnership and empirically inform the implementation of unique and contextualized partnership interventions.

As a first step in this line of research, it is important to identify the presumed active ingredients of partnerships (Damschroder & Hagedorn, 2011). Producing taxonomies (Chorpita & Daleiden, 2009) can elucidate partnership components shared across interventions. In this approach, coding the extant literature can generate a comprehensive list of the techniques and strategies used in effective family–school partnership programs. Data algorithms can be used to determine common partnership elements by examining the frequency with which specific techniques are used across these interventions (Chorpita, Becker, & Daleiden, 2007; Chorpita, Daleiden, & Weisz, 2005). Additional data sets can be created by coding the literature for information regarding demographic characteristics (e.g., student age), contextual features (e.g., rural communities), and partnership strategies (e.g., bidirectional communication). The data can be distilled, analyses (e.g., Chi-square, ANOVA) run, and results reviewed by experts to group practice elements into specific profiles. For example, different partnership element profiles can be created to

determine the strategies used for specific areas of concern (e.g., disruptive behaviors, academic skill deficits) and students of diverse backgrounds (e.g., race, language spoken). Other statistical analyses can then be used to test the elements in relation to outcomes (e.g., West, Walia, Hyder, Shahab, & Michie, 2010). Findings can inform the understanding of the operative components of partnerships and each component's potency to help determine whether each ingredient is an essential, desirable, or sufficient condition to produce treatment effects. An understanding of each ingredient's weight can clarify the components required to maximize the potential for certain outcomes. More nuanced analyses of desirable partnership features (e.g., quality, frequency) will uncover elements that can be adapted to be responsive to particular relationship dynamics and local contexts.

Translational Methods

One of the goals of applied partnership research is to successfully translate efficacious practices into natural settings (e.g., homes, schools). Clinical trials are often necessary to determine efficacious practices; however, research that relies on highly controlled experimental settings fails to account for the complexities that arise when implementation moves to uncontrolled sites. As a result, there is a need to understand the contextual factors that facilitate and impede the uptake of family–school partnership interventions. An implementation science approach allows for the scientific study of variables that promote the adoption of partnership programs into professional practice (Forman et al., 2013).

The successful investigation of contextual features assumes a reciprocal and dynamic relationship between practice and research (Kratochwill et al., 2012). Methods that build off researchers and practitioners working in concert hold particular promise for identifying local features that support the adoption of family–school partnership interventions. For example, participatory action research actively involves major stakeholders in the research process (Power, 2003). Engaging educators and parents in partnership research from the outset could create consistent goals and resolve existing divides. For example, involving key parties in the research process can help examine the factors that influence parents' decisions to participate and actively engage in partnership programs or decline invitations to partner with schools. Modifications to partnership practices can be made based on the information gathered to ensure programs align with the needs of families and educators. Further, in a practice-based evidence framework (Kratochwill et al., 2012), practitioners gather information during the course of intervention implementation to complement traditional experimental research methods and elucidate the effects of natural variations in partnership programs on treatment outcomes.

A related line of inquiry is concerned with transportability of partnership practices over time. That is, there is a need to elucidate contextual features that support the generalization of family–school partnerships over development, grade level, and

changing parent–teacher relationships due to situational and natural mobility. Statistical analyses and methods that adequately model temporal variation and stability of partnership practices within the natural schooling sequence are necessary. Attending directly to the practice context in this manner may help match educational and research agendas and clarify the contextual fit of family–school partnership interventions.

Fidelity Analysis

Cutting across each line of research is the need to clearly specify the family–school partnership intervention being implemented. Drawing valid conclusions regarding the effects of a partnership program relies on an understanding of what comprises the intervention and how those components were delivered and received; that is, how fidelity operates within family–school partnership interventions. As a result, fidelity assessment depends on both an awareness of the critical elements of family–school partnerships as well as the contextual features that influence their implementation.

A necessary step in this line of research is to determine psychometrically sound measures to assess the various dimensions of fidelity (e.g., adherence, quality, participant responsiveness, dosage, and program differentiation; Dane & Schneider, 1998). Although critical elements of partnership interventions (and their operational definitions) have not been identified, it is likely that relational features such as shared responsibility, mutual decision making, and bidirectional communication are components that contribute to a partnership intervention. To date, no generally accepted tool or approach to assessing partnership intervention fidelity has been identified, and as a result, basic reliability and validity evidence for measures of partnership intervention fidelity have not been evaluated. Only when measures are developed and subject to rigorous psychometric analyses will researchers be able to fully explore fidelity within partnership programs.

Once measures of fidelity are determined, attention to the various dimensions will allow researchers to carefully examine many facets of family–school partnership interventions (Sheridan et al., 2014). It is necessary to begin empirically investigating fidelity (and each dimension) as an independent variable or a moderator of treatment effects. Testing relationships between fidelity and relevant variables can help determine the influence of variations of fidelity and the mechanisms through which partnership interventions operate.

Another particularly valuable line of inquiry could examine threshold and saturation levels of partnership programs (Sheridan et al., 2014). Assessment of threshold levels can clarify the intensity required for partnership interventions to produce optimal effects, and assessment of saturation levels can establish the point at which effects may have reached and surpassed their peak. Information generated from this line of research can help to determine how much deviation is permissible

(i.e., allowable degree of drift) within partnership interventions and how much support is needed by the system to implement the practices. Indeed, research of this type and specificity would be beneficial for virtually all psychosocial and educational interventions.

Conclusion

Our research team has spent the last decade conducting family–school partnership intervention research. Although our findings have added to the historic body of evidence demonstrating the importance of family–school partnerships, careful reflection and years of experience have uncovered the complexities associated with the execution (e.g., fidelity of partnership practices), interpretation (e.g., definitional variations), and translation (e.g., fit of partnership intervention) of partnership research. We believe a viable research agenda is one that seeks to address these unique challenges by empirically determining the active ingredients of family–school partnership programs, using methods that support the translation of partnership research into practice, and measuring and analyzing the fidelity with which these interventions are put into practice to provide a more nuanced understanding of how family–school partnership interventions operate.

Acknowledgments This study was supported by federal grants awarded to the first author by the U.S. Department of Education Institute of Education Sciences (Grants #R305C090022, R324A100115, R324A120153, R305A120144). The opinions expressed herein are those of the authors and are not considered reflective of the funding agency. For correspondence regarding this article, please contact Dr. Susan Sheridan.

References

- Albright, M. I., & Weissberg, R. P. (2010). Family-school partnerships to promote social and emotional learning. In S. L. Christenson & A. L. Reschly (Eds.), *Handbook of school–family partnerships* (pp. 246–265). New York, NY: Routledge.
- Barry, L. M., & Santarelli, G. E. (2000). Making it work at school and home: A need based collaborative, across settings, behavioral intervention. *The California School Psychologist*, *5*, 43–51.
- Bronfenbrenner, U. (1979). *The ecology of human development: Experimental by nature and design*. Cambridge, MA: Harvard University Press.
- Bronfenbrenner, U. (1992). Ecological systems theory. In R. Vasta (Ed.), *Six theories of child development: Revised formulations and current issues* (pp. 187–248). Philadelphia, PA: Jessica Kingsley.
- Brown, J. R., Knoche, L. L., Edwards, C. P., & Sheridan, S. M. (2009). Professional development to support parent engagement: A case study of early childhood practitioners. *Early Education and Development*, *20*, 482–506.
- Chandra, A., Martin, L. T., Hawkins, S. A., & Richardson, A. (2010). The impact of parental deployment on child social and emotional functioning: Perspectives of school staff. *Journal of Adolescent Health*, *46*, 218–223. doi:[10.1016/j.jadohealth.2009.10.009](https://doi.org/10.1016/j.jadohealth.2009.10.009).

- Chorpita, B. F., Becker, K. D., & Daleiden, E. L. (2007). Understanding the common elements of evidence-based practice: Misconceptions and clinical examples. *Journal of the American Academy of Child & Adolescent Psychiatry*, *46*, 647–652. doi:[10.1097/chi.0b013c318033ff71](https://doi.org/10.1097/chi.0b013c318033ff71).
- Chorpita, B. F., & Daleiden, E. L. (2009). Mapping evidence-based treatments for children and adolescents: Application of the distillation and matching model to 615 treatments from 322 randomized trials. *Journal of Consulting and Clinical Psychology*, *77*, 566–579. doi:[10.1037/a0014565](https://doi.org/10.1037/a0014565).
- Chorpita, B. F., Daleiden, E. L., & Weisz, J. R. (2005). Identifying and selecting the common elements of evidence based interventions: A distillation and matching model. *Mental Health Services Research*, *7*, 5–20. doi:[10.1007/s11020-005-1962-6](https://doi.org/10.1007/s11020-005-1962-6).
- Colton, D., & Sheridan, S. M. (1998). Conjoint behavioral consultation and social skills training: Enhancing the play behavior of boys with attention deficit-hyperactivity disorder. *Journal of Educational and Psychological Consultation*, *9*, 3–28.
- Connell, A. M., Dishion, T. J., Yasui, M., & Kavanagh, K. (2007). An adaptive approach to family intervention: Linking engagement in family-centered intervention to reductions in adolescent problem behavior. *Journal of Consulting and Clinical Psychology*, *75*, 568–579.
- Damschroder, L. J., & Hagedorn, H. J. (2011). A guiding framework and approach for implementation research in substance use disorders treatment. *Psychology of Addictive Behaviors*, *25*, 194–205. doi:[10.1037/a0022284](https://doi.org/10.1037/a0022284).
- Dane, A. V., & Schneider, B. H. (1998). Program integrity in primary and early secondary prevention: Are implementation effects out of control? *Clinical Psychology Review*, *18*, 23–45. doi:[10.1016/S0272-7358\(97\)00043-3](https://doi.org/10.1016/S0272-7358(97)00043-3).
- Downer, J. T., & Myers, S. S. (2010). Application of a developmental/ecological model to family-school partnerships. In S. L. Christenson & A. L. Reschly (Eds.), *Handbook of school-family partnerships* (pp. 3–29). New York, NY: Routledge.
- Elicker, J., Wen, X., Kwon, K. A., & Sprague, J. B. (2013). Early Head Start relationships: Association with program outcomes. *Early Education & Development*, *24*, 491–516.
- Engel, R. C., Gallagher, L. B., & Lyle, D. S. (2010). Military deployment and children's academic achievement: Evidence from Department of Defense Education Activity schools. *Economics of Education Review*, *29*, 73–82. doi:[10.1016/j.econedurev.2008.12.003](https://doi.org/10.1016/j.econedurev.2008.12.003).
- Epstein, J. L., & Sanders, M. G. (2002). Family, school, and community partnerships. In M. H. Bornstein (Ed.), *Handbook of parenting* (Vol. 5, pp. 407–437). Mahwah, NJ: Lawrence Erlbaum.
- Fan, X., & Chen, M. (2001). Parental involvement and students' academic achievement: A meta-analysis. *Educational Psychology Review*, *13*, 1–22.
- Fantuzzo, J., Tighe, E., & Childs, S. (2000). Family involvement questionnaire: A multivariate assessment of family participation in early childhood education. *Journal of Educational Psychology*, *92*, 367–376.
- Forman, S. G., Shapiro, E. S., Coddling, R. S., Gonzales, J. E., Reddy, L. A., Rosenfield, S. A., ... Stoiber, K. C. (2013). Implementation science and school psychology. *School Psychology Quarterly*, *28*, 77–100. doi:[10.1037/spq0000019](https://doi.org/10.1037/spq0000019)
- Grolnick, W. S., & Slowiaczek, M. L. (1994). Parents' involvement in children's schooling: A multidimensional conceptualization and motivational model. *Child Development*, *65*, 237–252.
- Guli, L. A. (2005). Evidence-based parent consultation with school-related outcomes. *School Psychology Quarterly*, *20*, 455–472.
- Jelleyman, T., & Spencer, N. (2008). Residential mobility in childhood and health outcomes: A systematic review. *Journal of Epidemiology and Community Health*, *62*, 584–592. doi:[10.1136/jech.2007.060103](https://doi.org/10.1136/jech.2007.060103).
- Jeynes, W. H. (2003). A meta-analysis: The effects of parental involvement on minority children's academic achievement. *Education and Urban Society*, *35*, 202–218.
- Jeynes, W. H. (2005). A meta-analysis of the relation of parental involvement to urban elementary school student academic achievement. *Urban Education*, *40*, 237–269.

- Kerbow, D. (1996). Patterns of urban student mobility and local school reform. *Journal of Education for Students Placed at Risk, 1*, 147–169. Retrieved from <http://www.csos.jhu.edu/crespar/techReports/Report5.pdf>.
- Kim, E. M., Coutts, M. J., Holmes, S. R., Sheridan, S. M., Ransom, K. A., Sjuts, T. M., & Rispoli, K. M. (2012). *Parent involvement and family-school partnerships: Examining the content, processes, and outcomes of structural versus relationship-based approaches* (CYFS Working Paper No. 2012-6). Retrieved from cyfs.unl.edu
- Kim, E. M., & Sheridan, S. M. (2014). Foundational aspects of family-school connections: Definitions, conceptual frameworks, and research needs. In S. M. Sheridan & E. M. Kim (Eds.), *Research on family-school partnerships: An interdisciplinary examination of state of the science and critical needs, 1*, 1–14. New York, NY: Springer.
- Knoche, L. L., Edwards, C. P., Sheridan, S. M., Kupzyk, K. A., Marvin, C. A., Cline, K. D., & Clarke, B. L. (2012). Getting Ready: Results of a randomized trial of a relationship-focused intervention on the parent-infant relationship in rural early head start. *Infant Mental Health Journal, 33*, 439–458.
- Knoche, L. L., Sheridan, S. M., Edwards, C. P., & Osborn, A. Q. (2010). Implementation of a relationship-based school readiness intervention: A multidimensional approach to fidelity measurement for early childhood. *Early Childhood Research Quarterly, 25*, 299–313.
- Kratochwill, T. R., Elliott, S. N., Loitz, P. A., Sladeczek, I., & Carlson, J. S. (2003). Conjoint consultation using self-administered manual and videotape parent–teacher training: Effects on children’s behavioral difficulties. *School Psychology Quarterly, 18*, 269–302.
- Kratochwill, T. R., Hoagwood, K. E., Kazak, A. E., Weisz, J. R., Hood, K., Vargas, L. A., & Banez, G. A. (2012). Practice-based evidence for children and adolescents: Advancing the research agenda in schools. *School Psychology Review, 41*, 215–235.
- Kratochwill, T. R., & Stoiber, K. C. (2002). Evidence-based interventions in school psychology: Conceptual foundations of the Procedural and Coding Manual of Division 16 and the Society for the Study of School Psychology Task Force. *School Psychology Quarterly, 17*, 341–389.
- Lasecki, K., Olympia, D., Clark, E., Jenson, W., & Heathfield, L. T. (2008). Using behavioral interventions to assist children with type 1 diabetes manage blood glucose levels. *School Psychology Quarterly, 23*, 389–406.
- Lines, C., Miller, G. E., & Arthur-Stanley, A. (2011). *The power of family-school partnering (FSP): A practical guide for school mental health professionals and educators*. New York, NY: Routledge.
- Mortier, K., Hunt, P., Desimpel, L., & Van Hove, G. (2009). With parents at the table: Creating supports for children with disabilities in general education classrooms. *European Journal of Special Needs Education, 24*, 337–354.
- Murphy, D., Bandy, T., & Moore, K. A. (2012). Frequent residential mobility and young children’s well-being. *Child Trends Research Brief*. Retrieved from www.childtrends.org
- Power, T. J. (2003). Promoting children’s mental health: Reform through interdisciplinary and community partnerships. *School Psychology Review, 32*, 3–16.
- Ray, K. P., Skinner, C. H., & Watson, T. S. (1999). Transferring stimulus control via momentum to increase compliance in a student with autism: A demonstration of collaborative consultation. *School Psychology Review, 28*, 622–628.
- Rimm-Kaufman, S. E., & Pianta, R. C. (2000). An ecological perspective on the transition to kindergarten: A theoretical framework to guide empirical research. *Journal of Applied Developmental Psychology, 21*, 491–511.
- Senechal, M., & LeFevre, J. (2002). Parental involvement in the development of children’s reading skill: A five-year longitudinal study. *Child Development, 73*, 445–460.
- Sheldon, S. B., & Epstein, J. L. (2005). Involvement counts: Family and community partnerships and mathematics achievement. *Journal of Education Research, 98*, 196–206.
- Sheridan, S. M., Bovaird, J. A., Glover, T. A., Garbacz, S. A., Witte, A., & Kwon, K. (2012). A randomized trial examining the effects of conjoint behavioral consultation and the mediating role of the parent-teacher relationship. *School Psychology Review, 41*, 23–46.

- Sheridan, S. M., Eagle, J. W., Cowan, R. J., & Mickelson, W. (2001). The effects of conjoint behavioral consultation: Results of a four-year investigation. *Journal of School Psychology, 39*, 361–385.
- Sheridan, S. M., Eagle, J. W., & Doll, B. (2006). An examination of the efficacy of conjoint behavioral consultation with diverse clients. *School Psychology Quarterly, 21*, 396–417.
- Sheridan, S. M., Knoche, L. L., Edwards, C. P., Bovaird, J., & Kupzyk, K. A. (2010). Parent engagement and school readiness: Effects of the Getting Ready intervention on preschool children's social-emotional competencies and behavioral concerns. *Early Education and Development, 21*, 125–156.
- Sheridan, S. M., Knoche, L. L., Edwards, C. P., Kupzyk, K. A., Clarke, B. L., & Kim, E. M. (2014). Efficacy of the Getting Ready intervention and the role of parental depression. *Early Education and Development, 25*, 746–769.
- Sheridan, S. M., Knoche, L. L., Kupzyk, K. A., Edwards, C., & Marvin, C. A. (2011). A randomized trial examining the effects of parent engagement on early language and literacy: The Getting Ready intervention. *Journal of School Psychology, 49*, 361–383.
- Sheridan, S. M., & Kratochwill, T. R. (1992). Behavioral parent-teacher consultation: Conceptual and research considerations. *Journal of School Psychology, 30*, 117–139.
- Sheridan, S. M., & Kratochwill, T. R. (2008). *Conjoint behavioral consultation: Promoting family-school connections and interventions*. New York, NY: Springer.
- Sheridan, S. M., Kratochwill, T. R., & Bergan, J. R. (1996). *Conjoint behavioral consultation: A procedural manual*. New York, NY: Plenum.
- Sheridan, S. M., Kratochwill, T. R., & Elliott, S. N. (1990). Behavioral consultation with parents and teachers: Delivering treatment for socially withdrawn children at home and school. *School Psychology Review, 19*, 33–52.
- Sheridan, S. M., Marvin, C. A., Knoche, L. L., & Edwards, C. P. (2008). Getting ready: Promoting school readiness through a relationship-based partnership model. *Early Childhood Services, 3*, 149–172.
- Sheridan, S. M., Rispoli, K., & Holmes, S. R. (2014). Treatment integrity in conjoint behavioral consultation: Conceptualizing active ingredients and potential pathways of influence. In L. Sanetti & T. Kratochwill (Eds.), *Treatment integrity: Conceptual, methodological, and applied considerations for practitioners* (pp. 255–278). Washington, DC: American Psychological Association.
- Sheridan, S. M., Ryoo, J. H., Garbacz, S. A., Kunz, G. M., & Chumney, F. L. (2013). The efficacy of conjoint behavioral consultation on parents and children in the home setting: Results of a randomized controlled trial. *Journal of School Psychology, 51*, 717–733.
- Sheridan, S. M., Warnes, E. D., Woods, K. E., Blevins, C. A., Magee, K. L., & Ellis, C. (2009). An exploratory evaluation of conjoint behavioral consultation to promote collaboration among family, school, and pediatric systems: A role for pediatric school psychologists. *Journal of Educational and Psychological Consultation, 19*, 106–129.
- Stormshak, E., Brown, K. L., Moore, K. J., Dishion, T., Seeley, J., & Smolkowski, K. (in press). Going to scale with family-centered, school-based interventions: Challenges and future directions. In S. M. Sheridan & E. M. Kim (Eds.), *Research on family-school partnerships: An interdisciplinary examination of state of the science and critical needs. Vol. IV: Translating family-school partnerships research into practice*. New York, NY: Springer.
- Weiner, R., Sheridan, S. M., & Jenson, W. R. (1998). Effects of conjoint behavioral consultation and a structured homework program on math completion and accuracy in junior high students. *School Psychology Quarterly, 13*, 281–309.
- West, R., Walia, A., Hyder, N., Shahab, L., & Michie, S. (2010). Behavior change techniques used by English stop smoking services and their associations with short-term quit outcomes. *Nicotine & Tobacco Research, 12*, 742–747. doi:10.1093/ntr/ntq074.

Chapter 2

Going to Scale with Family-Centered, School-Based Interventions: Challenges and Future Directions

Elizabeth A. Stormshak, Kimbree L. Brown, Kevin J. Moore, Thomas Dishion, John Seeley, and Keith Smolkowski

Students who display problem behaviors at school are at risk for a variety of difficulties, including poor academic achievement, poor school attendance, depression, and substance use (Barry, Lyman, & Grofer Klinger, 2002; Patterson, Reid, & Dishion, 1992), all of which can be challenging for teachers and school administrators to manage (Dishion & Stormshak, 2007; Walker, Colvin, & Ramsey, 1995). Many schools also lack the infrastructure necessary to systematically and effectively support children and adolescents with academic, behavioral, or mental health concerns (Eccles & Harold, 1993; Ringeisen, Henderson, & Hoagwood, 2003). However, schools are an ideal location to implement evidence-based prevention and intervention programs to address problem behaviors because youths spend a considerable amount of time there (Dishion, 2011). The World Health Organization (WHO, 2008) and Centers for Disease Control (CDC, 2013) promote school settings as particularly important for actions that target and improve outcomes for child and adolescent health. Moreover, using schools as service delivery settings may increase opportunities to provide health services to underserved populations, such as rural populations, low-income families, and ethnically diverse youths. As such, local, state, and federal policies have increasingly called for the use of evidence-based practices in school settings.

E.A. Stormshak, Ph.D. (✉) • K.L. Brown
University of Oregon, 5251 College of Education, Eugene, OR 97403, USA
e-mail: bstorm@uoregon.edu

K.J. Moore
Prevention Science Institute, 6217 University of Oregon, Eugene, OR 97403-6217, USA

T. Dishion
Arizona State University, Tempe, AZ, USA

J. Seeley • K. Smolkowski
Oregon Research Institute, Eugene, OR USA

Although schools have become consistent venues for intervention efforts, research is limited on effective implementation and execution of these programs to high-quality standards. Schools are thus left without effective or efficient plans when they choose to adopt empirically based interventions. Clearly, the unique issues and challenges presented by program scale-up must be addressed.

Implementation of Evidence-Based Practices in School Settings

Little theory or research exists regarding how to implement behavioral and mental health interventions, such as family-school partnership programs, with fidelity (Domitrovich & Greenberg, 2000; Elliott & Mihalic, 2004), yet high-quality implementation is directly linked to strong outcomes and improved effect sizes across intervention models (Durlak & DuPre, 2008). Family-centered treatment models that emphasize parent training and support for families show the largest effects over time in nearly every review of interventions designed to reduce problem behavior and substance use (Kazdin, 2010; Prinz & Dumas, 2004). Despite this overwhelming evidence, a high proportion of children and adolescents never receive treatment for these problems, and a very small percentage of parents participate in parenting or family interventions to address behavior problems (Prinz & Sanders, 2007; Zubrick et al., 1995). Limited access to mental health treatment for children has fueled an increase in the number of school-based mental health programs in the United States. Nevertheless, there are many barriers to implementing the programs effectively (Weist, 2005).

The majority of interventions focus on the individual child or on the school context (e.g., positive behavior support; Horner, Sugai, Todd, & Lewis-Palmer, 2005); few are brief and target known risk factors for substance use, such as family management. They typically consist of a response-to-intervention (RTI) framework that embeds services in a model of universal, selected, and indicated interventions delivered in the school, but they offer little coordination between school and home. This is a serious shortcoming in that the nature of interactions between parents and their child's school becomes more formalized and less frequent in middle school (Rimm-Kaufman & Pianta, 2000) and leads to less engagement by parents in their child's overall adjustment, when parenting and family management are critical to school success and healthy adaptation. Data strongly suggest that motivating parents to engage in family management will effect long-term change (Dishion & Kavanagh, 2003; Forgatch, Bullock, & Patterson, 2004; Kazdin, 2002; Stormshak, Fosco, & Dishion, 2010), and research supports the efficacy of interventions for high-risk students in the public school environment that target parenting practices (e.g., Atkins et al., 2008).

Multiple barriers, such as time, money, and competing priorities, limit the ability of schools to implement interventions that involve families (Forman, Olin, Hoagwood, Crowe, & Saka, 2009), making most interventions that target parenting practices unrealistic for schools (Christenson, 2003), despite their proven efficacy. Given the dire economic situation currently facing many school systems, it is imperative to find a cost-effective means of improving student success rates that is efficient

and effective, realistic, does not require extensive school staff time to implement with fidelity, and integrates families and family-centered care into school systems.

Literature pertaining to the diffusion, implementation, and sustainability of school-based interventions is sparse and leaves schools with little strategic support regarding the use of evidence-based programs (Feldstein & Glasgow, 2008). Additional research has found that evidence-based programs implemented outside of controlled trials are generally not executed to proficient levels of quality (Dusenbury, Brannigan, Hansen, Walsh, & Falco, 2005; Gottfredson & Gottfredson, 2002). This is unfortunate because program fidelity is strongly linked to positive intervention outcomes (Durlak & DuPre, 2008). A more systematic understanding of how to effectively and accurately implement evidence-based family–school partnership interventions in school settings is needed to ensure successful student outcomes (Greenberg, Domitrovich, Graczyk, & Zins, 2001). Failure to fulfill this need may lead to detrimental effects, such as the inability of schools to develop and sustain systems of intervention that support struggling students (Dishion, 2011).

Translation of research to practice in community settings involves several phases, including a preadoption phase, during which key stakeholders and markets are identified; the adoption phase, during which organizations get ready to implement the program; the implementation phase, during which training and fidelity evaluation occur; and a sustainability phase, during which structures and policies are identified to enable continuation of the intervention (Spoth et al., 2013). Many contextual factors in schools influence their ability to implement family–school partnership practices and sustain them, including teacher training, administrative support, financial resources, and school morale and organization. Few of these factors are taken into consideration when these interventions are developed or disseminated, however (Domitrovich et al., 2008). Protecting program fidelity is a primary goal when evidence-based programs are embedded in existing school frameworks (Spoth, Kavanagh, & Dishion, 2002). Even though few guidelines exist that demonstrate how to integrate programs effectively and realistically (Dishion, 2011) and that identify contextual and program structures that can make or break implementation quality (Payne & Eckert, 2010), researchers and practitioners must understand the conditions that both facilitate and impede high-quality implementation in schools. This is a crucial next step in implementation science because schools connect daily with large numbers of children and thus are valuable venues for dissemination of prevention and intervention programs. In fact, schools are the largest provider of child behavioral health services and the only community setting where many children receive any behavioral health interventions at all (Bums et al., 1995; Hoagwood, Bums, Kiser, Ringeisen, & Schoenwald, 2001).

Importance of Family–School Partnerships

Poor parenting practices and family relationships have been linked to the development and maintenance of youths' problem behaviors (Connell & Dishion, 2008; Spoth et al., 2002; Stormshak, E. A., Bierman, K. L., McMahon, R. J., Lengua, L., &

Conduct Problems Prevention Research Group, 2000). On the other hand, healthy parenting practices and relationships have been associated with positive youth outcomes, even in the presence of factors such as poverty and stress (Galambos, Barker, & Almeida, 2003; Ryan, Martin, & Brooks-Gunn, 2006). It makes sense that interventions targeting the development of positive parenting systems are effective for reducing youth problem behaviors (Dishion, Nelson, & Kavanagh, 2003; Dishion & Stormshak, 2007; Forgatch, DeGarmo, & Beldavs, 2005). A particularly salient time for intervening with parents may be during their child's transition to middle school, in that problem behaviors often amplify during adolescence (Dishion & Patterson, 2006; Patterson, Capaldi, & Bank, 1991). For example, decreased parental monitoring and parent-teacher communication and increased exposure to peers make the middle school years a risk period for the development of adolescent substance use, aggression, and violence (Dishion, Patterson, Stoolmiller, & Skinner, 1991; Eccles, Lord, & Roeser, 1995).

Even though parental involvement in school tends to decline when children enter middle school, research has shown that parent involvement in education is associated with positive child outcomes, including higher grade point averages (Gutman & Midgley, 2000), better self-regulation and social skills (Brody, Flor, & Gibson, 1999; McWayne, Hampton, Fantuzzo, Cohen, & Sekino, 2004), lower dropout rates (Rumberger, 1995), fewer grade retentions and special education placements (Miedel & Reynolds, 1999), and improvements in language and reading skills (Sheridan, Knoche, Kupzyk, Pope Edwards, & Marvin, 2011). When parents are involved in their child's education, students also more readily adjust to the demands of the classroom and show improved academic performance (Epstein, 1991; Henderson & Berla, 1994; Henderson & Mapp, 2002; Reynolds, 1992). Despite the advantages of involving parents in school settings in terms of primary school outcomes, such as achievement, few schools develop or maintain organized systems for positively intervening with them (Stormshak & Dishion, 2002).

Positive Family Support Program

To support the advancement of positive family-school partnerships, particularly during the middle school years, Dishion and colleagues developed the Positive Family Support (PFS) project. PFS is a tiered intervention designed to increase collaboration between families and school personnel during periods of developmental transition or risk. In this chapter, we provide a brief introduction to the model underlying PFS (Dishion & Stormshak, 2007) and its adaptation to the middle school environment (Fosco, Dishion, & Stormshak, 2012). Scale-up of the PFS model in 41 Oregon middle schools, a project funded by the Department of Education (R324A090111), is described in detail.

PFS evolved from intervention trials of the Family Check-Up in schools. The Family Check-Up (FCU) is a brief, cost-effective intervention that has emerged from a series of intervention trials in public middle schools to prevent escalating problem behaviors among young adolescents (Dishion et al., 2008; Dishion &

Kavanagh, 2003; Dishion & Stormshak, 2007; Stormshak et al., 2011; Stormshak, Dishion, Light, & Yasui, 2005). These trials with ethnically and socioeconomically diverse young children and middle school-age youths have demonstrated intervention effects on self-regulation, grade point average, attendance, school engagement, and growth of teacher-rated child problem behavior over time (Fosco et al., 2012; Stormshak et al., 2005, 2010), as well as a variety of nonacademic outcomes, such as rates of depression, substance use, high-risk sexual behavior, and early-adult obesity (Connell, Dishion, & Deater-Deckard, 2006; Stormshak et al., 2010; Van Ryzin & Nowicka, 2013).

The PFS model is intended to be delivered by school personnel with relatively little support from external consultants. Adaptations to the model for integration into middle schools have included tiered intervention intensity (Myers & Nastasi, 1999), strategies to enhance motivation (Miller & Rollnick, 2002), and a tailored intervention design (Collins, Murphy, & Bierman, 2004). As depicted in Fig. 2.1, the core components of PFS have been matched and dovetailed to components of school-wide positive behavior support systems, such as the Positive Behavior Interventions and Supports (PBIS; Sugai et al., 2000) model, to build bridges between school and home. The dovetailing of PFS with programs such as PBIS was intentional with respect to a public health implementation perspective (Biglan, 1995; Biglan, Sprague, & Moore, 2006; Shaw, 1986). This perspective suggests that by using an effective intervention model that makes pragmatic use of naturally occurring ecological settings and well-established service delivery structures (e.g., PBIS), the rate of engagement will increase while some of the implementation response cost to the setting will be reduced. In the scaling-up process, the ability of PFS to improve family–school partnerships and student academic and social outcomes was tested through dissemination and promotion of family support services by existing school personnel. The program has been implemented in a range of schools and economic conditions in Oregon; Table 2.1 shows the distribution of the

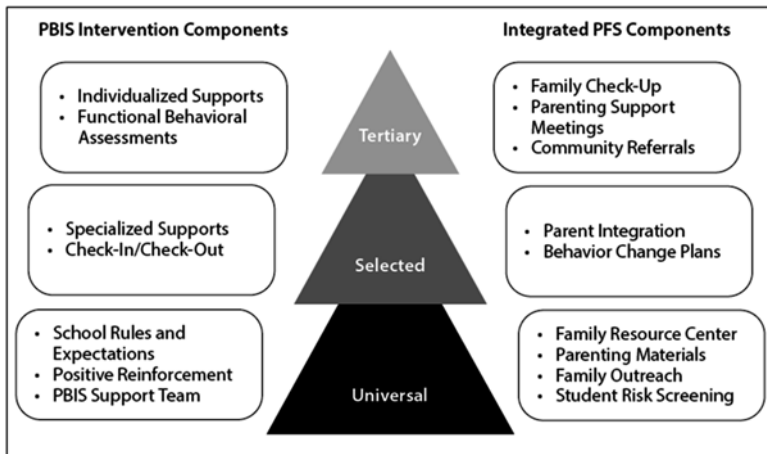

Fig. 2.1 Concatenation of school and family Positive Behavior Interventions and Supports (PBIS)

Table 2.1 Demographics of schools in the Positive Family Support Project

Schools	Number of students			Ethnic minority			Eligible for free/reduced-cost lunch			Location %
	<i>M</i>	SD	Range	<i>M</i> %	SD	% Range	<i>M</i> %	SD	% Range	
Intervention	507.24	236.56	158–990	29.6	12.68	10.6–60.9	59.7	14.46	28.3–87.6	50 urban
Control	526.05	212.10	202–874	30.7	19.20	8.1–79.1	59.0	19.10	18.3–87.7	42.86 urban
Total	516.41	222.35		30.2	16.0		59.4	16.60		46.3 urban

participating schools with respect to number of students, ethnic/minority status, and eligibility for free/reduced-cost lunch. The study sample are approximately 30 % ethnically diverse, and 59 % are eligible for free/reduced-cost lunch.

A number of challenges and obstacles arose throughout the scaling-up process. The remainder of this chapter focuses on the complexities of scaling up evidence-based family–school partnership practices aimed at improving the behavioral and mental health of students. It also describes approaches to successfully managing these complexities.

Contextual Complexities in School-Based Scale-Up of Family–School Partnership Interventions

Designing and implementing school-based interventions that target improvement of family–school partnerships is a challenging task (Spoth et al., 2002). As posited by Stormshak and Dishion (2002), interventions that can be embedded within existing school frameworks and that take into account each school’s unique contextual factors are the most likely to engage large numbers of school personnel and families. It can be challenging for program designers and implementers to develop and disseminate interventions that account for such complexities, however, because little research has specifically addressed them. More work is needed to understand the impact of a variety of contextual factors on successful scale-up and to articulate potential solutions to manage them successfully. The majority of research in this area has focused on similar constructs that predict effective implementation, such as principal support, school climate, and teacher support for the model, and most of these factors have indeed spelled success. The problem is that many schools nationwide do not have these basic structures in place. How can we implement programs in schools with few resources, high principal turnover, and limited support for the models we have developed? Additional research on implementation and dissemination in this area would increase our understanding of successful uptake of these programs in all schools, regardless their immediate resources.

Lack of Resources

Lack of resources, money, and staffing is probably the most common reason that researchers fail to successfully disseminate interventions, curricula, and other empirically based models to schools. It is a key underlying factor that predicts poor uptake and implementation, and it is related to staff turnover, lack of training, lack of principal support, and other critical variables that predict implementation success (Gingiss, Roberts-Gray, & Boerm, 2006; Payne & Eckert, 2010). Many schools are serving growing numbers of students and managing increasing rates of mental

health and behavioral problems with limited financial resources (Stormshak et al., 2011). A diminished staff-to-student ratio can leave school personnel at all levels feeling overworked and undersupported, with little energy or time left to implement family-school partnership interventions. Assets are being depleted in an effort to comply with existing public policy, such as achievement testing and complex teacher and administrative evaluations. Amid financial cutbacks and reductions in funding, many schools struggle to find the administrative focus, support services, class time, or physical space necessary to support additional programs. Family-school interventions may be seen as a luxury rather than a component of student success and well-being (Stormshak et al., 2005). Principals who must cut key staff members often find it politically challenging to prioritize interventions that are considered superfluous by influential stakeholders (Fosco et al., 2014). The overall lack of resources and the increasing numbers of problematic students present substantial barriers to successful implementation and sustainability of school-based prevention and intervention programs.

Finding a balance between the need to sustain all pertinent intervention components and the need to be brief and cost-effective is a potential difficulty in family-school partnership research. Infusion of a multilevel, family-centered approach, that is, a combination of universal, selected, and indicated levels, contributes to the efficient management of resources, in that only those students who are most in need of intensive intervention receive costly services (Stormshak et al., 2011). A tiered design also dovetails more easily with other multilevel education programs, such as PBIS and/or RtI. Programs can be executed gradually to further reduce burden and support school staff who may be overwhelmed by the implementation of a new intervention. This approach can also prove to be more economical. Similarly, when it is not possible for one school staff member to devote the time needed to put the intervention into action, it may become necessary to shift responsibilities to a range of staff members. When this occurs, it is crucial that intervention components be seamlessly integrated into the existing activities of school personnel, so as not to overload already-pressured individuals (Gottfredson & Gottfredson, 2002). Finally, user-friendly and streamlined implementation materials, such as manuals, brochures, and videos, enable school staff to easily accommodate an intervention without expending excessive amounts of time or energy. Materials should offer detailed guidelines and explicit scripts yet remain flexible enough to match the unique needs of individual schools and staff members (Turner & Sanders, 2006). In sum, it is vital that intervention designers and implementers seriously consider each school's available resources because attempts to support expensive and time-consuming programs often result in poor uptake, execution, and sustainability. Research that focuses on adapting programs to fit into existing curricula and services in schools is critical to understanding how to improve uptake in schools with few resources.

In our PFS project, schools in the intervention condition have weathered constant budgetary changes during the course of implementation. Forty-eight percent of the schools experienced a loss in overall operating expenditures per student between the 2007–2008 and 2011–2012 school years. In particular, one relatively small rural school lost more than \$1,500 of operating expenditures per student during this time

period. Expenditure per student for counselor, nurse, and support staff services was reduced in 57 % of PFS intervention schools. A common result has been low teacher and administrator morale brought on by multiple years of job loss, employment insecurity, and turnover. Constant budgetary shortages have also compromised continuity in terms of training, intervention implementation, and staff expectations.

School Staff Training and Experience

While the majority of school staff are involved in education out of genuine concern for children and excel at being student centered, few understand or take into account family contributions to problem behavior (Shirk & Jungbluth, 2008; Stormshak, Connell, & Dishion, 2009). That said, schools are not likely to gather information from parents regarding conditions at home or involve parents in school-based interventions. Furthermore, most school staff are trained according to individual models of development (Stormshak et al., 2005), meaning few individuals working in schools have the knowledge or skills necessary to consistently engage parents in a manner that effectively and positively supports children's academic and behavioral success. Programs that require schools to enact structural changes to accommodate the proactive involvement of parents in school-based student interventions often necessitate a substantial shift in traditional paradigms (Fosco et al., 2014). Such large-scale changes may impede the successful implementation and scale-up of family-school partnership programs. If these changes can be embedded or dovetailed with other successful structural changes, such as PBIS, these impediments may be diminished.

Positive family-school partnership is a key component in the behavioral, mental health, and academic success of students, yet many school staff do not receive training in how to effectively engage parents (Stormshak et al., 2005, 2011). Not only must scientists who are developing and disseminating family-school interventions be cognizant of the need to empower through efficient multilevel program design, but school administrators and teachers must learn how to proactively and positively interact with parents. To begin, implementers should be ready to provide direction, coaching, scaffolding, corrective feedback, and encouragement to school personnel about their interactions with parents (Gottfredson & Gottfredson, 2002). This support opens an important channel of communication between scientists and schools regarding best practices with respect to using family-school partnerships to enhance student success and well-being. It may also be necessary to contextualize parenting skills in terms of school-relevant tasks, such as homework routines and positive behavior support, to overcome resistance and help staff recognize their own expertise in providing parental support (Fosco et al., 2014). Similarly, materials must be available that are concrete, behavioral, and positive in nature (Fosco et al., 2014). Overall, all these exigencies must be addressed to overcome any resistance to altering existing school paradigms whose focus is on individual student development to the exclusion of family participation.

In light of this potential impasse, efficient training in the use of family–school relationships seems necessary to foster positive student outcomes. Research on the most effective means for preparing teachers and school staff to develop constructive relationships is necessary. Essential to that goal is to focus on concrete, behavioral, and positive strategies that are familiar to school staff and therefore are not intimidating (Fosco et al., 2014). Administrators and teachers can be provided with easily accessible and scripted materials (e.g., scaffolding) that strengthen collaboration with parents. Research that examines training in these approaches prior to implementation of family-centered practices in schools would help us understand the importance of this training and content. Finally, if staff appear resistant or fearful of contacting parents, it may be necessary to encourage school administrators to provide incentives to reward attempts at positive parent interactions until staff become fluid in these skills. All these recommended tactics represent fruitful lines of research on professional development in the area of family–school partnerships.

School Leadership

Support and leadership from school principals is a key element in the successful implementation of evidence-based family–school partnership programs. Without it, fidelity is not maintained long enough to fully integrate the program into school policy and routines (Handler et al., 2007; McDougal, Clonan, & Martens, 2000). When factors that predict successful uptake of interventions are studied, principals' support often predicts successful implementation and maintenance of models in schools (Payne, 2008; Payne & Eckert, 2010). Closely involving principals in the training, consultation, implementation, and sustainability of these programs can be difficult in the face of time constraints, limited resources, varying interest levels, and individual differences in leadership ability. Yet, principals are crucial to establishing family–school partnerships as an overarching school norm and holding school staff accountable for maintaining positive collaborations with families. When principals do not consistently advocate for family collaboration, uptake and maintenance of the intervention can be seriously constrained. Persistent administrative turnover presents additional challenges, especially during difficult economic times. In the PFS project, high levels of turnover occurred during the 3 years of the study, with 45 % of schools turning over at least one principal and 20 % of schools hiring a new principal every year of the study. In addition, vice principal turnover occurred at 40 % of schools at least once during the project period. To accomplish buy-in and support for the existing model required quick adjustment to working with new school leadership in the middle of the project.

Gaining the support and buy-in of school principals can be a challenging task. Tremendous demands have been placed on them in this age of achievement accountability, instructional leadership, and federal and state requirements for new, time-consuming teacher evaluation methods. As a result, they may not appreciate additional expectations to foster a family-friendly school culture. Implementation

strategies can be adapted to enhance the adoption of systemic change by those in leadership positions (Turner & Sanders, 2006). Individual consultation and face-to-face time enables implementers to understand and work with the principal's unique leadership style and tailor intervention strategies accordingly (Fosco et al., 2014). With research strongly suggesting that principal support predicts successful uptake, it is critical to consider how to work successfully with schools that have a high leadership turnover. Research that focuses on factors that predict successful uptake under these conditions will be important future work. District-wide support and teacher support may be two ways to ensure that continuity exists in the school despite changes in leadership.

School Climate

The overall school climate can significantly affect the staff's ability to successfully implement evidence-based family-school partnership programs. School climate, defined in the literature in multiple ways, often refers to supportive administration and endorsement of program implementation (Beets et al., 2008). Schools that foster a sense of respect, collaboration, support, and active problem solving at all staffing levels to effectively sustain implementation requirements may be the most successful at long-term uptake of programs (Greenberg, Domitrovich, & Bumbarger, 2001). Constructive and encouraging interpersonal relationships among staff members can promote a sense of community that is critical to promoting positive student outcomes (King & Newmann, 2000). Unfortunately, for a multitude of reasons, such as high turnover rates, poor leadership, staff shortages, and inadequate communication systems, the school climate does not always appear supportive or optimistic. The result may be an absence of collegiality and insufficient motivation to implement the intervention, which can require significant amounts of focus, energy, and openness to change. Poor school climates almost guarantee a lack of buy-in.

Staff members' readiness and motivation to increase collaborative family involvement with the school can be assessed before a partnership intervention is begun. This evaluation helps pinpoint what additional support may be needed and which strategies may be used to increase buy-in by school personnel and ultimately, to facilitate implementation (Gottfredson & Gottfredson, 2002). Particularly in inadequate school climates, it is helpful if implementers work closely with the school's key opinion holders and develop working relationships with administrators and teachers that facilitate positive family-school practices (Stormshak et al., 2005). We have found it necessary for implementers to align the key components of an intervention with the school's current mission (e.g., the family involvement and partnership requirement in federal and state regulations, such as Title 1 and IDEA) and change capacity (Feldstein & Glasgow, 2008). Although it can be quite challenging to implement and sustain family-school interventions in hostile or resistant school climates, implementers may be able to combat some of these difficulties by first prioritizing effective and supportive relationships with staff members at all

levels. Research in this area could broaden the definition of school climate to include factors such as teacher support, parent involvement, and community-level support. These factors may buttress successful uptake of programs in schools.

Critical Events

Critical events are serious incidents at a school that may affect training, implementation, or the program itself. These events are disruptive to the school, learning environment, and overall school climate. When these events occur, leadership are compelled to focus almost entirely on them, and the school enters a “crisis mode” that interrupts learning and programming until the school recovers from the incident. During the course of the PFS project, critical incidents were tracked and documented. The number of incidents was surprising: they occurred in nearly 50 % of schools. Following are examples of some of these incidents that led to disruption of the implementation of the model.

- School A principal was involved in a career-altering motorcycle accident.
- Teacher at School B committed suicide.
- Physical fight between parents occurred in the School C family resource center.
- Several project schools experienced strikes; strikes occurred statewide.
- 204 teachers were laid off in the school district that included two middle schools in the study.
- School E was restructured from sixth to eighth grades to seventh and eighth grades.
- Eighth grader in School F lost a parent in a multiple homicide.
- Teacher at School G died unexpectedly.
- Sixth grader at School H died in a bus accident.

Although some of these crises were disruptive and divisive and caused a setback to positive program implementation, some schools were able to use these crises as a positive opportunity to increase support and collaboration with parents (e.g., using the universal-level family resource center as a safe room for staff, students, and parents). Implementation research has not addressed the issue of critical events. More research is needed in this area to understand the impact that critical events have on schools, their support of students and families, and their ability to continue implementing programs.

Attitude Toward Parents

School staff seldom receive adequate training regarding the influence of family factors on student outcomes or how to include families in student interventions (Stormshak et al., 2005). For example, one of the staff members in the PFS study

completed a school administrator credentialing program that included 10 content areas and 27 modules, yet not one involved families or family factors in education interventions or outcomes. Schools typically attempt to resolve the academic, behavioral, and emotional problems of students with little parent input or communication. As a result, parents tend not to be contacted by school personnel until their child's behavior has gained significant momentum and becomes severe, leaving little opportunity or emotional space to proactively prevent problem behaviors or focus on student and family strengths (Fosco et al., 2014). The unfortunate result is that school staff concentrate on student deficits and offer few opportunities to collaborate with parents; most of the "solutions" that are generated rely on punitive techniques, such as suspension or detention. These approaches tend to disregard the unique context of the family, which in turn reduces the likelihood that solutions will be helpful or sustainable. Given that few school staff receive extensive training in how to effectively collaborate with families, the chance that family-school partnership programs will be implemented is seriously diminished.

Program Integration

Schools may have access to a number of promising intervention programs, yet few possess a map for how to realistically integrate programs into their daily norms and routines (Dishion, 2011). Consequently, schools often feel burdened by their attempts to implement too many individual interventions and may never uptake any particular program to fidelity. School staff can also be wary of new intervention efforts because other daily requirements are seldom reduced to accommodate them, and most often the workload is increased with no commensurate increase in pay. To make matters worse, because few schools are able to sustain evidence-based programs with a high degree of fidelity, program effectiveness is thereby decreased (Durlak & DuPre, 2008), and school staff may not observe positive changes in their students as a result of intervention efforts. Rarely seeing clear and consistent positive student outcomes may reduce the likelihood that schools continue to devote time to applying new interventions. Successful uptake of family-school partnership programs suffers because developing positive, proactive, and collaborative relationships with families is a potentially difficult endeavor and can seem quite distal to student achievement.

To reduce the burden of implementation experienced by schools and potentially increase uptake, program developers must design and test interventions that can easily be integrated into other efforts and existing school structures. There are several ways to address the challenge of increasing the ease of integration and usability of these programs. For example, family-centered interventions that offer a range of services, from brief but effective parent contacts to more intensive involvement, often fit well with referral and intervention systems that already exist in schools (Stormshak et al., 2005). Similarly, family-school partnership programs that offer a menu of empirically supported interventions (e.g., brief-focused consultation, two

to three sessions about a parenting topic, multisession parenting group) that can be accomplished using diverse delivery methods are often accessible to a greater number of families and school personnel (Stormshak & Dishion, 2009). Offering a range of intervention options and multiple delivery methods enables schools to more easily integrate new interventions into their existing routines, thereby increasing the uptake, penetration of families served, and sustainability of family-centered practices. Using a bottom-up collaborative approach to intervention design that recognizes the expertise of school staff enables developers and implementers to successfully integrate intervention efforts and motivate school personnel toward positive change (Cappella, Jackson, Bilal, Hamre, & Soulé, 2011; Shernoff et al., 2011). For example, building on the skill and experiences that schools already possess regarding parent interactions (e.g., a well-attended parent topic night, assignment completion and attendance records proactively provided to parents via technology) can increase buy-in for integrating new methods of family involvement, as well as encourage innovation and risk taking among administrators and teachers. Finally, future research must continue to investigate how schools both struggle and succeed in managing the educational, social, behavioral, and mental health outcomes of students (Dishion, 2011). Such information is pivotal to increased understanding of how to develop, implement, and sustain family–school partnership programs that are meaningful and successful for students, parents, and school staff alike.

Conclusion and Future Research Directions

Research in the area of implementation has been growing during the past decade, and multiple studies have been examining circumstances such as principal support, resources, teacher training, and school climate as primary factors that predict successful uptake and implementation. The challenge is that with declining financial support for schools, research must find a way for programs to be implemented in spite of few resources and for these models to be sustained over time. Molloy, Moore, Trail, Epps, and Hopfer (2013) examined schools that had implemented PBIS to understand factors related to sustaining the model. They found that full implementation was related to reduced rates of problem behavior, which provides meaningful support for the model. Smaller schools, elementary schools, and those with higher SES parents had the best quality implementation; on the other hand, only 37–49 % of schools implemented the model fully. If we can implement programs effectively only in high-SES, well-resourced schools, a nation-wide improvement in family–school partnership and quality of education will not occur. Measures of school capacity are commonly used to evaluate whether schools are “ready” to implement programs with fidelity (Gingiss et al., 2006). This practice eliminates schools that are the most disadvantaged and would most benefit from implementing family-centered practices. Research that focuses on understanding how to implement family-centered programs in schools with few resources and limited stability will be important for the future of implementation science.

The most effective intervention for enhancing family-centered practices in schools may involve training the next generation of teachers in these practices and studying their ability to integrate them as they get their first jobs across the country. Including research and training that enhances the ability of teachers and educators to work with parents will be important for future generations of teachers. Although parent involvement in school has been linked to a multitude of positive student outcomes (Epstein, 1991; Henderson & Berla, 1994; Henderson & Mapp, 2002; Reynolds, 1992), few schools use effective family–school partnership programs (Stormshak & Dishion, 2002). As a result, students may not receive the behavioral, academic, and mental health support they need to be successful in school. It can be challenging to scale-up family–school partnership interventions with a high degree of fidelity because many contextual factors in schools complicate the uptake and maintenance of evidence-based interventions. In particular, successful scale-up requires that programs be simple and flexible to adapt to school environments. Programs must also fit into a school’s culture, daily routines, other change initiatives, and leadership structure so they are not regarded as overbearing and burdensome. For example, multitiered family–school partnerships are successful when they integrate well with existing multitiered strategies already being used to improve academic and developmental outcomes (e.g., RtI, PBIS, Data-based Decision Making). It is recommended that researchers address factors such as dissemination, uptake, implementation, and sustainability by using theoretical frameworks such as Re-Aim (Glasgow, Vogt, & Boles, 1999) or Diffusion of Innovation (Rogers, 2003) throughout the development process rather than at scale-up. Policy changes at the local and state level may also have to be made to help schools successfully uptake and sustain models of prevention (Biglan & Taylor, 2000).

Without doubt, identifying how to increase schools’ effective use of positive family–school partnership practices is worthy of continued investigation and inquiry. By taking into consideration the unique needs, strengths, and constraints of school systems, intervention implementers can bridge the gap between research and practice in natural settings and those with few resources across the country.

Acknowledgment This work was supported by grant R324A09011 from the Institute of Education Sciences to John Seeley (PI) and Thomas Dishion (PI).

References

- Atkins, M. S., Frazier, S. L., Leathers, S. J., Graczyk, P. A., Talbott, E., Jakobsens, L., ... Bell, C. C. (2008). Teacher key opinion leaders and mental health consultation in low-income urban schools. *Journal of Consulting and Clinical Psychology, 76*, 905–908. doi:10.1037/a0013036.
- Barry, T. D., Lyman, R. D., & Grofer Klinger, L. (2002). Academic underachievement and attention-deficit/hyperactivity disorder: The negative impact of symptom severity on school performance. *Journal of School Psychology, 40*, 259–283. doi:10.1016/S0022-4405(02)00100-0.
- Beets, M. W., Flay, B. R., Vuchinich, S., Acock, A. C., Li, K.-K., & Allred, C. (2008). School climate and teachers? Beliefs and attitudes associated with implementation of the positive action program: A diffusion of innovations model. *Prevention Science, 9*(4), 264–275. doi:10.1007/s11121-008-0100-2.

- Biglan, A. (1995). Translating what we know about the context of antisocial behavior into a lower prevalence of such behavior. *Journal of Applied Behavior Analysis*, 28, 479–492. doi:[10.1901/jaba.1995.28-479](https://doi.org/10.1901/jaba.1995.28-479).
- Biglan, A., Sprague, J., & Moore, K. J. (2006). A functional contextualist framework for affecting peer influence practices. In K. A. Dodge, T. J. Dishion, & J. E. Lansford (Eds.), *Deviant peer influences in programs for youth: Problems and solutions* (pp. 342–365). New York, NY: The Guilford Press.
- Biglan, A., & Taylor, T. K. (2000). Increasing the use of science to improve child-rearing. *The Journal of Primary Prevention*, 21, 207–226. doi:[10.1023/A:1007083203280](https://doi.org/10.1023/A:1007083203280).
- Brody, G. H., Flor, D. L., & Gibson, N. M. (1999). Linking maternal efficacy beliefs, developmental goals, parenting practices and child competence in rural single-parent African American families. *Child Development*, 70, 1197–1208. doi:[10.1111/1467-8624.00087](https://doi.org/10.1111/1467-8624.00087).
- Bums, B. J., Costello, E. J., Angold, A., Tweed, D. L., Stangl, D. K., Farmer, E. M. Z., & Erkanli, A. (1995). Children's mental health service use across service sectors. *Health Affairs*, 14, 147–159.
- Cappella, E., Jackson, D. R., Bilal, C., Hamre, B. K., & Soulé, C. (2011). Bridging mental health and education in urban elementary schools: Participatory research to inform intervention development. *School Psychology Review*, 40, 486–508.
- Centers for Disease Control and Prevention. (2013, February 27). Coordinated School Health Program. Retrieved from <http://www.cdc.gov/HealthyYouth/CSHP/>
- Christenson, S. L. (2003). The family–school partnership: An opportunity to promote the learning competence of all students. *School Psychology Quarterly*, 18, 454–482. doi:[10.1521/scpq.18.4.454.26995](https://doi.org/10.1521/scpq.18.4.454.26995).
- Collins, L., Murphy, S., & Bierman, K. (2004). A conceptual framework for adaptive preventive interventions. *Prevention Science*, 5, 185–196. doi:[10.1023/B:PREV.0000037641.26017.00](https://doi.org/10.1023/B:PREV.0000037641.26017.00).
- Connell, A. M., & Dishion, T. J. (2008). Reducing depression among at-risk early adolescents: Three-year effects of a family-centered intervention embedded within schools. *Journal of Family Psychology*, 22, 574–585. doi:[10.1037/0893-3200.22.3.574](https://doi.org/10.1037/0893-3200.22.3.574).
- Connell, A. M., Dishion, T. J., & Deater-Deckard, K. (2006). Variable- and person-centered approaches to the analysis of early adolescent substance use: Linking peer, family, and intervention effects with developmental trajectories [Special Issue]. *Merrill-Palmer Quarterly*, 52, 421–438. doi:[10.1353/mpq.2006.0025](https://doi.org/10.1353/mpq.2006.0025).
- Dishion, T. J. (2011). Promoting academic competence and behavioral health in public schools: A strategy of systemic concatenation of empirically based intervention principles. *School Psychology Review*, 40, 590–597.
- Dishion, T. J., & Kavanagh, K. (2003). *Intervening with adolescent problem behavior: A family-centered approach*. New York, NY: Guilford.
- Dishion, T. J., Nelson, S. E., & Kavanagh, K. (2003). The Family Check-Up with high-risk young adolescents: Preventing early-onset substance use by parent monitoring. *Behavior Therapy*, 34, 553–571. doi:[10.1016/S0005-7894\(03\)80035-7](https://doi.org/10.1016/S0005-7894(03)80035-7).
- Dishion, T. J., & Patterson, G. R. (2006). The development and ecology of antisocial behavior in children and adolescents. In D. Cicchetti & D. J. Cohen (Eds.), *Developmental psychopathology: Vol. 3. Risk, disorder, and adaptation* (pp. 503–541). New York, NY: Wiley.
- Dishion, T. J., Patterson, G. R., Stoolmiller, M., & Skinner, M. (1991). Family, school and behavioral antecedents to early adolescent involvement with antisocial peers. *Developmental Psychology*, 27, 172–180. doi:[10.1037/0012-1649.27.1.172](https://doi.org/10.1037/0012-1649.27.1.172).
- Dishion, T. J., Shaw, D. S., Connell, A. M., Gardner, F., Weaver, C. M., & Wilson, M. N. (2008). The Family Check-Up with high-risk indigent families: Preventing problem behavior by increasing parents' positive behavior support in early childhood. *Child Development*, 79, 1395–1414. doi:[10.1111/j.1467-8624.2008.01195.x](https://doi.org/10.1111/j.1467-8624.2008.01195.x).
- Dishion, T. J., & Stormshak, E. A. (2007). *Intervening in children's lives: An ecological family-centered approach to mental health care*. Washington, DC: American Psychological Association.
- Domitrovich, C. E., Bradshaw, C. P., Poduska, J. M., Hoagwood, K., Buckley, J. A., Olin, S., Romanelli, L. H., ... Jalongo, N. S. (2008). Maximizing the implementation quality of

- evidence-based preventive interventions in schools: A conceptual framework. *Advances in School Mental Health Promotion*, 1, 6–28. doi: [10.1080/1754730X.2008.9715730](https://doi.org/10.1080/1754730X.2008.9715730)
- Domitrovich, C. E., & Greenberg, M. T. (2000). The study of implementation: Current findings from effective programs for school aged children. *Journal of Educational and Psychological Consultation*, 11, 193–222. doi:[10.1207/S1532768XJEPCC1102_04](https://doi.org/10.1207/S1532768XJEPCC1102_04).
- Durlak, J. A., & DuPre, E. P. (2008). Implementation matters: A review of research on the influence of implementation on program outcomes and the factors affecting implementation. *American Journal of Community Psychology*, 41, 327–350. doi:[10.1007/s10464-008-9165-0](https://doi.org/10.1007/s10464-008-9165-0).
- Dusenbury, L., Brannigan, R., Hansen, W. B., Walsh, J., & Falco, M. (2005). Quality of implementation: Developing measures crucial to understanding the diffusion of preventive interventions. *Health Education Research*, 20, 308–313. doi:[10.1093/her/cyg134](https://doi.org/10.1093/her/cyg134).
- Eccles, J. S., & Harold, R. D. (1993). Parent–school involvement during the early adolescent years. *Teachers College Record*, 94, 568–587.
- Eccles, J. S., Lord, S. E., & Roeser, R. W. (1995). Round holes, square pegs, rocky roads, and sore feet: The impact of stage–environment fit on young adolescents’ experiences in schools and families. In D. Cicchetti & S. Toth (Eds.), *Rochester Symposium on Developmental Psychopathology: Vol. VII. Adolescence: Opportunities and challenges* (pp. 47–92). New York, NY: University of Rochester Press.
- Elliott, D. S., & Mihalic, S. (2004). Issues in disseminating and replicating effective prevention programs. *Prevention Science*, 5, 47–53. doi:[10.1023/B:PREV.0000013981.28071.52](https://doi.org/10.1023/B:PREV.0000013981.28071.52).
- Epstein, J. L. (1991). Effects on student achievement of teachers’ practices of parent involvement. *Advances in Reading/Language Research*, 5, 261–276.
- Feldstein, A. C., & Glasgow, R. E. (2008). A practical, robust implementation and sustainability model (PRISM). *Joint Commission Journal on Quality and Patient Safety*, 34, 228–243.
- Forgatch, M. S., Bullock, B. M., & Patterson, G. R. (2004). From theory to practice: Increasing effective parenting through role play. The Oregon Model of Parent Management Training (PMTO). In H. Steiner, K. Chang, J. Lock, & J. Wilson (Eds.), *Handbook of mental health interventions in children and adolescents: An integrated development approach* (pp. 782–813). San Francisco, CA: Jossey–Bass.
- Forgatch, M. S., DeGarmo, D. S., & Beldavs, Z. G. (2005). An efficacious theory-based intervention for stepfamilies. *Behavior Therapy*, 36, 357–365. doi:[10.1016/S0005-7894\(05\)80117-0](https://doi.org/10.1016/S0005-7894(05)80117-0).
- Forman, S. G., Olin, S. S., Hoagwood, K. E., Crowe, M., & Saka, N. (2009). Evidence-based interventions in schools: Developers’ views of implementation barriers and facilitators. *School Mental Health*, 1, 26–36. doi:[10.1007/s12310-008-9002-5](https://doi.org/10.1007/s12310-008-9002-5).
- Fosco, G. M., Dishion, T. J., & Stormshak, E. A. (2012). A public health approach to family-centered prevention of alcohol and drug addiction: A middle school strategy. In H. J. Shaffer, D. A. LaPlante, & S. E. Nelson (Eds.), *The American Psychological Association addiction syndrome handbook* (pp. 225–245). Washington, DC: American Psychological Association.
- Fosco, G. M., Seeley, J. R., Dishion, T. J., Smolkowski, K., Stormshak, E. A., Downey-McCarthy, R., ... Strycker, L. A. (2014). Lesson learned from scaling-up the Ecological Approach to Family Interventions and Treatment (EcoFIT) program in middle schools. In M. Weist, N. Lever, C. Bradshaw, & J. Owens (Eds.), *Handbook of school mental health* (2nd ed.). New York, NY: Springer.
- Galambos, N. L., Barker, E. T., & Almeida, D. M. (2003). Parents do matter: Trajectories of change in externalizing and internalizing problems in early adolescence. *Child Development*, 74, 578–594. doi:[10.1111/1467-8624.7402017](https://doi.org/10.1111/1467-8624.7402017).
- Gingiss, P. M., Roberts-Gray, C., & Boerm, M. (2006). Bridge-It: A system for predicting implementation fidelity for school-based tobacco prevention programs. *Prevention Science*, 7(2), 197–207. doi:[10.1007/s11121-006-0038-1](https://doi.org/10.1007/s11121-006-0038-1).
- Glasgow, R. E., Vogt, T. M., & Boles, S. M. (1999). Evaluating the public health impact of health promotion interventions: the RE-AIM framework. *American Journal of Public Health*, 89, 1322–1327.
- Gottfredson, D. C., & Gottfredson, G. D. (2002). Quality of school-based prevention programs: Results from a nation survey. *Journal of Research on Crime and Delinquency*, 39, 3–35. doi:[10.1177/002242780203900101](https://doi.org/10.1177/002242780203900101).

- Greenberg, M. T., Domitrovich, C., Graczyk, P., & Zins, J. (2001). *The study of implementation in school-based preventive interventions: Theory, research, and practice*. Washington, DC: Center for Mental Health Services, Substance Abuse and Mental Health Administration, U.S. Department of Health and Human Services.
- Greenberg, M. T., Domitrovich, C., & Bumbarger, B. (2001). The prevention of mental disorders in school-aged children: Current state of the field. *Prevention and Treatment, 4*, 1–62. doi:10.1037/1522-3736.4.1.41a.
- Gutman, L. M., & Midgley, C. (2000). The role of protective factors in supporting the academic achievement of poor African American students during the middle school transition. *Journal of Youth and Adolescence, 29*, 233–248. doi:10.1023/A:1005108700243.
- Handler, M. W., Rey, J., Connell, J., Their, K., Feinberg, A., & Putnam, R. (2007). Practical considerations in creating school-wide positive behavior support in public schools. *Psychology in the Schools, 44*, 29–39. doi:10.1002/pits.20203.
- Henderson, A. T., & Berla, N. (1994). *A new generation of evidence: The family is critical to student achievement* (p. 174). Washington, DC: National Committee for Citizens in Education.
- Henderson, A. T., & Mapp, K. L. (2002). *A new wave of evidence: The impact of school, family and community connections on student achievement*. Austin, TX: Southwest Educational Laboratory.
- Hoagwood, K., Bums, B. J., Kiser, L., Ringeisen, H., & Schoenwald, S. K. (2001). Evidence-based practice in child and adolescent mental health services. *Psychiatric Services, 52*, 1179–1189. doi:10.1176/appi.ps.52.9.1179.
- Horner, R. H., Sugai, G., Todd, A. W., & Lewis-Palmer, T. (2005). School-wide positive behavior support. In L. Bambara & L. Kern (Eds.), *Individualized supports for students with problem behaviors: Designing positive behavior plans* (pp. 359–390). New York, NY: Guilford Press.
- Kazdin, A. E. (2002). Psychosocial treatments for conduct disorder in children and adolescents. In P. E. Nathan & J. M. Gorman (Eds.), *A guide to treatments that work* (2nd ed., pp. 57–85). London, United Kingdom: Oxford University Press.
- Kazdin, A. E. (2010). Problem-solving skills training and parent management training for oppositional defiant disorder and conduct disorder. In J. R. Weisz & A. E. Kazdin (Eds.), *Evidence-based psychotherapies for children and adolescents* (pp. 211–226). New York, NY: Guilford Press.
- King, M. B., & Newmann, F. M. (2000). Will teacher learning advance school goals? *Phi Delta Kappan, 81*, 576–580.
- McDougal, J. L., Clonan, S. M., & Martens, B. K. (2000). Using organizational change procedures to promote the acceptability of prereferral intervention services: The School-Based Intervention Team Project. *School Psychology Quarterly, 15*, 149–171. doi:10.1037/h0088783.
- McWayne, C., Hampton, V., Fantuzzo, J., Cohen, H. L., & Sekino, Y. (2004). A multivariate examination of parent involvement and the social and academic competencies of urban kindergarten children. *Psychology in the Schools, 41*, 363–377. doi:10.1002/pits.10163.
- Miedel, W. T., & Reynolds, A. J. (1999). Parent involvement in early intervention for disadvantaged children: Does it matter? *Journal of School Psychology, 37*, 379–402. doi:10.1016/S0022-4405(99)00023-0.
- Miller, W. R., & Rollnick, S. (2002). *Motivational interviewing: Preparing people for change* (2nd ed.). New York, NY: Guilford.
- Molloy, L. E., Moore, J. E., Trail, J., Epps, J. J., & Hopfer, S. (2013). Understanding real-world implementation quality and “active ingredients” of PBIS. *Prevention Science, 14*(6), 593–605. doi:10.1007/s11121-012-0343-9.
- Myers, J., & Nastasi, B. (1999). Primary prevention in school settings. In C. R. Reynolds & T. B. Gutkin (Eds.), *Handbook of school psychology* (3rd ed.). New York, NY: Wiley.
- Patterson, G. R., Capaldi, D., & Bank, L. (1991). An early starter model for predicting delinquency. In D. J. Pepler & K. H. Rubin (Eds.), *The development and treatment of childhood aggression* (pp. 139–168). Hillsdale, NJ: Erlbaum.
- Patterson, G. R., Reid, J. B., & Dishion, T. J. (1992). *A social learning approach: Vol 4. Antisocial boys*. Eugene, OR: Castaglia.

- Payne, A. A. (2008). A multilevel analysis of the relationships among communal school organization, student bonding, and delinquency. *Journal of Research in Crime and Delinquency*, *45*, 429–455. doi:[10.1177/0022427808322621](https://doi.org/10.1177/0022427808322621).
- Payne, A. A., & Eckert, R. (2010). The relative importance of provider, program, school, and community predictors of the implementation quality of school-based prevention programs. *Prevention Science*, *11*, 126–141. doi:[10.1007/s11121-009-0157-6](https://doi.org/10.1007/s11121-009-0157-6).
- Prinz, R. J., & Dumas, J. E. (2004). Prevention of oppositional-defiant disorder and conduct disorder in children and adolescents. In P. Barrett & T. H. Ollendick (Eds.), *Handbook of interventions that work with children and adolescents: From prevention to treatment* (pp. 475–488). Chichester, UK: Wiley.
- Prinz, R. J., & Sanders, M. R. (2007). Adopting a population-level approach to parenting and family support interventions. *Clinical Psychology Review*, *27*, 739–749. doi:[10.1016/j.cpr.2007.01.005](https://doi.org/10.1016/j.cpr.2007.01.005).
- Reynolds, A. J. (1992). Comparing measures of parental involvement and their effects on academic achievement. *Early Childhood Research Quarterly*, *7*, 441–462. doi:[10.1016/0885-2006\(92\)90031-S](https://doi.org/10.1016/0885-2006(92)90031-S).
- Rimm-Kaufman, S. E., & Pianta, R. C. (2000). Patterns of family–school contact in preschool and kindergarten. *School Psychology Review*, *28*, 426–438.
- Ringeisen, H., Henderson, K., & Hoagwood, K. (2003). Context matters: Schools and the “research to practice” gap in children’s mental health. *School Psychology Review*, *32*, 153–168.
- Rogers, E. M. (2003). *Diffusion of Innovations* (5th ed.). New York, NY: Free Press.
- Rumberger, R. W. (1995). Dropping out of middle school: A multilevel analysis of students and schools. *American Educational Research Journal*, *32*, 583–625. doi:[10.2307/1163325](https://doi.org/10.2307/1163325).
- Ryan, R. M., Martin, A., & Brooks-Gunn, J. (2006). Is one good parent good enough? Patterns of mother and father parenting and child cognitive outcomes at 24 and 36 months. *Parenting: Science and Practice*, *6*, 211–228. doi:[10.1207/s15327922par0602&3_5](https://doi.org/10.1207/s15327922par0602&3_5).
- Shaw, M. C. (1986). The prevention of learning and interpersonal problems. *Journal of Counseling and Development*, *64*, 624–627. doi:[10.1002/j.1556-6676.1986.tb01024.x](https://doi.org/10.1002/j.1556-6676.1986.tb01024.x).
- Sheridan, S. M., Knoche, L. L., Kupzyk, K. A., Pope Edwards, C., & Marvin, C. A. (2011). A randomized trial examining the effects of parent engagement on early language and literacy: The Getting Ready intervention. *Journal of School Psychology*, *49*, 361–383. doi:[10.1016/j.jsp.2011.03.001](https://doi.org/10.1016/j.jsp.2011.03.001).
- Shermoff, E. S., Maríñez-Lora, A., Frazier, S. L., Jakobsons, L., Atkins, M. S., & Bonner, D. (2011). Teachers supporting teachers in urban schools: What iterative research designs can teach us. *School Psychology Review*, *40*, 465–485.
- Shirk, S. R., & Jungbluth, N. J. (2008). School-based mental health checkups: Ready for practical action. *Clinical Psychology: Science and Practice*, *5*, 217–223. doi:[10.1111/j.1468-2850.2008.00131.x](https://doi.org/10.1111/j.1468-2850.2008.00131.x).
- Spoth, R. L., Kavanagh, K. A., & Dishion, T. J. (2002). Family-centered preventive intervention science: Toward benefits to larger populations of children, youth, and families. *Prevention Science*, *3*, 145–152. doi:[10.1023/A:1019924615322](https://doi.org/10.1023/A:1019924615322).
- Spoth, R., Trudeau, L., Shin, C., Ralston, E., Redmond, C., Greenberg, M., & Feinberg, M. (2013). Longitudinal effects of universal preventive intervention on prescription drug misuse: Three randomized controlled trials with late adolescents and young adults. *American Journal of Public Health*, *103*, 665–672. doi: [10.2105/AJPH.2012.301209](https://doi.org/10.2105/AJPH.2012.301209).
- Stormshak, E. A., Connell, A. M., Véronneau, M-H., Myers, M. W., Dishion, T. J., Kavanagh, K., & Caruthers, A. S. (2011). An ecological approach to promoting early adolescent mental health and social adaptation: Family-centered intervention in public middle schools. *Child Development*, *82*, 209–225. doi: [10.1111/j.1467-8624.2010.01551.x](https://doi.org/10.1111/j.1467-8624.2010.01551.x).
- Stormshak, E. A., Connell, A. M., & Dishion, T. J. (2009). An adaptive approach to family-centered intervention in schools: Linking intervention engagement to academic outcomes in middle and high school. *Prevention Science*, *10*, 221–235. doi:[10.1007/s11121-009-0131-3](https://doi.org/10.1007/s11121-009-0131-3).
- Stormshak, E. A., & Dishion, T. J. (2002). An ecological approach to child and family clinical and counseling psychology. *Clinical Child and Family Psychology Review*, *5*, 197–215. doi:[10.1023/A:1019647131949](https://doi.org/10.1023/A:1019647131949).

- Stormshak, E. A., & Dishion, T. J. (2009). A school-based, family-centered intervention to prevent substance use: The Family Check-Up. *The American Journal of Drug and Alcohol Abuse*, *35*, 227–232. doi:[10.1080/00952990903005908](https://doi.org/10.1080/00952990903005908).
- Stormshak, E. A., Dishion, T. J., Light, J., & Yasui, M. (2005). Implementing family-centered interventions within the public middle school: Linking service delivery to change in student problem behavior. *Journal of Abnormal Child Psychology*, *33*, 723–733. doi:[10.1007/s10802-005-7650-6](https://doi.org/10.1007/s10802-005-7650-6).
- Stormshak, E. A., Bierman, K. L., McMahon, R. J., Lengua, L., & Conduct Problems Prevention Research Group. (2000). Parenting practices and child disruptive behavior problems in early elementary school. *Journal of Clinical Child Psychology*, *29*, 17–29. doi:[10.1207/S15374424jccp2901_3](https://doi.org/10.1207/S15374424jccp2901_3).
- Stormshak, E. A., Fosco, G. M., & Dishion, T. J. (2010). Implementing interventions with families in schools to increase youth school engagement: The Family Check-Up model. *School Mental Health*, *2*, 82–92. doi:[10.1007/s12310-009-9025-6](https://doi.org/10.1007/s12310-009-9025-6).
- Sugai, G., Horner, R. H., Dunlap, G., Hieneman, M., Lewis, T. J., Nelson, C. M., ... Ruef, M. (2000). Applying positive behavioral support and functional assessment in schools. *Journal of Positive Behavior Interventions*, *2*, 135–141. doi: [10.1177/109830070000200302](https://doi.org/10.1177/109830070000200302)
- Turner, K. M., & Sanders, M. R. (2006). Dissemination of evidence-based parenting and family support strategies: Learning from the Triple P-Positive Parenting Program system approach. *Aggression and Violent Behavior*, *11*, 176–193. doi:[10.1016/j.avb.2005.07.005](https://doi.org/10.1016/j.avb.2005.07.005).
- Van Ryzin, M. J., & Nowicka, P. (2013). Direct and indirect effects of a family-based intervention in early adolescence on parent–youth relationship quality, late adolescent health, and early adult obesity. *Journal of Family*, *27*(1), 106–116. doi:[10.1037/a0031428](https://doi.org/10.1037/a0031428).
- Walker, H. M., Colvin, G. R., & Ramsey, E. R. (1995). *Antisocial behavior in school settings*. Pacific Grove, CA: Brooks/Cole.
- Weist, M. D. (2005). Fulfilling the promise of school-based mental health: Moving toward a public mental health promotion approach. *Journal of Abnormal Child Psychology*, *33*, 735–741. doi:[10.1007/s10802-005-7651-5](https://doi.org/10.1007/s10802-005-7651-5).
- Zubrick, S. R., Silburn, S. R., Garton, A., Burton, P., Dalby, R., Carlton, J., ... Lawrence, D. (1995). Developing health and well-being in the Nineties. *Western Australian Child Health Survey*. Perth, WA, Australia: Australian Bureau of Statistics and the Institute for Child Health Research.

Chapter 3

Moving Beyond Monitoring: A District Leadership Approach to School, Family, and Community Partnerships

Steven B. Sheldon

Schools operate in a highly public, policy-oriented system that is expected to promote learning and skill development for all students. This system relies heavily on external accountability mechanisms and is rooted in the notion that schools and teachers will respond to the rewards and sanctions outlined in government policies (Diamond, 2007; Mintrop & Sunderman, 2009; Spillane, Diamond, et al. 2002). Sanctions, in particular, are the means by which federal and state levels of education bureaucracy exert pressure on educators to change and improve practice (Mintrop & Sunderman, 2009). School districts, then, operate in a unique space because they most closely monitor schools for compliance to state and federal law and they are charged with supporting educators so that schools can meet policy demands and standards.

The limitations of this sanction-based accountability approach are easily found in the research literature about school improvement. Spillane and his colleagues (Spillane, Diamond, et al. 2002), for example, found that while the policy emphasis on standardized test score performance focused teachers' and administrators' attention on testing, it did not necessarily result in changed classroom instruction or improved student performance on these tests. They have argued for the need to study education policy through a "sense-making" perspective recognizing the role of human cognition and agency in the translation of policy to practice. Rewards and sanctions alone, it is clear, do not ensure that policies will be implemented or that they will result in strong academic outcomes.

Individuals are not the only influence on policy implementation. Policies are not only interpreted by the individuals responsible for enacting them (Diamond, 2012), but the impact of policy on instruction "is complex and depends on multiple organizational patterns and dynamics" (p. 155). Diamond found that school structures and organizational patterns are essential to understanding how schools implement policies and programs. These aspects of schools may limit the impact of sanctions on

S.B. Sheldon (✉)

Johns Hopkins University School of Education, Baltimore, MD, USA

e-mail: ssheldon@jhu.edu

educational practice and approaches to school improvement. Thus far, researchers studying the effects of current sanction-based policy approaches have focused on how these policies shape classroom instruction and instructional leadership. There are, however, other aspects of schools and schooling that are impacted by education policy and that contribute to student learning, including instructional leadership, school climate, assessment, and school–family–community partnerships. In particular, school–family–community partnerships represent a key component to successful school improvement.

Focusing on Partnerships

Schools and school districts need to collaborate with and support students' families and communities because of their significant impact on student learning and academic performance. Family involvement and parenting, for example, consistently predicts stronger student outcomes such as higher academic achievement, more regular school attendance, and greater student engagement (Epstein et al., 2010; Henderson & Mapp, 2002; Pomerantz, Moorman, & Litwack, 2007). Looking at school performance through the decentralization reform in Chicago, Bryk and his colleagues found that schools that flourished tended to be characterized by strong relationships with students' families and community (Bryk, Seabring, Allensworth, Luppescu, & Easton, 2010). Their extensive analyses demonstrate that strong, positive school–family–community relationships are an essential element of school improvement. Efforts to improve schools and student achievement need to devote attention to the manner in which schools are communicating and engaging families and to consider these practices an important part of any movement to reform and improve school systems.

For schools' efforts to engage families and community partners to be successful, they need to be coordinated, systematic, and organized. A programmatic and organized approach to school, family, and community partnerships contributes to the ability of these efforts to produce meaningful student and family outcomes (Epstein et al., 2010). Sheldon (2005), for example, showed that schools using an organizational approach that includes teamwork, annual planning, and evaluation tend to conduct stronger outreach to families; and elsewhere found that these schools tend to report higher levels of family involvement at school (Sheldon, 2007a, 2009; Sheldon & Van Voorhis, 2004). Also, compared to schools that are not working to engage families in an organized and systematic manner, those using this organizational framework had greater gains in student daily attendance from 1 year to the next (Sheldon, 2007b). Together these studies illustrate the importance of schools using a programmatic approach to family engagement focused on meeting students' goals.

Schools' approach to family and community engagement is strongly influenced by the surrounding administrative context and community. This chapter focuses on how the context in which schools are embedded shape educators' approach to implementing family and community engagement practices. Specifically, I focus on

the role of the central school district in developing and sustaining school programs for school, family, and community partnerships. I provide a framework from which to understand the different ways central district leaders can promote family engagement in schools. In doing so, this chapter offers a framework that provides practitioners examples of strong district practices. Additionally, the framework provides researchers a starting point from which studies might further develop theoretical and empirical understandings about how districts can help strengthen school–family relationships and, ultimately, student and school outcomes.

Partnership Programs in Schools

Schools that are not intentional about their efforts to engage families will not persist with these efforts and will not engage all families equally (Epstein & Sheldon, 2006). At Johns Hopkins University, the National Network of Partnership Schools (NNPS) has worked with schools and school districts around the United States and internationally to create organized programs of school, family, and community partnerships (see Epstein et al., 2010). Schools are encouraged to implement four organizational components that help embed partnerships into the fabric of schools: Teamwork, Goal-Oriented Plans, Responsive Implementation, and Program Evaluation.

Teamwork

One reason school-based programs for school, family, and community partnerships are not implemented and sustained more widely is because the responsibility of this work often rests with a single individual in a school. In these cases the most likely result is that the partnership work is not school-wide, the person responsible becomes burnt out and leaves after a short time, or both. Instead, school leaders need to establish a committee or team to take ownership of the partnership work and help teachers, staff, and families coordinate their efforts to engage all families and community members.

As a first step in establishing a school-wide partnership program, NNPS recommends that schools form a team dedicated to coordinate the partnership efforts throughout the school—An Action Team for Partnerships (ATP). The ATP members include teachers, school administrators, parents, community members, and, at the high school level, students. To ensure that the partnership efforts at the school reinforce, rather than distract from, other school improvement efforts, at least one member of the ATP should also be a member of the school improvement team or council (SIT). The ATP chair attends SIT meetings and communicates with the school principal, teacher leaders, and the PTO/PTA president about ATP plans and goals. Also, ATPs need parental representation from all groups throughout the school community.

Goal-Oriented Plans

A primary responsibility of the ATP is to construct an annual action plan in the spring that will coordinate, guide, and document the family and community engagement efforts for the following school year. The annual action plan links family and community involvement activities to specific school goals, consistent with those established by the SIT. Action plans that share the same student and school goals as the school improvement plan allow partnership activities to work with other programs at the school. The NNPS encourages ATPs to set two academic goals (e.g., improved reading or math achievement test performance), one non-academic goal (e.g., improved attendance or behavior), and a goal of improving the partnership climate at the school.

For each goal on the action plan, schools can implement a variety of practices that will engage families in their children's schooling in multiple ways. A research-based framework outlines six types of involvement that help create effective school, family, and community partnerships. Schools with comprehensive programs of partnership implement activities encouraging six types of involvement across the four goals:

1. Parenting—helping all families establish supportive home environments for children.
2. Communicating—establishing two-way exchanges about school programs and children's progress.
3. Volunteering—recruiting and organizing parent help at school, home, or other locations.
4. Learning at Home—providing information and ideas to families about how to help students with homework and other curriculum-related materials.
5. Decision Making—having family members serve as representatives and leaders on school committees.
6. Collaborating with the Community—identifying and integrating resources and services from the community to strengthen school programs.

Not every goal needs to have activities planned from each of the six types of involvement, but in general, it is useful for each Action Plan to have at least one activity planned that represents each type of involvement.

Responsive Implementation

Effective family and community engagement activities are responsive and sensitive to the factors that limit family member's participation. Researchers have demonstrated variation in family engagement according to the education levels of the child, educational attainment of the parents, family structure, and language spoken at home (Astone & McLanahan, 1991; Dauber & Epstein, 1993; Eccles & Harold,

1996; Lareau, 2003). Thus, examination of partnership practices within unique contexts is needed to determine necessary modifications such as translation for family members who do not speak English, increased accessibility of materials for those who are not strong readers, transportation and child care to help make programs accessible, and food if an activity is scheduled during mealtime.

In some cases, educators need to adopt a new definition for commonly understood terms related to family involvement. For example, volunteering cannot only mean having family members helping at school, but must also recognize the many ways family members can support the school from home, work, or the neighborhood. Many students have parents who work during the day and cannot volunteer in the traditional sense, but who are nonetheless eager to support the school and their children's education. Thus, it is necessary that volunteer opportunities be available for families outside of school grounds and hours. By recognizing and being responsive to the realities families face, schools can inform and involve parents across racial, educational, and socioeconomic groups.

Evaluation

Finally, school and action team leaders need to conduct on-going and end-of-year evaluations of their partnership program and practices. In the current context of education, whatever gets measured gets done. Evaluating a partnership program, therefore, is essential to the development and sustainability of family engagement efforts. ATP members, by evaluating their partnership program, are able to identify the strengths and weaknesses of their program; demonstrate outcomes from the activities implemented; and send a message that partnerships are valued at the school. Studies demonstrate that partnership programs are more likely to improve and maintain a higher level of quality if the Action Team participates in an end-of-year evaluation of the program, and if feedback is obtained from families participating in family engagement activities (Sheldon, 2007a).

Contextual Influences

Extensive research has been conducted to understand the school-level factors that predict the development of strong partnership programs. Repeatedly, studies have found that partnership programs need the support of the school principal to provide school staff the time, space, and encouragement to reach out and engage families in their children's schooling (Sanders & Harvey, 2002; Sanders & Sheldon, 2009; Sheldon & Van Voorhis, 2004). In this way, school partnership programs are like most other school improvement strategies.

Another important influence on school practices to engage family and community members is the support from the central district offices. Numerous studies show that

schools reporting greater support for partnerships from the district tend to have stronger partnership programs and are better able to sustain those programs (Epstein et al., 2010; Sanders, 2012; Sheldon, 2005, 2007a). Epstein, Galindo, and Sheldon (2011) found district reports of their efforts to promote partnerships in schools corresponded to stronger school reports of program implementation and outreach to families. Also, they found that district facilitation helped predict schools' implementation of practices most responsive to the challenges families face when trying to support their children's schooling. The studies, however, provide little guidance about *how* district personnel can provide that support.

District support has also been shown to be vital to improve classroom instruction. Drawing on organizational and social-learning theories, researchers have explored the ways school district personnel enable school leaders to implement school reform practices to improve teaching and learning (Burch & Spillane, 2004; Honig, 2003, 2006, 2012; Knapp, 2008). This work demonstrates that practices of school district personnel have the ability to improve classroom instruction and shape educators' approaches to using data to improve student achievement.

For educators to improve instruction and student learning, it may be necessary for district personnel to change the nature of their relationship with schools. Historically, and predominantly still, district personnel have maintained a relationship with schools founded on monitoring and oversight (Honig, 2006, 2012). Rather than work with principals or other school leaders, and consistent with the sanction-based policy approach, central district personnel have tended to focus their efforts on ensuring policy compliance. As a result, districts are often perceived to be an additional burden for schools and not a resource to spur school improvement.

In some cases, however, central district personnel have changed the nature of their relationship with school leaders, helping them improve instructional leadership in schools. Studying several of these districts, Honig (2012) was able to categorize specific practices used by district personnel to promote principals' instructional leadership: (1) *Joint Work*—helping principals value their role as instructional leaders at their school, (2) *Differentiation*—providing support to meet the individual needs of principals, (3) *Modeling*—demonstrating practices and meta-cognitive strategies principals can use at their school, (4) *Developing Tools*—providing principals with documents and templates that help guide principals' actions as instructional leaders, and (5) *Brokering*—connecting principals to new information and/or individuals, as well as buffering them from competing demands to help them focus on instructional leadership in their schools. These practices illustrate how the central district offices, moving beyond monitoring, can support school leaders and facilitate practices to help promote strong instruction and student learning. One question that researchers need to explore, however, is the extent to which these types of district practices can be applied to the development of strong school, family, and community relationships; and the degree to which this capacity-building approach to partnerships translates into educational practice and student outcomes.

A District Model of School, Family, and Community Partnerships

Similar to instructional leadership, the district role with regard to school, family, and community partnerships tends to emphasize monitoring over supporting school practices. In working with and researching schools and districts at NNPS, we have discovered that district support and outreach to schools is essential to the development and scale-up of school partnership programs. The NNPS provides a framework to help district personnel understand how to reorient their work and interactions with schools and school leaders. This framework is based on the work by researchers and facilitators who collaborate with and support districts across the United States. Schools and districts that join NNPS follow the research-based approach described above to involve all families in their children's education.

Researchers at NNPS collect an annual UPDATE survey from its members, which measures program implementation and support of school, family, and community partnerships. As stated previously, analyses have shown that schools nested within districts that support the implementation of comprehensive partnership programs receive more and better support from families than schools trying to involve parents without district support (Hutchins & Sheldon, 2013). These findings have spurred greater attention to the work of district personnel and how they can support partnership work in schools.

The UPDATE survey data collected from district leaders show that their practices generally fall under two broad categories: district-level leadership and direct facilitation of schools. *District-level leadership* helps to ensure that home-school collaboration is not siloed but integrated throughout other offices within the district, and that it is coordinated across schools throughout the district. Examples of district-level leadership activities include: reviewing a district policy on family involvement, conducting staff development on partnerships, coordinating a District Advisory Council on family and community involvement, and collecting best practices from schools to share throughout the district. *Direct facilitation of schools* provides support to school and ATP leaders who work to implement comprehensive school, family, and community partnership programs for student success. Examples of facilitation initiatives include: conducting one-day workshops for ATPs, making monthly visits or contacts with school ATPs, scheduling an annual meeting with building principals, and helping ATPs evaluate their programs and progress. Both types of district leadership are important for schools to implement and sustain school, family, and community partnership programs (Epstein et al., 2010).

Studies and fieldwork with diverse districts across the United States indicate six strategies (see Table 3.1) that help district leaders to organize their partnership work: *create awareness, align program and policy, guide learning and program development, share knowledge, celebrate milestones, and document progress and evaluate outcomes* (Epstein, 2008; Epstein et al., 2010). These six objectives weave through the two primary categories of district leaders' work: *district-level leadership* and *direct facilitation* of schools' efforts. Below are examples of activities

Table 3.1 District leadership and direct facilitation strategies

Strategies and goals	District leadership	Direct facilitation
Create awareness		
<i>Goal:</i> to promote partnership program efforts to key stakeholders in the community	District leaders meet with or present to district leaders and colleagues to discuss the goals of the partnership program	District leaders meet with or present to school leaders to discuss the importance and goals of the partnership program. These practices provide information to schools and family about partnership opportunities
Align program and policy		
<i>Goal:</i> to integrate the partnership program with other district policies, requirements and procedures	District partnership leaders work together with colleagues to integrate the partnership program with other district policies, requirements and procedures	District leaders work with school leaders to integrate the partnership program with school goals for students
Guide learning and program development		
<i>Goal:</i> to develop school-based partnership programs by organizing and conducting professional development activities	Conduct training and workshops with district personnel about partnership programs and practices, and their role in school improvement	Conduct training and workshops, as well as on-going professional development, for teachers, school leaders, and ATP members about partnership programs and best practices
Share knowledge		
<i>Goal:</i> to help all stakeholders exchange knowledge with one another and foster ongoing communication	Create opportunities, systems, and tools that allow district leaders the ability to share information, as well as opportunities to talk and collaborate	Share best practices among schools and provide school leaders opportunities to talk and collaborate
Celebrate milestones		
<i>Goal:</i> to recognize progress, efforts, and success and excellence made by district colleagues, school personnel, and community stakeholders	Hosting celebrations, distributing promising practices, or creating a video of selected partnership activities to share with the school board and superintendent	Hosting celebrations for all schools' ATPs, distributing schools' promising partnership practices, or creating a video to share with the media, principals, families, and community groups
Document progress and evaluate outcomes		
<i>Goal:</i> to measure and assess teamwork, family and community engagement outreach and results, as well as the quality of district and school program implementation	Write an annual plan in consultation with leaders from other nearby districts, as well as with leadership personnel from other offices within their own district. Also, collect survey and other data from schools across the data about partnership implementation	Help school and ATP leaders write an annual plan, and use data collection tools that document the implementation and success of partnership practices. Provide opportunities for school leaders to examine these data in light of partnership goals

central district personnel conduct around the six strategies of district leadership and facilitation of schools.¹ These strategies are not mutually exclusive of one another, as one district practice might capture two or more strategies.

Create Awareness

Creating awareness occurs when district personnel are actively promoting the district's partnership program to all key stakeholders, including teachers, administrators, families, and community groups. Activities that create awareness include convening a one-on-one meeting between the district leader for family and community engagement and the district's superintendent to discuss the goals of the partnership program and disseminating a press release announcing the launch of the district's partnership initiative. Creating awareness is an important step to help potential partners understand the district's goals for its partnership program.

District Leadership

Somerset County Public Schools, located in Westover, Maryland, conducts *Coffee and Conversations with the Superintendent*. These casual meetings occur three times a year at each of the district's 10 schools. Originally planned for an hour, the gatherings between the superintendent and parents often last up to 2 hours. Parents talk about any topics—positive or negative—and ask questions. The district's superintendent uses these meetings to help parents understand how they can positively influence their children's education and attitudes toward school. The superintendent also talks about what is happening in the district and the schools. At the end of each session, parents complete an evaluation form to help the district improve the practice in the future.

Direct Facilitation

Many school districts create awareness through monthly newsletters to school personnel. Pasco School District, in Pasco, Washington, disseminates its monthly *ATP Connection* to school leaders and other interested stakeholders. The two-page newsletter has five sections: District News, Spotlight On, Read All About It, Resource Corner, and Important Dates. *ATP Connection* helps Pasco's 19 schools to stay connected, coordinate dates of activities, and share promising practices.

¹The National Network of Partnership Schools solicits examples of promising partnership practices from its members annually. The examples of activities in this section are taken from various collections of *Promising Partnership Practices*. To read the latest edition of *Promising Partnership Practices*, go to www.partnershipschools.org.

The Center of Excellence at Francis Marion University in Florence, South Carolina, also disseminates a monthly newsletter to its schools and districts. Along with sections similar to those in Pasco's newsletter, the Center of Excellence e-newsletter also includes funding opportunities and links to the NNPS monthly e-brief. Regular communication between the district, schools, and community members helps to keep all stakeholders informed about partnership initiatives.

Align Program and Policy

District leaders for partnerships are encouraged to work with other district and school leaders to integrate the partnership program with other district policies, requirements, and procedures. Examples of activities aimed at aligning program and policy include identifying a budget to implement the district's partnership program and developing district policies so that work and progress on family and community involvement is one component of the evaluations of principals and teachers. Aligning program and policy necessitates cross-departmental collaboration.

District Leadership

Francis Howell School District, in Saint Charles, Missouri, aligns program and policy through its District Parent Involvement Advisory group. The group meets three times a year and brings together representatives of partnership programs from the district's 23 schools. Members of the advisory group share promising practices, discuss challenges, and make joint plans. In addition, the district superintendent, chief academic officer, and chief financial officer report on current conditions and answer questions. School board members also participate. District leaders consider the Parent Involvement Advisory meetings crucial to student success, especially in a district small enough for everyone to meet occasionally in one place.

Direct Facilitation

With many states adopting the Common Core, district leaders are developing resources for families to understand how to support student learning at home. St. Paul Public Schools, located in St. Paul, Minnesota, addressed this need through its *Learning Standards for Families* booklets. Teachers in St. Paul volunteered their time and resources to create the booklets, which were then translated from English into Spanish, Hmong, and Somali. The booklets help to meet a number of parent involvement goals, including defining parental roles in supporting the academic standards and promoting consistency across schools and programs in support of the standardized curriculum. The resource also helps to ease the transition between schools for highly mobile students.

Guide Learning and Program Development

Guiding learning and program development involves the district leader organizing and conducting professional development activities to develop school-based partnership programs. Many districts in NNPS conduct an initial one-day action team training and then hold “refresher” courses for new ATP members in the following years or semesters. District leaders may also attend the schools’ monthly ATP meetings and conduct quarterly cluster meetings with ATP chairs or co-chairs. Some districts conduct virtual meetings via Skype or Adobe Connect if they span a large geographic distance.

District Leadership

In Cecil County Public Schools, in Elkton Maryland, the district awards mini-grants to schools to help fund family engagement practices. Schools apply for a mini-grant by mid-June to fund a practice they will implement the following year. The program is sponsored by the Board of Education. The Board expanded the award program after seeing the successful results from year to year. District personnel are responsible for promoting the program to schools, reading proposals and making awards, monitoring the awards, and evaluating the family engagement projects.

Direct Facilitation

Connecticut Technical High School, based in Middletown, Connecticut includes 16 high schools from across the state. District leaders found that even after schools establish Family Engagement Action Teams (FEATs), they benefit from on-going guidance and support. The district conducts a needs assessment survey to help develop customized content for refresher workshops. To accommodate the FEAT members’ busy schedules, the district facilitators offer day-long workshops or shorter sessions on a monthly basis. The interactive workshops help FEATs to refocus and regroup and provide team members with a clear understanding of how they can best serve their school communities.

Naperville Community District 203, in Naperville, Illinois conducts school-specific trainings. With the recent addition of an Early Childhood Center in the district, Naperville district leaders found it necessary to differentiate trainings for newly established and more “advanced” school action teams. Schools in the district requested help from the district about specific challenges they encounter when working with families and the community. The district’s “Core Team” then drew from resources they had collected from prior training workshops, but tailored the material to conduct shorter, individualized sessions with the action team at each school. Naperville’s leaders for partnerships have found that small-group

workshops are valuable for advancing a particular school's partnership program because they are able to address a school's particular questions or challenges.

In addition to more formal trainings, many districts also develop tools to help schools implement and sustain their partnership programs. For example, schools in Pasco, Washington reported the challenge of recruiting and involving ATPs members, particularly parents. In response, district leaders used a quarterly cluster meeting with school partnership leaders to draft ATP members' roles and responsibilities, including chairs, scribes, and time-keepers. District staff also developed a parent job description to help schools recruit parents who would be interested in participating on the ATP. These tools help the district and schools sustain and improve their partnership programs.

Share Knowledge

Districts that are able to sustain their partnership programs often help diverse groups of stakeholders exchange knowledge with one another. This strategy involves fostering ongoing communication throughout the district to build knowledge about practices and programs of school, family, and community partnerships. As with guiding learning and program development, districts share knowledge virtually and through face-to-face interactions.

District Leadership

The Arizona State Parent Information and Resource Center (PIRC), located in Gilbert, Arizona, worked with school sites across the entire state. In order to build a statewide network of partnerships, the PIRC developed a virtual Share Center. The Share Center was an online forum that allowed school leaders in Arizona to share ideas with each other and to access information posted by schools and services from outside the state. Before items are available for public viewing, PIRC staff review the submissions. The Share Center includes a growing catalog of partnership ideas for activities and events, presentations, handouts, newsletters, templates, activities, and other materials.

For many years, Fort Worth Independent School District, located in Fort Worth, Texas, had a Roving Resource Center that served parent liaisons and counselors with a lending library of books and media for use in workshops with parents. To improve the Center, the district found space in a centrally located middle school for a stationary Parent Engagement Outreach Center and can now also serve families directly. In addition to the traditional book and media library, the Center has a "make and take" station where parents gain ideas about how to help their children with learning at home; computer and audio stations; and workshops for parents about nutrition, parenting, college planning, and other important topics.

Direct Facilitation

When facilitating activities that allow school leaders to share knowledge, it is important for district leaders to consider all stakeholders. Partnerships do not just involve teachers and parents. Sharing knowledge also includes other district leaders, community partners, feeder schools, colleges and universities, etc. Casting a wide net for stakeholder support helps districts meet partnership challenges and implement more and better activities to support their schools.

In Naperville Community School District 203, Naperville, Illinois, the district hosted a Lunch Bunch. The event was a relaxed and comfortable way of bringing together the chairs and co-chairs of all schools' partnership teams. The mid-year meeting was organized as a working lunch that provided schools' ATP chairs and co-chairs the opportunity to share progress, describe successes, and solve challenges to strengthen their partnership programs. The team leaders brought their lunches, shared ideas, and asked questions about upcoming activities. The district leaders provided beverages and desserts for the occasion.

Celebrate Milestones

Parents, teachers, administrators, and other partnership stakeholders work hard to implement and evaluate partnership programs, so it is important to recognize school and district efforts and successes. Districts celebrate milestones by hosting an end-of-year celebration for all schools' ATPs, editing and distributing a collection of promising partnership practices, or creating a video of selected partnership activities to share with the school board, principals, community groups, and others. Another important aspect of celebrating milestones is to disseminate the successes widely, whether through local media, websites, newsletters, or even national awards.

District Leadership

Hampton City Schools, in Hampton, Virginia, conducted an annual celebration called "Celebrating our Stars." The purpose of the event is to recognize the exceptional contributions of parents, volunteers, and community partners in all of its Title I schools. Through showing appreciation to those who volunteer in the Title I school community, district leaders hope to keep encouraging these and other school partners to be "Stars" in the education of all Hampton City School students. The district distributes a nomination packet for each school to select nominees. Any parent, guardian, volunteer, or community partners are eligible for recognition. The district then selects three recipients for district-wide recognition. The celebration occurs each May.

Direct Facilitation

Francis Howell School District, in Saint Charles, Missouri, makes sure that celebrations are a community affair. Each year, the district conducts “Howell-a-Palooza” to showcase student work, promote community resources, and strengthen school–community bonds. The first celebration, held in 2008, drew over 5000 people. The event offers an array of activities for all ages, including high school bands performances, choice performances, school showcases, and more than 100 booths featuring community organizations. The annual celebration promotes partnerships within and across the district and promotes family engagement as well as highlights community resources.

Document Progress and Evaluate Outcomes

Evaluation is integral to sustaining home–school collaboration at both the school and district level, yet it is often an overlooked aspect of partnership program implementation. Researchers across the United States have developed surveys to measure school, family, and community collaboration; including topics such as school climate, teacher efficacy, and school outreach (Sheldon & Epstein, 2007a, 2007b). At NNPS, we have learned that it is important for district and school educators to evaluate site-specific partnership activities, and partnership programs as a whole.

District Leadership

Richland School District One, located in Columbia, South Carolina, found an innovative way to gather parent involvement data from its schools. The district developed a family involvement calendar that serves as a way for central office leaders to document the schools’ activities. The purpose of the calendar is to increase K-12 parent involvement and to keep the district office aware of upcoming parent involvement activities. The calendar also includes questions for parents to answer about their involvement, which serves as a way for schools and the district to evaluate collaboration practices. Each month, families who answer and return the calendar question are eligible to win a prize. One winner from each school is chosen.

It is also helpful for district leaders to write an annual action plan in consultation with leaders from other nearby districts, as well as with leadership personnel from other offices within their own district. By creating and recording annual plans, district leaders are able to evaluate their own work, as well as document their accomplishments for others.

Direct Facilitation

Some districts distribute data notebooks for each school to document progress and evaluation outcomes. In Pasco Public Schools, in Pasco Washington, the district leaders created an organizational and record-keeping notebook for each ATP to help the school keep track of its partnership plans and progress. Each binder included the following sections: Training Materials, One-Year Action Plan, Meeting Minutes, Newsletters, ATP Contact Information, Resources (Help!), Evaluation Tools and Correspondence & Miscellaneous. At the end of each year, the district collects the binders and assesses the progress on school, family, and community partnerships at each school. They also prepare the binder for the next year, adding and updating information for the new and returning ATP members.

Next Steps for Research

Research shows that high-quality classroom instruction and positive school–family relationships are essential to developing strong schools (Bryk et al., 2010). District personnel have an important role in helping school leaders realize both of these school qualities (Honig, 2012; Sanders, 2009, 2012). The district framework and accompanying examples presented in this chapter are based on NNPS’ work with district leaders across the United States, and they are consistent with the existing literature (Honig, 2012) about how district leaders facilitate instructional leadership in schools. As with instructional leadership, partnerships strengthen when district leaders move away from a model where they function as policy monitors to one where they become active resources for principals, teacher leaders, and families.

The examples outlined above are not a comprehensive list of possible activities central district personnel can implement to promote school, family, and community partnership programs. Also, any of the examples may not be appropriate across all district contexts. They do, however, provide insight into how district personnel working with NNPS are currently leading district-level leadership initiatives to develop, improve, and sustain programmatic approaches to family and community engagement in schools. Furthermore, the range of examples demonstrate that at least some form of district leadership for partnerships can be done in large or small districts, as well as those located in urban, suburban, or rural areas.

The district framework presented, while used in some studies, requires additional investigation and research. Epstein et al. (2011) found that district reports of leadership and facilitation practices predicted school ratings of partnership program quality; however, studies have not explored how the six strategies are related to program or academic outcomes in schools. It is likely that some strategies are more strongly associated with program development for schools in the start-up phase, while others may be most effective for schools with more experience. Additional studies are needed to clarify these relationships.

Studies are also needed that explore the impact of this district approach to family and community engagement on principals and other school leaders. Because school principals are so important to the implementation of school, family, and community partnership programs (Sanders & Sheldon, 2009), understanding how district leadership shapes principal leadership within schools is vital. This research might adopt a cognitive or interpretive framework (Spillane, Diamond, et al. 2002; Spillane, Reiser & Reimer, 2002) to study whether and how school leaders change their beliefs and practices related to the engagement of family and community members in student learning through district facilitation of partnership programs. An interpretive framework approach would not only examine district leaders' work, but may help uncover how school leaders are making sense and implementing family engagement practices in light of that district support.

In addition to examining how district leadership and facilitation for partnerships affect school leader attitudes and behaviors, studies are needed to understand how organizational dynamics within schools promote the development of strong school, family, and community partnerships. In particular, studies might examine how district leaders can use the social networks among educators to promote the diffusion of partnership efforts by teachers and develop a school climate supportive of partnerships. Teachers' social networks have been shown to affect their implementation of instructional practices and adoption of technology (Diamond, 2012; Frank, Zhao, & Borman, 2004); however, how teachers' formal and informal interactions shape their attitudes and practice toward students' families requires additional research.

Additional District-Level Research

To more fully understand the impact of school districts on family and community engagement, studies are needed that look at ways in which districts are engaging families directly. Currently, many school districts implement a parent education/leadership training course hoping to engage families in their children's school or learning at home. These workshops, sometimes called Parent Universities, are aimed at educating family members about child development and the school system, as well as empowering them to advocate for their children at home and at school (Henderson, 2010). Recently, the Harvard Family Research Project reported that over 140 parent university groups exist across the United States (<http://www.hfrp.org/hfrp-news/news-announcements/parent-university-network> retrieved on May 27, 2014). Very few studies, however, have examined the extent to which these empowerment programs are motivating family members to become involved as leaders at their children's school, district, or in city governance. As this form of direct district engagement with families extends to more and more locales, better research is needed to understand the extent to which these efforts are associated with family, student, and school outcomes.

Also, increasingly central district offices are collaborating with community organizations to support students and families. Some important research has begun to explore the nature and potential of district-community collaborations, demonstrating

the benefits of these relationships. For example, in their book, *A Match on Dry Grass*, Warren and Mapp (2011) provide examples of how community organizing groups have worked with schools and districts to promote equity and student achievement in districts across the country. Similarly, Sanders (2009) showed how community groups can work with and support districts to maintain an emphasis on family and community engagement. These studies, however, have not attempted to look at the impact of district-community collaborations on family engagement at home or at the school, nor has there been research connecting these efforts to school or student outcomes.

Across districts, increasing emphasis is being placed on using data and data-driven processes to improve classroom instruction and student outcomes. District offices are using early warning indicators such as attendance, behavior, and course credits to identify those students most at risk of dropping out (Allensworth & Easton, 2007; Mac Iver & Messel, 2013). Being at risk, however, does not mean that a student cannot succeed in school. Mac Iver and Messel (2013) found that eighth graders who exhibited an early warning indicator but who, then, did not in ninth grade were as likely to graduate as students who never exhibited an early warning indicator. Combining district or school practices of family and community engagement with this data-driven educational approach, however, has not been attempted and represents an important method by which schools and district offices can collaborate to improve student outcomes like attendance, behavior, grades, and graduation rates.

Finally, in addition to basic research on the impact of district strategies on schools, researchers are encouraged to investigate the effectiveness of specific practices and strategies across districts. Studies are needed, for example, that investigate whether and which practices within the six strategies are most effective for rural, large urban, and/or suburban districts; which are more or less effective for districts with varying degrees of racial or ethnic heterogeneity; and which strategies are most effective for districts with high percentages of immigrant families. These types of studies would significantly help district leaders choose practices most likely to succeed in their community.

Conclusions

It is clear that without on-going support from school district personnel, school leaders will struggle to develop and maintain strong programs of school, family, and community partnerships. In presenting the framework of district strategies, I offer methods for structuring partnership work in applied settings and add to policymakers' understandings about the role of district leadership for school reform and improvement. Most importantly, perhaps, I argue for the need to expand research into the role of the central district office; studying the impact of district leadership and collaboration among colleagues, facilitation of school programs, and district programs intended to directly empower families. How district personnel construct their work with school leaders around partnerships, moving beyond monitoring, is

also an aspect of education policy and practice that needs greater attention from researchers. District leadership for partnerships is likely to have the greatest impact on whether and how school leaders approach their engagement with families and the community when district personnel operate as an active and supportive resource for schools.

References

- Allensworth, E., & Easton, J. (2007). *What matters for staying on-track and graduating in Chicago public high schools*. Chicago, IL: Consortium on Chicago School Research.
- Astone, N. M., & McLanahan, S. S. (1991). Family structure, parental practices, and high school completion. *American Sociological Review*, *56*, 309–320.
- Bryk, A. S., Seabring, P., Allensworth, E., Luppescu, S., & Easton, J. Q. (2010). *Organizing schools for improvement: Lessons from Chicago*. Chicago, IL: University of Chicago Press.
- Burch, P., & Spillane, J. (2004). *Leading from the middle: Mid-level district staff and instructional improvement*. Chicago, IL: Cross City Campaign for Urban School Reform.
- Dauber, S. L., & Epstein, J. L. (1993). Parents' attitudes and practices of involvement in inner-city elementary and middle schools. In N. Chavkin (Ed.), *Families and schools in a pluralistic society* (pp. 53–71). Albany, NY: SUNY Press.
- Diamond, J. B. (2007). Where the rubber meets the road: Rethinking the connection between high stakes accountability policy and classroom instruction. *Sociology of Education*, *80*, 285–313.
- Diamond, J. B. (2012). Accountability policy, school organization, and classroom practice: Partial recoupling and educational opportunity. *Education and Urban Society*, *44*, 151–182.
- Eccles, J. S., & Harold, R. D. (1996). Family involvement in children's and adolescents' schooling. In A. Bloom & J. F. Dunn (Eds.), *Family-school links: How do they affect educational outcomes?* (pp. 3–34). Mahwah, NJ: Erlbaum.
- Epstein, J. L. (2008). Research meets policy and practice: How are school districts addressing NCLB requirements for parental involvement? In A. R. Sadovnik, J. O'Day, G. Bohrnstedt, & K. Borman (Eds.), *No child left behind and the reduction of the achievement gap: Sociological perspectives on federal educational policy* (pp. 267–279). New York, NY: Routledge.
- Epstein, J. L., Galindo, C. L., & Sheldon, S. B. (2011). Levels of leadership: Effects of district and school leaders on the quality of school programs of family and community involvement. *Educational Administration Quarterly*, *47*, 462–495.
- Epstein, J. L., Sanders, M. G., Sheldon, S. B., Simon, B. S., Salinas, K. C., Jansorn, N. R., ..., Williams, K. J. (2010). *School, family, and community partnerships: Your handbook for action* (3rd ed.). Thousand Oaks, CA: Corwin Press.
- Epstein, J. L., & Sheldon, S. B. (2006). Moving forward: Ideas for research on school, family, and community partnerships. In C. F. Conrad & R. Serlin (Eds.), *SAGE handbook for research in education: Engaging ideas and enriching inquiry* (pp. 117–137). Thousand Oaks, CA: Sage.
- Frank, K. A., Zhao, Y., & Borman, K. (2004). Social capital and the diffusion of innovations within organizations: Application to the implementation of computer technology in schools. *Sociology of Education*, *77*, 148–171.
- Henderson, A. T. (2010). *Building local leadership for change: A national can of parent leadership training programs*. Providence, RI: Annenberg Institute for School Reform at Brown University.
- Henderson, A. T., & Mapp, K. L. (2002). *A new wave of evidence: The impact of school, family, and community connections on student achievement*. Austin, TX: Southwest Educational Development Laboratory.
- Honig, M. I. (2003). Building policy from practice: District central office administrators' roles and capacity for implementing collaborative education policy. *Educational Administration Quarterly*, *39*, 292–338.

- Honig, M. I. (2006). Street-level bureaucracy revisited: Frontline district central office administrators as boundary spanners in education policy implementation. *Educational Evaluation and Policy Analysis*, 28, 357–383.
- Honig, M. I. (2012). District central office leadership as teaching: How central office administrators support principals' development as instructional leaders. *Educational Administration Quarterly*, 48, 733–774.
- Hutchins, D. J., & Sheldon, S. B. (2013). *Summary 2012 school data*. Baltimore, MD: National Network of Partnership Schools at Johns Hopkins University.
- Knapp, M. S. (2008). How can organizational and sociocultural learning theories shed light on district instructional reform? *American Journal of Education*, 114, 521–539.
- Lareau, A. (2003). *Unequal childhoods: Class, race, and family life*. Berkeley, CA: University of California Press.
- Mac Iver, M. A., & Messel, M. (2013). The ABCs of keeping on track to graduation: Research findings from Baltimore. *Journal of Education for Students Placed at Risk*, 18, 50–67.
- Mintrop, H., & Sunderman, G. L. (2009). Predictable failure of federal sanction-driven accountability for school improvement and why we maintain it anyway. *Educational Researcher*, 38, 355–364.
- Pomerantz, E. M., Moorman, E. A., & Litwack, S. D. (2007). The how, whom, and why of parents' involvement in children's schooling: More is not necessarily better. *Review of Educational Research*, 77, 373–410.
- Sanders, M. G. (2009). Collaborating for change: How an urban school district and a community-based organization support and sustain school, family, and community partnerships. *Teachers College Record*, 111, 1693–1712.
- Sanders, M. G. (2012). Sustaining programs of school, family, and community partnerships: A qualitative longitudinal study of two districts. *Educational Policy*, 26, 845–869.
- Sanders, M. G., & Harvey, A. (2002). Beyond the school walls: A case study of principal leadership for school–community collaboration. *Teachers College Record*, 104, 1345–1368.
- Sanders, M. G. & Sheldon, S. B. (2009). *Principals Matter: A Guide to School, Family, and Community Partnerships*. Thousand Oaks, CA: Corwin Press.
- Sheldon, S. B. (2005). Testing a structural equation model of partnership program implementation and parent involvement. *The Elementary School Journal*, 106, 171–187.
- Sheldon, S. B. (2007a). Improving student attendance with a school-wide approach to school–family–community partnerships. *Journal of Educational Research*, 100, 267–275.
- Sheldon, S. B. (2007b). Getting families involved with NCLB: Factors affecting schools' enactment of federal policy. In A. R. Sadovnik, J. O'Day, G. Bohrnstedt, & K. Borman (Eds.), *No child left behind and the reduction of the achievement gap: Sociological perspectives on federal educational policy*. New York, NY: Routledge.
- Sheldon, S. B. (2009). Using evaluation to prove and improve the quality of partnership programmes in schools. In R. Deslandes (Ed.), *International perspectives on contexts, communities and evaluated innovative practices: Family-school-community partnerships* (pp. 126–142). New York, NY: Routledge.
- Sheldon, S. B. & Epstein, J. L. (2007a). Elementary and Middle School Family and Community Involvement Surveys: Student Questionnaires. Report from the Center on School, Family, and Community Partnerships. Johns Hopkins University: Baltimore, MD.
- Sheldon, S. B. & Epstein, J. L. (2007b). Elementary and Middle School Family and Community Involvement Surveys: Parent Questionnaires. Report from the Center on School, Family, and Community Partnerships. Johns Hopkins University: Baltimore, MD.
- Sheldon, S. B., & Van Voorhis, F. L. (2004). Partnership programs in U. S. Schools: Their development and relationship to family involvement outcomes. *School Effectiveness and School Improvement*, 15, 125–148.
- Spillane, J. P., Diamond, J. B., Burch, P., Hallett, T., Jita, L., & Zoltner, J. (2002). Managing in the middle: School leaders and the enactment of accountability policy. *Educational Policy*, 16, 731–762.
- Spillane, J. P., Reiser, B., & Reimer, T. (2002). Policy implementation: A cognitive model. *Review of Educational Research*, 72, 387–431.
- Warren, M. R., & Mapp, K. L. (2011). *A match on dry grass*. New York, NY: Oxford University Press.

Chapter 4

Research Issues to Forward a Policy Agenda in Support of Family–School Partnerships

Lisa L. Knoche

Introduction

A primary objective of the research being conducted by family–school partnership scholars is to promote the health and well-being of children and their families and diminish challenging behaviors that might prevent positive developmental progress. It is through this focus on end-usability that research findings are made relevant for practitioners in field-based educational settings. Translating research to promote change in practice, as discussed in this volume, is one possible mechanism for encouraging healthy outcomes. Changes in educational practice to facilitate family–school partnerships may take place in one school, or in several communities or school districts, and may result from (a) relationships with a research team; (b) a specific desire on the part of the community or school to adopt an approach; or perhaps (c) mandated participation in a given initiative. In these cases, family–school partnership research findings are being used and incorporated to transform practice at local levels or in targeted communities to promote positive outcomes.

Alternatively, the research evidence generated by family–school partnership scholars can be used to affect change in a population of children and/or families more broadly, beyond targeted communities or schools. If the desires or objectives of the researchers are to make more sweeping, large-scale impacts on the well-being of children and families, researchers must look towards using research evidence to inform and influence public policy at local, state, and federal levels of

L.L. Knoche (✉)

Nebraska Center for Research on Children, Youth, Families and Schools,
University of Nebraska-Lincoln, Lincoln, NE, USA
e-mail: lknoche2@unl.edu

government.¹ Broader impacts of family–school partnership research can be realized through policy change.

Opportunities exist at the intersection of research and policy to advance evidence-based practices that have been identified by family–school partnership scholars to promote healthy well-being in children and families. Policy makers and researchers can work collaboratively to incorporate existing research evidence into large-scale, population-based policy efforts intended to support child and family well-being. Using an iterative approach, they can also work jointly to inform a policy-relevant research agenda related to family–school partnerships. However, several factors must be considered by the research community to maximize these opportunities.

The purpose of this chapter is to describe how researchers might interface with various individuals in the policy arena to affect change at a broad, population level. This chapter will (a) describe knowledge utilization by decision makers; (b) suggest an approach for developing a research agenda; (c) identify elements of research that are relevant for influencing and informing policy; and (d) suggest mechanisms for sharing research results and engaging with the policy community.

Knowledge Utilization by Decision Makers

Within the research community, there is general consensus on how research findings are assessed, and how they contribute to future research directions. The intent of family–school partnership research, for example, is to systematically build a knowledge base for understanding behaviors and actions of individuals and schools that contribute to engagement and partnership practices. Researchers are steeped in the intricacies of content related to family–school partnerships. Researchers can commit lengthy periods of time to investigating a single research question. Policy makers, and their intermediaries, are also accessing research, but using it for an alternative purpose. Their intent is not to build a knowledge base, but instead is primarily focused on action. The timeline for policy makers is often swift; information is needed quickly and decisions might be rushed. Given these different orientations, it is worthwhile to first specify policy makers' approach for using research information and detail how information is processed to contribute to policy decisions.

¹Public policy is generally defined as a system of laws, regulatory measures, and funding priorities concerning a given topic put in place by governmental entities to cause action in an effort to achieve some social goal (Smith & Larimer, 2009). Policy makers work in a variety of settings, and include government representatives at all levels of local, state and federal government. Policy makers include individuals such as school board members, city council representatives, administrative leaders within state or federal organizations, and legislators at all levels of government.

Use of Research Data

Examining the ways that research findings might be used by policy makers is a first step in understanding the interface between policy and research (Nutley, Walter, & Davies, 2007; Tseng, 2012). First, information can be used by policy makers for instrumental purposes. That is, research findings are used to directly inform a policy decision. A decision maker might seek out relevant research information and shape his legislation or funding priority according to the available research findings. Information can also be used in a political way to reinforce or refute a given position on a policy-related decision. That is, a policy maker uses the findings from research studies to back up a position she already holds—not to establish a new position, or explore possible options. When used for developing a greater understanding of issues, policy makers are using research conceptually. Research is contributing to the overall perspective of the policy maker on a given topic, but not directly contributing to any action. Finally, the imposed use of research evidence (Weiss, Murphy-Graham, & Birkeland, 2005) is becoming increasingly prevalent as evidence-based practices and programs are being incorporated into many government programs. Policy makers are demanding that evidence be a criterion in determining actions.

For researchers, it is important to understand that research information can and will be used in these different ways. It underscores the importance of providing data in multiple forms, for multiple audiences. Ideally, the research community would like rigorous research evidence to play a foundational role in policy decisions; however, evidence is only one aspect considered by decision makers. There are many competing priorities; policy makers are responsible to key stakeholders and constituent bases with numerous interests and varying goals (Shonkoff, 2000). The current ideological climate is often highly influential; research evidence may contribute little to shape policy decisions (Shonkoff, 2000; Weiss, Murphy-Graham, Petrosino, & Gandhi, 2008).

Affecting Thoughts, Behaviors, and Actions

Understanding how research findings might influence the thoughts, behaviors, and actions of policymakers and their constituents is relevant. Research findings can be influential at the individual/person level, the interpersonal level, and/or at a collective level (Henry & Mark, 2003). At the individual level, research information may cause a change in the thoughts or actions of a single policy maker. At this level, decision makers are likely to imply a “truth test” and a “utility test” to assess research findings; these are considered their frames of reference (Weiss & Bucuvalas, 1980). Decision makers will assess the rigor and reliability of the research findings and determine if they are trustworthy. Decision makers will also assess findings to determine if they suggest feasible change or provide guidance for policy direction. These frames of reference reinforce the value and necessity of high-quality research

to inform policy. At the interpersonal level, change results from interaction among individuals. Data might be shared to influence the behavior of others. For example, one school board member might share research information with another member to affect a discussion on effective school practices. Finally, at the collective level, change in action can also occur within organizations—this is the level at which policy change is likely to occur. A school district, for example, might institute the application of a district-wide drop-out prevention program, or at the federal level, policy-makers might make programs to support parent engagement a funding priority. The levels at which behavior change and action may take place are interdependent (i.e., the conversation between the school board members could in turn contribute to a change in the district's policies). Thus, affecting attitudes and behaviors of individual policy makers is a likely first step for researchers interested in promoting change in the collective.

Collaboration between family–school partnership scholars and policy makers could provide an instructive backdrop for further informing the process by which research evidence is utilized in policy-making contexts. The topic of knowledge utilization has been studied previously (Weiss & Bucuvalas, 1980), but evolution in political ideologies, funding priorities and limitations, and the active involvement of intermediary agencies could certainly affect how information is used for policy making in today's political landscape. Compelling and informative research questions might include the following: What data form is most effective at directly informing policy? What type of research information is likely to yield change in the thoughts, behaviors, and/or actions of individual policymakers? What levels of engagement are needed at the individual level before policy change can occur at the collective level? How can researchers support engagement? While these questions are not exclusive to family–school partnership research, the content area could provide an opportunity to explore these meaningful associations via interdisciplinary partnerships.

Developing a Research Agenda: Establishing Priorities

A research agenda to inform and influence policy may or may not directly align with research emanating from the scientific community. Indeed, compelling, policy-guiding research can result from an iterative process involving both policy makers and practitioners who work alongside researchers to generate a research agenda. The framework of agenda setting is most effective when it is bi-directional—that is the process reflects both “research to policy” *and* “policy to research.” A uni-directional approach where research is “pushed” out to the policy community without their input or desires will not likely be effective at promoting change.

It is customary, and often comfortable, for researchers to serve as “suppliers” of information to the policy and practice communities. In such an approach, researchers are working in a uni-directional capacity. The expectation is that the information being disseminated will be utilized and ultimately influence decisions. Alternatively,

a focus on “demand” (Tseng, 2012)—that is research priorities originating in the policy or practice communities—could be more compelling at generating research results to affect population level changes than information generated exclusively from the perspective of the research community.

The push–pull infrastructure model is designed to enhance knowledge utilization, or the use of research findings, through a focus on demand (Dearing & Kreuter, 2010). In this model, information is “pushed out” by the research community; but in order to be “pulled” in by the practice and policy communities, the information must be wanted and needed. For example, policy makers may be interested in improving school readiness of young children (e.g., positive social-emotional development including a reduction in challenging behaviors). Research is available that supports the use of conjoint behavioral consultation with families and schools to promote these specific child outcomes (Sheridan et al., 2012). In this case, Sheridan et al. can “push” this information out to the policy community; simultaneously, the policy makers will “pull” in the information. If, at the same time, information is being pushed out on effective partnership programs to prevent school drop-out, it would likely not be “pulled” in at this point in time given the current legislative priority. Researchers spend a great deal of time focusing on dissemination efforts; dissemination alone (a push) is not likely to result in change. It is through diffusion, or the pull of disseminated information, that change is likely to occur (Dearing & Kreuter, 2010). An effective partnership approach will balance the push and pull of information to most successfully influence policy change.

To have an ongoing, generative relationship with the policy and practice communities, researchers must spend time in these communities. Researchers must become familiar with the policy making process and priorities of the decision makers. It is sustained relationships with decision makers that contribute to a mutually beneficial and meaningful research agenda. Participation with these communities is not intended to be for the exclusive purpose of policy influence. Rather, the notion is to participate and learn from individuals in other roles so as to conduct enhanced research that will effectively inform gaps in knowledge and promote and support policy decisions concerning family–school partnerships (Granger, 2005).

Conducting Policy-Relevant Research

High-quality research is of primary importance if it is to inform public policy at any governmental level. The same elements of rigor that define high-quality research in academic contexts are also required in policy contexts. In high-quality research, (a) the research questions are well-specified; (b) the study approach is well-designed and executed; (c) the research is grounded in a larger literature base and justified; (d) the data are the best available; and (e) assumptions of the study and findings are clear (RAND, 2011). Indeed, it is not the case that all research is, or should be, relevant for policy decisions. If the intent of the family–school partnership researcher is to inform policy, however, there are particular aspects of the research enterprise

that will strengthen the likelihood of information being influential in a policy arena. These include the need to develop relevant questions, establish strong evidence of effectiveness, replicate findings, and incorporate varied research designs.

Developing Relevant Research Questions

The quality and type of research questions addressed in studies are among the first considerations when research is intended to influence policy. A clear statement about the importance of the work and relevancy to policy is needed from the beginning. Often, the discussion and application of research is relegated to a small section in discussion sections of manuscripts. If one of the intended purposes of the research is to inform policy, its potential utility in this regard should be initially specified (Guerra, Graham, & Tolan, 2011).

Furthermore, researchers are advised to frame research questions around issues that policies can actually address and consider targets that can be regulated through policy change (Huston, 2005). Often, the questions of primary interest to researchers highlight associations between variables. For example, how does the parent-child relationship evolve over a developmental spectrum? Or, what teacher variables predict effective family-school partnerships? These questions, while highly relevant for advancing the understanding of family-school partnerships, are not easily regulated through policy change. Researchers often talk about conditions that promote outcomes; policy makers want to know how to create these conditions. Examples of the types of questions relevant to policy makers include how is an effective parent-child relationship established? Or, how can effective teachers be identified? Policy making is action-oriented and is about change—how would a change in behavior lead to improvement? What would be gained? Associations alone do not provide this type of action-focused information (Huston, 2005).

In research, the focus is often on “what we do not know” and is less likely targeting “what we should do” (Shonkoff, 2000). Researchers tend to be more concerned with issues of internal validity, whereas external validity is of utmost priority for the practice and policy communities. To meet the needs of policy makers, research must attend to organizational or setting level changes that promote or relate to outcomes as opposed to a typical focus on individual differences (Huston, 2005). Fortunately, analytic techniques have been identified and are available to address these contextual variables (see Beretvas, Volume II of this series).

Establishing the Evidence

The randomized controlled trial continues to be considered a gold-standard approach to identify evidence-based programs to be implemented in the field. Data from such trials are commonly referenced and increasingly incorporated into government

initiatives. There are ways, however, that these studies would be enhanced to provide even greater information for policy decisions. First, economic information is a priority element for policy makers. Thus, a focus by researchers on cost, as well as effectiveness, is needed (Guerra et al., 2011; Huston, 2005, 2008). An intervention program might have excellent results, but the cost for implementing the program could prohibit uptake of the program. Policy makers are balancing multiple priorities and cost is essential information in determining decisions. In the same spirit of efficiency, policy makers are interested in thresholds of services associated with desired outcomes. Thresholds concern identifying how much of a given service or program is enough to promote adequate, or expected, change. A focus on thresholds and cost effectiveness helps policy makers identify efficiencies in programming and maximize funding opportunities (Huston, 2005).

Second, attention to issues of fidelity is critically important for understanding program effects. Researchers are often concerned about Type 1 error or detecting an effect when it is not present. Avoiding Type 2 error, however, is also of primary concern (Huston, 2005). Measures of implementation fidelity can provide assurance that an intervention was in fact implemented and that a lack of change in targeted outcomes was a result of program ineffectiveness, and not due to lack of implementation. The field of implementation science provides guidance on effective methods for measuring indicators of implementation fidelity (Halle, Metz, & Martinez-Beck, 2013).

Third, research that identifies and assesses the effectiveness of evidence-based strategies, principles, or practices for use across varying contexts is needed (Guerra et al., 2011). Context is a primary focus of family–school partnership research. Contextual variables describe and differentiate children, families, and schools and help illustrate and understand associations with partnership outcomes. Likewise, context is critical for child and family policy. Complete context descriptions must be collected, analyzed, and reported to improve the chance that evidence-based programs can be appropriately scaled up from efficacy trials. One of the common concerns about evidence-based curricula or programs is that they can be difficult to implement beyond the bounds of the settings in which they were developed and initially tested. Policy makers are interested in supports via programs that can be implemented in their full constituent body. The primary questions that confront family–school partnership researchers revolve around “what works for whom under what conditions” (Tseng, 2012). Researchers must consider mediators and moderators of impact (Guerra et al., 2011; Shonkoff, 2000). Information on how a program operates in the field is of critical importance to decision makers (Dodge, 2011).

Fourth, researchers are advised to consider uptake rates in randomized controlled trials. This is an extension of the recommendation to include context descriptors in all research. The uptake rate is the percentage of participants who agree to engage in a study out of those who are invited to participate. Understanding characteristics and selection factors among children, families, and teachers who opt out of participation in the trial, as well as those who opt in, is relevant and important. Results from research studies are based on subjects who elect to participate in intervention activities; reported findings do not generally consider subjects who opt out of

participation. Given that one goal of policy making is to promote population-level change, program uptake and the manner in which it influences effectiveness is a key point of consideration (Dodge, 2011). When programs are taken to scale, the population will likely have more varied demographic characteristics, needs, and strengths than during initial effectiveness trials. Though this larger group may have been approached during initial efficacy trials, a subset likely participated. Thus, effectiveness of the intervention for this larger, potentially more diverse group, could be minimized when assessed at-scale. Understanding essential characteristics of the participants and non-participants is necessary.

Finally, results of research studies must be presented in socially significant terms to be readily interpreted by non-scientists. Presenting statistically significant results or large effect sizes in the report of study findings is valuable and will be readily consumed by some non-scientists. However, translating these into terms such as percent of population change or reporting gains in outcome measures to illustrate highly relevant findings (e.g., a reduction in the gap of standardized test scores between comparison groups) is more compelling and interpretable for action. Furthermore, this practical translation is likely to improve comprehension and in turn allow findings to be more easily transported to other settings and communicated to other key stakeholders.

Replicating Findings

Evidence resulting from single studies is helpful for informing and advancing the knowledge base of family–school partnership research. Each study independently contributes to a repository of information on effective programs, practices, and behaviors to support positive outcomes. It is this accumulation of consistent evidence that is essential for use in policy decisions (Huston, 2008). Of even greater value is information provided from a multidisciplinary perspective. For example, data from economists and psychologists that illustrate intervention effectiveness in terms of student outcomes, as well as economic impact, across multiple trials, would prove very useful for policy makers. In many instances, findings from studies are inconsistent and may be contradictory. Such a scenario provides an opportunity for researchers to dig deeper into the research and attempt to understand the processes that may be contributing to the variation. However, from a policy making perspective, this scenario is challenging. Inconsistent and contradictory findings violate the desire for a well-specified action plan.

Meta-analysis is a useful methodology for compiling available data on constructs of interest and dealing with conflicting findings. However, for meta-analyses to be of benefit to decision makers, researchers must provide sufficient data on the context in which studies are taking place. Details on location, age of participants, racial/ethnic background, language, education, and other demographic characteristics are essential. Presenting associations and impacts of intervention without adequate contextual detail is of minimal benefit (Weiss et al., 2008).

Incorporating Varied Methodologies

There is a growing consensus in the research community that the use of mixed method designs—including both qualitative and quantitative methodologies—is valuable and important. Different methodologies generate distinct types of data to inform similar research questions. Randomized experimental designs yield information that indicates if a particular program, policy, or intervention resulted in change. Results indicate the amount of change that might be expected, and can even specify the conditions under which these changes occurred. However, such a design in isolation can rarely describe how that change occurred (Guerra et al., 2011; McCall & Green, 2004; Tseng, 2012). Qualitative data can illustrate and describe how participants experienced the intervention. The combination of methodologies provides useful information on intervention effects and process. Additionally, designs that gather effectiveness information from a community sample are also needed (Dodge, 2011). Family–school partnership scholars are encouraged to look towards creative, alternative evaluation designs to assess program effectiveness that consider population-level effects (e.g., use of administrative data).

Mechanisms for Connecting with Policy Community

To influence and inform policy, researchers need to connect with policy makers and affiliated key stakeholders, including intermediary organizations, and build relationships that are essential for information exchange. As a first step, researchers must determine the most appropriate targets or outlets for research findings. Once the information targets are identified and partnerships formed, the connections can provide an opportunity to educate policy makers. Furthermore, this identification allows researchers to tailor dissemination efforts and products to improve understanding and reinforce significance of research findings.

Information Targets

Networks of relationships and connections among individuals guide decision making within the policy arena. As a researcher, it is important to recognize and understand that the interface with decision makers is based on relationships grounded in trust (Tseng, 2012). Frequently, policy makers have developed long-standing, trusting relationships with intermediary agencies or offices and key stakeholders. Given their experience in and connection to the policy community, these individuals can create a necessary bridge between research and policy. Direct relationships with policy makers are effective, but access can sometimes be challenging. There are many groups that have a primary focus on translational efforts. Therefore, one

pathway towards enhancing dissemination efforts and improving the likelihood for influence is through targeted relationships with intermediary agencies and offices that contribute to policy efforts. There are several relevant national organizations that are connected to policy work and also have an interest in family–school partnership issues. A short list of these organizations include the (a) National Community Education Association, (b) National Education Association, (c) National Coalition for Parent Involvement in Education, (d) National Parent Teacher Association, (e) National Center for Children in Poverty (NCCP), and (f) Center for Law and Social Policy (CLASP). This is only a selected few organizations with an interest in this topic. Researchers are advised to give consideration to intermediary groups and individuals at all levels—local, state, and national.

Ensuring that research findings are available to these organizations will enhance the opportunity for research findings to make their way to policy discussions. For example, a guide for policy makers regarding parent engagement from preschool to grade three was recently released by NCCP (Smith, Robbins, Stagman, & Mahur, 2013). This summary document was developed with policy makers as a target audience and includes research findings on parent engagement, promising models to support engagement, examples of policy efforts in several states, and specific policy recommendations related to parent engagement. The authors at NCCP synthesized relevant research to produce this easy-to-read, appealing guide that includes direct calls for policy action. Another example that highlights the work of an intermediary in prompting policy change is that of CLASP, an organization that considers policy solutions for low-income individuals. A recently released report includes a synthesis of relevant research related to parent engagement and also provides targeted policy recommendations and resources for state representatives (Johnson-Staub, 2013). These are two examples of how intermediary organizations have become involved in translating scientific findings into practical and palatable products and solutions for a varied group of key stakeholders. Targeted relationships with intermediaries, therefore, are essential and can prompt and support dialogue between the research, practice, and policy communities.

Opportunities for Education

Partnerships among policy makers, intermediary organizations, and researchers create an educational opportunity for enhancing the knowledge of the policy making community. Through partnerships, researchers can serve as ambassadors to educate policy makers (Phillips, 2005). For research findings to be utilized for instrumental purposes to directly inform policy decisions, policy makers must understand the content of the research results. Researchers are advised to focus on the causal mechanisms and teach policy makers about the science behind family–school partnerships rather than advocating about specific programs or interventions (Shonkoff & Bales, 2011). For example, researchers can inform policy makers about the potential mechanisms by which family–school partnerships can positively enhance

student outcomes; though several programs are available to support partnerships, the most effective conversation would be grounded in basic associations. Once policymakers have an understanding of associations, introducing programs to affect those changes will be more meaningful. An educational approach will be more generative in the long term, and the information will not be discounted if a given intervention or program is not adopted.

Dissemination of Products

Dissemination of research findings across various formats typically occurs as part of the research process. In addition to peer-reviewed journal articles, dissemination products include materials such as briefs, summaries, and/or messaging on social media platforms. Meaningful dissemination procedures recognize the varied consumer audience and provide individualized information to targets. For example, some administrative level decision makers will have deep knowledge in a core content area; other decision makers might be unfamiliar with social or educational science. Tailoring dissemination products for this broad audience is a worthwhile endeavor. Published journal articles, though perhaps used by some intermediary entities, will rarely be utilized by policy makers. Research and policy briefs that highlight key findings will be most useful (Huston, 2005). Research briefs are generally created to summarize research related to policy-relevant issues. Though specific recommendations for policy are not required, the research brief is targeted to issues that could inform policy decisions. Alternatively, the policy brief includes relevant research findings and also includes proposed policy recommendations that are suggested by the evidence. To maximize diffusion and exposure, researchers are advised to target dissemination across all levels of government and varied key stakeholder groups.

Conclusions

For family–school partnership researchers, the objective of research is to improve the well-being of children and families and promote positive outcomes. This can be accomplished by researchers through varied contributions. Researchers can contribute to the knowledge base through ongoing research and scholarly articles. Contributions can also come through direct influences on practice in educational communities. Support for child and family well-being can also be supported through research contributions to affect policy; sometimes this association is direct and in other instances the influence is indirect. High-quality research is a foundational feature for all of these contributions. Family–school partnership researchers must continue to dedicate their time and attention to the conduct of high-quality and rigorous research.

Indeed, not all research is intended or well-suited to directly influence practice or policy. There are important research questions that will advance the field and the knowledge of family–school partnerships, but may not directly affect change in practice or policy. Theoretical advances are necessary and required to build evidence to support the development of interventions and programming. Every study conducted will not have a policy implication and this is acceptable. Recognizing limitations and boundaries of research findings is also important; while researchers are encouraged to focus on external validity, not all studies can or should have this focus.

Multiple roles are available to family–school partnership researchers should they wish to engage in the policy arena. First, researchers can become trusted allies. Taking the time to form relationships with policy makers, or their intermediaries, and providing education on the scientific knowledge base is a valuable contribution. Instrumental knowledge use will not occur if policy makers are ill-informed. Second, as allies, researchers can co-construct a “use- and need-inspired” research agenda that targets action-oriented and change-directed outcomes. Third, family–school partnership researchers can intentionally focus on issues related to context, fidelity, uptake, replication, and mixed methodologies in intervention trials. Finally, researchers can commit to developing dissemination products that will effectively communicate research findings to a varied consumer audience, including policy makers with varying degrees of expertise. Through some or all of these suggested roles, family–school partnership researchers can become active players in the formation of public policy.

References

- Dearing, J., & Kreuter, M. (2010). Designing for diffusion: How can we increase uptake of cancer communication innovations? *Patient Education and Counseling*, *81*, S100–S110. doi:[10.1016/j.pec.2010.10.013](https://doi.org/10.1016/j.pec.2010.10.013).
- Dodge, K. A. (2011). *Context matters in child and family policy*. *Child Development*, *82*, 433–442. doi:[10.1111/j.1467-8624.2010.01565.x](https://doi.org/10.1111/j.1467-8624.2010.01565.x).
- Granger, R. (2005). *Connecting research and practice*. Annual Report Essay, W.T. Grant Foundation.
- Guerra, N. G., Graham, S., & Tolan, P. H. (2011). Raising healthy children: Translating child development research into practice. *Child Development*, *82*, 7–16. doi:[10.1111/j.1467-8624.2010.01537.x](https://doi.org/10.1111/j.1467-8624.2010.01537.x).
- Halle, T. G., Metz, A. J., & Martinez-Beck, I. (Eds.). (2013). *Applying implementation science in early childhood programs and systems*. Baltimore, MD: Paul H. Brookes.
- Henry, G. T., & Mark, M. M. (2003). Beyond use: Understanding evaluation’s influence on attitudes and actions. *American Journal of Evaluation*, *24*, 293–314. doi:[10.1177/109821400302400302](https://doi.org/10.1177/109821400302400302).
- Huston, A. C. (2005). Connecting the science of child development in public policy. *SRCD Social Policy Report*, *19*(4), 3–18.
- Huston, A. C. (2008). From research to policy and back. *Child Development*, *79*, 1–12. doi:[10.1111/j.1467-8624.2007.01107.x](https://doi.org/10.1111/j.1467-8624.2007.01107.x).

- Johnson-Staub, C. (2013). *Charting progress for babies in child care project: Promote family engagement*. Retrieved from http://www.clasp.org/admin/site/babies/make_the_case/files/Promote-Family-Engagement.pdf
- McCall, R. B., & Green, B. L. (2004). Beyond the methodological gold standards of behavioral research: Considerations for practice and policy. *SRCD Social Policy Report*, 18(2), 3–19.
- Nutley, S., Walter, I., & Davies, H. T. O. (2007). *Using evidence: How research can inform public services*. Bristol, UK: Policy Press.
- Phillips, D. A. (2005). Commentary. In A. C. Huston (Ed.), *Connecting the science of child development in public policy*. *SRCD Social Policy Report*, 19(4), 3–18.
- RAND Corporation. (2011). *Standards for high quality research and practice*. Santa Monica, CA: Author.
- Sheridan, S. M., Bovaird, J. A., Glover, T. A., Garbacz, S., Witte, A., & Kwon, K. (2012). A randomized trial examining the effects of conjoint behavioral consultation and the mediating role of the parent-teacher relationship. *School Psychology Review*, 41, 23–46.
- Shonkoff, J. P. (2000). Science, policy, and practice: Three cultures in search of a shared mission. *Child Development*, 82, 181–187. doi:10.1111/1467-8624.00132.
- Shonkoff, J. P., & Bales, S. (2011). Science does not speak for itself: Translating child development research for the public and its policymakers. *Child Development*, 82, 17–32. doi:10.1111/j.1467-8624.2010.01538.x.
- Smith, K. B., & Larimer, C. W. (2009). *The public policy theory primer*. Boulder, CO: Westview Press.
- Smith, S., Robbins, T., Stagman, S., & Mahur, D. (2013). *Parent engagement from preschool through grade 3: A guide for policymakers*. New York, NY: National Center for Children in Poverty.
- Tseng, V. (2012). The uses of research in policy and practice. *SRCD Social Policy Report*, 26(2), 3–16.
- Weiss, C. H., & Bucuvalas, M. J. (1980). Truth tests and utility tests: Decision-makers' frames of reference for social science research. *American Sociological Review*, 45, 302–313.
- Weiss, C. H., Murphy-Graham, E., & Birkeland, S. (2005). An alternate route to policy influence: How evaluations affect D.A.R.E. *American Journal of Evaluation*, 26, 12–29. doi:10.1177/1098214004273337.
- Weiss, C. H., Murphy-Graham, E., Petrosino, A., & Gandhi, A. G. (2008). The Fairy Godmother—and her warts. *American Journal of Evaluation*, 29, 29–47. doi:10.1177/1098214007313742.

Chapter 5

Testing Statistical Moderation in Research on Home–School Partnerships: Establishing the Boundary Conditions

Oi-Man Kwok, MyungHee Im, Jan N. Hughes, Sarah E. Wehrly, and Stephen G. West

Parent academic involvement, as one of the typical forms of home–school partnerships, is generally defined as parents’ work with schools and with their children to benefit their children’s educational outcomes (Hill et al., 2004). Forms of parent academic involvement include help with homework, conversations with children about school, communication with teachers, attendance at school events, volunteer activities at school, and discussions with children about the value of education and their educational plans and aspirations (Epstein & Sanders, 2002; Fan & Chen, 2001; Wong & Hughes, 2006). Although most forms of parent academic involvement are associated with positive outcomes for children’s academic and behavioral functioning, a number of family and child factors moderate the effects of parent academic involvement on children’s outcomes (for review, see Hill & Tyson, 2009).

Statistical moderation refers to the finding of variations in the strength or direction of the effects of some (focal) variables on an outcome variable across subgroups of students who differ on some demographic, behavioral, or other characteristic. A finding that parents’ help with homework is more strongly predictive of their children’s math achievement for parents with higher versus lower levels of educational attainment would be an example of statistical moderation of the effect of parent academic involvement (or home–school relationship) on students’ achievement. By examining “for whom” a particular type of parent academic involvement bestows benefits, statistical moderation establishes the “boundary” conditions for the effect, thus providing a more nuanced understanding of the effects of home–school relationships.

O.-M. Kwok, Ph.D. (✉) • M. Im • J.N. Hughes • S.E. Wehrly
Department of Educational Psychology, Texas A&M University, 4225 TAMU,
College Station, TX 77843-4225, USA
e-mail: omkwok@neo.tamu.edu

S.G. West
Arizona State University, Tempe, AZ, USA

In this chapter, we provide a tutorial on how to test for moderated effects of home–school relationships using different statistical approaches. First, we provide a brief review of current research on moderated effects of home–school relationships to illustrate the theoretical and practical value of statistical testing of moderated effects. Next, with a detailed example, we demonstrate statistical methods to test the moderating effect of a child characteristic (i.e., ADHD symptoms) on home–school relationship. We also discuss some related issues on testing moderation effects such as centering variables and handling missing data to provide guidance to researchers.

Examples of Moderated Effects of Home–School Relationship on Children’s School Adjustment

Demographic Characteristics

An extensive body of research has documented differences in mean levels of parent academic involvement (or home–school relationship) across demographic groups. For example, Eccles and Harold (1996) reported that African American parents reported higher levels of involvement in educational activities at home, whereas European Americans reported higher levels of involvement at school. In addition to differences in the level of parent academic involvement across groups, differences in the magnitude or direction of the effect of parent academic involvement on student outcomes may differ across demographic groups. A number of studies have examined whether child and family demographic characteristics (e.g., gender, racial, or ethnic group membership, family socioeconomic status) moderate the effect of different types of parent academic involvement on student outcomes. For example, although ethnic minority status and lower SES are often correlated, there is evidence that ethnicity and SES have unique effects on parent involvement and on the relation between parent involvement and student outcomes (Hill, 2001; Hill et al., 2004). For example, Hill et al. (2004) found that among low parent education families, parent academic involvement in grade 7 did not predict students’ school behavior problems in grade 8 or school achievement in grade 9. On the other hand, for high parent education families, parent academic involvement in grade 7 predicted students’ improved behavior in grade 8 and academic achievement in grade 9. Gender is another common moderator in parental involvement studies. Although parent involvement generally is beneficial to both boys and girls, gender has been found to moderate the effect of some forms of parent academic involvement on children’s academic and behavioral adjustment. Using a large nationally representative sample, Zhang, Haddad, Torres, and Chen (2011) found that the effect of parent educational aspirations at grade 8 on adolescents’ educational aspirations at grade 12 was stronger for males than females. The authors suggested that these findings may reflect parents placing a stronger emphasis on education for boys.

Child and Family Characteristics

Although many studies have investigated the moderating effects of demographic characteristics on parent involvement, fewer studies have examined the moderating effects of other risk factors, such as child academic or behavioral characteristics or family processes. Children at-risk for educational difficulties based on any risk indicator are more responsive to variations in the quality of the home and school environments (Hamre & Pianta, 2001; Meehan, Hughes, & Cavell, 2003). Parent academic involvement is one such factor that may mitigate the risk of future academic or behavioral problems for students who have academic or behavioral problems early in their school career. Consistent with this reasoning, in a sample of low-income, Spanish-speaking Mexican-American families, the effect of school-based parent academic involvement (e.g., attending classroom open house) on third grade literacy performance was moderated by children's kindergarten literacy skills, such that children with low early literacy skills benefited more from involved parents than did children with higher early literacy skills (Tang, Dearing, & Weiss, 2012). Another study found moderating effects of preschool students' early levels of behavior problems on the association between parent academic involvement and future levels of behavior problems. Specifically, for children with more behavior problems at the beginning of pre-K, high-quality parent-teacher relationships were more strongly associated with decreased behavior problems at the end of pre-K (Serpell & Mashburn, 2012).

Demonstration of Different Approaches to Testing Moderation Effects

The preceding discussion illustrates the importance of investigating child or family factors that may moderate a finding of a main effect of parent involvement on students' academic outcomes. In this section, we demonstrate different approaches to testing moderation effects. First, we provide a snapshot of the current practice of testing moderation effects in mainstream school psychology research. Second, we provide an example of a child behavior characteristic (i.e., hyperactivity) moderating the effect of home-school relationship on children's peer acceptance at school.

Snapshot of Testing Statistical Moderation in Select Journals

We conducted a search of articles published in 2012 in three relevant journals: *Journal of School Psychology*, *Elementary School Journal*, and *Journal of Applied Developmental Psychology*. There were a total of 101 studies published in these three journals in 2012 and 36 (36 %) of them have tested at least one moderation/interaction effect. The percentage of selected studies for testing interaction effects

were 29, 46, and 32 % in *Journal of School Psychology*, *Elementary School Journal*, and *Journal of Applied Developmental Psychology*, respectively. Among the 36 studies, close to one third of them (31 %) have involved multilevel data and analyzed the data with multilevel models. The sample size of these studies ranged from 62 to 33,311. However, only 10 (28 %) out of the 36 studies have reported the actual estimation method and the statistical software used for the analyses. Most importantly, none of these 36 studies used any latent variables techniques (e.g., the use of structural equation models; Brown, 2006; Kline, 2011) or took into account the issue of potential measurement error in their analyses. In other words, all the (observed) variables in the analyses were assumed to have perfect reliability (or no measurement error). The issue of measurement error and the advantage of accounting for measurement error in the analyses are discussed below with a real data demonstration.

Example of Statistical Moderation Using Actual Data

In our example, we test a potential moderation effect of hyperactivity (as the moderator) on the relation between teacher-rated home-school relationship (as the focal variable related to parent academic involvement) and peer acceptance (as the outcome variable). Peer acceptance was selected as the outcome variable based on its noted importance to students' academic engagement and achievement (Buhs, Ladd, & Herald, 2006). Hyperactivity was selected as the moderator variable based on the finding that hyperactive behaviors place a child at risk for low peer acceptance (Ronk, Hund, & Landau, 2011). Thus, a finding that a positive home-school relationship buffers children with hyperactive behaviors from low peer acceptance would suggest the importance of this type of parent involvement for improving social and academic adjustment of students with elevated levels of hyperactive behaviors.

Our demonstration is based on a portion of data from Project Achieve (Hughes & Kwok, 2007) and contained 409 (54 % male) fourth grade children attending one of three school districts (one urban, two small cities) in southeast and central Texas. The ethnic composition of these 409 students was 37 % White, 21 % Black, 38 % Hispanic, and 4 % Other. Children's mean age was 6.56 years ($SD = .35$), and 59 % of participants were identified by school records as eligible for free or reduced lunch. In 45.4 % of households, at least one parent had completed high school. Children's mean Broad Reading and Broad Math age standard scores on the Woodcock Johnson III (Woodcock, McGrew, & Mather, 2001), or the comparable Spanish language test of achievement, the Bateria-III (Muñoz-Sandoval, Woodcock, McGrew, & Mather, 2005) were 97.92 ($SD = 16.25$) for Reading and 101.50 ($SD = 12.56$) for Math. These 409 students were enrolled in 159 classrooms.

Study Measures and Descriptive Statistics

Below we provide more information related to the measures we use in our demonstration.

Home-school relationship: Students' teachers completed the 22-item Teacher Perception of the Home-School Relationship (HSR) Questionnaire (Hughes & Kwok, 2007). Each item is rated on a five-point (1–5) Likert-type scale. Exploratory and confirmatory factor analysis yielded three factors: Teacher-Parent Alliance (8 items), Parent School-Based Involvement (8 items), and Teacher Initiation of Home-School communication. For the current study, only the Teacher-Parent Alliance scale was used (sample item: "I can talk to and be heard by this parent"; the full description of the eight items is presented in Appendix 1). The reliability of this eight-item subscale was .941.

Peer acceptance: In individual interviews at school, all children in the classroom were asked to indicate their liking for each child in the classroom on a five-point scale. Specifically, the interviewer named each child in the classroom and asked the child to point to one of five faces ranging from sad (1 = don't like at all) to happy (5 = like very much). A child's mean peer acceptance score was the average rating received by classmates.

Hyperactivity: We used a modified version of the class play method (Masten, Morrison, & Pelligrini, 1985) to assess peers' perceptions of children's academic, social, and behavioral competencies. Children were asked to name classmates who best fit each of several behavioral descriptors. Children were told they could list as few or as many classmates as they wanted for each descriptor. The hyperactivity item was "Some kids do strange things and make a lot of noise. They bother people who are trying to work." We obtained a child's peer nomination score for hyperactivity by summing all nominations received. Scores were standardized within classrooms. Scores on this item are moderately correlated ($r = .46$) with teacher ratings of hyperactivity (Hill & Hughes, 2007).

The descriptive statistics (i.e., means and standard deviations) and the zero-order correlations of these variables are presented in Table 5.1. The hypothetical model is presented in Fig. 5.1a.

Analysis of Hypothesized Model 1a

Multilevel data are very common in educational studies; for instance, students are often nested within higher level clusters such as classrooms and schools. Given that students from the same classroom share the same environment (e.g., with the same home-room teacher), they are more likely to respond or react in a manner similar to classmates than to children from other classrooms. Hence, the responses of students from the same cluster are likely to *not* be independent from each other, which is a very important assumption (i.e., independent observations) for traditional statistical

Table 5.1 Descriptive statistics and zero-order correlations of the variables used in the demonstration

	1.	2.	3.	4.	5.	6.	7.	8.	9.	10.	11.	12.
<i>Correlations</i>												
1. PA	1.000											
2. HSR	.142	1.000										
3. HA	-.373	-.207	1.000									
4. HSR × HA	.225	.148	-.346	1.000								
5. X1	.066	.893	-.128	.086	1.000							
6. X2	.107	.877	-.130	.069	.803	1.000						
7. X3	.151	.874	-.249	.159	.724	.684	1.000					
8. X4	.070	.847	-.146	.040	.726	.764	.679	1.000				
9. X5	.165	.872	-.218	.165	.716	.708	.854	.681	1.000			
10. X6	.105	.840	-.227	.171	.670	.710	.688	.797	.686	1.000		
11. X7	.068	.830	-.157	.116	.765	.722	.678	.665	.635	.677	1.000	
12. X8	.204	.739	-.139	.173	.641	.579	.580	.494	.593	.511	.515	1.000
<i>Descriptive statistics</i>												
Mean	3.288	.004	.079	-.163	.026	-.184	.034	-.056	.030	.028	.001	.033
SD	.708	.777	1.017	.856	.933	.885	.997	.788	.975	.863	.866	1.055

Underscored correlations were significant at $p < .05$

Note: PA peer acceptance, HSR home-school relationship, HA hyperactivity, X1-X8 Items for HSR (the description of individual item is presented in Appendix 1), SD standard deviation

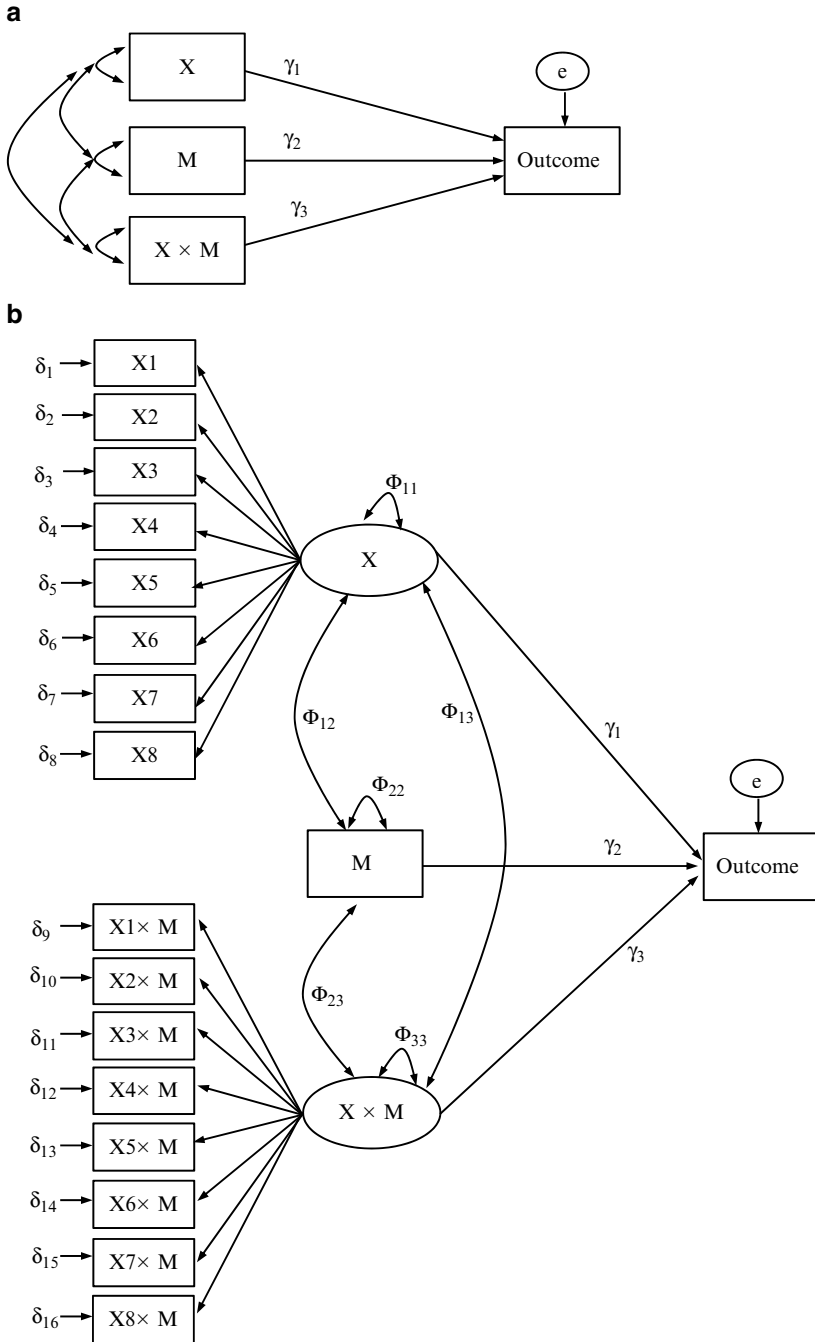

Fig. 5.1 (a) Moderation model with composite scores. *Note.* X (Focal variable): Home-school relationship (HSR); M (Moderator): Hyperactivity as the moderator; Outcome: Peer acceptance. (b) Moderation model with latent factors. *Note.* X : Home-school relationship (HSR); $X1$ – $X8$:

c**d**

Fig. 5.1 (continued) the eight items of the home–school relationship scale; M: Hyperactivity as the moderator; $X \times M$: the interaction effect between home–school relationship and hyperactivity; ($X1 \times M$) to ($X8 \times M$): the eight product indicators between the eight items of HSR scale and the hyperactivity; Outcome: Peer acceptance. (c) Moderation model with the use of the latent moderated structural equations (LMS) approach. *Note.* X: Home–school relationship (HSR); X1–X8: the eight items of the home–school relationship scale; M: Hyperactivity as the moderator; Outcome: Peer acceptance. The interaction effect between X and M is represented by a filled circle. (d) Moderation model with the reliability-adjusted composite score. *Note.* X: Teacher-rated home–school relationship; M: Hyperactivity as the moderator; Outcome: Peer acceptance. Variance of e_x : $V(e_x) = V(X) \times (1 - \rho_{XX})$ where $V(X)$ is the variance of Teacher-rated home–school relationship composite score and ρ_{XX} is the reliability of Teacher-rated home–school relationship (based on the eight-item teacher-rated home–school relationship scale); Variance of $e_{X \times M}$: $V(e_{X \times M}) = V(X \times M) \times (1 - \rho_{(X \times M)(X \times M)})$ where $V(X \times M)$ is the variance of the interaction effect term and $\rho_{(X \times M)(X \times M)}$ is the reliability of the interaction effect term based on Aiken and West’s (1991) equation 8.12 (p. 144)

methods such as the ordinary least squares (OLS) regression. Without adequately taking this dependency issue into account, the standard errors of the parameter estimates can be underestimated, which in turn, can lead to inflated type I error rates and incorrect statistical conclusions.

Given the multilevel structure of our data (with students nested within classrooms), multilevel models (MLMs; Hox, 2010; Raudenbush & Bryk, 2002) are needed to analyze this type of data due to the potential non-independent observations. To examine whether our data were completely independent, we first fit the random intercept model (i.e., a model without any predictors; Raudenbush & Bryk, 2002) to obtain the intra-class correlation (ICC) of the outcome variable, peer acceptance. ICC can be viewed as the average correlation between a pair of observations (students) within a cluster (classroom). The ICC of peer acceptance was .32 which was substantial and further supported the need of using multilevel models for analyzing our data.

We then fit our hypothesized model as shown in Fig. 5.1a with the traditional multilevel models which assume that all the observed variables are perfectly measured. We analyzed our data using the MIXED routine in SPSS (V.22; SPSS Inc., 2013). The corresponding annotated SPSS MIXED syntax for this model is presented in Appendix 2. The restricted maximum likelihood (REML) estimation method was used given that it has been the default estimation method in most of the commonly used multilevel modeling-related programs (e.g., SPSS MIXED, HLM, STATA xtmixed). The parameter estimates are presented in Table 5.2. As shown in Table 5.2, the target interaction effect between teacher-rated home-school relationship (HSR) and hyperactivity was *marginally* significant ($p = .053$) while the two main effects were significant ($p < .05$).

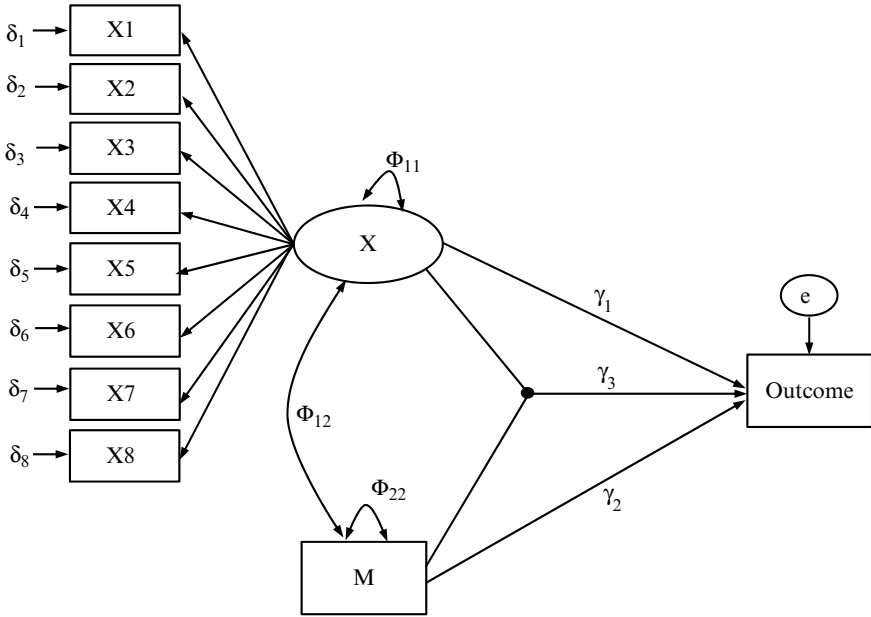
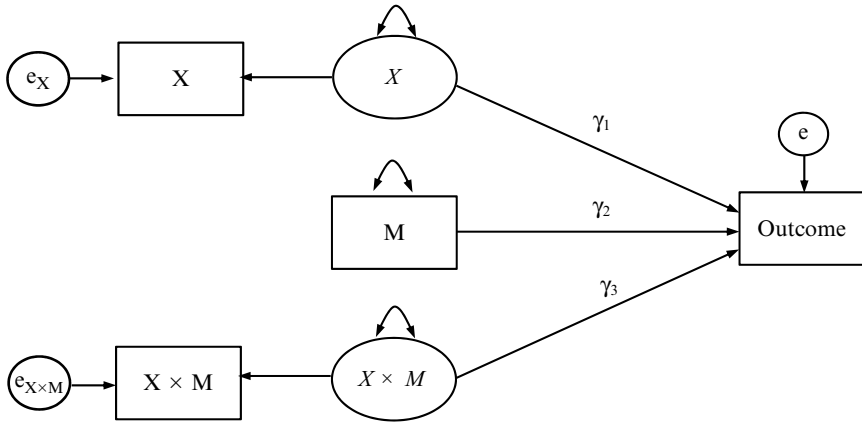
One of the potential causes of the marginal significant effect is the lack of control of the plausible measurement error in the variables. As Aiken and West (1991) pointed out, moderation or interaction effects generally carry relatively low statistical power, and the occurrence of measurement error can further introduce potential bias in the parameter estimates and the corresponding standard errors. There are many potential sources of measurement error in educational studies, including the physical and mental condition of the participants or test takers such as fatigue, the testing situation such as lighting and noisiness, and the instruments such as the wording of items and equipment-related issues. The occurrence of measurement error can sometimes lead to underestimated effects (a.k.a. attenuation due to measurement error). One of the major advantages of using structural equation modeling (SEM) over the traditional approaches such as OLS regression is that SEM can flexibly analyze models with both observed and unobserved/latent variables (or constructs) simultaneously while taking into account the potential measurement error by isolating the corresponding variance out from the model (as the measurement part of the model), thus allowing researchers to directly model the relations among the error-free latent variables (as the structural part of the model) and reduce bias in parameter estimates (Cham, West, Ma, & Aiken, 2012). Following, we will reanalyze the hypothesized model using the structural equation model. Details of how to set up the model and conduct the analysis are described below.

Table 5.2 Summary of the results from different models

Effect	Model 1a			Model 1b ^a			Model 1c ^b			Model 1d		
	Estimate ^c	SE	p value	Estimate ^d	SE ^e	p value	Estimate ^c	SE	p value	Estimate ^d	SE ^e	p value
Intercept	3.321	.044	<.001	3.280	.048	<.001	3.293	.048	<.001	3.280	.049	<.001
Home-school relationship (HSR) $\gamma 1$.084	.038	.029	.051 (.060)	.039 (.045)	.196	.051	.039	.196	.060 (.063)	.041 (.042)	.141
Hyperactivity (HA) $\gamma 2$	-.237	.030	<.001	-.219 (-.312)	.038 (.054)	<.001	-.221	.037	<.001	-.216 (-.303)	.038 (.053)	<.001
HSR \times HA $\gamma 3$.068	.035	.053	.092 (.113)	.044 (.055)	.039	.086	.041	.035	.092 (.106)	.043 (.052)	.035

Note: *Model 1a* Moderation model with observed composite scores and interaction effect only, *Model 1b* Moderation model with latent interaction effect factor, *Model 1c* Moderation model with the use of latent moderated structural equations (LMS) method, *Model 1d* Moderation model with the reliability-adjusted composite scores and interaction effect

^aBased on the modified model with three additional correlated residuals between: product indicators X3 and X5, X3 and X5, and X4 and X6

^bBased on the modified model with two additional correlated residuals between: X3 and X5, and X4 and X6

^cUnstandardized coefficient

^dUnstandardized coefficient (standardized coefficient)

^eSE of the unstandardized coefficient (SE of the standardized coefficient)

Analysis of the Revised Hypothesized Model 1b with the Product-Indicator Approach

One of the commonly used approaches for analyzing models with latent interaction effects is the product-indicator approach (Marsh, Wen, & Hau, 2004; Marsh, Wen, Hau, & Nagengast, 2013), which includes several variations: the constrained approach (Algina & Moulder, 2001; Jöreskog & Yang, 1996; Moulder & Algina, 2002), the partially constrained approach (also named as the generalized appended product-indicator approach; Wall & Amemiya, 2001), and the unconstrained approach (Marsh et al., 2004; Marsh, Wen, & Hau, 2006). As stated in the name (product-indicator approach), all these approaches require the creation of the latent interaction factor(s) by creating the corresponding interaction/product terms from the observed variables. In our real data example, hyperactivity (M) is a single standardized score and the teacher-rated home–school relationship is an eight-item scale. As shown in Fig. 5.1b, the eight indicators of the latent interaction factor ($X \times M$) are the product terms between the standardized hyperactivity score (M) and each of the eight items ($X1$ – $X8$) of the home–school relationship scale.

There are some guidelines on how to create the latent interaction factors when involving two latent factors. For example, suppose that we have two latent factors (F1 and F2) and each latent factor has three items uniquely loaded on it ($X1$, $X2$, and $X3$ exclusively on F1; and $X4$, $X5$, and $X6$ exclusively on F2). As Marsh et al. (2004) pointed out, there is no need to create all possible product terms (in our example, the maximum number of product terms between the indicators of the two latent factors is nine) given that some of the product terms carry overlapping or redundant information. They propose the use of the matched pair product term by pairing up the indicators with similar (standardized) factor loadings. Following our previous example with two latent factors (F1 and F2), suppose that the standardized loadings for the three indicators in F1 are .8 ($X1$), .6 ($X2$), and .4 ($X3$) and the standardized loadings for the three indicators in F2 are .5 ($X4$), .9 ($X5$), and .3 ($X6$). The total number of matched pairs of indicators needed for creating the latent interaction factor ($F1 \times F2$) is three: ($X1 \times X5$), ($X2 \times X4$), and ($X3 \times X6$). When the latent factors carry uneven numbers of indicators (e.g., F1 has six indicators while F2 has four indicators), we only need to create *four* distinctive matched pairs given that pairs with reused indicators will only contain redundant information. In addition to the magnitude of the factor loadings, we can also create the matched pairs based on the actual description/meaning of the indicators. Again, instead of creating all possible pairs, the matched pair approach creates the pairs containing unique information which eases the estimation while yields the optimal results in terms of standard errors and statistical power.

As pointed out previously, there are three different product-indicator approaches, and the commonly used one is the unconstrained approach proposed by Marsh et al. (2004). Compared with the other approaches which require many nonlinear constraints for the interaction latent factor, the unconstrained approach is the one with the simplest specification which only requires imposing a single constraint (i.e., constrain the mean of the interaction latent factor equal to the covariance between

the two main latent factors). Nevertheless, this constraint will not be necessary if the double-mean-centering strategy (Lin, Wen, Marsh, & Lin, 2010) is used. That is, all the observed indicators are mean-centered¹ before creating the product terms, and the product terms are then mean-centered before fitting the model with the latent interaction factor.

We adopted the double-mean-centering strategy to create all the product indicators and fit the model as shown in Fig. 5.1b. As shown in Fig. 5.1b, the indicators of the interaction latent factor ($X \times M$) are from the product terms between the eight items (i.e., X1–X8) of the home–school relationship scale and the standardized hyperactivity score (i.e., M). Given that we used the unconstrained approach with doubly mean-centered variables, nonlinear constraint was not necessary and we did not impose any nonlinear constraints in the model. We have used the Type = Complex routine in Mplus (V7.11; Muthén & Muthén, 1998–2012) which is the model-based approach to analyze multilevel data (Wu & Kwok, 2012). Robust maximum likelihood estimation method (i.e., MLR as the default estimation method under Type = Complex) was used. MLR produces “maximum likelihood parameter estimates with standard errors and a chi-square test statistic that are robust to non-normality and non-independence of observations” (Muthén & Muthén, 1998–2012, p. 603). The corresponding Mplus syntax for this model is presented in Appendix 2.

We first fit the model as shown in Fig. 5.2 but the model did not fit the data well based on the overall model chi-square test and other commonly used fit indices² ($\chi^2(133) = 463.215, p < .001$; RMSEA = .078; CFI = .869), which were off from the generally recommended cutoff values of fit indices (i.e., RMSEA \leq .05 and CFI \geq .95 indicate good fit; Kline, 2011). Based on the modification indices, we then added three correlated residuals: between X3 (parent has shared goals with school) and X5 (similar expectations of child) of the home–school relationship (HSR) scale, between X4 (parent respects teacher) and X6 (teacher respects parent) of the HSR scale, and between the product indicators of ($X3 \times M$) and ($X5 \times M$). Although the overall model chi-square test of the modified model was still significant ($\chi^2(130) = 260.462, p < .001$), the model fit indices did indicate that this modified model fit the data adequately (RMSEA = .050; CFI = .948).

¹Mean-centering of a variable is to subtract each observed value by the corresponding mean of that variable. For example, for X_i , the observed value of the X variable for the i -th person, the mean-centered value for this i -th person is:

$$X_i^* (\text{the mean centered } X_i) = X_i - \bar{X},$$

where \bar{X} is the arithmetic mean of the X variable.

²As Ryu and West (2009) pointed out, the commonly used model fit indices in structural equation modeling (SEM) such as RMSEA and CFI are not sensitive to model misspecifications (especially to between-level misspecifications) in multilevel SEM and the use of these fit indices should be with caution for evaluating multilevel structural models. Nevertheless, Hsu et al. (2015) have taken a further step to evaluate the effectiveness of these fit indices and concluded that the traditional cutoff values based on the single-level SEM (e.g., RMSEA \leq .05 and CFI \geq .95 as good fit) are in general effective on identifying the misspecified models (especially for the within-model misspecifications).

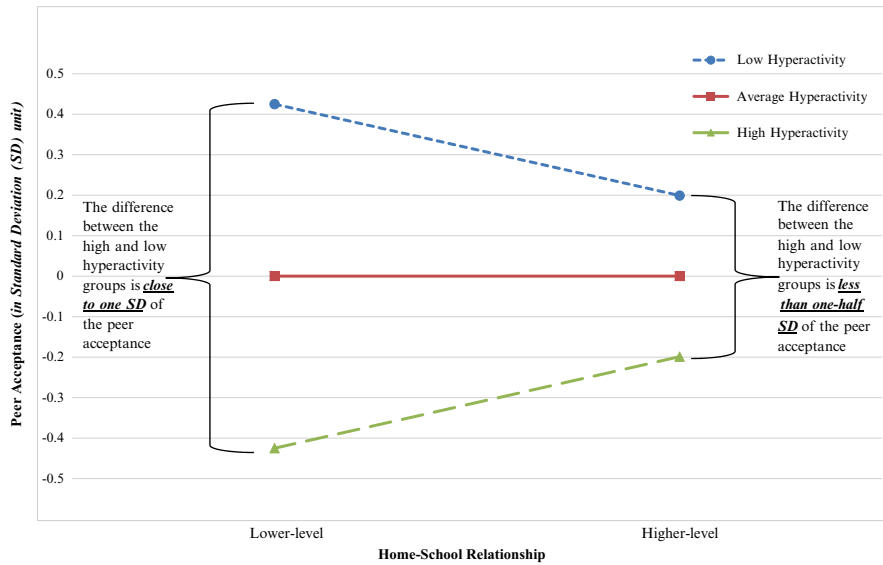

Fig. 5.2 Decomposing the moderation effect of hyperactivity on the relation between home–school relationship and peer acceptance. (a) Single-group approach. (b) Multiple-group approach

For the measurement part of the model (i.e., the latent factors of X and X×M), all the observed indicators and the product terms were significantly loaded on the corresponding latent factors, with standardized loadings ranged from .672 to .901 for the home–school relationship factor (i.e., the X latent factor in Fig. 5.1b) and from .729 to .900 for the interaction latent factor (i.e., the X×M latent factor in Fig. 5.1b). For the structural part of the model, both hyperactivity ($\gamma_2 = -.219, p < .001$) and the interaction effect factor ($\gamma_3 = .092, p = .039$) were statistically significant in predicting peer acceptance whereas home–school relationship was not significant ($\gamma_1 = .051, p = .196$). Specifically, compared with the results in model 1a ($\gamma_3 = .068, p = .053$), the target interaction effect, hyperactivity by home–school relationship, is now statistically significant ($\gamma_3 = .092, p < .05$).

To further understand the interaction effect, we have adopted the Aiken and West’s (1991) approach to decompose the interaction effect by substituting some meaningful values of the moderator to the final model as shown below (also see Table 5.2 model 1b):

$$\widehat{PA} = -.312 HA + .113(HSR \times HA) \tag{5.1}$$

where \widehat{PA} is the predicted peer acceptance (outcome variable), HA is hyperactivity (moderator) and $(HSR \times HA)$ is the home–school relationship (HSR) by hyperactivity interaction effect. HSR (focal variable) is not included in the final model due to the nonsignificant coefficient of the predictor. All the coefficients in (5.1) are standardized based on the completely standardized solution in which all (observed and latent) variables are standardized in the model. Given that hyperactivity is the moderator

which has been mean-centered and completely standardized in (5.1), we can substitute three commonly used values for hyperactivity, including: mean of hyperactivity (i.e., 0; also labeled as the average hyperactivity group in Fig. 5.2), one standard deviation (SD) above the mean of hyperactivity (i.e., 0 (mean)+1 (SD)=1; also labeled as the high hyperactivity group in Fig. 5.2), and one standard deviation below mean of hyperactivity (i.e., 0 (mean)-1 (SD)=-1; also labeled as the low hyperactivity group in Fig. 5.2). Here are the three equations for the three hyperactivity groups:

$$\text{High hyperactivity group : } \widehat{PA} = -.312(1) + .113(\text{HSR} \times 1) = -.312 + .113\text{HSR}$$

$$\text{Average hyperactivity group : } \widehat{PA} = -.312(0) + .113(\text{HSR} \times 0) = 0$$

$$\text{Low hyperactivity group : } \widehat{PA} = -.312(-1) + .113(\text{HSR} \times -1) = .312 - .113\text{HSR}$$

Similarly, given the completely standardized solution, we also use one standard deviation above and below the mean of HSR (i.e., 1 and -1, respectively) as the two anchor points to plot the predicted models as shown in Fig. 5.2. The y-axis in Fig. 5.2 is the outcome variable, peer acceptance, which is in standard deviation unit. The x-axis is the focal variable, the home-school relationship (HSR) with the two anchors: low HSR (i.e., 1SD below the mean HSR) and high HSR (i.e., 1SD above the mean HSR). The three regression lines represent the three different hyperactivity groups. As shown in Fig. 5.2, the low hyperactivity group in general had higher peer acceptance. However, the discrepancy between the high and low hyperactivity groups on peer acceptance is substantially large under the low-level of home-school relationship (close to one standard deviation) whereas this discrepancy becomes smaller (less than half standard deviation) under the high-level home-school relationship condition. Another way to understand this interaction effect is that based on (5.1), hyperactivity has a significant negative effect on peer acceptance, while the significant positive interaction effect indicates that higher positive home-school relationship can buffer the negative effect of hyperactivity on peer acceptance.

In addition to the finding of the significant interaction effect, we wanted to know the effect size (or the magnitude) of this interaction effect. Hence, we fit another model with exactly the same setting except constraining the direct path from the interaction latent factor to peer acceptance to zero (i.e., $\gamma_3=0$). The unstandardized residual variance of peer acceptance of this model is .458 while the same residual variance in the previous model with the significant direct path from the latent interaction factor is .452. With these two residual variance estimates, we can obtain the change in the proportion of the residual variance in peer acceptance due to the addition of the latent interaction factor as below:

$$\begin{aligned} & \text{\% of explained variance} \\ &= \frac{\Psi_{\text{model without interaction factor}} - \Psi_{\text{model with interaction factor}}}{\Psi_{\text{model with interaction factor}}} \times 100\% \\ &= \frac{.458 - .452}{.458} \times 100\% = 1.3\% \end{aligned}$$

where Ψ is the residual variance of the target outcome variable (i.e., peer acceptance in our example). This change in the residual variance is similar to the R -square change in multiple regression models, which can be viewed as the proportion of the variance explained in the outcome variable (i.e., peer acceptance) solely by adding the latent interaction factor. Accordingly, 1.3 % of the variance in peer acceptance has been explained by the latent interaction factor between hyperactivity and home-school relationship. Based on Cohen's (1988) guideline, this (1.3 %) is a small effect size which is quite common (especially for interaction effects) in the social sciences literature.

Analysis of Hypothesized Model 1c with the Distribution-Analytic Approach

Another commonly used approach for analyzing latent interaction effects is the distribution-analytic approaches (Kelava et al., 2011; Marsh et al., 2013; Marsh, Wen, Nagengast, & Hau, 2012), which include: Latent Moderated Structural Equations (LMS; Klein & Moosbrugger, 2000), Quasi-Maximum Likelihood (QML; Klein & Muthén, 2007), and other similar approaches such as marginal maximum likelihood (Cudeck, Harring, & du Toit, 2009). Compared with the product-indicator approaches, the distribution-analytic approaches directly estimate the latent interaction effects by taking the non-normality of the interaction effects into account without creating any product indicators. Both LMS and QML are more commonly discussed than the other distribution-analytic approaches (Kelava et al., 2011; Marsh et al., 2012; Marsh et al., 2013). LMS uses a full information maximum likelihood-based approach with the expectation-maximization (EM) algorithm, whereas QML uses a quasi-log-likelihood function with two-stage maximization (i.e., single-step iteration method followed by the Newton-Raphson algorithm).

There are some major differences between LMS and QML. First, LMS has a very restrictive distributional assumption (i.e., all the observed and latent predictor variables and the corresponding measurement error/residual variances are normally distributed) whereas QML has a less restrictive distributional assumption and more robust against the violations of the normality assumptions. Second, LMS can become computationally intensive when multiple (three or more) interaction effects are simultaneously estimated in the model, and QML is generally computationally feasible (i.e., the number of latent interaction effects is less of a concern with QML). A third difference is that LMS is built-in to Mplus (V7.11) and QML is a stand-alone program available from Andreas Klein (klein@psych.uni-frankfurt.de). Given that only LMS is available in Mplus, we analyzed the hypothesized latent interaction effect (as presented in Fig. 5.1c) with the use of LMS. The corresponding annotated Mplus syntax for this model is presented in Appendix 2. For more information regarding QML, readers can consult Klein and Muthén (2007) which contained the technical details, or Kelava et al. (2011).

Based on the previous 1b model, we have analyzed the latent interaction effect model using the LMS approach by including the same two correlated residuals (i.e., X3 [parent has shared goals with school] and X5 [similar expectations of child] of the home-school relationship (HSR) scale, X4 [parent respects teacher] and X6 [teacher respects parent] of the HSR scale). Given the multilevel nature of our data, we used the “Type=Complex Random” routine along with “Algorithm=Integration” in which the “Type=Complex” part could address the multilevel data while the “Type=Random” and “Algorithm=Integration” parts were to initiate the LMS procedure for analyzing the latent interaction effect. The robust estimation method, MLR, was the default estimation method for the LMS approach in Mplus.

The results are presented in Table 5.2. Mplus does not produce any overall model fit chi-square test or related fit statistics when using the “Type=Random” routine. Additionally, neither standardized solutions nor modification indices are available under the “Type=Random” routine. As shown in Table 5.2, model 1c had the exact same pattern of significances and very similar (unstandardized) parameter estimates as those from model 1b. That is, both hyperactivity and the interaction effect between hyperactivity and home-school relationship (HSR) were significant in predicting peer acceptance whereas HSR was not significant. The conclusion of the findings was the same as model 1b.

In summary, both the unconstrained approach (one of the product-indicator approaches as used in model 1b) and the LMS approach (one of the distribution-analytic approaches as used in model 1c) have their own advantages and disadvantages for analyzing latent interaction effects. For example, the unconstrained approach can be easily implemented in most of the SEM programs (e.g., AMOS, EQS, LISREL, Mplus, and Stata’s SEM routine) while LMS can only be estimated in Mplus. Similarly, the unconstrained approach is in general computationally feasible and can produce overall model chi-square test and other fit indices, as well as the standardized solutions and modification indices whereas the LMS can be computationally intensive without producing the same set of model fit information as the unconstrained approach. On the other hand, the LMS approach does not require the creation of the product indicators which can become an issue when there is a large difference in the number of observed indicators among the latent factors used for creating the latent interaction effects (Wu, Wen, Marsh, & Hau, 2013). Moreover, as shown in previous simulation studies (Cham et al., 2012; Wu et al., 2013), when the normality assumption is met, the LMS approach produces more accurate and efficient parameter estimates and standard errors which can lead to higher statistical power than the unconstrained approach. Whereas, the unconstrained approach is relatively more robust against the non-normal conditions and still yields unbiased latent interaction effect estimates. Again, each one of these approaches offers different advantages (and disadvantages) on estimating the latent interaction effects and readers may select one (or both) of these approaches depending on their needs and the availability of the statistical software.

Analysis of Hypothesized Model 1d

Although we have shown the advantages of analyzing interaction effects with the use of the latent factor model, sometimes it may not be feasible to include all the observed and latent variables in the same model simultaneously. Moreover, structural equation models are generally estimated using the maximum likelihood or related estimation methods which require relatively large sample sizes to produce unbiased and efficient parameter estimates. Hence, trying to estimate a complex model which contains many observed and latent variables with a relatively small sample sizes can lead to potential convergence difficulties. To avoid the convergence issue, one may modify the model by creating composite scores (e.g., summing or averaging the items of a latent construct) to reduce the number of variables and parameters in the model. In our demonstration, this will involve converting model 1b (with original observed items and latent factors) back to model 1a (observed composite scores only). Nevertheless, we have already noted that the target interaction effect, home–school relationship by hyperactivity, was statistically significant ($p=.039$) under model 1b whereas marginally significant under model 1a ($p=.053$).

Instead of directly using the observed composite scores, there is an alternative approach to incorporate measurement errors into the composites-only model (Brown, 2006; Kline, 2011). As shown in Fig. 5.1d, each of the two latent factors, home–school relationship and the interaction effect, contains only one indicator, respectively. This model is not identifiable and some constraints have to be imposed to make it identifiable. First, the factor loadings are both fixed to be 1.0 for the two latent factors. For home–school relationship, the variance of the corresponding residual (e_x) is constrained based on the following equation:

$$V(e_x) = V(X) \times (1 - \rho_{xx}), \quad (5.2)$$

where $V(X)$ is the variance of the home–school relationship composite score (.604) and ρ_{xx} is the reliability of the home–school relationship scale (.941) based on the eight-item HSR scale. As shown in Table 5.1, the standard deviation of HSR is .777 and the variance of this variable is $(.777)^2 = .604$. Given these two pieces of information, we can then obtain the residual variance of home–school relationship:

$$V(e_x) = V(X) \times (1 - \rho_{xx}) = .604 \times (1 - .941) = .036$$

and constrain the corresponding residual variance in the model to .036.

We can use a very similar equation (as presented below) to obtain the residual variance of the interaction effect (i.e., $X \times M$):

$$V(e_{X \times M}) = V(X \times M) \times (1 - \rho_{(X \times M)(X \times M)}), \quad (5.3)$$

where $V(X \times M)$ is the variance of the interaction effect and $\rho_{(X \times M)(X \times M)}$ is the reliability of the interaction effect, which can be further calculated based on Aiken and West's (1991) equation³ 8.12 (p. 144):

$$\rho_{(X \times M)(X \times M)} = \frac{(\gamma_{XM})^2 + \rho_{XX} \times \rho_{MM}}{(\gamma_{XM})^2 + 1} \quad (5.4)$$

where γ_{XM} is the zero-order correlation between home-school relationship (X) and hyperactivity (M), ρ_{XX} is the reliability of home-school relationship, and ρ_{MM} is the reliability of hyperactivity. Given that hyperactivity is a single standardized score, we assume it has perfect reliability (i.e., $\rho_{MM} = 1.00$) to ease the calculation. The zero-order correlation between home-school relationship and hyperactivity is $-.207$. With this information, we can calculate the reliability of the interaction effect:

$$\rho_{(X \times M)(X \times M)} = \frac{(\gamma_{XM})^2 + \rho_{XX} \times \rho_{MM}}{(\gamma_{XM})^2 + 1} = \frac{(-.207)^2 + .941 \times 1.00}{(-.207)^2 + 1} = .943$$

Given that the variance of the interaction effect is $.732$, we can then calculate the residual variance of the interaction effect using (5.3):

$$V(e_{X \times M}) = V(X \times M) \times (1 - \rho_{(X \times M)(X \times M)}) = .732 \times (1 - .943) = .042$$

Thus, we can constrain the two residual variances (of HSR and the interaction effect) to $.036$ and $.042$, respectively. The corresponding annotated Mplus syntax for this model is presented in Appendix 2.

As presented in Table 5.2, this is a saturated model which fits the data perfectly. The parameter estimates and the corresponding tests of significance of model 1d are very similar to the ones from model 1b (estimated with the latent interaction factor). Specifically, the target interaction effect is still significant ($p = .035$). Hence, based on these results, we can again reach the same conclusion as the findings for model 1b. That is, hyperactivity has a substantial negative effect on peer acceptance while this negative effect can be reduced by more positive home-school relationships.

Regression coefficients can be biased (attenuated) due to measurement error in predictors and the underestimated effects may lead to low statistical power and incorrect statistical conclusions (Aiken & West, 1991). Given that interaction effects in general have relatively low statistical power, the occurrence of the measurement error in predictors which are used for creating the interaction effects introduces more measurement error in the interaction effects which may lead to more substantial attenuation of the interaction effects and further lower the statistical power for detecting the effects. Hence, when analyzing interaction effects, taking the measurement error into account can reduce the bias in the parameter estimates, which in turn, may sometimes help to increase the statistical power for detecting the interaction effects.

³The variables are assumed to be mean-centered.

Dealing with Missing Data When Testing Interaction Effects

To ease our demonstration example, we only used the students with complete data. In reality, researchers may have missingness in their data. The traditional approaches, such as listwise deletion which only includes cases without missing data in the analysis or mean imputation which replaces missing values with the arithmetic mean of the variable based on the available observations, generally result in substantial reduction of statistical power and produce biased estimates of the effects (Enders, 2010). There are two promising modern approaches to handle data that are either missing completely at random (i.e., MCAR; the missingness does not depend on the complete data that can potentially be observed) or missing at random (i.e., MAR; the missingness does not depend on any unobserved data): full information maximum likelihood (FIML) and multiple imputation (MI) (cf. Enders, 2010; Little & Rubin, 2002; Schafer & Graham, 2002). FIML is the default method in Mplus to handle missing data. However, these two approaches require the multivariate normality assumption and interaction effect is likely not normally distributed even though both the predictor and the moderator are bivariate normally distributed. Enders, Baraldi, and Cham (2014) showed that, while both FIML and MI performed well when the interaction effect was close to normally distributed, with moderate to severe non-normality, FIML and MI could result in substantial bias on the interaction effect estimate. Nevertheless, these two modern approaches still outperformed the listwise deletion method. Future research is needed for better procedures to handle missing data with interaction effects. Readers are encouraged to consult with Enders et al. (2014) for discussions on how to analyze interaction effects with the two modern approaches when missing data are present, and Von Hippel (2009) for guidance on multiple imputation with nonlinear effects.

Other Issues Related to Testing and Reporting Interaction Effects

In our example, we tested a simple interaction effect with two continuous predictors. We can also test interaction effects with the product of continuous and non-continuous or categorical variables (e.g., gender, intervention conditions). Below we discuss a few other issues researchers may face when they examine interaction effects.

Interaction Effect with Noncontinuous/Categorical Variable

Interaction effects can also be examined between noncontinuous variables. For dichotomized variables (e.g., gender or treatment/control groups), one can create the interaction effect by multiplying the continuous variable and the dichotomized

a Single-group approach

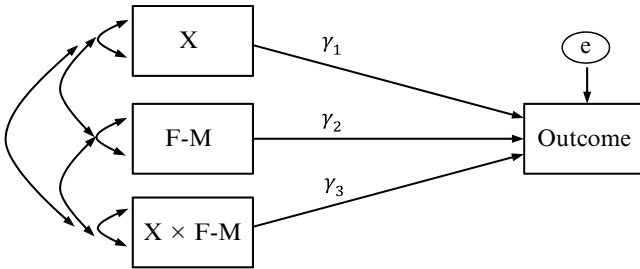

b Multiple-group approach

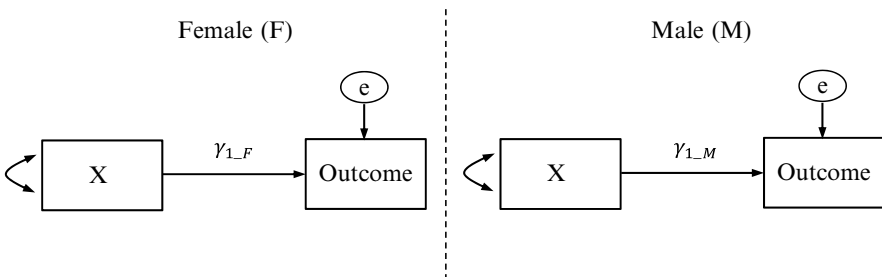

Fig. 5.3 Different approaches for testing interaction effect with noncontinuous/categorical variable. *Note.* X: Home–school relationship; F–M: The dichotomized gender variable (i.e., F=Female group; M=Male group); Outcome: Peer acceptance

variable (e.g., dummy coded as 0 and 1 to represent the two categories/conditions) and include the product term directly in the model for analysis (see Fig. 5.3a). Another approach for testing such interaction effects is the multiple group analysis under the structural equation modeling (SEM) framework. That is, as shown in Fig. 5.3b, we can examine the effect of home–school relationship (HSR) on peer acceptance by different gender groups, respectively. With the use of the chi-squared difference test to compare the overall model chi-squared values between models with and without constraining the path from HSR to peer acceptance, we are basically testing the gender by home–school relationship interaction effect (i.e., $H_0: \gamma_{1,F} = \gamma_{1,M}$). The advantage of using the SEM approach (Fig. 5.3b) over the traditional approach (Fig. 5.3a) is that, whereas the traditional approach assumes homoscedasticity (i.e., assuming the residual variance is exactly the same for both gender groups), the multiple group analysis in SEM does not require this very restrictive assumption. The violation of this homogeneous variance assumption, especially for unbalanced design conditions with very uneven group sizes, can result in biased estimation of the standard errors (with either inflated Type I error rate or reduced statistical power), which in turn, can lead to incorrect statistical conclusions.

For categorical variables with three or more categories, West, Aiken, and Krull (1996) have thoroughly discussed different type of coding schemes for this type of

variables and the ways to test and interpret the interaction effects created between the coded categorical variables and the continuous variables. Nevertheless, some researchers may be unfamiliar with how to treat continuous variables and decide to categorize at least one of the predictors (e.g., dichotomizing a variable with the use of median split). As shown previously (MacCallum, Zhang, Preacher, & Rucker, 2002; Maxwell & Delaney, 1993), under some circumstances, splitting (or dichotomizing) a continuous variable into distinct groups can produce misleading results such as spurious effects with inflated Type I error rate. Hence, researchers should avoid this practice and keep their continuous variables as they are in the analysis.

Rescaling/Centering Variables when Creating Interaction Effects

As shown in our demonstration, centering variables (by their arithmetic means) plays an important role in setting up the latent interaction model (i.e., model 1b). For example, the double-mean-centering strategy eases the specification of the latent interaction model using the unconstrained approach which does not require any nonlinear constraints. Additionally, centering variables (generally by the corresponding arithmetic means) can (a) improve the interpretation (especially for the intercept term) and (b) simplify the relationships and ease the estimation in complex models when multivariate normality is assumed (Shieh, 2011).

In multilevel models, centering is a more complex issue given that variables (especially the ones affiliated with lower levels) can have different centering options which can sometimes lead to quite different parameter estimates (Kreft, de Leeuw, & Aiken, 1995). Enders and Tofighi (2007) pointed out the importance of adequately centering the variables in multilevel analysis so that the desired source of variation can be accurately isolated. They recommend that, for a two-level model, the lower level (level-1) variables should generally be group-mean centered while the higher level (level-2) variables should always be grand-mean centered. Readers are recommended to consult with Kreft et al. (1995) and Enders and Tofighi (2007) for further information on centering in multilevel models.

Concluding Remarks

In this chapter, we offer some alternative approaches for testing moderation effects with an example of hyperactivity moderating the effect of home–school relationship on peer acceptance. In our demonstration, we showed that the latent interaction approaches (models 1b and 1c) and the reliability-adjusted approach (model 1d) resulted in significant interaction effects, whereas the traditional approach (model 1a) resulted in a marginally significant effect. We have discussed the potential advantage of taking the measurement error into account in testing interaction effects which can in general reduce the bias in the parameter estimates. Additionally, we have discussed issues related to testing interaction effects including: centering variables, probing (graphing) interaction effects, obtaining effect sizes of the interaction effects, handling missing data, and testing more complex interaction effects (e.g.,

interaction effects with categorical variables). We hope that this chapter can shed some light on testing moderation effects in family–school partnership research.

Appendix 1: (Description of the Home–School Relationship Scale Items)

The home–school relationship (HSR) scale

X1 = Teacher can talk to and feel heard by parent

X2 = Mutual understanding

X3 = Parent has shared goals with school

X4 = Parent respects teacher

X5 = Similar expectations of child

X6 = Teacher respects parent

X7 = Teacher comfortable discussing child problems with parent

X8 = Difficult communication (reversed coding)

Appendix 2: (SPSS and Mplus Annotated Syntax)

Model 1a (SPSS MIXED)

MIXED PA with Hyper HSR H_H

```
/FIXED=Hyper HSR H_H
/RANDOM=INTERCEPT | SUBJECT(ClassID)
/METHOD=REML
/PRINT=SOLUTION TESTCOV.
```

Note:

Mixed—SPSS Mixed routine

Mixed (Outcome) with (Predictors)

PA: Peer Acceptance; Hyper: Hyperactivity; HSR: home–school relationship;

H_H: the interaction effect term (i.e., product between HSR and Hyper)

/Fixed=(Predictors): estimate the regression coefficients

/Random=Intercept: estimate the level-2 variance

|Subject (ClassID): indicate the higher level cluster variable (i.e., class-room ID in our example)

/Method=REML: estimation method (REML: Restricted Maximum Likelihood as the default estimation method)

/Print=Solution: print out the parameter estimates

Testcov: test the random effect variance

Model 1b (Mplus V7.11)

TITLE: Testing Model 1b

Data:

File is centered.dat;

Variable:

Names are ClassID PA X1 X2 X3 X4 X5 X6 X7 X8

Hyper HX1 HX2 HX3 HX4 HX5 HX6 HX7

HX8;

Usevariables are PA X1 X2 X3 X4 X5 X6 X7 X8

Hyper HX1 HX2 HX3 HX4 HX5 HX6

HX7 HX8;

Cluster=ClassID;

Analysis:

TYPE=COMPLEX;

Model:

HSR BY X1 X2 X3 X4 X5 X6 X7 X8;

H_H BY HX1 HX2 HX3 HX4 HX5 HX6 HX7 HX8;

PA ON Hyper HSR H_H;

X3 WITH X5;

X4 WITH X6;

HX3 WITH HX5;

Output:

Stdyx;

Note:

Title: Title of the syntax

Data: File is (the file name containing the data)

Variable: Names are (the variable names in the data file)

Usevariables are (the variables used in the analysis/model)

Cluster=(cluster ID variable)

Analysis: Type=Complex (Mplus routine which takes the dependency issue into account by adjusting the standard errors of the estimates)

Model: (specifying the model as shown in Fig. 5.1b)

HSR (the latent factor of HSR) **BY** the corresponding 8 observed indicators (i.e., X1–X8)

H_H (the latent interaction factor) **BY** the corresponding 8 observed product indicators (i.e., HX1–HX8)

PA (the observed Peer Acceptance variable) **ON** (predicted by) Hyper, HSR, and H_H

X3 **WITH** X5 (correlated the residuals between observed items X3 and X5)

Output: Stdyx (request for standardized solutions)

Model 1c (Mplus V7.11)

TITLE: Testing Model 1c

Data:

File is centered.dat;

Variable:

Names are ClassID PA X1 X2 X3 X4 X5 X6

X7 X8 Hyper HX1 HX2 HX3

HX4 HX5 HX6 HX7 HX8;

Usevariables are PA X1 X2 X3 X4 X5 X6 X7

X8 Hyper HX1 HX2 HX3

HX4 HX5 HX6 HX7 HX8;

Cluster = ClassID;

Analysis:

TYPE = COMPLEX random;

algorithm = integration;

Model:

HSR BY X1 X2 X3 X4 X5 X6 X7 X8;

PA ON Hyper HSR;

H_H | HSR XWITH Hyper;

PA ON H_H;

X3 WITH X5;

X4 WITH X6;

Note:

Title: Title of the syntax

Data: File is (the file name containing the data)

Variable: Names are (the variable names in the data file)

Usevariables are (the variables in the analysis/model)

Cluster = (cluster ID variable)

Analysis: Type = Complex Random (Complex is for taking the multilevel structure/dependency into account while Random is required for the use of the LMS routine)

Algorithm = integration (This command line is required for the use of the LMS routine)

Model: (specifying the model as shown in Fig. 5.1c)

HSR (the latent factor of HSR) **BY** the corresponding 8 observed indicators (i.e., X1–X8)

PA (the observed Peer Acceptance variable) **ON** (predicted by) Hyper and HSR

(continued)

H_H | HSR XWITH Hyper: the latent interaction effect H_H is created by the product (XWITH) between HSR and Hyper PA (the observed Peer Acceptance variable) ON (predicted by) the latent interaction effect H_H
 X3 WITH X5 (correlated the residuals between observed items X3 and X5)

Model 1d (Mplus V7.11)

TITLE: Testing Model 1d

Data:

File is centered1.dat;

Variable:

Names are ClassID PA Hyper HSR H_H;

Usevariables are PA Hyper HSR H_H;

Cluster=ClassID;

Analysis:

Type=complex;

Model:

aHSR BY HSR;

HSR@.036;

aH_H BY H_H;

H_H@.042;

PA ON aHSR Hyper aH_H;

Output:

Stdyx;

Note:

Title: Title of the syntax

Data: File is (the file name containing the data)

Variable: Names are (the variable names in the data file)

Usevariables are (the variables in the analysis/model)

Cluster=(cluster ID variable)

Analysis: Type=Complex (Complex is for taking the multilevel structure/dependency into account)

(continued)

Model: (specifying the model as shown in Fig. 5.1d)
 aHSR (the latent factor of HSR) **BY** the corresponding observed HSR composite score
 HSR@.036 (the residual variance of the composite score HSR is fixed to .036)
 aH_H (the latent factor of the interaction effect) **BY** the corresponding observed interaction score (H_H) created by the product of HSR and Hyper
 H_H@.042 (the residual variance of the interaction composite score is fixed to .042)
 PA (the observed Peer Acceptance variable) **ON** (predicted by) Hyper, aHSR and aH_H
 Output: Stdyx (request for standardized solutions)

References

- Aiken, L. S., & West, S. G. (1991). *Multiple regression: Testing and interpreting interactions*. Newbury Park, CA: Sage.
- Algina, J., & Moulder, B. C. (2001). A note on estimating the Jöreskog–Yang model for latent variable interaction using LISREL 8.3. *Structural Equation Modeling*, 8, 40–52.
- Brown, T. A. (2006). *Confirmatory factor analysis for applied research*. New York, NY: Guilford Press.
- Buhs, E. S., Ladd, G. W., & Herald, S. L. (2006). Peer exclusion and victimization: Processes that mediate the relation between peer group rejection and children's classroom engagement and achievement? *Journal of Educational Psychology*, 98, 1–13. doi:10.1037/0022-0663.98.1.1.
- Cham, H., West, S. G., Ma, Y., & Aiken, L. S. (2012). Estimating latent variable interactions with nonnormal observed data: A comparison of four approaches. *Multivariate Behavioral Research*, 47, 840–876. doi:10.1080/00273171.2012.732901.
- Cohen, J. (1988). *Statistical power analysis for the behavioral sciences* (2nd ed.). Hillsdale, NJ: Erlbaum.
- Cudeck, R., Haring, J. R., & du Toit, S. H. C. (2009). Marginal maximum likelihood estimation of a latent variable model with interaction. *Journal of Educational and Behavioral Statistics*, 34, 131–144. doi:10.3102/1076998607313593.
- Eccles, J. S., & Harold, R. D. (1996). Family involvement in children's and adolescents' schooling. In A. Booth & J. F. Dunn (Eds.), *Family-school links: How do they affect educational outcomes?* (pp. 3–34). Mahwah, NJ: Erlbaum.
- Enders, C. K. (2010). *Applied missing data analysis*. New York, NY: Guilford Press.
- Enders, C. K., Baraldi, A. N., & Cham, H. (2014). Estimating interaction effects with incomplete predictor variables. *Psychological Methods*, 19(1):39-55
- Enders, C. K., & Tofighi, D. (2007). Centering predictor variables in cross-sectional multilevel models: A new look at an old issue. *Psychological Methods*, 12, 121–138. doi:10.1037/1082-989X.12.2.121.
- Epstein, J. L., & Sanders, M. G. (2002). Family, school, and community partnerships. In M. H. Bornstein (Ed.), *Handbook of parenting* (2nd ed., Vol. 5, pp. 407–437). Mahwah, NJ: Lawrence Erlbaum.

- Fan, X., & Chen, M. (2001). Parental involvement and students' academic achievement: A meta-analysis. *Educational Psychology Review, 13*, 1–22. doi:[10.1023/A:1009048817385](https://doi.org/10.1023/A:1009048817385).
- Hamre, B. K., & Pianta, R. C. (2001). Early teacher-child relationships and the trajectory of children's school outcomes through eighth grade. *Child Development, 72*, 625–638. doi:[10.1111/1467-8624.00301](https://doi.org/10.1111/1467-8624.00301).
- Hill, N. E. (2001). Parenting and academic socialization as they relate to school readiness: The roles of ethnicity and family income. *Journal of Educational Psychology, 93*, 686–697. doi:[10.1037/0022-0663.93.4.686](https://doi.org/10.1037/0022-0663.93.4.686).
- Hill, N. E., Castellino, D. R., Lansford, J. E., Nowlin, P., Dodge, K. A., Bates, J. E., & Pettit, G. S. (2004). Parent academic involvement as related to school behavior, achievement, and aspirations: Demographic variations across adolescence. *Child Development, 75*, 1491–1509. doi:[10.1111/j.1467-8624.2004.00753.x](https://doi.org/10.1111/j.1467-8624.2004.00753.x).
- Hill, C. R., & Hughes, J. N. (2007). An examination of the convergent and discriminant validity of the Strengths and Difficulties Questionnaire. *School Psychology Quarterly, 22*, 380–406. doi:[10.1037/1045-3830.22.3.380](https://doi.org/10.1037/1045-3830.22.3.380).
- Hill, N. E., & Tyson, D. F. (2009). Parental involvement in middle school: A meta-analytic assessment of the strategies that promote achievement. *Developmental Psychology, 45*, 740–763. doi:[10.1037/a0015362](https://doi.org/10.1037/a0015362).
- Hox, J. J. (2010). *Multilevel analysis: Techniques and applications* (2nd ed.). New York, NY: Routledge.
- Hsu, H.-Y., Kwok, O., Acosta, S., & Lin, J.-H. (2015). Detecting misspecified multilevel SEMs using common fit indices: A Monte Carlo study. *Multivariate Behavioral Research, 50*, 197–215.
- Hughes, J. N., & Kwok, O. (2007). The influence of student-teacher and parent-teacher relationships on lower achieving readers' engagement and achievement in the primary grades. *Journal of Educational Psychology, 99*, 39–51. doi:[10.1037/0022-0663.99.1.39](https://doi.org/10.1037/0022-0663.99.1.39).
- Jöreskog, K. G., & Yang, F. (1996). Nonlinear structural equation models: The Kenny-Judd model with interaction effects. In G. A. Marcoulides & R. E. Schumacker (Eds.), *Advanced structural equation modeling: Issues and techniques* (pp. 57–88). Mahwah, NJ: Erlbaum.
- Kelava, A., Werner, C. S., Schermelleh-Engel, K., Moosbrugger, H., Zapf, D., Ma, Y., ... & West, S. G. (2011). Advanced nonlinear latent variable modeling: Distribution analytic LMS and QML estimators of interaction and quadratic effects. *Structural Equation Modeling, 18*, 465–491. doi:[10.1080/10705511.2011.582408](https://doi.org/10.1080/10705511.2011.582408).
- Klein, A. G., & Moosbrugger, H. (2000). Maximum likelihood estimation of latent interaction effects with the LMS method. *Psychometrika, 65*, 457–474. doi:[10.1007/BF02296338](https://doi.org/10.1007/BF02296338).
- Klein, A. G., & Muthén, B. O. (2007). Quasi-maximum likelihood estimation of structural equation models with multiple interaction and quadratic effects. *Multivariate Behavioral Research, 42*, 647–673. doi:[10.1080/00273170701710205](https://doi.org/10.1080/00273170701710205).
- Kline, R. B. (2011). *Principles and practice of structural equation modeling* (3rd ed.). New York, NY: Guilford Press.
- Kreft, I. G. G., de Leeuw, J., & Aiken, L. S. (1995). The effect of different forms of centering in hierarchical linear models. *Multivariate Behavioral Research, 30*, 1–21. doi:[10.1207/s15327906mbr3001_1](https://doi.org/10.1207/s15327906mbr3001_1).
- Lin, G. C., Wen, Z., Marsh, H. W., & Lin, H. S. (2010). Structural equation models of latent interactions: Clarification of orthogonalizing and double-mean-centering strategies. *Structural Equation Modeling, 17*, 374–391. doi:[10.1080/10705511.2010.488999](https://doi.org/10.1080/10705511.2010.488999).
- Little, R. J. A., & Rubin, D. B. (2002). *Statistical analysis with missing data* (2nd ed.). Hoboken, NJ: Wiley.
- MacCallum, R. C., Zhang, S., Preacher, K. J., & Rucker, D. D. (2002). On the practice of dichotomization of quantitative variables. *Psychological Methods, 7*, 19–40. doi:[10.1037/1082-989X.7.1.19](https://doi.org/10.1037/1082-989X.7.1.19).

- Marsh, H. W., Wen, Z., Hau, K. T., & Nagengast, B. (2013). Structural equation models of latent interaction and quadratic effects. In G. R. Hancock & R. O. Muller (Eds.), *Structural equation modeling: A second course* (2nd ed., pp. 267–308). Greenwich, CT: Information Age.
- Marsh, H. W., Wen, Z., Nagengast, B., & Hau, K.-T. (2012). Structural equation models of latent interaction. In R. H. Hoyle (Ed.), *Handbook of structural equation modeling* (pp. 436–458). New York, NY: Guilford Press.
- Marsh, H. W., Wen, Z., & Hau, K.-T. (2004). Structural equation models of latent interactions: Evaluation of alternative estimation strategies and indicator construction. *Psychological Methods*, 9, 275–300. doi:[10.1037/1082-989X.9.3.275](https://doi.org/10.1037/1082-989X.9.3.275).
- Marsh, H. W., Wen, Z., & Hau, K. T. (2006). Structural equation models of latent interaction and quadratic effects. In G. R. Hancock & R. O. Mueller (Eds.), *Structural equation modeling: A second course* (pp. 225–265). Greenwich, CT: Information Age.
- Masten, A. S., Morrison, P., & Pelligrini, D. S. (1985). A revised class play method of peer assessment. *Developmental Psychology*, 21, 523–533. doi:[10.1037/0012-1649.21.3.523](https://doi.org/10.1037/0012-1649.21.3.523).
- Maxwell, S. E., & Delaney, H. D. (1993). Bivariate median splits and spurious statistical significance. *Psychological Bulletin*, 113, 181–190. doi:[10.1037/0033-2909.113.1.181](https://doi.org/10.1037/0033-2909.113.1.181).
- Meehan, B. T., Hughes, J. N., & Cavell, T. A. (2003). Teacher-student relationships as compensatory resources for aggressive children. *Child Development*, 74, 1145–1157. doi:[10.1111/1467-8624.00598](https://doi.org/10.1111/1467-8624.00598).
- Moulder, B. C., & Algina, J. (2002). Comparison of methods for estimating and testing latent variable interactions. *Structural Equation Modeling*, 9, 1–19. doi:[10.1207/S15328007SEM0901_1](https://doi.org/10.1207/S15328007SEM0901_1).
- Muñoz-Sandoval, A. F., Woodcock, R. W., McGrew, K. S., & Mather, K. (2005). *Bateria III Woodcock–Muñoz*. Itasca, IL: Riverside.
- Muthén, L. K., & Muthén, B. O. (1998–2012). *Mplus user's guide* (6th ed.). Los Angeles, CA: Muthén & Muthén.
- Raudenbush, S., & Bryk, A. S. (2002). *Hierarchical linear models: Applications and data analysis methods* (2nd ed.). Thousand Oaks, CA: Sage.
- Ronk, M. J., Hund, A. M., & Landau, S. (2011). Assessment of social competence of boys with attention-deficit/Hyperactivity disorder: Problematic peer entry, host responses, and evaluations. *Journal of Abnormal Child Psychology*, 39, 829–840. doi:[10.1007/s10802-011-9497-3](https://doi.org/10.1007/s10802-011-9497-3).
- Ryu, E., & West, S. G. (2009). Level-specific evaluation of model fit in multilevel structural equation modeling. *Structural Equation Modeling*, 16, 583–601. doi:[10.1080/10705510903203466](https://doi.org/10.1080/10705510903203466).
- Schafer, J. L., & Graham, J. W. (2002). Missing data: Our view of the state of the art. *Psychological Methods*, 7, 147–177. doi:[10.1037/1082-989X.7.2.147](https://doi.org/10.1037/1082-989X.7.2.147).
- Serpell, Z. N., & Mashburn, A. J. (2012). Family–school connectedness and children's early social development. *Social Development*, 21, 21–46. doi:[10.1111/j.1467-9507.2011.00623.x](https://doi.org/10.1111/j.1467-9507.2011.00623.x).
- Shieh, G. (2011). Clarifying the role of mean centering in multicollinearity of interaction effects. *British Journal of Mathematical and Statistical Psychology*, 64, 462–477.
- SPSS Inc. (2013). *IBM SPSS statistics 22 core system user's guide*. Chicago, IL: Author.
- Tang, S., Dearing, E., & Weiss, H. B. (2012). Spanish-speaking Mexican-American families' involvement in school-based activities and their children's literacy: The implications of having teachers who speak Spanish and English. *Early Childhood Research Quarterly*, 27, 177–187. doi:[10.1016/j.ecresq.2011.09.001](https://doi.org/10.1016/j.ecresq.2011.09.001).
- Von Hippel, P. T. (2009). How to impute interactions, squares, and other transformed variables. *Sociological Methodology*, 39, 265–291. doi:[10.1111/j.1467-9531.2009.01215.x](https://doi.org/10.1111/j.1467-9531.2009.01215.x).
- Wall, M. M., & Amemiya, Y. (2001). Generalized appended product indicator procedure for non-linear structural equation analysis. *Journal of Educational and Behavioral Statistics*, 26, 1–29. doi:[10.3102/10769986026001001](https://doi.org/10.3102/10769986026001001).
- West, S. G., Aiken, L. S., & Krull, J. L. (1996). Experimental personality designs: Analyzing categorical by continuous variable interactions. *Journal of Personality*, 64, 1–48. doi:[10.1111/j.1467-6494.1996.tb00813.x](https://doi.org/10.1111/j.1467-6494.1996.tb00813.x).

- Wong, S. W., & Hughes, J. N. (2006). Ethnicity and language contributions to dimensions of parent involvement. *School Psychology Review, 35*, 645–662.
- Woodcock, R. W., McGrew, K. S., & Mather, N. (2001). *Woodcock-Johnson III tests of achievement*. Riverside, CA: Riverside.
- Wu, J., & Kwok, O. (2012). Using SEM to analyze complex survey data: A comparison between design-based single-level and model-based multilevel approaches. *Structural Equation Modeling, 19*, 16–35. doi:[10.1080/10705511.2012.634703](https://doi.org/10.1080/10705511.2012.634703).
- Wu, Y., Wen, Z., Marsh, H. W., & Hau, K.-T. (2013). A comparison of strategies for forming product indicators for unequal numbers of items in structural equation models of latent interactions. *Structural Equation Modeling, 20*, 551–567. doi:[10.1080/10705511.2013.824772](https://doi.org/10.1080/10705511.2013.824772).
- Zhang, Y., Haddad, E., Torres, B., & Chen, C. (2011). The reciprocal relationships among parents' expectations, adolescents' expectations, and adolescents' achievement: A two-wave longitudinal analysis of the NELS data. *Journal of Youth and Adolescence, 40*, 479–489. doi:[10.1007/s10964-010-9568-8](https://doi.org/10.1007/s10964-010-9568-8).

Chapter 6

Contexts of Family–School Partnerships: A Synthesis

Eva N. Patrikakou

The realization of children’s potential depends, to a great degree, on the contexts within which they develop and learn. The more productive interconnections exist among those contexts, the greater the impact on academic, social, and emotional learning. From the onset of a child’s life, the context and the relationships formed among family members serve as a profound catalyst for physical, cognitive, emotional, and social development. From the critical bonding of infancy to the later years of adolescent identity-formation, families are the first context in which children’s traits interact with environmental characteristics and result in individual growth.

Years of evidence supporting the benefits of family involvement have forged a consensus among researchers, educators, and policy-makers that parent involvement is a crucial force in children’s development, learning, and success at school and in life. Parent involvement, parent participation, parent engagement, family–school partnerships, school–family–community partnerships are just a few of the terms that are used interchangeably to describe what seems like an elusive concept of how, and to what degree, parents engage with their children in academic, social, and emotional learning, as well as how families interact with schools to maximize children’s school and life success. This decades-long research has time and again supported what appears self-evident that children of involved parents have a much greater chance to develop into healthy, knowledgeable, responsible, and caring adults. Interestingly though, even within the premise of this broader consensus, a nebulous picture is painted when one closely examines how studies and programs have defined, measured, and evaluated this concept that falls under the umbrella term “parent involvement.”

A commentary on the chapters contained in volume III: contexts of family–school partnerships: research, practice, and policy

E.N. Patrikakou (✉)
DePaul University, Chicago, IL, USA
e-mail: epatrika@depaul.edu

The lack of a common definition lies primarily in the multidimensional nature of parent and teacher influences on children, as well as in the complexity of home–school partnerships. The challenge posed by the lack of common ground gets further augmented when one moves beyond “parent involvement” to the investigation of “partnerships” between families and schools, and to the examination of specific programming that can enhance this relationship. One critical difference between the term parent involvement, and related terms, is the lack of a partnership orientation. Such an orientation reflects even further the *multidimensional nature* of home–school interactions and indicates a shared responsibility that both families and schools have in educating children and adolescents. This multidimensionality is emphasized in all chapters included in this volume, and it permeates the contextual facets (including those that are research-, practice-, methodological-, or policy-oriented), that each chapter has detailed.

Central in the discussion of family–school partnerships is the assumption that a single setting is not the sole, or isolated, contributor to a child’s development, but, most importantly, it is the interrelationships among contexts that play a decisive role in human development. The more supportive links among settings, the greater the potential for healthy development (Bronfenbrenner, 1979). This focal assumption is inherent in the bioecological approach to development and underscores the multidimensionality of relationships between school and home environments which is the prominent, common running theme through the chapters in this volume. As part of this series on family–school partnerships, this opportunity to discuss the importance of context to accommodate the multidimensionality of this area of study is timely and welcomed. It is essential to moving the field forward as new contextual demands (i.e., technology and media use) have rapidly infused into family and school lives, and, therefore, must be integrated in future research and programming.

Bioecological Model: An Integrative Framework of Family–School Partnerships

If the quest for a common definition is viewed as intangible or even futile given the multidimensional nature of home–school partnerships, the need for using an integrative theoretical framework is tangible and valuable. Having an integrative framework within which home–school partnerships can be explored, implemented, and evaluated is fundamental to alleviate some of the definitional and methodological issues that have afflicted this field of study since its inception.

Bronfenbrenner’s broader bioecological framework has been proposed and used over the years as it encompasses the multidimensional nature of home–school partnerships, and also puts the spotlight on the uniqueness of interactions between two or more settings contributing to development (Bronfenbrenner, 1979, 1994). Although calls for the need and critical function of integrating such a theoretical infrastructure have been raised both in empirical and theoretical work in the past two decades, close attention to this aspect has not been paid (e.g., Patrikakou, 1996;

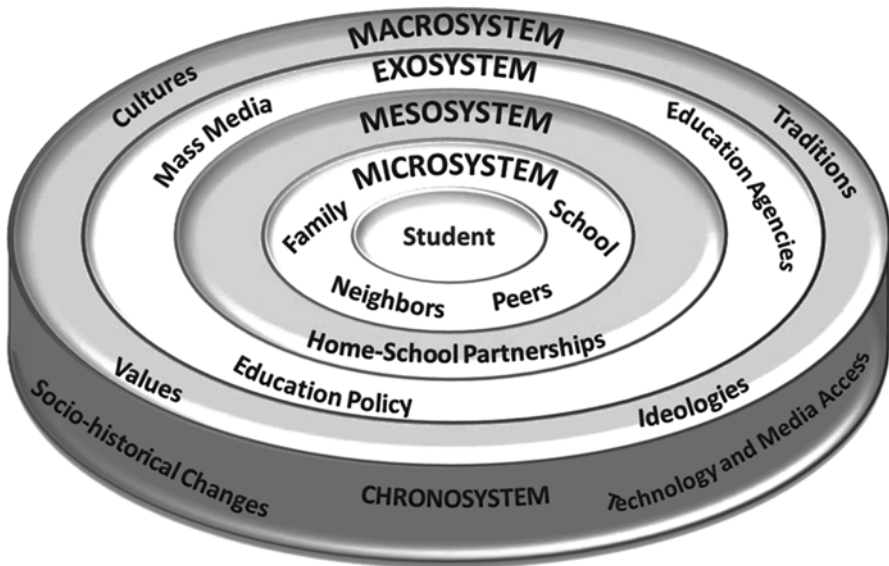

Fig. 6.1 Bioecological model: An integrative framework of family–school partnerships

Patrikakou, Weissberg, Redding, & Walberg, 2005; Sheridan, Cowan, & Meegan, 1999; Sheridan, Knoche, Edwards, Bovaird, & Kupzyk, 2010).

The bioecological framework of development acknowledges both individual and contextual characteristics, which is a necessary assumption when studying the effects of any factor in human development. This theory also posits that individual characteristics affect and are affected by systems, institutions, and programs. In its original form, there were four concentric systems included (i.e., microsystem, mesosystem, exosystem, and macrosystem)¹ one of which, the mesosystem, has been exclusively dedicated to the interaction of immediate environments in an individual's life, such as family and school (Bronfenbrenner, 1979). In later reformulations of his theory, Bronfenbrenner (1986, 1994) added a fifth system (chronosystem) which extended the concept of context into the dimension of time, not in terms of chronological age and developmental changes in a person, which are nonetheless inherent in the study of development, but rather in terms of the changes that occur in various environments in which a person lives and grows (see Fig. 6.1). This key addition makes the bioecological theory even more pertinent as a framework to discuss home–school partnerships, especially in light of rapid and massive contextual changes that have occurred, such as technology and media advances that have influenced individuals and all surrounding systems.

¹*Microsystem*: proximal influences from immediate settings such as home and school; *mesosystem*: interactions between two or more microsystems; *exosystem*: settings that may not contain the individual, but which influence the individual's microsystems; and *macrosystem*: broader societal, cultural, and ideological influences.

Bronfenbrenner emphasized the use of the bioecological model as a context of human development in general, but also as a paradigm for investigating the impact of environments and their interactions on development (Bronfenbrenner, 1986). Such a framework of inquiry allows for interrelationships while also recognizing all possible sources that may serve as influences or moderators of growth and learning.

Chapters in this volume, directly or indirectly, underscore the importance of the bioecological theory as an integrative framework in the study of home–school partnerships. For example, Sheridan, Holmes, Smith, and Moen (2015) clearly denote the framework’s significance and underline the reciprocity of home–school interactions as a force of learning and growth, and as the basis of effective, partnership-oriented programming to enhance children’s school readiness, or to address children’s learning and behavior needs across home and school settings. In their review of the *Getting Ready* intervention and the *Conjoint Behavioral Consultation* intervention, authors describe both direct and indirect factors and processes that impact families and schools, two of the most important microsystems in a child’s life. Such factors and processes included in the chapter’s discussion of the two intervention exemplars have the potential of enhancing a child’s academic, social, and emotional learning, and increase collaborative opportunities, clearly targeting the mesosystemic influences in a student’s life.

Stormshak et al. (2015) discuss the significant role that the microsystem of the family has on children and adolescent development, and its function especially during times of transition from one educational level to the next. The authors present the *Positive Family Support (PFS)* program which is designed to increase collaborative relationships between families and school personnel. In their discussion, Stormshak et al. highlight not only the effects of microsystems and the mesosystem through the interactions of home and school, but also influences and pressures descending from other systems such as the macrosystem, exosystem, and chronosystem through the lack of resources, the broader educational climate, critical events, as well as broader attitudes and beliefs.

Along the lines of broader influences, in his chapter on the importance of Local Education Agencies to establish and foster school–family partnerships, Sheldon (2015) underscores the significance of factors such as policy, administrative structures, leadership, and community influences. The author argues that these macro-systemic and, to some extent, exosystemic elements affect the educators’ approach to implementing family and community engagement practices. Whether through creating a widely disseminated awareness of the benefits of home–school–community partnership programs, or through evaluating the results of such programming, the author highlights the importance of taking into account specific needs that exist in each context, and also recommends that program implementation be flexible to incorporate factors from multiple systems.

Knoche (2015) further enhances the focus on distal processes by examining the broader macro-systemic and exosystemic policy factors. The chapter builds onto the discussion of context and home–school partnerships by viewing the interplay among

research, programming, and policy which is not always triggered by the researchers' agenda, but by policy needs, whether to inform a decision, enhance the policy-makers' understanding on a given topic, or directly target opportunities to actively influence public policy. Such a view significantly expands the sometimes narrow consideration of family–school partnerships as only a mesosystemic area of study, to highlighting its impact on, and interaction with, broader systems of influence. The author's argument that scholars in the area of home–school partnerships can engage in the process of policy-making through a variety of ways further highlights the multidimensionality of the field, not only in terms of inquiry, but also in terms of practical applications and broad dissemination.

Another aspect of the multidimensional nature of home–school partnerships is showcased by Kwok, Im, Hughes, Wehrly, and West (2015). The authors discuss methodological issues illuminating the bioecological theory's premise of bidirectionality of influences in that individual and microsystemic family and school characteristics not only are affected by other systems, institutions, and programs, but they affect those spheres of influence. The issues discussed in this chapter are also pertinent to the study of issues encompassed in the chronosystem by illuminating contextual changes or consistency of conditions and characteristics in one's immediate and broader environment. The example of exceptionality characteristics interacting with environmental properties and processes, including family–school relations, also points to how microsystems, and their mesosystemic interactions are vital in, and are affected by, development and individual characteristics. As Bronfenbrenner and Ceci (1994) noted “which features of the environment become, or are made, salient plays a critical role in determining which of a multitude of innate possibilities have the most chance of finding realization” (p. 583).

Multidimensionality

Chapters in this volume discuss various facets of the multidimensional nature of home–school partnerships. Sheridan and colleagues (2015) directly address the issue of multidimensionality by noting how complicated the implementation of partnership programs becomes as it requires to tend to all the contextual components and needs of all involved. As these authors note, given the complexity of partnership programming there is a dearth of intervention research evidence, particularly related to which aspects of home–school partnership interventions work within specific environments.

Using the integrative framework of the bioecological model and the multidimensionality reflected in the chapters of this volume, one can identify three broad dimensions that are intertwined: (a) developmental considerations and personal competencies; (b) roles in home–school partnerships; and (c) contextual perspectives.

Developmental Considerations and Personal Competencies

When discussing parent involvement and home–school partnerships, most studies focus on the early childhood and the elementary school years. Oftentimes, both parents and school personnel misinterpret the adolescents' desire for autonomy as a developmental barrier to family involvement and home–school interactions. However, such a desire for autonomy serves as a moderator of preferences for certain types of involvement over others, rather than serving as a barrier to any type of parent involvement, which continues to be a powerful factor for school achievement and success in life (Patrikakou, 2004). Describing challenges and future directions, Stormshak et al. (2015) raise the crucial issue of a significant decline in interactions between home and school as children progress into middle school, and offer the PFS program as an intervention designed to foster collaboration between families and school personnel during periods of critical developmental transitions.

Developmental considerations such as times of transition from one level of schooling to the next have not been given the close attention to which they are due. Especially the transition to middle school is one of the most difficult, and the middle school years are a time of peak referrals for mental health services. For example, the onset for mood and substance use disorders is reported early to middle adolescence (e.g., 13 years old for mood, and 15 years old for substance use disorders). Also, the prevalence of alcohol and other drug use, which often occurs along with mental health problems, increases substantially among teenagers in the USA during the middle school and high school years, with alcohol and marijuana use tripling from sixth to eighth grade (Stein et al., 2012). In addition, in the USA, suicide is the third leading cause of death in youth 10–19 years of age (American Academy of Pediatrics Committee on School Health, 2004). Evidence not only from the USA, but also from around the world reinforce the importance of the middle school years, and given the ecological and contextual nature of these transitions, successful adaptation requires the coordinated action of family, schools, and community (Elias, Patrikakou, & Weissberg, 2007). Home–school partnership programming offers a unique opportunity to prevent at-risk behaviors and improve early diagnosis and intervention services for children and adolescents.

Sheridan et al. (2015) also raise the issue of the importance of transitions through their evaluation of the *Getting Ready* program. Such a partnership-oriented approach intends to support children's school readiness, including language use and early literacy, as well as social and emotional aspects, all of which are necessary elements for successful transition to formal schooling and for overall school adjustment. In addition, the authors introduce the increasingly critical issue of child competencies. In addition to parent competencies that are addressed by the *Getting Ready* program, program activities direct parent attention to particular child competencies which are of paramount importance as education shifts from mere knowledge based to becoming competence based.

Competency-based education extends beyond knowledge-transfer, requires the learner to demonstrate targeted content and skills, and lends itself to more personalized learning. This approach culminates into a higher order of learning that is assessed by a comprehensive student evaluation. Such an evaluation is embedded throughout the educational process not only as a measure of learning objectives, but also as a meaningful assessment to directly inform practice (Twyman, 2014).

The personal competencies of the learner can be clustered into four broad categories: *cognitive* (prior learning, associations to new concepts, and facilitating); *meta-cognitive* (including self-appraisal and self-management); *motivational* (student's intrinsic motivation for exploration, discovery, and mastery); and *socio-emotional* (involving self-awareness, social awareness, self-management, responsible decision-making, and relationship skills; Redding, 2014). Fostering these competencies through home–school partnerships strengthens the learner's ability to quickly adjust his/her thinking and adapt to technological advances and their applications, keeping up with the brisk changes in accessing resources, and displaying the personal competencies for school and life success (Patrikakou, 2015).

Roles in Home–School Partnerships

As discussed in the first part of this chapter, examining home–school partnerships within the bioecological framework involves many systems. Several individuals from these various systems are involved in the development, implementation, and evaluation of such programming. An additional consideration is that role-construction within the framework of home–school partnerships depends on the individual meaning construction within the reform process, centered not on what school professionals do (or fail to do) when enacting policy, but on how they interpret ideas. Individual responses to educational policy or intervention are influenced by distinct factors, including internal cognitive structures, specifics of context, and underlying messages (Spillane, Reiser, & Reimer, 2002). Each individual—holding unique beliefs, attitudes, and emotions that greatly influence how he or she interacts with new ideas—has an impact on the degree and quality of implementation, and therefore the success of any policy or reform (Hoekstra & Korthagen, 2011). As Sheridan et al. (2015) note individuals involved in parent partnerships often project their own personal understandings of such partnerships, posing a challenge to fidelity implementing activities in a manner inconsistent with a given partnership intervention or a particular research protocol. Therefore, it becomes relevant to examine perceptions and beliefs of all those involved in home–school interventions.

All chapters included in this volume address the importance of various roles occurring in all ecological systems from the obvious, proximal to the less obvious and distal to enhancing the home–school connection. Kwok et al. (2015) discuss the importance of child and family characteristics as moderators for the impact of home–school interventions. Sheridan et al. (2015) emphasize the crucial role that

parents can play in their child's development and the need to support families in maximizing the benefits of parent-child interactions. Stormshak et al. (2015) shed light on the importance of school leadership and targeted training from pre-service, and in-service, teachers and other school personnel on home-school partnership issues. The impact of school leadership, perceptions of leadership on professionals' attitudes toward interventions, and broader policy initiatives are immense. This has become especially evident for policy initiatives, such as Response of Intervention (RTI), also known as Multi-Tiered System of Supports (MTSS), that have been proposed to serve as a structural backbone of home-school interventions. School professionals, who have confidence in their leadership, including a positive, knowledgeable principal and other informed leaders, display more favorable attitudes about RTI and its intended benefits (Feiker-Hollenbeck & Patrikakou, 2014). Such perceived importance of school-based leaders contributes to the critical role school climate and fidelity of implementation play in the implementation of home-school interventions.

Sheldon (2015) expands the discussion of roles in the function that districts can play in facilitating schools working with families, and in this way, moving beyond the mere monitoring of partnership activities in which schools are engaged. Expanding the discussion on this topic, Knoche (2015) further extends the examination of various roles to the broader level of policy-makers and researchers, and emphasizes the importance of forging ways to enhance each other's work and create (a) a more solid basis for policies involving families and schools, as well as (b) more targeted research to enhance our understanding of contextual perspectives in home-school partnerships.

As Stormshak et al. (2015) suggest to enhance the chances of home-school programming to be implemented with fidelity—an issue that several authors discuss as a recurring problem for partnership interventions—it is best if it is couched within existing, naturally occurring ecological configurations, or established multi-tiered service-delivery structures, such as RTI. Response to Intervention is a multi-tiered assessment and intervention-delivery model designed to improve educational outcomes via research-based instructional methods aligned with student data. Although the earliest conceptualization of RTI involved four tiers of instruction, with the forth tier being special education, RTI is now typically considered a general education reform framework involving assessment and intervention that occurs prior to special education referral (Feiker-Hollenbeck & Patrikakou, 2014). Teachers' accountability for student progress has been key to the framework, while school leadership and collaboration with families are also fundamental aspects of this model. Stormshak et al.'s (2015) recommendation that implementation of evidence-based practices within existing service-delivery settings and mandated initiatives already in place can minimize impediments inherent in scale-up implementations is an important one.

Inherent in the premise of utilizing existing service-delivery models is the assumption that home-school partnerships are an integral part of broader interventions. Indeed, as Sheldon (2015) denotes, robust school-family-community partnerships

are essential in fostering school improvement. Family involvement has long been part of federal policy (e.g., the Elementary and Secondary Education Act, Individuals with Disabilities Education Act) and recently calls for its integration into broader educational reform have been intensified (e.g., The Southwest Educational Development Laboratory, 2013).

Contextual Perspectives

There are several contextual parameters involved in home–school partnerships and related programming, and the chapters in this volume presented these multifaceted parameters in an exemplary way. Sheridan et al. (2015) discuss the contextual factors that are nested within family involvement or partnership intervention research. Such factors affect the research plan (e.g., recruitment, attrition, mobility), the sustainability of an intervention in a particular setting (e.g., fit between programming and setting-specific needs), or both research and practice components (e.g., fidelity of implementation). Stormshak et al. (2015) also underline the importance of broader contextual factors in research and intervention, but discuss contextual elements unique to each school or site. On a broader level, authors highlight the importance of already established structures serving as the hosting context of home–school interventions. On a more targeted level, authors address idiosyncratic issues that affect family-centered interventions and their broader dissemination and implementation, such as lack of resources and school personnel training, as well as the nature of school leadership and school climate.

Sheldon (2015) further identifies the surrounding administrative, leadership context that has a significant impact on ways that home outreach gets implemented in schools around the USA. Inherent in this contextual theme lie elements, also identified in other chapters, such as teamwork, goal-orientation, and responsive implementation. Knoche (2015) directly acknowledges the importance of context in family–school partnership research as well as for child, family, and educational policy; focuses on implications stemming from contextual dynamics created by the intersection of research and policy; and calls for a more synergetic approach when addressing home–school collaborations. The author emphasizes that the information flow between these two spheres of influence must be reciprocal with research informing policy, or at least policy-makers, and with researchers being more attuned with the level of relevancy their investigation has with policy objectives.

Kwok et al. (2015) build on Knoche's (2015) call for collecting, analyzing, and reporting comprehensive contextual descriptions to enhance the scaling-up of evidence-based programs, as well as to gain support by policy-makers for the wide implementation of home–school partnership programming. Authors of this chapter put the focus on such identifiable contextual characteristics that moderate the effects of home–school relationships and should be taken into account when designing or implementing home–school partnerships. Whether examining demographic-, family-, school-, or child-specific attributes, selecting the appropriate statistical

methods to parse out the not-so-obvious nuances is essential to inform further program design efforts and provide a more comprehensive description of the contextual factors under investigation.

Moving Forward

The chapters in this volume have detailed the importance of various contextual and methodological aspects in the study of home–school partnerships. The call made by authors to clearly design, implement, and evaluate partnership interventions is especially challenging, as it requires to address concretely the multidimensional nature of home–school relations. Papers in this volume offer distinct and tangible ways to advance research in this area. Specifically, chapter authors draw attention to (a) critical issues involved in the fidelity of implementation of intervention programs; (b) the analysis and interpretation of results, methodologically addressing the multidimensionality of home–school partnerships; (c) the training of the next generation of teachers to effectively integrate home–school partnerships in their practice; and (d) reaching out to policy-makers and policy-enforcers to garner support for developing and maintaining strong home–school partnership programs. Most importantly, the work presented in this volume highlights the fact that a viable and valuable research agenda in the area of home–school partnerships can be methodologically robust and successfully address the complexities inherent in this line of inquiry.

As the variables, processes, and effects (direct, indirect, and moderated) associated with family involvement and home–school partnerships have become more clear over the past three decades, a major new factor has rapidly taken traction and wedged itself among all these factors, and will take the field swiftly into a new era. Easy access to technology and the Internet is changing the way that families conduct their daily lives, connect with schools and the community, and enhance their children’s learning opportunities. This rapidly changing nature of relationships will affect the field of home–school partnerships in profound ways. Given the socio-historical impact of technology and media infusion on daily life, such a profound contextual change serves as a good example of the bioecological framework’s importance of chronosystemic influences.

The prospect of exploring the impact of new forms of connectedness both among family members, as well as between home and school is an exciting prospect. Some of the critical issues raised in the chapters of this volume as impeding implementation of effective programs may be mediated and potentially moderated by the use of technology (e.g., recruitment, attrition, mobility, or to a certain extent, fidelity); other issues may become pronounced and would need to be further addressed (e.g., lack of resources or decreased family time); and yet others will be significantly enhanced (e.g., the development of the learner’s personal competencies).

The basic principles underlining good research approaches or effective programming that were discussed in the chapters of this volume will not shift in the same way that responsive, caring parenting and the responsive, caring education have not

changed. However, due to rapid technological developments, the enormous change in modes of communication and instruction-delivery options does have an impact on the way research questions will be formed and the manner in which interventions will be structured and delivered.

As exemplified by chapters in this volume, integrating contextual elements is a central aspect of research and intervention work in the field of home–school partnerships. In this era of rapidly evolving demands for technological awareness and use, integrating this new contextual dimension of technology and media seems as the vital next step. Better understandings of the way these applications affect parent, teacher, and student interactions, and outreach to families, will further enhance the carefully established knowledge and practice, and make future policy mandates pertinent to the shifting needs of the twenty-first century.

References

- American Academy of Pediatrics Committee on School Health. (2004). School-based health services. *Pediatrics*, *113*, 1839–1845.
- Bronfenbrenner, U. (1979). *The ecology of human development: Experiments by nature and design*. Cambridge, MA: Harvard University.
- Bronfenbrenner, U. (1986). Ecology of the family as a context for human development: Research perspectives. *Developmental Psychology*, *22*, 723–742.
- Bronfenbrenner, U. (1994). Ecological models of human development. In T. Husen & T. N. Postlewaite (Eds.), *International encyclopedia of education* (Vol. 3, pp. 1643–1647). Oxford, United Kingdom: Elsevier Sciences.
- Bronfenbrenner, U., & Ceci, S. J. (1994). Nature-nurture reconceptualized in developmental perspective: A bioecological model. *Psychological Review*, *101*, 568–586.
- Elias, M. J., Patrikakou, E. N., & Weissberg, R. P. (2007). A competence-based framework for parent-school-community partnerships in secondary schools. *School Psychology International*, *28*, 540–554.
- Feiker-Hollenbeck, A., & Patrikakou, E. N. (2014). Response to Intervention in Illinois: An exploration of school professionals' attitudes and beliefs. *Mid-Western Educational Researcher*, *26*, 58–82.
- Hoekstra, A., & Korthagen, F. (2011). Teacher learning in a context of educational change: Informal learning versus systematically supported learning. *Journal of Teacher Education*, *62*, 76–92.
- Knoche, L. L. (2015). Research issues to forward a policy agenda in support of family–school partnerships. In S. M. Sheridan & E. M. Kim (Eds.), *Family-school partnerships in context*. New York, NY: Springer.
- Kwok, O.-M., Im, M., Hughes, J. N., Wehrly, S. E., & West, S. G. (2015). Testing statistical moderation in research on home-school partnerships: Establishing the boundary conditions. In S. M. Sheridan & E. M. Kim (Eds.), *Family-school partnerships in context*. New York, NY: Springer.
- Patrikakou, E. N. (1996). Investigating the academic achievement of adolescents with learning disabilities: A structural modeling approach. *Journal of Educational Psychology*, *88*, 435–450.
- Patrikakou, E. N. (2004). Adolescence: Are parents relevant to students' high school achievement and post-secondary attainment? *The Harvard Family Research Project. Family Involvement Network of Educators: Research Digests*. From <http://gseweb.harvard.edu/hfrp/projects/fine/resources/digest/adolescence.html>

- Patrikakou, E. N. (2015). Relationships among parents, students, and teachers: The technology wild card. *Procedia Journal of Social and Behavioral Science*, 174, 2253–2258.
- Patrikakou, E. N., Weissberg, R. P., Redding, S., & Walberg, H. J. (Eds.). (2005). *School-family partnerships: Fostering children's school success*. New York, NY: Teachers College Press.
- Redding, S. (2014). *Personal competency: A framework for building students' capacity to learn*. Center on Innovations in Learning, Temple University. Retrieved from http://www.centeril.org/publications/Personal_Competency_Framework.pdf
- Sheldon, S. B. (2015). Moving beyond monitoring: A district leadership approach to school, family, and community partnerships. In S. M. Sheridan & E. M. Kim (Eds.), *Family-school partnerships in context*. New York, NY: Springer.
- Sheridan, S., Cowan, R., & Meegan, T. (1999). The times, they are a changing: A review of raising children in a socially toxic environment. *School Psychology Quarterly*, 14, 428–432.
- Sheridan, S. M., Holmes, S. R., Smith, T. E., & Moen, A. L. (2015). Complexities in field-based partnership research: Exemplars, challenges, and an agenda for the field. In S. M. Sheridan & E. M. Kim (Eds.), *Family-school partnerships in context*. New York, NY: Springer.
- Sheridan, S., Knoche, L., Edwards, C., Bovaird, J., & Kupzyk, K. (2010). Parent engagement and school readiness: Effects of the getting ready intervention on preschool children's social-emotional competencies. *Early Education and Development*, 21, 125–156.
- Southwest Educational Development Laboratory. (2013). *Partners education in a dual capacity-building framework for family-school partnerships*. Retrieved March, 2014, from <http://www2.ed.gov/documents/family-community/partners-education.pdf>
- Spillane, J. P., Reiser, B. J., & Reimer, T. (2002). Policy implementation and cognition: Reframing and refocusing implementation research. *Review of Educational Research*, 72, 387–431.
- Stein, B., Sontag-Padilla, L., Chan Osilla, K., Woodbridge, M., Kase, C., Jaycox, L., ... & Golan, S. (2012). *Interventions to improve student mental health*. Retrieved September, 2014, from http://www.rand.org/content/dam/rand/pubs/technical_reports/2012/RAND_TR1319.pdf
- Stormshak, E. A., Brown, K. L., Moore, K. J., Dishion, T., Seeley, J., & Smolkowski, K. (2015). Going to scale with family-centered, school-based interventions: Challenges and future directions. In S. M. Sheridan & E. M. Kim (Eds.), *Family-school partnerships in context*. New York, NY: Springer.
- Twyman, J. S. (2014). Competency-based education: Supporting personalized learning. *Connect: Making Learning Personal*. Center on Innovations in Learning, Temple University. Retrieved from http://www.centeril.org/connect/resources/Connect_CB_Education_Twyman-2014_11.12.pdf

Index

A

- Administration, 35
- An Action Team for Partnerships (ATP), 47, 51, 55, 56, 59
- The Arizona State Parent Information and Resource Center (PIRC), 56

B

- Bioecological model
 - Bronfenbrenner's broader bioecological framework, 110
 - children's learning and behavior, 112
 - chronosystem, 111
 - empirical and theoretical work, 110–111
 - family–school partnerships, 110, 111
 - home–school–community partnership programs, 112
 - home–school partnerships, 110
 - human development, 112
 - individual and contextual characteristics, 111
 - Local Education Agencies, 112
 - macrosystemic and exosystemic policy factors, 112–113
 - mesosystem, 111
 - mesosystemic interactions, 113
 - microsystem of family, 112
 - multidimensionality, 113
 - policy-making, 113
- Bronfenbrenner's broader bioecological framework, 110

C

- CBC. *See* Conjoint behavioral consultation (CBC)
- Center for Law and Social Policy (CLASP), 74

Centering variables, 99

CLASP. *See* Center for Law and Social Policy (CLASP)

- Community engagement and family data-driven educational approach, 61
- district approach, 60
- goal-oriented plans, 48
- A Match on Dry Grass*, 67
- responsive implementation, 48
- school–family partnerships, 112
- schools' approach, 46–47

Conjoint behavioral consultation (CBC)

- educational problem-solving, 8
- empirical support, 8–10
- families and schools, 69
- family–school partnership, 7
- and Getting Ready, 10, 112
- operationalized stages, 7
- stages, 7–8

Conjoint behavioral consultation stages, 8

Contextual perspectives, 113, 116–18

D

- Developmental considerations, 14–15
- Dissemination
 - contextual perspectives, 117
 - family support services, 29
 - prevention and intervention programs, 27
 - products, 75
- District leadership and direct facilitation strategies, 52

E

Early childhood professionals (ECPs), 4–6

F

- Family-centered approach
 - evidence-based practices
 - contextual factors in schools, 27
 - family-centered treatment models, 26
 - family-school partnerships, 27–28
 - interventions on individual child/school context, 26
 - Little theory, 26
 - multiple barriers, 26
 - positive family support program, 28–31
 - program fidelity, 27
 - in high-SES, 38
 - multitiered family-school partnerships, 39
 - research and training, 39
 - school-based scale-up
 - attitude toward parents, 36–37
 - contextual factors, 31
 - critical events, 36
 - lack of resources, 31–33
 - program integration, 37–38
 - school climate, 35–36
 - school leadership, 34–35
 - school staff training and experience, 33–34
 - students, 25
 - WHO and CDC, 25
- Family Check-Up (FCU), 28
- Family engagement
 - direct facilitation, 55
 - district-community collaborations, 61
 - district leadership, 55
 - evaluation, 49
 - fidelity in partnership research, 16
 - responsive implementation, 48–49
 - schools' approach, 46
- Family Engagement Action Teams (FEATs), 55
- Family-school partnership
 - attrition and mobility, 13–14
 - bioecological model (*see* Bioecological model)
 - conjoint behavioral consultation, 7–10
 - definitions, 2–3
 - fidelity issues, 16
 - Getting Ready intervention, 4–7
 - multidimensional nature, 11–12
 - parental involvement practices, 1
 - poor parenting practices, 27–28
 - positive family support program, 28–31
 - recruitment, 12–13
 - researchers, 75
 - research evidence, 65–66
 - scholars and policy makers, 68

- school climate, 35–36
- school leadership, 34–35
- school staff training and experience, 33–34
- in school tends, 28
- specification, 17–18
- translational methods, 18–19
- FEATs. *See* Family Engagement Action Teams (FEATs)
- Fidelity in partnership research, 16
- Field-based partnership research. *See also* Family-school partnership
 - CBC (*see* Conjoint behavioral consultation)
 - Getting Ready intervention, 4–7
 - parental involvement, 2
 - research and practice contexts
 - attrition and mobility, 13–14
 - fidelity analysis, 19–20
 - fit, 14–15
 - recruitment, 12–13
 - relational context, 14–15
- Full information maximum likelihood (FIML), 97

G

- Getting Ready model
 - and CBC, 4
 - Head Start ECPs, 7
 - partnership-oriented approach, 4–5
 - research support, 6–7
- Getting Ready strategies, 5
- Government, 45, 65–67, 69, 75

H

- Home-school partnerships
 - ADHD symptoms, 80
 - advantages, 99
 - children's academic and behavioral function, 79
 - children's school adjustment
 - child and family characteristics, 81
 - demographic characteristics, 80
 - moderation effects, 81
 - statistical moderation in journals, 81–82
 - interaction effects, 97
 - noncontinuous/categorical variable, 97–99
 - parent academic involvement, 79
 - rescaling/centering variables, 99
 - statistical moderation in actual data
 - home-school relationship, 83
 - hyperactivity, 82, 83

- hypothesized model 1a, 83–88
 - hypothesized model 1c, 93–94
 - hypothesized model 1d, 95–96
 - peer acceptance, 83
 - revised hypothesized model 1a, 89–93
 - teacher-rated home–school relationship, 82
 - Home–school relationship (HSR)
 - children's school adjustment
 - child and family characteristics, 81
 - demographic characteristics, 80
 - moderated effects of, 80
 - moderation effects, 81
 - statistical moderation in journals, 81–82
 - Hypothesized model 1a, 83–88
 - Hypothesized model 1c, 93–94
 - Hypothesized model 1d, 95–96
- I**
- Integrative framework, family–school partnerships, 111
 - Interaction effects
 - Aiken and West's approach, 91
 - home–school relationship and hyperactivity, 86
 - hypothesized model 1d, 95
 - LMS approach, 93, 94
 - noncontinuous/categorical variable, 97–99
 - non-normality, 93
 - rescaling/centering variables, 99
 - teacher-rated home–school relationship, 87
- K**
- Knowledge utilization
 - affecting thoughts, behaviors and actions, 67–68
 - push–pull infrastructure model, 69
 - research data, 67
 - researchers, 66
 - timeline for policy makers, 66
- L**
- Latent interaction factor
 - hypothesized model 1c with distribution-analytic approach, 93–94
 - product-indicator approach, 89
 - revised hypothesized model 1b, 89–90
 - Latent moderated structural equations (LMS) approach, 87, 93, 94
 - Leadership
 - align program and policy, district leadership, 54
 - celebrate milestones, district leadership, 57
 - create awareness, district leadership, 53
 - district-level leadership, 51, 52
 - document progress and evaluate outcomes, district leadership, 58
 - guide learning and program development, district leadership, 55
 - instructional leadership in schools, 50
 - school leadership, 34–35
 - share knowledge, district leadership, 56
 - LMS approach. *See* Latent moderated structural equations (LMS) approach
- M**
- Mental health
 - children, 26
 - developmental considerations, 114
 - positive family–school partnership, 33
 - Missing data, 97, 99
 - Moderation effects, 80–82, 91, 99
 - Moderation model
 - composite scores, 85
 - latent factors, 85
 - LMS approach, 86
 - reliability-adjusted composite score, 86
 - MTSS. *See* Multi-Tiered System of Supports (MTSS)
 - Multidimensionality
 - contextual perspectives, 116–118
 - developmental considerations and personal competencies, 114–115
 - home–school partnerships, 115–116
 - and partnerships, 110, 113
 - Multilevel data, 82, 83, 90, 94
 - Multi-Tiered System of Supports (MTSS), 116
- N**
- National Center for Children in Poverty (NCCP), 74
 - Noncontinuous/categorical variable, 98
- O**
- Ordinary least squares (OLS) regression, 87
- P**
- Parental involvement, 2, 3, 28, 80
 - Parenting, 26, 28, 38

- Partnership implementation, 48
 - PBIS. *See* Positive Behavior Interventions and Supports (PBIS)
 - Personal competencies, 114–115
 - Policy
 - align program
 - direct facilitation, 54
 - district leadership, 54
 - broader macrosystemic and exosystemic, 112–113
 - decision maker, 66
 - education, 74–75
 - family-school partnership research, 117
 - high-quality research, 69–70
 - individuals, 66
 - information targets, 73–74
 - initiatives, 116
 - inside and outside of the school system, 15
 - NCCP, 74
 - policy-makers and policy-enforcers, 118
 - policy makers and researchers, 66
 - and practice communities, 68, 69
 - products, 75
 - sanction-based, 46
 - teachers' and administrators' attention, 45
 - Positive Behavior Interventions and Supports (PBIS), 29, 32, 38
 - Positive Behavior Support, 26, 29, 33
 - Positive Family Support Project, 30
 - Prevention
 - dissemination, 27
 - district-wide drop-out, 68
 - school-based, 32
 - Public policy, 32, 45, 69, 113
 - Push-pull infrastructure, 69
- R**
- Randomized controlled trials (RCTs), 9, 10
 - RCTs. *See* Randomized controlled trials (RCTs)
 - Reliability-adjusted scores, 86, 99
 - Response of Intervention (RTI), 116
 - Revised hypothesized model 1a, 89–93
- S**
- School–community partnerships, 112
 - School district, 46, 47, 53, 56.
 - See also* Leadership
 - School–family partnerships, 112
 - Structural equation modeling (SEM)
 - framework, 87, 94, 98
- T**
- Technology and media, 110, 111, 118