

PROGRESS IN
MEDICINAL CHEMISTRY 27

G. P. ELLIS
G. B. WEST
EDITORS

Progress in
Medicinal Chemistry 27

This Page Intentionally Left Blank

Progress in Medicinal Chemistry 27

Edited by

G.P.ELLIS, D.SC., PH.D., F.R.S.C.

*School of Chemistry and Applied Chemistry,
University of Wales,
P.O. Box 13,
Cardiff, CF1 3XF,
United Kingdom*

and

G.B. WEST, B. PHARM., D.SC., PH.D., F.I.BIOL.

*Department of Medical Sciences and Health Studies,
Polytechnic of East London,
Romford Road,
London, E15 4LZ,
United Kingdom*

1990



ELSEVIER
AMSTERDAM · NEW YORK · OXFORD

© 1990, Elsevier Science Publishers B.V. (Biomedical Division)

All rights reserved. No part of this publication may be reproduced, stored in a retrieval system or transmitted in any form or by any means, electronic, mechanical, photocopying, recording or otherwise without the prior written permission of the Publisher, Elsevier Science Publishers B.V. (Biomedical Division), P.O. Box 1527, 1000 BM Amsterdam, The Netherlands.

No responsibility is assumed by the Publisher for any injury and/or damage to the persons or property as a matter of products liability, negligence or otherwise, or from any use or operation of any methods, products, instructions or ideas contained in the material herein. Because of rapid advances in the medical sciences, the Publisher recommends that independent verification of diagnoses and drug dosages should be made.

Special regulations for readers in the USA:

This publication has been registered with the Copyright Clearance Center Inc. (CCC), Salem, Massachusetts. Information can be obtained from the CCC about conditions under which the photocopying of parts of this publication may be made in the USA. All other copyright questions, including photocopying outside of the USA, should be referred to the publisher.

ISBN 0-444-81309-8

ISBN Series 0-7204-7400-0

Published by:

Elsevier Science Publishers B.V. (Biomedical Division)
P.O. Box 211
1000 AE Amsterdam
The Netherlands

Sole distributors for the USA and Canada:
Elsevier Science Publishing Company, Inc.
655 Avenue of the Americas
New York, NY 10010
USA

Library of Congress Cataloging in Publication Data

Please refer to card number 62-27/2 for this series

Printed in The Netherlands
This book is printed on acid-free paper

Preface

We have pleasure in presenting eight reviews in this volume, all of which cover important advances in the chemistry and biology of products of medicinal interest.

Chapter 1 reviews the wide-ranging biochemical and pharmacological activities of pyridazine derivatives, the novel non-steroidal anti-inflammatory analgesic emorfazone being of particular interest. The stability of drugs to light, discussed in Chapter 2, has long been a matter of concern since photolysis can lead to toxic or allergic products being formed during storage of a drug.

Chapter 3 describes the 1-benzazepine family, particularly in relation to their use in the treatment of certain forms of hypertension resulting from inhibition of angiotensin-converting enzymes. In Chapter 4, regulation of the role of mast cells in the control of the microenvironment, and tissue growth and repair by many endogenous peptides is reviewed.

Mercury and nickel salts form many stable complexes with biologically important molecules such as those containing sulphhydryl groups; Chapter 5 stresses the importance and the dangers of these being formed in the skin from topical contact. The last 10 years have been a highly fertile and productive period in the discovery of antibacterial quinolones (reviewed in Chapter 6) which inhibit target enzymes at the molecular level.

Chapter 7 outlines the basic mechanism and treatment of emesis, and in particular, that induced by chemotherapy of cancer. Finally, the chemistry, pharmacology and clinical applications of antagonists of the platelet-activating factor (PAF), an important mediator of many physiological and pathological conditions, are reviewed in Chapter 8.

We thank our authors for surveying the literature of the several aspects of medicinal chemistry. We also offer our thanks both to owners of copyright material who have given their permission for it to be reproduced in this volume, and to the staff of our publishers for their invaluable help and encouragement.

July 1989

G.P. Ellis
G.B. West

This Page Intentionally Left Blank

Contents

Preface	v
1. Pharmacologically Active Pyridazine Derivatives. Part 1	1
G. Heinisch, Univ. Prof., Dr. Phil., Mag. Pharm. and H. Frank, Dr. Rer. Nat., Mag. Pharm. <i>Institute of Pharmaceutical Chemistry, University of Vienna, Währinger Strasse 10, A-1090 Vienna, Austria</i>	
2. Photodecomposition of Drugs	51
J.V. Greenhill, Ph.D., B.Pharm. and M.A. McLelland, Ph.D., B.Sc. <i>Pharmaceutical Chemistry, School of Pharmacy, University of Bradford, Bradford, BD7 1DP, U.K.</i>	
3. Medicinal Chemistry of 1-Benzazepines	123
K. Hino, Ph.D. and J.-i. Matsumoto, Ph.D. <i>Research Laboratories, Dainippon Pharmaceutical Co. Ltd., Enoki 33-94, Suita, Osaka 564, Japan</i>	
4. Peptide Regulation of Mast-Cell Function	143
D.E. Cochrane, Ph.D. <i>Department of Biology, Tufts University, Medford, MA 02155, U.S.A.</i>	
5. Biological Effects of Mercuric Chloride, Nickel Sulphate and Nickel Chloride	189
K. Nordlind, M.D., Ph.D. <i>Department of Dermatology, Karolinska Hospital, S-104 01 Stockholm, Sweden</i>	
6. The Fluoroquinolone Antibacterial Agents	235
T. Rosen, Ph.D. <i>Department of Medicinal Chemistry, Pfizer Central Research, Groton, CT 06340, U.S.A.</i>	

(continued)

7. Developments in the Antiemetic Area: Chemistry, Pharmacology and Therapy	297
I. Monković, Ph.D. ¹ and J.A. Gylys, Ph.D. ²	
<i>¹Anti-Tumor Chemistry and ²CNS Biology, Bristol-Myers Squibb Company, Pharmaceutical Research and Development Division, Wallingford, CT 06492-7660, U.S.A.</i>	
8. Antagonists of Platelet-Activating Factor: Chemistry, Pharmacology and Clinical Applications	325
D. Hosford, Ph.D. and P. Braquet, Ph.D., D.Sc.	
<i>Institut Henri Beaufour Research Labs., 17 Avenue Descartes, 92350 Le Plessis-Robinson, France</i>	
Index	381
Author Index (Vols. 1-27)	391
Subject Index (Vols. 1-27)	395

1 Pharmacologically Active Pyridazine Derivatives. Part 1

GOTTFRIED HEINISCH, Univ. Prof., Dr. Phil., Mag. Pharm. and
HANNELORE FRANK Dr. Rer. Nat., Mag. Pharm.

*Institute of Pharmaceutical Chemistry, University of Vienna, Währinger Strasse 10,
A-1090 Vienna, Austria*

INTRODUCTION	2
ANALGESIC AND ANTI-INFLAMMATORY AGENTS	3
ANTISECRETORY AND ANTI-ULCER AGENTS	8
ANTIDEPRESSANTS	10
NEUROLEPTICS AND ANXIOLYTICS	12
SEDATIVE-HYPNOTICS AND TRANQUILLIZERS	13
ANTICONVULSANTS	13
CENTRALLY ACTING MUSCLE RELAXANTS AND ANTIPARKINSONISM AGENTS	15
GABA ANTAGONISTS	16
BLOOD PLATELET AGGREGATION INHIBITORS AND ANTITHROMBOTICS	17
ANTITUMOUR AGENTS	20
IMMUNOSUPPRESSANT AGENTS	24
ANTIVIRAL AGENTS	24
ANTIBACTERIAL AGENTS	25
ANTIFUNGAL AGENTS	32

ANTIALLERGIC AGENTS	34
ACKNOWLEDGEMENTS	35
REFERENCES	35

INTRODUCTION

In 1886 the first examples of compounds containing two adjacent nitrogen atoms in a six-membered ring were reported [1]. The preparation of the parent system pyridazine or 1,2-diazine (1) was described as early as 1895 by Täuber [2]. Compared with the 1,3- and the 1,4-diazine systems (pyrimidine and pyrazine), however, the pyridazine system for a long period attracted little attention in medicinal chemistry.



(1)

However, since 1971, when pyridazine derivatives (cyclohexadepsipeptides containing a hexahydro-3-pyridazinecarboxylic acid moiety as characteristic subunit) were found for the first time in nature [3], an enormous number of papers and patents dealing with the biological activities of pyridazine have been published. Quite recently, the first example of a naturally occurring pyridazine derivative containing the fully unsaturated heterocycle, an antifungal antibiotic named pyridazomycin, has been described [4]. This report may well stimulate further increasing interest in the chemistry and the biological activities of pyridazines.

The chemistry of pyridazine derivatives is now covered comprehensively by several monographs and review articles [5–9], one of these [7] also providing references regarding biological activities up to 1977. In addition, review articles have been published on the antimicrobial activity [10], the antihypertensive activity [11] and the GABA-antagonism [12] of pyridazine derivatives. The chemotherapeutic activity of pyridazine nucleosides [13] and the therapeutic potential of 3-aminopyridazines [14] have been reviewed, too. There is also a recent article summarizing syntheses directed mainly to selected herbicidal, insecticidal and fungicidal pyridazines [15].

A review of pharmacologically active pyridazines, however, has not been available so far. The present chapter represents an attempt to discuss the

literature as covered by *Chemical Abstracts* from 1975 (Vol. 82) through to 1988 (Vol. 108). *Chemical Abstracts* has been searched by a computer-aided program. For the present, only monocyclic pyridazines will be reviewed; fused systems are not included, despite the fact that numerous carbocycle or heterocycle annulated 1,2-diazines are of pharmacological interest.

Due to the large number of references which appeared to be worth mentioning, it became necessary to divide this review into two parts. The present part deals mainly with pyridazines as chemotherapeutics, antithrombotics, antisecretory and anti-ulcer agents, analgesic and anti-inflammatory agents as well as with various central nervous system stimulants and depressants. Part 2 of this review, which is planned for a future volume of this Series, will be devoted mainly to compounds which act on the cardiovascular system and to a discussion of miscellaneous additional pharmacological activities of pyridazine derivatives.

Throughout this review, emphasis will be placed on publications in scientific journals; patents claiming biological activities will be mentioned only briefly. The formulae given for classes of compounds represent selected typical structures. In order to ensure lucidity of the presentation, not all the substituents listed in a patent are shown.

Despite the authors' intention to provide a comprehensive survey, it was impossible to include all of the relevant references in this review due to space limitations. Accordingly, the authors wish to apologize to those contributors to research on this subject whose results are not discussed appropriately.

ANALGESIC AND ANTI-INFLAMMATORY AGENTS

Attempts to develop novel drugs by (formal) ring enlargement of pyrazolone-derived analgesic anti-inflammatory agents date back to the early fifties, when a Swiss research group prepared a series of pyridazinones structurally closely related to aminopyrine [16]. In continuation of these efforts during the seventies, a variety of 2-alkyl-3(2*H*)-pyridazinones of type (2, R^1 = substituted amino; R^2, R^3 = alkyl) have been synthesized and tested in Japan [17-23]. From these studies, the novel nonsteroidal analgesic anti-inflammatory agent 4-ethoxy-2-methyl-5-morpholino-3(2*H*)-pyridazinone (3) (emorfazone, M 73101; CAS 38957-41-4) emerged [24, 25].

Also 2-alkylpyridazinones of type (4, R^1, R^2 = alkyl) [26, 27] and type (5, R^1, R^2 = alkyl) [28, 29], being regioisomers of compounds (2), as well as thio-analogues (6, R^1, R^2 = alkyl) [30] and 2-alkenyl congeners [31], have been reported in the patent literature to exhibit such activities. Structure-activity

relationships in these classes of compounds have been discussed in some detail [24, 32]. Out of a series of 2-substituted-4,5-dihalo-3(2*H*)-pyridazinones, recently prepared in Italy [33], compound (7) (CAS 14305-08-9) appears to be worth mentioning as it possesses marked analgesic and anti-inflammatory activity and low toxicity. Likewise, various 6-aryl-3(2*H*)-pyridazinones have been claimed in a patent as analgesic and anti-inflammatory agents [34].

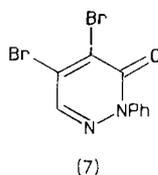
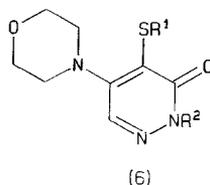
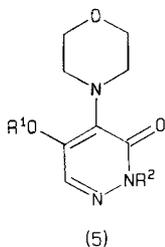
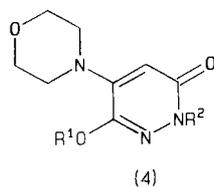
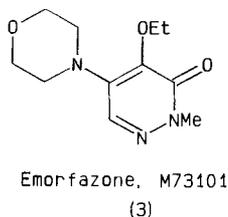
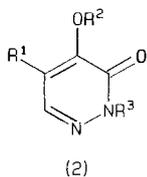

Emorfazone (3) exhibits activities equal to or even more potent than those of basic analgesic anti-inflammatory drugs [25, 32, 35, 36], with no inhibiting action on prostaglandin biosynthesis [37, 38]. Inhibition of vascular permeability [39] and of bradykinin release [37] was observed with (3). It has been found that the anti-inflammatory action of (3) may be due in part to pituitary-adrenocortical stimulation [40].

Electroencephalographic and cardiovascular studies of (3) have been performed [41]. There is also a detailed report on the action of (3) on the central nervous system [42] and on the effect of (3) on β -endorphin release in rats [43]. It has been shown that (3) does not produce physical dependence upon chronic administration to animals [44].

The acute toxicity of emorfazone was found to be equal to or less than that of aminopyrine depending on animal models used [45]. From chronic toxicity tests [46, 47], safe doses of 30 mg/kg per day (rats) or 120 mg/kg per day (dogs) were deduced. In rats, no significant effects of (3) on the reproductive activity or newborn development were observed [48–50], nor were adverse effects on the embryos found when (3) was given to rabbits, rats or mice during the period

of major organogenesis [51, 52]. From *in vivo* cytogenetic studies of (3) and two of its major metabolites, it has been concluded that these compounds are not mutagenic [53, 54].

Investigations of the pharmacokinetics and the metabolism of emorfazone in various animals [55–61] and in man [62] have shown that oxidative cleavage of the morpholine ring was the major metabolic pathway leading to (8, $R^1 = H$, $R^2 = (CH_2)_2OCH_2COOH$) and (9, $R^1 = (CH_2)_2OH$; $R^2 = CH_2COOH$). Several metabolites isolated from urine of patients have been synthesized [63]. Pharmacological studies of the urinary metabolites indicated the activities of (3) are not due to these degradation products [64].

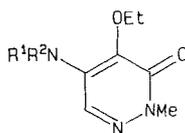

(8) (9)

From investigations of the effect of emorfazone on liver drug-metabolizing enzymes, (3) has been classified as a phenobarbitone (phenobarbital)-type inducer of enzymes [65]. For results of clinical evaluations of emorfazone, see [66, 67].

Emorfazone has been launched as Pentoil, Pentoyl, Nandron. Synergistic analgesic formulations containing (3) and either acetaminophen (paracetamol), sulpyrine (dipyron), grafinin or phenylbutazone were claimed in patents [68, 69]. The combined use of emorfazone with different non-steroidal acidic anti-inflammatory drugs has been reported to be beneficial [70, 71].

3-Amino-4-mercapto-6-methylpyridazine (10) (pyridazine S_1 ; CAS 18591-81-6) represents another newly discovered antipyretic, analgesic and anti-inflammatory agent [72]. It was the most effective compound among several mercaptopyridazines tested in the German Democratic Republic [73–75]; the acute toxicity was found to be low ($LD_{50} \approx 10$ mmol/kg p.o.; mouse) [74].

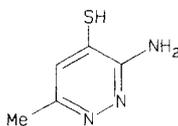
Pyridazine S_1
(10)

The effect of (10) in acute inflammation models has been reported to be comparable with that of acetylsalicylic acid but to be less than that of phenylbutazone and indomethacin [76]. A comparative study on the antipyretic activity of (10) and some standard drugs in rats with yeast-induced hyperthermia [77] revealed similar activity to acetylsalicylic acid, phenacetin and aminophenazone (ampyrone). Based on the finding that this activity of (10) was not inhibited by atropine, a central nervous system mechanism of action has been considered [77]. The analgesic activity was investigated in mice by employing various screening methods [78]. When applied subcutaneously, (10) and aminophenazone showed almost equal analgesic activity, whereas (10) proved to be less potent than aminophenazone when administered orally. This might be attributed to incomplete resorption of (10) from the gastrointestinal tract. The analgesic activity of orally applied (10) was found to be greater than that of acetylsalicylic acid and phenacetin, similar to that of phenylbutazone but less than that of indomethacin. The acute oral toxicity of (10) was comparable with that of phenacetin but less than that observed with the other standard analgesics investigated [78].

Anti-inflammatory activity against carrageenin-induced edema has been reported for 3-hydrazinopyridazine derivatives of type (11, $R^1, R^2 = \text{aryl}$) [79], (12) [80], (13, $R = \text{substituted amino}$) [81], as well as for some 3-(1-pyrazolyl)pyridazines, for example (14) [82, 83]. 1-(2-Pyridyl)tetrahydropyridazines (15) [84] and 4-(4-pyridyl)-3(2*H*)-pyridazinones (16) [85] were also claimed as inflammation inhibitors. Within a series of 6-oxo-1(6*H*)-pyridazinylacetamide derivatives synthesized and tested in Spain [86], several compounds of type (17, $R^1 = \text{Me, aryl}$; $R^2 = \text{H, alkyl}$; $R^3 = \text{Ph, PhCH}_2$) were reported to exhibit anti-inflammatory and analgesic activity. As a typical example, isamfazone (Pir 353; CAS 55902-02-8) (17, $R^1 = \text{Ph}$, $R^2 = \text{Me}$, $R^3 = \text{CH}_2\text{Ph}$) has to be mentioned. Pyridazinylacetohydrazides (18, $R = \text{aryl}$) [87] and 2-phenyl-2-(3-pyridazinyl)thioacetamide [88] have also been patented as analgesic agents.

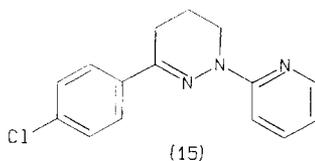
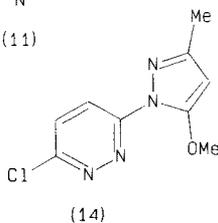
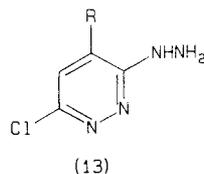
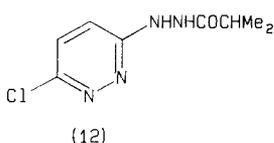
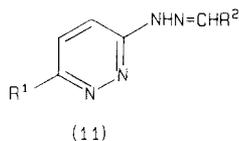

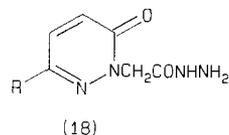
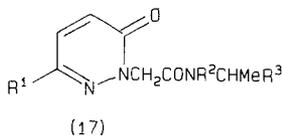
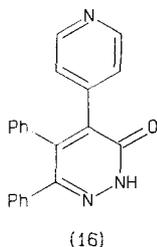

Compound R 62818 (19, CAS 104719-71-3), recently developed in Belgium [89], represents an interesting new analgesic agent. From a comparative investigation [90], it has been concluded that this 3-piperazinopyridazine derivative represents a safer, slightly more potent and more specific analgesic than codeine, with a shorter duration of action and an activity profile not typically morphine-like.

From a series of 5,6-diphenylpyridazines prepared in Italy [91], chloro derivatives of type (20, R = 4-Me₂NC₆H₄, 4-MeOC₆H₄) have been found to be anti-inflammatory, analgesic and antipyretic agents superior to phenylbutazone when tested in mice or rats.

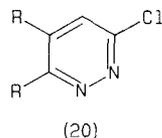
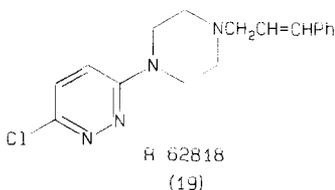

Quite recently, a French group reported on the synthesis of 2-substituted 5-arylidene-pyridazinones as represented by the general formula (21, R¹ = Ph, 2-ClC₆H₄; R² = Ph(CH₂)₂, PhCO). These compounds were found to exhibit significant dose-dependent analgesic activity (phenylquinone-induced writhing test in mice; oral administration) [92]. For a novel type of aminopyridazine-derived inhibitors of prostacyclin biosynthesis, see [93].

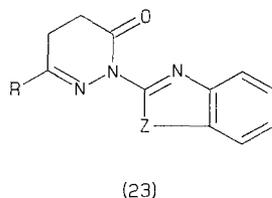
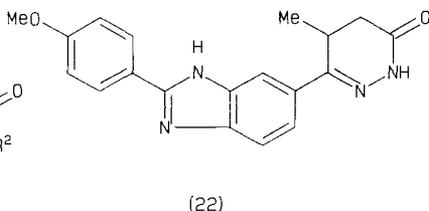
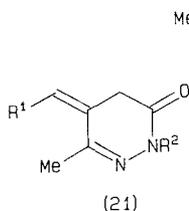

Benzimidazolypyridazinones as represented by compound (22), which were prepared and tested as adenosine antagonists in West Germany, have to be mentioned, too. These compounds were found to be 40-fold more effective in inhibiting the vasodilating effect of adenosine compared with caffeine, when administered i.v. to dogs in doses of 10–100 $\mu\text{g}/\text{kg}$, and thus were claimed as agents for the prophylaxis and treatment of migraine [94]. In India, benzimidazolyl- and benzothiazolyl-pyridazinones of type (23), R = substituted Ph; Z = NH, S) have been prepared as anti-inflammatory agents [95].

Finally, three additional pyridazine-derived analgetic agents, which are cited in reference book [96] should be mentioned; their structures are given in formulae (24), (25) and (26).

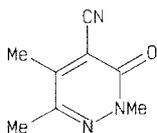

Triladine, Ba 14607
(CAS 60296-04-0)
(24)

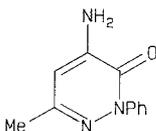

Metamfazon, A.G.N.20
(CAS 54063-49-9)
(25)

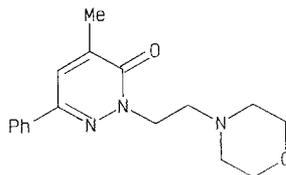

Ag 246 (CAS 13300-10-2)
(26)

ANTISECRETORY AND ANTI-ULCER AGENTS

Based on the known antisecretory activity of 2-phenyl-2-(2-pyridyl)thioacetamide, various aza-analogous 3-pyridazinyl derivatives have been prepared in Japan in search of more potent and less toxic long-lasting gastric antisecretory and anti-ulcer agents [88, 97]. The most effective agents in this series were compounds of type (27, R = H, Me); structure-activity relationships have been discussed in some detail [97]. The marked antisecretory and anti-ulcer activity observed in rats (20 mg/kg, intraduodenally) [97, 98] has been found not to be due to anticholinergic or histamine H_2 -receptor antagonistic activity. It is of interest to note that in this class of compounds the replacement of a 2-pyridyl group by a 3-pyridazinyl moiety results in a significant decrease of the acute toxicity. However, it has to be stressed that, according to UV and $^1\text{H-NMR}$ investigations, compounds (27) have to be formulated as pyridazinone methides rather than as benzylpyridazines [97].

The same Japanese group then synthesized numerous 3(2*H*)-pyridazinones of type (28) bearing a thiocarbamoylalkyl side-chain at N-2 as well as 4,5-dihydro analogues thereof and observed similar activities in this series

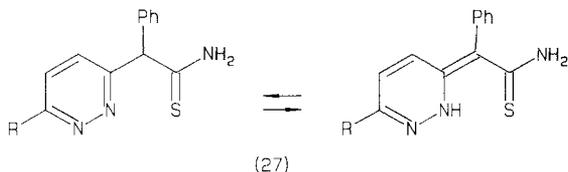

[99–101]. The most potent among the compounds tested were the pyridazinones (28, $R^1 = \text{Ph}$, $R^2, R^3, R^4, R^5 = \text{H}$, $n = 2-5$) [101]. Structure–activity relationships have been investigated in detail with this type of compound. Also, thio-analogues of compounds (28) (3-pyridazinethione derivatives) as well as 2-aminoalkyl-6-aryl-3(2*H*)-pyridazinones were claimed in patents as gastric secretion inhibitors or anti-ulcer agents [100, 102, 103].

A wide variety of 6-aryl-3(2*H*)-pyridazinones having an ω -thioureidoalkyl or an ω -cyanoguanidinoalkyl group attached to N-2 have been included in these investigations [104–106]. Likewise, numerous compounds having a sulphur or an oxygen atom in the alkylene bridge between the cyanoguanidine and the pyridazinone moiety [105, 107] as well as 6-phenyl-2-(ω -ureidoalkyl)-3(2*H*)-pyridazinones and 4,5-dihydro derivatives thereof [108, 109] have been evaluated as antisecretory and/or anti-ulcer agents. In all these classes of compounds as represented by the general formula (29, $R^1 = \text{aryl}$, $R^2 = \text{alkyl}$, substituted Ph; X = CH₂, O,S; Y = O,S,NCN), structure–activity relationships have been established.

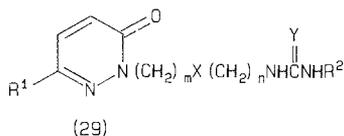
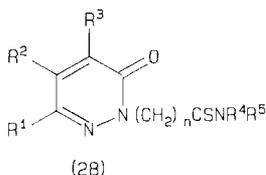

The most potent activities (gastric antisecretory activity in the pylorus-ligated rat or anti-ulcer activity on stress-induced gastric lesion in rat) have been observed with compounds (30), (31) [106], (32) [107], (33) and (34) [108], which were shown neither to be histamine H₂ receptor inhibitors nor to act as anticholinergic agents. Thus, the activity of compound (32), for example, has been reported to be superior to that of cimetidine [107].

Moreover, some German patents claiming *N*-unsubstituted 6-aryl-3(2*H*)-pyridazinones and 4,5-dihydro congeners as stomach secretion inhibitors and ulcer inhibitors have to be cited [110–113]. Several cardiotonic 6-aryl-pyridazinones, recently prepared in Japan, also have been reported to inhibit secretion

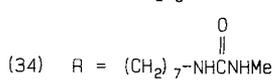
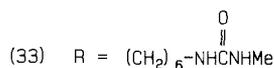
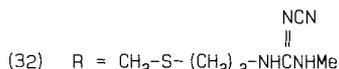
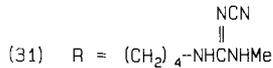
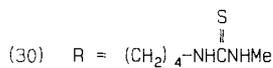
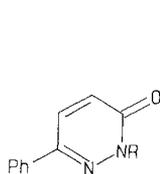

of gastric juice [114]. Finally, a U.S. patent on pyridazines substituted by a thiourea or urea side-chain similar to that in compound (29) [115] as well as a recent patent from Spain on 3(2*H*)-pyridazinones bearing a 4-arylpiperazino substituent at C-5 [116] should be mentioned.

ANTIDEPRESSANTS

The patent literature covers various types of pyridazine derivatives for which antidepressant activity has been claimed.

Compounds which are of interest in this context include 4-oxadiazolylpyridazines (35, R = cyclopropyl, Et) [117], 6-aryloxy-2-hydroxyalkyl-3(2*H*)-pyridazinones [118], 3-halo-6-hydrazinopyridazines of type (36, R = substituted amino) [119], *N*-2-isoxazolylmethyl-substituted 3-iminopyridazines (37) [120], carbamates derived from 3,6-bis(hydroxymethyl)-4-pyridazinones (38, R = alkyl, Ph) [121], and iminodihydropyridazine derivatives (39, R¹ = acyl; R² = H, MeS; R³ = aryl) [122, 123]. In Hungary, antidepressant activity has been observed with some 3,6-disubstituted pyridazines of type (40) [124].

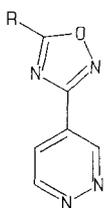

(35)

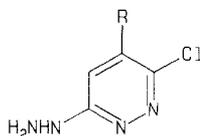

(36)

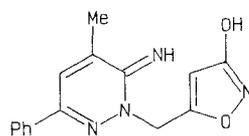

(37)

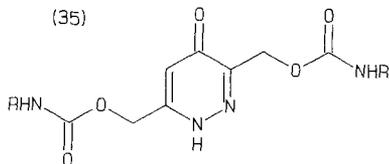

(38)

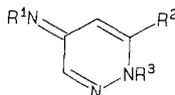

(39)

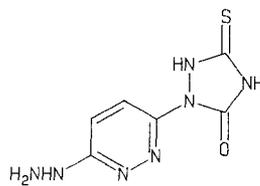

(40)

In France, much effort has been devoted to the development of novel pyridazine-derived compounds acting on the central nervous system [125–131] (also compare the sections on anticonvulsant pyridazines and pyridazine-derived GABA antagonists). Interest has been focused mainly on 3-aminopyridazine derivatives. An excellent review of the pharmacological and therapeutic potential of this class of compounds, including a discussion of structure–activity relationships, has been published [14]. That report summarizes the results obtained by the French group within the period 1968–1984 and thus provides convenient access to the relevant literature. Accordingly, in the present review only the most interesting agents which emerged from these studies will be discussed.

3-(2-Morpholinoethylamino)-4-methyl-6-phenylpyridazine (41) (minaprine, 30038CM, Agr 620, Agr 1240; CAS 25905-77-5; dihydrochloride: CAS 25953-17-7), which has been launched as Cantor, Kantor, Isopulsan or Nortimic, represents a psychotropic agent, the therapeutic profile of which differs from that of other known drugs. Minaprine not only antagonizes the ‘inhibitory state’ syndrome in man, but is also effective in certain depressive states [132, and literature cited therein]. Minaprine has been evaluated in animal models for depression [132, 133]. The results obtained indicate that (41) enhances both dopaminergic and serotonergic transmission without affecting cholinergic or noradrenergic transmission [134–137].

The psychopharmacological profile of minaprine in mice and rats has been investigated in comparison with reference antidepressant drugs [133, 138]. Additional reports on various biological effects of minaprine [14, 139–143], and recent discussions of its neurochemical profile are available [144, 145].

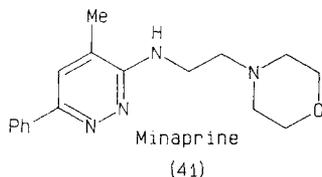

The pharmacokinetics of minaprine (orally administered) in humans have been studied [146, 147]. The bioavailability has been found to be excellent, and the pharmacokinetic parameters did not show a dose-dependency [147]. The binding of (41) to human serum proteins and erythrocytes has been investigated [148]. Minaprine has been found to undergo extensive biotransformation in different species, with major groups of metabolites derived from degradation of the morpholine subunit and from hydroxylation of the phenyl substituent [149–152].

In man, minaprine at doses of 150–300 mg/day (p.o.) is well tolerated, and extensive safety and tolerance studies have been performed [153 and references cited therein]. Clinical evaluations of minaprine have been published [154–158 and literature cited therein].

Recently, compound CM 30366 (CAS 82239-52-9), the 4-hydroxyphenyl analogue of minaprine, also has been studied in some detail. Based on the results obtained in a behavioural study in mice and rats, it has been concluded that CM 30366 may be of potential therapeutic usefulness due to a significant atypical dopamine-like activity [159]. Also thiophene isosters of minaprine have been claimed as antidepressant agents [131].

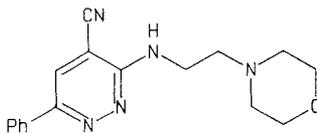

(42)

Compound SR 95191 (42, CAS 94011-82-2) is another aminopyridazine-derived antidepressant agent structurally closely related to minaprine, which has been investigated in France quite recently [160–162]. This compound has been shown to be active in most animal models of depression with an activity profile resembling that of a selective type A MAO inhibitor [160]. Recently, it has been found that this inhibition is selective, reversible and competitive *in vivo*; *in vitro*, however, SR 95191 behaves like an irreversible MAO-A inhibitor [162].

NEUROLEPTICS AND ANXIOLYTIC AGENTS

In the United States, 4,5-dihydro-3(2*H*)-pyridazinones bearing a 2-hydroxyalkyl substituent at N-2 have been patented as anxiolytics [163]. Compounds of type (43, R = Cl, CF₃) have been investigated in France; significant neurosedative effects have been demonstrated [164]. Anxiolytic properties of 3-amino-6-arylpyridazines have been reported [165].

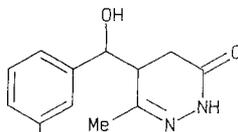

(43)

SEDATIVE-HYPNOTICS AND TRANQUILLIZERS

Sedative properties of *N*-substituted dihydropyridazinones (44, $R^1 =$ substituted Ph; $R^2 =$ H, HO) have been reported in the patent literature [166]. *N*-2-Aryl substituted pyridazinones of type (45, $R^1R^2 =$ H, alkyl; $R^3 =$ Cl, Br) [167] and type (46, $R^1 =$ H, alkyl; $R^2 =$ H, alkyl, hydroxyalkyl; $R^3 =$ H, Cl, Br; $R^4 =$ substituted Ph, substituted PhCH_2) [168] have been claimed to be sleep-inducers.

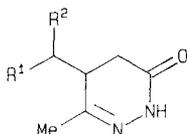

(44)

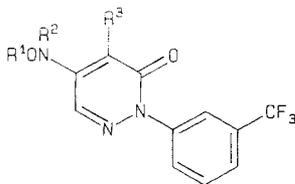

(45)

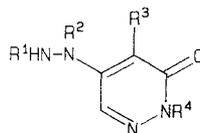

(46)

According to another patent [169], the anticonvulsant 6-aryl-3-(4-hydroxypiperidino)pyridazines exhibit hypnotic activity. Sedative effects of several anticonvulsant 6(1*H*)-oxo-3-aryl-1-pyridazine aceto-hydrazides and -acetic acid esters have been reported in the patent literature [87, 170, 171]. 1-(6-Hydrazino-3-pyridazinyl)-3-ethylurea also exhibits a sedative effect [124]. 4,6-Dimethyl-3(2*H*)-pyridazinone (47) (ceto-hexazine; CAS 7007-92-3) is listed as an hypnotic agent [96]. Ergoline derivatives bearing a 6-substituted 3-pyridazinyl residue have been patented as tranquillizers [172] and antagonists of amphetamine [173]. Other pyridazines are claimed in patents to be tranquillizing agents [87, 174]. Ridaflone (48) (ridiflone, delibryl; CAS 23419-43-4) is listed as a tranquillizer [96].

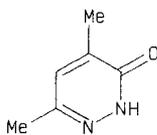

(47)

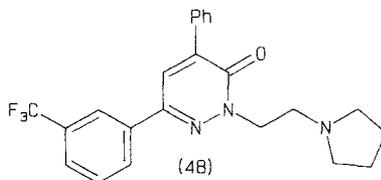

(48)

ANTICONVULSANTS

In search of novel anticonvulsants, various pyridazine derivatives have been synthesized and screened. Thus, the patent literature covers anticonvulsant

4-pyridazinyl-1,2,4-oxadiazoles [175, 176], 3-aminopyridazine derivatives like compound (49) [177], the 4-hydrazinopyridazine derivative (50) [178], various 6-aryl-3(*2H*)-pyridazinones bearing a functionalized acetic acid side-chain at the ring nitrogen atom (51, R^1 = substituted Ph; R^2 = EtO, NH_2 , NH_2NH) [87, 170, 171] and structurally related 4,5-dihydropyridazinones [174].

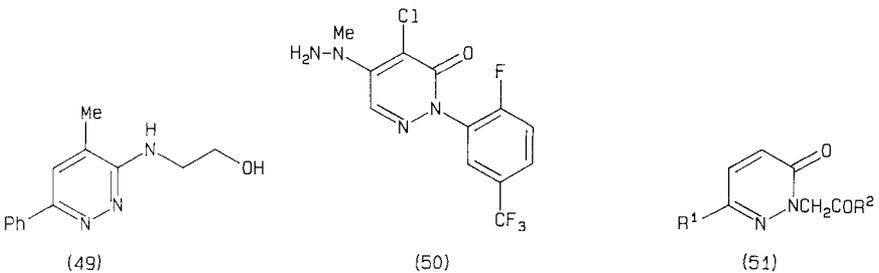

Within a series of compounds blocking the uptake of GABA into neurons or glia, which have been investigated in England, hexahydro-3-pyridazinecarboxylic acid has been found to exhibit anticonvulsant effects in mice [179]. In Poland, anticonvulsant activity has been observed with some aminomethylpyridazinones of type (52, R^1 = 4- ClC_6H_4 ; R^2 = cycloamino; R^3 = CH_2CN , HO, Et_2N , cycloamino) [180]. A Chinese group observed anticonvulsant activity with the fluoro-substituted pyridazinedione (53) [181].



In the United States, anticonvulsant properties have been found in a series of 1-methyl-2-phenylcarbamoyl piperidazines [182]. The introduction of a methylene bridge into the hexahydro-1,2-diazine system of these compounds has been reported to lead to 2,3-diazabicyclo[2.2.1]heptane congeners with significantly reduced anticonvulsant activity [183].

From extensive studies in the field of pharmacologically active pyridazines performed in France, interesting novel anticonvulsant agents emerged. Out of a series of 6-aryl-3-(hydroxypolymethyleneamino)pyridazines prepared [169, 184], compounds CM 40907 (CAS 93181-81-8) (54, R = H) and SR 41378 (CAS 93181-85-2) (55, R = Cl) appear to be of particular interest.

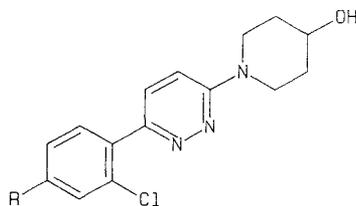

(54) (55)

From the examination of structure–activity relationships, it has been concluded that a phenyl moiety at C-6 as well as a 4-hydroxypiperidine side-chain attached to C-3 of the pyridazine system is essential for anticonvulsant activity in this class of compounds [184]. Compounds (54) and (55) have been found to have similar anticonvulsant profiles in animals (mice, rats and baboons) [165, and literature cited therein] and to represent potent broad-spectrum antiepileptic drugs. Their potency with regard to antagonizing seizures (induced by electro-shock or various chemicals) has been compared with standard anticonvulsants like carbamazepine and phenobarbitone [185, 186]. A quantitative electroencephalographic analysis of (55) has been published [187]. From *in vitro* studies it has been concluded that the anticonvulsant activities of these compounds are not mediated by an enhancement of GABAergic transmission or by an interaction with benzodiazepine receptor sites [165, 186, 187]. On the other hand, *in vivo* experiments showed that (54), at anticonvulsant doses, increases the affinity of flunitrazepam for its central receptor site [186]. Investigations of (54) and (55) in a behavioural test predictive of antianxiety activity revealed a marked difference in the pharmacological profiles of these structurally closely related compounds: the dichloro compound SR 41378 (55) has also been found to possess anxiolytic (anticonflict) properties [165].

CENTRALLY ACTING MUSCLE RELAXANTS AND ANTIPARKINSONISM AGENTS

For several pyridazine derivatives reported in the patent literature a muscle relaxant activity has been claimed. In this context, oxadiazolopyridazines (35) [117] and 6-aryl-4,5-dihydropyridazine-3(2*H*)-ones bearing various functionalized alkyl side-chains at N-2 [163, 174, 188, 189] are to be mentioned. Denpidazone (56) (CAS 42438-73-3), a 1,2-diphenylpyridazine-3,6-dione derivative, is listed as a muscle relaxant [96].

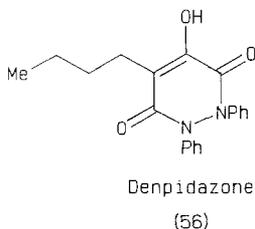

Iminodihydropyridazine derivatives of type (39) have been claimed recently as antiparkinsonism agents [123].

GABA ANTAGONISTS

GABA antagonists are essential tools for characterizing the pharmacological, functional and structural properties of the receptors of this important neurotransmitter. In search of selective GABA-A-antagonists, a variety of 3-amino-6-arylpyridazines bearing a functionalized four-carbon side-chain at the ring nitrogen atom 2 have been prepared in France [190]. A review of this subject [12] and a discussion of structure-activity relationships in this series [190] are available. The structures of the most interesting compounds SR 95103, SR 95531 and SR 42641 are shown in formulae (57), (58, R = MeO; X = Br; SR 95531) and (59, R = X = Cl; SR 42641).

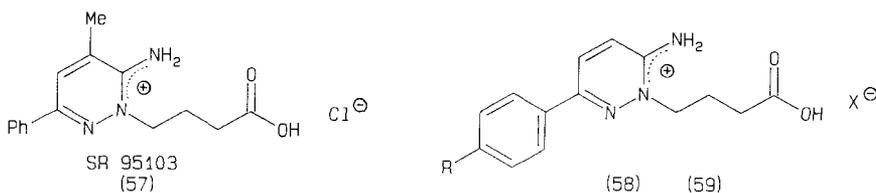

Compound (57), in which the γ -aminobutyric acid moiety is incorporated by its N-terminal group into a 3-amino-4-methyl-6-phenylpyridazine system, has been shown to be a selective and competitive GABA antagonist at the GABA-A receptor site [190 and literature cited therein, 191–194]. Further investigations revealed compounds (58) and (59) (having an additional *para*-substituent at the benzene ring but no methyl group attached to the diazine system) to be even more potent GABA-A antagonists [190, 195–197].

Compound (58) has been shown to be sufficiently selective to be of use in microelectrophoretic investigations of GABA-mediated synaptic transmission

[198]. Some recent reports on this type of neurotransmitter antagonists are available [199–204].

BLOOD PLATELET AGGREGATION INHIBITORS AND ANTITHROMBOTICS

The patent literature covers many pyridazine derivatives claimed as blood platelet aggregation inhibitors and antithrombotic agents. The interest has been focused mainly on 6-aryl-4,5-dihydro-3(2*H*)-pyridazinones. In these compounds the aryl substituent has been varied within a wide range. Thus, dihydropyridazinones bearing a substituted or heterocycle-fused phenyl group at C-6 (60, $R^1, R^2, R^3 = H, \text{alkyl}$; Ar = substituted Ph) [34, 110–112, 205–233] as well as various heteroaryl substituted congeners (61, $R^1, R^2, R^3 = H, \text{alkyl}$; Ar = pyridyl, thienyl, pyrrolyl, pyrazolyl) [234–241] have been prepared in search of novel antithrombotics.

Compounds in which the aryl or heteroaryl substituent is separated from the pyridazine moiety by an alkylene or alkenylene bridge (62, X = alkylene, alkenylene; $R^1 = \text{substituted Ph, heteroaryl}$; $R^2 = H, \text{alkyl}$) have been claimed as inhibitors of platelet aggregation [242–244].

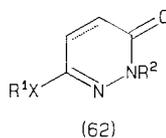
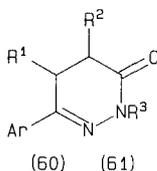

As a typical example of a 6-heteroarylsubstituted dihydropyridazinone exhibiting antithrombotic activity motapizone, NAT 05-239 (63) (CAS 90697-57-7) may serve [96]. Compound CCI 17810 (64) (CAS 76283-03-9) bearing a substituted phenyl moiety at C-6 of the pyridazine system has been shown to inhibit potently *in vitro* human platelet aggregation (induced by collagen, ADP, thrombin or arachidonic acid) with EC_{50} values in the range of 0.5–10 $\mu\text{g/ml}$ [245].

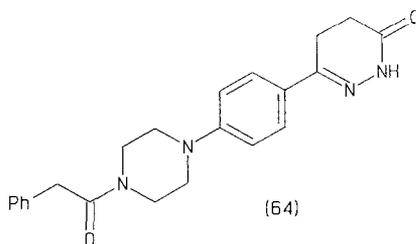
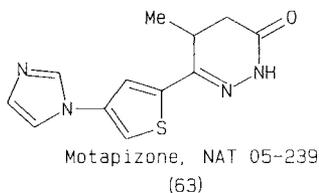

Most of the above-mentioned dihydropyridazinones bear an alkyl substituent either at C-4 or at C-5. However, there are also patents on 4,5-cycloalkane annulated congeners (65, R = substituted Ph; X = (CH₂)_n, n = 1-4) [111, 225, 246-248] and on 6-aryldihydropyridazinones bearing various other substituents at the β -carbon atoms [206, 211, 229, 237, 249-252].

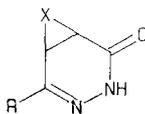

(65)

Antithrombotic activity has been claimed also for some related fully unsaturated pyridazinones [208, 210, 241, 244, 251]. Many of these compounds were found to exhibit additionally antihypertensive, positive inotropic, antiallergic or anti-inflammatory activity. Pyridazinones of type (60) and (65) have been reported recently to enhance the activity of antithrombotic phenylacetone nitrile derivatives [253].

From extensive investigations of 6-aryldihydropyridazinones of type (60) performed in West Germany [254], it is claimed that compounds (66, R¹ = alkanoyl, chloroalkanoyl; R² = H, Me) represent very potent platelet aggregation inhibitors, being 16,000-times more active *in vitro* and up to 400-times more active *ex vivo* (inhibition of collagen-induced aggregation in rats, oral administration) than acetylsalicylic acid. Considering the additional hypotensive effect of these compounds, their pattern of action corresponds to that of prostacyclin. Structure-activity relationships in this class of compounds have been discussed [254]. It has been found that the antiaggregatory activity is significantly correlated with the van der Waal's volume of the aryl substituent [255]. Amipizone, (66, R¹ = 2-chloropropanoyl, R² = Me; Lu 23051; CAS 69635-63-8) is a typical example for this class of compounds [96, 256].

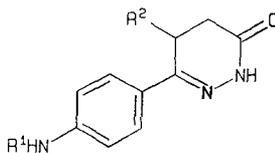

(66)

Recently, compounds of type (67, R¹ = H, NH₂, AcNH, MeO, F; R² = H, EtCO) characterized by a hydroxymethyl or an acyloxymethyl group attached to C-5 of the aryldihydropyridazinone system have been investigated in Italy.

They have been shown to exhibit antithrombotic *in vivo* activity (mice) comparable with or greater than, that of acetylsalicylic acid [257].

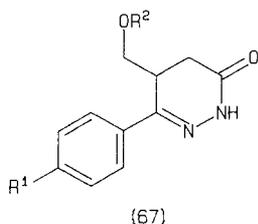

Compound Y-590 (68) (CAS 70386-06-0) investigated in Japan, represents another potent antithrombotic pyridazinone derivative. In rat platelets, its IC_{50} value for ADP induced aggregation has been found to be 9 ng/ml. In *ex vivo* experiments (rats, rabbits; oral administration) activity has been observed at doses of 0.1 and 0.01 mg/kg [258]. This activity has been attributed to the inhibition of cAMP degradation in platelets [259].

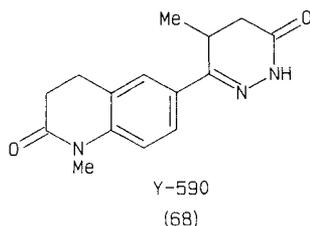

Additional reports on dihydropyridazinones as antithrombotic agents have been published [260–264].

Not only 5-alkyl-6-aryldihydropyridazinones have attracted considerable attention as antithrombotics. There are also patents claiming structurally closely related compounds in which the (formal) hydroxy function at C-3 is replaced by a hydrazino moiety as displayed in formula (69, $R = NH_2NH$, $ArCH = NNH$) [265–267] or by cycloamino substituents [268].

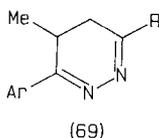

Also some 4(1*H*)-pyridazinones [121] and several 3-(aminoalkylthio)-6-chloropyridazines [269] have been claimed as useful antithrombotic agents. In

Poland, platelet-inhibiting effects have been observed with bisarylpyridazines of type (70, $R^1 = H, Me, Br, Cl$; $R^2 = H, Me$) [270]. In France, the arylidenedihydropyridazines (71) and (72) have been investigated [271, 272]. They have been found to inhibit thromboxane biosynthesis.

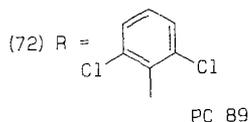
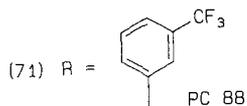
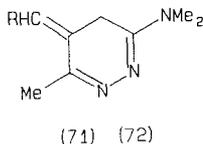
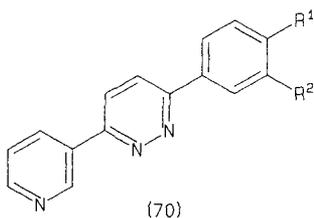

On the other hand, it should be noted that with some pyridazine derivatives, haemostatic activity has been observed [273–275]. Thus for instance, sulphonylpyridazinones of type (73, $R = HO, NH_2NH, Me_2N(CH_2)_3NH$) have been reported to shorten the bleeding time in mice to an extent comparable to carbazochrom sodium sulphonate [275].

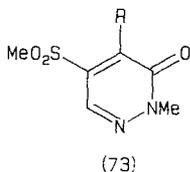

ANTITUMOUR AGENTS

Various pyridazine-*N*-oxides (including cinnoline *N*-oxides) have been prepared as potential antitumour agents in Japan [276–278]. Among several 4-nitropyridazine 1-oxides tested for activity against rat ascites hepatoma AH-13, 3,6-dimethoxy-4-nitropyridazine 1-oxide (74) has been found to be the most potent compound; a minimal effective dose of 5 mg/kg has been estimated [276]. Also pyridazine *N*-oxides of type (75) bearing a bis(2-chloroethyl)aminomethyl side-chain at C-6 have been reported to be effective (0.5–5 mg/kg, i.p.) against AH-13 in rats [278]. Both types of compound (74), (75, $R = H, Br$), however, have been shown to be inactive against mouse lymphoid leukaemia L-1210.

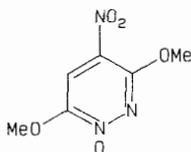

(74)

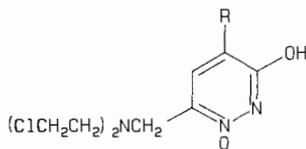

(75)

In Poland, the cytostatic activity (human KB and Hela cell cultures) of various pyridazinones (76, $R^1, R^2 = H, Cl$; $R^3 =$ substituted Ph) and pyridazinediones (77, $R^1, R^2 = H, Br$; $R^3 =$ substituted Ph) bearing a substituted phenyl group at the ring nitrogen atom and a halogen substituent at C-4 or C-5 have been investigated [279, 280]. Several of these compounds were reported to have ED_{50} values of 0.02–3 $\mu\text{g/ml}$. The effect of the halogen substituent on the activity has been discussed [281]. With compounds of type (77), a high correlation between the cytostatic activity in L-1210 cell cultures and the lipophilicity has been observed [282, 283].

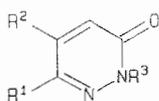

(76)

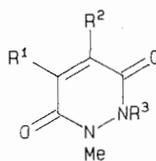

(77)

Several dihydropyridazinones of type (78, $R^1 =$ cycloamino; $R^2 = H, \text{cycloamino}$; $R^3 = H, \text{Ph}$) characterized by a cycloaminomethyl substituent at C-5 have been reported to exhibit cytostatic activity [284, 285]. In addition, compounds having a pyridazinone or pyridazinedione moiety linked to the purine system by a sulphur atom (79) have been prepared as potential cytostatic agents [286].

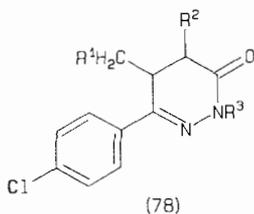

(78)

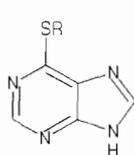

(79)

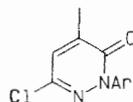

R =

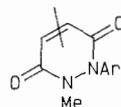

Recently, several 5,6-diphenyl-3(2*H*)-pyridazinones (80, R = F, Cl) have been found to be active against murine P-388 leukaemia [287].

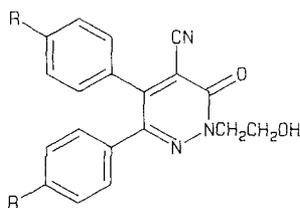

(80)

A novel antitumour antibiotic complex named **BBM-928** has been isolated in Japan in 1979 from an *Actinomadura luzonensis* (actinomycetes) strain [288–290]. The three main components of this complex **BBM-928A, B** and **C** were found to possess cyclic decadepsipeptide structures, each containing two *trans*-(3*S*,4*S*)-4-hydroxy-2,3,4,5-tetrahydropyridazine-3-carboxylic acid subunits (81) [291, 292]. Compound **BBM 928A** also reported as luzopeptin A, in which the alcoholic hydroxy groups of both pyridazine units are acetylated, has been shown to have a high binding affinity towards DNA [293, 294] and to possess significant activity in several murine tumour models (**B-16** melanoma, **P-388** and **L-1210** leukaemia) [289, 295]. The behaviour of **BBM 928A** in these tests was found to be similar to that of echinomycin, which is structurally closely related [295]. Another antileukaemic (**P 388** in mice) depsipeptide, named luzopeptin E₂, which contains two hexahydropyridazine-3-carboxylic acid moieties (82) has been described in the patent literature in 1984 [296].

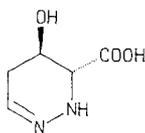

(81)

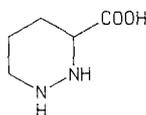

(82)

Acetamides of type (83) derived from various *N*-heterocycles have been prepared and investigated for antileukaemic activity in the German Democratic Republic. Within this series, the pyridazine derivative (84) was found to be the only active compound inhibiting the growth of L-1210 mouse cells *in vitro* ($ID_{50} \approx 10^{-4}$ mol/l) [297].

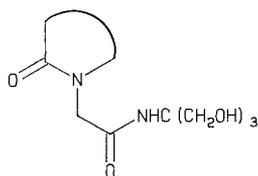

(83)

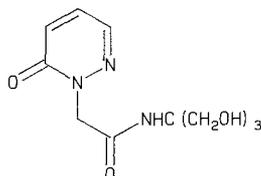

(84)

An excellent antineoplastic potency against the murine neoplasm Sarcoma 180 has been observed with arylsulphonylhydrazones derived from pyridazine-3-carboxaldehyde 2-oxide (85) [298]. These compounds were prepared in the U.S.A. in order to investigate the effect of the incorporation of an additional nitrogen atom into antitumour active pyridine 1-oxide congeners. Interestingly, the pyridazine-derived compounds (85, R = H, Me, MeO) proved to be superior to the corresponding pyridine derivatives, whereas the analogous pyrimidine-4-carboxaldehyde 3-oxide derivatives were found to be devoid of activity.

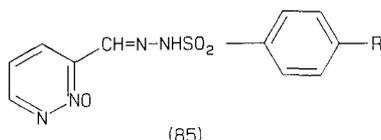

(85)

In the U.S.A. various pyridazine analogues of naturally occurring pyrimidine nucleosides have been prepared [299, 300]; for a review on this subject see [13]. Within this series, 3-deaza-6-azauridine (86) has been found to inhibit the growth of L-1210 mouse leukaemic cells with an ID_{50} value of $\approx 7 \times 10^{-5}$ M [299, 301]. The inhibitory effect of this uridine isoster might be due to interference in pyrimidine biosynthesis [302].

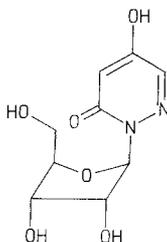

(86)

Finally, several patents claiming antitumour-active pyridazine derivatives are to be mentioned [273, 274, 303–305]. Thus for instance, numerous

sulphonylpyridazinones (87, $R^1, R^3 = \text{alkyl, aryl}$; $R^2 = \text{substituted amino, HO, RO}$) and *N*-benzoyl-*N'*-pyridazinylphenoxyurea derivatives of type (88, $R^1 = \text{H, halogen, CF}_3$; $R^2 = \text{substituted Ph}$) have been prepared and tested in this context.

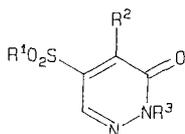

(87)

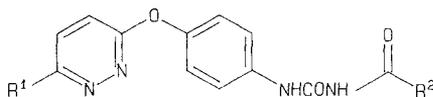

(88)

IMMUNOSUPPRESSANT AGENTS

In Poland, various 5-cycloaminomethyl-6-(*p*-chlorophenyl)-4,5-dihydro-3(2*H*)-pyridazinones (89, $R^1 = \text{pyrrolidino, piperidino, morpholino, etc.}$; $R^2 = \text{H, substituted alkyl, aryl}$) have been prepared in search of biologically active pyridazines; some of these compounds have been reported to exhibit immunosuppressive activity [180, 284, 285].

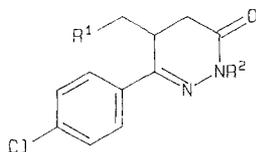

(89)

ANTIVIRAL AGENTS

Sulphonylpyridazinones of type (90, $R^1 = \text{alkyl, PhCH}_2, \text{Ph}$; $R^2 = \text{substituted amino, HO, AlkO}$; $R^3 = \text{alkyl, Ph}$) prepared in Japan have been patented as antiviral agents [273, 274]. A moderate activity against influenza A Ann Arbor strain in mice has been observed with several 3-pyridazinylhydrazones, for instance (91), which have been synthesized in the U.S.A. [306]. In West Germany various benzimidazoles bearing a 4,5-dihydro-3(2*H*)-pyridazinone substituent at position 5 or 6 have been claimed as virucidal agents [110]. In Belgium, a wide variety of 3-aminopyridazine derivatives have been prepared [307]. It has been reported that compound (92), which may serve as a typical example for this series, inhibits 75% of the cytopathic effect of human rhinovirus at 0.006 $\mu\text{g/ml}$.

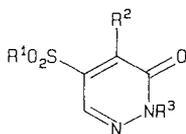

(90)

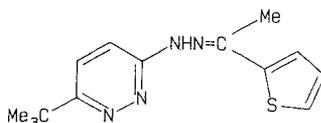

(91)

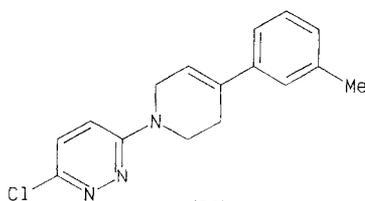

(92)

In Austria, various thiosemicarbazones derived from pyridazinecarbaldehydes and alkyl pyridazinyl ketones have been prepared recently in search of antiviral agents more efficacious than the previously described heteroaromatic thiosemicarbazones [308]. It has been found that compounds of type (93, $R^1 = H$; $R^2 = \text{cycloamino}$) are markedly less cytotoxic than the corresponding 2-pyridine-derived congeners (factor 300) while being equipotent with regard to antiherpetic activity (HSV-1). A similar phenomenon has been observed with thiosemicarbazones derived from alkyl pyridazinyl ketones (94, $R^1 = \text{alkyl}$; $R^2 = \text{cycloamino}$). The replacement of a 2-pyridyl moiety in this class of compounds by a 3-pyridazinyl ring additionally permits a significant improvement of the water solubility [308].

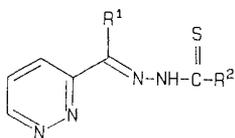

(93)

(94)

ANTIBACTERIAL AGENTS

In 1977, a review on the antimicrobial activity of pyridazine derivatives was published [309]. Accordingly, in the present article, antibacterial pyridazines developed more than a decade ago will be mentioned only briefly. Synonyms of the agents (95)–(104) listed below are given in a reference book [96]. In order

to provide convenient access to the original literature dealing with these drugs, their CAS numbers are given. Apart from nifurprazine (104), these compounds, most of which have been prepared in the period 1950–1960, are sulphanilamide derivatives bearing a substituted pyridazine moiety at the amide nitrogen atom.

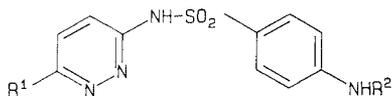

(95) - (99)

(95) Sulfamethoxypyridazine (CAS 80-35-3)

(97) Sulfachlorpyridazine (CAS 80-32-0)

(96) Sulfethoxypyridazine (CAS 963-14-4)

(98) Phthalylsulfapyridazine (CAS 13010-46-3)

(99) Malazin (CAS 13010-48-5)

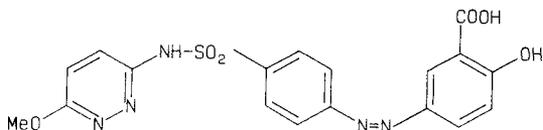
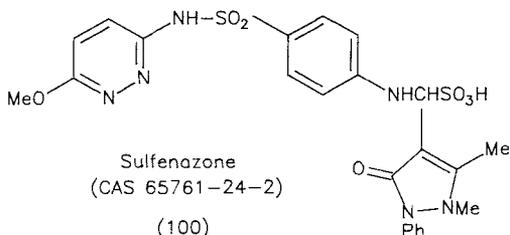

Salazosulfapyridazine, (CAS 22933-72-8)
(101)

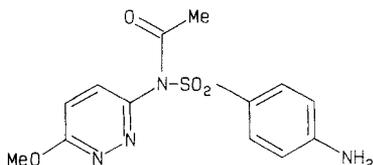

Acetylsulfamethoxypyridazine
(CAS 3568-43-2)
(102)

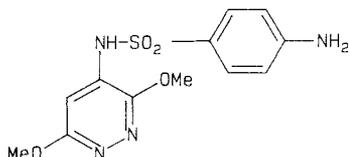

CS 61 (CAS 1230-33-7)
(103)

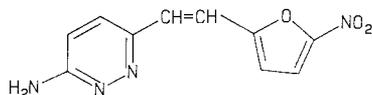

Nifurprazine (CAS 1614-20-6)
(104)

3-Methoxy-6-sulphanilamidopyridazine (95, $R^1 = \text{MeO}$; $R^2 = \text{H}$) (sulphamethoxy pyridazine) represents the first example of a long-acting antibacterial sulphonamide. Also compounds (96, $R^1 = \text{EtO}$; $R^2 = \text{H}$), (99, $R^1 = \text{MeO}$; $R^2 = \text{Maleyl}$), (102), and (103) have been developed as depot sulphonamides. Phthalylsulphapyridazine (98, $R^1 = \text{MeO}$; $R^2 = \text{phthaloyl}$), on the other hand, represents an agent for the treatment of intestinal infections. In the sulphenazone molecule (100), the sulphamethoxy pyridazine system has been combined with an antipyretic pyrazolone moiety. The nitro furan derivative, nifurprazine (104), is a topical antibacterial agent used mainly for the treatment of animal diseases.

Pyridazine-derived sulphonamide antibacterials, in particular sulphamethoxy pyridazine, are still the subject of extensive investigations. Thus, for instance, in volumes 82 to 108 of *Chemical Abstracts*, there are more than 300 abstracts of papers dealing with compound (95, $R^1 = \text{MeO}$; $R^2 = \text{H}$), which are not included in the present review due to space limitations. Only selected examples are mentioned.

A detailed report on the structure of sulphamethoxy pyridazine has been given recently [310]. Various complexes of sulphamethoxy pyridazine have been prepared, including bismuth, cadmium, calcium, chromium, cobalt, copper, iron, nickel, silver and zinc complexes. Thus, for instance, Cu(II) and Ag(I) complexes have been found to be more potent against selected bacterial pathogens than (95, $R^1 = \text{MeO}$; $R^2 = \text{H}$) [311].

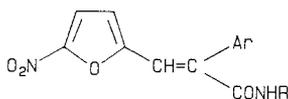

(105)

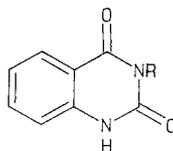

(106)

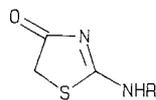
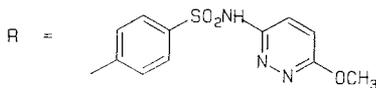

(107)

Antibacterial activity has also been observed with a variety of sulphamethoxy-pyridazine derivatives like the imine obtained upon reaction of (95, $R^1 = \text{MeO}$; $R^2 = \text{H}$) with 5-nitrofurfural [312], 2-aryl-3-nitrofurylacrylamides (105) [313], quinazoline-2,4-diones (106) [314], thiazolin-4-ones of type (107) [315] and with aldol condensation products of the latter [316].

Sulphonylpyridazinones (108, $R^1, R^3 = \text{alkyl}$, Ph; $R^2 = \text{substituted NH}_2$, HO, RO) [273, 274], trichloromethylchloropyridazines (109) [317] and 3-mercaptopyridazine 2-oxide derivatives [318, 319] have been claimed as antibacterial agents.

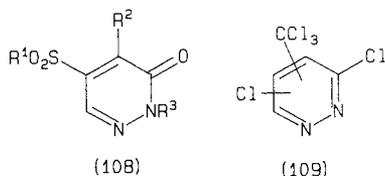

In addition, there are several Japanese patents on antibacterial pyridazine derivatives as represented by formulae (110, X = halogen; R = substituted amino, AlkS) [320, 321], (111, $R^1 = \text{substituted Ph}$; $R^2 = \text{alkyl}$, alkenyl, morpholinosulphonyl) [322] and (112, $R^1 = \text{aryl}$, aminosubstituted heterocycle; $R^2 = \text{H}$, halogen, alkyl; $R^3 = \text{COOH}$; $R^4 = \text{aryl}$, aralkyl, etc.) [323].

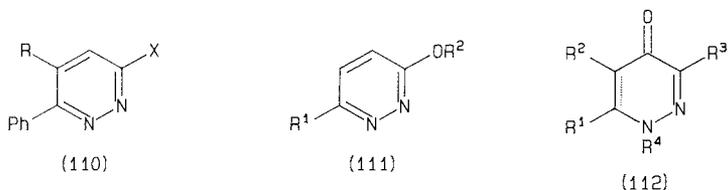

In Poland, various 3,6-pyridazinediones have been prepared as potential antimicrobial agents [324–328]. Antibacterial activity has been observed with some compounds of type (113, $R^1 = \text{H}$, Br; $R^2 = \text{Br}$, EtNH, $R^3 = \text{aryl}$). There are also reports on antibacterial pyridazinylpyridazinones (114, R = aryl) [329, 330] and 6-aryl-3(2H)-pyridazinones (115, R = aryl) [331, 332].

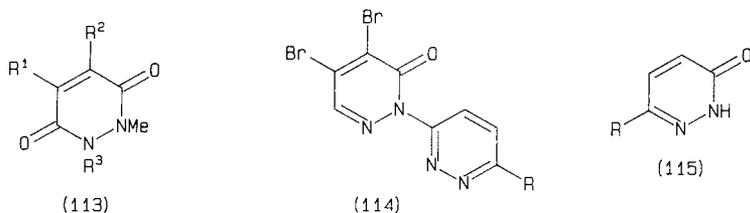

In China, tuberculostatic activity has been observed recently with 2-arylpyridazinones of type (116, $R^1 = \text{HO, Cl}$; $R^2 = \text{F, Cl}$; $R^3 = \text{aryl}$) and related compounds [333]. In the U.S.S.R., antibacterial 6-chloro-3-hydrazinopyridazine derivatives (117, $R = \text{aryl}$) have been described [334].

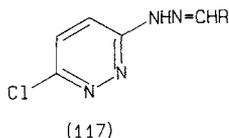
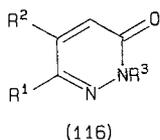

Several antimicrobial benzofuran derivatives including dihydropyridazinone-substituted congeners of type (118, $R = \text{H, Ac, Ph, cycloaminomethyl}$) have been prepared in Egypt [335, 336]. The triazinylpyridazinone (119) has also been reported to have antibacterial properties [337].

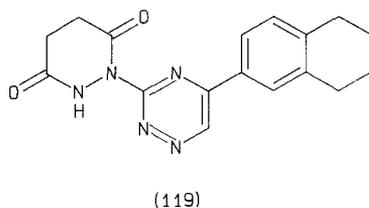
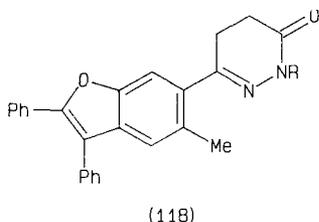

In West Germany pyridazinium compounds as represented by formula (120, $R^1 = \text{halogen, alkyl, aryl}$; $R^2 = \text{H, alkyl}$; $R^3 = \text{substituted amino}$; $R^4 = \text{substituted alkyl, cycloalkyl}$) have been claimed as antibacterial agents [338]. In Australia, mercapto derivatives of several nitrogen heteroaromatics including pyridazine-derived compounds (121, $R = \text{CONH}_2, \text{CH}_2\text{NMe}_2$) have been prepared in a search of amplifiers of phleomycin [339]; however, only low activity has been observed in this series.

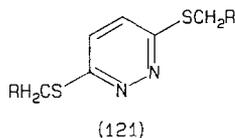
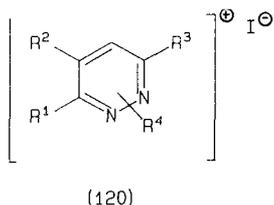

In the U.S.A. it has been found that 4-cyano-3(2*H*)-pyridazinone (122), which exhibits antibacterial activity against systemic *E. coli* infection in mice

(but not *in vitro*), is metabolized to afford the mesoionic pyridazine nucleoside (123, R = CN) [340]. Based on this observation, various 4-substituted 3-oxido-1- β -D-ribofuranosylpyridazinium nucleosides have been prepared and tested for antibacterial activity [341]. The chloro compound (124, R = Cl) has been found to be several times more active *in vitro* than (123) against *E. coli*, although it is inactive *in vivo*.

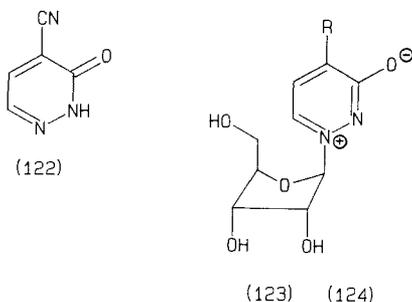

In search of novel and more effective antibacterial agents, numerous β -lactam antibiotics bearing a pyridazine core have been synthesized mainly in Japan. Thus, the penicillin derivative (125) characterized by a 3-hydroxypyridazine-4-carboxamido subunit has been patented as a broad-spectrum bactericide [342–345]; likewise, the corresponding cephalosporin analogue has been claimed in a patent [346].

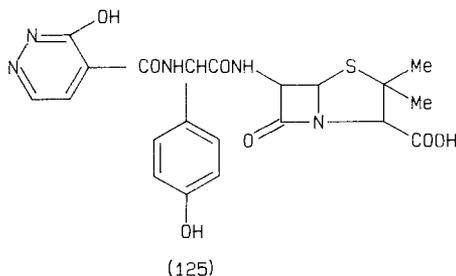

Moreover, there are several patents and reports on cephalosporins and 7-alkoxy derivatives thereof, which are characterized by a pyridazine-derived substituent attached to the thiazine ring. Some typical examples are given in formulae (126) [347–356], (127) [357], (128) [358], (129) [359, 360] and (130) [355, 361–363] in which R¹ represents a variable acyl group.

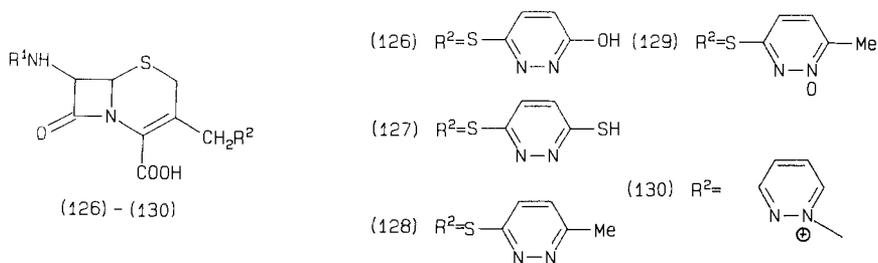

The pyridazine ring has also been introduced as a substituent into antibacterial carbapenems (131) [364, 365].

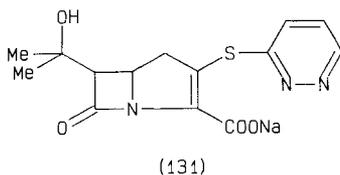

Finally, several naturally occurring depsipeptide antibiotics containing the 2,3,4,5-tetrahydropyridazine or the hexahydropyridazine system have to be mentioned. In Japan, antrimycin (132, $R = Me$) has been isolated from *Streptomyces xanthodicus* MG125-CF1, which *in vitro* shows antibacterial activity (*Mycobacterium smegmatis*: MIC 12.5 $\mu g/ml$; *Mycobacterium tuberculosis*: MIC 50 $\mu g/ml$) [366].

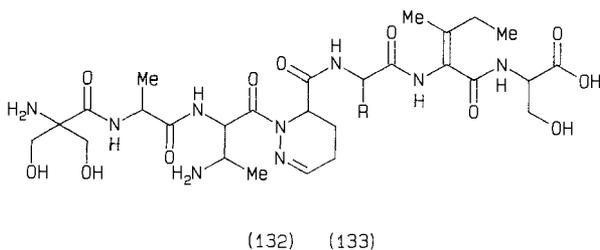

From *Streptomyces cirratus* 248-Sq2, cirratiomycin A (133, $R = iBu$) has been obtained, and has been found to be active *in vitro* against a narrow range of *Lactobacillus* and some strains of *Streptococcus* [367]. In addition, the peptide antibiotic (132, $R = Me$) is also produced by this *Streptomyces* [367].

Antibacterial activity *in vitro* has also been observed with the components of the antibiotic complex BBM-928 [288, 290] and with luzopeptin E₂ (*Streptococcus pyogenes*: MIC < 0.05 $\mu g/ml$; *Bacillus anthracis*: MIC 0.1 $\mu g/ml$; *My-*

cobacterium smegmatis: MIC 0.8 $\mu\text{g/ml}$) [296]. These compounds have been discussed in the section on antitumour pyridazines. Another novel cyclodepsi-peptide antibiotic termed azinotrizin (134) has been isolated recently in the U.S.A. from the culture filtrate of *Streptomyces* sp.X-14950 [368]. It is characterized by both the L-piperazic acid and the D-piperazic acid as unusual amino acids and exhibits an antimicrobial spectrum similar to that of the monamycins [3] (activity against Gram-positive micro-organisms). However, azinotrizin shares toxic liabilities with the latter antibiotics which preclude its clinical use.

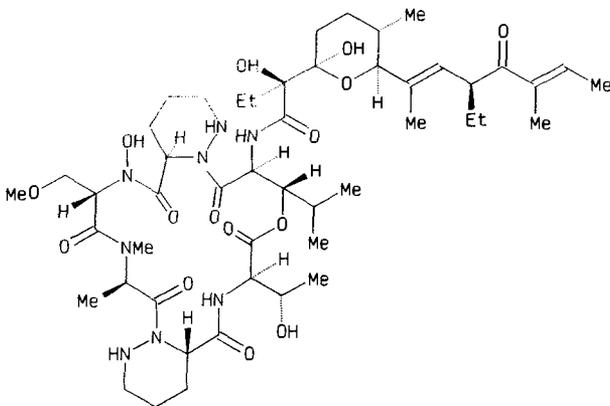

ANTIFUNGAL AGENTS

For several decades much effort has been devoted to the search for novel pyridazine-derived antifungal agents. Most of the investigations in this field, however, have been directed to agrochemicals which are not subject of the present review. Accordingly, only some selected antifungal pyridazines, mainly those appearing to be of some interest in the treatment of fungal infections in humans, will be discussed in this chapter.

Antifungal activity has been reported for a series of mercaptopyridazinethiones (135, $R = \text{H}$, alkyl, PhCH_2), (136, $R = \text{H}$, alkyl, alkoxyalkyl, PhCH_2), (137, $R = \text{H}$, alkyl, alkoxyalkyl, PhCH_2), prepared in Great Britain, as well as for metal or ammonium salts and zinc complexes thereof [369, 370]. In Japan, various 3(2*H*)-pyridazinones bearing a substituted sulphur or oxygen function at C-5, as represented by formula (138, $R^1 = \text{aryl}$, heteroaryl; $R^2 = \text{H}$, alkyl, halogen; $R^3 = \text{alkyl}$; $X = \text{O}$, S), have been synthesized and patented as fungicides [371–376]. Antifungal activities have also been reported recently for

chloropyridazine derivatives of type (139) or (140) [377] and for 2-pyridylpyridazinones (141, $R^1 = \text{HO}, \text{AcO}$; $R^2 = \text{H}, \text{halogen}$; $R^3 = \text{substituted 2-pyridyl}$) [378]. 3-Alkoxy-6-trichloromethylpyridazines have been claimed as fungicides in the United States [379].

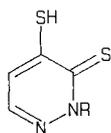

(135)

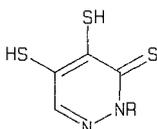

(136)

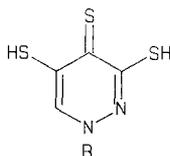

(137)

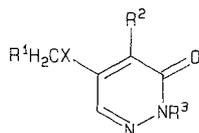

(138)

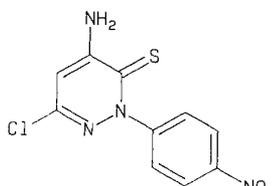

(139)

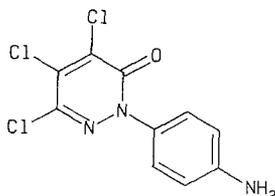

(140)

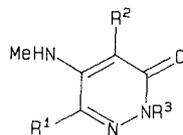

(141)

Moreover, it has to be noted that many pyridazine derivatives exhibiting antibacterial activity, which are discussed in the preceding section, also have been found to possess antifungal properties [317, 318, 322, 325, 329, 333, 334, 336, 338].

Quite recently, a novel antifungal antibiotic named pyridazomycin (142) has been isolated in the Federal Republic of Germany from the culture filtrate of *Streptomyces violaceoniger* sp. *griseofucus* [4]. To our knowledge, this compound – 1-(4-amino-4-carboxybutyl)-4-carbamoylpyridazinium chloride (Chem. Abstr. name: (*S*)-5-(2-azonia-5-carbamoyl-2-pyridazinyl)-2-amino-pentanoic acid chloride) – represents the first example of a naturally occurring 1,2-diazine derivative containing the fully unsaturated pyridazine system.

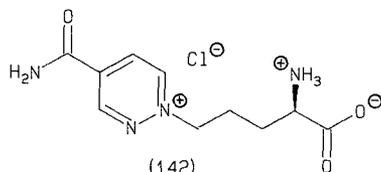

(142)

ANTIALLERGIC AGENTS

Several types of 2(2*H*)-pyridazinones have been claimed in patents as antiallergic agents. In Japan, the interest has been focused mainly on compounds of type (143, R^1 = substituted aminoalkyl; R^2 = H, alkyl; R^3 = H, Me, HOCH_2CH_2) [207], and recently, in particular, on pyridazinones as represented by formulae (144, R^1 = 4-MeOOC-3-R- $\text{C}_6\text{H}_3\text{O}(\text{CH}_2)_3$; R^2 = Et) [380], (145, R^1 = 3,4-(MeO) $_2\text{C}_6\text{H}_3$; R^2 = Pr) [381], (146, R^1 = 3-MeOC $_6\text{H}_4$; R^2 = cyclopentyl) [382], (147, R^1 = substituted Ph; R^2 = halogen; R^3 = alkyl; X = O, S) [383], and congeners. The latter compounds have been shown to inhibit significantly leukotriene-induced contraction in the isolated guinea-pig trachea test 10^{-4} – 10^{-5} g/ml. Benzyloxy- and benzylthiopyridazinones of type (147) have been patented as inhibitors of slow-reactive substances of anaphylaxis [383].

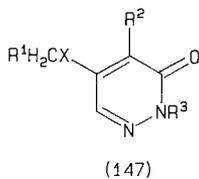
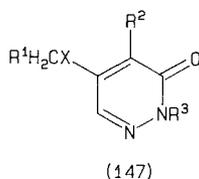
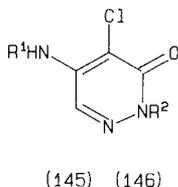
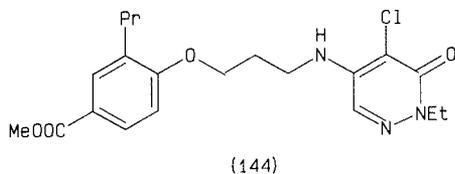
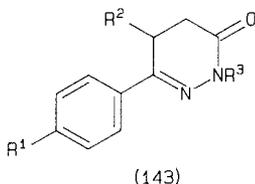

In the United States, various thiourea- and urea-derived antihistaminics and gastrin inhibitors have been patented, including compounds bearing a pyridazinyl substituent [115]. Among various (pyridylaminoalkylamino)thiadiazoles having an additional heteroaromatic moiety linked by a methyleneamino function to the 5-membered ring, pyridazine-derived compounds have also been claimed as histamine H_1 antagonists [384]. There is a recent patent on antiallergic 1,4-naphthalenediones bearing a pyridazinylaminoalkylamino side-chain [385]. Within a series of heterocyclic ethylenyloxanilates investigated in the U.S.A., the 3-pyridazinyl-substituted compound (148) has been found to be an antiallergic active in the IgE-mediated passive cutaneous anaphylaxis test in rats (50% inhibition) at oral doses of 1 mg/kg [386, 387]. A systematic modification of the heteroaromatic moiety has shown [386] that potent

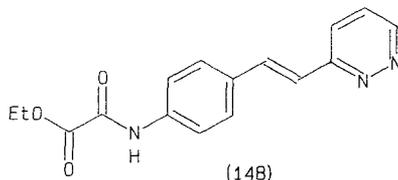

antiallergic activity is observed only in the case of 4-pyrimidine-, 2-pyrazine- or 3-pyridazine-derived compounds. The replacement of these heteroaromatic systems by other heterocycles, including pyridine, has been found to result in total loss of activity.

ACKNOWLEDGEMENTS

The authors express their gratitude to Mrs. Ing. S. Offenberger and Mr. E. Möllner for indispensable help in collecting the literature. Moreover, we wish to thank all those scientists who facilitated our task by providing us with reprints of their papers.

REFERENCES

1. E. Fischer, *Justus Liebigs Ann. Chem.*, 236 (1886) 147.
2. E. Täuber, *Chem. Ber.*, 28 (1895) 451.
3. K. Bevan, J.S. Davies, C.H. Hassall, R.B. Morton and D.A. Phillips, *J. Chem. Soc. (C)*, (1971) 514.
4. R. Grote, Y. Chen, A. Zecek, Z. Chen, H. Zähler, P. Mischnick-Lübbecke and W.A. König, *J. Antibiot.*, 41 (1988) 595.
5. M. Tišler and B. Stanovnik, *Adv. Heterocycl. Chem.*, 9 (1968) 211.
6. R.N. Castle, *The Chemistry of Heterocyclic Compounds*, eds. A. Weissberger and E.C. Taylor (J. Wiley, New York) Vol. 28 (1973).
7. M. Tišler and B. Stanovnik, *Adv. Heterocycl. Chem.*, 24 (1979) 363.
8. M. Tišler and B. Stanovnik in: *Comprehensive Heterocyclic Chemistry*, eds. A.R. Katritzky and C.W. Rees (Pergamon Press, Oxford) Vol. 3, 2B (1984) pp. 1-56.
9. G. Heinish, *Heterocycles*, 26 (1987) 481.
10. V.E. Limanov, *Pharmazie*, 32 (1977) 555.
11. G. Pifferi and G. Gaviraghi, *Cron. Farm.*, 23 (1980) 186.
12. C.G. Wermuth and K. Biziere, *Trends Pharmacol. Sci.*, 7 (1986) 421.
13. L.B. Townsend, D.S. Wise, D.J. Katz, Y. Iwai, L.C. Bloomer and L.L. Wotring, *Proc. Int. Round Table Nucleosides, Nucleosides and their Biol. Appl.* 4th, (1982) 125; *Chem. Abstr.*, 98 (1983) 107619.
14. C.G. Wermuth, *Actual. Chim. Ther.*, 12 (1985) 3.
15. R. Schönböck and E. Kloimstein, *Oesterr. Chem. Z.*, 85 (1984) 185.

16. J. Druey, *Angew. Chem.*, 70 (1958) 5.
17. I. Satoda, J. Matsuo, M. Takaya and K. Takeda, *Jpn. Kokai* 74 109, 387; *Chem. Abstr.*, 83 (1975) 164217.
18. T. Kishikawa and T. Matsuo, *Jpn. Kokai* 76 59, 882; *Chem. Abstr.*, 86 (1977) 29858.
19. M. Takaya, T. Yamada and T. Kishikawa, *Jpn. Kokai* 77 03, 083; *Chem. Abstr.*, 87 (1977) 53349.
20. M. Takaya, K. Terashima and T. Yuizono, *Jpn. Kokai* 77 03, 085; *Chem. Abstr.*, 87 (1977) 68402.
21. M. Takaya, M. Nakamura and T. Kishikawa, *Jpn. Kokai* 77 03, 082; *Chem. Abstr.*, 87 (1977) 68403.
22. M. Takaya, K. Terashima and T. Kishikawa, *Jpn. Kokai* 77 03, 086; *Chem. Abstr.*, 87 (1977) 68401.
23. M. Takaya, T. Yamashita and T. Yuisono, *Jpn. Kokai* 77 03, 084; *Chem. Abstr.*, 87 (1977) 85031.
24. M. Takaya, M. Sato, K. Terashima, H. Tanizawa and Y. Maki, *J. Med. Chem.*, 22 (1979) 53.
25. M. Sato, Y. Ishizuka and A. Yamaguchi, *Arzneim.-Forsch.*, 31 (1981) 1738.
26. I. Satoda, M. Takaya and Y. Maki, *Jpn. Kokai* 74 116, 085; *Chem. Abstr.*, 83 (1975) 164216.
27. M. Takatani and T. Kishikawa, *Jpn. Kokai Tokkyo Koho* 78 121, 772; *Chem. Abstr.*, 90 (1979) 121626.
28. I. Satoda, M. Takaya and Y. Maki, *Jpn. Kokai* 74 117, 481; *Chem. Abstr.*, 83 (1975) 164218.
29. T. Kishikawa and T. Matsuo, *Jpn. Kokai* 76 59, 883; *Chem. Abstr.*, 86 (1977) 43726.
30. M. Takaya, K. Terashima, H. Tanizawa, M. Sato and T. Kishikawa, *Jpn. Kokai Tokkyo Koho* 78 124, 278; *Chem. Abstr.*, 90 (1979) 152222.
31. M. Takaya, K. Terashima, H. Tanizawa, M. Sato and T. Kishikawa, *Jpn. Kokai* 78 31, 684; *Chem. Abstr.*, 89 (1978) 109547.
32. M. Sato, H. Tanizawa, T. Fukuda and T. Yuizono, *Jpn. J. Pharmacol.*, 29 (1979) 303.
33. N.A. Santagati, F. Duro, A. Caruso, S. Trombadore and M. Amico-Roxas, *Farmaco, Ed. Sci.*, 40 (1985) 921.
34. E. Schacht, H.A. Kurmeier, J. Gante, R. Lissner, G. Melzer and D. Orth, *Eur. Pat. Appl.* 10, 156; *Chem. Abstr.*, 93 (1980) 204679.
35. M. Sato, H. Tanizawa, T. Fukuda and T. Yuizono, *Nippon Yakurigaku Zasshi*, 74 (1978) 841; *Chem. Abstr.*, 90 (1979) 115089.
36. T. Matsui, H. Tanaka, M. Yoshida, R. Nakagi and M. Sato, *Yakuri to Chiryō*, 13 (1985) 1989; *Chem. Abstr.*, 103 (1985) 115897.
37. M. Sato and A. Yamaguchi, *Arzneim.-Forsch.*, 32 (1982) 379.
38. M. Sato, *Arch. Int. Pharmacodyn. Ther.*, 257 (1982) 200.
39. M. Sato, Y. Ishizuka, K. Seki, H. Tanizawa, T. Fukuda and T. Yuizono, *Nippon Yakurigaku Zasshi*, 75 (1979) 127; *Chem. Abstr.*, 91 (1979) 49479.
40. M. Sato, M. Kataoka and A. Yamaguchi, *J. Pharmacobio-Dyn.*, 4 (1981) 649.
41. Y. Gomita, H. Kawasaki, M. Sato, T. Yuizono and T. Fukuda, *Oyo Yakuri*, 18 (1979) 23; *Chem. Abstr.*, 92 (1980) 104389.
42. M. Sato, *Nippon Yakurigaku Zasshi*, 75 (1979) 695; *Chem. Abstr.*, 92 (1980) 157654.
43. M. Matsumura, H. Mori and S. Saito, *Igaku no Ayumi*, 136 (1986) 883; *Chem. Abstr.*, 105 (1986) 72951.
44. M. Sato, I. Kimura, H. Tanizawa, T. Fukuda and T. Yuizono, *Oyo Yakuri*, 17 (1979) 241; *Chem. Abstr.*, 91 (1979) 83393.

45. M. Sato, H. Tanizawa and T. Yuizono, *Oyo Yakuri*, 16 (1978) 1011; *Chem. Abstr.*, 90 (1979) 197741.
46. K. Shimpō, N. Mori, M. Takahashi, N. Aoki, H. Togashi, K. Hiroga, T. Kosazuma, H. Shimazu and T. Tanabe, *J. Toxicol. Sci.*, 4 (1979) 255.
47. C. Onodera, T. Hayashi, I. Makita, T. Hashi, K. Takeda, F. Ozeki and H. Shimazu, *J. Toxicol. Sci.*, 4 (1979) 229.
48. H. Tanigawa, H. Tanaka, R. Obori, J. Yoshida and T. Kosazuma, *Oyo Yakuri*, 18 (1979) 417; *Chem. Abstr.*, 92 (1980) 157695.
49. H. Tanigawa, J. Yoshida, H. Tanaka, R. Obori and T. Kosazuma, *Oyo Yakuri*, 18 (1979) 429; *Chem. Abstr.*, 92 (1980) 157696.
50. H. Tanigawa, T. Kosazuma, H. Tanaka and R. Obori, *J. Toxicol. Sci.*, 3 (1978) 69.
51. H. Tanigawa, R. Obori, H. Tanaka, J. Yoshida and T. Kosazuma, *J. Toxicol. Sci.*, 4 (1979) 175.
52. H. Tanigawa, R. Obori, H. Tanaka, J. Yoshida and T. Kosazuma, *J. Toxicol. Sci.*, 4 (1979) 163.
53. H. Tanigawa, R. Obori, H. Tanaka, J. Yoshida and S. Okuma, *Iyakuin Kenkyu*, 11 (1980) 559; *Chem. Abstr.*, 94 (1981) 132177.
54. J. Yoshida, H. Tanaka, R. Obori and H. Tanigawa, *Iyakuin Kenkyu*, 11 (1980) 566; *Chem. Abstr.*, 94 (1981) 95989.
55. T. Hayashi, M. Sato, M. Ohki and T. Kishikawa, *Chem. Pharm. Bull.*, 26 (1978) 3124.
56. T. Hayashi, M. Aoyama, M. Fukuda, M. Ohki and T. Kishikawa, *Chem. Pharm. Bull.*, 27 (1979) 317.
57. M. Amino, T. Hayashi, T. Matsuo and A. Yamaguchi, *Yakugaku Zasshi*, 99 (1979) 1091; *Chem. Abstr.*, 92 (1980) 87794.
58. T. Hayashi, M. Amino, A. Yamaguchi and M. Ohki, *Yakugaku Zasshi*, 100 (1980) 105; *Chem. Abstr.*, 92 (1980) 157499.
59. M. Amino, T. Hayashi, M. Tsuchikawa and A. Yamaguchi, *Oyo Yakuri*, 18 (1979) 773; *Chem. Abstr.*, 92 (1980) 191016.
60. T. Hayashi, *Chem. Pharm. Bull.*, 30 (1982) 3748.
61. T. Hayashi, M. Amino and Y. Ikoma, *Xenobiotica*, 13 (1983) 461.
62. T. Seki, T. Hayashi, M. Oki and T. Kishikawa, *Rinsho Yakuri*, 9 (1978) 149; *Chem. Abstr.*, 89 (1978) 173334.
63. M. Takaya, T. Yamada and H. Shimamura, *Yakugaku Zasshi*, 98 (1978) 1421; *Chem. Abstr.*, 90 (1979) 80647.
64. M. Sato, Y. Ishizuka, I. Kimura, H. Tanizawa and T. Yuizono, *Oyo Yakuri*, 17 (1979) 249; *Chem. Abstr.*, 91 (1979) 133938.
65. Y. Ishizuka, M. Sato and H. Tanizawa, *Nippon Yakurigaku Zasshi*, 75 (1979) 633; *Chem. Abstr.*, 92 (1980) 69473.
66. T. Seki, *Jpn. J. Clin. Pharmacol.*, 9 (1978) 143.
67. P. Kyun, *Acta Urol. Jap.*, 25 (1979) 211.
68. M. Sato, I. Kimura and A. Yamaguchi, *Eur. Pat. Appl. EP 59, 031*; *Chem. Abstr.*, 97 (1982) 203250.
69. Morishita Pharm. Co. Ltd., *Jpn. Kokai Tokkyo Koho JP 82 128, 626*; *Chem. Abstr.*, 97 (1982) 203232.
70. I. Kimura, M. Yoshida and M. Sato, *Yakuri to Chiryō*, 13 (1985) 2797; *Chem. Abstr.*, 103 (1985) 153586.
71. T. Hayashi, M. Amino, M. Fukuda, F. Yoshida and M. Yoshida, *Yakuri to Chiryō*, 13 (1985) 2807; *Chem. Abstr.*, 103 (1985) 115705.

72. R. Bluth, Ger. (East) DD 150, 150; Chem. Abstr., 96 (1982) 57775.
73. R. Bluth, Pharmazie, 36 (1981) 775.
74. R. Bluth, Pharmazie, 37 (1982) 208.
75. R. Bluth, Pharmazie, 37 (1982) 136.
76. R. Bluth, Pharmazie, 37 (1982) 502.
77. R. Bluth, Pharmazie, 37 (1982) 441.
78. R. Bluth, Pharmazie, 37 (1982) 285.
79. K.R. Rao and P.B. Sattur, Indian J. Chem., Sect. B., 14B (1976) 203.
80. K. Shinozaki, T. Kimura, T. Kawada, T. Okazaki, S. Sugai, M. Akaboshi, S. Ikegami, Y. Kajiwara and T. Kanbara, Jpn. Kokai Tokkyo Koho JP 86 151, 177; Chem. Abstr., 106 (1987) 33084.
81. P.L. Anderson, W.J. Houlihan and R.E. Manning, U.S. 3, 978, 057; Chem. Abstr., 86 (1977) 16691.
82. I. Matsuura, S. Tomizawa, N. Sato and K. Furuno, Jpn. Kokai 77 31, 083; Chem. Abstr., 87 (1977) 68353.
83. F. Haviv and R.L. Walters, U.S. Patent 4, 503, 056; Chem. Abstr., 102 (1985) 185096.
84. W.J. Houlihan, U.S. Patent 3, 920, 646; Chem. Abstr., 84 (1976) 121879.
85. L.J. Powers, PCT Int. Appl. WO 8, 300, 863; Chem. Abstr., 99 (1983) 70746.
86. L. Pitarch, R. Coronas and J. Mallol, Eur. J. Med. Chem.-Chim. Ther., 9 (1974) 644.
87. I. Nitelea, M. Petrovanu, E. Rucinschi, M. Caprosu, I. Ciocoiu, E. Stefanescu, A. Carstea and A. Mihalcea, Rom. RO 75, 837; Chem. Abstr., 99 (1983) 139960.
88. M. Takaya, T. Yamada and T. Yuizono, Jpn. Kokai 78 21, 180; Chem. Abstr., 89 (1978) 24342.
89. Janssen Pharm., Jpn. Kokai Tokkyo Koho JP 87 29, 575; Chem. Abstr., 106 (1987)
90. K.H. Schellekens, F.A. Wouters, K.S. Artois, R.E. Frederickx, H.M. Henderickx, W. Van Bruggen and C.J. Niemegeers, Drug Dev. Res., 8 (1986) 353; Chem. Abstr., 105 (1986) 164810.
91. G. Nannini, G. Biasoli, E. Perrone, A. Forgione, A. Buttinoni and M. Ferrari, Eur. J. Med. Chem.-Chim. Ther., 14 (1979) 53.
92. C. Rubat, P. Coudert, J. Couquelet, P. Bastide and J. Bastide, Chem. Pharm. Bull., 36 (1988) 1558.
93. Pham Huu Chanh, B. Lasserre, V. Dossou-Gbete, J. Couquelet and P. Tronche, Prostaglandins, Leukotrienes Med., 30 (1987) 1.
94. J. Van Meel, V. Trach, V. Austel, J. Heider and W. Eberlein, Ger. Offen. DE 3, 536, 030; Chem. Abstr., 107 (1987) 23353.
95. S.N. Sawhney, S. Bhutani and D. Vir, Indian J. Chem., Sect. B., 26B (1987) 348.
96. M. Negwer, Organic-chemical Drugs and their Synonyms (Akademie-Verlag Berlin) 6th Edn., Vol. I-III (1987).
97. T. Yamada, Y. Nobuhara, H. Shimamura, K. Yoshihara, A. Yamaguchi and M. Ohki, Chem. Pharm. Bull., 29 (1981) 3433.
98. S. Okabe, Y. Ishihara, S. Adachi, M. Matsumoto, Y. Kawahara and K. Arita, Oyo Yakuri, 19 (1980) 1019; Chem. Abstr., 94 (1981) 76683.
99. Morishita Pharm. Co. Ltd., Jpn. Kokai Tokkyo Koho 80 118, 469; Chem. Abstr., 94 (1981) 103408.
100. M. Takaya, T. Yamada and T. Yuizono, U.S. Patent 4, 242, 512; Chem. Abstr., 95 (1981) 43150.
101. T. Yamada, Y. Nobuhara, A. Yamaguchi and M. Ohki, J. Med. Chem., 25 (1982) 975.

102. Morishita Pharm. Co. Ltd., Jpn. Kokai Tokkyo Koho JP 82 42, 676; Chem. Abstr., 97 (1982) 72379.
103. Morishita Pharm. Co. Ltd., Jpn. Kokai Tokkyo Koho JP 57 188, 574; Chem. Abstr., 98 (1983) 198259.
104. Morishita Pharm. Co. Ltd., Jpn. Kokai Tokkyo Koho 80 118, 470; Chem. Abstr., 94 (1981) 175142.
105. T. Yamada, Eur. Pat. Appl. 30, 835; Chem. Abstr., 95 (1981) 203979.
106. T. Yamada, Y. Nobuhara, H. Shimamura, Y. Tsukamoto, K. Yoshihara, A. Yamaguchi and M. Ohki, J. Med. Chem., 26 (1983) 373.
107. T. Yamada, H. Shimamura, Y. Tsukamoto, A. Yamaguchi and M. Ohki, J. Med. Chem., 26 (1983) 1144.
108. T. Yamada, Y. Tsukamoto, H. Shimamura, S. Banno and M. Sato, Eur. J. Med. Chem.-Chim. Ther., 18 (1983) 209.
109. Morishita Pharm. Co. Ltd., Jpn. Kokai Tokkyo Koho JP 58 146, 571; Chem. Abstr., 100 (1984) 51593.
110. V. Austel, J. Heider, W. Eberlein and W. Diederer, Ger. Offen. 2, 922, 336; Chem. Abstr., 94 (1981) 175143.
111. P.A. Rossy, M. Thyès, A. Franke, H. Koenig, H.D. Lehmann, J. Gries, L. Friedrich and D. Lenke, Ger. Offen. DE 3, 302, 021; Chem. Abstr., 101 (1984) 230558.
112. M. Thyès, P.A. Rossy, H. Koenig, H.D. Lehmann, J. Gries and D. Lenke, Ger. Offen. DE 3, 302, 442; Chem. Abstr., 102 (1985) 24641.
113. K.H. Geiss, B. Schmied, R. Kropp, V. Baldinger, J. Gries, H.D. Lehmann, K. Ruebsamen and M. Traut, Ger. Offen. DE 3, 600, 275; Chem. Abstr., 107 (1987) 115602.
114. Y. Morisawa, M. Kataoka, H. Koike, S. Kobayashi and S. Kumakura, Jpn. Kokai Tokkyo Koho JP 62 142, 165; Chem. Abstr., 108 (1988) 37852.
115. G.J. Durant, J.C. Emmett and C.R. Ganellin, U.S. Patent 4, 018, 931; Chem. Abstr., 87 (1977) 184510.
116. M.C. Gomez Gil, V. Gomez Parra, F. Sanchez Alonso and T. Torres Cebada, Span. ES 540, 813; Chem. Abstr., 106 (1987) 18587.
117. W.J. Fanshawe and S.R. Safir, U.S. Patent 3, 935, 211; Chem. Abstr., 84 (1976) 135719.
118. G. Thuillier and S.S. Mignonac-Mondon, Ger. Offen. 2, 817, 649; Chem. Abstr., 90 (1979) 54964.
119. W.J. Houlihan and R.E. Manning, Can. Patent 959, 845; Chem. Abstr., 83 (1975) 10124.
120. C.G. Wermuth, G. Schlewer and M. Heaulme, Eur. Pat. Appl. EP 221, 820; Chem. Abstr., 107 (1987) 236724.
121. Y. Tsuda, H. Yasuda and T. Yokobe, Jpn. Kokai 77 128, 386; Chem. Abstr., 88 (1978) 89700.
122. R. Schlecker, R. Kropp, F. Reicheneder, J. Gries, H.P. Hofmann, H.J. Teschendorf and M. Traut, Ger. Offen. DE 3, 436, 550; Chem. Abstr., 103 (1985) 215309.
123. H.J. May, M. Traut, H. Weifenbach, V. Baldinger, J. Gries and H.J. Teschendorf, Ger. Offen. DE 3, 542, 197; Chem. Abstr., 107 (1987) 134317.
124. J. Kosary, G. Szilagyi, P. Matyus, K. Czako and E. Kasztreiner, Acta Pharm. Hung., 53 (1983) 106.
125. C.G. Wermuth, H. Davi and K. Bizière, Eur. Pat. Appl. EP 72, 299; Chem. Abstr., 99 (1983) 105265.
126. J.P. Chambon, K. Bizière and C.G. Wermuth, Fr. Demande FR 2, 540, 113; Chem. Abstr., 102 (1985) 62256.
127. J.P. Kan, K. Bizière and C.G. Wermuth, Fr. Demande FR 2, 539, 739; Chem. Abstr., 102 (1985) 45966.

128. C.G. Wermuth, K. Bizière and J.P. Kan, Eur. Pat. Appl. EP 72, 726; Chem. Abstr., 99 (1983) 88217.
129. J.P. Kan, K. Bizière and C.G. Wermuth, Fr. Demande FR 2, 540, 115; Chem. Abstr., 102 (1985) 62255.
130. K. Bizière, J.P. Kan and C.G. Wermuth, Eur. Pat. Appl. EP 116, 494; Chem. Abstr., 102 (1985) 24642.
131. J.P. Kan, K. Bizière and C.G. Wermuth, Fr. Demande FR 2, 539, 742; Chem. Abstr., 102 (1985) 45967.
132. K. Bizière, J.P. Kan, J. Souilhac, J.P. Muyard and R. Roncucci, *Arzneim.-Forsch.*, 32 (1982) 824.
133. P. Worms, J.P. Kan, A. Perio, C.G. Wermuth, K. Bizière and R. Roncucci, *J. Pharmacol.*, 17 (1986) 126.
134. K. Bizière, J.P. Kan, C. Goniot, S. Garattini and C.G. Wermuth, *J. Neurochem.*, 41 (1983) 78.
135. S. Garattini, G.L. Forloni, S. Tirelli, H. Ladinsky and S. Consolo, *Psychopharmacology*, 82 (1984) 210.
136. P. Ferretti, S. Algeri, F. Benfenati, M. Cimino, C. Ferretti, S. Garattini and M. Lipartiti, *J. Pharm. Pharmacol.*, 36 (1984) 48.
137. K. Bizière, P. Worms, J.P. Kan, P. Mandel, S. Garattini and R. Roncucci, *Drugs Exp. Clin. Res.*, 11 (1985) 831.
138. P. Worms, J.P. Kan, P. Mandel, K. Bizière and R. Roncucci, *Minaprine: New Psychotropic Drug Act. Affective Disord., Int. Symp.*, (1984) 1; Chem. Abstr., 102 (1985) 125402.
139. H. Laborit, C. Baron, C. Ferran and I. Henriët, *Agressologie*, 23 (1982) 15.
140. H. Laborit, C. Baron, C. Ferran and I. Henriët, *Agressologie*, 22 (1981) 59.
141. H. Laborit, C. Baron, C. Ferran and I. Henriët, *Agressologie*, 22 (1981) 63.
142. G. Leblondel and P. Allain, *Agressologie*, 22 (1981) 101.
143. H. Laborit and J.F. Bonifacj, *Res. Commun. Chem. Pathol. Pharmacol.*, 44 (1984) 63.
144. J.P. Kan, C. Mouget-Goniot, P. Worms, K. Bizière, H. Ladinsky and S. Garattini, *Minaprine: New Psychotropic Drug Act. Affective Disord., Int. Symp.*, (1984) 11; Chem. Abstr., 102 (1985) 160284.
145. J.P. Kan, C. Mouget-Goniot, P. Worms and K. Bizière, *Biochem. Pharmacol.*, 35 (1986) 973.
146. A. Cailleux, D. Leguay, R. Wartel, M. Patay and P. Allain, *Thérapie*, 37 (1982) 45.
147. W. Cautreels, M. De Mello, G. Houin, P. Dupont and J.P. Jeannot, *Minaprine: New Psychotropic Drug Act. Affective Disord., Int. Symp.*, (1984) 21; Chem. Abstr., 102 (1985) 105657.
148. J. Barre, G. Houin, J.P. Jeannot, C. Coirre and J.P. Tillement, *Int. J. Clin. Pharmacol. Res.*, 6 (1986) 1.
149. H. Davi, P. Dupont, J.P. Jeannot, R. Roncucci and W. Cautreels, *Xenobiotica*, 11 (1981) 735.
150. M.H. Fong, A. Abbiati, E. Benfenati and S. Caccia, *J. Chromatogr.*, 259 (1983) 141.
151. S. Caccia, T. Fossati and A. Mancinelli, *Xenobiotica*, 15 (1985) 1111.
152. H. Davi, A. Carayon, E. Marti, Y. Sales and W. Cautreels, *Xenobiotica*, 15 (1985) 97.
153. P. Mikus, K. Bizière and U. Bentel, *Clin. Tri. J.*, 22 (1985) 477.
154. M. Fromantin, J.P. Fensch, J.P. Muyard, P. Lena and D. Gautier, *Probl. Actuels Endocrinol. Nutr.*, 21 (1977) 43; Chem. Abstr., 90 (1979) 97700.
155. M. Passeri, D. Cucinotta, M. De Mello, G. Storchi, R. Roncucci and K. Bizière, *Lancet*, i (1985) 824.

156. N. Bohacek, M. Ravic and K. Bizière, *J. Clin. Psychopharmacol.*, 6 (1986) 320.
157. M. Passeri, D. Cucinotta, M. De Mello and K. Bizière, *Int. J. Geriatr. Psych.*, 2 (1987) 97.
158. E. Radmayr, U. Bentel and K. Bizière, *Clin. Tri. J.*, 23 (1986) 100.
159. P. Worms, J.P. Kan, C.G. Wermuth and K. Bizière, *Naunyn-Schmiedeberg's Arch. Pharmacol.*, 334 (1986) 246.
160. P. Worms, J.P. Kan, C.G. Wermuth, R. Roncucci and K. Bizière, *J. Pharmacol. Exp. Ther.*, 240 (1987) 241.
161. J.P. Kan, R. Steinberg, C. Mouget-Goniot, P. Worms, and K. Bizière, *J. Pharmacol. Exp. Ther.*, 240 (1987) 251.
162. J.P. Kan, R. Steinberg, J. Leclercq, P. Worms, and K. Bizière, *J. Neurochem.*, 50 (1988) 1137.
163. W.J. Houlihan, U.S. Patent 3, 931, 176; *Chem. Abstr.*, 84 (1976) 105630.
164. J. Taoufik, J.D. Couquelet, J. Bastide, P. Bastide and P. Champiat, *Ann. Pharm. Fr.*, 42 (1984) 135.
165. A. Perio, J.P. Chambon, R. Calassi, M. Heaulme and K. Bizière, *J. Pharmacol. Exp. Ther.*, 239 (1986) 542.
166. H. Chibret, *Ger. Offen. DE 3, 321, 772*; *Chem. Abstr.*, 100 (1984) 191896.
167. J. Linder, U.S. Patent 3, 892, 859; *Chem. Abstr.*, 83 (1975) 152378.
168. J. Linder, U.S. Patent 4, 002, 751, *Chem. Abstr.*, 86 (1977) 189990.
169. K. Bizière, J.P. Chambon and A. Hallot, *Eur. Pat. Appl. EP 114, 770*; *Chem. Abstr.*, 101 (1984) 230559.
170. I. Nitelea, M. Petrovanu, E. Rucinschi, M. Caprosu, I. Ciocoiu, E. Stefanescu, A. Carstea and A. Mihalcea, *Rom. RO 75, 836*; *Chem. Abstr.*, 99 (1983) 139959.
171. S. Cilianu-Bibian, A. Carstea, M. Petrovanu, E. Rucinschi, I. Druta, M. Caprosu, I. Ciocoiu and A. Mihalcea, *Rom. RO 87, 512*; *Chem. Abstr.*, 105 (1986) 115082.
172. L. Bernardi, C. Elli, G. Falconi and A. Bonsignori, *Ger. Offen. 2, 803, 255*; *Chem. Abstr.*, 89 (1978) 215645.
173. Società Farmaceutici Italia, S.p.A., *Jpn. Kokai Tokkyo Koho 78, 105, 499*; *Chem. Abstr.*, 90 (1979) 55150.
174. G.B. Bennett, U.S. Patent 4, 177, 273; *Chem. Abstr.*, 92 (1980) 94416.
175. W.J. Fanshawe and S.R. Safir, U.S. Patent 3, 857, 843; *Chem. Abstr.*, 82 (1975) 140184.
176. W.J. Fanshawe and S.R. Safir, U.S. Patent 3, 906, 097; *Chem. Abstr.*, 83 (1975) 193393.
177. J.P. Chambon and C.G. Wermuth, *Eur. Pat. Appl. EP 73, 161*; *Chem. Abstr.*, 99 (1983) 5640.
178. J. Linder, *Fr. Demande 2, 222, 089*; *Chem. Abstr.*, 82 (1975) 156352.
179. R.W. Horton, J.F. Collins, G.M. Anlezark and B.S. Meldrum, *Eur. J. Pharmacol.*, 59 (1979) 75.
180. R. Zabska and T. Jakobiec, *Arch. Immunol. Ther. Exp.*, 32 (1984) 263.
181. G. Tian and Ch. Lin, *Gaodeng Xuexiao Huaxue Xuebao*, 5 (1984) 350; *Chem. Abstr.*, 101 (1984) 191820.
182. M.J. Kornet and J. Chu, *J. Heterocycl. Chem.*, 18 (1981) 293.
183. M.J. Kornet and J. Chu, *J. Pharm. Sci.*, 72 (1983) 94.
184. A. Hallot, R. Brodin, J. Merlier, J. Brochard, J.P. Chambon and K. Bizière, *J. Med. Chem.*, 29 (1986) 369.
185. J.P. Chambon, A. Hallot and K. Bizière, *Curr. Probl. Epilepsy*, 4 (1986) 313.
186. J.P. Chambon, J. Brochard, A. Hallot, M. Heaulme, R. Brodin, R. Roncucci and K. Bizière, *J. Pharmacol. Exp. Ther.*, 233 (1985) 836.

187. V. Santucci, D. Rocher, J. Veyrun and K. Bizière, *Naunyn-Schmiedeberg's Arch. Pharmacol.*, 333 (1986) 186.
188. W.J. Houlihan, U.S. Patent 4, 162, 317; *Chem. Abstr.*, 91 (1979) 175380.
189. W.J. Houlihan, U.S. Patent 4, 228, 166; *Chem. Abstr.*, 96 (1982) 57750.
190. C.G. Wermuth, J.J. Bourguignon, G. Schlewer, J.P. Gies, A. Schoenfelder, A. Melikian, M.J. Bouchet, D. Chantreux, J.C. Molimard, M. Heaulme, J.P. Chambon and K. Bizière, *J. Med. Chem.*, 30 (1987) 239.
191. V. Santucci, M. Fournier, J.P. Chambon and K. Bizière, *Eur. J. Pharmacol.*, 114 (1985) 219.
192. P. Schmitt, G. Di Scala, M.L. Brandao and P. Karli, *Eur. J. Pharmacol.*, 117 (1985) 149.
193. P. Worms, J.P. Chambon and K. Bizière, *Eur. J. Pharmacol.*, 138 (1987) 343.
194. J.P. Chambon, P. Feltz, M. Heaulme, S. Restle, R. Schlichter, K. Bizière and C.G. Wermuth, *Proc. Natl. Acad. Sci.*, 82 (1985) 1832.
195. M. Heaulme, J.P. Chambon, R. Leyris, J.C. Molimard, C.G. Wermuth and K. Bizière, *Brain Res.*, 384 (1986) 224.
196. M. Heaulme, J.P. Chambon, R. Leyris, C.G. Wermuth and K. Bizière, *Neuropharmacology*, 25 (1986) 1279.
197. J.C. Michaud, J.M. Mienville, J.P. Chambon and K. Bizière, *Neuropharmacology*, 25 (1986) 1197.
198. B.D. Gynther and D.R. Curtis, *Neurosci. Lett.*, 68 (1986) 211.
199. M. Desarmenien, E. Desaulles, P. Feltz and M. Hamann, *Br. J. Pharmacol.*, 90 (1987) 287.
200. M. Heaulme, J.P. Chambon, R. Leyris, C.G. Wermuth and K. Bizière, *J. Neurochem.*, 48 (1987) 1677.
201. J.M. Mienville and S. Vicini, *Neuropharmacology*, 26 (1987) 779.
202. Th. Boulanger, D.P. Vercauteren, G. Evrard and F. Durant, *J. Crystallogr. Spectrosc. Res.*, 17 (1987) 561.
203. C.G. Wermuth, J.P. Chambon, M. Heaulme, A. Melikian, G. Schlewer, R. Leyris and K. Bizière, *Eur. J. Pharmacol.*, 144 (1987) 375.
204. M. Hamann, M. Desarmenien, E. Desaulles, M.F. Bader and P. Feltz, *Brain Res.*, 442 (1988) 287.
205. K. Thomae GmbH., *Fr. Demande* 2, 273, 545; *Chem. Abstr.*, 85 (1976) 192752.
206. R. Lebkuecher, M. Thyes, H. Koenig, H.D. Lehmann, J. Gries, D. Lenke and J. Kunze, *Ger. Offen.* 2, 727, 481; *Chem. Abstr.*, 90 (1979) 137849.
207. T. Nakao, H. Mikajima and N. Setoguchi, *Jpn. Kokai Tokkyo Koho* 78, 124, 279; *Chem. Abstr.*, 90 (1979) 168635.
208. V. Austel, J. Heider, W. Eberlein, W. Diederer and W. Haarmann, *Ger. Offen.* 2, 837, 161; *Chem. Abstr.*, 93 (1980) 114525.
209. T. Nakao, N. Setoguchi and O. Yaoka, *Jpn. Kokai Tokkyo Koho* 80 49, 319; *Chem. Abstr.*, 93 (1980) 210262.
210. Yoshitomi Pharm. Ind. Ltd., *Jpn. Kokai Tokkyo Koho* 80 53, 283; *Chem. Abstr.*, 93 (1980) 220764.
211. Yoshitomi Pharm. Ind., Ltd., *Neth. Appl.* 78 10, 396; *Chem. Abstr.*, 93 (1980) 239442.
212. M. Thyes, J. Gries, H.D. Lehmann, D. Lenke and J. Kunze, *Ger. Offen.* 2, 854, 191; *Chem. Abstr.*, 93 (1980) 239443.
213. Yoshitomi Pharm. Ind., Ltd., *Jpn. Kokai Tokkyo Koho* 80 83, 781; *Chem. Abstr.*, 94 (1981) 47349.
214. Yoshitomi Pharm. Ind., Ltd., *Jpn. Kokai Tokkyo Koho* 80 141, 483; *Chem. Abstr.*, 94 (1981) 121578.

215. M. Thyse, H. Koenig, D. Lenke, H.D. Lehmann and J. Gries, Ger. Offen. DE 3, 022, 176; Chem. Abstr., 96 (1982) 104272.
216. M. Thyse, A. Franke, H. Koenig, D. Lenke, H.D. Lehmann and J. Gries, Ger. Offen. DE 3, 022, 177; Chem. Abstr., 96 (1982) 142875.
217. R. Goeschke, Eur. Pat. Appl. EP 59, 688; Chem. Abstr., 98 (1983) 53923.
218. V. Austel, J. Heider, W. Eberlein, W. Diederer and W. Haarmann, U.S. 4, 361, 563; Chem. Abstr., 98 (1983) 72123.
219. H. Lautenschlaeger, G. Hilboll, H. Friehe and J.P. Loehr, Ger. Offen. DE 3, 130, 251; Chem. Abstr., 98 (1983) 160722.
220. N. Haul, V. Austel, J. Heider, M. Reiffen, W. Diederer and W. Haarmann, Ger. Offen. DE 3, 129, 447; Chem. Abstr., 98 (1983) 198261.
221. Mitsui Toatsu Chemicals, Inc., Jpn. Kokai Tokkyo Koho JP 58 69, 869; Chem. Abstr., 99 (1983) 88221.
222. T. Katakami, N. Fukazawa, H. Iizuka, T. Nishina, J. Kamiya, Y. Tanaka and T. Nakano, PCT Int. Appl. WO 83 01, 447; Chem. Abstr., 99 (1983) 88219.
223. M. Thyse, A. Franke, H. Koenig, D. Lenke, H.D. Lehmann and J. Gries, Eur. Pat. Appl. EP 42, 513; Chem. Abstr., 96 (1982) 162721.
224. P.A. Rossy, M. Thyse, A. Franke, H. Koenig, J. Gries, H.D. Lehmann and D. Lenke, Ger. Offen. DE 3, 209, 158; Chem. Abstr., 99 (1983) 175786.
225. P.A. Rossy, M. Thyse, A. Franke, H. Koenig, J. Gries, H.D. Lehmann and D. Lenke, Ger. Offen. DE 3, 209, 159; Chem. Abstr., 100 (1984) 6536.
226. T. Katakami, N. Fukazawa, H. Iizuka, T. Nishina, J. Kamiya, Y. Tanaka and T. Nakano, Eur. Pat. Appl. EP 84, 250; Chem. Abstr., 100 (1984) 6534.
227. Mitsui Toatsu Chemicals Inc., Jpn. Kokai Tokkyo Koho JP 59 53, 479; Chem. Abstr., 101 (1984) 90957.
228. Mitsui Toatsu Chemicals Inc., Jpn. Kokai Tokkyo Koho JP 59 53, 482; Chem. Abstr., 101 (1984) 90955.
229. G. Hilboll and J. Biedermann, Ger. Offen. DE 3, 306, 195; Chem. Abstr., 102 (1985) 6517.
230. I. Ueda, K. Taniguchi and Y. Katsura, Eur. Pat. Appl. EP 132, 817; Chem. Abstr., 102 (1985) 166768.
231. J. Biedermann, H. Borbe, E. Graf, G. Hilboll and G. Prop, Ger. Offen. DE 3, 407, 509; Chem. Abstr., 104 (1986) 15084.
232. R.A. Slater, PCT Int. Appl. WO 85 03, 076; Chem. Abstr., 104 (1986) 34098.
233. H. Meyer, G. Franckowiak, U. Rosentreter, R. Gross, G. Thomas, M. Schramm, M. Kayser, F. Seuter, E. Perzborn and M. Bechem, Ger. Offen. DE 3, 445, 852; Chem. Abstr., 105 (1986) 152945.
234. T. Nakao, N. Setoguchi and O. Yaoka, Jpn. Kokai Tokkyo Koho 79 19, 987; Chem. Abstr., 91 (1979) 39511.
235. H.H. Lautenschlaeger, G. Hilboll, H. Friehe and J.P. Loehr, Ger. Offen. DE 3, 130, 252; Chem. Abstr., 98 (1983) 198225.
236. G. Hilboll, G. Prop, H. Borbe, J.P. Loehr and I.S. Doppelfeld, Ger. Offen. DE 3, 241, 102; Chem. Abstr., 101 (1984) 72744.
237. G. Zoller, R. Beyerle, M. Just, P. Martorana, H. Bohn and R.E. Nitz, Ger. Offen. DE 3, 322, 079; Chem. Abstr., 102 (1985) 132062.
238. J. Gainer and R. Goeschke, Eur. Pat. Appl. EP 180, 542; Chem. Abstr., 105 (1986) 78948.
239. G. Zoller, R. Beyerle, M. Just, H. Bohn, P. Martorana and R.E. Nitz, Eur. Pat. Appl. EP 175, 363; Chem. Abstr., 105 (1986) 153074.
240. N. Haul, B. Narr, K. Noll, A. Bomhard, J. Heider, M. Psiorz, W. Diederer and J. Van Meel, Ger. Offen. DE 3, 511, 110; Chem. Abstr., 106 (1987) 18589.

241. H. Pruecher, J. Rochus, J. Piulats and M. Klockow, Ger. Offen. DE 3, 505, 609; Chem. Abstr., 106 (1987) 33085.
242. I. Sircar, Eur. Pat. Appl. EP 145, 450; Chem. Abstr., 103 (1985) 141997.
243. G. Hilboll, G. Prop, H. Borbe and J. Uhlendorf, Ger. Offen. DE 3, 401, 911; Chem. Abstr., 104 (1986) 34096.
244. I. Sircar, U.S. Patent 4, 656, 170; Chem. Abstr., 106 (1987) 213965.
245. E.M. Griffett, S.M. Kinnon, A. Kumar, D. Lecker, G.M. Smith and E.G. Tomich, Br. J. Pharmacol., 72 (1981) 697.
246. M. Thyges, J. Gries, H.D. Lehmann, D. Lenke and J. Kunze, Ger. Offen. 2, 854, 475; Chem. Abstr., 94 (1981) 15760.
247. P.A. Rossy, M. Thyges, A. Franke, H. Koenig, J. Gries, H.D. Lehmann and D. Lenke, Ger. Offen. DE 3, 135, 617; Chem. Abstr., 98 (1983) 198262.
248. N. Hael, K. Noll, B. Narr, J. Heider, M. Psiorz, A. Bomhard, W. Diederer and J. Van Meel, Ger. Offen. DE 3, 606, 254; Chem. Abstr., 108 (1988) 21915.
249. Yoshitomi Pharm. Ind., Ltd., Jpn. Kokai Tokkyo Koho 80 53, 284; Chem. Abstr., 93 (1980) 220765.
250. T. Nakao, S. Setoguchi and O. Yaoka, Fr. Demande 2, 439, 196; Chem. Abstr., 94 (1981) 65712.
251. T. Nakao, S. Setoguchi and O. Yaoka, Br. UK Pat. Appl. 2, 031, 404; Chem. Abstr., 94 (1981) 103407.
252. G. Zoller, R. Beyerle, M. Just, P. Martorana, H. Bohn and R.E. Nitz, Eur. Pat. Appl. EP 129, 791; Chem. Abstr., 102 (1985) 220886.
253. H. Koenig, Ger. Offen. DE 3, 535, 949; Chem. Abstr., 107 (1987) 102661.
254. M. Thyges, H.D. Lehmann, J. Gries, H. Koenig, R. Kretzschmar, J. Kunze, R. Lebkuecher and D. Lenke, J. Med. Chem., 26 (1983) 800.
255. S.P. Gupta, D.G. Shewade, C. Garg, A. Handa and Y. S. Prabhakar, Indian J. Biochem. Biophys., 22 (1985) 122.
256. Anonymous, Drugs of the Future, 7 (1982) 714.
257. D. Barlocco, A. Martini, G.A. Pinna, M.M. Curzu, F. Sala and M. Germini, Farmaco, Ed. Sci., 42 (1987) 585.
258. H. Mikashima, T. Nakao and K. Goto, Thromb. Res., 31 (1983) 599.
259. H. Mikashima, T. Nakao, K. Goto, H. Ochi, H. Yasuda and T. Tsumagari, Thromb. Res., 35 (1984) 589.
260. T. Nakao, S. Setoguchi and O. Yaoka, Ger. Offen. DE 2, 845, 220.
261. E.M. Griffett, S.M. Konnon, A. Kumar, D. Lecker, G.M. Smith and E.G. Tomich, Br. J. Pharmacol., 72 (1981) 697.
262. M. Takatani, T. Yamashita, T. Kishikawa and K. Maki, Jpn. Kokai 77 85, 181; Chem. Abstr., 88 (1978) 6927.
263. D. Lecker and A. Kumar, Thromb. Haemostasis, 44 (1980) 9.
264. W.J. Coates, Eur. Pat. Appl. EP 220, 044; Chem. Abstr., 108 (1988) 112503.
265. Yoshitomi Pharm. Ind., Ltd., Jpn. Kokai Tokkyo Koho 80 160, 773; Chem. Abstr., 95 (1981) 62244.
266. Yoshitomi Pharm. Ind., Ltd., Jpn. Kokai Tokkyo Koho 80 141, 484; Chem. Abstr., 94 (1981) 121577.
267. Yoshitomi Pharm. Ind., Ltd., Jpn. Kokai Tokkyo Koho 80 139, 376; Chem. Abstr., 94 (1981) 121579.
268. V. Austel, E. Kutter, J. Heider, W. Eberlein and R. Kadatz, Ger. Offen. 2, 427, 943; Chem. Abstr., 84 (1976) 121880.

269. J.E. Dunbar and L.E. Begin, U.S. Patent 4, 058, 520; Chem. Abstr., 88 (1978) 89699.
270. K. Samula and M. Serwin-Krajewska, Acta Pol. Pharm., 38 (1981) 33.
271. Pham Huu Chanh, B. Lasserre, V. Dossou-Gbete, A.L. Palhares de Miranda, R. Kaiser, P. Tronche and J. Couquelet, IRCS Med. Sci., 13 (1985) 690; Chem. Abstr., 103 (1985) 205974.
272. Pham Huu Chanh, B. Lasserre, P. Tronche, J. Couquelet, V. Dossou-Gbete and A.L. Palhares de Miranda, Prostaglandins, 19 (1985) 37.
273. M. Takaya, T. Yamashita, H. Kohara, T. Fukuda, A. Yamaguchi and T. Kishikawa, Jpn. Kokai 77 03, 081; Chem. Abstr., 87 (1977) 201567.
274. M. Takatani, T. Yamashita, H. Kohara, T. Fukuda, H. Yamaguchi and T. Kishikawa, Jpn. Kokai 77 91, 883; Chem. Abstr., 88 (1978) 37821.
275. M. Takaya, T. Yamashita, A. Yamaguchi and H. Kohara, Yakugaku Zasshi, 98 (1978) 1530; Chem. Abstr., 90 (1979) 87377.
276. S. Kamiya, M. Anzai, T. Nakashima, S. Sueyoshi, M. Tanno, I. Suzuki, M. Ishidate and S. Odashima, Chem. Pharm. Bull., 25 (1977) 504.
277. M. Anzai, I. Suzuki, S. Kamiya, T. Nakashima, M. Nakadate, A. Nakamura, S. Sueyoshi, M. Tanno, M. Miyahara et al., Eisei Shikensho Hokoku, 94 (1976) 148; Chem. Abstr., 87 (1977) 177554.
278. S. Kamiya, M. Miyahara, S. Sueyoshi, I. Suzuki and S. Odashima, Chem. Pharm. Bull., 26 (1978) 3884.
279. B. Hladon, S. Baloniak, P. Szafarek and I. Zyczynska-Baloniak, Arch. Immunol. Ther. Exp., 28 (1980) 427.
280. B. Hladon, S. Baloniak and A. Mroczkiewicz, Pol. J. Pharmacol. Pharm., 33 (1981) 445.
281. B. Hladon, W. Gutsche, W. Jungstand and S. Baloniak, Pol. J. Pharmacol. Pharm., 34 (1982) 207.
282. L. Skibinska, B. Hladon, T. Hermann and S. Baloniak, Farm. Pol., 40 (1984) 535.
283. L. Skibinska and B. Stefanska, Farm. Pol., 43 (1987) 203.
284. J. Gieldanowski, W. Steuden, J. Skowronska, W. Gorczyca and W. Doskocz, Arch. Immunol. Ther. Exp., 29 (1981) 249.
285. R. Zabska and T. Jakobiec, Arch. Immunol. Ther. Exp., 32 (1984) 255.
286. S. Baloniak, A. Mroczkiewicz and A. Ostrowicz, Acta Pol. Pharm., 39 (1982) 193.
287. J.K. Batra, L.J. Powers, F.D. Hess and E. Hamel, Cancer Res., 46 (1986) 1889.
288. H. Koshiyama, F. Sakai and H. Ohkuma, Ger. Offen. 3, 012, 565; Chem. Abstr., 94 (1981) 63776.
289. H. Ohkuma, F. Sakai, Y. Nishiyama, M. Ohbayashi, H. Imanishi, M. Konishi, T. Miyaki, H. Koshiyama and H. Kawaguchi, J. Antibiot., 33 (1980) 1087.
290. H. Koshiyama, F. Sakai and H. Ohkuma, U.S. Patent 4, 360, 458; Chem. Abstr., 98 (1983) 87624.
291. M. Konishi, H. Ohkuma, F. Sakai, T. Tsuno, H. Koshiyama, T. Naito and H. Kawaguchi, J. Antibiot., 34 (1981) 148.
292. M. Konishi, H. Ohkuma, F. Sakai, T. Tsuno, H. Koshiyama, T. Naito and H. Kawaguchi, J. Am. Chem. Soc., 103 (1981) 1241.
293. Cheng-Hsiung Huang, A.W. Prestayko and S.T. Crooke, Biochemistry, 21 (1982) 3704.
294. Cheng-Hsiung Huang, C.K. Mirabelli, S. Mong and S.T. Crooke, Cancer Res., 43 (1983) 2718.
295. W.C. Rose, J.E. Schurig, J.B. Huftalen and W.T. Bradner, Cancer Res., 43 (1983) 1504.
296. Bristol-Myers Co., Neth. Appl. NL 84 00, 237; Chem. Abstr., 102 (1985) 22795.

297. H. Pischel, A. Holy, J. Vesely and G. Wagner, *Collect. Czech. Chem. Commun.*, 49 (1984) 2541.
298. J.A. May and A.C. Sartorelli, *J. Med. Chem.*, 21 (1978) 1333.
299. D.J. Katz, D.S. Wise and L.B. Townsend, *J. Med. Chem.*, 25 (1982) 813.
300. D.J. Katz, D.S. Wise and L.B. Townsend, *J. Heterocycl. Chem.*, 12 (1975) 609.
301. L.L. Wotring, L.C. Bloomer and L.B. Townsend, *Proc. Am. Assoc. Cancer Res.*, 20 (1979) 156.
302. L.C. Bloomer, L.L. Wotring and L.B. Townsend, *Cancer Res.*, 42 (1982) 100.
303. M. Hozumi, H. Nomura and Y. Yoshioka, *Eur. Pat. Appl. EP 40, 039*; *Chem. Abstr.*, 96 (1982) 122199.
304. M.S. Brouwer and R. Van Hes, *Eur. Pat. Appl. EP 193, 249*; *Chem. Abstr.*, 105 (1986) 226078.
305. T. Haga, S. Yamada, H. Sugi, T. Koyanagi and H. Okada, *Jpn. Kokai Tokkyo Koho JP 62, 116, 566*; *Chem. Abstr.*, 107 (1987) 198347.
306. R.F. Abdulla, *U.S. Patent 4, 670, 437*; *Chem. Abstr.*, 107 (1987) 96730.
307. R.A. Stokbroekx, M.J. Van der Aa, J.J. Willems and M.G. Luyckx, *Eur. Pat. Appl. EP 156, 433*; *Chem. Abstr.*, 104 (1986) 129918.
308. J. Easmon, G. Heinisch, W. Holzer and B. Rosenwirth, *Arzneim.-Forsch. (Drug Res.)*, 39 (1989) 1196.
309. V.E. Limanov, *Pharmazie*, 32 (1977) 555.
310. A.K. Basak, S.K. Mazumdar and S. Chaudhuri, *Acta Crystallogr., Sect. C: Cryst. Struct. Commun.*, C43 (1987) 735.
311. S.C. Chaturvedi, S.H. Mishra, K.L. Bhargava and Y. Avadhoot, *Indian Drugs*, 16 (1979) 178; *Chem. Abstr.*, 91 (1979) 169037.
312. Jung Sup Park, *Misaengmul Hakhoe Chi*, 12 (1974) 77; *Chem. Abstr.*, 82 (1975) 140048.
313. Jung Sup Park, *Yakhak Hoe Chi*, 18 (1974) 249; *Chem. Abstr.*, 84 (1976) 30993.
314. R.E. Abdel Ossman and M. Khalifa, *Pharmazie*, 30 (1975) 254.
315. R. Peciura, E. Tarasevicius, R. Martinkus and A. Sosnovskaya, *Pharmazie*, 36 (1981) 862.
316. R. Peciura and E. Tarasevicius, *Farm. Zh.*, 6 (1981) 62; *Chem. Abstr.*, 96 (1982) 100783.
317. D.E. Bublitz, *U.S. Patent 3, 883, 530*; *Chem. Abstr.*, 83 (1975) 147495.
318. M.L. Douglass, *U.S. Patent 3, 966, 928*; *Chem. Abstr.*, 85 (1976) 143127.
319. M.L. Douglass, *U.S. Patent 4, 041, 033*; *Chem. Abstr.*, 87 (1977) 201583.
320. Mitsui Toatsu Chemicals, Inc., *Jpn. Kokai Tokkyo Koho 80 111, 472*; *Chem. Abstr.*, 94 (1981) 175141.
321. Mitsui Toatsu Chemicals, Inc., *Jpn. Kokai Tokkyo Koho 81 51, 458*; *Chem. Abstr.*, 95 (1981) 203978.
322. Sankyo Co., Ltd., *Jpn. Kokai Tokkyo Koho JP 81 156, 206*; *Chem. Abstr.*, 96 (1982) 137992.
323. Fujisawa Pharmaceutical Co., Ltd., *Jpn. Kokai Tokkyo Koho JP 61 246, 163*; *Chem. Abstr.*, 106 (1987) 156278.
324. S. Baloniak, U. Thiel and M. Pacholczyk, *Acta Pol. Pharm.*, 33 (1976) 73.
325. S. Baloniak, A. Mroczkiewicz and M. Cagara, *Acta Pol. Pharm.*, 32 (1975) 445.
326. S. Baloniak and A. Mroczkiewicz, *Ann. Pharm. (Poznan)*, 12 (1977) 53.
327. S. Baloniak and A. Mroczkiewicz, *Ann. Pharm. (Poznan)*, 12 (1977) 65.
328. A. Mroczkiewicz, *Acta Pol. Pharm.*, 38 (1981) 187.
329. M. Dorneanu, E. Carp, E. Stefanescu and G. Grosu, *Rev. Med.-Chir.*, 88 (1984) 712.
330. M. Ungureanu, M. Dorneanu, E. Stefanescu, M. Pavelescu, C. Radu and M. Petrovanu, *Rev. Med.-Chir.*, 88 (1984) 709.

331. Y. Takahi and T. Shirojima, *Jpn. Kokai* 78 12, 879; *Chem. Abstr.*, 89 (1978) 43470.
332. Sankyo Co., Ltd., *Jpn. Kokai Tokkyo Koho JP* 82 75, 974; *Chem. Abstr.*, 97 (1982) 163004.
333. Y. Cui, C. Lin and G. Tian, *Gaodeng Xuexiao Huaxue Xuebao*, 7 (1986) 417; *Chem. Abstr.*, 107 (1987) 58959.
334. A.V. Dogot, P.M. Steblyuk, T.V. Bari'nik and S.B. Kas'ko, *Farm. Zh.*, 3 (1986) 69; *Chem. Abstr.*, 105 (1986) 130583.
335. O.H. Hishmat, S.M. Atta, M.M. Atalla and A.H. Abdel Rahman, *Arzneim.-Forsch.*, 35 (1985) 784.
336. O.H. Hishmat, S.M. Atta, M.M. Atalla and A.H. Abdel Rahman, *Pharmazie*, 40 (1985) 460.
337. I. Nabih, A.A. Zayed, J. Metri, M.M. Kamel and M.S. Motawie, *Egypt. J. Chem.*, 29 (1986) 101.
338. R.H. Woerther, R. Jellinger, H.R. Bodingbauer and J. Graf, *Ger. Offen. DE* 3, 517, 617; *Chem. Abstr.*, 107 (1987) 19516.
339. G.B. Barlin and S.J. Ireland, *Aust. J. Chem.*, 38 (1985) 1685.
340. R.E. Bambury, D.T. Feeley, G.C. Lawton, J.M. Weaver and J. Wemple, *J. Chem. Soc., Chem. Commun.*, 7 (1984) 422.
341. R.E. Bambury, D.T. Feeley, G.C. Lawton, J.M. Weaver and J. Wemple, *J. Med. Chem.*, 27 (1984) 1613.
342. K. Irie, Y. Eda, H. Yamada, H. Tobiki, N. Tanno, K. Shimago, K. Okamura, T. Nakagome, T. Komatsu et al., *Ger. Offen.* 2, 605, 910; *Chem. Abstr.*, 85 (1976) 160076.
343. H. Yamada, H. Tobiki, N. Tanno, K. Kojima, K. Okamura, T. Nakagome, T. Komatsu, A. Izawa, H. Noguchi et al., *Jpn. Kokai* 77 151, 189; *Chem. Abstr.*, 88 (1978) 170139.
344. H. Yamada, H. Tobiki, N. Tanno, K. Shimako, K. Okamura, M. Nakagome and T. Komatsu, *Jpn. Kokai Tokkyo Koho* 77 87, 188; *Chem. Abstr.*, 88 (1978) 170137.
345. T. Noguchi, Y. Yamahira and T. Maeda, *Jpn. Kokai Tokkyo Koho* 77 156, 918; *Chem. Abstr.*, 88 (1978) 158485.
346. H. Yamada, K. Okamura, H. Tobiki, N. Tanno, K. Shimaji, T. Nakagome, T. Komatsu, A. Izawa, H. Noguchi et al., *Jpn. Kokai* 77 156, 893; *Chem. Abstr.*, 88 (1978) 190862.
347. T. Naito, J. Okumura and H. Kamachi, *U.S. Patent* 3, 910, 900; *Chem. Abstr.* 84 (1976) 44096.
348. T. Naito, J. Okumura and H. Kamachi, *Jpn. Kokai* 75 160, 292; *Chem. Abstr.*, 85 (1976) 94376.
349. M. Iwanami, M. Murakami, T. Maeda, M. Fujimoto, Y. Nagano, Y. Yoshikawa and A. Yamazaki, *Jpn. Kokai Tokkyo Koho* 77 83, 690; *Chem. Abstr.*, 87 (1977) 201562.
350. T. Naito and J. Okumura, *Swiss Patent* 595, 391; *Chem. Abstr.*, 88 (1978) 170174.
351. H. Yamada, K. Okamura, H. Tobiki, N. Tanno, K. Shimaji, T. Nakagome, T. Komatsu, A. Izawa, H. Noguchi et al., *Jpn. Kokai* 77 156, 894; *Chem. Abstr.*, 88 (1978) 190860.
352. Asahi Chem. Ind. Co., Ltd., *Jpn. Kokai Tokkyo Koho JP* 82 48, 986; *Chem. Abstr.*, 97 (1982) 55588.
353. Toyama Chem. Co., Ltd., *Jpn. Kokai Tokkyo Koho JP* 57 118, 588; *Chem. Abstr.*, 99 (1983) 5433.
354. J. Goto, K. Sakane, Y. Nakai, T. Teraji and T. Kamiya, *J. Antibiot.*, 37 (1984) 546.
355. J. Goto, K. Sakane and T. Teraji, *J. Antibiot.*, 37 (1984) 557.
356. H. Sadaki, H. Imaizumi, T. Nagai, K. Takeda, I. Myokan, T. Inaba, Y. Watanabe, Y. Fukuoka, S. Minami and I. Saikawa, *Ger. Offen. DE* 3, 341, 591; *Chem. Abstr.*, 102 (1985) 24353.

357. M. Murakami, M. Iwanami, I. Isaka, Y. Nagano, M. Fujimoto and T. Maeda, Ger. Offen. 2, 544, 243; Chem. Abstr., 85 (1976) 33053.
358. M. Ochiai, A. Morimoto, Y. Matsushita, O. Aki, T. Okada and K. Kawakita, Jpn. Kokai 77 83, 862; Chem. Abstr., 88 (1978) 62403.
359. M. Ochiai, O. Aki, A. Morimoto and T. Okada, Jpn. Kokai 74 72, 288; Chem. Abstr., 83 (1975) 147489.
360. M. Numata, I. Minamide, M. Yamaoka, M. Shiraishi and T. Miyawaki, Jpn. Kokai 76 11, 783; Chem. Abstr., 84 (1976) 180254.
361. B.E. Ayres, C.H. Oocallaghan, D.G. Livermore and C.E. Newall, Ger. Offen. 3, 006, 777; Chem. Abstr., 94 (1981) 84145.
362. T. Shibanuma, K. Nakano, N. Nagano, Y. Murakami and R. Hara, Eur. Pat. Appl. EP 112, 164; Chem. Abstr., 101 (1984) 170970.
363. Sankyo Co., Ltd., Jpn. Kokai Tokkyo Koho JP 60 67, 484; Chem. Abstr., 103 (1985) 141745.
364. M. Hashimoto, M. Aratani and K. Sawada, Eur. Pat. Appl. EP 90, 366; Chem. Abstr., 100 (1984) 120772.
365. H. Natsugari, Y. Matsushita, N. Tamura, K. Yoshioka, M. Kondo, K. Okonogi, M. Kuno and M. Ochiai, J. Antibiot., 36 (1983) 855.
366. N. Shimada, K. Morimoto, H. Naganawa, T. Takita, M. Hamada, K. Maeda, T. Takeuchi and H. Umezawa, J. Antibiot., 34 (1981) 1613.
367. T. Shiroza, N. Ebisawa, A. Kojima, K. Furihata, A. Shimazu, T. Endo, H. Seto and N. Otake, Agri. Biol. Chem., 46 (1982) 1885.
368. H. Maehr, C.M. Liu, N.J. Palleroni, J. Smallheer, L. Todaro, T.H. Williams and J.F. Blount, J. Antibiot., 39 (1986) 17.
369. G.E. Gymer and K. Richardson, Brit. UK Pat. Appl. 2, 025, 416; Chem. Abstr., 93 (1980) 114552.
370. G.E. Gymer and K. Richardson, Eur. Pat. Appl. 14, 562; Chem. Abstr., 94 (1981) 84150.
371. Nissan Chem. Ind., Ltd., Jpn. Kokai Tokkyo Koho JP 60 04, 173; Chem. Abstr., 102 (1985) 220887.
372. Nissan Chem. Ind., Ltd., Jpn. Kokai Tokkyo Koho JP 60 32, 774; Chem. Abstr., 103 (1985) 6357.
373. T. Ogura, Y. Kawamura, S. Ishii, M. Baba, M. Taniguchi, M. Hirose, K. Hirata and Y. Ochiai, Eur. Pat. Appl. EP 183, 212; Chem. Abstr., 105 (1986) 115084.
374. T. Ogura, Y. Kawamura, M. Baba, S. Ishii, K. Hirata, M. Kudo, Y. Ochiai and M. Hirose, Eur. Pat. Appl. EP 199, 281; Chem. Abstr., 106 (1987) 63043.
375. Y. Kawamura, S. Ishii, T. Ogura, Y. Nakajima, T. Makabe, M. Hirose, K. Hirata and Y. Ochiai, Jpn. Kokai Tokkyo Koho JP 62 16, 470; Chem. Abstr., 106 (1987) 176413.
376. Y. Nakajima, Y. Kawamura, T. Ogura, T. Makabe, K. Hirata, M. Kudo, Y. Ochiai and M. Hirose, Eur. Pat. Appl. EP 232, 825; Chem. Abstr., 108 (1988) 37854.
377. M. Takaya, Yakugaku Zasshi, 107 (1987) 819.
378. Ishihara Sangyo Kaisha, Ltd., Jpn. Kokai Tokkyo Koho JP 58 213, 776; Chem. Abstr., 100 (1984) 209853.
379. E.F. Rothgery and H.A. Schroeder, U.S. Patent 4, 263, 297; Chem. Abstr., 95 (1981) 62247.
380. M. Mutsukado, K. Tanikawa, K. Shikada and R. Sakoda, Eur. Pat. Appl. EP 193, 853; Chem. Abstr., 105 (1986) 208902.
381. M. Mutsukado, K. Tanikawa, K. Shikada and R. Sakoda, Eur. Pat. Appl. EP 186, 817; Chem. Abstr., 105 (1986) 226609.

382. M. Mutsukado, K. Tanikawa, K. Shikada and R. Sakoda, Eur. Pat. Appl. EP 201, 765; Chem. Abstr., 106 (1987) 143986.
383. M. Mutsuto, K. Tanikawa, K. Shikada and R. Sakoda, Jpn. Kokai Tokkyo Koho JP 61 260, 018; Chem. Abstr., 107 (1987) 77822.
384. A.D. Gribble and R.J. Ife, Eur. Pat. Appl. EP 194, 746; Chem. Abstr., 106 (1987) 18572.
385. J.B. Medwid, L.W. Torley and A.S. Tomcufcik, Eur. Pat. Appl. EP 226, 842; Chem. Abstr., 107 (1987) 236736.
386. K.G. Grozinger, R.J. Sorcek and J.T. Oliver, Eur. J. Med. Chem.-Chim. Ther., 20 (1985) 487.
387. K.G. Grozinger and J.T. Oliver, Eur. Pat. Appl. EP 137, 979; Chem. Abstr., 103 (1985) 123521.

This Page Intentionally Left Blank

2 Photodecomposition of Drugs

JOHN V. GREENHILL, Ph.D., B.Pharm.* and
MARGARET A. McLELLAND, Ph.D., B.Sc.

*Pharmaceutical Chemistry, School of Pharmacy, University of Bradford,
Bradford, BD7 1DP, U.K.*

INTRODUCTION	53
ALICYCLIC COMPOUNDS	56
Sodium nitroprusside	56
Chloroform and ether	56
DRUGS WITH CARBOCYCLIC RINGS	57
Vanillin	57
Benorylate	57
Phenylalanine	58
Tyrosine and levodopa	59
Ephedrine	59
Adrenaline, noradrenaline and isoprenaline	60
Phenylephrine	61
Diphenhydramine	61
Chloramphenicol	62
<i>p</i> -Aminobenzoic acid	63
Sulpha drugs	63
Hexachlorophene	65
Retinoic acid	65
Tetrachlorosalicylanilide	66
Thyroxine	66
Photocyclization in synthetic oestrogens	67
<i>Clomiphene</i>	67
<i>Stilboestrol</i>	68
<i>Dienoestrol</i>	68
<i>Tamoxifen</i>	69
Vitamin D group	69
Vitamin K group	70
Dithranol	74

* Present address: Department of Chemistry, University of Florida, Gainesville, FL 32611, U.S.A.

Naproxen	75
Protriptyline	76
Tetracyclines	76
Steroids	77
<i>Norethisterone</i>	77
<i>Ethinyllostradiol and oestrone</i>	78
<i>Prednisone</i>	78
<i>Prednisolone</i>	79
<i>Dexamethasone and betamethasone</i>	80
DRUGS WITH FIVE-MEMBERED HETEROCYCLIC RINGS	80
Frusemide	80
Nitrofurans	81
Nicotine	82
Thiamin	82
Pyrazolones	82
<i>Phenazone</i>	82
<i>Amidopyrine and sulpyrine</i>	84
Phenytoin	84
Metronidazole	85
Dacarbazine	85
Phenylbutazone	86
Amiodarone	87
Benzoxaprofen	88
Cocaine	89
Indapamide	89
Aminophylline	90
Mercaptopurine	90
Azathioprine	91
Psoralens	91
Physostigmine	92
Ergotamine and dihydroergotamine	92
Reserpine	93
DRUGS WITH SIX-MEMBERED HETEROCYCLIC RINGS	94
Nicotinic acid and nicotinamide	94
Isoniazid	94
Pyrithione	95
Methyprylone	95
Nifedipine	96
Pyridoxine and pyridoxal 5-phosphate	96
Barbiturates	97
<i>Barbitone</i>	97
<i>Methylphenobarbitone</i>	98
<i>Pentobarbitone</i>	98
<i>Quinalbarbitone</i>	98
<i>Proxibarbitone</i>	98
<i>Cyclobarbitone</i>	99

α -Tocopherol	99
Chloroquine and hydroxychloroquine	100
Cinchona alkaloids	100
Methaqualone	101
Hydrochlorothiazide	102
Nalidixic and oxolinic acids	102
Dipyridamole	103
Methotrexate and folic acid	103
Thioxanthine tranquilizers	104
Chlorpromazine and other phenothiazines	105
Emetine	107
Riboflavin	108
DRUGS WITH SEVEN-MEMBERED HETEROCYCLIC RINGS	109
Benzodiazepines	109
<i>Diazepam</i>	109
<i>Nitrazepam</i>	110
<i>Chlordiazepoxide</i>	111
<i>Analysis of benzodiazepines</i>	112
Doxepin and dothiepin	112
APPENDIX	113
REFERENCES	115

INTRODUCTION

The stability of pharmaceutical substances, both as pure compounds and as formulations, has long been a matter for concern. In the past, discoloration of material was often the only evidence of light-induced decomposition. Sensitive preparations were therefore kept in dark bottles to preserve their 'pharmaceutical elegance'. Modern chromatographic techniques now allow the separation of decomposition products and provide clear evidence of instability. In recent years, chromatographic isolation of pure derivatives followed by spectrometric analyses has also allowed the identification of some of the photodegradation products. This review concentrates on those drugs where one or more photo-derivatives have been positively identified. Also included are photosensitizers which, although unchanged themselves, photocatalyse degradations of biomolecules.

We searched the British Pharmacopoeias 1980 [1] and 1988 [2] for all drugs which carry a 'protection from light' warning and these were programmed into a C.A.S. on-line search which covered *Chemical Abstracts* from 1967 to the end of 1988 to form the basis for the review. (Little of this work was done before

the start of C.A.S. files in 1967.) This is not to say that the Pharmacopoeia is the perfect source for such information. A cursory glance in the 1988 edition revealed several drugs which did not carry a 'protection from light' warning although the available evidence suggests that such would be merited. Benorylate, chlorothiazide, cyclopentiazole, diazoxide, hydrochlorthiazide, polythiazide and tamoxifen citrate are the entries in question.

Precautions against photodegradation of drugs in storage are easily taken, but light-induced changes after the patient has taken the medicine may lead to serious side-effects – typically the erythema, oedema and vesicle formation of exaggerated sunburn. It is well established that sunlight penetrates the skin to a depth sufficient to reach blood circulating in surface capillaries [3, 4]. Two types of photosensitivity as a result of foreign chemicals circulating in the blood stream have been described, namely, phototoxicity and photoallergy [5,6]. In phototoxicity, the excited state of the drug molecule can induce cellular damage in at least one of three ways: by inducing radical formation in an endogenous molecule, by converting oxygen from its ground (triplet) to the highly toxic singlet state or, by electron transfer, it can generate the very reactive superoxide radical. Phototoxicity occurs only in areas of skin exposed to the light and is characterized by the relief of symptoms when the drug is withdrawn. It can be effective with only one dose in combination with exposure to the sun (or an ultraviolet lamp). It is reported that, with a high enough dose, the phototoxic response can be elicited from all exposed individuals [5]. Examples of drugs which can generate singlet oxygen are: chloroquine, frusemide, nalidixic acid and naproxen. Superoxide generators are chlorpromazine, mercaptopurine, some tetracyclines and the psoralens. Photoallergy occurs when the excited molecule itself or a degradation product reacts with DNA or a protein to produce an antigen which reacts immunologically with skin and other tissues. It usually requires several exposures before the response is produced and only a few patients are affected. Reactions can appear in areas not exposed to light and symptoms can continue for months or years after withdrawal of the drug. Examples of photoallergens are chlorpromazine, promethazine, bithional and sulphanilamide.

Recent work suggests that these ideas should be further refined. It may not be the drug which is subject to photodegradation, but one of its metabolites, for example, amiodarone, azathioprine, methaqualone. Phototoxicity may be caused by a photodegradation product circulating in the blood and causing organ damage by ionic rather than by radical reactions, for example, catechol amines, chlordiazepoxide and norethisterone. The possibility exists that the photodegradation products can be toxic or these may be thermally or photochemically unstable and react further to give toxic derivatives.

A few drugs depend for their therapeutic action upon light activation. Included in this review are dithranol, which has been suggested to exert its antipsoriatic action in this way, and the psoralens, which have long been used in combination with sunbathing to treat various skin conditions and now are also used against surface cancers.

The term photosensitizer can be ambiguous. In the reports of clinicians, it is used to describe any drug showing light-induced side-effects. To a photochemist, it means any molecule which is readily excited by light and induces reaction in an otherwise stable second molecule. Several drugs and biomolecules are photosensitizers in this sense. We have decided that the meaning of the term should be clear within the context in each case. As some biomolecules photosensitize drug decomposition, we have included examples where unnatural sensitizers such as rose bengal or methylene blue have been employed. These may alert investigators to possible phototoxicity or photoallergy.

The most energetic frequencies in sunlight are removed by atmospheric filtration. The light which penetrates to sea level has wavelengths above about 300 nm [6, 7]. The most important ranges are known as UVB (290–320 nm) and UVA (320–400 nm). In setting these boundaries we recognize that authorities differ somewhat in the definitions of UVA and UVB, even within a single symposium [8]. A lucid discussion on the basis for the two bands has recently been published [9]. Although artificial light has sometimes been implicated in photodegradation [6, 10], in studies of this kind it is clearly desirable to use a light source as close as possible in its frequency spectrum to that of sunlight. Medium-pressure mercury lamps, which provide a range of monochromatic emissions from 254 nm upwards, are often used together with suitable filters. Some investigators have used the 254 nm line of low-pressure mercury lamps. This is justified when it can be shown that the photo-reaction rate is increased without change in the product mixture. Without such a precaution, it is never certain whether the observations accurately reflect reactions of the drug in natural light. Diazepam, for example, appears to give extra photodegradation products when irradiated at 254 nm [10]. However, work done only with (high-energy) light of less than 300 nm is included here, since any photodegradation shows that precautions should be taken, at least until work has been reported with simulated sunlight. Other work reviewed here involved high-pressure mercury or xenon arc lamps, which give a continuum of frequencies, and various tungsten and fluorescent light sources. In an ideal world, all photochemists would work in warm, sun-drenched laboratories and do their experiments on the windowsill. It is not always clear in published material what wavelengths and intensity of light have been used, but as far as possible, we give this information for each example. The only photoreactions

of drugs not included are those where conditions were completely different from those which could be encountered naturally, for example, photochemical reactions used in steroid synthesis. The physical chemistry and methodology of photodegradation studies have recently been expertly reviewed [11, 12].

In considering the layout of this review, three methods of classification suggested themselves. The first would be to report examples under type of photoreaction, the second to group drugs under their therapeutic actions and the third to list photoactive compounds by molecular type. Initially we were inclined to use the first method, but we then realized that many drugs would appear in several different sections and the whole would be too cumbersome. We thought it useful, however, to append a table showing the types of photodegradation covered and the main examples of each reaction. The second approach has its attractions in a volume used by pharmacists and pharmacologists, but there is usually no relationship between the photochemistry of a molecule and its clinical use. We therefore decided that the only sensible arrangement would be the third – by molecular type.

After an initial inorganic example and two aliphatic compounds, drugs based on single carbocyclic rings are discussed, followed by di-, tri- and tetracyclic systems. Five-, six- and seven-membered heterocycles complete the review, with simple before more complex molecules within each section.

ALICYCLIC COMPOUNDS

SODIUM NITROPRUSSIDE

Sodium nitroprusside has long been known to degrade under the influence of fluorescent lighting or sunlight [13]. Initial reaction [14] follows the equation:



However, solutions exposed to the normal lighting conditions of hospital wards during intravenous infusion have been shown to contain prussian blue, nitric oxide and cyanide ions [15, 16].

CHLOROFORM AND ETHER

Both of these general anaesthetics have long been known to oxidize in the presence of air and sunlight. Chloroform was shown to photo-oxidize to a peroxide of uncertain structure which collapsed to the poison gas phosgene. Anaesthetic chloroform is protected by the addition of ethanol, which intercepts the initial free radical and prevents the photodegradation [17]. Diethyl ether

(1) photo-oxidizes rapidly to give the toxic and explosive hydroperoxide (2) [18, 19].

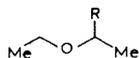

- (1) R = H
(2) R = OOH

DRUGS WITH CARBOCYCLIC RINGS

VANILLIN

Vanillin (4-hydroxy-3-methoxybenzaldehyde) in ethanolic solution – as supplied as a flavouring agent – was dimerized by sunlight or more rapidly under a mercury lamp to dehydrodivanillin (3). This is a typical *ortho*-phenol coupling reaction [20].

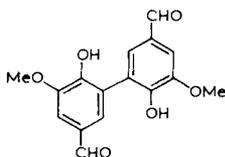

(3)

BENORYLATE

The antirheumatic, benorylate (4), photodegraded at wavelengths above 300 nm under glass, but more rapidly and with the same product distribution

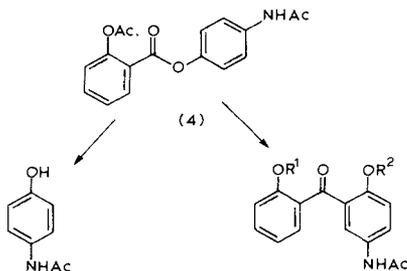

(5)

- (6) R¹ = Ac R² = H
(7) R¹ = H R² = Ac
(8) R¹ = R² = H

when a quartz filter was used to pass wavelengths down to 254 nm. The isolated products were consistent with homolysis of the aryl ester group to give paracetamol (5) and, via photo-Fries rearrangement, the ketone (6). The production of compound (7) was assumed to follow an intramolecular transesterification of (6). The diphenol (8) would arise by hydrolysis of either (6) or (7) or by transesterification with the methanol solvent [21].

PHENYLALANINE

Hasselmann and Laustriat irradiated aqueous solutions of phenylalanine (9) – the most photosensitive amino acid – with an intense narrow band of wavelengths centered at 257.5 nm. Positively identified degradation products were: tyrosine (10), 3,4-dihydroxyphenylalanine (DOPA, 11), aspartic acid, benzoic acid and 3-phenyllactic acid (12). There was also a melanic polymer. When the experiment was repeated in the presence of oxygen, the concentrations of tyrosine, DOPA and the polymer were increased, but those of the other products remained the same. Additionally, there were minor amounts of the *ortho* and *meta* isomers of tyrosine. Under nitrogen, phenylethylamine was a minor product [22]. Brief irradiations with or without oxygen using low-intensity light at 254 nm gave mixtures from which alanine and glycine were identified [23].

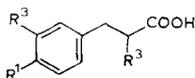

- (9) R¹ = R² = H R³ = NH₂
 (10) R¹ = OH R² = H R³ = NH₂
 (11) R¹ = R² = OH R³ = NH₂
 (12) R¹ = R² = H R³ = OH
 (13) R¹ = R³ = OH R² = H
 (14) R¹ = H R² = OH R³ = NH₂
 (15) R¹ = R² = R³ = OH

Experiments by Kenyon and Blois, with samples of phenylalanine labelled with ¹⁴C at each of the three aliphatic carbon positions, showed that the molecule could photolyse at each of the three exocyclic carbon-carbon bonds. Decarboxylation was also thought to be an important process, but unfortunately no resulting phenylethylamine was detected during this work. Mechanisms for the production of the observed products were suggested [24].

When a sample of phenylalanine carrying a ¹⁴C label in the benzene ring was photolysed at 254 nm, it gave radioactive 2-allylglycine (2-aminopent-4-enoic acid, 16). This showed that the irradiation had disrupted the aromatic ring [23].

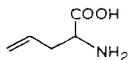

(16)

TYROSINE AND LEVODOPA

Tyrosine (10) irradiated by Hasselmann and Laustriat for 72 h in water at 254 nm in the presence of air gave dihydroxyphenylalanine (DOPA, 11) in 12% yield plus 4-hydroxyphenyllactic acid (13). The anti-Parkinsonism drug levodopa (laevo-11), under the same conditions, gave tyrosine (10), 4-hydroxyphenyllactic acid (13), *meta*-tyrosine (14) and 3,4-dihydroxyphenyllactic acid (15). Under nitrogen, only the DOPA dehydroxylation occurred. It was pointed out that these were all minor products; the bulk of the material polymerized under the forceful conditions used [21]. Dearden and Elrick used high-intensity broad band irradiation which converted L-tyrosine into levopoda. Levopoda in 0.1 M hydrochloric acid or 0.1 M sodium hydroxide was similarly photolysed to give trace amounts (detected by TLC) of aspartic acid, glycine and dopamine. The main products, however, were thought to be soluble melanin-like pigments formed from levopoda via quinone intermediates. Reactions were faster in alkali except when the phenolic hydroxy groups were methylated. This was taken as evidence for the intermediacy of quinones [25]. Finally, in the photo-oxidation of DOPA in water, Reszka and Sealy showed that both free-radical and singlet oxygen mechanisms were important [26].

EPHEDRINE

Ephedrine (17) was known to give coloured products on exposure to sunlight. When a 1% solution was irradiated with UV light from a 30 W tube the solution became coloured and colourless needle-shaped crystals separated. With prolonged exposure, the crystals redissolved as the solution darkened to an intense brown. On analysis, the crystalline compound was identified as the oxazolidine (18). This compound was known to be formed by reaction between ephedrine and benzaldehyde, so it was assumed that the primary photodegradation product of the drug was benzaldehyde [27].

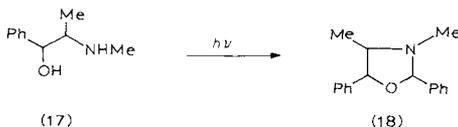

(17)

(18)

ADRENALINE, NORADRENALINE AND ISOPRENALINE

Adrenaline (19) as the hydrogen tartarate gave an aqueous solution of *ca.* pH 5. Irradiation for 30 min at 254 nm by de Mol *et al.* gave adrenochrome (22). On longer photolysis the characteristic UV absorption of an aminochrome decreased. When a fresh adrenochrome solution was irradiated, it gave a product with the chromatographic and spectral behaviour of 5,6-dihydroxy-*N*-methylindole (25). Isoprenaline (20) hydrochloride similarly gave (23), a pure sample of which was converted to (26). The dihydroxyindoles were photochemically too unstable to be detected in irradiated solutions of the catecholamines. Finally, an aqueous solution of (25) was photolysed under the same conditions to give spectral changes consistent with melanine formation. Thus, the photodegradations gave similar products to thermal degradations of the free bases except that in the irradiated solutions, no 3,5,6-trihydroxyindoles could be positively identified [28].

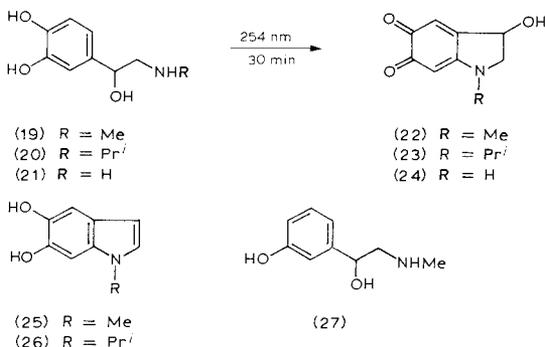

In further experiments by de Mol *et al.* on dilute solutions of catecholamine salts, adrenaline and isoprenaline gave the aminochromes in 65% and 56% yields, respectively. However, noradrenaline (21) gave the corresponding noradrenochrome (24) in only 35% yield. It was suggested that the phototoxicity associated with the medicinal use of catecholamines such as isoprenaline and levodopa may be caused by these adrenochromes [29]. Kruk [30] and Jahnke and Frenkel [31] considered that both singlet oxygen and superoxide were involved in the photo-oxidation. Singlet oxygen was important below pH 6.5, but superoxide became progressively more important as the alkalinity was increased [31].

Broad-band irradiation from a xenon arc lamp by Felix and Sealy produced semiquinone radicals from catecholamines. They were detected by ESR spectra of their metal complexes. Semiquinones gave rise to *o*-quinones and

superoxide; both species are toxic. Although no radicals were seen with light wavelengths greater than 300 nm, it was pointed out that they are readily generated by visible light in combination with low concentrations of photosensitizers and this may be of biological relevance [32]. A Japanese group also detected semiquinones after irradiation of adrenaline, noradrenaline, DOPA or dopamine with a high-pressure mercury lamp in neutral aqueous buffer [33].

PHENYLEPHRINE

Phenylephrine (27) is a low-potency sympathomimetic amine used as a decongestant. Solutions become coloured due to an auto-oxidation accelerated by light. In a series of experiments, aqueous solutions of the hydrochloride were left under a UV lamp until a tan colour developed. HPLC analysis showed four main products of which one was identified as adrenaline (19). Even after prolonged irradiation, there was never more than 2% adrenaline in the solution. It was assumed that the catecholamine was removed as it formed by further reaction to adrenochrome and melanine, which accounted for the colour [34].

DIPHENHYDRAMINE

Irradiation of an aqueous solution of diphenhydramine base (28) at 254 nm for 1.5 h produced a mixture from which no less than eleven products were isolated

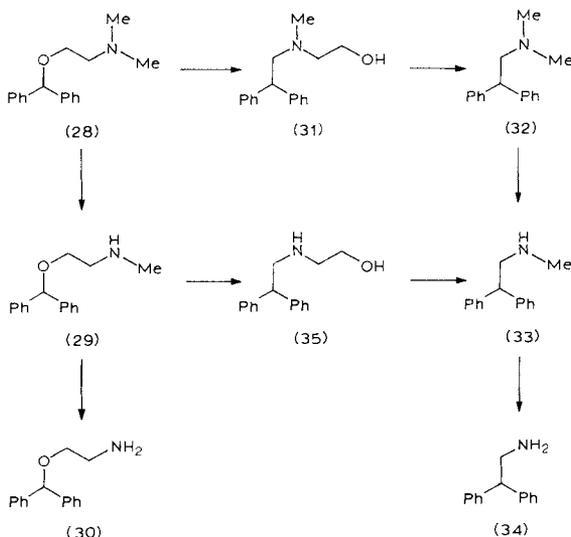

Scheme 2.1

[35]. These were the eight compounds of *Scheme 2.1* plus diphenylmethane, diphenylmethanol and benzophenone. Progressive *N*-demethylations of the antihistaminic drug (28) gave the secondary (29) and primary (30) amines. An intramolecular rearrangement gave the aminoethanol (31) which lost formaldehyde to give (32). This new tertiary amine also showed progressive *N*-demethylations to give (33) and (34). Intramolecular rearrangement of (29) gave the aminoalcohol (35). When a pure sample of (29) was irradiated, it gave (33), (34) and (35). As with diphenhydramine itself, irradiation of (29) or (30) gave diphenylmethane, diphenylmethanol and benzophenone. Of greater significance, no rearranged product similar to (35) was obtained from (30) – evidence for the intramolecular nature of the above rearrangements. Finally, a solution of diphenhydramine hydrochloride was subject to photodegradation. The same products were obtained, but 24 h irradiation was needed to achieve about the same degree of decomposition. Presumably only the small proportion of unprotonated molecules in solution reacted [35].

CHLORAMPHENICOL

Aqueous solutions of chloramphenicol (36) have given several photolysis products on exposure to sunlight, tungsten light or UV [36, 37]. The molecule showed homolytic fission at the position marked to give an aromatic and an aliphatic radical. The former became 4-nitrobenzaldehyde and the latter broke down further to glycol aldehyde and dichloroacetamide [37]. Secondary reaction products included 4,4'-azoxybenzoic acid (37), 4-aminobenzaldehyde, 4-aminobenzoic acid and 4-nitrosobenzoic acid (38). In addition, the reaction mixture contained hydrochloric acid and 1-(4-aminophenyl)-2-acetamidopropane-1,3-diol (39) formed by photoreduction. The discovery of the nitroso compound (38) is most important, since it is likely to be the cause of the aplastic

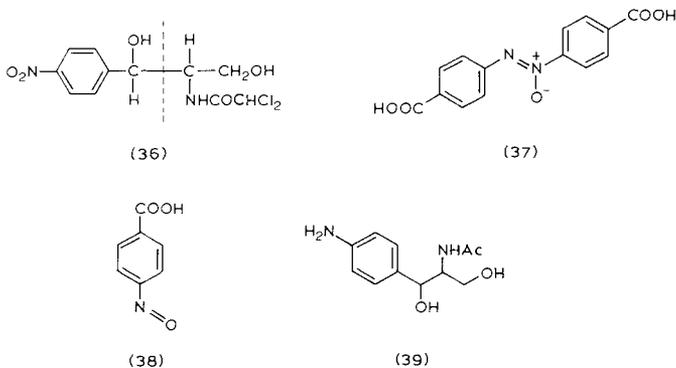

anaemia associated with the use of this drug, a side-effect which has even been observed following its use in eyedrops [38]. Photolysis of 4-nitrobenzaldehyde in water gave 4-nitrosobenzoic acid in 92% yield [36]. Under *in vitro* conditions, up to 45% of chloramphenicol in eyedrops was converted to 4-nitrosobenzoic acid [38]. The mechanisms of these reactions have been carefully investigated [37, 39].

p-AMINO BENZOIC ACID

The ability of *p*-aminobenzoic acid to absorb ultraviolet light has led to its widespread use as a sunscreen. This allows users much longer periods of sunbathing which could aggravate any photosensitizing effects it may have. The compound has been shown to sensitize the killing of *E. coli* by 313 nm light and also to increase the mutagenic activity of light of this wavelength [40].

J.C. Sutherland and Griffin incorporated tritium-labelled thymine into DNA and irradiated it with 313 nm light in buffered saline in the presence of *p*-aminobenzoic acid for up to 12 min. After separation of the products by TLC, the radioactivity was associated with a fraction which had the characteristic R_F of dimers. When the hydrolysate from a 313 nm irradiated sample was re-irradiated at 254 nm and then chromatographed, the radioactivity had the mobility of thymine monomer. This is characteristic of pyrimidine cyclobutyl dimers which were known to be photosynthesized at 313 nm and photodegraded to monomers at 254 nm. Although not degraded itself, the *p*-aminobenzoic acid clearly acted as a photosensitizer for the DNA-damaging thymine dimerization [40].

B.M. Sutherland used *in vitro* experiments with human neonatal foreskin fibroblasts in buffer solution to show that DNA-pyrimidine dimer formation under a sunlamp was sensitized by *p*-aminobenzoic acid. Cells illuminated in the presence of the acid had a 10-fold higher frequency of transformation to anchorage-independant growth than cells irradiated in buffer alone [41].

Chignell *et al.* intensely irradiated *p*-aminobenzoic acid with a xenon arc lamp and showed the formation of several free radicals detected by spin traps in conjunction with ESR spectroscopy. It was suggested that such radicals could cause lipid peroxidation or react via one of the excited forms of oxygen [42, 43].

SULPHA DRUGS

Reisch and Niemeyer photolysed sulphanilamide (40) in ethanol and obtained the nitro derivative (41), carbamate (42), azobenzene (43) and 2-methylqui-

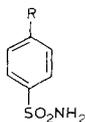

- (40) R = NH₂
 (41) R = NO₂
 (42) R = NHCOOEt

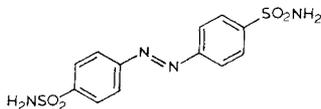

(43)

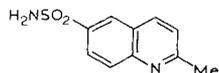

(44)

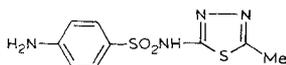

(45)

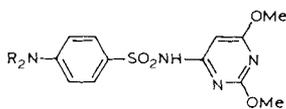

- (46) R = H
 (47) R = Me

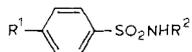

- | R ¹ | R ² |
|----------------------|-----------------------|
| (48) NH ₂ | 2-thiazolyl |
| (49) NH ₂ | 2-pyridyl |
| (50) NH ₂ | C(=NH)NH ₂ |
| (51) NH ₂ | CONHBu |
| (52) Me | CONHBu |
| (53) Cl | CONHPr |

noline-6-sulphonamide (44) [44]. Chiang *et al.* irradiated sulphamethizole (45) in methanol with a high-pressure mercury lamp for 1 h to give a 10.5% yield of 2-amino-5-methyl-1,3,4-thiadiazole. Under the same conditions sulphadimethoxine (46) was methylated to the tertiary amine (47) [45]. Golpashin, Weiss and Durr recently studied the photolyses of several sulphonamides at 254 nm in methanol. Sulphathiazole (48), sulphapyridine (49), sulphaguanidine (50) and carbutamide (51) all gave aniline as one of the products. Yields were 23.3, 29.1, 95.1 and 23.5%, respectively. Likewise, tolbutamide (52) gave toluene (29.6%), and chlorpropamide (53) gave chlorobenzene (32.8%). Most also gave the appropriate heterocyclic amine or urea. Sulphathiazole gave 2-aminothiazole (trace), sulphapyridine gave 2-aminopyridine (15.6%), tolbutamide and carbutamide gave butylurea (25.7, 27.3%, respectively) and chlorpropamide gave propylurea (21.8%). Sulphapyridine and sulphaguanidine also gave small amounts of sulphanilamide (40) and 4-aminobenzenesulphonic acid [46].

Sulphanilamide, sulphacetamide, sulphadiazine, carbutamide and tolbutamide have all been shown by Motton and Chignell to produce radicals by homolysis. Light wavelengths above 300 nm were used and the radicals were detected by ESR spectra in the presence of spin traps. It was suggested that the radicals are the cause of the cutaneous photosensitization associated with these drugs. The products of the radical reactions were not isolated [47]. Intense irradiation from a xenon arc lamp gave a series of radicals from sulphanilamide, detected by the same technique. Such radicals, if formed under natural conditions, could cause lipid peroxidation or react via singlet oxygen

or superoxide to produce phototoxicity. The observed photoallergy would be caused by reaction with a cellular protein or other macromolecule to give an antigen [42, 47].

HEXACHLOROPHENE

Hexachlorophene (2,2'-dihydroxy-3,3',5,5',6,6'-hexachlorodiphenylmethane, 54) gave similar mixtures of photodechlorinated products when irradiated through a corex filter ($\lambda > 255$ nm) or a pyrex filter ($\lambda > 290$ nm), but the reaction was slower at the higher wavelengths. The initial pentachloro compounds resulted from loss of chlorine from either C-3 or C-5. Further irradiation of the 2,2'-dihydroxy-3,5,5',6,6'-pentachlorodiphenylmethane gave several products, including 2,2'-dihydroxy-5,5',6,6'-tetrachlorodiphenylmethane and 2,2'-dihydroxy-3,5',6,6'-tetrachlorodiphenylmethane. The latter was also obtained on further irradiation of the 2,2'-dihydroxy-3,3',5,6,6'-pentachlorodiphenylmethane, along with 2,2'-dihydroxy-3,3',6,6'-tetrachlorodiphenylmethane and several minor unidentified products. Unfortunately, these results are for ethanolic solutions degassed with argon. It was noted that hexachlorophene exposed to moisture, sunlight and oxygen when used as a skin bacteriostat may be subject to a more complex photodegradation [48].

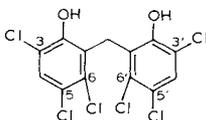

(54)

RETINOIC ACID

The vitamin A metabolite all-*trans*-retinoic acid (55) has important biological functions in epithelial cell differentiation and is useful in the treatment of skin disorders. On irradiation with long-wavelength UV light (emission max. 366 nm) of alcoholic or aqueous-alcoholic solutions, several photoisomerizations were observed. The products were analysed using HPLC and structures were assigned after careful high-field NMR experiments, including the use of

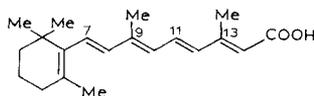

(55)

nuclear Overhauser effects and proton-carbon correlations. The following isomers, listed in increasing concentrations, were found in the photostationary product: 9,11,13-*tricis*, 9-*cis*, 9,13-*dicis*, 11-*cis*, unchanged (55), 11,13-*dicis* and 13-*cis* [49].

TETRACHLOROSALICYLANILIDE

3,3',4',5-Tetrachlorosalicylanilide (TCSA, 56) has been employed as a bacteriostat in soap. It produced a photosensitivity in some users which persisted for months or even years after all contact with the compound ceased. Irradiation at physiological pH with monochromatic light of 365 nm caused first homolysis of the C-Cl bond at position 3, but within 1 h, 3 molar equivalents of chloride had been released. Hydrochloric acid was produced from reaction of the chloride radicals with the solvent. Work with unbuffered solutions showed that only the anion was photolysed because a falling pH as acid accumulated stopped the reaction. The aryl free radical from the first reaction was shown to combine readily with γ -globulin and protein. It was suggested that this bound form was responsible for the long-term photosensitivity, since it presumably was capable of acting as a photosensitizer [50]. The various dechlorination products did not cause photoallergy and a mixture of TCSA and human serum albumin formed only a covalent bond upon irradiation [5].

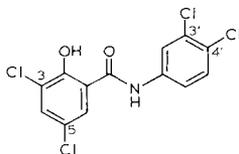

(56)

THYROXINE

Thyroxine (57) was rapidly photodeiodinated by light filtered to give wavelengths above 300 nm. In the first few minutes the main product was 3,3',5-triiodothyronine, but by 15 min, 3,5-diiodothyronine and 3-iodothyronine were present in major amounts. There were also traces of 3,3',5-triiodothyronine and 3,3'-diiodothyronine. In some runs traces of 3,3',5'-triiodothyronine and 3',5'-diiodothyronine were detected. Over 30 min the main product was 3-iodothyronine. Further deiodination to thyronine was very slow, presumably because the UV spectra had lower-wavelength maxima as iodine was removed. Similar photolysis of 3,3',5-triiodothyronine for 10 min also gave 3,5-diiodo-

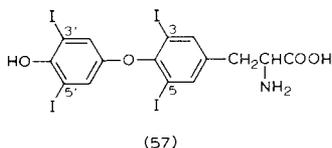

thyronine with traces of 3,3'-diiodothyronine and 3-iodothyronine. Photolysis of other tri- and diiodothyronines gave similar results, indicating that loss of iodine was progressive.

When thyroxine (57) was irradiated through a Corning filter which cut out wavelengths below 340 nm, photolysis was slower and it was possible to isolate reasonable yields of 3,3',5-triiodothyronine. This was resistant to further loss of iodine, but 3,5-diiodothyronine slowly accumulated on prolonged exposure [51].

PHOTOCYCLIZATION IN SYNTHETIC OESTROGENS

Clomiphene

Clomiphene citrate is used as a mixture of *E* (58) and *Z* (60) isomers to treat infertility. Photolysis of a chloroform solution with a high-pressure mercury lamp gave the expected phenanthrenes (59) and (61), which were separated and identified by GC-MS. Study of the separate isomers (58) and (60) indicated that rapid *cis-trans* photoisomerization preceded ring closure so that each gave a mixture of phenanthrenes (60) and (61) (*Scheme 2.2*) [52].

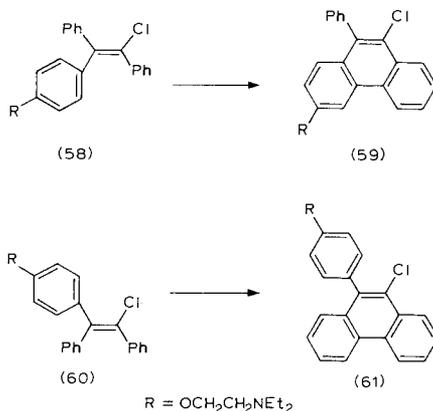

Scheme 2.2

Stilboestrol

When stilboestrol (diethylstilbestrol, 62) was photolysed in aqueous methanol at 254 nm it gave the stable 4a,4b-dihydrophenanthrene dione (63). The mechanism required a photo *trans-cis* isomerization, photocyclization and spontaneous *enol-keto* tautomerism [53, 54]. Previous workers had carried out a similar irradiation in dilute acetic acid and obtained the expected aromatic product (64) [55].

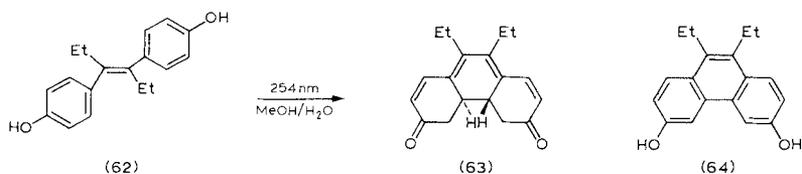
*Dienoestrol*

The conjugated diene dienoestrol (65) was irradiated at 254 nm in 90% aqueous methanol. Rotation and *cis-trans* photoisomerization gave (66) which underwent a photochemical [1, 5]sigmatropic rearrangement to give (67). Photocyclization followed by *enol-keto* tautomerism then gave the isolated dihydrophenanthrene dione (68) [56].

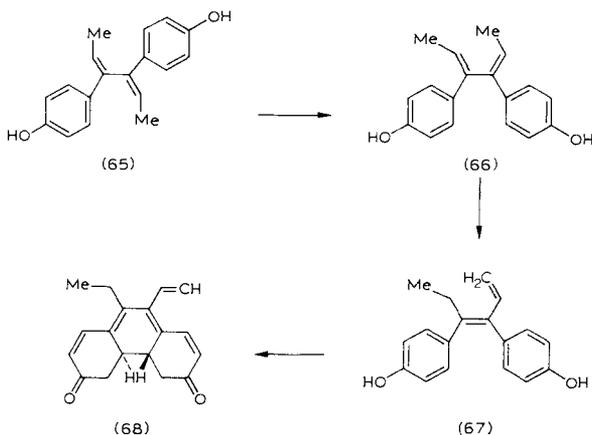

Tamoxifen

The ability to cyclize to a phenanthrene has been employed in analytical procedures for tamoxifen (69). The drug was irradiated at 254 nm in dioxane-heptane solution and the assay based on the fluorescence of the product (70) [57]. Another group ran the tamoxifen on a TLC plate which was exposed to a UV lamp for some minutes before assaying in a densitometer [58].

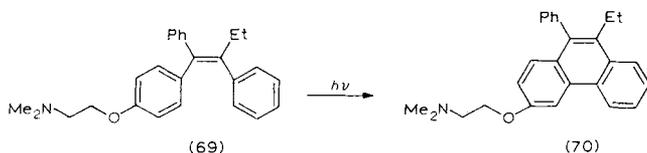

VITAMIN D GROUP

An X-ray crystal structure determination of calciferol (vitamin D-2, 71) showed that steric crowding in the *s-cis* diene system resulted in a twisted conformation with a dihedral angle of 53° [59]. On irradiation with a mercury lamp, it was partially converted into ergosterol (72) and tachysterol (73) [60, 61]. When a solution of calciferol in light petroleum containing a trace of iodine was exposed to diffuse daylight, the vitamin was photoisomerized to (74) [62].

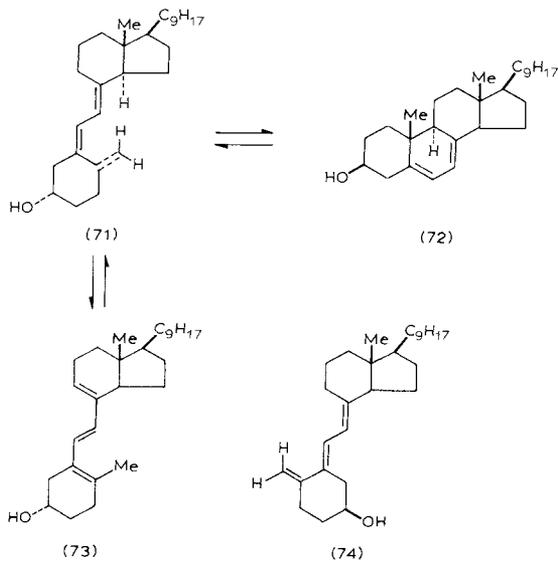

Cholecalciferol (vitamin D-3) differs from calciferol only in the alkyl side-chain, so it was assumed to be in the twisted conformation (75a). In alcoholic solution, vitamin D-3 was irradiated with a mercury arc lamp through a cupric sulphate solution filter to give wavelengths above 250 nm. Six products were isolated. Conformation (75a) could reasonably give rise to the assigned structures (76a), (77a) and (78a) (Scheme 2.3). Photoisomerization could give conformation (75b), which would explain the isolation of (76b), (77b) and (78b). The report is confident on four of the new compounds, but notes that the cyclobutene structures (78a) and (78b) are 'tentatively assigned' [63].

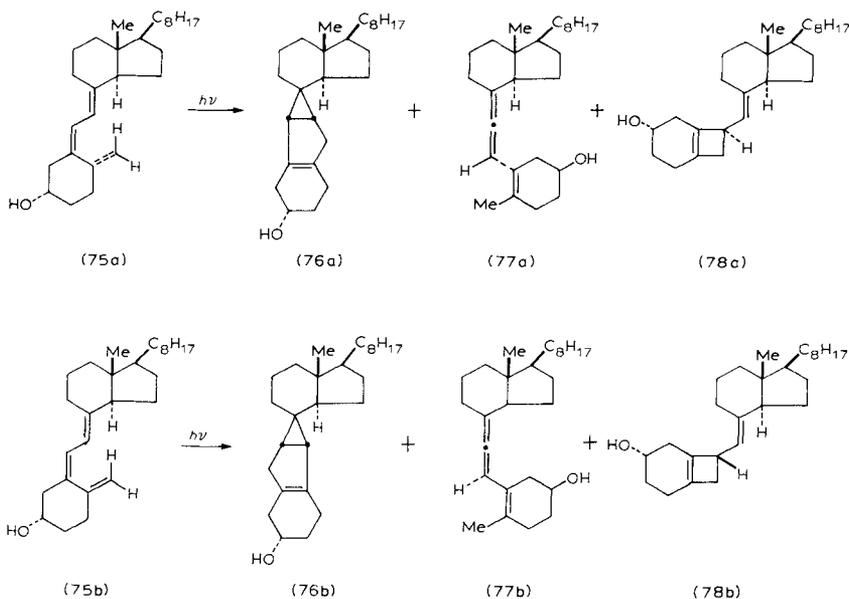

Scheme 2.3

VITAMIN K GROUP

Menadione (vitamin K-3, 79) in ethanol in the presence of oxygen was placed in the sun for 10 min to give the 2,3-epoxide (80) [64]. This has been photolysed in micellar solutions to give two main products; 2-hydroxy-3-methylnaphthoquinone and 2,3-dihydro-2-hydroxy-2-methylnaphthoquinone [65]. Solid menadione left on a south-facing windowsill (in Texas!) for a month gave two photodimers: the *syn* head-to-head and *syn* head-to-tail cyclobutanes. With UV

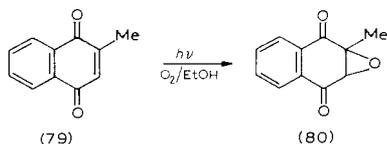

irradiation of an acetone solution, the two *anti* cyclobutane isomers were prepared [66].

Menaquinone-1 (81), the first of the vitamin K-2 group, was photolysed with light of 458 nm wavelength in fluorotrichloromethane solution at -30°C to give a mixture of the hydroperoxide (84) and the trioxane (86). The trioxane did not absorb at 458 nm, but at 334–364 nm it rapidly photodegraded to the aldehyde (87) and acetone (88) (Scheme 2.4). Compound (84) also gave acetone under 334–364 nm light, but (87) was not detected [67].

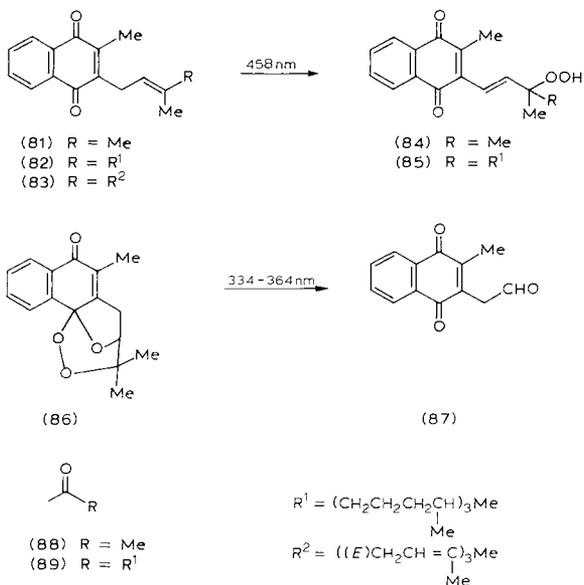

Scheme 2.4

Snyder and Rapoport photolysed phyloquinone (vitamin K-1, 82) in cyclohexane solution with the surface exposed to atmospheric oxygen and moisture. This system was adopted on the assumption that the *in vivo* photo-oxidation would occur with the hydrocarbon side-chain dissolved in a lipid layer, but the polar naphthoquinone moiety would be in contact with water. Under the

influence of monochromatic light of 360 nm, two products were obtained. There was a 10% yield of the hydroperoxide (85) and a 50% yield of the ketone (89). Isolation and anaerobic photolysis of the peroxide gave the same ketone in 91% yield [68].

Ohmae and Katsui irradiated vitamin K-1 (82) in alcoholic solution with UV light and obtained the hydroperoxide (85), its corresponding hydroxide and the ketone (89). Also isolated were phthiocol (90), the naphthofuran (91) and polymeric material [69]. Similar irradiation in benzene gave (89) and (91) [70].

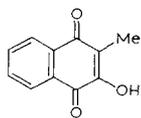

(90)

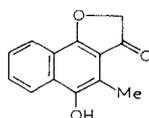

(91)

Irradiation of phyloquinone (82) in 85% methanol at 254 nm was reported by Vire *et al.* to give the 2,3-epoxide [71]. Under light of 458 nm wavelength in fluorotrchloromethane at -30°C (82) gave two trioxanes believed by Wilson *et al.* to differ in the configuration of the prenyl side-chains [67]. Yamano *et al.* reported photoisomerization of the side-chain 2,3-double bond of phyloquinone (82) and menaquinone-4 (83). In both cases pure *cis* or *trans* isomers were irradiated in benzene to give mixtures which favoured the *trans* forms [72]. The same two compounds in infusion solutions were irradiated at 350–500 nm to give the fused pyrans phyllochromenol (92) and menachromenol (93) [73, 74]. Phyllochromenol was also formed by exposure of solutions in ethanol, benzene or aqueous polysorbate 80 to fluorescent light [75].

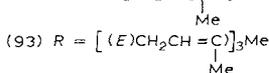
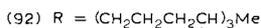
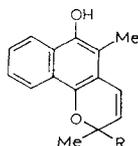

Menadione (79) has been shown by Krishna *et al.* to act as a photosensitizer for thymine degradation. Spin-trapping experiments with several nucleosides showed that the photosensitizations occurred by electron transfer from the substrate to the excited triplet state of menadione to form the cation radical of the substrate and the anion radical of menadione, both of which were detected

by ESR [76]. Fisher and Land used laser flash photolysis to show that thymine oxidation products were derived from charge transfer from the menadione triplet state to thymine to give the thymine cation radical [77].

Irradiation of oxygenated aqueous solutions of the vitamin and thymine (94) at 365 nm gave nine products. The six monomers were known compounds previously generated by gamma-ray or X-ray treatment of thymine. They were: the two enantiomeric hydroperoxides (95), the two derived hydroxides (96), the hydantoin (97) and the ring-opened compound (98). The remaining products were new dimers, provisionally assigned structures (99) and the two geometrical isomers (100) [78].

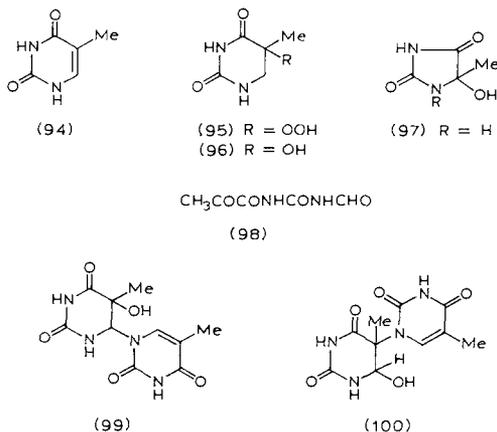

The nucleoside thymidine (101) (*Scheme 2.5*) similarly underwent menadione-sensitized photodegradation. Decarroz *et al.* irradiated an aerated aqueous solution of thymidine and 0.1 equivalent of menadione for 3 h. Nine products were separated. The four stereoisomers of the diol (105) were present, although it was pointed out that the two *trans* isomers undergo spontaneous isomerization to *cis* forms in solution through a ring-chain tautomerism. The aldehyde (102) and the alcohol (103) were identified, as were the two enantiomorphs of the imidazole (107) and the formamide (108) [79]. The same group have recently reported the irradiation of similar mixtures with a less intense light source emitting predominantly at 365 nm for a shorter period – 15 min. This time, the HPLC analysis showed the presence (by co-chromatography) of hydrogen peroxide, the four stereoisomers of the hydroperoxide (106) and the side-chain hydroperoxide (104). It was considered that the reduced menadione anion radical would be reoxidized by the oxygen to give superoxide which by dismutation would produce hydrogen peroxide. The thymidine cation radical

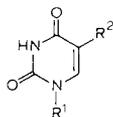

- (101) $R^2 = \text{Me}$
 (102) $R^2 = \text{CHO}$
 (103) $R^2 = \text{CH}_2\text{OH}$
 (104) $R^2 = \text{CH}_2\text{OOH}$

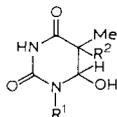

- (105) $R^2 = \text{OH}$
 (106) $R^2 = \text{OOH}$

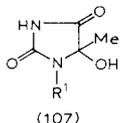

- $R^1\text{NHCHO}$
 (108)

$R^1 = 2\text{-deoxy-}\beta\text{-D-ribofuranosyl}$

Scheme 2.5

would react with water and oxygen to give the observed hydroperoxides [80].

The possibility of naphthoquinone-induced photodegradation of DNA has to be taken seriously [78].

DITHRANOL

The antipsoriatic compound dithranol (anthralin, 109) has recently been proved to be a photosensitizer. Irradiated in the presence of 2,3-dimethylbut-2-ene, it gave 2,3-dimethylbut-1-en-3-hydroperoxide, a typical singlet oxygen product. When the singlet oxygen quencher betacarotene was added, no hydroperoxide was formed. Methyl oleate was also shown to give products of singlet oxygen attack in the presence of dithranol. This led to the suggestion that the antipsoriatic activity was mediated through oxidation of polyunsaturated fatty acids which were known to be present in psoriatic skin in greatly increased concentrations compared with those in normal skin. The result of singlet oxygen production by dithranol is its own conversion to chrysazine (110), the bisanthrone (111) and the polymeric dithranol brown [81]. The stable tautomer of dithranol, in dichloromethane, for example, is form (109a). In weakly basic



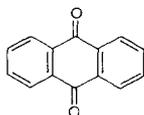

(110)



(111)

solution, however, it is changed into the anion of form (109b). It has been shown that a [4 + 2] cycloaddition of singlet oxygen to the anion leads to chrysazine [82].

NAPROXEN

This anti-inflammatory agent has been shown to be much less phototoxic than benzoxaprofen, although clinical responses have been observed and it photodecomposes in aqueous solution [83]. Neutral aqueous solutions of naproxen (112) were purged with oxygen and irradiated with light of 310–390 nm. The first reaction was a photodecarboxylation to give radical (113). This may have formed a peroxide with the oxygen. If so, it immediately changed to the alcohol (114). There was then a slow conversion to the ketone (115). Some ketone may have been formed by disproportionation of the peroxy intermediate, but it was demonstrated that alcohol (114) was photo-oxidized to ketone (115). When the reaction was repeated in deaerated solution, the initial radical (113) was postulated to abstract either H or OH from water to give as major product 2-ethyl-6-methoxynaphthalene and in slightly lesser amounts, the alcohol (114) [83].

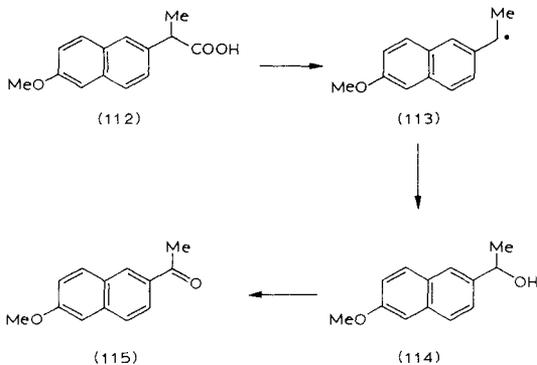

PROTRIPTYLINE

The antidepressant protriptyline (116) causes skin photosensitization in man. Jones and Sharples irradiated an aqueous solution of the hydrochloride with a medium-pressure mercury lamp for 16 h and separated the products by preparative TLC. First formed was the epoxide (117) which photohydrated to the diol (118). Also isolated was the enol (119) [84]. Earlier, Gasparro and Kochevar had shown that only the hydrochloride was photodegraded under nitrogen in water or ethanol. Three products were isolated and all lysed erythrocytes, but the structure of only one was suggested. This was a cyclobutyl dimer as shown by its mass spectrum and its photolysis back to protriptyline by light of 254 nm. Presumably, a [2 + 2] cycloaddition of the olefine bonds had occurred [85].

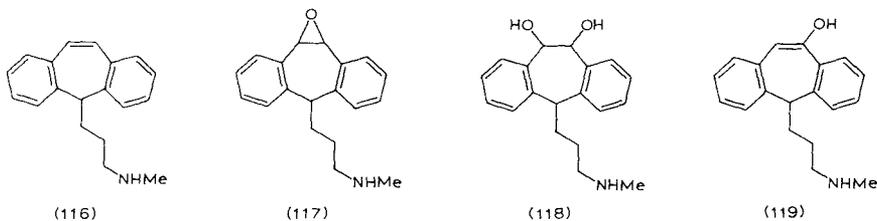

TETRACYCLINES

Tetracycline (120), doxycycline (121), demeclocycline (122) and oxytetracycline (123), although used in the treatment of acne, have been proved to be causes of skin phototoxicity [86, 87]. Irradiation of tetracycline (120) in the presence of oxygen at pH 9 with wavelengths above 290 nm caused homolysis of the C-N bond to give the radical (126). Oxidation with atmospheric oxygen was presumed to go via a peroxide anion (127) to the red quinone (128). The full mechanism was discussed by the original investigators [88] and further refined on the basis of a differential pulse polarographic study by a second group [89].

UV irradiation (335 nm) at pH 7.3 showed that some tetracyclines produced significant concentrations of the superoxide anion radical. Demeclocycline (122), oxytetracycline (123) and chlortetracycline (124) were the most active in this. These are all potent photosensitizers and probably give the observed exaggerated sunburn as a result of superoxide production in the skin [90]. Other photochemical experiments demonstrated the production of singlet oxygen. Yields obtained by luminescence measurements in alkaline ethanol were in the order (122) > (120) > (124) > (121) > (125). Chlortetracycline

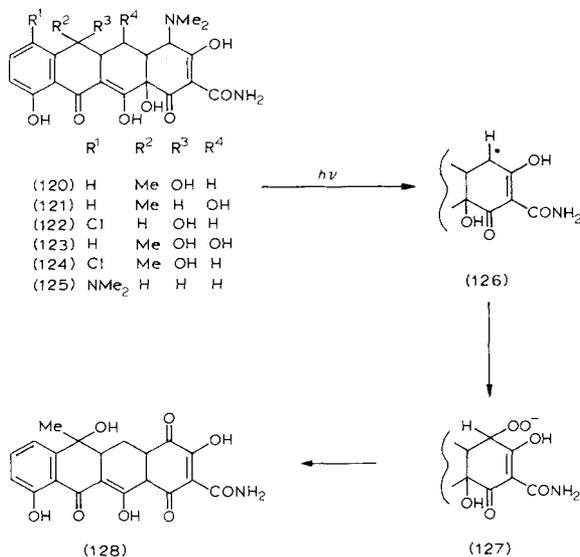

(124) was shown to give an aryl radical by photodechlorination when irradiated at 360 nm in aqueous buffer at pH 7.4. On the other hand, demeclocycline (122) did not. It was concluded that more than one mechanism is responsible for tetracycline photosensitivity [91]. Several tetracyclines photosensitized *in vitro* breakdown of bacteriophage DNA synthesis [86].

STEROIDS

Norethisterone

The oral contraceptive norethisterone (norethindrone, 129) has been shown to produce the 4 β ,5 β -epoxide (130) over a 30 min irradiation at 300 nm in aqueous buffer at pH 7.4. The possibility that this reactive species is responsible for the non-dermatological side-effects of oral contraceptives containing norethisterone was noted. One serious systemic effect of the drug which could be caused

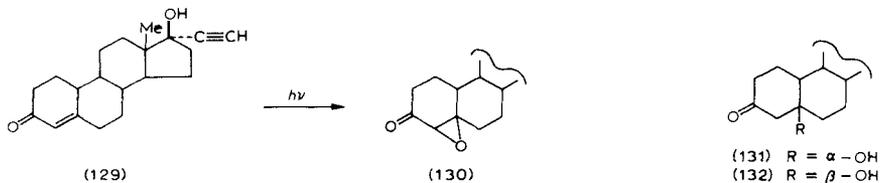

by the epoxide is the induction of liver cell tumours [92]. Further work has revealed that up to 16 photodecomposition products are produced in UVB light. Among the compounds firmly identified are the 4 α ,5 α -epoxide diastereoisomeric with (130) [93] and the epimeric alcohols (131) and (132), of which the former was in major amount [94].

Ethinylestradiol and oestrone

Ethinylestradiol (133), irradiated at 450 nm in a mixture of aqueous buffer (pH 7.4) and methanol 7:3 in the presence of oxygen and the photosensitizer hematoporphyrin, gave the peroxide (134), identified by its ready reduction with potassium iodide to the corresponding alcohol [95]. Oestrone (135) reacted similarly [96].

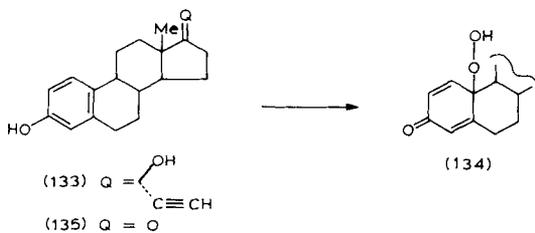

Prednisone

Prednisone (136) irradiated at 254 nm with a low-pressure mercury lamp in dioxane gave lumiprednisone (138). Further irradiation under the same condi-

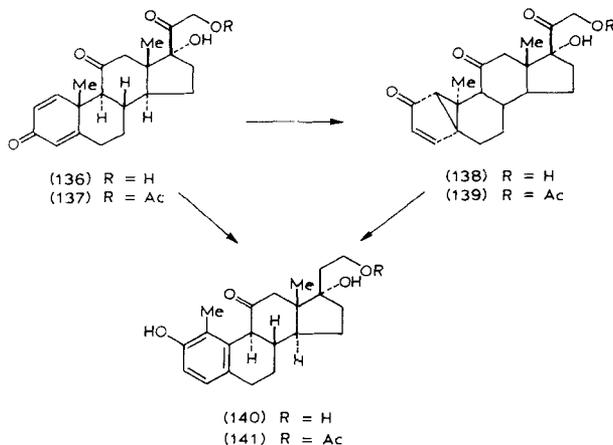

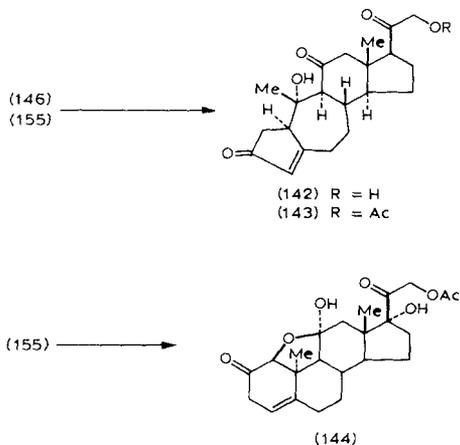

tions isomerized (138) to the phenol (140). Using a high-pressure lamp through a uranium filter, prednisone was converted directly to the phenol. Similar reactions were shown by prednisone acetate (137) which gave (139) and (141). However, in aqueous acetic acid, a high-pressure lamp converted (136) and (137) into the ring-A/B-rearranged products (142) and (143). Prednisone acetate (137) has also been photolysed in aqueous acetic acid to the ether-bridged derivative (144) [99, 100].

Prednisolone

Photolysis of prednisolone (145) or its 21-acetate (146) in dry dioxan at 254 nm gave lumiprednisolone (150) and its 21-acetate (151), respectively. Further irradiation of the lumiproductions in dioxan at 366 nm (21 h) or in ethanol with 313 and 366 nm light (45 min) gave the ether (155) or its acetate (156). Photolysis of (150) in 50% aqueous acetic acid with wavelengths above 300 nm

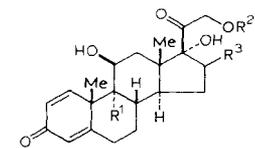

- (145) $R^1 = R^2 = R^3 = H$
 (146) $R^1 = R^3 = H, R^2 = Ac$
 (147) $R^1 = F, R^2 = H, R^3 = \alpha-Me$
 (148) $R^1 = F, R^2 = Ac, R^3 = \alpha-Me$
 (149) $R^1 = F, R^2 = H, R^3 = \beta-Me$

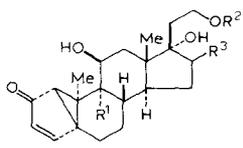

- (150) $R^1 = R^2 = R^3 = H$
 (151) $R^1 = R^3 = H, R^2 = Ac$
 (152) $R^1 = F, R^2 = H, R^3 = \alpha-Me$
 (153) $R^1 = F, R^2 = Ac, R^3 = \alpha-Me$
 (154) $R^1 = F, R^2 = H, R^3 = \beta-Me$

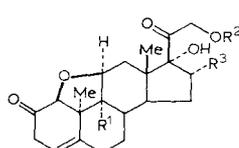

- (155) $R^1 = R^2 = R^3 = H$
 (156) $R^1 = R^3 = H, R^2 = Ac$
 (157) $R^1 = F, R^2 = Ac, R^3 = Me$
 (158) $R^1 = F, R^2 = H, R^3 = Me$

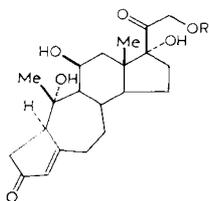

(159) R = H
(160) R = Ac

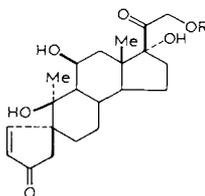

(161) R = H
(162) R = Ac

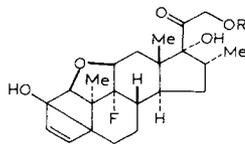

(163) R = Ac
(164) R = H

gave three products: the ether (155) – 64%, and the rearranged ring systems (159) – 20% and (161) – 16%. The 21-acetate derivative (148) similarly gave (156) – 50%, (160) – 20% and (162) – 19% [97, 98].

Dexamethasone and betamethasone

Dexamethasone (147) was photolysed in chloroform-methanol to the lumiprodukt (152) [98]. Irradiation of dexamethasone acetate (148) in methanol gave a mixture of (153), (157) and (163). The lumiprodukt (152) was shown to be an intermediate for (158) and (164) [101]. Betamethasone (149) was photolysed under similar conditions to give the lumiprodukt (154) [102]. Betamethasone-17-valerate has been shown to photodegrade in sunlight, although the products were not identified [103].

DRUGS WITH FIVE-MEMBERED HETEROCYCLIC RINGS

FRUSEMIDE

The widely used diuretic frusemide (165a) is a good photosensitizer *in vitro*. Its phototoxicity may arise from ready free-radical formation [104] or could be a consequence of the production of toxic photodegradation products [105]. In burette administration sets, frusemide was shown to be decomposed by direct sunlight, but not by diffuse daylight or fluorescent light [106].

UV irradiation of an alkaline solution of frusemide over 48 h gave 4-amino-5-carboxy-2-chlorobenzenesulphonic acid (166a) as the only identifiable product. There was a photo-oxidation of the sulphonamide group, but hydrolysis of the furylmethyl group could have been a result of the alkalinity of the medium [107]. Moore and Tamat questioned the identity of this product because they observed rapid photodechlorination of frusamide in water under nitrogen or oxygen [104]. Moore and Sithipitaks irradiated an oxygen-free methanol

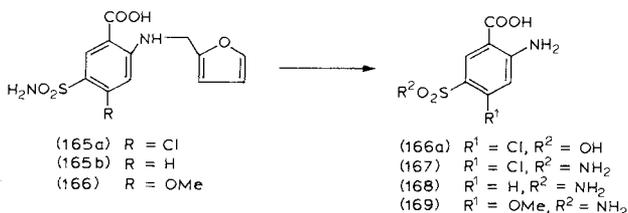

solution at 365 nm for 10 min after which a number of primary photoproducts could be identified. These were the photodechlorinated compound (165b) and the methoxy derivative (166), considered to be formed via reaction of the triplet state with solvent. Photohydrolysis also occurred to give (167), which degraded to (168) and (169). With irradiation times in excess of 20 min additional HPLC peaks were seen which were attributed to secondary photodegradation products [105]. Moore and Burt irradiated micellar solutions of frusemide at 365 nm and showed that the neutral form in nonionic surfactants was the most active in producing free radicals. Furthermore, the strength of the carboxyl function (pK_a 3.9) was reduced by about 2 pK units on incorporation into anionic surfactant micelles, so that a significant proportion under these conditions would be un-ionized at physiological pH [108].

NITROFURANS

When a solution of the topical antiseptic nitrofurazone (170) in water, methanol or tetrahydrofuran was left under a tungsten or fluorescent light, it tended to isomerize to the *syn* form (171). On standing in the dark, the *syn* form changed back to the *anti* form. The artificial light also caused photodegradation to the dihydrazone (172). Nitrofurantoin and furazolidone also showed evidence of *anti/syn* photoisomerism [109]. Under UV light, these and similar nitrofurans were degraded mainly to the corresponding aldehydes [110]. It was shown that *Euglena gracilis* cells were damaged by nitrofurans more rapidly in light than in the dark. 5-Nitrofurfural was separately shown to be toxic to *Euglena* [111].

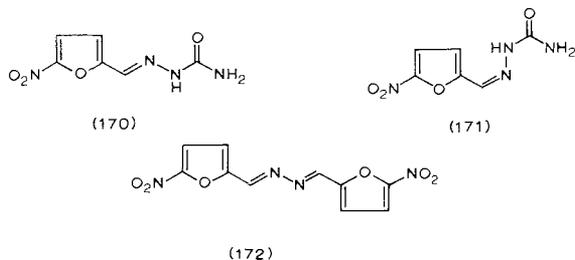

NICOTINE

Photolysis of nicotine (173) in the presence of oxygen and methylene blue with light wavelengths greater than 300 nm gave the pyrrolidone (174, 30%), nicotyrine (175, 23%) and *N*-oxide (176, 7%). Under nitrogen, with eosin as photosensitizer, only nicotyrine (14%) was identified in the photodegraded mixture [112].

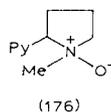
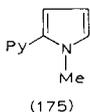
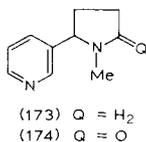

THIAMIN

Thiamin (vitamin B-1, 177) when photolysed, gives preparations having a characteristic odour. Photolysis of an aqueous solution with a high-pressure mercury lamp is reported to give the pyrimidine (178) [113]. Other work used irradiation at 254 nm and concentrated on the approximately 0.1% yield of ether-soluble odoriferous products. As many as nine compounds have been identified: (179), (180), (181), 2-methyl-3-formyl-4,5-dihydrofuran, 3-acetyl-4,5-dihydrofuran, 4-oxopentyl formate, 3-formyl-5-hydroxypentan-2-one, 3-mercapto-2-methyl-4,5-dihydrofuran and bis(4,5-dihydro-2-methylfuran-3-yl)disulphide [114, 115].

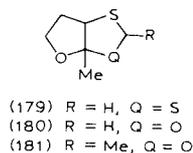
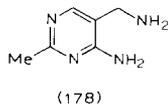
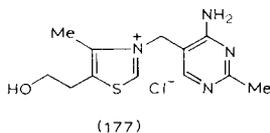

PYRAZOLONES

Phenazone

Phenazone (182) was shown to be more photostable than amidopyrine or sulpyrine [116]; however, several publications describe a number of photo-degradation products. After irradiation in methanol with a medium-pressure mercury lamp for 70 h, Ege isolated the carbamate (183, 20%), the imidazolone

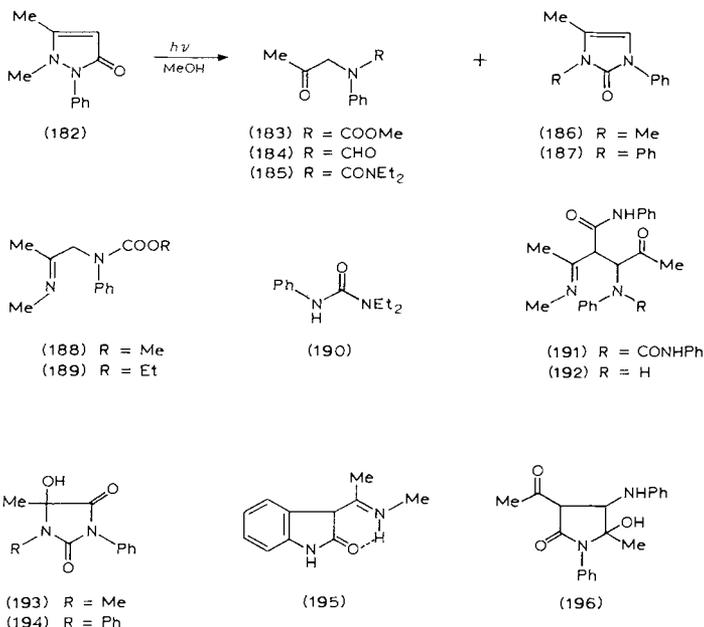

(186, 10%) and small amounts of methylphenylcarbamate, *N*¹-methyl-*N*²-phenyl oxamide and oxanilide. Reactions were similar in ethanol or benzene, but in acetone the major product was the formamide (184) [117]. Cardy and Poquet used a low-pressure lamp (254 nm) to photolyse methanolic or ethanolic solutions of phenazone and obtain the carbamates (188) and (189), respectively [118]. Anaerobic photodegradation of an aqueous solution containing diethylamine by Reisch and Ossenkop gave a mixture of (184) and the ureas (185) and (190) [119]. These authors went on to study the reaction in the presence of a photosensitizer (rose bengal or methylene blue). In alkaline solution with oxygen passing, compounds (187), (191), (193) and (194) were obtained [120]. With the light from the mercury lamp filtered through a potassium ferrichromate solution into a sodium hydroxide or diethylamine solution of phenazone under nitrogen, they obtained the rearranged indolone (195) [121]. In the absence of base, the photosensitized reaction appeared to give the imine (192) as the intermediate to a 20% yield of the pyrrolidinone (196) or its ring chain tautomer [122]. Marciniak examined this photolysis under nitrogen at 254 nm and commented on the importance of using dilute solutions. A number of products similar to those mentioned above were separated, but in concentrated solution, decomposition was quenched [123, 124].

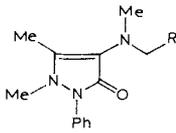

(197) R = H
(198) R = SO₃Na

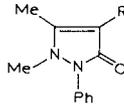

(199) R = NHCHO
(200) R = NMeCHO
(201) R = NH₂
(202) R = NHMe
(203) R = OH

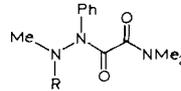

(204) R = H
(205) R = Ac

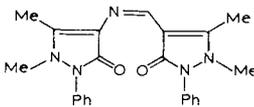

(206)

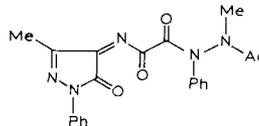

(207)

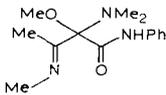

(208)

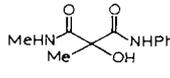

(209)

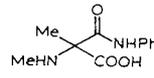

(210)

Amidopyrine and sulpyrine

These mild analgesic and antipyretic compounds are known to become coloured when kept in sunlight in the presence of atmospheric oxygen. The resulting mixtures are less active and more toxic than the pure drugs [125]. Among several products which were separated by Kovalenko *et al.* from photolysis (254 nm) of amidopyrine (197) in water, ethanol or chloroform solution were the formamides (199) and (200) as well as 4-aminoantipyrene (201). Sulpyrine (198) photolysed in water, ethanol or 0.1 M sodium hydroxide also gave (200) [116]. Other reports by Yankova and Yankov give, in addition to some of these, (202), (203), (204) and (205) [126], (206) and (207) [127]. From irradiation at 280 nm of a methanol solution of amidopyrine, Cardy and Poquet separated the methylcarbinolamine (208) which was assumed to hydrolyse and rearrange to give samples of the amides (209) and (210) [118].

PHENYTOIN

The anticonvulsant and antiepileptic phenytoin (211) has long been known to decompose in sunlight. It was photolysed in methanol with a high-pressure

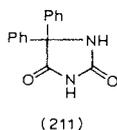

mercury lamp to give benzophenone (68%), benzil (4.8%) and a trace of benzoin. Mechanisms were suggested to explain the rearrangements [128].

METRONIDAZOLE

Two groups reported the photodegradation of this drug simultaneously. Unusually for photochemistry, both came to the same conclusion [129, 130]. Metronidazole (212) is an antibacterial agent and also sensitizes hypoxic cells to gamma irradiation. Solutions became yellow in daylight. An aqueous solution photorearranged under a medium-pressure mercury lamp to the oxadiazole (213) in 90% yield. The structure was proved by an X-ray crystallographic analysis of its *p*-nitrobenzoate [129]. Several similar antibacterial 1-alkyl-2-methyl-5-nitroimidazoles photorearranged to the oxadiazoles in wet dioxane [130].

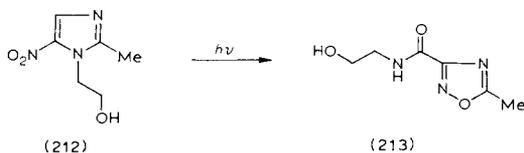

DACARBAZINE

The antitumour drug dacarbazine (DTIC, 214) turns pink in solution unless protected from light, and the coloured preparation causes pain at the site of injection. When the solution is carefully kept dark both during storage and administration, there is no trouble.

Dilute solutions in aqueous buffers exposed to diffused or direct sunlight gave dimethylamine and 5-diazoimidazole-4-carboxamide (215). At pH 1.0 or pH 7.4 and above, this cyclized to 2-azahypoxanthine (216). In the intermediate pH range, a different product was obtained (217) which happens to be the aglycone of the antibiotic bredinin. Compound (217) was not formed by irradiation of (216). It was suggested that the betaine arose from a carbene (218) which had been quenched by water. However, (217) is colourless. Formulated injection solutions which had been found to lose activity contained 10 mg/ml

PHOTODECOMPOSITION OF DRUGS

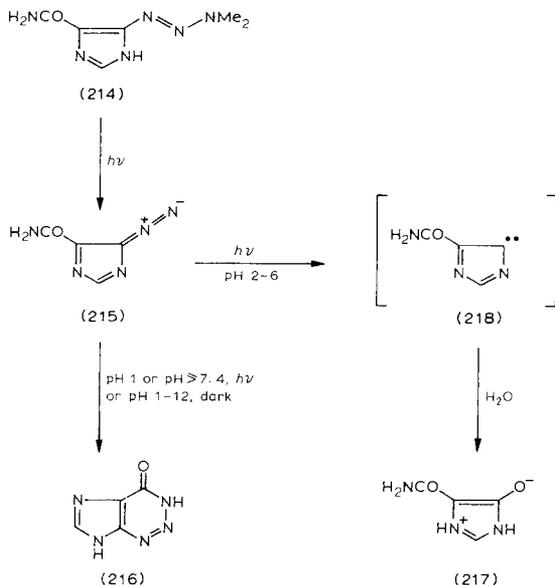

of the drug at pH 3 to 4. When solutions of this, higher, concentration were left on the windowsill, they gave a maroon precipitate with 20 to 25% decomposition over 10 h. This proved to be the diimidazole (219). The structure was established when it was prepared by reaction of (215) with (217) [131].

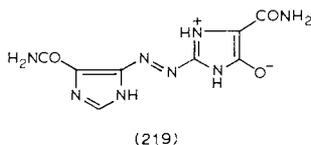

PHENYLBUTAZONE

Photolysis at 254 nm of phenylbutazone (220) in aqueous solution raised to pH 8 to 9 with sodium hydroxide gave a mixture of ring-opened products. Reisch *et al.* identified samples of aniline, the malonamides (221) and (222) and the 2-oxohexanamide (225). When the solution was basified with diethylamine, the amino diamide (223) was produced in addition to (222) and (225). In methanol solution the malonamides (221) and (224) were obtained [132]. In an older study by Pawelczyk and Wachowiak, a 20% solution (pH 10.5) of phenylbutazone sodium was kept in a clear glass bottle in diffused daylight for 2 years.

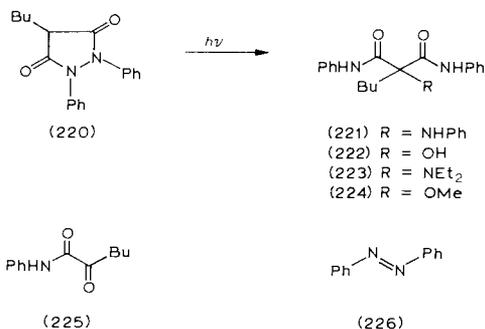

Among some hydrolysis products in the yellow-orange solution was found 4-hydroxyphenylbutazone, which may have resulted from radical attack. The colour was accounted for by a mixture of the *trans* (226) and *cis* forms of azobenzene [133].

Baugh and co-workers exposed solutions of phenylbutazone to the light of a projector lamp in the presence of typical dyes used to colour sugar-coated tablets. Erythrosine sodium photosensitized decomposition of the drug via, it was suggested, singlet oxygen [134].

AMIODARONE

Amiodarone (227) is a widely used antianginal and antiarrhythmic agent, but a dose-related photosensitivity is seen in many patients. Blue-green pigmentation in light exposed areas has been observed in a few cases [135, 136]. The photolyses of amiodarone and its major metabolite deethylamiodarone have been studied by Li and Chignell. Both compounds underwent photodeiodination. Spin trapping experiments suggested the formation of aryl radicals. Photoionization and superoxide formation were also detected. The aryl radical abstracted a hydrogen atom from several donors, including linoleic acid. It was suggested that this could lead to peroxy radical formation and so explain the deposition of lipofuscin – from lipid peroxidation – in the skin of sensitive patients [137]. Recently, Paillous and Verrier irradiated an anaerobic ethanol solution of amiodarone at 300 nm and isolated three products. The monodeha-

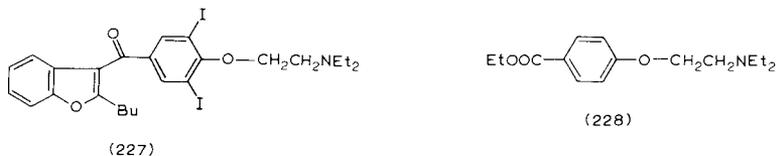

logenated derivative was seen first, followed by the didehalogenated derivative. Photodeiodination was quantitatively complete in about 10 h. Over a much longer period – up to 300 h – the resulting molecule was photochemically cleaved to the ester (228). The derivative from the benzofuran moiety was not isolated. The mechanisms of the photoreactions and the photosensitivity were discussed [136].

BENZOXAPROFEN

The anti-inflammatory agent benzoxaprofen (229) was withdrawn from clinical use in 1982 because of its photosensitizing effects [83]. Many patients experienced itching and urticaria, while some suffered onycholysis – separation of the finger nails from the nail beds [138]. In a trial, healthy volunteers were sensitive by the 4th day of treatment. UVA provoked itching and a burning sensation followed by development of a classical wheal and flare response within 2 to 4 min [139].

The only photodegradation which has been observed (340 nm, aqueous solution) is decarboxylation to (230) [140]. When irradiated at 310 to 390 nm in an aqueous solution containing a surfactant to solubilize the drug, it was shown by Moore and Chappuis to produce singlet oxygen [83]. Yoon and Lee irradiated aqueous or ethanolic solutions of the drug at wavelengths above 300 nm to gain evidence for the production of superoxide, probably via the anion radical of benzoxaprofen, since the decarboxylated drug was not active in this respect. The photosensitization was inhibited by superoxide dismutase [141]. Reszka and Chignell detected, from similar irradiations, hydroxyethyl and ethoxyl radicals as well as both singlet oxygen and superoxide. They concluded that both oxygen-dependent and oxygen-independent processes may have contributed to the phototoxic reactions [138]. An interesting suggestion by Kochevar *et al.* followed from work on the oxygen-dependent haemolysis of red blood cells. It was assumed that the polar benzoxaprofen photodecarboxylated at the surface of the cells. The nonpolar product (230) then dissolved in the lipid membrane, where it caused disruption via singlet oxygen. This explanation was used to account for their observation that the

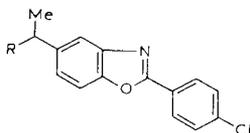

(229) R = COOH
(230) R = H

normal singlet oxygen quencher, sodium azide, was ineffective in preventing the haemolysis, as was superoxide dismutase [142, 143]. It is interesting to note that a model compound, 2-(4-chlorophenyl)benzoxazole, lacking only the propionic acid side-chain of benzoxaprofen, was irradiated in oxygen-free cyclohexane and showed photodimerization and photodehalogenation, both via the singlet state [144].

COCAINE

This local anaesthetic was photodemethylated in an organic chemical experiment. The cocaine (231) was irradiated at 300 nm in methanol for 43 h under nitrogen to give a 20% yield of norcocaine (232) [145].

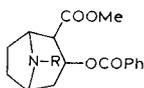

(231) R = Me
(232) R = H

INDAPAMIDE

This indoline derivative has antihypertensive and diuretic actions. Indapamide (233) in methanol under nitrogen was irradiated with a medium-pressure mercury lamp through a copper sulphate filter solution for 12 h. The filter removed wavelengths below 300 nm. Products were separated by preparative TLC and identified as 2-methylindoline (234), the formylhydrazide (235), the amide (237) and semicarbazide. The procedure was repeated under oxygen to give the above products plus the urethane (236), acid (238), ester (239) and *N*-acetylanthranilic acid [146].

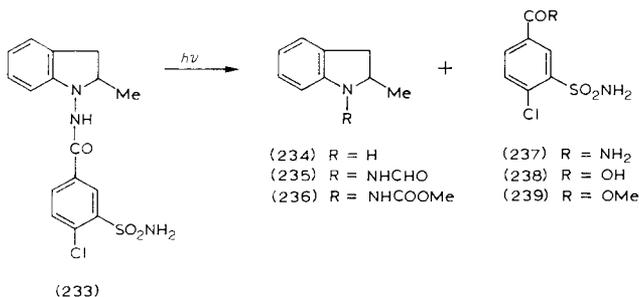

AMINOPHYLLINE

This traditional diuretic is a double compound of theophylline (240) and ethylenediamine. When a solution of aminophylline was exposed to oxygen and daylight, it gave dimethylalloxan (241), N^1, N^2 -dimethylloxamide and ammonia [147].

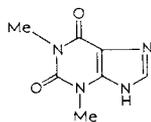

(240)

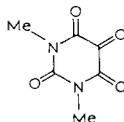

(241)

MERCAPTOPYRINE

The antineoplastic agent mercaptopurine (242) was irradiated in aqueous solution under oxygen at wavelengths greater than 300 nm to give three photo-products. Under nitrogen there was no degradation. The main initial product was purine-6-sulphinate (244). This was unstable and was further photo-oxidized to purine-6-sulphonate (245). Hypoxanthine (243) was a minor photodegradation product, but it also accumulated through a dark reaction on the sulphonate [148]. Further work showed that mercaptopurine can sensitize biological tissue to UVA radiation. The activity of the drug and of its 2- and 8-hydroxy metabolites resides in the sulphhydryl function through free-radical photosensitization and singlet oxygen production. It was shown that mercaptopurine could photosensitize the destruction of free-radical scavengers, both natural (glutathione) and unnatural (pyrogallol) [149].

When photolysis (>290 nm) was carried out in *t*-butanol, the identified products were purine, hypoxanthine and purine-6-sulphonic acid. Again, reaction occurred only in the presence of oxygen. The sulphonic acid was thought to arise from the sulphinic acid, but this intermediate could not be detected [150].

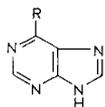

(242) R = SH

(243) R = OH

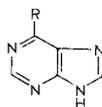
(244) R = SO₂⁻(245) R = SO₃⁻

AZATHIOPRINE

Azathioprine (246) has been of great value as an immunosuppressive drug following kidney transplantation. However, its use is associated with the occurrence of severe skin cancers, particularly in patients who indulge in sunbathing. Irradiation in deaerated solutions at pH 7 or, more rapidly, at pH 3 to 4 gave at least six peaks on HPLC analysis. Two were identified as 6-mercaptopurine (242) and hypoxanthine (243), but as the latter is a photolysis product of the former, a secondary reaction was indicated. Other peaks corresponded to 1-methyl-4-nitro-5-hydroxyimidazole and a compound which had lost a molecule of nitrous acid relative to azathioprine, for which structure (247) was suggested. A peak corresponding to the nitrite ion was also observed on HPLC analysis. In the presence of oxygen, no 6-mercaptopurine was detected in the irradiated solution, but small amounts of its oxidation products, purine-6-sulphinic acid (244) and purine-6-sulphonic acid (245), were seen [151].

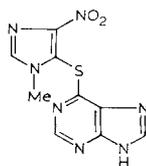

(246)

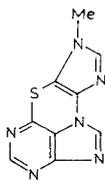

(247)

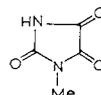

(248)

In an attempt to understand further the carcinogenicity of azathioprine, recent work in the authors' laboratory has concentrated on the photodegradation of two compounds associated with the drug. 1-Methyl-4-nitro-5-thioimidazole is a metabolite and 5-hydroxy-1-methyl-4-nitroimidazole a hydrolysis product. Both gave, on irradiation at wavelengths greater than 300 nm, 1-methylparabanic acid (248) [152]. The primary metabolites of azathioprine had previously been shown to be more potent than the parent drug as photosensitizers. Both 6-mercaptopurine and these imidazoles may play roles in its neoplastic action [151].

PSORALENS

The ancient Egyptians used the plant *Ammi majus*, which contains methoxsalen (sometimes called 8-methoxy-psoralen, based on a now obsolete method of naming fused heterocycles; indexed in *Chemical Abstracts* under furo[3,2-g][1]benzopyran-7-one, 9-methoxy-, 249), in combination with sunbathing to

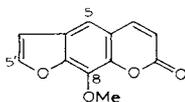

(249)

treat the skin disorder vitiligo (leucoderma). The pure drug and derivatives of it are now used in conjunction with UVA to treat psoriasis [153]. It can also be used to cure surface cancers such as cutaneous T-cell lymphoma. Methoxsalen is non-toxic and inactive after ingestion, but intercalates between basepairs in the DNA chain. On absorption of two photons of UVA radiation it crosslinks the two chains and prevents replication [6, 7, 154]. However, it has recently been reported that methoxsalen was covalently bound to five human cell lines after exposure to UVA light. This was independent of its ability to intercalate DNA. It was suggested that at least part of the psoralen-induced phototoxicity is mediated through non-DNA binding sites [155].

Other psoralens which have similar activity are 5-methoxypsoralen and trioxsalen (sometimes called 4,5',8-trimethylpsoralen; *Chemical Abstracts* name: furo[3,2-g][1]benzopyran-7-one, 2,5,9-trimethyl-,) – the preferred treatment for vitiligo. It has been shown that these drugs photosensitize the production of singlet oxygen in proportion to their skin-sensitizing activity. It was suggested that, in addition to the crosslinking of DNA, the singlet oxygen may play a role in inducing erythema and pigmentation and could be important in the mutagenicity [154].

PHYSOSTIGMINE

The anticholinesterase alkaloid physostigmine (250) was photodegraded at 300 nm to deoxyeseroline (251) in 10% yield, along with a not readily purified oil [156].

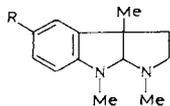

(250) R = MeNHCOO

(251) R = H

ERGOTAMINE AND DIHYDROERGOTAMINE

Ergotamine (252) tartarate in aqueous solution under nitrogen was photohydrated by UV light, daylight or incandescent light to a mixture of the lumiergotamines (253) [157].

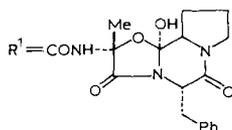
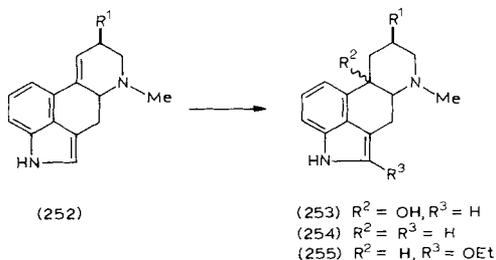

Scheme 2.6

A solution of dihydroergotamine (254) methanesulphonate in water was left in the sunlight for 15 days. The only photolysis product found was the derivative (255). There had been no alcohol in the reaction solution, so the molecule was assumed to have formed an oxo-derivative which gave the *enol* ether during separation by thick-layer chromatography [158], (Scheme 2.6).

RESERPINE

The hypotensive and sedative drug reserpine (256) has long been known to decompose in daylight. The photolysis has been studied in aqueous solution under a mercury discharge tube [159] and in chloroform at 360–370 nm [160]. The conclusions were essentially the same. The derivatives detected were isoreserpine (the C-3 epimer of reserpine), 3,4-dehydroreserpine (257) and lumireserpine which was shown to be 3,4,5,6-tetrahydroreserpine (258).

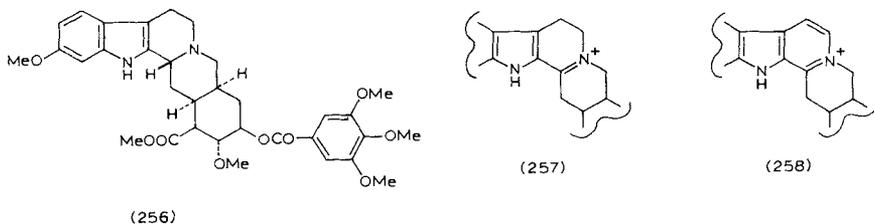

DRUGS WITH SIX MEMBERED HETEROCYCLIC RINGS

NICOTINIC ACID AND NICOTINAMIDE

The B-group vitamin, nicotinic acid (259), was irradiated with low-intensity light at 254 nm. In aqueous solution without buffer, the bi-aryl (260) was obtained, presumably via decarboxylation to give the pyridyl anion which would attack position 6 of nicotinic acid. In aqueous acid, the substrate was photohydroxylated to give 2-hydroxynicotinic acid (40%). Clearly, only the cationic form was sufficiently activated for position 2 to be attacked by the solvent. Nicotinamide under the same conditions was also converted to the 2-hydroxy derivative, but the reaction was slower [161].

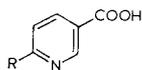

(259) R = H
(260) R = 3-pyridyl

ISONIAZID

Irradiation of an alcoholic solution of the antitubercular drug isoniazid (261) with a low-pressure mercury lamp by Ninomiya and Yamamoto gave isolated yields of the hydrazone (262, 60%) and the hydrazide (264, 17%). Nicotinic and picolinic acid hydrazides reacted similarly, as did other alcohols. The production of (262) was easily understood since it was known that photolysis of ethanol gave acetaldehyde which would react spontaneously with the

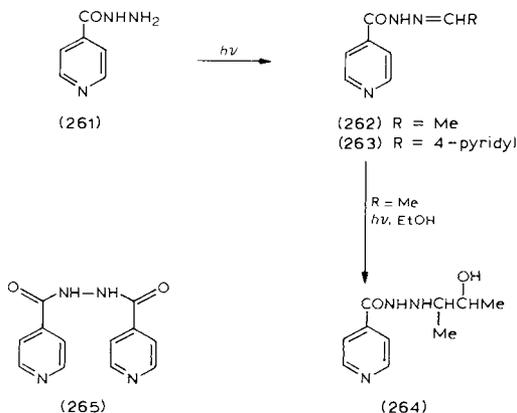

hydrazide (261). The remarkable photoaddition of a further molecule of alcohol to the hydrazone (262) to give (264) was established [162].

Chiang and Lin also irradiated alcoholic solutions of isoniazid, but used a high-pressure mercury lamp. From the methanol solution they isolated small yields of isonicotinic acid, isonicotinamide, the hydrazone (263) and the bishydrazide (265). From the ethanolic solution, they obtained isonicotinamide, the hydrazone (262) and the bishydrazide (265). As before, (262) was assumed to arise via photo-oxidation of the solvent. The other products were explained as resulting from either CO-N or N-N bond homolysis [163].

PYRITHIONE

Pyrithione (266) chelates metals; its zinc derivative is antibacterial and antifungal and is used in shampoos as an antiseborrhoeic. Dipyrithione (267) is also antibacterial and antifungal. Pyrithione used in hair dressings or in selective metal ion assays was known to develop green or brown colours when exposed to light. Solutions in chloroform or aqueous buffers were irradiated in an apparatus which simulated the UV in sunlight. Eight 8 W blacklight blue fluorescent tubes gave a light output between 300 and 400 nm. The first photolysis product, detected within 1 min in chloroform, was the dimer (267) and within 6 min the reduced dimer (268) was present. Both compounds were identified by TLC comparison with reference samples [164].

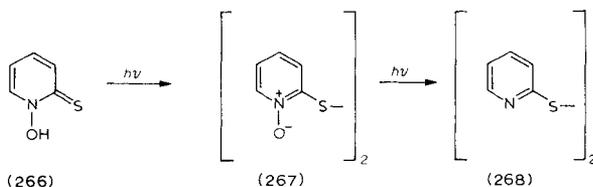

METHYPRYLONE

An ethanolic solution of the hypnotic, methyprylone (269), was irradiated with simulated sunlight [164]. Solvent attack and ring opening gave the amidoester (270) [165].

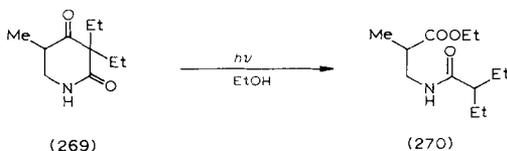

NIFEDIPINE

Solutions of the calcium antagonist, nifedipine (271), rapidly turn yellow and then brown on exposure to light. In ethyl acetate it was found to decompose in sunlight to the nitrosophenylpyridine (272) and under UV light (254 nm) to the nitro compound (273) [166, 167]. When irradiated by a fluorescent lamp, water, ethanol, acetonitrile and chloroform solutions all gave similar UV spectral changes [168]. The rate of oxidation was highest at low pH and in 95% alcohol solutions was complete within 4 h [169]. Experiments with similar compounds lacking the nitro group failed to reveal any photodecomposition. It was concluded that the nitro group was essential for photo-oxidation to occur. The drug was quite stable in solutions protected from light [168].

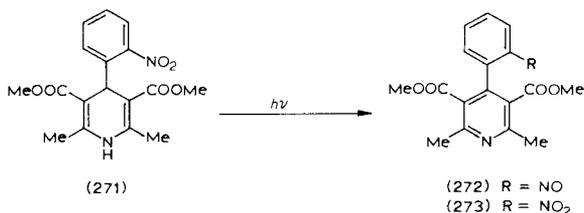

PYRIDOXINE AND PYRIDOXAL 5-PHOSPHATE

Pyridoxine (vitamin B-6, 274) was irradiated in neutral solution in the presence of oxygen at 254 nm to give the diacid (275). It was possible to identify all partial and fully oxidized intermediates to (275) at both the 4- and 5-positions. When the irradiation was performed in the absence of oxygen, only the dimer (277) was obtained [170].

Infusion solutions of pyridoxine (274) hydrochloride were unaffected by ward lighting, but when riboflavine phosphate sodium was added the pyridoxine was completely decomposed in about 3 h. The photosensitized oxidation gave

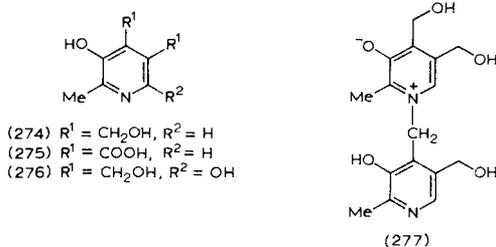

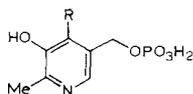

(278) R = CHO
(279) R = COOH

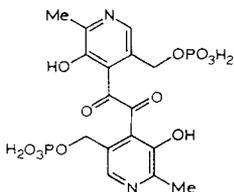

(280)



(281)

as the main product the hydroxy derivative (276). Solutions could be protected by shading or by addition of ascorbic acid as an antioxidant [171].

An aqueous solution (pH 6.5) of pyridoxal 5-phosphate (278) was irradiated at 410 nm with oxygen passing for 5 h. Of five spots on TLC, the major products were shown to be the acid (279) and the dimer (280). When high initial concentrations of neutral solutions of pyridoxal 5-phosphate were irradiated without oxygen passing, there were lower yields of (279) and (280) and the major product was the acyloin (281) [172].

BARBITURATES

Barbitone

Barbitone (barbital, 282) was irradiated in aqueous solution at pH 10 with light of 254 nm wavelength to give the ureide (289) in 68% yield. In ethanol, the derivative (290) was formed (62%). With *N*-methylbarbitone (283) in buffer at pH 10, a mixture of the ureide (291) and the imidazole (292) was obtained. It was suggested that the ring-opened compounds were formed via isocyanates (288). Reaction with water would then give an acid which would spontaneously decarboxylate, but in ethanol a stable urethane (290) would form [173].

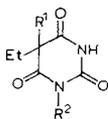

(282) R¹ = Et, R² = H
(283) R¹ = Et, R² = Me
(284) R¹ = Ph, R² = Me
(285) R¹ = CH(Me)CH₂CH₂Me, R² = H
(286) R¹ = R² = H
(287) R¹ = OH, R² = H

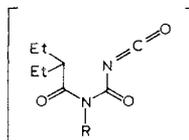

(288)

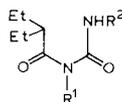

(289) R¹ = R² = H
(290) R¹ = H, R² = COOEt
(291) R¹ = Me, R² = H

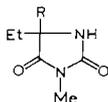

(292) R = Et
(293) R = Ph

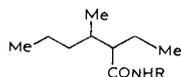

(294) R = H
(295) R = CONH₂

Methylphenobarbitone

Methylphenobarbitone (mephobarbital, 284) was stable to light in neutral solution but in alkaline buffer, where the anion was present, it gave carbon monoxide and a 40% yield of the imidazole (293) [174].

Pentobarbitone

Photolysis of pentobarbitone (pentobarbital, 285) was achieved on a solution buffered to pH 11 with a low-pressure mercury lamp over 10 h. At this pH the mono anion was the main species present. The products identified were the dealkylated ethyl barbitone (286), the amide (294) and both diastereoisomers of the ureide (295). On more prolonged irradiation, there also appeared ethylhydroxybarbitone (287) and an unidentified dimeric compound. When ethylbarbitone (286) was photolysed in the same way, it gave (287) and 2-ethyl-2-hydroxymalonic acid. Finally, pentobarbitone was irradiated in molar sodium hydroxide solution, where the dianion would be the main form present, to give (295) with a small amount of (294) [175].

Quinalbarbitone

When quinalbarbitone (secobarbital, 296) was irradiated in acid solution (pH 2) at 254 nm, it underwent photodealkylation to give (297), (298), pent-1-ene and pent-2-ene. These four compounds were also obtained at pH 10, but in addition there were the ring-opened materials (299) to (301), *Scheme 2.7* [176].

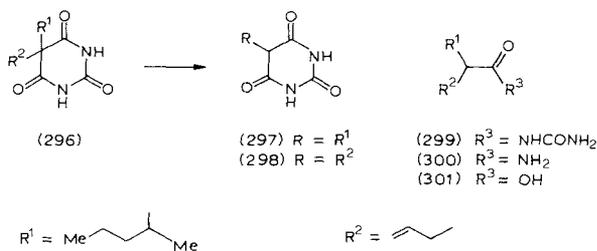
*Scheme 2.7**Proxibarbitone*

This nonhypnotic barbiturate (proxibarbal, 302) is used as a tranquillizer in the treatment of migraine. It gave a different spectrum of photolysis products from

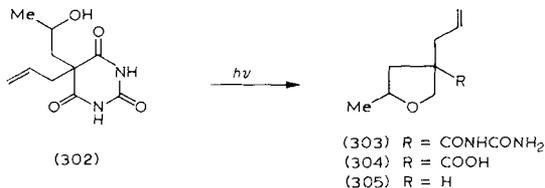

the previous barbiturates. The first (303) was a structural isomer of proxibarbitone. Progressive breakdown gave the acid (304) and urea followed by (305) [177].

Cyclobarbitone

The acid form of cyclobarbitone (cyclobarbital, 306) was photo-oxidized at 254 nm to the ketone (307). The reaction took 48 h, but no other details were given [178].

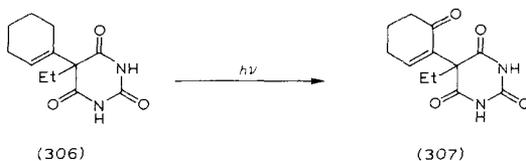

α -TOCOPHEROL

α -Tocopherol, vitamin E (308) is a biological antioxidant and singlet oxygen scavenger prescribed in cases of vitamin deficiency. An oxygenated solution of the vitamin in chloroform containing a trace of the photosensitizer tetraphenylporphine was cooled to -30°C and irradiated through a potassium dichromate

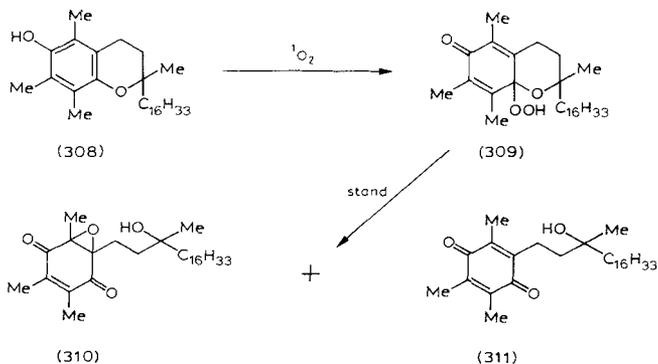

filter with a tungsten/halogen lamp. After careful workup, the sole product was the hydroperoxide (309). On being allowed to stand at room temperature for periods of 1 to 7 days, (309) was smoothly converted into a mixture of the epoxide (310) and quinone (311). It was suggested that the *p*-hydroperoxydienone (309) is the product of α -tocopherol interaction with singlet oxygen under biological conditions and that it would slowly decompose *in vivo* to the epoxide and quinone [179].

CHLOROQUINE AND HYDROXYCHLOROQUINE

The antimalarials chloroquine (312) and hydroxychloroquine (313) have a number of toxic side-effects thought to be photoinduced. They can cause skin pigmentation and bleaching of the hair. With long-term use, they are likely to effect irreversible damage to the cornea and retina. Moore and Hemmens used irradiation restricted to the range 310 to 380 nm to show that both compounds had maximal photo-oxidative behaviour at about pH 9, when they are in the monocationic forms. They suggested that the strong DNA binding may lower the apparent pK_a so that maximum reactivity would occur nearer to physiological pH values. Photopolymerization experiments showed that free-radical production was maximal from the neutral chloroquine molecule at high pH. It was proved that the radicals were produced by a photodechlorination process [180].

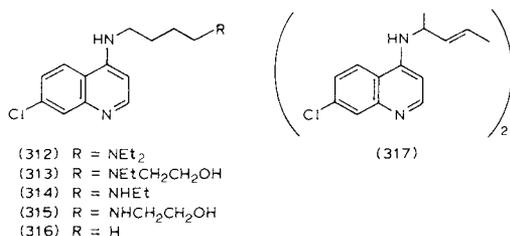

When Tonnesen *et al.* used an immersion lamp giving emission wavelengths between 240 and 600 nm, the same four photodegradation products were obtained from solutions of hydroxychloroquine (313) in water or isopropanol. Compounds (314) to (317) all derived from *N*-dealkylations. It was particularly noted that no photodechlorinated products were obtained in this work [181].

CINCHONA ALKALOIDS

Cinchonidine (318) and quinine (319) were subjected to broad-band irradiation in strongly acidic solutions in isopropanol. They were photoreduced to the

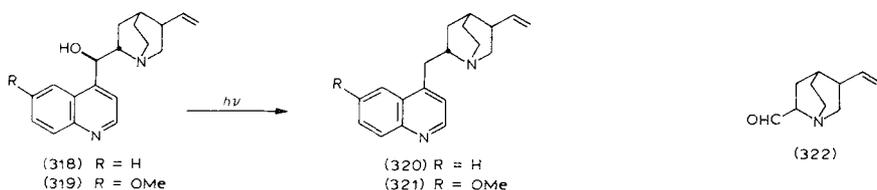

corresponding 9-deoxy compounds (320) and (321). The respective diastereoisomers, cinchonine and quinidine, reacted similarly [182]. When irradiations were conducted in neutral methanol with a medium-pressure mercury lamp, none of the 9-deoxy compounds could be detected by TLC. Instead, the C-8,C-9 bond homolysed to give quinoline or 6-methoxyquinoline as appropriate and the aldehyde (322). Again, all four alkaloids reacted in the same way. The difference between the two sets of results was ascribed to the fact that the alkaloids would have been fully protonated in the earlier work [183].

METHAQUALONE

There appear to be no reports of photodegradation of the hypnotic, methaqualone (323), but two of its metabolites are photolabile. The main metabolite, the N^1 -oxide (324), was photolysed at 366 nm or in sunlight to the oxaziridine (325) which could be isolated with care [184]. Further degradation, either thermal or photochemical, gave the more readily isolated products (326) to (329). A mechanistic explanation for these observations was offered [185]. A solid second metabolite (330) rapidly turned maroon on exposure to laboratory light and an alcoholic solution became intensely coloured under a medium-pressure

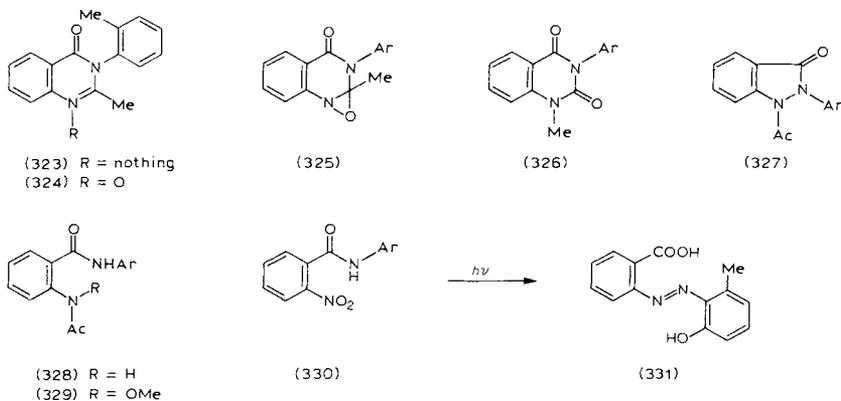

mercury lamp. The maroon product was isolated and identified as the azobenzene (331). Yields were never better than 25% due to the filtering effect of the highly coloured photoproduct. However, a sensitive colour test was developed to identify the metabolite in urine [186].

HYDROCHLOROTHIAZIDE

The diuretic, hydrochlorothiazide (332), causes skin photosensitization by both free-radical and singlet oxygen mechanisms. Also, the compound showed a light-activated weak mutagenicity. This suggested that photodechlorination gave a radical which damaged DNA. A solution of the drug in methanol was irradiated with UV light wavelengths greater than 310 nm under nitrogen. This gave about equal amounts of the dechlorinated material (333) and the ring-opened product (335) in addition to the photosubstituted derivative (334). On prolonged irradiation both (333) and (335) reacted further to give (336). Compound (335) under the same conditions gave an 85% yield of (336). These reactions were inhibited by oxygen to run at one-tenth of the rate under nitrogen. In water, rapid photodechlorination was followed by ring opening to give mainly (336) with a trace of (335). Oxygen again slowed the reaction and only (336) was obtained [187]. Although the drug is only a weak UV absorber in the 300 to 400 nm range, it was completely dechlorinated in 5 h [104].

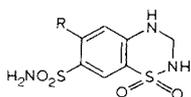

- (332) R = Cl
 (333) R = H
 (334) R = OMe

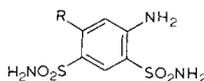

- (335) R = Cl
 (336) R = H

NALIDIXIC AND OXOLINIC ACIDS

The antibacterial, nalidixic acid (337), is associated with a high incidence of photosensitivity reactions. Detzer and Huber irradiated a solution in 0.1 M sodium hydroxide with a high-pressure mercury lamp and identified four photodegradation products: the decarboxylated derivative (338), carbon dioxide, ethylamine, and the new dione (339) [188].

Moore *et al.* [189] showed that nalidixic acid has a strong intramolecular hydrogen bond between the acid proton and the ring carbonyl oxygen. This stabilized the molecule and weakened the acid (pK_a 6.11). It is interesting in view of the previous photodegradation work that radical formation was most

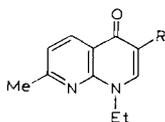

(337) R = COOH
(338) R = H

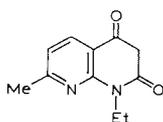

(339)

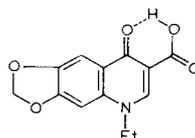

(340)

rapid from the unionized form *ca.* pH 4. However both ionized forms, the cation below pH 3 and the anion above pH 6, were more effective photo-oxidizers by the singlet oxygen mechanism.

The related antibacterial oxolinic acid (340, pK_a 6.9) also photosensitized singlet oxygen production in either of its ionized forms. As oxolinic acid seemed not to be very phototoxic, it was concluded that free radicals were the most potent photosensitizing agents from nalidixic acid and some other drugs.

DIPYRIDAMOLE

Photolysis of the anticoagulant dipyridamole (341) in organic solvents or on TLC plates gave the oxidized derivative of one of the piperidine rings (342) [190].

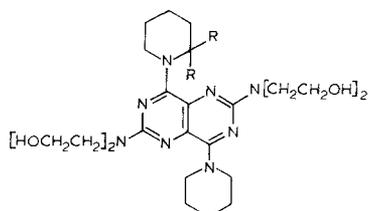

(341) R = H
(342) R, R = =O

METHOTREXATE AND FOLIC ACID

Methotrexate (343) is a powerful antineoplastic agent [190a], but has caused photosensitization in some patients. A buffered solution at pH 8.3 under fluorescent light gave the aldehyde (345), the acid (346) and the primary amine (351) (Scheme 2.8). It was shown that the aldehyde could be photo-oxidized to the acid [191]. Irradiation at 365 nm of an oxygen-saturated solution buffered to pH 7 again gave (345) and (346). In addition, aminopterin (347) and the azobenzene (352) were isolated. *N*-(4-Aminobenzoyl)-L-glutamic acid (351) was not photo-oxidized to (352) because it does not absorb at 365 nm. How-

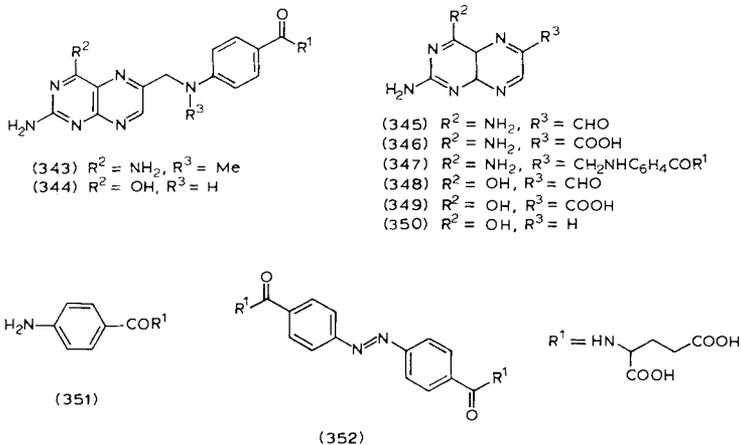

Scheme 2.8

ever, the aldehyde (345) was shown to act as a photosensitizer for this reaction [192]. Methotrexate photoproducts were shown to sensitize the oxidation of histidine and tryptophan at 365 nm by a singlet oxygen mechanism. There is also evidence that methotrexate is bound to serum albumin by UV light [193].

Folic acid (344) readily photolysed in 0.01 M acetic acid to the aldehyde (348) and a diazotizable amine. The aldehyde was progressively photo-oxidized to the acid (349) and photodecarboxylated to (350) [194].

THIOXANTHINE TRANQUILLIZERS

The tranquillizers flupenthixol (353), clopenthixol (354), chlorprothixene (355) and thiothixene (356) showed batch-to-batch variation in their *cis/trans* isomer ratio.

cis-Flupenthixol was irradiated in aqueous solution with a medium-pressure mercury lamp or a mercury-tungsten lamp. Using glass vessels to filter out

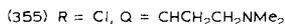
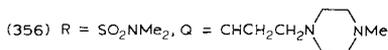
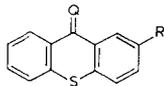

wavelengths below 300 nm, the lamps were adjusted to give 3.4-times the intensity of natural sunlight. In the absence of oxygen, the drug gave a 1 : 1 mixture of its *cis* and *trans* forms within 15 min. Under aerobic conditions the geometrical isomerism was again rapid, but both isomers were slowly oxidized to 2-trifluoromethylthioxanthone (357).

Similar isomerizations of clopenthixol (354) and chlorprothixene (355) were observed but, unlike flupenthixol (353), the photostationary states of these mixtures differed significantly in their isomer ratios from those of the drugs as normally supplied. It was pointed out that the photoisomerizations could affect their potencies [195].

CHLORPROMAZINE AND OTHER PHENOTHIAZINES

Serious side-effects have been associated with the important psychotherapeutic agent, chlorpromazine (358), almost since its introduction. High sensitivity to sunburn, pigmentation of the skin and ocular opacity are common phototoxic effects [196]. In a series of phenothiazines, the chloro-substituted compounds, particularly chlorpromazine, prochlorperazine and perphenazine, showed by far the greatest phototoxic activity [197, 198].



(358) R = Cl
 (359) R = H
 (360) R = OH



(361)

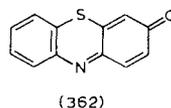

(362)

Felmeister and Discher irradiated chlorpromazine in 0.05 M HCl (pH 1.5) with light of 360 to 370 nm and identified chlorpromazine sulphoxide among the products [199]. Huang and Sands exposed an open dish containing an aqueous solution of chlorpromazine hydrochloride to the atmosphere under a UV lamp. It gave a mixture of chlorpromazine *N*-oxide, chlorpromazine sulphoxide and several unidentified products [200]. The same investigators repeated the irradiation under nitrogen and isolated a different list of products. Photodechlorination had given promazine (359), photosubstitution 2-hydroxy-promazine (360) and there was an unidentified dimer and a polymer [201]. From methanol solutions of chlorpromazine irradiated at 365 nm for 16 h, Sharples obtained chlorpromazine sulphoxide, promazine and a dimer [202]. The nucleophilic photosubstitution was confirmed by reactions in alcohols.

Rosenthal *et al.* irradiated chlorpromazine hydrochloride solutions in methanol with wavelengths greater than 300 nm in the absence of oxygen. They identified promazine and 2-methoxypromazine [196]. Grant and Greene used dilute anaerobic solutions of the base, left in sunlight, to produce a series of 2-substituted promazines from chlorpromazine. For example, in ethanol they obtained the 2-ethoxy and in isopropanol the 2-isopropoxy derivatives, respectively [203]. Kochevar and Hom photolysed chlorpromazine hydrochloride solutions with a medium-pressure mercury lamp through a filter to cut out wavelengths below 280 nm. Five low-molecular-weight products were separated by HPLC. Two were promazine and chlorpromazine sulphoxide, but the others were not identified. The high-molecular-weight photoproducts were separated by Sephadex chromatography into a mixture of dimers and a mixture of trimers and other oligomers. Both of these mixtures caused lysis of red blood cell membranes. It was suggested that the photoproducts that cause cell membrane disruption are dimers and higher multimers [204]. Maruchin irradiated an oxygenated aqueous solution (pH 6.01) with monochromatic light at 303 nm and obtained a dimer of the sulphoxide. Evidence was presented that the molecules were joined through an SO–OS bond [205].

An aqueous solution of the antihistamine, promethazine (361) hydrochloride, was photolysed to promethazine sulphoxide, phenothiazine, phenothiazine sulphoxide and 3*H*-phenothiazin-3-one (362) [206].

Saucin and Van de Vorst investigated the mechanisms of photodegradation in 29 phenothiazine derivatives by fluorescence and phosphorescence spectroscopy. They showed that, in the presence of oxygen, singlet oxygen and, more important, superoxide ions and cation radicals formed. There was some correlation between quantum yields of photoionization and *in vivo* phototoxic potency [207]. Decuyper *et al.* irradiated solutions of DNA and various promazines with a xenon lamp filtered to cut out wavelengths below 290 nm. In aerobic or anaerobic conditions, chlorpromazine gave radicals via photo-dechlorination which caused breaks in the DNA strands. Promazine, trifluoropromazine and methoxypromazine were less vigorous strand breakers and appeared to react through two mechanisms – first by direct reaction of the cation radical formed by irradiation and second via superoxide and its derived hydroxyl radicals [208].

Chlorpromazine and prochlorperazine were irradiated by Moore and Tamat in methanol and water at wavelengths greater than 300 nm. In methanol, both were rapidly photodechlorinated under nitrogen, but oxygen inhibited the reaction. The same photodegradation was observed in water under nitrogen and this time was only slightly slowed by oxygen [104]. Promazine and chlorpromazine were tested by Moore and Burt as photosensitizers at 365 nm in

micellar solutions. The micelles enhanced both free-radical and photo-oxidation reactions. The use of cationic, anionic and nonionic surfactants showed that the base form of chlorpromazine is the main photosensitizing form. Cation radicals are the major species formed photochemically from chlorpromazine and promazine. Photodechlorination accounted for the higher reactivity of the former. From this and other evidence, it was concluded that free radical reactions may play the major role in photosensitivity and, as the drugs were more reactive in a hydrophobic environment, cell membranes or the hydrophobic surfaces of proteins or DNA may be the important sites of action in photosensitivity [89].

Li and Chignell examined the photochemistry of chlorpromazine and its metabolites 7-hydroxychlorpromazine, demethylchlorpromazine, didemethylchlorpromazine and chlorpromazine sulphoxide. They found that all of the compounds except the sulphoxide underwent photodechlorination which was more rapid in the absence of air. It was concluded that the yield of dechlorinated product was directly related to the degree of phototoxicity [209].

7-Hydroxychlorpromazine and chlorpromazine sulphoxide generated hydroxyl radicals when excited at 330 nm under either anaerobic or aerobic conditions. It is interesting that phenothiazine sulphoxides and 7-hydroxychlorpromazine have been associated with ocular opacity. It was suggested that the highly reactive hydroxyl radicals may be the cause of this. Chlorpromazine does not damage the eye [209].

Motton *et al.* made a spin-trapping study of the radicals induced by a xenon arc lamp from promazine and chlorpromazine. The results suggested that the radical from photodechlorination of chlorpromazine was sufficiently more reactive than the promazine radical to amount for the order of magnitude difference in the potencies of their phototoxicities [233].

EMETINE

The emetic principle of ipecacuanha, emetine (363), has found important application against amoebiasis. An aqueous solution of the dihydrochloride was irradiated to *ca.* 50% decomposition at 254 nm. The decomposition pattern was qualitatively similar at longer wavelength (300 or 350 nm), but the reaction rate was reduced. The products isolated and characterized in an impressive piece of work included emetamine (1',2',3',4'-tetrahydroemetine), *O*-methylpsychotrine (1',12-didehydroemetine), 1',2'-didehydroemetine and the dihydroisoquinolines (364) and (365). There were also five quaternary ammonium derivatives (366) to (370) isolated as their hydroxides [210].

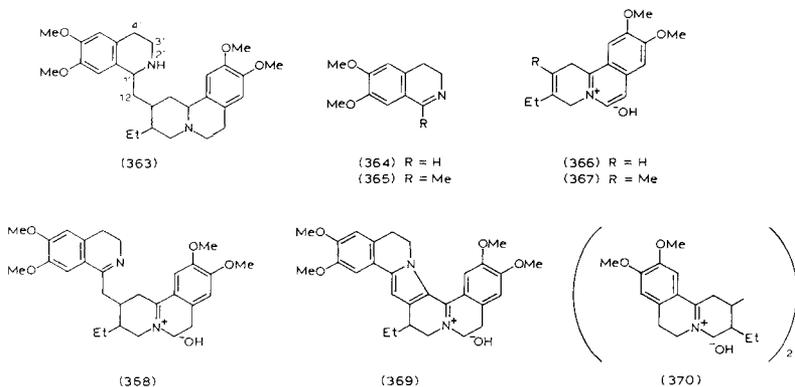

RIBOFLAVIN

Riboflavin (vitamin B-2, 371) was so rapidly decomposed by tropical sunlight that aqueous solutions had to be screened to reduce the light flux by 90% so that the photodecomposition could be studied. Dunlap and Susic found that the rate of decomposition was higher in sea water, giving lumichrome (372, 96%) and lumiflavin (373, 4%), than in distilled water, where only lumichrome was obtained [211]. Riboflavin was photoreduced under nitrogen to dihydroriboflavin. On admission of air, some of the material was reoxidized to riboflavin but the rest was converted to a mixture of lumichrome and lumiflavin. It was possible to take the compound through several reduction-oxidation cycles with accumulation of the dealkylated derivatives [212]. Some of the early work was reviewed in 1962 [213]. Smith and Metzler used a fluorescent tube to illuminate an aqueous solution under vacuum. They obtained a mixture which included lumichrome and the acetaldehyde derivative (374) [214]. They showed that (374) decomposed in alkaline solution (pH 9.9) to a mixture of lumiflavin, in major amount, and lumichrome [215]. In the same laboratory, a new TLC system was developed to allow the separation of several new photodegradation

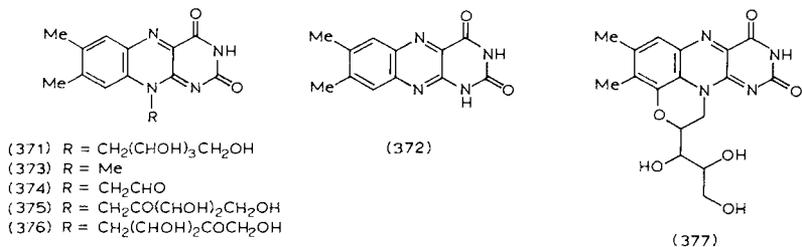

products [216]. Two were identified as the 2'-ketone (375) and the 4'-ketone (376) [217]. In the presence of high concentrations of divalent anions, Jorns *et al.* discovered a new cyclized product in up to 3.5% yield. Irradiation of aqueous solutions with a projector lamp (λ_{\max} 445 nm) gave the cyclodehydroflavin (377) [218].

Several otherwise stable drugs have been photodegraded in the presence of riboflavin. Solutions of 12 sulpha drugs in aqueous methanol exposed to fluorescent light for 5 to 60 min degraded only when riboflavin or lumichrome was included. Six other sulpha drugs were not damaged by this treatment. It was concluded that only those with a heterocyclic moiety and a free sulphonamide acidic hydrogen were vulnerable [219].

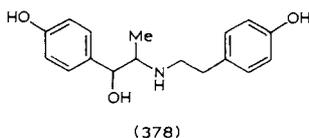

Ritodrine (378) hydrochloride was also stable in infusion solutions containing glucose, but in the presence of riboflavin it photo-oxidized to *p*-hydroxybenzaldehyde [220]. See also the photosensitized reaction of pyridoxine.

DRUGS WITH SEVEN-MEMBERED HETEROCYCLIC RINGS

BENZODIAZEPINES

Some of the benzodiazepine group of tranquillizers and hypnotics, for example, chlordiazepoxide and nitrazepam, have been shown to be phototoxic [221].

Diazepam

Cornelissen and co-workers found that the products of photodegradation of diazepam (379) were different after irradiation at 254 nm from those after irradiation at wavelengths greater than 300 nm. In simulated natural conditions

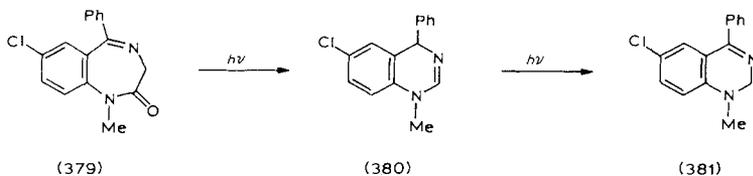

using methanol-water at pH 7.4 and irradiation at 300 nm, diazepam gave 2-methylamino-5-chlorobenzophenone and glycine. At 254 nm there was an additional product, the 1,4-dihydroquinazoline (380). This became the main product when the photolysis was conducted in methanol alone and was slowly photoisomerized to the 1,2-dihydroquinazoline (381). It was established that isolated (380) could be photoisomerized to (381) under the same conditions [10].

Following a previous prolonged irradiation of diazepam at 254 nm, the same group identified the above four compounds and also 2-methylaminobenzophenone, 2-amino-5-chlorobenzophenone, 1-methyl-4-phenylquinazolinone (382) and 6-chloro-1-methyl-4-phenylquinazolinone (383) [221]. Diazepam has been shown to be a comparatively weak photosensitizer via singlet oxygen production [222]. However, *in vivo* experiments and clinical experience suggest that it is not phototoxic in man [10].

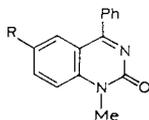

(382) R = H
(383) R = Cl

Nitrazepam

The photodecomposition of nitrazepam (384) was first investigated in a series of organic solvents under nitrogen with a high-pressure mercury lamp or in sunlight. Solvents with transferrable hydrogen atoms (alcohols, tetrahydrofuran, dioxane, etc.) caused photoreduction of the nitro group to an amino group (385) and a photoreductive dimerization to the azo derivative (386) and the azoxy derivative (387). It was shown that the reduction intermediate (387) could be photolysed to (386). Further, it was recognized that nitrazepam is readily hydrolysed or metabolized to 2-amino-5-nitrobenzophenone. Under the same photodegradation conditions, this ketone was reduced to 2,5-diamino-

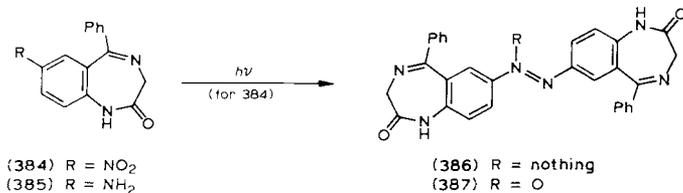

benzophenone and azo and azoxy compounds equivalent to (386) and (387) [223].

Clearly, any of these degradation products could be the cause of the phototoxicity. Later irradiations, carried out in isopropanol at 350 nm in the presence or absence of oxygen, demonstrated that the drug is a photosensitizer for singlet oxygen. Under anaerobic conditions, the same photoreductions were seen as above. In the presence of oxygen, nitrazepam was stable, but in a series of experiments the singlet oxygen produced was accepted by both 2-methyl-2-pentene and levodopa. It seemed that the gas was a quencher for the excited state of the drug, preventing its photodegradation at the cost of production of highly toxic singlet oxygen [224].

Chlordiazepoxide

Not only does chlordiazepoxide (388) show phototoxicity, but so do two of its metabolites, demethylchlordiazepoxide and demoxepam (389). The first of these is formed by *N*-demethylation of the drug and this is followed by oxidative deamination to give demoxepam. Both derivatives therefore retain the *N*-oxide group, which proved to be the seat of the phototoxicity. When irradiated in isopropanol at 350 nm for a few minutes, all three compounds gave oxaziridines [10, 225].

In further experiments, chlordiazepoxide (388) was dissolved in methanol or methanol-water. Solutions were irradiated at 254, 300 or 350 nm for 50 min. Change of wavelength did not alter the products formed, but did change their

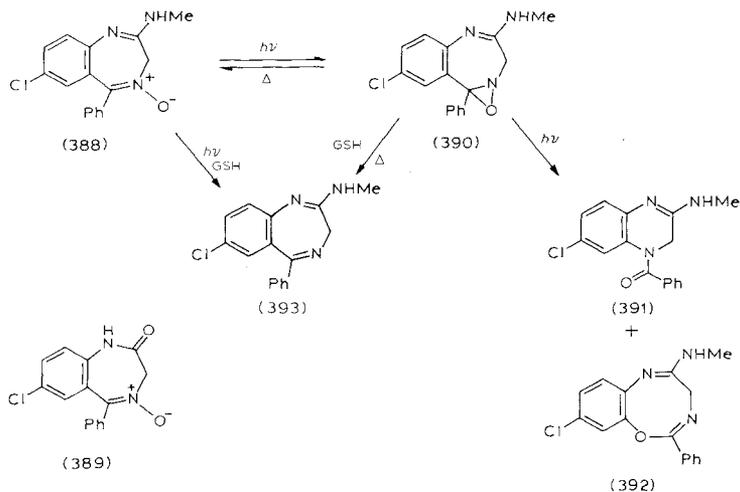

proportions in the reaction mixture. Initially the oxaziridine (390) was formed and this was converted on to the quinoxaline (391) and the benzoxadiazocine (392) [226]. At 350 nm, up to 80% of the chlordiazepoxide was converted into oxaziridine with only trace amounts of the secondary photolysis products. This was because the oxaziridine has negligible UV absorption at this wavelength. When glutathione (GSH) was added to the reaction mixture, the rate of decomposition increased and only the alternative products, the reduced benzodiazepine (393) and a conjugate were obtained. The higher rate of reaction pointed to the participation of two excited states. The first produced oxaziridine, which then reacted thermally with glutathione. The second excited state reacted directly with glutathione [10]. The photosynthetic preparation of (391) and (392) by broad-band irradiation of chlordiazepoxide has been scaled up and patented [227].

It was conclusively shown that deoxychlordiazepoxide (393) had none of the phototoxic properties of the parent drug, at least in the rat [225]. Chlordiazepoxide, demethylchlordiazepoxide, demoxepam and diazepam-4-oxide were all phototoxic to a bacterial cell preparation. There was a close relationship between the phototoxicities of the *N*-oxides and the toxicity in the dark of their oxaziridines. The reduced forms of the four compounds were not phototoxic [228]. Kinetic studies demonstrated that the oxaziridine (390) covalently bonds to plasma proteins. The half-life of the oxaziridine in the presence of high concentrations of protein was about 30 min. It therefore has time not only to bind to biomolecules in the skin surface, but also to attack internal organs. This was put forward as the explanation of previously observed kidney and liver damage in the rat [229].

Analysis of benzodiazepines

It is interesting to note that the *N*¹-alkylbenzodiazepines can be analysed by a method that involves photodealkylation. The compounds are acid-hydrolysed to benzophenones and run on a plate to separate primary and secondary amines. The plate is then exposed to UV light for 10–15 min, which causes *N*-dealkylation, and run in the second dimension to identify the primary aminobenzophenones [230].

DOXEPIN AND DOTHIEPIN

The tricyclic antidepressives, doxepin (394) and dothiepin (395), were photoisomerized when aqueous solutions of their hydrochlorides were irradiated with a medium-pressure mercury lamp [195]. Doxepin was photodegraded by

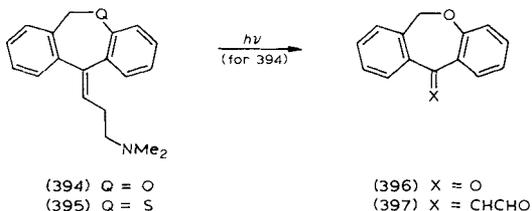

sunlight in either dilute hydrochloric acid or buffer (pH 3.6 to 6.5). The drug is used as an isomeric mixture, but over 60 days illumination the proportion of the *cis* form increased from 13% to 23% in acid and to 45% in buffers (pH 4.5 or 6.5). In addition, two new compounds were identified, the ketone (396) and the aldehyde (397). The latter showed a *cis/trans* ratio of 1 : 3 [231]. When similar samples were irradiated in glass ampoules with a high-pressure mercury lamp, decomposition was much more rapid, but a different pattern of products was seen. These compounds, which probably included polymers, were not identified [232].

APPENDIX

LIST OF COMMON PHOTOREACTIONS OF DRUGS

<i>Photoreaction</i>	<i>Drug</i>	<i>Photoreaction</i>	<i>Drug</i>	
Cyclization	adrenaline	Decarboxylation	hydroxychloroquine	
	azathioprine		levodopa	
	calciferol		methotrexate	
	chlordiazepoxide		phenylalanine	
	cholecalciferol		tyrosine	
	clomiphene		Decarboxylation	barbitone
	dienoestrol			methylphenobarbitone
	isoprenaline			pentobarbitone
	noradrenaline			quinalbarbitone
	phyloquinone			Decarboxylation
	stilboestrol		nalidixic acid	
tamoxifen	naprofen			
<i>N</i> -Dealkylation	amidopyrine	Dehalogenation	nicotinic acid	
	cocaine		amiodarone	
	diphenhydramine		chloroquine	
	emetine		chlortetracycline	
	folic acid			
hydrochlorothiazide				

continued

<i>Photoreaction</i>	<i>Drug</i>	<i>Photoreaction</i>	<i>Drug</i>
<i>(Dehalogenation cond.)</i>	chlormpromazine	Oxidation	retinoic acid
	demeclocycline		stilboestrol
	diazepam		thiothixene
	frusemide		
	hexachlorophene		
	hydrochlorthiazide		
	oxytetracycline		
	perphenazine		
	prochlorperazine		
	tetrachlorosalicylanilide		
thyroxine			
Dehydroxylation	levodopa		doxepin emetine
Dimerization	chlormpromazine		ethinyloestradiol
	dithranol		folic acid
	protriptyline		frusemide
	vanillin		menadione
			menaquinone-1
Hydrolysis	azathioprine		menaquinone-4
	benorylate		mercaptopurine
	diazepam		methotrexate
	diphenhydramine		nalidixic acid
	frusemide		nicotinamide
	furazolidone		nicotine
	nitrofurantoin		nicotinic acid
			nifedipine
			norethisterone
			oestrone
Hydroxylation	ergotamine		phenytoin
	phenylalanine		phyloquinone
	tyrosine		pyrithione
Isomerization	calciferol	Rearrangement	reserpine
	chlorprothixene		sulpyrine
	cholecalciferol		tetracycline
	clomiphene		
	clopenthixol		
	dienoestrol		
	doxepin		benorylate
	flupenthixol		betamethasone
	furazolidone		chlordiazepoxide
	menaquinone-4		dexamethasone
	nitrofurantoin		diazepam
	nitrofurazone		diphenhydramine
	norethisterone		metronidazole
	phyloquinone		phenazone
			phenytoin

<i>Photoreaction</i>	<i>Drug</i>	<i>Photoreaction</i>	<i>Drug</i>
	prednisolone prednisone proxibarbitone thiamin	Sensitization	quinidine quinine <i>p</i> -aminobenzoic acid amiodarone
Reduction	chloramphenicol cinchonidine cinchonine nitrazepam physostigmine pyrithione quinidine quinine		benzoxaprofen chlortetracycline demeclocycline dithranol menadione mercaptapurine methotrexate nalidixic acid oxolinic acid
Ring dealkylation	cinchonidine cinchonine pentobarbitone quinalbarbitone		oxytetracycline protriptyline psoralens riboflavin

REFERENCES

1. British Pharmacopoeia (Her Majesty's Stationery office, London) 1980.
2. British Pharmacopoeia (Her Majesty's Stationery office, London) 1988.
3. R.R. Anderson and J.A. Parrish, in *The Science of Photomedicine*, eds. J.D. Regan and J.A. Parrish (Plenum Press, NY) 1982, pp. 147-174.
4. T.R.C. Sisson, *Drug Ther.*, (1976) 42.
5. I.E. Kochevar, *Photochem. Photobiol.*, 30 (1979) 437.
6. L.C. Harber and R.L. Baer, *J. Invest. Dermatol.*, 58 (1972) 327; P.J. Reynolds and J.K. Sugden, *Pharm. Acta Helv.*, 57 (1982) 164.
7. R.L. Edelson, *Sci. Am.*, 259(2) (1988) 50.
8. *The Biological Effects of UVA Radiation*, eds. F. Urbach and R.W. Gange (Praeger, Connecticut) (1987)
9. M.J. Peak and J.G. Peak in ref. 8, p. 42.
10. P.J.G. Cornelissen and G.M.J. Beijersbergen van Henegouwen, *Pharm. Weekblad Sci. Edn.*, 2 (1980) 39.
11. D.E. Moore, *Trends Anal. Chem.*, 6 (1987) 234.
12. D.E. Moore, *J. Pharm. Biomed. Anal.*, 5 (1987) 441.
13. S.W. Davidson and D. Lyall, *Pharm. J.*, (1987) 599.
14. O.R. Leeuwenkamp, E.J. van der Mark, W.P. van Bennekom and A. Bult, *Int. J. Pharm.*, 24 (1985) 27.
15. S. Ikeda, J.F. Schweiss, P.A. Frank and S.M. Homan, *Anesthesiology*, 66 (1987) 381.
16. W.P. Arnold, D.E. Longnecker and R.E. Epstein, *Anesthesiology*, 61 (1984) 254.

17. A.T. Chapman, *J. Am. Chem. Soc.*, 57 (1935) 419.
18. A.M. Clover, *J. Am. Chem. Soc.*, 44 (1922) 1107.
19. A. Rieche and R. Meister, *Ang. Chem.*, 49 (1936) 101.
20. S.A. Jethwa, J.B. Stanford and J.K. Sugden, *Drug Dev. and Ind. Pharm.*, 5 (1979) 79.
21. J.V. Castell, M.J. Gomez-L., V. Mirabet, M.A. Miranda and I.M. Morera, *J. Pharm. Sci.*, 76 (1987) 374.
22. C. Hasselmann and G. Laustriat, *Photochem. Photobiol.*, 17 (1973) 275.
23. C. Hasselmann and G. Laustriat, *Photochem. Photobiol.*, 21 (1975) 133.
24. D.H. Kenyon and M.S. Blois, *Photochem. Photobiol.*, 4 (1965) 335.
25. J.C. Dearden and J.G. Elrick, *J. Pharm. Pharmacol.*, 24 (1972) 140P.
26. K. Reszka and R.C. Sealy, *Photochem. Photobiol.*, 39 (1984) 293.
27. K. Usmanghani, I. Ahmad and S.M.S. Zoha, *Pakistan J. Sci. Ind. Res.*, 18 (1975) 229.
28. N.J. de Mol, G.M.J. Beijersbergen van Henegouwen and K.W. Gerritsma, *Photochem. Photobiol.*, 29 (1979) 7.
29. N.J. de Mol, G.M.J. Beijersbergen van Henegouwen and K.W. Gerritsma, *Photochem. Photobiol.*, 29 (1979) 479.
30. I. Kruk, *Z. Phys. Chem. (Leipzig)*, 226 (1985) 1239; *Chem. Abstr.*, 104 (1986) 79 034.
31. L.S. Jahnke and A.W. Frenkel, *Photochem. Photobiol.*, 28 (1978) 517.
32. C.C. Felix and R.C. Sealy, *Photochem. Photobiol.*, 34 (1981) 423.
33. M. Yoshioka, Y. Kirino, Z. Tamura and T. Kwan, *Chem. Pharm. Bull.*, 25 (1977) 75.
34. L. Chafetz and L.H. Chow, *J. Pharm. Biomed. Anal.*, 6 (1988) 511.
35. G.M.J. Beijersbergen van Henegouwen, H.J. van de Zijde, J. van de Griend and H. de Vries, *Int. J. Pharm.*, 35 (1987) 259.
36. I.K. Shih, *J. Pharm. Sci.*, 60 (1971) 1889.
37. J. Reisch and K.G. Weidmann, *Arch. Pharm. (Weinheim)*, 304 (1971) 911.
38. H. de Vries, G.M.J. Beijersbergen van Henegouwen and F.A. Huf, *Int. J. Pharm.*, 20 (1984) 265.
39. S.I.M. Mubarak, J.B. Standford and J.K. Sugden, *Pharm. Acta Helv.*, 57 (1982) 226.
40. J.C. Sutherland and K.P. Griffin, *Photochem. Photobiol.*, 40 (1984) 391.
41. B.M. Sutherland, *Photochem. Photobiol.*, 36 (1982) 95.
42. C.F. Chignell, B. Kalyanaraman, R.P. Mason and R.H. Sik, *Photochem. Photobiol.*, 32 (1980) 563.
43. C.F. Chignell, B. Kalyanaraman, R.H. Sik and R.P. Mason, *Photochem. Photobiol.*, 34 (1981) 147.
44. J. Reisch and D.H. Niemeyer, *Arch. Pharm. (Weinheim)*, 305 (1972) 135.
45. H-C. Chiang, S-J.S. Chen and L-C. Yeh, *J. Taiwan Pharm. Assoc.*, 28 (1976) 36.
46. F. Golpashin, B. Weiss and H. Durr, *Arch. Pharm. (Weinheim)*, 317 (1984) 906.
47. A.G. Motton and C.F. Chignell, *Photochem. Photobiol.*, 37 (1983) 17.
48. G.W. Schaffer, E. Nikawitz, M. Manowitz and H.U. Daeniker, *Photochem. Photobiol.* 13 (1971) 347.
49. R.W. Curley, Jr., and J.W. Fowble, *Photochem. Photobiol.*, 47 (1988) 831.
50. A.K. Davies, N.S. Hilal, J.F. McKellar and G.O. Phillips, *Br. J. Dermatol.*, 92 (1975) 143.
51. B. van der Walt and H.J. Cahnmann, *Proc. Natl. Acad. Sci. USA.* 79 (1982) 1492.
52. R.G. Frith and G. Phillipou, *J. Chromatogr.*, 367 (1986) 260.
53. T.D. Doyle, N. Filipescu, W.R. Benson and D. Barnes, *J. Am. Chem. Soc.*, 92 (1970) 6371.
54. T.D. Doyle, W.R. Benson and N. Filipescu, *J. Am. Chem. Soc.*, 98 (1976) 3262.
55. P. Hugelshofer, J. Kalvoda and K. Schaffner, *Helv. Chim. Acta*, 43 (1960) 1322.
56. T.D. Doyle, W.R. Benson and N. Filipescu, *Photochem. Photobiol.*, 27 (1978) 3.

57. D.W. Mendenhall, H. Kobayashi, F.M.L. Shih, L.A. Sternson, T. Higuchi and C. Fabian, *Clin. Chem.*, 24 (1978) 1518.
58. H.K. Adam, M.A. Gay and R.H. Moore, *J. Endocrinol.*, 84 (1980) 35.
59. C. Knobner, C. Romers, P.B. Braun and J. Hornsta, *Acta Cryst.*, B28 (1972) 2097.
60. R. Mermet-Bouvier, *Bull. Soc. Chim. Fr.*, (1973) 3023.
61. A.E.C. Snoeren, M.R. Daha, J. Lugtenburg and E. Havinga, *Rec. Trav. Chim. Pays-Bas*, 89 (1970) 261.
62. A. Verloop, A.L. Koevoet and E. Havinga, *Rec. Trav. Chim. Pays-Bas*, 74 (1955) 1125.
63. S.A. Bakker, J. Lugtenburg and E. Havinga, *Rec. Trav. Chim. Pays-Bas*, 91 (1972) 1459.
64. J.M.L. Mee, C.C. Brooks and K.H. Yanagihara, *J. Chromatogr.*, 110 (1975) 178.
65. K. Nakawaga, E. Kouno, K. Tabuchi, M. Kidawara, A. Osuka and K. Maruyama, *Niihama Kogyo Koto Semmon Gakko Kiyō, Rikogaku Hen*, 24 (1988) 96.
66. H. Werbin and E.T. Strom, *J. Am. Chem. Soc.*, 90 (1968) 7296.
67. R.M. Wilson, T.F. Walsh and S.K. Gee, *Tetrahedron Lett.*, 21 (1980) 3459.
68. C.D. Snyder and H. Rapoport, *J. Am. Chem. Soc.*, 91 (1969) 731.
69. M Ohmae and G. Katsui, *Vitamins (Japan)*, 39 (1969) 190.
70. M Ohmae and G. Katsui, *Vitamins (Japan)*, 39 (1969) 181.
71. J. C. Vire, G.J. Patriarche and G.D. Christian, *Pharmazie*, 35 (1980) 209.
72. Y. Yamano, S. Ikenoya, M. Ohmae and K. Kawabe, *Yakugaku Zasshi*, 99 (1979) 1102; *Chem. Abstr.*, 93 (1980) 8320.
73. Y. Yamano, S. Ikenoya, M. Anze, M. Ohmae and K. Kawabe, *Yakugaku Zasshi*, 98 (1978) 774; *Chem. Abstr.*, 89 (1978) 117 665.
74. G. Katsui, *Vitamins*, 38 (1968) 81.
75. S. Fujisawa, S. Kawabata and R. Yamamoto, *Yakugaku Zasshi*, 87 (1967) 1451; *Chem. Abstr.*, 69 (1968) 35 874.
76. C.M. Krishna, C. Decarroz, J.R. Wagner, J. Cadet and P. Reisz, *Photochem. Photobiol.*, 46 (1987) 175.
77. G.J. Fisher and E.J. Land, *Photochem. Photobiol.*, 37 (1983) 27.
78. J.R. Wagner, J. Cadet and G.J. Fisher, *Photochem. Photobiol.*, 40 (1984) 589.
79. C. Decarroz, J.R. Wagner, J.E. van Lier, C.M. Krishna, P. Reisz and J. Cadet, *Int. J. Radiat. Biol.*, 50 (1986) 491.
80. J.R. Wagner, J.E. Van Lier, C. Decarroz and J. Cadet, *Bioelectrochem. Bioenerg.*, 18 (1987) 155.
81. K. Muller, E. Eibler, K.K. Mayer and W. Wiegrebe, *Arch. Pharm. (Weinheim)*, 319 (1986) 2.
82. K. Muller, K.K. Mayer and W. Wiegrebe, *Arch. Pharm. (Weinheim)*, 319 (1986) 1009.
83. D.E. Moore and P.P. Chappuis, *Photochem. Photobiol.*, 47 (1988) 173.
84. G.E. Jones and D. Sharples, *J. Pharm. Pharmacol.*, 36 (1984) 46.
85. F.P. Gasparro and I.E. Kochevar, *Photochem. Photobiol.*, 35 (1982) 351.
86. J. Piette, J. Decuyper and A. van de Vorst, *J. Invest. Dermatol.*, 86 (1986) 653.
87. M. Bjellerup and B. Ljunggren, *Acta Derm.-Venereol*, 64 (1984) 378.
88. A.K. Davies, J.F. McKellar, G.O. Phillips and A.G. Reid, *J. Chem. Soc., Perkin Trans 2*, (1979) 369.
89. D.E. Moore, M.P. Fallon and C.D. Burt, *Int. J. Pharm.*, 14 (1983) 133.
90. A.S.W. Li, H.P. Roethling, K.B. Cummings and C.F. Chignell, *Biochem. Biophys. Res. Commun.*, 146 (1987) 1191.
91. A.S.W. Li, C.F. Chignell and R.D. Hall, *Photochem. Photobiol.*, 46 (1987) 379.
92. A.G.J. Sedee, G.M.J. Beijersbergen van Henegouwen and H.J.A. Blaauwgeers, *Int. J. Pharm.*, 15 (1983) 149.

93. A.G.J. Sedee, G.M.J. Beijersbergen van Henegouwen, H. de Vries, W. Guijt and C.A.G. Haasnoot, *Pharm. Weekbl. Edn. Sci.*, 7 (1985) 194.
94. A.G.J. Sedee, G.M.J. Beijersbergen van Henegouwen, W. Guijt and C.A.G. Haasnoot. *Pharm. Weekbl. Ed. Sci.*, 7 (1985) 202.
95. A. Sedee and G.M.J. Beijersbergen van Henegouwen, *Arch. Pharm. (Weinheim)*, 318 (1985) 111.
96. A.G.J. Sedee, G.M.J. Beijersbergen van Henegouwen, N.J. de Mol and G. Lodder, *Chem.-Biol. Interact.*, 51 (1984) 357.
97. J.R. Williams, R.H. Noore, R. Li and C.M. Weeks, *J. Org. Chem.*, 45 (1980) 2324.
98. J. Reisch, Y. Topaloglu and G. Henkel, *Acta Pharm. Technol.*, 32 (1986) 115.
99. J.R. Williams, R.H. Moore, R. Li and J.F. Blount, *J. Am. Chem. Soc.*, 101 (1979) 5019.
100. D.H.R. Barton and W.C. Taylor, *J. Chem. Soc.*, (1958) 2500.
101. Y. Arakawa, C. Fukaya, K. Yamanouchi and K. Yokoyama, *Yakugaku Zasshi*, 105 (1985) 1029.
102. T. Hidaka, S. Huruumi, S. Tamaki, M. Shiraishi and H. Minato, *Yakugaku Zasshi*, 100 (1980) 72.
103. K. Thoma, R. Kerker and Ch. Weissbach, *Pharm. Ind.*, 49 (1987) 961.
104. D.E. Moore and S.R. Tamat, *J. Pharm. Pharmacol.*, 32 (1980) 172.
105. D.E. Moore and V. Sithipitaks, *J. Pharm. Pharmacol.*, 35 (1983) 489.
106. A.M. Yahya, J.C. McElmay and P.F. D'Arcy, *Int. J. Pharm.*, 31 (1986) 65.
107. P.C. Rowbotham, J.B. Stanford and J.K. Sugden, *Pharm. Acta Helv.*, 51 (1976) 304.
108. D.E. Moore and C.D. Burt, *Photochem. Photobiol.*, 34 (1981) 431.
109. M.A. Quillian, B.E. McCarry, K.H. Hoo, D.R. McCalla and S. Vaitekunas, *Can. J. Chem.*, 65 (1987) 1128.
110. A.B. Narbutt-Mering and W. Weglowska, *Acta Pol. Pharm.*, 37 (1980) 301; *Chem. Abstr.*, 94 (1981) 109 228.
111. L. Ebringer, S. Trubacik and T. Tuyet, *Acta Fac. Rerum Nat. Univ. Comenianae, Microbiol.*, 6 (1978) 1; *Chem. Abstr.*, 90 (1979) 146 292.
112. Y. Hubert-Brierre, D. Herlem and F. Khoung-Huu, *Tetrahedron*, 31 (1975) 3049.
113. N. Hameed and H.D.C. Rapson, *J. Pharm. Pharmacol.*, 24 Suppl. (1972) 139 P.
114. P. Gygax, *J. Agri. Food Chem.*, 29 (1981) 172.
115. H.M. van Dort, L.M. van der Linde and D. de Rijke, *J. Agri. Food Chem.*, 32 (1984) 454.
116. N.P. Kovalenko, Yu.A. Ershov and S.F. Orlova, *J. Photochem.*, 31 (1985) 289.
117. S.N. Ege, *J. Chem. Soc., Chem. Commun.*, (1967) 488.
118. H. Cardy and E. Poquet, *Tetrahedron*, 37 (1981) 2279.
119. J. Reisch and W.F. Ossenkop, *Arch. Pharm. (Weinheim)*, 306 (1973) 155.
120. J. Reisch and W.F. Ossenkop, *Arch. Pharm. (Weinheim)*, 306 (1973) 679.
121. J. Reisch and W.F. Ossenkop, *Chem. Ber.*, 106 (1973) 2070.
122. J. Reisch and W.F. Ossenkop, *Arch. Pharm. (Weinheim)*, 309 (1976) 467.
123. B. Marciniac, *Pharmazie*, 40 (1985) 30.
124. B. Marciniac, *Pharmazie*, 40 (1985) 180.
125. W. Awe and B. Stoy, *Arch. Pharm. (Weinheim)* 293 (1960) 489.
126. M.V. Yankova and L.K. Yankov, *Farmatsiya (Sofia)*, 32 (1982) No. 1, 1; *Chem Abstr.*, 97 (1986) 127 557.
127. M.V. Yankova and L.K. Yankov, *Farmatsiya (Sofia)*, 32 (1982) No. 4, 5; *Chem Abstr.*, 98 (1986) 95 544.
128. H-C. Chiang and S-Y. Li, *J. Taiwan Pharm. Assoc.*, 29 (1977) 70.
129. B.J. Wilkins, G.J. Gainsford and D.E. Moore, *J. Chem. Soc., Perkin Trans. 1*, (1987) 1817.

130. K.H. Pfoertner and J.J. Daly, *Helv. Chim. Acta*, 70 (1987) 171.
131. J.K. Horton and M.F.G. Stevens, *J. Pharm. Pharmacol.*, 33 (1981) 808.
132. J. Reisch, K.-G. Weidmann and J. Triebe, *Arch. Pharm. (Weinheim)* 310 (1977) 811.
133. E. Pawelczyk and R. Wachowiak, *Diss. Pharm. Pharmacol.*, 20 (1968) 653.
134. R. Baugh, R.T. Calvert and J.T. Fell, *J. Pharm. Sci.*, 66 (1977) 733.
135. C.B. Zachary, D.N. Slater, D.W. Holt, G.C.A. Story and D.M. McDonald, *Br. J. Dermatol.*, 110 (1984) 451.
136. N. Paillous and M. Verrier, *Photochem. Photobiol.*, 47 (1988) 337.
137. A.S.W. Li and C.F. Chignell, *Photochem. Photobiol.*, 45 (1987) 191.
138. K. Reszka and C.F. Chignell, *Photochem. Photobiol.*, 38 (1983) 281.
139. G.F. Webster, K.H. Kaidbey and A.M. Kingman, *Photochem. Photobiol.*, 36 (1982) 59.
140. S. Navaratham, J.L. Hughes, B.J. Parsons and G.O. Phillips, *Photochem. Photobiol.*, 41 (1985) 375.
141. M. Yoon and K-H. Lee, *Bull. Korean Chem. Soc.*, 8 (1987) 261.
142. I.E. Kochevar, K.W. Hoover and M.J. Yoon, *J. Invest. Dermatol.*, 80 (1983) 318.
143. I.E. Kochevar, K.W. Hoover and M. Gawienowski, *J. Invest. Dermatol.*, 82 (1984) 214.
144. S. Fery-Forgues and N. Paillous, *J. Org. Chem.*, 51 (1986) 672.
145. V.I. Stenberg, S.P. Singh, N.K. Narain and S.S. Parmar, *J. Chem. Soc., Chem. Commun.*, (1976) 262.
146. R. Davis, C.H.J. Wells and A.R. Taylor, *J. Pharm. Sci.*, 68 (1979) 1063.
147. Y. Ishiguro, M. Sawada, Y. Tanaka and K. Kawabe, *Yakugaku Zasshi*, 100 (1980) 1048; *Chem. Abstr.*, 94 (1981) 109 189.
148. V.J. Hemmens and D.E. Moore, *J. Chem. Soc., Perkin Trans. 2*, (1984) 209.
149. V.J. Hemmens and D.E. Moore, *Photochem. Photobiol.*, 43 (1986) 247.
150. G. Wenska and S. Paszyc, *Z. Naturforsch.*, 36b (1981) 1628.
151. V.J. Hemmens and D.E. Moore, *Photochem. Photobiol.*, 43 (1986) 257.
152. A.F. Fell, J.V. Greenhill and M. McLelland, unpublished results.
153. F. Dall'Acqua, S.M. Magno, F. Zambon and G. Rodighiero, *Photochem. Photobiol.*, 29 (1979) 489.
154. N.J. de Mol and G.M.J. Beijersbergen van Henegouwen, *Photochem. Photobiol.*, 33 (1981) 815.
155. J.D. Laskin, E. Lee, E.J. Yurkov, D.L. Laskin and M.A. Gallo, *Proc. Natl. Acad. Sci. USA*, 82 (1985) 6158.
156. E.F. Travecedo and V.I. Stenberg, *Tetrahedron Lett.*, (1970) 4539.
157. R. Karlicek and V. Klimesova, *Cesk. Farm.*, 26 (1977) 413; *Chem. Abstr.*, 89 (1978) 12 047.
158. H. Auterhoff and A. Walter, *Dtsch. Apoth.-Ztg.*, 115 (1975) 1931.
159. N. Jamil, H. Afrozrizvi, I. Ahmed and A. Jazbeg, *Pharmazie*, 38 (1983) 467.
160. G.E. Wright and T.Y. Tang, *J. Pharm. Sci.*, 61 (1972) 299.
161. F. Takeuchi, T. Sugiyama, T. Fujimori, K. Seki, Y. Harada and A. Sugimori, *Bull. Chem. Soc. Jpn.*, 47 (1974) 1245.
162. I. Ninomiya and O. Yamamoto, *Heterocycles*, 4 (1976) 475.
163. H-C. Chiang and L-J. Lin, *J. Chinese Chem. Soc.*, 25 (1978) 125.
164. P.G.E. Evans, J.K. Sugden and N.J. Van Abbe, *Pharm. Acta Helv.*, 50 (1975) 94.
165. J.K. Sugden and E.J.A. Wood, *Pharm. Acta Helv.*, 56 (1981) 302.
166. R. Testa, E. Dolfini, C. Reschiotto, C. Secchi and P.A. Biondi, *Farmaco, Edn. Prat.*, 34 (1979) 463.
167. P. Pietta, A. Rava and P. Biondi, *J. Chromatogr.*, 210 (1981) 516.

168. W.A. Al-Turk, I.A. Majeed, W.J. Murray, D.W. Newton and S. Othman, *Int. J. Pharm.*, 41 (1988) 227.
169. I.A. Majeed, W.J. Murray, D.W. Newton, S. Othman and W.A. Al-Turk, *J. Pharm. Pharmacol.*, 39 (1987) 1044.
170. S. Ikeda, T. Oka, N. Ohishi and S. Fukui, *Vitamins (Japan)* 38 (1968) 109.
171. A. Yamaji, Y. Fugii, Y. Kurata, N. Onishi and E. Hirooka, *Yakuzaigaku*, 40 (1980) 143.
172. N.P. Bazhulina, M.P. Kirpichnikov, Yu.V. Morozov, F.A. Savin, L.B. Sinyavina and V.L. Florentiev, *Mol. Photochem.*, 6 (1974) 367.
173. H. Barton, J. Bojarski and J. Mokrosz, *Tetrahedron Lett.*, (1982) 2133.
174. H. Barton, Z. Aleksandra, J. Bojarski and W. Welna, *Pharmazie*, 38 (1983) 268.
175. H. Barton, J. Mokrosz, J. Bojarski and M. Klimczak, *Pharmazie*, 35 (1980) 155.
176. H. Barton and J. Bojarski, *Pharmazie*, 38 (1983) 630.
177. J. Mokrosz, A. Zurowska and J. Bojarski, *Pharmazie*, 37 (1982) 832.
178. R. Bouche, M. Draguet-Brughmans, J.P. Flandre, C. Moreaux and M. Van Meersche, *J. Pharm. Sci.*, 67 (1978) 1019.
179. R.L. Clough, B.G. Yee and C.S. Foote, *J. Am. Chem. Soc.*, 101 (1979) 683.
180. D.E. Moore and V.J. Hemmens, *Photochem. Photobiol.*, 36 (1982) 71.
181. H.H. Tonnesen, A.-L. Grislingass, S.O. Woo and J. Karlsen, *Int. J. Pharm.*, 43 (1988) 215.
182. V.I. Sternberg and E.F. Travecedo, *J. Org. Chem.*, 35 (1970) 4131.
183. G.A. Epling and U.C. Yoon, *Tetrahedron Lett.*, (1977) 2471.
184. H. Pohlmann, F.-P. Theil and H. Otto, *Pharmazie*, 41 (1986) 390.
185. F.-P. Theil, H. Pohlmann, S. Pfeifer and P. Franke, *Pharmazie*, 40 (1985) 328.
186. M.F.G. Stevens and B.C. Gunn, *J. Pharm. Pharmacol.*, 24 (1972) 141P.
187. S.R. Tamat and D.E. Moore, *J. Pharm. Sci.*, 72 (1983) 180.
188. N. Detzer and B. Huber, *Tetrahedron*, 31 (1975) 1937.
189. D.E. Moore, V.J. Hemmens and H. Yip, *Photochem. Photobiol.*, 39 (1984) 57.
190. K. Kigasawa, H. Shimizu, S. Hayashida and K. Ohkubo, *Yakugaku Zasshi*, 104 (1984) 1191; *Chem. Abstr.*, 102 (1985) 137 650.
- 190a. D.C. Palmer, J.S. Skotnicki and E.C. Taylor, *Prog. Med. Chem.*, 25 (1988) 85; A. Rosowsky, *Prog. Med. Chem.*, 26 (1989) 1.
191. D.C. Chatterji and J.F. Gallelli, *J. Pharm. Sci.*, 67 (1978) 526.
192. C. Chahidi, M. Giraud, M. Aubailly, A. Valla and R. Santus, *Photochem. Photobiol.*, 44 (1986) 231.
193. C. Chahidi, P. Morliere, M. Aubailly, L. Dubertret and R. Santus, *Photochem. Photobiol.*, 38 (1983) 317.
194. O.H. Lowry, O.A. Bessey and E.J. Crawford, *J. Biol. Chem.*, 180 (1949) 389.
195. A. Li Wan Po and W.J. Irwin, *J. Pharm. Pharmacol.*, 32 (1980) 25.
196. I. Rosenthal, E. Ben-Hur, A. Prager and E. Riklis, *Photochem. Photobiol.*, 28 (1978) 591.
197. B. Ljunggren and H. Moller, *Acta Derm.-Venereol.*, 57 (1977) 325.
199. A. Felmeister and C.A. Discher, *J. Pharm. Sci.*, 53 (1964) 756.
200. C.L. Huang and F.L. Sands, *J. Chromatogr.*, 13 (1964) 246.
201. C.L. Huang and F.L. Sands, *J. Pharm. Sci.*, 56 (1967) 259.
202. D. Sharples, *J. Pharm. Pharmacol.*, 33 (1981) 242.
203. F.W. Grant and J. Greene, *J. Toxicol. Appl. Pharmacol.*, 23 (1972) 71.
204. I.E. Kochevar and J. Hom, *Photochem. Photobiol.*, 37 (1983) 163.
205. J.E. Maruchin, *Pol. J. Pharmacol. Pharm.*, 30 (1978) 825.
206. S. Hashiba, M. Tatsuzawa and A. Ejima, *Eisei Shikensho Hokoku*, 97 (1979) 73; *Chem. Abstr.*, 93 (1980) 16 854.

207. M. Saucin and A. van de Vorst, *Radiat. Environ. Biophys.*, 17 (1980) 159.
208. J. Decuyper, J. Piette, M. Lopez, M.P. Merville and A. Van de Vorst, *Biochem. Pharmacol.*, 33 (1984) 4025.
209. A.S.W. Li and C.F. Chignell, *Photochem. Photobiol.*, 45 (1987) 695.
210. C. Schuijt, G.M.J. Beijersbergen van Henegouwen and K.W. Gerritsma, *Pharm. Weekblad, Sci. Ed.*, 1 (1979) 186.
211. W.C. Dunlap and M. Susic, *Mar. Chem.*, 19 (1986) 99.
212. G. Strauss and W.J. Nickerson, *J. Am. Chem. Soc.*, 83 (1961) 3187.
213. G. Oster, J.S. Bellin and B. Holmstrom, *Experientia*, 18 (1962) 249.
214. E.C. Smith and D.E. Metzler, *J. Am. Chem. Soc.*, 85 (1963) 3285.
215. P-S. Song, E.C. Smith and D.E. Metzler, *J. Am. Chem. Soc.*, 87 (1965) 4181.
216. G.E. Treadwell, W. Cairns and D.E. Metzler, *J. Chromatogr.*, 35 (1968) 376.
217. W. Cairns and D.E. Metzler, *J. Am. Chem. Soc.*, 93 (1971) 2772.
218. M.S. Jorns, G. Schollnhammer and P. Hemmerich, *Eur. J. Biochem.*, 57 (1975) 35.
219. O.W. Parks, *J. Assoc. Off. Anal. Chem.*, 68 (1985) 1232.
220. Y. Akira, T. Hashizunie and Y. Masuike, *Byoin Yakugaku*, 13 (1987) 298; *Chem. Abstr.*, 108 (1988) 156 339.
221. P.J.G. Cornelissen, G.M.J. Beijersbergen van Henegouwen and K.W. Gerritsma, *Int. J. Pharm.*, 1 (1978) 173.
222. D.E. Moore, *J. Pharm. Sci.*, 66 (1977) 1282.
223. H.J. Roth and M. Adomeit, *Arch. Pharm. (Weinheim)*, 306 (1973) 889.
224. P.J.G. Cornelissen and G.M.J. Beijersbergen van Henegouwen, *Photochem. Photobiol.*, 30 (1979) 337.
225. A. Bakri, G.M.J. Beijersbergen van Henegouwen and J.L. Chanal, *Photodermatology*, 2 (1985) 205.
226. P.J.G. Cornelissen, G.M.J. Beijersbergen van Henegouwen and K.W. Gerritsma, *Int. J. Pharm.*, 3 (1979) 205.
227. G.F. Field and L.H. Sternbach, *U.S. Pat.* 3 697 545 (1972); *Chem. Abstr.*, 78 (1973) 16253.
228. P.J.G. Cornelissen, G.M.J. Beijersbergen van Henegouwen and G.R. Mohn, *Photochem. Photobiol.*, 32 (1980) 653.
229. A. Bakri, G.M.J. Beijersbergen van Henegouwen and A.G.J. Sedee, *Photochem. Photobiol.*, 44 (1986) 181.
230. S. Ebel, B.M. Langer and H. Schuetz, *Mikrochim. Acta*, 2 (1977) 261.
231. S. Tammilehto and M. Lehtonen, *Acta Pharm. Suec.*, 19 (1982) 297.
232. S. Tammilehto, L. Heikkinen and P. Jarvela, *J. Chromatogr.*, 246 (1982) 308.
233. A.G. Motten, G.R. Buettner and C.F. Chignell, *Photochem. Photobiol.*, 42 (1985) 9.

This Page Intentionally Left Blank

3 Medicinal Chemistry of 1-Benzazepines

KATSUHIKO HINO, Ph.D. and JUN-ICHI MATSUMOTO, Ph.D.

*Research Laboratories, Dainippon Pharmaceutical Co. Ltd., Enoki 33-94,
Suita, Osaka 564, Japan*

INTRODUCTION	123
ACTIONS ON CENTRAL NERVOUS SYSTEM	124
ACTIONS ON CARDIOVASCULAR SYSTEM	128
Cardiotonic activity	128
Antiarrhythmic activity	128
Antihypertensive activity	130
SOME MISCELLANEOUS ACTIONS	134
SYNTHESIS	135
CONCLUDING REMARKS	138
REFERENCES	138

INTRODUCTION

The first member of the 1-benzazepine series to be described was 2,3,4,5-tetrahydro-1*H*-1-benzazepin-2-one (1, $R^1 = R^2 = H$), which was synthesized by von Braun in 1907 by cyclization of 4-(2-aminophenyl)butyric acid [1].

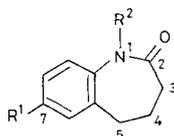

$R^1 = H, \text{ halogen};$

$R^2 = H, \text{ Me}$

(1)

Extensive studies of the chemistry of 1-benzazepines have since been developed. There are available excellent and comprehensive reviews on the chemistry of 1-benzazepines by Kasperek [2] and recently by Proctor [3], along with a brief one by Moore and Mitchell [4]. The former two cover the syntheses, reactions, physical properties and some biological activities of 1-benzazepines and their isomeric counterparts.

Many 1-benzazepines having various substituents possess interesting biological actions. It may be mentioned that most of the actions of particular interest have been reported in the past decade. Numerous 1-benzazepine derivatives fused to an additional ring, especially with an aromatic ring, have been reported to exhibit a variety of biological activities, in particular on the central nervous system; discussion on these, however, would be beyond the scope of this review. Hence, the present review surveys the literature of the medicinal chemistry of those 1-benzazepine derivatives consisting of a fused two-ring system. It sometimes refers to compounds without such framework in order to gain a better understanding of drug designs for the 1-benzazepine derivatives discussed. Although various traditional names such as homotetrahydroquinoline, benz[*b*]azepine, benz[*f*]azepine, benzo[*b*]hexamethylenimine and homodihydrocarbostyryl have been used to identify the derivatives, especially in the older literature, the systematic chemical names, tetrahydro-1-benzazepine and tetrahydro-1-benzazepin-2-one, are used in this review. We hope that the most important discoveries to mid-1988 have been covered.

ACTIONS ON CENTRAL NERVOUS SYSTEM

A simple benzazepine derivative (1, $R^1 = Cl$; $R^2 = H$) has been reported to show weak antipentylentetrazole activity in rats [5]. Other derivatives of (1) are claimed to have tranquillizing effect and antagonistic effect against both convulsions induced chemically and physically [6]. The 3-phenyl derivative of (1) [$R^1 = OMe$; $R^2 = (CH_2)_9Me$] has no significant effect on the central nervous system (CNS) [7]. Some compounds having a phenyl group at position 5 have been studied. Thus, compound (2, $R^1 = R^2 = H$; $R^3 = Me$) retains anti-convulsant activity [5], or is devoid of CNS activity [7]. An analogous difluorinated 5-phenylbenzazepine (2, $R^1 = R^2 = F$; $R^3 = H$) has been reported to have mild stimulant activity at high dosage [8].

Studies on the anxiolytic diazepam have been extended to compounds in which the imino nitrogen is replaced by a carbon function. A monoaza analogue (3) of diazepam was examined for anxiolytic activity by the antipentylentetrazole test in rats, but it was found to be inactive [5]. Two 4-methyl deriva-

tives (4) have been examined on general behaviour and are shown to have sedative properties [9]. A series of 1,2,4-triazolo[4,3-*a*]benzazepine derivatives (5) have been evaluated using the general screening method with the main emphasis to the central nervous system effects, and a variety of actions has been observed [10]. Similar triazolobenzazepines with other substituents in aromatic rings have been claimed as tranquillizers or anxiolytics [11].

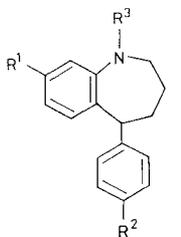
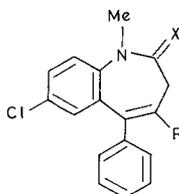
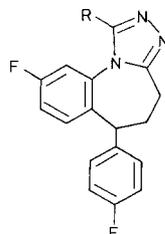
(2) $R^1 = R^2 = H, F$ (3) $R = H; X = O$ (4) $R = Me; X = O, H_2$ 

(5)

A series of 1-substituted 3-phenylbenzazepines have been evaluated. It was found that the aminopropyl derivative (6, $n = 3$; $R^1 = R^2 = Et$) counteracted amphetamine toxicity, and that the piperazinyll derivative (6) ($n = 2$; $NR^1R^2 = N(CH_2CH_2)_2 = NCH_2CH_2OH$) gave protection against maximal electroshock seizures (MES) [12]. None of the other derivatives such as the 2-oxo derivatives showed any significant effects on the central nervous or cardiovascular system, nor did any of them exhibit any diuretic or hypoglycaemic activity [12]. Several similar compounds possess antiarrhythmic and antihypertensive effects; this will be mentioned in a later section.

The 4-phenyl and 4-phenyl-2-oxo analogues of (6, $n = 3$; $R^1 = R^2 = Me$) have been reported to exhibit sedative properties [13]. Several carboxamides (7) with a 4-phenyl group have been claimed to be useful as tranquillizers [14]. A variety of central effects of the 1-substituted 5-phenyl derivatives (8) has been studied [10]. The 2-(substituted aminomethyl)tetrahydro-1-benzazepine and octahydropyrazino[1,2-*a*]-1-benzazepine derivatives have no pharmacological activity on the CNS [15]. 1-Substituted tetrahydro-1-benzazepines having an aminoalkyl group at position 3 are claimed to potentiate the activity of 5-hydroxytryptophan [16].

To search for novel neuroleptic agents, attention has been given to structural modifications of dibenzazepines such as clozapine (9) [17] as a clinically active atypical antipsychotic, and its analogous fluperlapine (10) [18, 19] with a pharmacological resemblance to clozapine. Some 2-piperazinyll-5-phenyl-

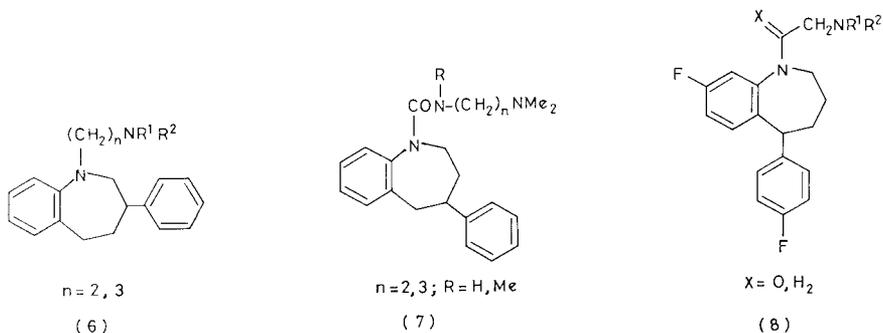

4,5-dihydro-1-benzazepines (11, $R = Me, HOCH_2CH_2$) have been prepared in view of their structural similarity to clozapine, but they are devoid of any significant CNS activity [20]. The inactivity of these compounds may be attributed to their ring system, the azepine conformation of which might be different from that of antipsychotic dibenzazepines. As another modification of dibenzazepines, a series of 2-piperazinyl-3-phenyl-5*H*-1-benzazepines (12) have been prepared and evaluated as potential antipsychotic agents [21]. Among them, the 3-(4-halophenyl) derivatives (12, $R^1 = H$; $R^2 = 4-F, 4-Cl$) were found to show potent central depressant effect, and increased brain dopamine turnover rates in animals. The most potent compound (12, $R^1 = H$; $R^2 = 4-F$; $R^3 = Me$) in this series shows the same extent of inhibition as chlorpromazine and clozapine in exploratory activity, conditioned avoidance response and self-stimulation tests. This compound inhibited, in particular, induced emesis more significantly than the above reference drugs. In this action, the 4-chloro isomer (12, $R^1 = H$; $R^2 = 4-Cl$; $R^3 = CH_2CH_2OH$) with the best activity was 16-times more potent than chlorpromazine. It was suggested that these benzazepine derivatives exert a CNS depressant effect through a possible antidopaminergic property. They may be expected to show few side-effects due to their low cataleptogenic and ptotic potential. Considering their CNS depres-

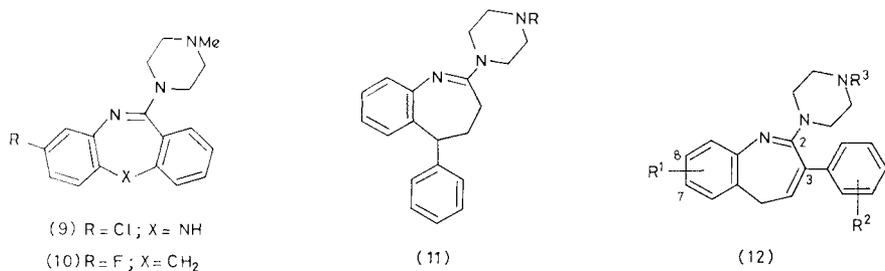

sion profile, however, they seem to be substantially closer to chlorpromazine than to clozapine. This feature may be attributed to their halogenated position, which is not in accordance with that of clozapine or fluperlapine and is rather closer to that of chlorpromazine.

In contrast to these neuroleptic properties, introduction of a chlorine, bromine or lower alkyl group into position 7 of (12) brings about potent anti-maximal electroshock seizure and anti-tremorine activities. Several compounds of this class inhibit convulsions induced both electrically and chemically (pentylenetetrazole). The potency of the most active compound (12, $R^1 = 7\text{-Br}$; $R^2 = \text{H}$; $R^3 = \text{Me}$, $\text{CH}_2\text{CH}_2\text{OH}$) is close to that of carbamazepine, a clinically useful antiepileptic. The order of increasing potency with R^1 is H , $\text{F} < \text{Me}$, $\text{Cl} < \text{Br}$. The 5*H*-1-benzazepine system of (12) is assumed to have the same conformation as that of dibenzazepines. A series of these compounds (12) have been claimed as CNS agents [22], but the eight-membered 5,6-dihydro-benzazocine analogues have been found not to show any significant effect on the CNS [23].

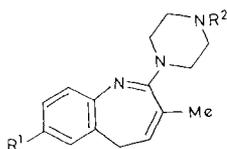

(13)

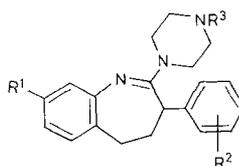

(14)

The 3-methyl (13) and 4,5-dihydro-3*H*-3-phenyl (14) derivatives, as analogues of (12), have been prepared [23]. It has been found that several derivatives of the former analogue (13) show a mild anti-reserpine activity ($R^1 = \text{H}$; $R^2 = \text{H}$, Me , Et , $\text{CH}_2\text{CH}_2\text{OH}$) or potent antagonism against induced-tremor ($R^1 = \text{H}$; $R^2 = \text{Me}$); however, no significant suppression of exploratory activity and of induced convulsions was found for them. Some analogues of (14) possess weak anti-reserpine ($R^1 = \text{Cl}$; $R^2 = \text{H}$; $R^3 = \text{Me}$, $R^1 = \text{H}$; $R^2 = 4\text{-Cl}$; $R^3 = \text{Ph}$, $R^1 = \text{Cl}$; $R^2 = 4\text{-Cl}$; $R^3 = \text{Me}$), anti-exploratory ($R^1 = \text{Cl}$; $R^2 = 4\text{-Cl}$; $R^3 = \text{Me}$) or antitremorine ($R^1 = \text{H}$; $R^2 = 4\text{-Cl}$; $R^3 = \text{Me}$) activity. These findings [21, 23] indicate that, in this class of compounds, the benzazepine skeleton with a 3-halophenyl group and the conjugated 3,4-double bond is essential for a potent neuroleptic effect [23]. On the other hand, replacement of the piperazinyl group of (14) with primary amino groups results in hypoglycaemic activity, as described later [7].

ACTIONS ON CARDIOVASCULAR SYSTEM

CARDIOTONIC ACTIVITY

The most salient pathophysiological features of congestive heart failure (CHF) are diminution of ventricular contractility and profound, sympathetically mediated vasoconstriction. Agents with both peripheral vasodilating [24] and positive inotropic [25] activities ameliorate the symptoms of CHF. 4-(3-Pyridazinylphenyl)acetamides (15) possess more *in vitro* and *in vivo* inotropic activity than milrinone (1,6-dihydro-2-methyl-6-oxo(3,4'-bipyridine)-5-carbonitrile) [26], which is a cardiotonic of a new generation with dual (inotropic and vasodilator) activities. This finding prompted the synthesis of a series of 7-pyridazinylbenzazepin-2-ones (16) in which the *p*-acetamido sub-

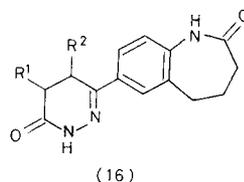
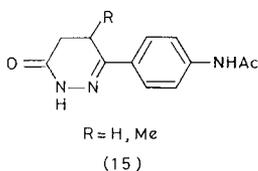

stituent of the compounds (15) was incorporated in the lactam ring. Among them, compound (16, $R^1 = R^2 = H$) was found to have a more potent positive inotropic effect than milrinone and the indol-2-one analogue of (16) in anaesthetized dogs, but less potent than the quinolin-2-one analogue of (16) [27]. Some 2-(2-oxobenzazepin-7-yl)-3,4-diazabicyclo[4,*n*,0]alk-2-en-5-ones (16) [$R^1, R^2 = (CH_2)_n; n = 1-3$] have been claimed to have positive inotropic and coronary vasodilating activities and as possible agents for the treatment of cardiac insufficiency [28]. 1-(2-Imidazolylmethyl)benzazepine, the dephenyl analogue of antiarrhythmic compounds described later, has been claimed to have cardiotonic properties [29].

ANTIARRHYTHMIC ACTIVITY

As an extension of the previous study of the 5,6-dihydromorphanthridine analogues, a series of benzazepines with an imidazolylmethyl group at position 1 and analogous compounds have been synthesized and examined for antiarrhythmic activity (antifibrillatory activity in unanaesthetized cats) [30]. Reduction of the 2-carbonyl group of the 3-phenyl derivatives (17, X = O) to a methylene group (17, X = H₂) enhanced antiarrhythmic activity. This activity

is retained when the imidazoline ring is substituted by a methyl group at position 4 or enlarged to a tetrahydropyrimidine ring. Introduction of chlorine into the 3-phenyl ring caused a considerable increase in the activity. Among them, the 3-(4-chlorophenyl) derivative (17, SU-13197, X = H₂; R = 4-Cl) exhibited a high potency and had relatively broad therapeutic range [31, 32]. The fate of SU-13197 in rat and man has been reported [33]. A number of the 2-deoxo derivatives were described in the patents [34, 35].

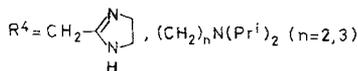
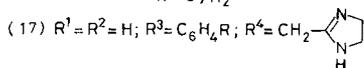
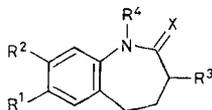

The antiarrhythmic activity of a series of 1-(2-imidazolyl)methyl- and 1-(substituted aminoalkyl)tetrahydrobenzazepines and their 2-oxo derivatives (18) has been studied [36]; the most favourable ratio of antiarrhythmic activity (chloroform-induced fibrillation test in mice) to toxicity is given by (18) ($R^1 = R^2 = R^3 = H$; $X = O$; $R^4 = (CH_2)_3NiPr_2$), which is, however, less effective than ajmaline hydrochloride, diisopramide hydrochloride and quinidine sulphate against the arrhythmias caused by the combined injection of light petroleum and adrenaline into guinea-pigs. Although almost all compounds have the activity in some degree, they also produce epileptoid syndrome in conscious dogs and they are devoid of psychodepressant activity in mice. The structure-activity study reached the following conclusion: when R^1 or R^2 is MeO, both activity and toxicity decrease; when $R^3 = 4\text{-}ClC_6H_4$, both activity and toxicity generally increase; when $R^4 = (CH_2)_3NiPr_2$, antiarrhythmic activity is the most potent.

The analogous 4- (19, X = H₂) and 5-phenyltetrahydro-1-benzazepines are less active than the 3-phenyl isomers [30]. The corresponding 4-phenylbenzazepin-2-one (19, X = O) shows moderate antiarrhythmic activity [30] and is claimed to be useful for the treatment of neurogenic or carcinogenic auricular and ventricular fibrillation and as an antihistaminic or local anaesthetic agent [37]. Introduction of an aminoalkyl group, such as 2-piperidinyl-

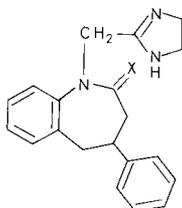

X = O, H₂
(19)

ethyl and 3-dimethylaminopropyl group, at position 1 of the 5-phenyltetrahydrobenzazepine skeleton caused a complete loss of activity [30].

ANTIHYPERTENSIVE ACTIVITY

The development of therapeutically effective inhibitors of angiotensin-converting enzyme (ACE, dipeptidyl carboxypeptidase, E C 3.4.15.1) has led to significant advances in the treatment of hypertension. Captopril (20) was the first orally effective ACE inhibitor [38, 39] and has become established as a useful agent for the treatment of hypertension and CHF [40, 41]. Because of a significant incidence of side-effects associated with captopril therapy, extensive efforts have been made to prepare more potent inhibitors that might offer a greater therapeutic ratio, for example, modifications of the side-chain [42] and reconstructions of the ring to a monocyclic or fused lactam. Efforts leading to the design of potent compounds with new ring systems might arouse interest.

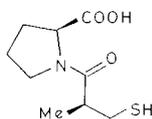

(20)

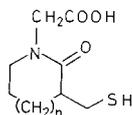

n = 0-3
(21)

Rupture of the pyrrolidine ring of captopril and reconstruction of the lactam ring result in compounds (21) with a carboxymethyl group at N-1 [43-45]. The mercaptomethyl group of (21) at position 3 was chosen, because it is the simplest of zinc ligands for ACE [46]. Testing the ACE-inhibitory potencies of (21) has revealed that the potency varied with lactam ring size in a manner predicted from molecular modelling studies [46]. Thus, both pyrrolidinone (21,

$n = 0$) and piperidinone (21, $n = 1$) derivatives showed low activity, whereas the azepinone isomer (21, $n = 2$) exhibited a good activity. The homologated azocinone isomer (21, $n = 3$) showed the highest potency in this series, but was less active than captopril.

The observation that severe non-bonded interactions would occur between the methyl group and C-5 of the pyrrolidine ring of captopril and the fact that the indoline analogue (22) [47, 48] was more potent than the parent captopril led to another approach. Thus, a series of bicyclic lactams (23) which were the conformationally restricted analogues of (21) were prepared and tested [43]. The benzazepine derivative (23, $n = 2$) exhibited a significant ACE-inhibitory activity, which was more potent than that of captopril. However (23, $n = 2$) was slightly less active than the eight-membered benzazocine analogue (23, $n = 3$) and the indoline (22).

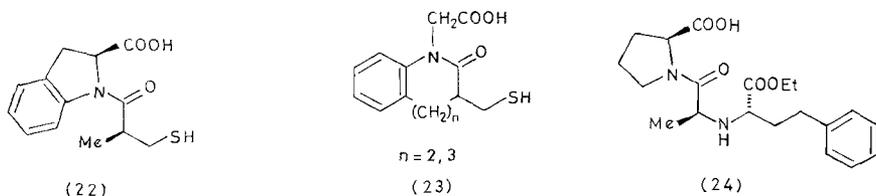

It was suggested that the mercapto function of captopril might be a contributing factor to the incidence of side-effects associated with captopril therapy [40]. On this account, enalapril (MK-421, 24) a non-thiol inhibitor derived from replacing the thiomethyl group of captopril with a glycine derivative, has been developed as an important therapeutic agent for the treatment of hypertension and CHF [42]. Although studies reported on the clinical application of enalapril are not as extensive as those with captopril, indications are that the incidence of side-effects is low [49–51]. The monocyclic (25) and conformationally more restricted benzofused lactams (26) [52, 54] were also synthesized and tested for their inhibitory activities *in vitro*. In the former series (25) [52, 53], the eight-membered lactam (25, $n = 3$) was 4-times more potent than the seven-membered isomer (25, $n = 2$) which has a comparable potency with that of captopril (20). For effective binding to the active site of ACE (and the related zinc peptidase), an inhibitor or substrate should possess properly oriented primary binding functionality (a zinc ligand, a hydrogen bond accepting carbonyl group, and a carboxyl group), as well as correctly oriented hydrophobic groups for subsite recognition [39, 42, 55]. These features were found to be well accommodated by the 7–9-membered lactams. The lactam design principle for

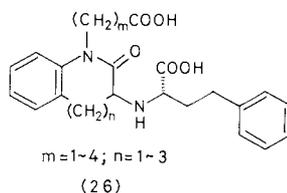
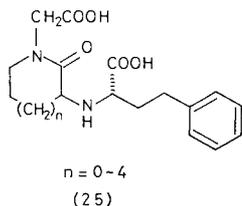

ACE inhibitors has been extended successfully to benzofused lactams (26). Inclusion of the fused aromatic ring of (26) was intended to increase the hydrophobic binding at subsite S_2' [52]. Two fused lactams, namely tetrahydrobenzazepinone (26, $m = 1$; $n = 2$) and hexahydrobenzazocinone (26, $m = 1$; $n = 3$) derivatives, were more effective (by approximately three orders of magnitude) than the tetrahydroquinolinone analogue (26, $m = n = 1$) [52, 54]. The IC_{50} values of these compounds were in a low nanomolar region and similar to that of the monocyclic isomer (25, $n = 3$).

The effect of variation in the N-1 side-chain of (26) on activity was also examined [52]. In the benzazepinone series (26, $n = 2$), no loss of activity occurred on extension of the side-chain from acetic acid ($m = 1$) to propanoic acid ($m = 2$). The butanoic acid homologue ($m = 3$) resulted in only a slight decrease in activity, whereas the next higher homologue ($m = 4$) became 1000-fold less active. These results imply unexpected degrees of freedom at the carboxyl binding site.

Some optically active compounds have been studied [54]. The benzazepinone diacid (CGS 12831, 27) was found to have the best *in vitro* inhibitor potency in a series of lactam compounds, but it showed only marginal biological activity following oral administration, presumably because of poor absorption. The corresponding monoethyl ester (CGS 14824A, 28) was much more potent *in vivo* [54, 56]. This compound (28) was found to produce dose-dependent antihypertensive effects in conscious normotensive and spontaneous hypertensive rats, generally similar to those produced by enalapril. Evaluation of (28) in healthy volunteers [57, 58] shows that it is an effective,

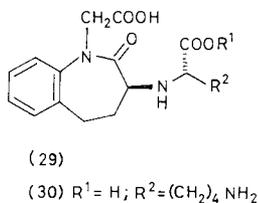
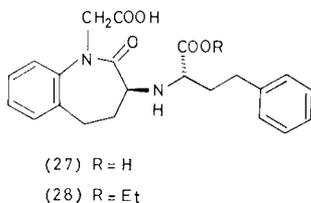

orally active, long-lasting and well-tolerated ACE inhibitor. The synthesis of ^{14}C -labelled (28) have been reported [59]. A series of compounds, including (27) and (28) and those possessing an oxygen function at position 5, have been claimed to have hypotensive activity [60–63].

The effect of replacement of the side-chain of (29) with a variety of L-amino acids was studied [64]. It was shown that alkyl, heteroalkyl or aralkyl groups (as short as a *n*-propyl group, as long as $(\text{CH}_2)_4\text{NHCOOCH}_2\text{Ph}$ group, or as bulky as $(\text{CH}_2)_4\text{NHCOO}^t\text{Bu}$) provide effective substrates for binding to ACE. It appeared that the S_1 subsite of the ACE-active site [55] did not have a specific structural requirement. Among the series of (29), the compound (CGS 16617, 30) was found to have promising ACE activity in rats and dogs with an indication of a long duration of action. The synthesis of ^{14}C -labelled and two stable isotope-labelled analogues of (30) have been reported [65]. It is of interest that this compound has good *in vivo* activity, even without an ester function for improving the absorption. This is reminiscent of lisinopril [66, 67], which has the same aminobutyl group. 1-Guanidinoethylbenzazepine (31) shows antihypertensive activity [68] and is claimed as an antihypertensive in a patent [69]. The 7-substituted derivative (32) has also been claimed as an antihypertensive [70]. Some benzazepinones bearing a triazine moiety at position 8 were claimed to have hypotensive and blood platelet aggregation-inhibitor activities [71]. Several 1-substituted 3- (33) and 4-phenylbenzazepinones (34, $\text{R}^3 = \text{H}$), reminiscent of the antiarrhythmic compound (18), have been claimed as hypotensives [72, 73]. Analogous benzazepines (34) with a variety of ether or acyloxy moieties [74] and those with a variety of alkyl or aralkyl moieties [75] at each position 3 have been claimed as vasodilators and antihypertensives and as cardiovascular agents, respectively.

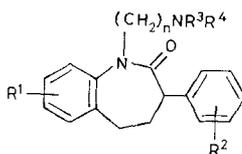
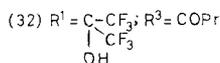
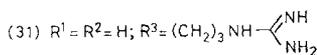
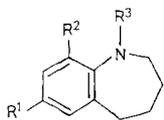

(33)

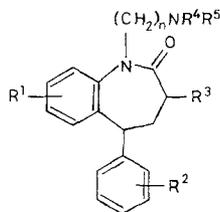

$n = 2, 3$
(34)

SOME MISCELLANEOUS ACTIONS

Various compounds bearing a carboxymethyl group at position 1 and a carboxymethylamino function at position 3, including ACE inhibitors (27, 28), have been claimed as cholecystokinin (CCK)-antagonists [76–78]. Analogous compounds with a 3-hydroxy-2-oxopropyl moiety at position 1 are also claimed to be useful as antihypertensives and CCK antagonists [79].

The 3-phenyl-1-(piperazinyl)ethyl derivative (6) ($n = 2$; $\text{NR}^1\text{R}^2 = \text{N}(\text{CH}_2\text{CH}_2)_2\text{NCH}_2\text{CH}_2\text{OH}$) has been reported to antagonize the action of 5-hydroxytryptamine (serotonin) [12]. The 5-phenyl derivative (2, $\text{R}^1 = \text{R}^2 = \text{F}$; $\text{R}^3 = \text{H}$) has been claimed to have anorectic and antimicrobial activity orally in mice [80]. The 2-oxo analogue of (2, $\text{R}^1 = \text{R}^2 = \text{F}$; $\text{R}^3 = \text{H}$) showed hypoglycaemic activity [8] and was also patented [80]. Their *in vitro* antimicrobial activity was weak [8]. Several similar compounds (8) with an amine function at position 1 have been claimed to have various pharmacological activities such as antispasmodic, anti-inflammatory, hypotensive, positive inotropic, local anaesthetic and antireserpine activities [81]. Some 1-substituted 5-phenyl derivatives (35) have been claimed to have gastric antisecretory activity [5, 82]. The 4,5-dihydro analogues of (35, $\text{R} = \text{H}$; $n = 2,3$) also showed similar properties [5].

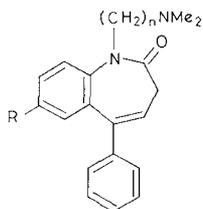

$\text{R} = \text{H, Cl}; n = 2, 3$
(35)

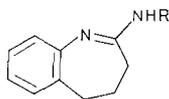

(36)

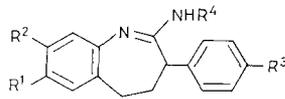

(37)

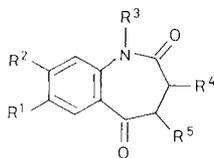

(38)

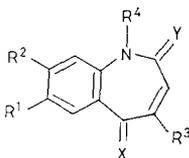

$X, Y = \text{O, S, NR, CHR}$
(39)

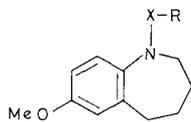

$X = \text{CO, SO}_2$
(40)

Some 2-amino derivatives (36) have been reported to show local anaesthetic, parasympathomimetic, long-lasting myorelaxant, brief hypotensive and mild antiarrhythmic activities [83]. Analogous cyclic amidines (37) with a 3-phenyl group were examined for potential hypoglycaemic agents [7]. Ten of 16 compounds showed weak to moderate activity in the rat. The most active compound was (37, $R^1 = \text{OMe}$; $R^2 = R^3 = \text{H}$, $R^4 = \text{cyclopropyl}$), although it was less active than tolbutamide [84].

Tetrahydrobenzazepin-2,5-diones (38, $R^1 = R^2 = R^3 = R^5 = \text{H}$) with a cyclic amine at position 3 have been claimed to have bactericidal activity [85]. A number of similar diones with a 4-carbamoyl group (38, $R^4 = \text{H}$) have been claimed to possess anti-inflammatory activity [86, 87]. Several 1*H*-2,5-dihydrobenzazepine derivatives (39), including the antiallergic 2,5-dione (39, $R^1 = R^2 = R^3 = R^4 = \text{H}$; $X = Y = \text{O}$), have been claimed [88]. A number of 1-acyl and sulphonyl derivatives (40) have been prepared and claimed for use as diuretic, hypoglycaemic, antibacterial and anticonvulsant agents [89]. 1-Cyclopropyl-7-methoxytetrahydrobenzazepine, its 5-methyl and 5,5-dimethyl analogues have been synthesized and evaluated for analgesic activity as congeners of 2-benzazepines; however, they were found to possess no significant activity [90]. Some benzazepin-2-one derivatives with a substituted aminoalkyl group at position 1 have been claimed to have analgesic activity [91]. A series of 2,5-diones have been examined for antitumour activity on Crocker sarcoma 180 [92]. Two compounds, (38, $R^1 = R^2 = \text{Me}$; $R^3 = R^4 = R^5 = \text{H}$) and the 3,4-dehydro isomer (39, $R^1 = R^2 = \text{Me}$; $R^3 = R^4 = \text{H}$; $R^5 = 4\text{-NHC}_6\text{H}_4\text{NMe}_2$; $X = Y = \text{O}$), showed activity comparable with that produced by triethanmelamine (triethylenemelamine).

SYNTHESIS

A variety of synthetic methods for 1-benzazepines has been reported and comprehensively reviewed [2, 3]. In this section, the main methods which appear to be of preparative value in the synthesis of 1-benzazepines are summarized.

The earliest synthetic method for 1-benzazepine derivatives was a ring closure of *o*-substituted anilines by C-N bond formation. Cyclization of 4-(2-aminophenyl)butanoic acid and the corresponding butyl chloride gave the lactam (1, $R^1 = R^2 = \text{H}$) [1] and the 2-deoxo analogue [93], respectively. Thermal cyclization of (41, $R^1 = R^2 = \text{Me}$; $R^3 = \text{OH}$) gives 2,5-dioxobenzazepines (38, $R^1 = R^2 = \text{Me}$; $R^3 = R^4 = R^5 = \text{H}$) [94]. Treatment of analogous esters with sodium hydride gives the derivatives of (38) [9, 95].

Similarly, dimethyl [2-(2-aminophenyl)-1-phenyl]ethylmalonates undergo ring closure to give 3-methoxycarbonyl-4-phenylbenzazepin-2-ones on treatment with sodium methoxide [75].

Allylic carbinols (42, $R^1, R^3 = \text{Me, Et}$; $R^2, R^4 = \text{H, Me}$) can be satisfactorily cyclized to the corresponding benzazepines (43) by C-C bond formation in dilute hydrochloric acid [96, 97]. On treatment with sulphuric acid, the *N*-tosylates (44, $R^1 = \text{H, Cl}$; $R^2 = \text{H, Me}$) afford 3-oxobenzazepines (45, $R^1 = \text{H, Cl}$; $R^2 = \text{H, Me}$) [16, 98]. The ketal derivative (46, $R = \text{H}$) of aniline reacts with 1-methoxy-2-buten-3-one to give the enamine adduct (46, $R = \text{CH=CHCOMe}$), which undergoes ring closure in acidic media to give the 1*H*-benzazepine (47) [99]. The Dieckmann cyclization of the diesters (48) ($R^1 = \text{H, Cl, 4,5-(MeO)}_2$; $R^2 = \text{tosyl, Ac, Me}$; $R^3, R^4 = \text{Me, Et}$) with a catalyst

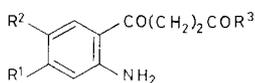

(41)

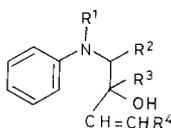

(42)

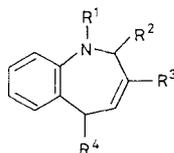

(43)

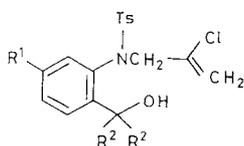

(44)

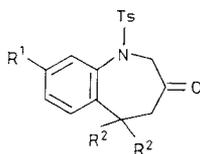

(45)

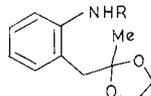

(46)

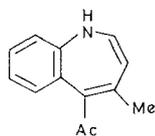

(47)

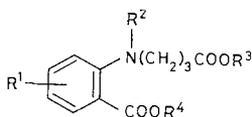

(48)

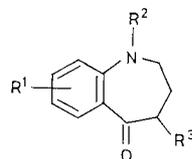

(49)

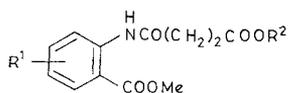

(50)

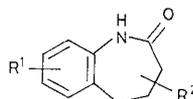

(51)

of KOtBu [100, 101], sodium hydride [102, 103] or sodium [104] proceed satisfactory to yield the corresponding 5-oxobenzazepines (49, $\text{R}^3 = \text{COOMe}$, COOEt), which can easily be decarboxylated to (49, $\text{R}^3 = \text{H}$). A similar cyclization successfully converts the diesters (50, $\text{R}^1 = \text{H}, 4\text{-Cl}, 5\text{-Cl}, 5\text{-F}, 5\text{-OMe}$; $\text{R}^2 = \text{Me}, \text{Et}$) to 2,5-dioxo-4-carboxylates (38, $\text{R}^1 = \text{H}, \text{Cl}, \text{F}, \text{OMe}$; $\text{R}^2 = \text{H}, \text{Cl}$; $\text{R}^3 = \text{R}^4 = \text{H}$; $\text{R}^5 = \text{COOMe}$, COOEt) [86, 87]. Anthranilic esters conveniently condense with succinic diesters to give (38, $\text{R}^1 = \text{R}^2 = \text{R}^3 = \text{R}^4 = \text{H}$; $\text{R}^5 = \text{COOMe}$, COOEt) by a concurrent formation of C-N and C-C bonds [105, 106].

The most widely used route to 1-benzazepin-2-ones involves the Beckmann or Schmidt reaction of the easily accessible 1-tetralones. Many biologically active compounds described in this review have been prepared on the basis of these reactions; they have been fully reviewed [2]. In the Beckmann reaction of 1-tetralone oximes, polyphosphoric acid is used as a catalyst-solvent in most instances. Aryl migration generally takes precedence over alkyl migration under these reaction conditions, and various 1-tetralone oximes substituted on the aromatic and/or aliphatic rings can be converted to the appropriate 2,3,4,5-tetrahydro-1*H*-1-benzazepin-2-ones (51) [5, 20-23, 36, 59, 65, 80, 107-112]. Both courses of the rearrangement occur in some instances, yielding 1-benzazepin-2-ones (51) and the isomeric 2-benzazepine-1-ones, probably due to electronic effects of the substituents [90, 113, 114].

The Schmidt reaction is also applied to a variety of 1-tetralones, yielding (51). The use of sodium azide in acetic acid and sulphuric acid [7, 12, 13, 30, 34, 36, 37, 72, 73, 84] is preferable to the procedure in the earlier stage, in which hydrazoic acid, sulphuric acid and chloroform are employed [115]. Other acidic reagents such as polyphosphoric acid [116, 117], sulphuric acid [116, 118], methanesulphonic acid [119] and trichloroacetic acid [116] are used in some cases. Variation of substituents affects the course of the rearrangement; 6-methoxytetralones are rather liable to afford the isomeric 2-benzazepine-1-ones in preference to the desired (51) [7, 116, 118]. The Schmidt reaction is also conveniently applied to various 1,4-naphthoquinones and yields a wide range of 2,5-dihydro-1-benzazepin-2,5-diones [85, 120-122].

Some other ring expansions involving the intramolecular amino Claisen rearrangement of vinylarylaziridine [123], the Diels-Alder reaction of indoles with acetylene derivative [124-127] and the dibromocarbene insertion into quinoline enol ethers [128] have been used to prepare 1-benzazepines. On the other hand, treatment of 3-chloro-3-phenyl-1,2,3,4,5,6-hexahydro-1-benzazocin-2-ones with piperidine causes a ring contraction to give 2-phenyl-2-(1-piperidinylcarbonyl)-2,3,4,5-tetrahydro-1*H*-1-benzazepines in an excellent yield [23].

CONCLUDING REMARKS

A number of 1-benzazepine derivatives show a variety of biological activities. Among them, of particular interest are central depressant (12) [21], cardiotoxic (16) [27], antiarrhythmic (17, 18) [30, 36] and ACE-inhibitory (23, 26) [52, 55] benzazepines. However none of them has yet reached the goal. The most promising agents are (28) [54, 57] and (30) [64], both ACE inhibitors are now undergoing clinical evaluation.

REFERENCES

1. J. von Braun, *Chem. Ber.*, 40 (1907) 1834.
2. S. Kasperek, *Adv. Heterocycl. Chem.* 17 (1974) 45.
3. G.R. Proctor, in *The Chemistry of Heterocyclic Compounds, Azepines*, ed. A. Rosowsky (John Wiley, New York) Vol. 43, Part 1 (1984) p. 652.
4. J.A. Moore and E. Mitchell, in *Heterocyclic Compounds*, ed. R.C. Elderfield (John Wiley, New York) Vol. 9 (1967) p. 224.
5. B. Loev, R.B. Greenwald, M.M. Goodman and C.L. Zirkle, *J. Med. Chem.* 14 (1971) 849.
6. Societa Farmaceutici Italia, *Br. Pat.* 1, 359, 285; *Chem. Abstr.*, 81 (1974) 152031.
7. L.I. Barsky and W.L. Bencze, *J. Med. Chem.*, 14 (1971) 40.
8. M. Rajsner, Z. Kopicova, J. Holubek, E. Svatek, J. Metys, M. Bartosova, F. Miksik and M. Protiva, *Collect. Czech. Chem. Commun.*, 43 (1978) 1760.
9. S. Rossi, M. Micheli, M. Giannotti and A. Slavatori, *Gazz. Chim. Ital.*, 111 (1981) 365.
10. Z. Vejdelek, E. Svatek, J. Holubek, J. Metys, M. Bartosova, and M. Protiva, *Collect. Czech. Chem. Commun.*, 46 (1981) 148.
11. R. Borer, M. Gerecke and E. Kyburz, *Eur. Pat. Appl. EP 72, 029*; *Chem. Abstr.*, 99 (1983) 5633.
12. J.M. Khanna and A. Nitya, *J. Med. Chem.*, 10 (1967) 944.
13. J. Krapcho and C.F. Turk, *J. Med. Chem.*, 9 (1966) 191.
14. J. Krapcho, *U.S. Pat.* 3, 748, 321; *Chem. Abstr.*, 79 (1973) 92303.
15. K. Bhandari, V. Aruna Murti and N. Anand, *Indian J. Chem., Sect. B*, 25B (1984) 1231.
16. L. Nedelec, D. Frechet, C. Dumont and M.H. Kannengiesser, *Ger. Offen.* 2, 714, 442; *Chem. Abstr.*, 88 (1978) 22674.
17. H. Gross and E. Langner, *Arzneim.-Forsch.*, 19 (1977) 496.
18. E. Eichenberger, *Arzneim.-Forsch.*, 34 (1984) 110.
19. K.A. Fischer-Cornelissen, *Arzneim.-Forsch.*, 34 (1984) 125.
20. M.J. Kukla, *J. Heterocycl. Chem.*, 14 (1977) 933.
21. K. Hino, Y. Nagai, H. Uno, Y. Masuda, M. Oka and T. Karasawa, *J. Med. Chem.*, 31 (1988) 107.
22. K. Hino, Y. Nagai, H. Uno and T. Karasawa, *Jpn. Kokai* 62 212, 372; *Chem. Abstr.*, 108 (1988) 167502.
23. K. Hino, Y. Nagai and H. Uno, *Chem. Pharm. Bull.*, 36 (1988) 2386.
24. B. Massie, T. Ports, K. Chatterjee, W. Parmley, J. Ostland, J. O'Young and F. Haughom, *Circulation*, 63 (1981) 269.
25. K.T. Weber, *Am. J. Med.*, 72 (1982) 665.

26. B.E. Jaski, M.A. Fifer, R.F. Wright, E. Braunwald and W.S. Colucci, *J. Clin. Invest.*, 75 (1985) 643.
27. D.W. Robertson, J.H. Krushinski, E.E. Beedle, V. Wyss, G.D. Pollock, H. Wilson, R.F. Kauffman, F. Raymond and J.S. Hayes, *J. Med. Chem.*, 29 (1986) 1832.
28. K.H. Geiss, M. Thyges, H. Koenig, H.D. Lehmann, M. Traut, J. Gries and P.A. Rossy, *Ger. Offen. DE 3, 535, 170*; *Chem. Abstr.*, 107 (1987) 70811.
29. D. Zivkovic, *Ger. Offen.* 1, 905, 525; *Chem. Abstr.*, 72 (1970) 12784.
30. L.H. Werner, S. Ricca, A. Rossi and G. deStevens, *J. Med. Chem.*, 10 (1967) 575.
31. W.E. Barrett, T. Garces, R. Rutledge and A.J. Plummer, *Pharmacologist*, 7 (1965) 229.
32. W.E. Barrett, T. Garces and A.J. Plummer, *Arch. Int. Pharmacodyn. Ther.*, 182 (1969) 65.
33. G.D. Shand, J.H. Cavanaugh and J.A. Oates, *Clin. Pharmacol. Ther.*, 12 (1971) 769.
34. A. Rossi, L.H. Werner, W.L. Bencze and G. deStevens, *Fr. Pat. M3273*; *Chem. Abstr.*, 65 (1966) 2272.
35. A.P.A. Rossi, L.H. Werner, W.L. Bencze and G. deStevens, *U.S. Pat.* 3, 332, 951; *Chem. Abstr.*, 67 (1967) 100138.
36. J. Huet, M. Sado-Odeye, M. Martin, P. Guibet, Ph. Linee, P. Locroix and P. Quiniou, *Eur. J. Med. Chem.-Chim. Ther.*, 9 (1974) 376.
37. L.H. Werner, *U.S. Pat.* 3,312,691; *Chem. Abstr.*, 68 (1968) 49473.
38. M.A. Ondetti, B. Rubin and D.W. Cushman, *Science (Washington, DC)*, 196 (1977) 441.
39. D.W. Cushman, H.S. Cheung, E.F. Sabo, M.A. Ondetti, *Biochemistry*, 16 (1977) 5484.
40. R.C. Heel, R.N. Brogden, T.M. Speight and G.S. Avery, *Drugs*, 20 (1980) 409.
41. J.A. Romankiewicz, R.N. Brogden, R.C. Heel, T.M. Speight and G.S. Avery, *Drugs*, 25 (1983) 6.
42. A.A. Patchett, E. Harris, E.W. Tristram, M.J. Wyvratt, M.T. Wu, D. Taub, E.R. Peterson, T.J. Ikeler, J. ten Broeke, L.G. Payne, D.L. Ondeyka, E. D. Thorsett, W.J. Greenlee, N.S. Lohr, R.D. Hoffsommer, H. Joshua, W.V. Ruyle, J.W. Rothrock, S.D. Aster, A.L. Maycock, F.M. Robinson, R. Hirshmann, C.S. Sweet, E.H. Ulm, D.M. Gross, T.C. Vassil and C.A. Stone, *Nature (London)*, 288 (1980) 280.
43. J.W.H. Watthey, T. Gavin and M. Desai, *J. Med. Chem.*, 27 (1984) 816.
44. S. Klutchko, M.L. Hoefle, R.D. Smith, A.D. Essenburg, R.B. Parker, V.L. Nemeth, M.J. Ryan, D.H. Dugan and H.R. Kaplan, *J. Med. Chem.*, 24 (1981) 104.
45. M.E. Condon, E.W. Petrillo, D.E. Ryono, J.A. Reid, R. Neubeck, M. Puar, J.E. Heikes, E.F. Sabo, K.A. Losee, D.W. Cushman and M.A. Ondetti, *J. Med. Chem.*, 25 (1982) 250.
46. E.D. Thorsett, E.E. Harris, S. Aster, E.R. Peterson, D. Taub, A.A. Patchett, E.H. Ulm and T.C. Vassil, *Biochem. Biophys. Res. Commun.*, 111 (1983) 166.
47. D.H. Kim, C.J. Guinosso, G.C. Buzby, D.R. Herbst, R.J. McCaully, T.C. Wicks and R.L. Wendt, *J. Med. Chem.*, 26 (1983) 394.
48. J.L. Stanton, N. Gruenfeld, J.E. Babiarez, M.H. Ackerman, R.C. Friedmann, A.M. Yuan and W. Macchia, *J. Med. Chem.*, 26 (1983) 1267.
49. R.J. Cody, *Drugs*, 28 (1984) 144.
50. J.H. Bauer, *Am. J. Med.*, 77 (1984) 43.
51. D.N. Sharpe, J. Murphy, R. Coxon, S.F. Hannan, *Circulation*, 70 (1984) 271.
52. W.H. Parsons, J.L. Davidson, D. Taub, S.D. Aster, E.D. Thorsett, A.A. Patchett, E.H. Ulm and B.I. Lamont, *Biochem. Biophys. Res. Commun.*, 117 (1983) 108.
53. E.D. Thorsett, E.E. Harris, S.D. Aster, E.R. Peterson, J.P. Snyder, J.P. Springer, J. Hirshfield, E.W. Tristram, A.A. Patchett, E.H. Ulm and T.C. Vassil, *J. Med. Chem.*, 29 (1986) 251.

54. J.W.H. Watthey, J.L. Stanton, M. Desai, J.E. Babiarez and B.M. Finn, *J. Med. Chem.*, 28 (1985) 1511.
55. E.W. Petrillo, Jr. and M.A. Ondetti, *Med. Res. Rev.*, 2 (1982) 1.
56. D. Miller, M.F. Hopkins, S.T. Tonnesen and B.E. Watkins, *Pharmacologist*, 25 (1983) 102.
57. G. Waeber, T. Fasanella d'Amore, J. Nusaberger, B. Waeber and H.R. Brunner, *Eur. J. Clin. Pharmacol.*, 31 (1987) 643.
58. M. Bellet, P. Sassano, T. Guyenne, P. Corvol and J. Menard, *Br. J. Clin. Pharmacol.*, 24 (1987) 465.
59. N.K. Chaudhuri, R. Patera, B. Markus and M.S. Sung, *J. Labelled Compd. Radiopharm.*, 24 (1987) 1177.
60. J.W.H. Watthey, *Eur. Pat. Appl. EP 72, 352*; *Chem. Abstr.*, 99 (1983) 53621.
61. J.W.H. Watthey, *U.S. Pat. 4, 410, 520*; *Chem. Abstr.*, 100 (1984) 34427.
62. J.W.H. Watthey, *U.S. Pat. 4, 473, 575*; *Chem. Abstr.* 102 (1985) 113326.
63. J.W.H. Watthey, *U.S. Pat. 4, 575, 503*; *Chem. Abstr.* 105 (1986) 42673.
64. J.L. Stanton, J.W.H. Watthey, M.N. Desai, B.M. Finn, J.E. Babiarez and H.C. Tomaselli, *J. Med. Chem.*, 28 (1985) 1603.
65. N.K. Chaudhuri, B. Markus and M.S. Sung, *J. Labelled Compd. Radiopharm.*, 25 (1988) 739.
66. H.H. Rotmensch, M. Vincent, P.H. Vlasses, B.N. Swanson, J.D. Irvin, M. Hichens, K.E. Harris and R.K. Ferguson, *Fed. Proc.*, 43 (1984) 1333.
67. H.H. Rotmensch, P.H. Vlasses, B.N. Swanson, J.D. Irvin, K.E. Harris, D.G. Merrill and R.K. Ferguson, *Am. J. Cardiol.* 53 (1984) 116.
68. R.R. Garcia, E. Ravine, L. Cortizo, F. Orallo and J.M. Colleja, *An. Quim. Ser. C.*, 83 (1987) 85.
69. R.P. Mull, *U.S. Pat. 3, 093, 632*; *Chem. Abstr.*, 59 (1963) 12771.
70. P.E. Aldrich and G.H. Berezin, *U.S. Pat. 4, 107, 303*; *Chem. Abstr.* 90 (1979) 87307.
71. T. Teraji, Y. Shiokawa, K. Okamura and Y. Sato, *Eur. Pat. Appl. EP 77, 983*; *Chem. Abstr.*, 99 (1983) 122496.
72. Olin Mathieson Chemical Corp., *Neth. Pat. Appl. 6,516,320*; *Chem. Abstr.* 65, (1966) 15354.
73. J. Bernstein, E.J. Pribyl and J. Krapcho, *U.S. Pat. 3, 330, 823*; *Chem. Abstr.*, 68 (1968) 95713.
74. D.M. Floyd, *Eur. Pat. Appl. EP 205, 334*; *Chem. Abstr.*, 106 (1987) 176198.
75. J. Das, D.M. Floyd and J. Krapcho, *Eur. Pat. Appl. EP 229, 329*; *Chem. Abstr.*, 108 (1988) 5872.
76. R.S.L. Chang and W.H. Parsons, *Eur. Pat. Appl. EP 166, 354*; *Chem. Abstr.*, 105 (1986) 60548.
77. W.H. Parsons and A.A. Patchett, *Eur. Pat. Appl. EP 166, 357*; *Chem. Abstr.*, 105 (1986) 97351.
78. W.H. Parsons, *S. Afr. Pat. ZA 85 04, 765*; *Chem. Abstr.*, 106 (1987) 32870.
79. W.H. Parsons, *Eur. Pat. Appl. EP 166, 353*; *Chem. Abstr.*, 105 (1986) 60547.
80. M. Rajsner, M. Protiva and M. Bartosova, *Czech. Pat. CS 192, 861*; *Chem. Abstr.*, 101 (1984) 38369.
81. M. Protiva, Z. Vejdelek and M. Bartosova, *Czech. Pat. CS 210, 532*; *Chem. Abstr.*, 101 (1984) 7055.
82. B. Loev and C.L. Zirkle, *U.S. Pat. 3, 769, 275*; *Chem. Abstr.*, 80 (1974) 27125.
83. M. Protiva, S. Zdenek, H. Jiri, S. Emil and N. Jiri, *Collect. Czech. Chem. Commun.*, 50 (1985) 1888.

84. W.L. Bencze, U.S. Pat., 3, 509, 130; Chem. Abstr., 73 (1970) 98832.
85. H. Uno, Y. Nakano and Y. Takase, J. Pat. 74 28, 753; Chem. Abstr., 82 (1975) 139978.
86. H.R. Rodriguez, U.S. Pat. 3, 949, 081; Chem. Abstr., 85 (1976) 46440.
87. H.R. Rodriguez, U.S. Pat., 3, 989, 689; Chem. Abstr., 86 (1977) 89641.
88. H. Jones and S.M. Coutts, U.S. Pat. US 4, 477, 446; Chem. Abstr., 102 (1985) 95556.
89. C.M.C. Koo, T.W. Pattison and D.R. Herbst, U.S. Pat. 3, 458, 498; Chem. Abstr., 71 (1969) 81225.
90. Y. Sawa, T. Kato, T. Masuda, M. Hori and H. Fujiwara, Chem. Pharm. Bull., 23 (1975) 1917.
91. H.J. Havera, U.S. Pat. 3, 475, 414; Chem. Abstr., 72 (1970) 3401.
92. D.M. James and A.H. Rees, J. Med. Pharm. Chem., 5 (1962) 1234.
93. J. von Brown and B. Bartsch, Chem. Ber., 45 (1912) 3376.
94. A.H. Rees, J. Chem. Soc., (1959) 3111.
95. J. Witte and V. Boekelheide, J. Org. Chem., 37 (1972) 2850.
96. R. Tillais, A. Latters, H. Huet and J. Bonnic, C.R. Acad. Sci. Paris, Ser. C, 267 (1968) 1350.
97. J. Bonnic, P. Uriac, H. Bouget and J. Huet, C.R. Acad. Sci. Paris, Ser. C, 286 (1978) 83.
98. D.N. Gupta, I. McCall, A. McLean and G.R. Proctor, J. Chem. Soc. (C), (1970) 2191.
99. M.J. Teuber and G. Emmerich, Tetrahedron Lett., (1970) 4069.
100. B.D. Astill and V. Boekelheide, J. Am. Chem. Soc., 77 (1955) 4079.
101. J.T. Braunholtz and F.G. Mann, Chem. Ind. (London), (1957) 266.
102. G.R. Proctor, W.I. Ross and A. Tapia, J. Chem. Soc., Perkin Trans. 1, (1972) 1803.
103. I. McCall, G.R. Proctor and L. Purdie, J. Chem. Soc. (C), (1970) 1126.
104. J.T. Braunholtz and F.G. Mann, J. Chem. Soc., (1958) 3377.
105. H.B. MacPhillamy, R.L. Dziemian, R.A. Lucas and M.E. Kuehne, J. Am. Chem. Soc., 80 (1958) 2172.
106. T.A. Geissman and A.K. Cho, J. Org. Chem., 24 (1959) 41.
107. E.C. Horning, V.L. Stromberg and H.A. Lloyd, J. Am. Chem. Soc., 74 (1952) 5153.
108. H.A. Lloyd, L.U. Matternas and E.C. Horning, J. Am. Chem. Soc., 77 (1955) 5932.
109. H.A. Lloyd and E.C. Horning, J. Am. Chem. Soc., 76 (1955) 3651.
110. G.N. Waker, D. Alkalay and R.T. Smith, J. Org. Chem., 30 (1965) 2973.
111. P.T. Lansbury and W.R. Mancuso, J. Am. Chem. Soc., 88 (1966) 1205.
112. R.L. Augustine and W.G. Pieson, J. Org. Chem., 34 (1969) 1070.
113. A. Vogel, F. Troxler and A. Lindenmann, Helv. Chim. Acta, 52 (1969) 1929.
114. L. Bauer and R.E. Hewitson, J. Org. Chem., 27 (1962) 3982.
115. L.M. Briggs and G.C. De Ath, J. Chem. Soc., (1937) 456.
116. M. Tomita, S. Minami and S. Uyeo, J. Chem. Soc. (C), (1969) 183.
117. R.T. Conley, J. Org. Chem., 23 (1958) 1330.
118. D. Evans and M. Lockhart, J. Chem. Soc., (1965) 4806.
119. P.A.S. Smith and W.L. Berry, J. Org. Chem., 26 (1961) 27.
120. G. Jones, J. Chem. Soc. (C), (1967) 1808.
121. G.R. Birchall and A.H. Rees, Can. J. Chem., 52 (1974) 610.
122. H. Uno and Y. Nakano, J. Pat., 74 28, 754; Chem. Abstr., 82 (1975) 139981.
123. P. Scheiner, J. Org. Chem., 32 (1967) 2628.
124. H. Plieninger and J. Wild, Chem. Ber., 99 (1966) 3070.
125. M.S. Lin and V. Snieckus, J. Org. Chem., 36 (1971) 645.
126. R.M. Acheson, J.N. Bridson and T.S. Cameron, J. Chem. Soc., Perkin Trans. 1, (1972) 968.
127. R. Fucus and H.G. Viehe, Chem. Ber., 103 (1970) 573.
128. A. Cromarty, K.E. Haque and G.R. Proctor, J. Chem. Soc. (C), (1971) 3536.

This Page Intentionally Left Blank

4 Peptide Regulation of Mast-Cell Function

DAVID E. COCHRANE, Ph.D.

Department of Biology, Tufts University, Medford, MA 02155, U.S.A.

INTRODUCTION	144
METHODS OF PEPTIDE DELIVERY	147
Neuronal–mast cell connection	147
Peptides from immunocompetent cells and those generated locally from circulating precursors	149
PEPTIDES THAT AFFECT MAST CELL FUNCTION	149
Neurotensin	151
Substance P	155
Somatostatin	157
Calcitonin-Genie Related Peptide	158
Nerve Growth Factor	159
Endogenous opiates	160
Parathormone	160
Thrombin	161
Gastrin	161
Peptide factors from inflammatory cells	161
Interleukin-1	163
Interleukin-3	163
Peptides generated locally from circulating precursors	164
Bradykinin	164
Peptides generated from albumin	165
MECHANISM OF PEPTIDE ACTION	168
Binding	168
Structure–activity relationships	171
Stimulus–secretion coupling	176
ACKNOWLEDGEMENTS	181
REFERENCES	182

INTRODUCTION

The ability of peptides of immune, neural and endocrine origin to affect mast-cell function is now well established. Once viewed with only passing pharmacological interest and believed to be of little physiological relevance, peptides are now recognized as important regulators of mast-cell secretion, growth and development. Besides, they are now believed to participate with mast cells in allergic disease [1-5], in bronchial asthma [6, 7], and in various states of inflammation [4, 8, 9]. Moreover, the ability of peptides to modulate mast-cell function could contribute to the suggested roles for mast cells in the control of the microenvironment and in tissue growth and repair [10, 11].

Traditionally, mast cells have been studied because of their prominent role in the reactions of immediate-type hypersensitivity [12-14]. This was clearly established by the pioneering studies of Lewis, Dale, Best and others [15, 16], who demonstrated the importance of antigen-antibody coupling and of histamine in allergic reactions, and by the studies of Riley and West [16] which established the mast cell as a prominent store of histamine. In the allergic reaction, IgE antibodies specific to the sensitizing antigen are bound during the sensitization period to high-affinity receptors on the mast-cell surface. Subsequent exposure of the mast cell to the specific antigen results in the binding and cross-linking of adjacent cell-bound IgE antibodies. This, in turn, initiates a series of biochemical reactions that culminate in the exocytotic extrusion of preformed mediators such as histamine, heparin, and chemotactic factors for neutrophils and eosinophils, and in *de novo* generation of several metabolites of arachidonic acid (various leukotrienes and prostaglandins) and in the generation of the phospholipid derivative, platelet-activating factor (PAF) [17-19] (see Chapter 8). Together, these various agents orchestrate the complex array of biological responses that characterize the reactions of immediate-type hypersensitivity [12-14]. Whether other factors such as peptides may be involved in modulating the allergic response cannot at this point be stated with certainty. However, as this review will show, the conditions for such modulation clearly exist; peptides can affect mast-cell function and they are present in sufficient quantity in the vicinity of the tissue mast cell.

A widely distributed fixed tissue cell, the mast cell, is particularly prevalent in organs with a high percentage of connective tissue [20] and is most numerous in the skin and in the linings of the respiratory, gastrointestinal and reproductive tracts, tissues which interface with the external environment. In these various locations, mast cells are frequently found in close proximity to small blood vessels and nerves [20]. This prominence of the mast cell in tissues that interface with the external world is strategic to its role as the sentinel cell of the

inflammatory response [8]. Here, initial stimulation by direct injury [21], by the peptide cleavage products of the third and fifth components of complement, the anaphylatoxins C3a and C5a [22], by specific peptide components of the kinin cascade [23], or by any of a multitude of other ill-defined factors [24], initiates the secretion of the preformed mediators as well as the *de novo* generation of the arachidonic acid metabolites and PAF [17–19]. The hallmarks of inflammation – vasodilatation, increased blood flow, plasma extravasation from increased vascular permeability, and the accumulation of leukocytes – then ensue producing the cardinal signs of an inflammatory response: redness, increased temperature, oedema, pain and the accumulation of pus at the site of injury [25]. Left untreated, there is often an eventual loss of function.

Specific interactions between the major systems of control (neural and endocrine) and the immune system have been considered for many years, backed up by numerous anecdotal accounts linking a healthy emotional state to the balance between health and disease. Who, for example, has not heard accounts relating the severity of an allergic or asthmatic attack to emotional upheavals or has not seen profound urticaria in a nervous public speaker? However, direct evidence for such interactions has been lacking. The discovery of numerous peptides of neural and endocrine origin that have the ability to alter immune function has at last provided the definitive proof for specific interactions between the dominant systems of control and that of host defence. For example, it is now known that substance P, a peptide of neural origin [27, 28], can affect proliferation of T lymphocytes [29], can promote macrophage and neutrophil phagocytosis [30], can stimulate secretion from mast cells [1, 27] and can increase the rate of synthesis of C3 complement factor in guinea-pig peritoneal macrophages [32]; vasoactive intestinal peptide (VIP), a neural-endocrine peptide [33], has been shown to influence lymphocyte function by affecting the activity of adenylate cyclase [34]; the endogenous opiates, β -endorphin and enkephalin [35], are known to increase natural killer cell activity [36]; and the neural-endocrine peptide neurotensin (NT) [37, 38] has been shown to stimulate phagocytosis in macrophages [39] and to markedly affect mast-cell function [37, 38, 40].

The regulation of mast-cell activity by biologically active peptides is an area of research, the rapid growth of which has been sparked in part by this intense interest in the interactions between neural, endocrine and immune systems [4, 26, 41] and in part by the recognition that activation of mast-cell secretion as a purely allergic IgE-dependent event is undoubtedly too restrictive. The involvement of the mast cell in the inflammatory response, for example, has for years been suspected to involve a number of non-immunologic, IgE-independent factors [24, 42]. Direct evidence for peptide involvement, however, has

been sparse. Recently, in studies using a rat model of arthritis, a close correlation was observed between the severity of joint arthritis and the extent of innervation by substance P-containing primary afferent neurons. Furthermore, when substance P was infused into the knee joint, the severity of arthritis significantly increased [43]. The authors of this study proposed that the release of neuronal substance P, by stimulating the cells of inflammation (for example, mast cells, neutrophils, monocytes), increases the severity of arthritis. It is worth noting that patients with rheumatoid arthritis have significantly more mast cells per blood vessel and a higher total number of mast cells per joint area than do patients with no joint disease [44–46]. Thus interactions between substance P and the synovial mast cell may be important in the etiology of arthritis [43].

Another area in which peptides and mast cells may interact is in the maintenance of local tissue homeostasis by regulation of the microvasculature [10, 11, 17]. In this role, the mast cell must be tonically active yet precisely controlled by factors in the local environment. How such control might be attained in tissues with vastly different metabolic requirements is uncertain, but it could involve neurally released peptides acting on nearby mast cells. Control could be enhanced further by a heterogeneity in mast-cell functions. Moreover, changes in local pH could, by affecting the net charge on the peptide, further contribute to modifying mast-cell secretion.

Heterogeneity of mast cells is now an area of great interest [47–49] and may have important bearing on our interest here. For not only do various subsets of mast cells exhibit different morphologic and histochemical features [50, 51], but they appear also to differ in their responsiveness to various peptides [52, 53]. In one study, for example, using enzymatically dispersed mucosal mast cells from the rat small intestine, only substance P (SP), of a variety of other peptides tested, elicited significant histamine release. The other peptides, somatostatin, vasoactive intestinal peptide, neurotensin and bradykinin, while effective in stimulating peritoneal mast cells that had gone through the same dispersal procedure, were without effect on mucosal mast cells [52]. It may be significant that, of the various peptides tested, only SP has been convincingly identified in nerve terminals which end in the intestinal mucosal in the vicinity of mucosal mast cells [54]. (In addition, it is interesting to note that, of these various peptides tested, only SP is blocked (amidated) at the C-terminal end and thus would resist the degradative action of carboxypeptidase – a known constituent of peritoneal mast cell granules [18].)

METHODS OF PEPTIDE DELIVERY

NEURONAL-MAST CELL CONNECTION

In order to influence mast-cell function, peptides must be made available at sites very near to tissue mast cells. One means of accomplishing this is by specific peptidergic innervation. This would not necessarily require a classical synaptic morphology, but only the termination of nerves within the vicinity of mast cells [1, 3]. Modulation of mast-cell secretion by peptides of neural origin is particularly attractive, for it would allow for a restricted, localized expression of peptide action in specific target tissues because of the selective distribution of each peptide within particular neurones. Moreover, this could be further modified and restricted by differing mast cell specificities. (Heterogeneity of mast cell responsiveness to peptide stimulation has been well documented [52, 53].) The result would permit a well-localized tissue response without systemic manifestation [3].

The evidence for a physiological connection between the nervous system and the mast cell by way of secreted peptides is now substantial. Some of this is summarized below:

- (1) Peptidergic nerves are known to innervate tissues with a high mast-cell content and to contain specific peptides which have been demonstrated to affect mast-cell function [5, 54–56].
- (2) Antidromic stimulation of sensory nerves produces vasodilatation and increased blood flow in the skin [57, 58] that is blocked by histamine receptor antagonists [59] or by pretreatment with compound 48/80 [60].
- (3) Neurogenic inflammation induced by chemical irritation of the skin is blocked by dorsal root section [61].
- (4) Direct stimulation of peripheral nerves in skin results in vasodilatation and degranulation of skin mast cells [57, 58].
- (5) The sensory neuropeptides, SP, calcitonin-gene-related peptide (CGRP) and somatostatin (SOM) rapidly release histamine from rat serosal mast cells by a non-cytotoxic mechanism [3, 62].
- (6) Substance P, calcitonin-gene-related peptide (CGRP), and neurokinin A have been identified by immunocytochemistry in primary sensory neurones and in cutaneous sensory nerve terminals and these are often in close proximity to mast cells [54, 56]. For example, in Lewis rats that were infected with the parasitic larvae of *Nippostrongylis brasiliensis* in order to induce a proliferation of mucosal mast cells, nearly two-thirds of the lamina propria mast cells were in intimate contact with peptidergic nerves containing SP and CGRP, while an additional 20% of the mast cells were within 2 μm [54]. All three peptides are

thought to be released together and while all three cause plasma extravasation when injected intradermally [63], only SP and CGRP have been shown to release histamine from isolated mast cells [3]. A similar close spatial relationship has been observed between mast cells of the rat diaphragm and mesentery and SP-containing nerves [55].

(7) SP antagonists have been shown to inhibit the vasodilatation and plasma extravasation induced by antidromic stimulation of the saphenous nerves or by the infusion of SP [64]. In these experiments somatostatin also inhibited the effect due to antidromic stimulation but not that induced by infusion of SP. Interestingly, the opiate agonist, [DMet²-Pro⁵]enkephalinamide, also inhibited the vasodilatation evoked by antidromic nerve stimulation but not that induced by SP infusion [64].

An interaction between neuronal stimulation and mast-cell secretion has been considered for sometime in neurogenic inflammation [59, 60]. Here, it is speculated that injury to the skin elicits a characteristic reaction beginning with a local reddening at the site of injury which then rapidly spreads out for several

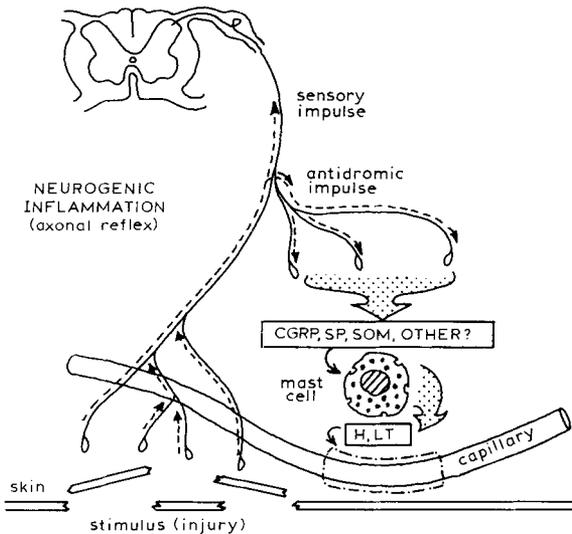

Figure 4.1. Model of neurogenic inflammation. Stimulation at the skin initiates orthodromic impulses in sensory nerve receptors which elicit antidromic impulses in branching collaterals. The release of neuropeptides such as calcitonin gene-related peptide (CGRP), substance P (SP), and somatostatin (SOM) from nerve terminals ensues and they in turn stimulate the release of histamine (H) and the generation of leukotrienes (LT) from nearby mast cells. These mediators then produce vasodilatation and an increase in vascular permeability. In addition, they act on the nerve terminal to produce further nerve stimulation.

cm (*Figure 4.1*). This area of flare is then replaced by a localized area of oedema (or wheal) with its centre at the site of injury. The intradermal injection of histamine produces a similar kind of reaction due, in part, to its ability to cause vasodilatation and an increase in vascular permeability. But, in addition, there is a spread of erythema beyond the point of injection that cannot be explained by diffusion of histamine (either injected or released). Lewis [65] demonstrated the spread of the flare to be neurogenic, perhaps due to an axonal reflex.

Recent studies [58] of neurogenic inflammation have shown a decrease in skin histamine and an increase in vascular permeability (measured by escape of ^{125}I -albumin) when the saphenous nerve to the rat paw was electrically stimulated (30 min). This effect was accompanied by mast cell degranulation, but there was no change in venous plasma histamine levels; shorter periods of nerve stimulation, while producing no significant change in skin histamine and no significant mast-cell degranulation, did produce an increase in vascular permeability. The authors [58] suggest that the initial phases of neurogenic inflammation are mast-cell independent. However, it is possible that small amounts of histamine could be released from skin mast cells (with little significant degranulation), thereby causing an increase in vascular permeability. Unfortunately, the effect of antihistamines was not tested.

PEPTIDES FROM IMMUNOCOMPETENT CELLS AND THOSE GENERATED LOCALLY FROM CIRCULATING PRECURSORS

While the majority of attention has focused on peptides contained within the nervous system, two other *important methods for delivering peptides* to the vicinity of the mast cell have been established: (1) peptides produced and secreted by other cells of inflammation that may affect mast-cell function and (2) the local generation of mast-cell-active peptides by secreted enzymes acting on circulating protein precursors. Examples of the former include several, as yet ill-defined, peptide factors and cationic proteins from other immunocompetent cells [66–69], defined lymphokines such as the interleukin-1 [70] and interleukin-3 [71], and tumour necrosis factor [70]. Examples of the latter include bradykinin [72] and a recently identified peptide produced by the action of acid proteinases on albumin [73, 74].

PEPTIDES THAT AFFECT MAST-CELL FUNCTION

The number of peptides that have been shown to stimulate mast-cell secretion is impressive (*Table 4.1*) and it is obvious that the potential for regulation of

Table 4.1. IDENTIFIED PEPTIDES AFFECTING MAST-CELL FUNCTION

See text for appropriate references unless otherwise indicated, RPMC, rat peritoneal mast cell; RMMC, rat mucosal mast cell; MBMC, murine bone-marrow derived.

<i>Peptide</i>	<i>Mast cell type</i>	<i>Effect</i>
ACTH [74a]	RPMC	stimulation of secretion (but only at $\geq 10^{-4}$ M)
Bradykinin	RPMC	stimulation of secretion
C5a	RPMC	stimulation of secretion
C3a	RPMC	stimulation of secretion
Calatonin-gene related peptide	RPMC human skin	stimulation of secretion
Crabrolin [74b] (from hornet venom)	RPMC	stimulation of secretion
Dynorphin	RPMC human skin	stimulation of secretion
β -Endorphin	RPMC human skin	stimulation of secretion
Eledosin-related peptide	RPMC human skin	stimulation of secretion
Gastrin	human skin	stimulation of secretion
Interleukin 1	human lung human basophil	stimulation of secretion
Interleukin 3	MBMC	differentiation and growth
Melanin	RPMC	stimulation of secretion
Mastoparan [74b]	RPMC	stimulation of secretion (only at $> 2-5$ μ g/ml)
Neurotensin	RPMC rat pleural mast cell human jejunal human skin	stimulation of secretion (inhibition at low concn.)
Nerve growth factor	RPMC human skin	stimulation of secretion
Parathormone	RPMC	stimulation of secretion
Somatostatin	RPMC human skin	stimulation of secretion (inhibition at low concn.)
Substance P	RPMC, RMMC human skin	stimulation of secretion
Thrombin	MBMC	stimulation of secretion
Xenopsin	RPMC	stimulation of secretion

mast-cell activity by biologically active peptides is enormous. The following sections will first review a number of specific peptides that have been shown to directly affect mast-cell function, and will second summarize our present understanding of the mechanism of peptide action by reviewing studies on binding, on structure-activity relationships and on stimulus-secretion coupling.

NEUROTENSIN

Neurotensin (NT) is a tridecapeptide (*Table 4.2*) first isolated from brain and gut by Carraway and Leeman [75] and reported by them to induce a rapid and transient hypotension, a cutaneous vasodilatation, and a cyanosis of the extremities in the anaesthetized rat. This report, along with others [76-78] indicating that the NT-induced hypotension and increased vascular permeability could be blocked by histamine receptor antagonists such as mepyramine [77] or by pretreatment with compound 48/80 [76], suggested that endogenous histamine (perhaps released from tissue mast cells) was involved in producing some of the biological effects of NT [78].

Table 4.2. NEUROTENSIN-RELATED PEPTIDES

	1	2	3	4	5	6	7	8	9	10	11	12	13
Neurotensin	Glp-Leu-Tyr-Glu-Asn-Lys-Pro-Arg-Arg-Pro-Tyr-Ile-Leu-OH												
Neuromedin N							H-Lys-Ile-Pro-Tyr-Ile-Leu-OH						
Xenopsin						Glp-Gly-Lys-Arg-Pro-Trp-Ile-Leu-OH							
Angiotensin I			H-Asp-Arg-Val-Tyr-Ile-His-Pro-Phe-His-Leu-OH										
NRP			H-Ile-Ala-Arg-Arg-His-Pro-Tyr-Phe-Leu-OH										
HRP			H-Ile-Ala-Arg-Arg-His-Pro-Tyr-Phe-OH										

NT was initially reported to stimulate the non-cytotoxic release of histamine from isolated rat peritoneal mast cells by workers in our laboratory [40, 79]. This observation has now been confirmed and extended by several other workers [80-85]. When added to isolated rat serosal mast cells, NT initiates the secretion of histamine which is dependent upon calcium and energy [79]. Secretion begins at about 10 nanomolar NT and reaches an initial plateau of some 20% histamine release at 10 μ M NT [79] (*Figure 4.2*); while higher levels

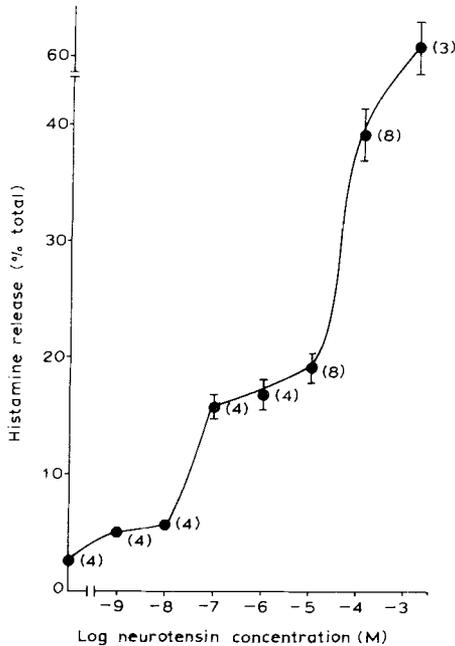

Figure 4.2. Histamine release from rat mast cells in response to increasing concentrations of neurotensin [79]. Mast cells were washed three times and bathed in Ca-Locke solution at 37°C for 10 min. Neurotensin was then added and the incubation continued for 10 min. Each point represents the mean \pm S.E. of mean of n experiments (in parentheses).

of NT cause additional histamine release, this is most likely nonspecific [79]. Although histamine release from mast cells stimulated by NT is abolished by prolonged exposure of the cells to calcium-free conditions [79], it is markedly inhibited by raising the concentration of extracellular calcium (Ca) above 0.5 mM [79]. This has prompted the suggestion that calcium may compete with NT (or other non-immunologic agents) for a common binding site [79]. In support of this suggestion is the observation that Ca inhibits the binding of ^{125}I -NT to the isolated mast cell [86]. This inhibitory effect of extracellular Ca may account for the lack of stimulation by NT observed by some workers [82].

Interestingly, pretreatment of isolated rat peritoneal mast cells with NT desensitizes the cells to the subsequent stimulation by compound 48/80 (Figure 4.3). However, the desensitized cells are still responsive to stimulation by the calcium ionophore, A23187, in the presence of Ca (Figure 4.3). A similar observation has been made when compound 48/80 and the peptides,

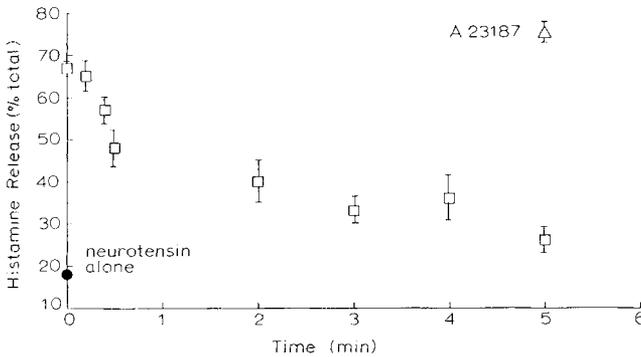

Figure 4.3. Histamine release from mast cells bathed in Locke solution and pretreated with neurotensin (10^{-5} M) [86a]. Compound 48/80 (0.1 $\mu\text{g}/\text{ml}$) was then added at the times indicated and histamine release (% total) determined 10 min later. NT alone elicited $19 \pm 1.4\%$ release. The addition of the ionophore, A23187 (0.5 $\mu\text{g}/\text{ml}$), to cells pretreated with NT for 5 min produced a maximal secretory response. 48/80 alone, without NT pretreatment, caused $68 \pm 1.0\%$ release. Note that histamine release in response to 48/80 declines as the period of pretreatment increases. Mean \pm S.E.M., $n = 3$.

bradykinin and polymyxin B [87] were used. These observations suggest that non-immunologic agents such as various peptides may share a common binding site or mechanism of activation. Moreover, they indicate that peptides like NT can either activate or suppress mast-cell function depending on the available concentration and the duration of action (for more on this aspect, see section on somatostatin).

NT can also stimulate mast cell histamine release *in vivo*. When given intravenously to anaesthetized rats, NT produces a rapid (within 30 s) and marked increase in the level of plasma histamine which then gradually declines to control values (Figure 4.4) [79]. This effect of NT is nearly abolished by pretreatment of the rats with compound 48/80 [79] or by the simultaneous administration of disodium cromoglycate (DSCG) (Figure 4.5). When NT is injected into raised skin blisters, it produces a dose-dependent release of histamine that is inhibited by DSCG or by pretreatment with low concentrations of somatostatin [88]. NT has been shown to evoke the release of histamine from the isolated perfused rat head [89], heart [90] and hindquarters [91] and these effects, too, are abolished by previous depletion of mast cell histamine by compound 48/80 [89–91]. Likewise, studies on the perfused rat heart have shown that NT has a direct effect on ventricular mast cells; this observation is supported by the fact that the secretory effect of NT is inhibited by pretreatment with compound 48/80 or with DSCG [90].

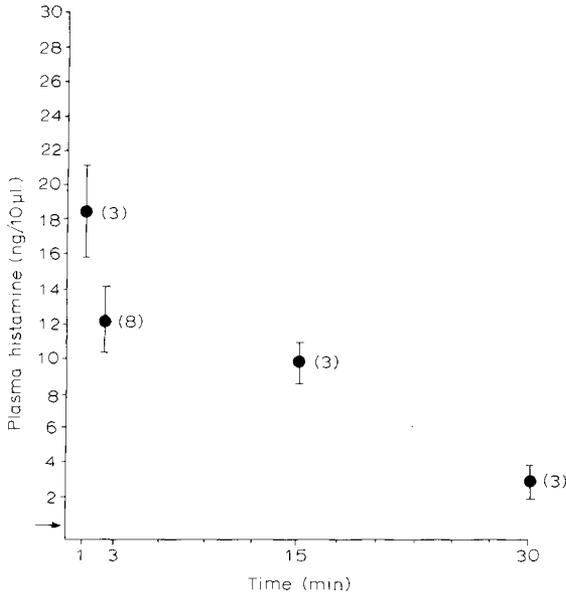

Figure 4.4. Plasma histamine levels in response to NT given at $t = 0$. Rats were anaesthetized and NT (5 nmol/kg) or saline (0.3 ml) given intravenously. Blood was collected at the indicated times. Mean \pm S.E.M. of mean of n values (in parentheses). Horizontal arrow is the histamine level before NT.

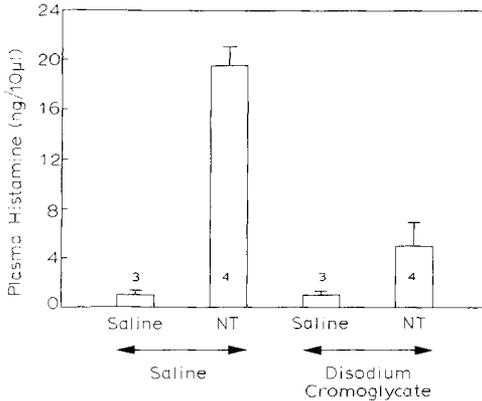

Figure 4.5. Plasma histamine levels in response to NT in rats pretreated with saline or disodium cromoglycate (100 µg). NT (5 nmol/kg) or saline (0.3 ml) was given intravenously. Mean \pm S.E.M. of n experiments, quoted with the column.

NT, at a concentration of one nanomolar, has also been found to cause a significant (57%) degranulation of human mucosal mast cells as judged by light microscopic inspection of fixed tissue sections [92–94]. This effect, too, was inhibited by DSCG. However, in these studies, NT was added to intact intestinal tissue, thereby offering the possibility for degradation of NT by intestinal proteinases to more active fragments [94].

Some workers have reported a failure of NT to elicit significant histamine release (<5% at 10 μ M NT) from isolated peritoneal mast cells obtained from Wistar strain rats [82]. In these studies, when NT was added to mast cells from the pleural cavity [82] or when the C-terminal octapeptide (NT_{6–13}) or the C-terminal hexapeptide (NT_{8–13}) was added to peritoneal mast cells, a significant (>20% histamine release) secretory response occurred [82]. In our laboratory a significant difference in the responsiveness to NT of peritoneal and pleural mast cells from Sprague-Dawley rats has also been found, pleural cells eliciting a higher percentage of histamine release than peritoneal cells for an equimolar concentration of NT (19.2 \pm 2% release for peritoneal mast cells versus 45 \pm 6% release for pleural mast cells at 10 μ M NT). Moreover, we have also observed anecdotally differences between various populations of mast cells and between various populations of rats in terms of their responsiveness to the same batch of NT.

The reason for the failure of NT to elicit a significant secretory response in these studies is unclear but may be due to the level of extracellular Ca used (>0.5 mM) or to strain differences between rats (most studies showing a significant secretory effect of NT have used Sprague-Dawley rats). Alternatively, it may be that peritoneal and pleural mast cells have different enzyme activities and different surface properties. Peritoneal mast cells are known to contain a carboxypeptidase within their secretory granules [18], which could rapidly inactivate NT by cleavage of the C-terminal amino acid (that is, Leu) to produce NT_{1–12}. Mast cells from the pleural cavity may, with different enzyme activities, expose the NT_{6–13} or NT_{8–13} residues, each of which has greater biological activity than NT_{1–13} [95]. This notion remains, however, to be tested.

SUBSTANCE P

The hypotensive effects of substance P (*Table 4.3*) (SP) were first demonstrated in the 1930's [27, 96]. Since then, its tachykinin and sialogogic activities have been repeatedly established [27]. Using radioimmunoassay and immunocytochemistry, SP has been identified in gut, salivary glands and many areas of the central nervous system, including high concentrations in the hypothalamus and

Table 4.3. SUBSTANCE-P-RELATED PEPTIDES

	1	2	3	4	5	6	7	8	9	10	11
Substance P	Arg-Pro-Lys-Pro-Gln-Gln-Phe-Phe-Gly-Leu-Met-NH ₂										
Eledosin	pGlu-Pro-Ser-Lys-Asp-Ala-Phe-Ile-Gly-Leu-Met-NH ₂										
Eledosin-related peptide (ERP)	Lys-Phe-Ile-Gly-Leu-Met-NH ₂										
Physalaemin	pGlu-Ala-Asp-Pro-Asn-Lys-Phe-Tyr-Gly-Leu-Met-NH ₂										
Neurokinin A (Substance K)	His-Lys-Thr-Asp-Ser-Phe-Val-Gly-Leu-Met-NH ₂										
Neurodynin K	ASP-Met-His-Asp-Phe-Phe-Val-Gly-Leu-Met-NH ₂										

dorsal horn of the spinal cord where stimulus-coupled release of SP which is dependent on Ca has been demonstrated [27].

The ability of SP to stimulate histamine release from isolated rat peritoneal mast cells is now well demonstrated [31, 97-101]. The release is rapid (< 1 min), non-cytotoxic, dependent on a supply of Ca and metabolic energy, and independent of cell-bound IgE [99]. Moreover, as with other peptides, its secretory effect on the mast cell is affected by moderate levels of extracellular cations. For example, the addition of Ca to the bathing medium *after* the addition of SP increased the secretory response of the cells, while adding calcium (0.1-1 mM), magnesium (1-10 mM) or cobalt (0.01-1 mM) to the cell suspension *before* SP inhibited histamine release, suggesting the possibility of cation competition for SP binding [99].

Like other peptides, the ability of SP to stimulate histamine release is closely related to its ability to mobilize Ca from a cellular pool and to the basic and the hydrophobic properties of its N-terminal and C-terminal amino acids, respectively. In this regard, intact SP (SP₁₋₁₁) is more active than the N-terminal tetrapeptide (SP₈₋₁₁) with SP₁₋₁₁ giving a half-maximal response at 8×10^{-6} M and 1×10^{-5} M producing some 40% release [99]. The C-terminal heptapeptide, SP₁₋₆ was inactive [99].

SP produces a pronounced (4-fold) increase in the histamine content of the venus outflow of the perfused rat hindquarters [91] and, when injected intravenously in intact animals, it produces a significant increase in the level of plasma histamine and in the hematocrit and a pronounced fall in systemic blood pressure [102]. In these experiments, pretreatment with the steroid, dexamethasone, reduced the SP-induced elevations in plasma histamine and hematocrit; neurotensin and compound 48/80 were found to be similarly

affected. The authors suggested that SP, NT and 48/80 share a common mechanism of action in eliciting hypotension in the rat [102].

In humans, the intradermal injection of SP (10^{-7} – 10^{-5} M) produces a flare, wheal and itching, and these effects are prevented by pretreatment with chlorcyclizine (an antihistamine) or by local pretreatment with compound 48/80 [103, 104]. It causes histamine release from sections of human foreskin [105]. These authors suggested that SP is significantly less active on isolated rat peritoneal mast cells than in human skin.

SP seems to be the only peptide capable of stimulating histamine release from mucosal mast cells [52] and generally exhibits a pronounced heterogeneity among various tissues and between species [106].

Because of the demonstrated involvement of SP in eliciting pain [27], there has been a great deal of interest in designing SP antagonists. However, their ability to block the action of SP on the mast cell has been generally disappointing due to the often significant histamine-releasing effect of the putative SP-blockers [107, 108]. For example, in one study [107], four SP analogues with reported antagonistic properties were tested for their ability to block the effect of SP on the isolated mast cell. Those tested were: [D-Pro²; D-Trp^{7,9}]-SP₁₋₁₁, [D-Trp^{7,9}]-SP₁₋₁₁, [D-Phe⁷, D-Trp⁹]-SP₁₋₁₁, and [Arg⁵-D-Trp^{7,9}]-SP₁₋₁₁. Each antagonist produced significant histamine release and each was more effective than SP in this regard. Thus, the ED₅₀ value for SP was 1.3×10^{-5} M, while the corresponding values for the analogues were 1.6×10^{-6} M, 3.3×10^{-6} M, 2.7×10^{-7} M and 2.5×10^{-6} M, respectively. It may be that because of the pronounced ability of basic peptides to elicit histamine release from mast cells, effective SP antagonists will, of necessity, be non-peptide in nature.

SOMATOSTATIN

Somatostatin (SOM), initially identified by its ability to inhibit the release of growth hormone, is known to have inhibitory effects on a variety of cells [109]. In mast cells and in basophils, SOM, like NT, has inhibitory as well as stimulatory effects depending on the concentration used. At high concentrations ($> 10^{-8}$ M), SOM is a powerful stimulus of peritoneal mast-cell secretion (from both normal and athymic rats) and resembles other non-immunologic secretagogues such as compound 48/80, SP and NT in that it triggers a rapid exocytosis that is primarily dependent on cellular Ca [110, 111]. A similar effect is seen *in vivo*; when injected into skin or skin blisters at high concentrations ($> 10^{-8}$ M), SOM causes a rapid, dose-dependent release of histamine [88, 112] but when used at concentrations lower than those which elicit a secretory

response (10^{-9} – 10^{-12} M), SOM is inhibitory. This has been demonstrated for rat cutaneous mast-cell histamine secretion elicited by NT and for peritoneal mast-cell secretion [88]. Likewise, when added to human basophils and rat basophilic leukaemia (RBL) cells, SOM has significant inhibitory effects on IgE-independent histamine secretion [113]. Furthermore, like SP, NT, and compound 48/80, SOM can stimulate histamine release from IgE-dependent, desensitized rat mast cells [113], suggesting that its mechanism of action differs from that of IgE-dependent activation.

CALCITONIN-GENE RELATED PEPTIDE

Calcitonin-Gene Related Peptide (CGRP) is a 37-amino-acid peptide (see *Table 4.4*) which is found in neural tissue [54, 56, 114, 115]. It has a range of biological activities, including contraction of the guinea-pig ileum, stimulation of sympathetic outflow, and vasodilation [62]. CGRP and SP are believed to co-exist in dorsal root ganglion cells and in peripheral nerve endings where each has been localized by immunocytochemistry [54, 56]. When injected into rabbit skin, CGRP was found to enhance the oedema produced by other inflammatory mediators [116] and, when injected into human skin at doses of 12.5 to 50 pmol, CGRP produced a classic wheal and flare reaction [62]. The flare (vasodilation) response but not the wheal (plasma extravasation) was inhibited by pretreatment with chlorpheniramine (an H_1 blocker). Interestingly, CGRP, but not SP, is effective in producing a delayed erythema and surrounding pallor which peaks 10 min after injection and lasts for more than 3 h. This delayed response is accompanied by the infiltration of neutrophils which suggests that

Table 4.4. MISCELLANEOUS PEPTIDES

Bradykinin	Arg-Pro-Pro-Gly-Phe-Ser-Pro-Phe-Arg
Somatostatin	Ala-Gly-Cys-Lys-Asn-Phe-Phe-Trp-Lys-Thr-Phe-Thr-Ser-Cys
Mastoporan	Ile-Asn-Leu-Lys-Ala-Leu-Ala-Ala-Leu-Ala-Lys-Lys-Ile-Leu-NH ₂
Tuftsins	Thr-Lys-Pro-Arg
Calcitonin-gene-related peptide (CGRP)	
	Ser-Cys-Asn-Thr-Ala-Thr-Cys-Val-Thr-His-Arg-Leu-Ala-Gly-Leu-Leu-Ser-Arg
	<div style="text-align: right;"> } Ser Gly Gly </div>
	Phe-Ala-Glu-Ser-Gly-Val-Asn-Thr-Pro-Val-Phe-Asn-Asp-Lys-Val-Val-

CGRP may be chemotactic for neutrophils or may release chemotactic factors from nearby cells (although it seems unlikely that the chemotactic factors would be derived from mast cells, since SP also stimulates mast cell secretion [97–101] yet does not promote neutrophil infiltration [62]). CGRP (2.5–1 μM) also stimulates histamine release from isolated rat peritoneal mast cells [62], but in this regard it is about 4-times less potent than SP. Histamine release from mast cells in response to CGRP is inhibited by either benzalkonium chloride (10 μM) or by the SP analogue, [D-Pro⁴, D-Trp^{7,9,10}]SP_{4–10} (10 μM) [62].

NERVE GROWTH FACTOR

Nerve growth factor (NGF), a protein capable of promoting the growth and differentiation of sympathetic and embryonic sensory neurones [117], causes a dose-dependent release of histamine from isolated rat peritoneal mast cells which is dependent upon the presence of extracellular Ca and added phosphatidylserine [118]. The secretory response elicited by NGF is non-cytotoxic, slow (5–10 min for maximum release), pH-dependent (maximal at pH 7.4), not dependent on cell-bound IgE, and blocked by polyclonal antibodies to NGF. It shows no cross-desensitization with antigenic stimulation suggesting that, like other peptide secretagogues, it acts by a different mechanism. However, its requirement for extracellular Ca distinguishes NGF [118] from other peptide secretagogues of the mast cell which can activate histamine release in the absence of extracellular Ca [79]. Interestingly, the requirement for phosphatidylserine by NGF is also shared by the lectin, concanavalin A, which is believed to act through the IgE receptor [119] and phosphatidylserine can enhance the secretory effect of antigenic stimulation [120]. Moreover, the secretory response elicited by these latter, IgE-dependent secretagogues is also dependent upon extracellular calcium [121].

Recently, NGF has been shown to cause a significant proliferation of connective tissue mast cells when injected subcutaneously into newborn (day 1) rats [122]. This effect of NGF is blocked by DSCG, which suggests that products released from NGF-stimulated mast cells are responsible (directly or indirectly) for the proliferation or recruitment of other mast cells. In adult rats, a similar proliferation of mucosal mast cells in the small intestine is known to accompany an infection by intestinal nematode, *N. brasiliensis* [123] and has also been reported to accompany the repeated injections of compound 48/80 [124]. It may be relevant in this regard that mast cells are frequently prominent in a wide variety of fibrotic conditions such as neurofibromatosis where itching around the growing neurofibroma is a common symptom [125]. Treatment of neurofibromatosis with ketotifen, a mast cell stabilizer similar to DSCG, results

in a significant improvement in the symptoms including a decrease in neurofibroma size [125]. Key components of these tumours are Schwann cells and fibroblasts. Fibroblasts have been shown to promote the growth and differentiation of murine bone marrow-derived mast cells [126] and Schwann cells are a potential source of NGF [127] perhaps capable of stimulating mast-cell secretion and proliferation.

ENDOGENOUS OPIATES

Dynorphin, α -neoendorphin and β -endorphin each produced a dose-dependent (10^{-6} M to 10^{-4} M) release of histamine from rat peritoneal mast cells but not from rat mucosal mast cells which were isolated following collagenase digestion [128]. When administered intradermally to the forearms of human volunteers, dynorphin, β -endorphin, Leu-enkephalin and morphiceptin each produced a wheal and flare reaction at nM concentrations. Mast cell degranulation was confirmed by electron microscopy of biopsy samples and by its inhibition by hydroxyzine pretreatment [129].

PARATHORMONE

Both intact bovine parathormone (PTH) and a biologically active fragment of human PTH stimulate a time-dependent release of histamine and serotonin from rat peritoneal mast cells that is dependent on the concentration of peptide, on the presence of calcium, and on a supply of metabolic energy [130]. When injected intradermally in the guinea-pig, PTH causes a pronounced increase in vascular permeability. While the physiological relevance of these findings is at present unclear, it is important to note that blood levels of PTH are elevated in advanced uraemia [131], and many of the uraemic patients show a significant increase in the number of tissue mast cells [132] and some clinical signs of possible mast-cell involvement such as generalized pruritus [133].

In other studies, mast cells have been shown to be abundant in the marrow of osteoporotic patients, and heparin, which is contained within the secretory granules of connective tissue (peritoneal)-type mast cells, has been shown to enhance bone resorption and to inhibit bone-cell replication and collagen synthesis *in vitro* [130]. Moreover, heparin is known to bind growth factors such as fibroblast growth factor and may therefore be important in limiting their availability [134]. Taken together, these various studies suggest a possible involvement of mast cells in the homeostasis of bone, but much more work is needed before any definitive conclusions can be drawn.

THROMBIN

The plasma proteinase, thrombin, a procoagulant enzyme with effects on platelets, endothelial cells and smooth muscle, has been shown to stimulate bone-marrow-derived murine mast cells to release histamine and β -hexosaminidase [135]. This secretory response is rapid, reaching a maximum in 1–2 min, and dose-dependent, beginning at about 0.1 U of thrombin and plateauing at 0.5 U thrombin.

Stimulation by thrombin does not lead to the generation of leukotriene C_4 or B_4 , whereas stimulation of the same mast cells by the calcium ionophore, A23187, does. The secretory response elicited by thrombin is prevented by preincubation with AT-III, a plasma inhibitor of thrombin, or by hirudin, a thrombin inhibitor derived from the leech [135].

GASTRIN

Gastrin I (G_{17}) is released from G cells in the gastric antrum and proximal duodenum in response to the ingestion of food [136]. Thus, G_{17} levels in blood increase to 10^{-10} M some 30–60 min after a meal and then gradually decline [137]. G_{17} is well known for its stimulatory effect on gastric acid secretion, an effect that has been reported to be blocked by antihistamines of the H_2 class [137]. Recently, G_{17} and a synthetic analogue of the carboxy-terminal region of gastrin, pentagastrin, have been shown to stimulate histamine release *in vitro* from human cutaneous mast cells at concentrations of 1–100 pM [137]. This is several orders of magnitude less than the concentrations that are required to stimulate histamine release from isolated rat mast cells. Maximum release (15%) occurred at 10^{-10} M G_{17} , while higher levels of G_{17} elicited a smaller response. The N-terminal tridecapeptide (G_{1-13}) had no effect on histamine release, nor did it inhibit G_{17} -evoked release [137]. When given intradermally, G_{17} (10^{-12} to 10^{-10} M) elicited a significant wheal and flare response in four out of six human subjects. The authors suggested that gastrin I may play a role in the postprandial episodes of hypotension that often occur in elderly patients and in the eating-related urticarias and anaphylactic syndromes that are of unknown etiology [137]. Further studies will be needed to confirm these notions.

PEPTIDE FACTORS FROM INFLAMMATORY CELLS

If peptides are involved in the local inflammatory response, one would expect their distribution to be ubiquitous. However, the available evidence using

immunocytochemical techniques and radioimmunoassay suggests that peptides such as SP, SOM, NT and CGRP have specific, highly localized distributions consistent with their presence in nerve endings or in other specialized secretory cells [27, 109, 114, 138]. Thus, aside from a possible role in neurogenic inflammation [59, 60], the described distribution of these peptides argues against their participation in generalized inflammation.

However, widespread distribution of peptide signals can be readily achieved by their production and storage in other cells of the inflammatory response. Ranadive and Cochrane [139] were the first to show that neutrophils contain cationic peptides within their cytoplasmic granules that are capable of eliciting a dose-dependent, exocytotic, secretory response from isolated mast cells. More recently, other workers have shown that the eosinophil also contains, along with major basic protein (the prominent histologic feature of eosinophils), cationic proteins [69] that are similar to those identified within the neutrophil [69]. Both of these eosinophilic proteins are capable of stimulating histamine secretion from isolated mast cells that is non-cytotoxic in nature [69]. Moreover, we [140], as well as several other laboratories [141–143], have now demonstrated an ability of the neutrophil to release products that are capable of stimulating mast-cell secretion. Evidence suggests that some of these products may be peptide in nature [143].

Acid: acetone extracts of human and rodent leukocytes (RBL-cells) have been found to contain immunoreactive SOM (iSOM) and immunoreactive SP (iSP) as determined by radioimmunoassay [144]. Quantities of the peptides varied from 325 pg iSOM/ 10^7 cells for human monocytes and 272 pg iSOM/ 10^7 cells for RBL-cells to 4.4 pg iSOM/ 10^7 cells for human T cells. iSP was highest in murine bone marrow-derived mast cells (64 pg iSP/ 10^7 cells) and RBL-cells (23 pg iSP/ 10^7 cells) and lowest in human T and B lymphocytes (2.5 and 1.2 pg iSP/ 10^7 cells, respectively). Interestingly, the murine bone marrow-derived mast cells had the highest ratio of iSP to iSOM. Preliminary chromatographic results show a large and a small SOM (SOM-28 and SOM-14, respectively). SOM-14 (3×10^{-9} M) has been shown to inhibit histamine release and LTC₄ generation from murine bone marrow-derived mast cells stimulated by anti-IgE serum [144].

Several other cell types have also been shown to secrete histamine-releasing activity, some of which may be peptide in nature (although more work is necessary for a definitive characterization). For example, human lung macrophages cultured for 24 h have been shown to release a soluble factor (12 and 30 kDa) that stimulates isolated human lung mast cells and human basophils to release histamine [145]. The generation and release of this factor developed over time (> 1 h) and was blocked by cycloheximide, indicating that protein

synthesis is required for its generation and/or release. In this regard it is similar to other lymphokines such as IL-1 [146]. Stimulated human platelets also release a soluble, heat-labile substance that causes histamine release from human basophils [147] and media derived from human neutrophils contain a factor (most likely peptide in nature) that causes histamine release from RBL-cells in a dose-dependent manner [148]. When injected intradermally, this factor causes an increase in vascular permeability in both rats and guinea-pigs, and this effect is blocked by antihistamine pretreatment.

Several other factors – some IgE-dependent, others IgE-independent – have been reported to modulate histamine release from basophils and mast cells [149, 150]. However, these factors, which are produced by mononuclear cells, have not been chemically characterized or well defined.

INTERLEUKIN-1

Interleukin-1 (IL-1) produced by monocytes and several other cell types [70, 146] has a wide array of biological properties, including T cell activation and inflammatory interactions with muscle, liver, fibroblasts, brain and bone [70, 146]. IL-1, both natural and recombinant, has been shown to release histamine from human basophils and from human adenoidal mast cells [70, 146, 151] and this release was abolished by an IL-1 antibody. However, the average release produced by 10 units of IL-1 was less than 20% and there was considerable variability between populations of basophils in the extent of histamine release. Moreover, the secretory response elicited was quite slow (within 15 min) compared with that of other peptides [151]. Desensitization of the basophils by anti-IgE serum had no effect on the subsequent IL-1 response, suggesting different mechanisms of action [151], as has been the case with other peptides. Interestingly, the portion of the IL-1 molecule that is responsible for its immunostimulatory activity appears to be separate from that portion responsible for its proinflammatory effects [152]. However, that portion of the molecule responsible for eliciting basophil and mast-cell histamine release has not as yet been defined.

INTERLEUKIN-3

Interleukin-3 (IL-3), a glycoprotein lymphokine from T cells, stimulates the growth of murine mast cells, neutrophils, and macrophages from haemopoietic progenitor cells [71, 153]. Thus, cultures of murine bone marrow or spleen cells supplemented with IL-3 have been shown to generate cells that have many of the characteristics of mucosal mast cells [71, 153]. The release of IL-3 *in vivo*

is achieved when T cells are activated by antigenic stimulation. When the antigenic challenge is of sufficient magnitude, such as occurs in some parasitic infestations, IL-3 is found in the systemic circulation, although its half-life is short [71, 153]. Whether this increase in IL-3 is responsible for the proliferation of mucosal mast cells that accompanies infection of rats with the parasitic larvae of *N. brasiliensis* is unclear. Likewise, the precise role of IL-3 in regulating mast-cell growth and differentiation awaits further experimentation.

PEPTIDES GENERATED LOCALLY FROM CIRCULATING PRECURSORS

Specific peptide signals can also be produced locally by the action of secreted enzymes on circulating inactive precursors. Well-known examples of such peptide signal generation are the renin-angiotensin system [154] and the kallikrein-bradykinin system [155]. In each, there is ubiquitous distribution of the precursor molecule within the vascular compartment and in each, the generation of the active peptide (angiotensin II or bradykinin) occurs rapidly as a consequence of a locally active enzyme (renin-converting enzyme or kallikrein) [155].

BRADYKININ

Perhaps the best characterized and most familiar locally generated peptide is bradykinin (Bk), a nonapeptide (*Table 4.4*), generated from circulating high-molecular-weight kininogen by the action of plasma kallikrein, an enzyme activated from prekallikrein by activated Hageman factor [72, 155]. Bk has a variety of biological effects, including stimulation of smooth muscle contraction, increasing vascular permeability, promoting vasodilatation, and the stimulation of pain [72, 155]. The intradermal injection of Bk causes a rapid vasodilatation and an increase in vascular permeability (but the area of erythema is less than that found with an intradermal injection of histamine because there is no axonal reflex involved). These effects are accompanied by an intense burning pain centred around the site of the injection [72]. Bk is rapidly inactivated by carboxypeptidase *N* and by a dipeptidase (kininase II), so the reliable measurement of Bk in the blood is quite difficult.

Bk has been shown to stimulate histamine release from isolated peritoneal rat mast cells [30, 87] and this secretory response, like that elicited by other peptides, requires a source of metabolic energy and is prevented by depletion of cellular Ca [30, 87]. The subsequent treatment of such cellular Ca-depleted mast cells with Bk produces an inactivation or desensitization phenomenon to the subsequent addition of extracellular Ca (secretion declines as the time

between stimulation and the addition of Ca increases) [87]. Interestingly, mast cells inactivated to Bk are also inactivated to stimulation by compound 48/80 or by polymyxin B, which suggests a common site of action. These inactivated mast cells do respond to stimulation by the calcium ionophore, A23187, in the presence of extracellular Ca [87], demonstrating that the exocytotic step in these cells is functional and suggesting that inactivation involves steps before Ca-dependent exocytosis.

Bk is thought to be involved in a number of allergic and inflammatory conditions [72, 155]. For example, in atopic individuals, kinin levels in the nasal secretions have been shown to increase significantly following challenge by allergen. Moreover, the severity of symptoms appears to be related to the level of kinin [72].

PEPTIDES GENERATED FROM ALBUMIN

Recently, workers in our laboratory, in collaboration with Dr. R.E. Carraway of the University of Massachusetts Medical Center, have established the ability of specific acid proteinases to generate from albumin biologically active peptides that can stimulate mast cell secretion [73, 156]. We and others [74] have found that treatment of albumin with pepsin generates a neurotensin-related peptide (NRP) (also called kinotensin) [73, 74] with the amino-acid sequence shown in *Table 4.2*. Like NT, with which it shares some sequence homology (*Table 4.2*), NRP can stimulate isolated peritoneal mast cells to release histamine (*Figure 4.6*) and can increase vascular permeability when injected intradermally [73]. Moreover, NRP binds to NT receptors from brain with high affinity [73]. Interestingly, when injected intravenously into anaesthetized rats, NRP (even at 10 nM) does not cause a significant increase in the level of plasma histamine. Thus, the levels of plasma histamine (ng/10 μ l) in anaesthetized rats as determined by radioimmunoassay [79] 3 min after the intravenous injection of NT (0.75 nmol), saline (0.4 ml) or NRP (100 nmol) were 1.32, <0.3 and <0.3 respectively. NRP thus differs significantly from NT in this regard [79]. Our studies show that NRP can be generated from human, canine, bovine, porcine and rat plasma and that these NRPs have similar amino-acid sequences and dose-response relationships when applied to the rat serosal mast cell (*Figure 4.6*).

Importantly, the amino-acid sequence of bovine NRP, with the exception of a single substitution of Tyr for Leu at the N-terminal, is contained within the reported sequence for bovine albumin residues 137 to 149 [73].

Other collaborative work from our laboratories has recently shown a second biologically active peptide to be generated by cathepsin D (as well as pepsin)

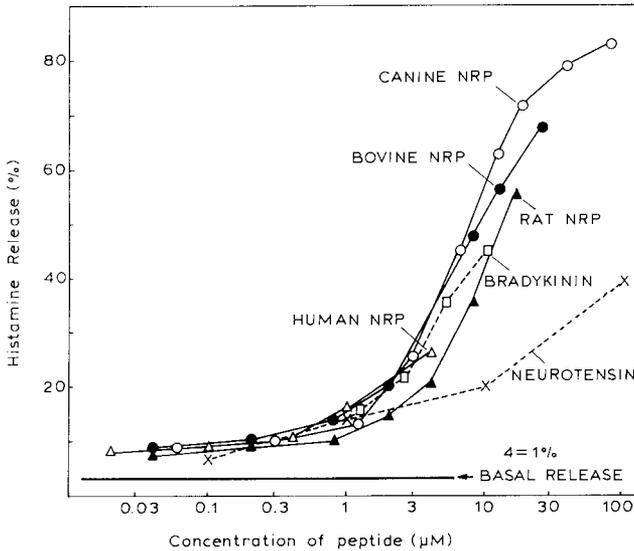

Figure 4.6. Log dose-response relationships for the effects of synthetic neurotensin, synthetic bradykinin, and various preparations of NRP on the release of histamine from isolated rat mast cells [73]. Each point is the mean obtained for two separate incubations.

treatment of albumin. This second peptide, called histamine-releasing peptide (HRP) because of its pronounced histamine-releasing effect when added to isolated mast cells, has a sequence similar to that of NRP (Table 4.2) but is generated in some 20-fold excess of NRP by proteinase treatment of albumin. We have hypothesized that these peptides may be produced locally at sites of inflammation [155a].

This suggestion is supported by our recent observations [156] that medium derived from neutrophils stimulated by the synthetic chemotactic peptide, fMet-Leu-Phe, can generate, in a time- and concentration-dependent manner, significant quantities of histamine-releasing activity (HRA) when incubated with serum albumin (Figure 4.7). This HRA is most likely peptide in nature as it is destroyed by carboxypeptidase and is extractable into acid-acetone [156]. Significantly, its generation is blocked by the addition of pepstatin – an inhibitor of acid proteinases like pepsin and cathepsin D [156]. Our working hypothesis for how NRP and HRP might be involved in an inflammatory response is shown in Figure 4.8. In this model, an inflammatory response is initiated by stimulation of mast cells by direct injury, by complement fragments, by peptides (for example SP, CGRP) released from nerve endings or by other ill-defined

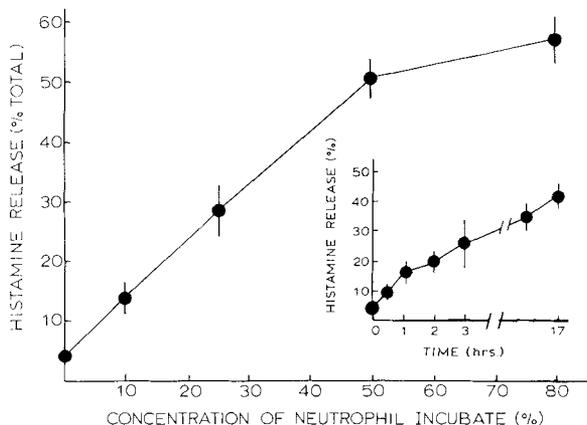

Figure 4.7. Histamine release from mast cells in response to various dilutions of HRA generated from bovine serum albumin (BSA) by medium derived from stimulated rat neutrophils [156]. Neutrophils $(50-100) \times 10^6/\text{ml}$ were stimulated with FMLP ($10^{-5} M$), the medium removed and incubated with BSA (10 mg/ml) at pH 4.5 for 18 h at 37°C. It was then boiled and centrifuged ($11,000 \times g$ for 30 s), the supernatant fraction was removed, its pH was adjusted to 7.2 and it was added, at various dilutions, to suspensions of mast cells. Histamine release was then measured after 10 min. As the amount of generated HRA was increased histamine release increased to a maximum at $57 \pm 4\%$. Mean \pm S.E.M., $n = 5$. Inset: Time-course of generation of HRA as assayed by histamine release from isolated mast cells. HRA was generated as before using 50×10^6 neutrophils/ml. Aliquots were removed at the indicated times and assayed (at 50% dilution) for HRA. Note that there is a significant generation of HRA by 2 h. Mean \pm S.E.M., $n = 3$.

factors. Mediators released during this initial secretory response produce an immediate increase in local blood flow by vasodilation, an increase in vascular permeability with accompanying plasma extravasation, and the eventual chemotactic emigration of neutrophils (and later monocytes) to the site of inflammation. At the site of inflammation, the neutrophil becomes a highly efficient phagocyte and in the process releases its granule enzymes (among which are cathepsins) to the extracellular space. Once in the tissue space, enzymes like cathepsin D can generate biologically active peptides from albumin precursors which have entered the tissue space as a result of the increased vascular permeability. These locally generated peptides (for example, NRP or HRP) can then initiate a second wave of mast cell secretion such as occurs in late phase reactions of the allergic response [157]. The accompanying release of proteinases from secreted mast cell granules could act to degrade the peptide signals, thereby modulating the response. These generated peptides may also have other biological activities on other cells of inflammation (for

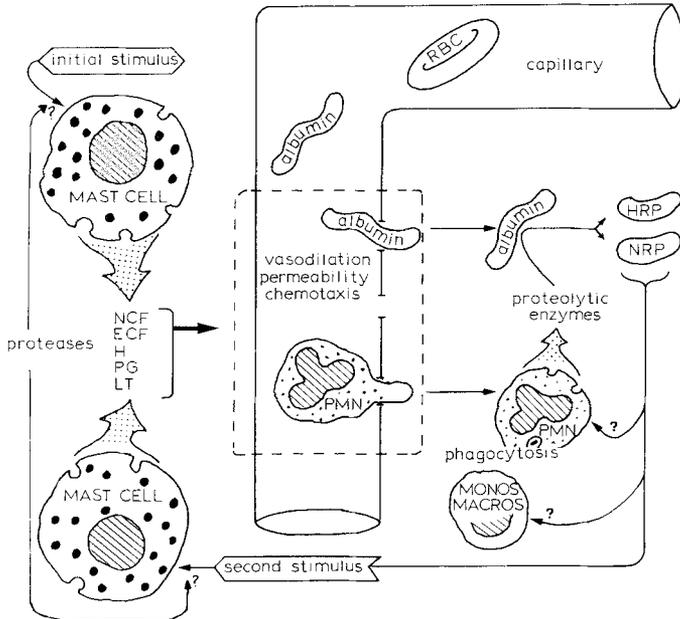

Figure 4.8. Hypothesis for the local generation of mast-cell-stimulating peptides by the action of neutrophil-derived enzymes on albumin. Initial stimulation of the mast cell by any of a variety of agents causes the release of preformed histamine (H); neutrophil and eosinophil chemotactic factors (NCF, ECF) and enzymes and the de novo synthesis of prostaglandins (PG) and leukotrienes (LT). These agents increase vascular permeability and vessel diameter. As a result, albumin and later neutrophils (PMN) enter the tissue space where the latter undergo phagocytosis and the secretion of proteolytic enzymes to the extracellular space where they act on albumin to generate NRP (neurotensin-related peptide) and HRP (histamine-releasing peptide). These newly formed peptides then act as a second stimulus to the mast cell. In addition NRP and HRP may affect other immunocompetent cells such as monocytes, macrophages or eosinophils.

example monocytes, neutrophils, or eosinophils) to promote additional mediator release (for example, lymphokines and monokines). The validity of this hypothesis awaits further experimentation.

MECHANISM OF PEPTIDE ACTION

BINDING

Evidence for the specific binding of peptides to isolated mast cells is limited. The most detailed study to date has been done by Lazarus *et al.* [86, 158] who

studied the binding of ^{125}I -labelled neurotensin (^{125}I -NT) to isolated rat peritoneal mast cells. Using a hypotonic buffer system consisting primarily of 80 mM sucrose, the binding of labelled NT was determined under equilibrium conditions. Specific binding reached a maximum at 10 min with a reported K_D of 154 mM at pH 6.8–7.2, which is about 20-fold higher than reported for the binding of ^{125}I -NT to brain synaptosomes (154 mM versus 1.27 pM) [86]. The presence of cations strongly inhibited the binding of NT. For example, Ca and Mg, at 1.5 mM and 4 mM (respectively) inhibited the binding of ^{125}I -NT by 50% and CaCl_2 and NaCl displaced 60% of the total bound ^{125}I -NT in about 6 min. When the cells were bathed in physiological concentrations of these cations, the specific binding of NT was below detectable limits [86].

The reported binding of ^{125}I -NT was effectively competed for by BK (100% effective) and by xenopsin (60% effective), a peptide with sequence homology to that of NT (*Table 4.2*). While both Bk and xenopsin have been shown to stimulate histamine release from isolated mast cells [30, 72, 87, 159] and to alter cutaneous vascular permeability when injected intradermally [72, 159], BK does not interact with NT receptors in other systems [160]. Other peptides, including SP, which has significant histamine-releasing activity [30, 158], and SOM, which stimulates histamine release at concentrations greater than 10^{-8} M [88, 110, 111] but which inhibits histamine secretion at lower concentrations [88, 113], showed no competition with NT for binding [158].

Changes in the C-terminal region of NT from Pro¹⁰ to Leu¹³ greatly reduced the binding [158], confirming results obtained from other tissues [38]. On the other hand, changes in the residues from pGlu¹ to Pro⁷ had little effect on binding, while substituting D-Arg for L-Arg at Arg⁸ or at Arg⁹ caused an increase or a decrease, respectively, in binding. The hydroxy groups of tyrosine are not involved in the interaction of NT with its reported binding site. However, the L-configuration of the amino acids is critical.

In summary, the binding of NT to its reported binding site on the rat peritoneal mast cell, as reported by these authors [86, 158], requires:

- (1) a free C-terminal carboxyl group;
- (2) a (+) charge at position 8 or 9;
- (3) the residues from Arg⁸ to Leu¹³ to be intact (the N-terminal region is not required for binding);
- (4) both Arg⁸ and Arg⁹ for optimal recognition, with Arg⁸ being more important than Arg⁹.

As the buffer used in these studies [86, 158] is hypotonic to rat peritoneal mast cells, incubations of greater than 10 min result in significant cell swelling, a large increase in membrane permeability, as judged by trypan blue staining, and eventually cell lysis. This raises some concern as to the location of the site

to which the ^{125}I -NT is binding. It is known, for example, that the mast-cell granule matrix has a high capacity to bind positively-charged molecules [18]. Furthermore, the lack of measurable binding at physiologically relevant concentrations of Na^+ and Ca^{2+} is difficult to reconcile with the observations of detectable secretion induced by low (10^{-8} M) concentrations of NT [79].

Whether the putative binding sites on the mast cell identified with ^{125}I -NT are functional – that is, do they mediate the NT-induced histamine secretion – cannot at present be directly determined. Structure–activity studies of the ability of NT-fragments to release mast-cell histamine from perfused rat hind-quarters [38] show marked differences with the data obtained from the binding studies described above with peritoneal mast cells. Interestingly, the results of these structure–activity studies do, however, agree quite well with those values derived from NT binding assays using rat brain [38]. This suggests that, if ^{125}I -NT binds to peritoneal mast cell receptors that are functionally involved in the NT-induced histamine release, these receptors differ in their recognition site from other functional NT receptors and from those on mast cells in the rat hindquarters. This implies that either different mast-cell populations have pharmacologically distinct NT receptors or the binding sites for NT identified on the rat peritoneal mast cell are not involved in histamine secretion [38, 160].

We also have attempted to study the binding of a peptide to the isolated rat mast cell using ^{125}I -[Tyr¹]-somatostatin. [Tyr¹]-SOM has histamine-releasing activity similar to that of SOM. For these experiments, mast cells ($(1.5\text{--}2.0) \times 10^5$ cells) were incubated at 4°C for 10 min in 100 mM Tris-acetate buffer, (pH 7.0) containing BSA (1 mg/ml), sucrose (10 mM), bacitracin (0.1 mg/ml), and EGTA (0.1 mM). Each binding assay was performed in triplicate and each sample contained 5–60 fmol of ^{125}I -[Tyr¹]-somatostatin. The mast cells used for these experiments were metabolically inhibited by antimycin A (10^{-6} M) and deoxyglucose (10^{-4} M) to prevent both the release of granule proteases and the exposure of granule matrix by degranulation. At the end of the incubation period, the cell suspension was rapidly filtered using Whatman GF/D glass-fibre filters which had been previously equilibrated with polylysine (10^{-5} M) to reduce nonspecific binding to the filter. The filters were then quickly washed (4–5 s) with an excess ($40\times$) of cold (4°C) 2% BSA solution, dried and counted. As shown in *Figure 4.9* the binding of ^{125}I -[Tyr¹]-SOM was saturable, reaching a maximum after 5 min at 3.5 fmol ^{125}I -SOM bound/ 2.5×10^5 mast cells. [Tyr¹]-SOM was most effective in competing with ^{125}I -[Tyr]-SOM for binding, while both NT and SP (each at 10^4 excess) failed to compete for ^{125}I -[Tyr¹]-SOM binding. Interestingly, compound 48/80 (at $5\ \mu\text{g/ml}$) was able to reduce the amount of ^{125}I -[Tyr¹]-SOM bound by some 15%. The K_D for the binding of [Tyr¹]-SOM as determined from Scatchard

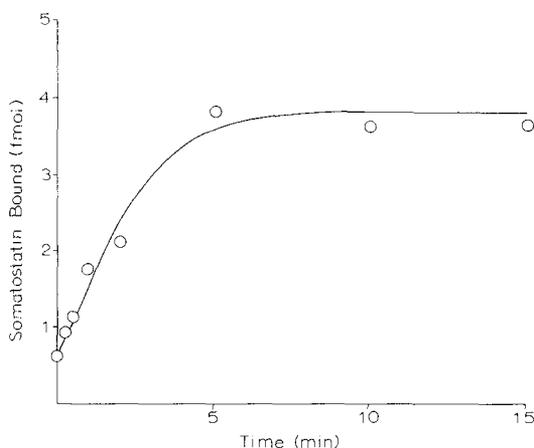

Figure 4.9. Time-course of ^{125}I -Tyr-SOM binding. Mast cells and 30 fmol of ^{125}I -[Tyr¹]somatostatin were incubated and assayed at various time intervals. The results are from one experiment done in triplicate. (Witkowski and Cochrane, unpublished results.)

analysis and from the concentration of unlabelled SOM giving 50% displacement was 1.52×10^{-10} M. This affinity is within the range of that determined for SOM receptors on human mononuclear leukocytes [161] but 10-times greater than that determined for guinea-pig and rat pancreatic acinar cells [162, 163] or for rat anterior pituitary membranes [164]. The K_D determined in our studies is consistent with the reported findings that SOM, at low concentrations (about 10^{-10} M), has a significant inhibitory effect on the secretory response of the cutaneous mast cell to NT [88] and on the ability of the human basophil to release histamine, while at higher concentrations ($> 10^{-9}$ M) it is stimulatory [113]. However, in our studies a large amount of nonspecific binding was encountered. Thus, the results of these experiments must be interpreted with considerable caution, even though they are consistent with those reported by earlier workers [161].

STRUCTURE-ACTIVITY RELATIONSHIPS

In their initial studies on the effects of vasoactive peptides on mast-cell secretion, Johnson and Erdos [31] concluded that the ability of peptides to elicit a secretory response from mast cells depended upon the number of basic groups a peptide contained, and not on the structure of the N-terminal or C-terminal amino acids *per se*. They found, for example, that *Polistes* kinin, with

5 positively charged groups, was considerably more active than either Met-Lys-bradykinin or SP, each of which have three basic (positive) groups, and these two peptides, in turn, were significantly more active than bradykinin, which has only two basic groups. Since then, a British team [165–169] as well as several other laboratories [95, 99, 104, 108, 170–175] have used the relationship between peptide structure and its activity as a means of understanding peptide-secretagogue action. Among the many peptides, associated fragments and analogues that have been studied, by far the most is known about SP.

Studies with SP have determined that the N-terminal basic amino-acid residues, Arg¹ and Lys³, are required for histamine releasing activity [99, 108]; substitution of neutral amino acids in the N-terminal region [108] significantly reduces histamine-releasing activity (recall that studies with ¹²⁵I-NT had determined that the N-terminal region was not required for binding [86, 158]). However, while basic amino acids at the N-terminal of the peptide are clearly important, the N-terminal sequence is not by itself sufficient for full histamine-releasing activity. This is supported by the observations that amino-acid substitution in the C-terminal region of SP can give rise to an increase in histamine-releasing activity [99, 172], while reducing the length of the C-terminal region decreases the ability of the peptide to stimulate histamine release (*Figure 4.10*).

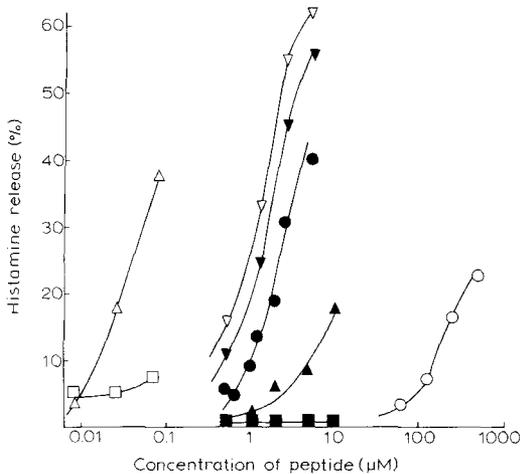

Figure 4.10. Dose-relationships for histamine release from rat mast cells induced by a variety of peptides [99]. No calcium was added to the extracellular medium. Each point is the mean of two or more determinations: Δ, poly(L-lysine) (molecular weight 30,000–70,000); □, succinylated poly(L-lysine) (molecular weight 30,000–70,000); ∇, [D-Phe⁷]SP₁₋₁₁; ▼, [D-Pro², D-Phe⁷, D-Trp⁹]SP₁₋₁₁; ●, SP₁₋₁₁; ▲, eleidoisin-related peptide; ■, eleidoisin; ○, N-terminal tetrapeptide of substance P.

For example, the N-terminal sequence of SP, (SP₁₋₄) Arg-Pro-Lys-Pro (which lacks the C-terminal components) is about 150-times less active than SP₁₋₁₁ itself in eliciting histamine release [99, 170], while the longer N-terminal sequences, SP₁₋₉ and SP₁₋₈, show approximately two-thirds of the histamine-releasing activity associated with the full molecule (SP₁₋₁₁) [99, 170]. Further shortening of the N-terminal region by removal of the next amino acid, Phe⁸, to give SP₁₋₇, results in a 10-fold loss of activity. Removing the next amino acid, Phe⁷, to give SP₁₋₆ causes a 100-fold decrease in secretagogue activity. Thus SP₁₋₉ > SP₁₋₈ > SP₁₋₇ > SP₁₋₆, in terms of histamine release (Figure 4.11) [99]. Interestingly, substitution at the 7 position with D-phenylalanine (for L-Phe) giving [D-Phe⁷]SP₁₋₁₁ yields a peptide that is more active than SP₁₋₁₁. From these experiments, it is clear that both the basic, N-terminal portion as well as the C-terminal region of SP are required for full activity and that the phenylalanines at positions 7 and 8 are particularly important for full secretory activity.

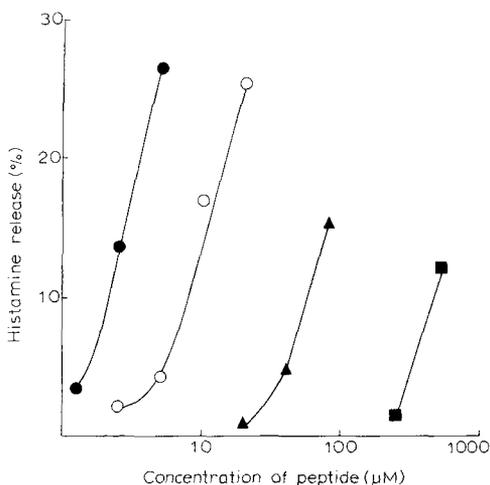

Figure 4.11. Comparison of the histamine-releasing activity of three fragments of SP with decreasing numbers of C-terminal amino acids [99]; ●, SP₁₋₁₁; ○, SP₁₋₈; ▲, SP₁₋₇; ■, SP₁₋₆.

The significance of the positive charge at the N-terminus is demonstrated by the fact that SP-related peptides (Table 4.3) which lack basic amino acids at the N-terminal region (such as SP₃₋₁₁ or SP₄₋₁₁), physalemin, [*p*-Glu⁶-*p*-amino-Phe⁷]SP₆₋₁₁ and eledoisin (Figure 4.10), are without histamine-releasing activity [99]. Exposing a basic amino acid at the N-terminal end (as

in eledoisin-related peptide) imparts histamine-releasing activity (about 20% that of SP) to a peptide that is otherwise inactive (for example, eledoisin).

A clue as to why the cationic N-terminal region and the hydrophobic C-terminal portion of SP are required for full histamine-releasing activity comes from studies of the electrical conductivity of black lipid membranes in the presence of peptides. Using SP, these authors [176] concluded that SP probably binds by its N-terminal region to negatively charged sites on membrane lipids, while the C-terminal portion of the molecule penetrates the hydrophobic core of the lipid bilayer, which could induce an increase in membrane permeability or a slight alteration in membrane conformation.

Studies with analogues of NT have also shown that a cluster of basic amino acids at the N-terminal coupled with a hydrophobic C-terminal region is optimal for histamine release [38, 173]. Thus, the C-terminal octapeptide of NT, NT₆₋₁₃, is more active in releasing histamine than the C-terminal hexapeptide, NT₈₋₁₃ (the ED₅₀ values being 13 μ M and 90 μ M, respectively) [95] and each is more active than NT₁₋₁₃ itself [79]. This suggests, first, that Lys⁶ and Pro⁷ are particularly important to the histamine-releasing ability of NT and, secondly, that the distance between the basic and hydrophobic regions is important. These authors [95] have speculated that Lys⁶ may add the necessary positive charge, while Pro⁷ may affect the tertiary structure of the peptide such that the Arg⁸-Arg⁹ grouping is oriented in a particular fashion which allows optimal binding and thus maximum release. Since they found little histamine-releasing activity by the native peptide (NT₁₋₁₃), they suggested that limited proteolysis of NT₁₋₁₃ to yield shorter fragments (for example, NT₆₋₁₃, NT₈₋₁₃) may be an important step in the ability of NT to elicit histamine secretion from mast cells. However, recent work from our laboratory together with Dr. R.E. Carraway suggests that, while degradation of NT does most likely occur as a result of mast-cell enzymes, the C-terminal region of NT is most likely affected to give NT₁₋₁₂, an inactive fragment.

Studies from our laboratory using various analogues of NT₈₋₁₃ have likewise found some remarkable differences in histamine releasing activity, when the C-terminal amino acid of the molecule is varied. In these experiments, purified rat serosal mast cells were incubated for 10 min in Locke buffer containing 0.2 mM Ca and exposed to the stimulus for 10 min, whereupon histamine release was determined. As has been previously reported by others [95], NT₈₋₁₃ was more active (45% release) than NT₁₋₁₃ (21% release). Substituting Val for Leu at position 12 slightly decreased histamine release to 31%. However, decreasing the hydrophobic nature of the C-terminal amino acid significantly altered the histamine-releasing activity. Thus, substitution of Asn, Gly or Asp for Leu¹³ reduced histamine-releasing activity to spontaneous levels

(< 4%), while substituting Ile or Val for Leu¹³ had little effect on activity (39% and 36%, respectively). These results provide yet another example of the importance of the C-terminal region for the histamine-releasing activity of NT and corroborate earlier findings of the importance of the hydrophobic C-terminal region of NT to its mast-cell-stimulating activity [95, 99, 104, 108, 165–169].

Like NT and SP, the conformation of SOM is critical for optimal histamine release. SOM requires a positive charge at the amino terminus (like NT and SP) and the amino acids, Lys⁴ and Lys⁹, appear particularly important to its histamine-releasing activity; D-Lys⁴ substitution reduces SOM activity by 80% while D-Lys⁹ substitution increases it some 4-times [171]. Cleavage of the disulphide bond in SOM results in a 30–50% reduction in its histamine-releasing activity [171]. The results of various amino acid substitutions on the histamine-releasing ability of SOM analogues are summarized in *Figure 4.12* [171].

In addition to the necessity for basic amino acids at the N-terminal region in eliciting mast cell histamine release, a stereospecific component to peptide action has been demonstrated [167]. When the core peptide of corticotropin,

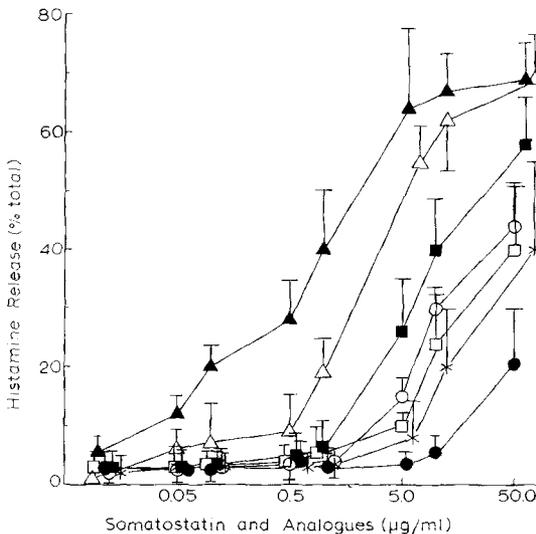

Figure 4.12. Dose-response curves of somatostatin and analogues on histamine secretion from purified rat peritoneal mast cells [171]. Somatostatin (x), [D-Lys⁹]-somatostatin (●), [D-Lys⁴]-somatostatin (○), [Tyr¹]-somatostatin (▲), Des,[Ala¹,Gly²]-desamino-[Cys²]-somatostatin (△), dihydro-somatostatin (■), and bis-S-acetamidomethyl-dihydro-somatostatin (□).

which is composed of the basic L-amino-acid sequence, Lys-Lys-Arg-Arg-OMe, was replaced by identical D-amino acids, its histamine-releasing activity was reduced by 100-fold. Interestingly, pairing the basic amino acids (that is, Lys-Lys-Arg-Arg-O-Me) resulted in a greater histamine-releasing activity than when the basic amino acids were alternated (that is, Lys-Arg-Lys-Arg-O-Me) even though the net positive charge remained the same. This suggests that the ability of peptides to stimulate mast-cell histamine secretion depends on the presence of L-amino acids, the degree of N-terminal positive charge (that is, basic amino acids), and on the hydrophilic-hydrophobic balance [167].

To summarize, the picture that has emerged from these various studies of peptide structure-activity is as follows:

- (1) Histamine-releasing activity requires a cluster of basic amino acids at the N-terminal region [169], with at least two basic amino acids appearing to be essential [172, 174].
- (2) The C-terminal region must be predominantly hydrophobic, as increasing the hydrophobic nature by amino acid substitution slightly increases the histamine-releasing activity, while increasing the hydrophilic nature of the C-terminal decreases histamine-releasing activity [99, 169, 170-176].
- (3) Neither the hydrophilic portion nor the hydrophobic portion of the peptide is by itself sufficient for optimal secretagogue activity [99, 104, 108, 165-169, 170-175].
- (4) The C-terminal hydrophobic region of the peptide has been suggested to insert into the lipid bilayer of the membrane, perhaps forming an α -helical structure after insertion [169, 174, 175].
- (5) Proper insertion of the hydrophobic C-terminus may enable the cationic region at the N-terminus to interact electrostatically with negatively charged polar membrane components [175].
- (6) The overall effect of the above interactions could be an aggregation of membrane protein components and an overall decrease in their mobility within the membrane [174] and ultimately the activation of secretion.

STIMULUS-SECRETION COUPLING

Defining the biochemical mechanisms that couple stimulation at the cell surface to secretion by exocytosis is a major focus in biological research. In the mast cell, the steps by which immunologic secretagogues (for example, specific antigen, anti-IgE antibodies) activate a secretory response have been extensively studied and there are several reviews covering this area [12-14, 16, 121, 177].

Peptide secretagogues of the mast cell have not been well studied at the level of stimulus-secretion coupling. Evidence [87, 121] suggests, however, that they share a common mechanism of action with the classic, well-studied, non-immunologic histamine releaser, compound 48/80. Thus, it is my contention that what we have learned regarding the action of compound 48/80 in initiating mast-cell secretion, may be applied in a general way to the secretagogue actions of peptides such as SP, NT, SOM and others.

Clearly, the most studied aspect of stimulus-secretion coupling is the requirement for calcium. That Ca ions are essential for many cellular processes has been known since the days of Sidney Ringer [178]. The eloquent studies of Douglas and his collaborators [179, 180] and others [181] firmly established the necessity for Ca in exocytotic secretion and set forth the notion that an increase in the level of free intracellular Ca, $[Ca^{2+}]_i$ was responsible for initiating exocytosis. Evidence for increases in the level of intracellular free Ca as prerequisite for initiating exocytosis by cell surface stimulation is now available from studies using a variety of systems [181–183].

In the mast cell, evidence for the mobilization of Ca from either extracellular or intracellular pools as an essential step in the initiation of histamine secretion comes from the following observations:

- (1) Removal of Ca reduces or prevents secretion initiated by either immunologic or non-immunologic stimulations [87, 184–187] and secretion can be restored by the reintroduction of Ca but not Mg [87, 184, 188].
- (2) There is an uptake of ^{45}Ca from the medium that accompanies stimulation of the mast cells and this uptake precedes the release of histamine [186, 188, 189].
- (3) The addition of Ca to the mast cell interior by ionophore [185, 190, 191], by iontophoresis [192], or by Ca-filled liposomes [193] initiates a secretory response.
- (4) The level of free intracellular Ca has been reported to rise in mast cells [194] and in RBL-cells [195] as measured by the fluorescent dye, quin2 (although there are doubts as to the usefulness of this technique in heavily granulated cells like mast cells, since quin2 has been shown to enter the granular matrix and to be released upon stimulation [196]).
- (5) There is evidence for a transient change in the permeability of the mast-cell membrane to Ca ions following stimulation by immunologic [186] or non-immunologic [87, 188] secretagogues. Moreover, while results of earlier experiments using patch-clamp techniques [197] suggested that physiologically relevant channels were not involved, the results of recent experiments demonstrated the presence of three ionic mechanisms involved in elevating intracellular free Ca [198].

Non-immunologic secretagogues such as peptides and compound 48/80, require Ca primarily mobilized from a cellular pool [87, 183, 187, 198]. This idea is supported by the following observations: removal of extracellular Ca reduces only slightly histamine secretion in response to peptide or 48/80 stimulation [87, 188]; prolonged incubation in Ca-free medium containing chelating agents abolishes peptide stimulated secretion [87, 188]; however, this depleted cellular pool of Ca can be replenished by a brief exposure (<5 s) to small amounts (<0.5 mM) of extracellular Ca [199]. Single cell analysis using patch-clamp techniques and the direct measurement of $[Ca^{2+}]_i$ by the indicator dye, fura-2, has shown a large increase in $[Ca^{2+}]_i$ following stimulation by compound 48/80 or SP [198]. The location of this cellular Ca pool and the mechanisms by which peptide secretagogues activate it are, however, unclear (although the recent experiments [198] have implicated cyclic AMP and inositol trisphosphate (IP_3)).

While the pools of Ca required (cellular or extracellular) distinguish non-immunologic peptide secretagogues from the classic immunologic secretagogues, peptide (non-immunologic) stimulation of the mast cell differs from IgE-dependent (immunologic) stimulation in a number of other important ways [86a]:

- (1) Stimulation of mast cells by peptides [86a] or by compound 48/80 [86a, 200] is not accompanied by an increase in the methylation of membrane lipids. In contrast, IgE-dependent stimulation of the mast cell results in an increase in the methylation of specific membrane phospholipids [200, 201] and IgE-dependent stimulation of histamine release is inhibited by agents that block this enzymatic methylation [200, 201].
- (2) Mast cells desensitized to stimulation by IgE-dependent agents still respond to peptide stimulation [86a].
- (3) Saturation of the IgE-receptor by IgE or the removal of cell-bound IgE, has no observable effect on peptide stimulation of histamine secretion [86a].
- (4) Desensitization (inactivation) of mast cells to a particular peptide (for example, bradykinin) or to compound 48/80, desensitizes the mast cells to further stimulation by another peptide or by compound 48/80 but not to IgE-dependent stimulation [3, 86a, 87]. This suggests that peptides (and 48/80) share a common mechanism of action in eliciting histamine secretion and that they compete for a common binding site.
- (5) Rat peritoneal mast-cell exocytosis (as monitored by membrane capacitance measurements) in response to either antigenic stimulation or to the intracellular perfusion with guanine nucleotides (for example, $GTP[\lambda S]$), occurs after a measurable lag period which has been suggested to be due to the involvement of a GTP-binding regulatory protein [202]. In contrast, stimula-

tion by compound 48/80 (100 $\mu\text{g/ml}$) shows no measurable lag period and thus it has been suggested that compound 48/80 acts at a site after the GTP-binding regulatory protein [202]. However, other workers [203, 204] have found that *Pertussis* toxin, which promotes the ADP-ribosylation of the α -subunit of the G_{Ni} protein thereby rendering it inactive, causes a concentration-dependent inhibition of Ca-induced histamine secretion from ATP-permeabilized mast cells to which a non-hydrolyzable GTP-analogue [Gpp[NH]p] was added. Similar results were obtained when compound 48/80 was used to stimulate intact mast cells. These later results suggest that guanine-nucleotide regulatory proteins may in fact be involved in both secretory response elicited by non-immunologic agents such as 48/80 and that elicited by Ca.

In many systems the mobilization of Ca from cellular pools in response to cell-surface stimulation is now thought to be accomplished by the enzymatic generation of specific inositide phosphates such as inositol trisphosphate (IP_3), which then act on intracellular compartments (for example, endoplasmic reticulum) to release stored Ca [205, 206]. The precursors of the inositide phosphates are the *myo*-inositol phosphates which include: phosphatidylinositol (PI), phosphatidylinositol 4-phosphate (PIP) and phosphoinositide 4,5-bisphosphate (PIP_2 or triphosphoinositol). While these compounds account for less than 10% of the total phosphatides in the cell, PI accounts for 90% of the inositides [205]. Receptor occupancy has been shown in many systems [205, 206] to result in the hydrolysis of the inositides with the subsequent release of inositol phosphates such as water-soluble IP_3 and 1,2-diacylglycerol (a lipophilic component). This reaction requires the activation of the membrane enzyme, phospholipase C (PIP_2 -phosphodiesterase), as a result of the activation of a G protein complex [205, 206]. In general, G proteins have been shown to have three polypeptide chains: an α chain (with guanine nucleotide binding activity), a β chain, and a λ chain. When guanine nucleotide diphosphate (GDP) is bound to the α subunit, the three subunits are associated into an $\alpha\beta\lambda$ complex and the phospholipase C enzyme is relatively inactive. Receptor occupancy by the appropriate ligand results in the displacement of GDP by GTP, which in turn prompts the dissociation of the α subunit, with the subsequent activation of phospholipase C. As a result, IP_3 and DAG are rapidly generated which then mobilize cellular Ca and activate protein kinase C, respectively, ultimately leading to the cellular response (for example, secretion) [205, 206].

It is, however, uncertain whether the above sequence of reactions accompanies peptide stimulation of mast-cell secretion. It is known that changes in the levels of key PI cycle intermediates accompany stimulation of mast cells by antigen or by compound 48/80 [207, 208]. Besides, there is now evidence for

the involvement of guanine nucleotides and G proteins in mast-cell secretion [206, 209] as well as for the participation of diacylglycerol and protein kinase C in antigenic stimulation of the murine mast-cell line, PT-18 [210]. In addition, Penner, Matthews and Neher [198] have recently observed, in a series of elegant experiments on fura-2-loaded, patch-clamped rat peritoneal mast cells, transient increases in intracellular free ionized Ca, $[Ca^{2+}]_i$, in response to stimulation by SP or 48/80. This increase in $[Ca^{2+}]_i$ was independent of external Ca. The perfusion of IP_3 into the mast cell induced both a Ca-influx and a transient release of Ca from intracellular stores. These authors suggest that, in addition to the rapid mobilization of Ca from internal stores, there is a later prominent influx of Ca following stimulation that is optimized by the interaction between generated IP_3 and cyclic AMP. Together, these intermediates produced a sustained phase of elevated $[Ca^{2+}]_i$ caused by an influx of extracellular Ca [198]. These recent results thus support earlier observations which suggested a transient Ca influx in response to secretagogue stimulation [87, 188] as well as the mobilization of cellular Ca in response to peptide stimulation [86a, 87]. A model for stimulus-secretion coupling in response to peptide stimulation of the mast cell is suggested in *Figure 4.13*.

Another aspect of stimulus-secretion coupling in the mast cell in which specific peptides and compound 48/80 have been studied is the phosphorylation of specific protein bands in response to stimulation [211–214]. In these experiments mast cells were pre-labelled with ^{32}P and stimulated, and

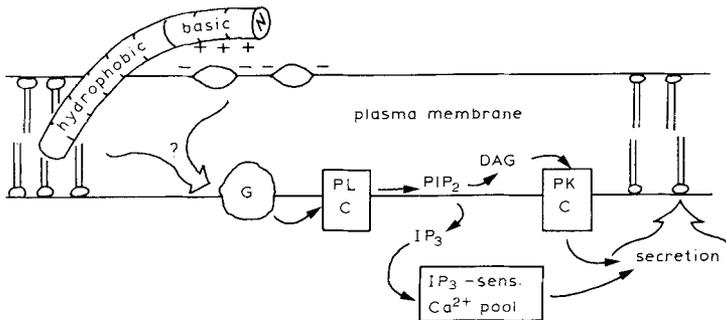

Figure 4.13. Model of peptide initiation of mast secretion. Insertion of the hydrophobic region of the peptide into the lipid bilayer properly orients the basic (+) groups at the N-terminus for binding to negatively charged membrane components. As a result, there is activation of the G protein complex with the subsequent generation of inositol triphosphate (IP_3) and diacylglycerol (DAG). These intermediates then stimulate the mobilization of cellular Ca and possibly the transient influx of extracellular Ca as well as the activation of protein kinase C. As a consequence, the level of intracellular free ionized Ca is maintained at an elevated state. The end result is the exocytotic extrusion of secretory granules.

subsequently phosphorylated protein bands were identified by autoradiographic analysis of one-dimensional SDS polyacrylamide gels.

SOM (5 $\mu\text{g/ml}$ for 1 min) was found to promote the same pattern of protein phosphorylation as compound 48/80, namely, the rapid phosphorylation of three specific bands of 42, 59 and 68 kDa and a slower phosphorylation of a 78 kDa band [211, 213]. This later band was also phosphorylated by the addition of DSCG or the DSCG-like drug, R021-7634 [214]. Significantly, the calcium ionophore, A23187, supported the phosphorylation of the 42, 59 and 68 kDa bands, but not that of the 78 kDa band [211]. Since this ionophore is believed to bypass the steps coupling stimulation at the cell surface leading to the appearance of an excess of intracellular free Ca, these results suggest that phosphorylation of the 78 kDa band may be involved in non-immunologic stimulus-response coupling, while the remaining three bands are most likely involved in the events following the mobilization of Ca which lead to exocytosis. In these experiments, the simultaneous addition of DSCG and 48/80 to the mast cells did not affect the phosphorylation of the 68, 59 or 42 kDa bands [212]. It was not reported whether histamine release was inhibited under these conditions.

The relatively slow phosphorylation of the 78 kDa band in response to either peptide stimulation or to the addition of DSCG suggests that this particular protein band may be involved in the termination of non-immunologically activated secretion [211-214].

While these observations clearly point to protein phosphorylation in the mast cell as an important aspect of stimulus-response coupling, how this may fit into the overall picture is unclear. It would be of interest to know, for example, whether activators of protein kinase C (for example, 1,2-diacylglycerol) will promote a similar pattern of phosphorylation or whether inhibitors of G protein involvement (for example, *Pertussis* toxin) alter the pattern of phosphorylation in response to peptide or immunologic stimulation.

ACKNOWLEDGEMENTS

I am grateful to my close and valued collaborator, Dr. Robert E. Carraway, of the Department of Physiology, University of Massachusetts Medical Center, for his continued support and expertise. I would like to thank Dr. Susan Leeman, also of the Department of Physiology, for introducing me to neurotensin and for her continued interest, and Drs. June Aprille, Harry Bernheim, Philip Bibb and Ross Feldberg of the Department of Biology, Tufts University, for their helpful discussions and input. I also wish to acknowledge

the fine technical skill and critical input of William Boucher and the contributions of the numerous research students who have worked in my laboratory. Lastly, I wish to thank Kimberly Calderwood and Valerie Ricciardone for their excellent secretarial work in the preparation of this review. Work from the author's laboratory has been supported by National Institutes of Health grants, AI 19736 and AI 19463, by the Cystic Fibrosis Foundation, and funds from the Tufts Biomedical Research Grants.

REFERENCES

1. D.G. Payan, J.D. Levine and E.J. Goetzl, *J. Immunol.*, 132 (1984) 1601.
2. J.C. Foreman, *J. Allergy Clin. Immunol.*, 74 (1984) 127.
3. E.J. Goetzl, T. Chernov, F. Renold and D.G. Payan, *J. Immunol.*, 135 (1985) 802s.
4. D.G. Payan, J.P. McGillis and E.J. Goetzl, *Adv. Immunol.* 39 (1986) 299.
5. J.C. Foreman, *Allergy*, 42 (1987) 1.
6. S.T. Holgate, *Agent Actions*, 18 (1986) 281.
7. D.G. Payan and E.J. Goetzl, *Eur. J. Respir. Dis. (suppl.)*, 144 (1986) 77.
8. S.I. Wasserman, in *The Mast Cell*, eds. J. Pepys and A.M. Edwards, (Pitman Medical Press, London, 1979) pp. 9–20.
9. N.S. Ranadive, in *Inflammation, Immunity and Hypersensitivity*, 2nd Edn., Ch. 6, ed. H.Z. Movat (Harper Row, New York, 1979) pp. 375–408.
10. K.F. Austen, *J. Immunol.*, 121 (1978) 793.
11. J. Bienenstock, A.D. Befus, and J.A. Denburg in *Mast Cell Differentiation and Heterogeneity*, eds. A.D. Befus, J. Bienenstock and J.A. Denburg (Raven Press, New York, 1986) pp. 391–402.
12. T. Ishizaka and K. Ishizaka, *Prog. Allergy*, 34 (1984) 188.
13. J.C. Foreman, *Annu. Rev. Pharmacol. Toxicol.*, 21 (1981) 63.
14. F.L. Pearce, *Prog. Med. Chem.*, 19 (1982) 59.
15. W.W. Douglas, in *The Pharmacological Basis of Therapeutics*, eds. L. Goodman and A. Gilman (MacMillan, New York 1975) p. 590, 5th edn. pp. 590–629.
16. J.F. Riley and G.B. West, *J. Physiol.*, 120 (1953) 528.
17. R.A. Lewis and K.F. Austen, *Nature (London)* 293 (1981) 103.
18. L.B. Schwartz and K.F. Austen, *Prog. Allergy*, 34 (1984) 271.
19. G.P. Lewis, in *Mediators of Inflammation*, 9 (IOP Publishers, Wright, Bristol, U.K. 1986) Ch. 9, pp. 96–106.
20. G.D. Bloom, in *The Inflammatory Process*, Vol. 1 2nd Edn. eds. B.W. Zweibach, L. Grant, and R.T. McCluskey (Academic Press, New York, 1974) pp. 545–599.
21. J.T. Whicher, *Diagn. Med.*, 4 (1981) 53.
22. A.R. Johnson, T.E. Hugli and H.J. Muller-Eberhard, *Immunology*, 28 (1975) 1967.
23. H.Z. Movat, in *Inflammation, Immunity and Hypersensitivity*, ed. H.Z. Movat (Harper Row, New York 1979) 2nd Edn. Ch. 1, pp. 1–162.
24. W.G. Specker, *Pharmacol. Rev.*, 10 (1958) 475.
25. J.I. Gallin, I.M. Goldstein, and R. Synderman, in *Inflammation: Basic Principles and Clinical Correlates*, eds. J.I. Gallin, I.M. Goldstein and R. Synderman (Raven Press, New York, 1988) pp. 1–3.

26. D.M. Schneider and M. Cohn in *Neuro-Immune-Endocrine Connection*, eds. C.W. Cotman, R.E. Brinton, A. Galaburda, B. McEwen and D.M. Schneider (Raven Press, New York 1987) pp. 1-14.
27. S.E. Leeman, *J. Exp. Biol.*, 89 (1980) 193.
28. A.C. Cuello, J.V.-Priestley and M.R. Matthews, in *Substance P in the Nervous System*, eds. R. Porter and M. O'Connor, (Pitman, London) Ciba Foundation Symp. 91 (1982) pp. 55-63.
29. D. Payan, D. Brewster, A. Misserian-Bastain, and E. Goetzl, *J. Clin. invest.*, 74 (1984) 1532.
30. Z. Bar-Shavit, R. Goldman, Y. Stabinsky, P. Gottlieb, M. Fridkin, V.I. Teichberg, and S. Blumberg, *Biochem. Biophys. Res. Commun.*, 94 (1980) 1445.
31. A.R. Johnson and E.G. Erdos, *Proc. Soc. Exp. Biol. Med.*, 142 (1973) 1252.
32. D.H. Perlmutter and H.R. Colten, in ref. 25, pp. 75-88.
33. D.T. Krieger, M.J. Brownstein and J.B. Martin, eds., *Brain Peptides* (Wiley, New York, 1983).
34. M.S. O'Doriso, N.S. Hermine, T.M. O'Doriso and S.P. Balcerzak, *J. Immunol.*, 127 (1981) 2551.
35. A. Beaumont and J. Hughes, *Annu. Rev. Pharmacol. Toxicol.*, 19 (1979) 245.
36. B. McEwen, in ref. 26, pp. 71-91.
37. S.E. Leeman and R.E. Carraway, *Ann. N.Y. Acad. Sci.*, 400 (1982) 1.
38. S.A. St. Pierre, R. Kerovac, R. Quirion, F.B. Jolicoevr, and F. Rioux in *Peptide and Protein Reviews*, ed. M.T.W. Hearn (Marcel Dekker, New York) Vol. 2 (1985) pp. 83-171.
39. R. Goldman, Z. Bar-Shavit, E. Shezen, S. Terry, and S. Blumberg. *Adv. Exp. Med. Biol.*, 155 (1982) 133.
40. D.E. Cochrane, J.B. Lansman, B. Paterson, R.E. Carraway and S.E. Leman, *Physiologist*, 22 (1979) 20.
41. C.B. Pert, M.R. Ruff, R.J. Weber and M. Herkenham, *J. Immunol.*, 135 (1985) 820s.
42. W.G. Spector, *J. Pathol. Bacteriol.*, 72 (1956) 367.
43. J.D. Levinde, R. Clarck, M. Devor, C. Helms, M.A. Moslowitz and A.I. Basbaum, *Science* (Washington DC) 226 (1984) 547.
44. S.I. Wasserman, *Arthritis Rheum.*, 27 (1984) 841.
45. B. Gruber, M. Poznansky, E. Boss, J. Partin, P. Gorevic and A.P. Kaplan, *Arthritis Rheum.*, 29 (1986) 944.
46. D.G. Malone, R.L. Wilder, A.M. Saavedra-Delgado and D.D. Metcalfe, *Arthritis Rheum.*, 30 (1987) 130.
47. F.L. Pearce, H. Ali, K.E. Barrett, A.D. Befus, J. Bienenstock, J. Borstoff, M. Ennis, K.C. Flint, B. Hudspith, N.M. Johnson, K. Leung and P.T. Peachell, *Int. Arch. Allergy Appl. Immunol.*, 77 (1985) 271.
48. F.L. Pearce, *Pharmacology*, 32, (1986) 61.
49. J. Bienenstock, A.D. Befus, J. Denburg, R. Goodacre, F.L. Pearce and F. Shanahan, *Monogr. Allergy*, 118 (1983) 124.
50. K.E. Barrett and D.D. Metcalfe, *J. Clin. Immunol.*, 4 (1984) 253.
51. K.E. Barrett and D.D. Metcalfe, *Am. Rev. Respir. Dis.*, 135 (1987) 1190.
52. F. Shanahan, J.A. Denburg, J. Fox, J. Bienenstock and D. Befus, *J. Immunol.*, 135 (1985) 1331.
53. H. Ali, K.B.P. Leung, F.L. Pearce, N.A. Hayes and J.C. Foreman, *Int. Arch. Allergy, Appl. Immunol.*, 79 (1986) 413.

54. R.H. Stead, M. Tomioka, G. Quinonez, G.T. Simon, S.Y. Felton and J. Bienenstock, *Proc. Natl. Acad. Sci. USA*, 84 (1987) 2975.
55. G. Skofitsch, J.M. Savitt, and D.M. Jacobowitz, *Histochemistry*, 82 (1985) 5.
56. F. Sundler, E. Brondin, E. Ekblad, R. Hakanson, and R. Uddman, in *Tachykinin Antagonists*, eds. R. Hakanson and F. Sundler (Elsevier, London, 1985) pp. 3-14.
57. J.A. Kierman, *Q. J. Exp. Physiol.*, 57 (1972) 311.
58. M.L. Kowalski and M.A. Kaliner, *J. Immunol.*, 140 (1988) 3905.
59. B.R. Powell and M.J. Brody, *Am. J. Physiol.*, 231 (1976) 1002.
60. J.A. Kierman, *Q.J. Exp. Physiol.*, 60 (1975) 123.
61. B. Pernow, *J. Immunol.*, 135 (1985) 8125.
62. W. Piotrowski and J.C. Foreman, *Br. J. Dermatol.*, 114 (1986) 37.
63. A. Saria, R. Gamse, J.M. Lundberg, T. Hokfelt, E. Theodorsson-Norheim, J. Petermann and J.A. Fischer, in *Tachykinin Antagonists*, eds. R. Hakanson and F. Sundler (Elsevier, Amsterdam, 1985) pp. 149-157.
64. F. Lembeck, J. Donnerer, and L. Bartho, *Eur. J. Pharmacol.*, 85 (1982) 171.
65. T. Lewis, in *The Blood Vessels of the Human Skin and Their Responses* (Shaw & Sons, London, 1927).
66. D.O. Thuesen, L.S. Speck, M.A. Lett-Brown and J. Andrew Grant, *J. Immunol.*, 123 (1979) 626.
67. J.D. Sedgwick, P.G. Holt and K.J. Turner, *J. Exp. Immunol.* 45 (1981) 409.
68. I.C. Ezeamuzic and E.S.K. Assem, *Agents Actions*, 13 (1983) 223.
69. L.M. Zheutlin, S.J. Ackerman, G.J. Gleich and L.L. Thomas, *J. Immunol.*, 133 (1984) 2180.
70. C.A. Dinarello, in ref. 25 pp. 195-208
71. E. Razin, J.N. Ihle, D. Seldin, J.M. Mencia-Huerta, H.R. Katz, P.A. LeBlanc, A. Hein, J.P. Caulfield, K.F. Austen and R.L. Stevens, *J. Immunol.*, 132 (1984) 1479.
72. Kozin, F. and C.G. Cochrane, in ref. 25 pp. 101-120.
73. R.E. Carraway, S.P. Mitra and D.E. Cochrane, *J. Biol. Chem.*, 262 (1987) 5968.
74. H. Mogard, R. Kobayashi, C. Chen, T.D. Lee, J.R. Reeve, J.E. Shirely and J.H. Walsh, *Biochem. Biophys. Res. Commun.*, 136 (1986) 983.
- 74a. T. Irman-Florjanc and F. Erjavec, *Agents Actions*, 14 (1984) 454.
- 74b. A. Argiolas and J.J. Pisano, *J. Biol. Chem.*, 259 (1984)
75. R.E. Carraway and S.E. Leeman, *J. Biol. Chem.*, 248 (1973) 6854.
76. R. Quirion, F. Rioux, D. Regoli and S. St. Pierre, *Life Sci.*, 27 (1980) 1889.
77. L.A. Cahl and S.B. Walker, *Life Sci.*, 29 (1981) 2009.
78. F. Rioux, R. Kerovac and S. St. Pierre, *Neuropeptides*, 3 (1983) 355.
79. R.E. Carraway, D.E. Cochrane, J. Lansman, S.E. Leeman, B. Peterson and H. Welch, *J. Physiol.*, 323 (1982) 403.
80. M. Kurose and K. Saeki, *Euro. J. Pharmacol.*, 76 (1981) 129.
81. A. Sydbrom, *Agents Actions*, 12 (1982) 91.
82. P.G. Kruger, P. Aas, J. Onarheim and K.B. Helle, *Acta. Physiol. Scand.*, 114 (1982) 467.
83. S.S. Rossie and R.J. Miller, *Life Sci.*, 31 (1982) 509.
84. R.E. Carraway, D.E. Cochrane, C. Granier, P. Kitabgi, E. Leeman and E.A. Singer, *Br. J. Pharmacol.*, 81 (1984) 227.
85. P. Devillier, M. Renoux, J.P. Giroud and D. Regoli, *Eur. J. Pharmacol.*, 117 (1985) 89.
86. L.H. Lazarus, M.H. Perrin and M.R. Brown, *J. Biol. Chem.*, 252 (1977) 7174.
- 86a. B.R. Rosengard, C. Mahalik and D.E. Cochrane, *Agents Actions*, 19 (1986) 133.
87. D.E. Cochrane, D. Distel, J. Lansman and B. Paterson, *J. Physiol.*, 323 (1982) 423.

88. D.E. Cochrane, W. Boucher P. Bibb, *Int. Arch. Allergy Appl. Immunol.* 80 (1986) 225.
89. F. Rioux, R. Kerovac and S. St. Pierre, *Neuropeptides*, 6 (1985) 1.
90. F. Rioux, R. Kerovac and S. St. Pierre, *Peptides*, 6 (1985) 121.
91. R. Kerovac, S. St. Pierre and F. Rioux, *Life Sci.*, 34 (1984) 947.
92. B.H. Selbekk, O. Flaten and L.E. Hanssen, *Scand. J. Gastroenterol.*, 15 (1980) 457.
93. B.H. Selbekk, *Scand. J. Gastroenterol.*, 19 (1984) 595.
94. B.H. Selbekk and S. Larsen, *Scand. J. Gastroenterol.*, 20 (1985) 145.
95. R. Sagi-Eisenberg, Z. Ben-Neriah, I. Pecht, S. Terry and S. Blumberg, *Neuropharmacol.*, 22 (1983) 197.
96. U.S. VonEuler and J.H. Gaddum, *J. Physiol.*, 72 (1931) 74.
97. C. Kitada, Y. Ashida, Y. Maki, M. Fujimo, Y. Hirai, T. Yasuhara, T. Nakajima, M., Takeyama, K. Koyama and H. Yajima, *Chem. Pharm. Bull.*, 28 (1980) 887.
98. F. Erjavec, F. Lembeck, T. Florjani-Irman, G. Skofitsch, J. Donnerer, A. Saria and P. Holzer, *Naunyn-Schmiedebergs Arch. Pharmacol.*, 317 (1981) 67.
99. C.M.S. Fewtrell, J.C. Foreman, C.C. Jordan, P. Oehme, H. Renner and J.M. Stewart, *J. Physiol.*, 330 (1982) 393.
100. F. Erjavec and M. Iskra, *Agents Actions*, 14 (1984) 373.
101. P. Devillier, D. Regoli, A. Asseraf, B. Descours, J. Marsac and M. Renoux, *Pharmacology*, 32 (1986) 340.
102. R. Kerovac, A. Fournier, J. Barabe, S. St. Pierre and F. Rioux, *Neuropeptides*, 3 (1983) 285.
103. O. Hagermark, T. Kokfelt and B. Pernow, *J. Invest. Dermatol.*, 71 (1978) 233.
104. J.C. Foreman, C.C. Jordan, P. Oehme and H. Renner, *J. Physiol.*, 335 (1983) 449.
105. J.M. Ebertz, C.A. Hirshman, N.S. Kettelkamp, H.Uno and J.M. Hanifin, *J. Invest. Dermatol.*, 88 (1987) 682.
106. H. Ali, K.B.P. Leung, F.L. Pearce, N.A. Hayes and J.L. Foreman, *Int. Arch. Allergy Appl. Immunol.*, 79 (1986) 413.
107. R. Hakanson, S. Leander, R.G.G. Andersson and J. Horig, *Acta Physiol., Scand.* 117 (1983) 319.
108. H. Schulthesis and J. Horig, in ref. 56, pp. 413–420.
109. S. Efendic and R. Ruft, *Ann. Clin. Res.*, 12 (1980) 87.
110. T.C. Theoharides and W.W. Douglas, *Endocrinology*, 102 (1978) 1637.
111. T.C. Theoharides, T. Betchaku and W.W. Douglas, *Eur. J. Pharmacol.*, 69 (1981) 127.
112. F. Diel and S. Szabo, *Regul. Pept.*, 13 (1986) 235.
113. E.J. Goetzl and D.G. Payan, *J. Immunol.*, 133 (1984) 3255.
114. MG. Rosenfeld, J.J. Mermod, S.G. Amara, L.W. Swanson, P.E. Sawchenko, J.E. Rivier, W.W. Valer and R.M. Evans, *Nature (London)*, 304 (1983) 129.
115. J. Fischer, W.G. Forssman, T. Hokfelt, J.M. Lundberg, M. Reinecke, F.A. Tschopp and Z. Wiensfeld-Hakin, *J. Physiol.*, 362 (1983) 29P.
116. S.D. Brain and T.J. Williams, *Br. J. Pharmacol.*, 86 (1985) 855.
117. R. Levi-Montalcini, *Science (Washington, DC)* 237 (1987) 1154.
118. F.L. Pearce and H.L. Thompson, *J. Physiol.*, 372 (1986) 379.
119. R.R. Siraganian and P.A. Siraganian, *J. Immunol.*, 114 (1975) 886.
120. A. Goth, V. Adams and M. Knoohuizen, *Science (Washington, DC)* 173 (1971) 1034.
121. D.E. Cochrane in *Trends in Autonomic Pharmacology*, ed. S. Kalsner (Taylor & Francis, London, 1985 Vol. 3) pp. 269–284.
122. J.S. Marshall, R.H. Stead, C. McSharry and J. Bienenstock, *FASEB J.*, 2 (1988) A 1234 (No. 5451).

123. H.R.P. Miller and W.F.H. Jarrett, *Immunology*, 20 (1971) 277.
124. L. Enerback and C.B. Lowhagen, *Cell Tissue Res.*, 198 (1979) 209.
125. H.N. Claman, *J. Am. Med. Assoc.*, 258 (1987) 823.
126. F. Levi-Schaffer, K.F. Austen, J.P. Caulfield, A. Hein, W.F. Bloes and R.L. Stevens, *J. Immunol.*, 135 (1985) 3454.
127. E.M. Johnson, Jr., M. Taniuchi and P.S. DiStefano, *Trends Neurosci.*, 11 (1988) 299.
128. F. Shanahan, T.D.G. Lee, J. Bienstock and A.D. Befus, *J. Allergy Clin. Immunol.*, 74 (1984) 499.
129. T.B. Casale, S. Bowman and M. Kaliner, *J. Allergy Clin. Immunol.*, 73 (1984) 775.
130. N.D. Tsakaks, T.C. Theoharides, S.K. Kops and P.W. Askenase, *Biochem. Pharmacol.*, 32 (1983) 355.
131. D.S. Emmanuel, M.D. Lindheimer and A.F. Katz, *Endocr. Rev.*, 1 (1980) 33.
132. H.A. Ellis, K.M. Peart and A.M. Pierides, *J. Clin. Pathol.* 30 (1977) 960.
133. R.S. Neiman, M.D. Bischel and R.J. Lukes, *Lancet*, i (1972) 959.
134. W.F. Serafin and K.F. Austin, *N. Engl. J. Med.*, 317 (1987) 30.
135. E. Razin and G. Marx, *J. Immunol.*, 133 (1984) 3282.
136. A.C. Guyton, in *Textbook of Medical Physiology* (Saunders, Philadelphia, PA, 1981) 6th Edn. pp. 801-815.
137. M.D. Tharp, R. Thirby and T.J. Sullivan, *J. Allergy Clin. Immunol.*, 74 (1984) 159.
138. S.A. St. Pierre, R. Kerovac, R. Quirion, F.B. Jolicœur and F. Rioux, *Prog. Hist. Cytochem.*, 16 (1985) 83.
139. N.S. Ranadive and C.G. Cochrane, *J. Immunol.*, 106 (1971) 506.
140. D.E. Cochrane, W. Boucher R.E. Carraway, *Int. Arch. Allergy appl. Immunol.* 87 (1988) 269.
141. O. Stendahl, L. Molin and M. Lindroth, *Int. Archs. Allergy Appl. Immunol.*, 70 (1983) 277.
142. R. Fantozzi, S. Brunelleschi, L. Giuliattini, P. Blandina, E. Masini, G. Cavallo and P.F. Mannaioni, *Agents Actions*, 16 (1985) 260.
143. D. Thueson, L.S. Speck, M.A. Lett-Brown and J.A. Grant, *J. Immunol.*, 123 (1979) 633.
144. E.J. Goetzl, T. Chernov-Rojan, K. Furuichi, L.M. Goetzl, J.Y. Lee and F. Renold, in *Ref.11*, pp.223-229.
145. E.S. Schulman, M.C. McGettyn, T.J. Post, R.J. Vigderman and S.S. Shapiro, *J. Immunol.*, 140 (1988) 2369.
146. S.K. Durum, J.A. Schmidt and J.J. Oppenheim, *Annu. Rev. Immunol.*, 3 (1985) 263.
147. M.A. Orchard, A. Kagey-Sobotka, D. Proud, and L.M. Lichtenstein, *J. Immunol.*, 136 (1986) 2240.
148. M.V. White and M.A. Kaliner, *J. Immunol.*, 139 (1987) 1624.
149. A.P. Kaplan, M. Haak-Frendscho, A. Fauci, C. Dinarello and E. Halbert, *J. Immunol.*, 135 (1985) 2027.
150. J.D. Sedgwick, P.G. Holt and K.J. Turner, *J. Exp. Immunol.*, 45 (1981) 409.
151. N. Subramanian and M.A. Bray, *J. Immunol.*, 138 (1987) 271.
152. G. Antoni, R. Presentini, F. Perin, A. Tagliabue, P. Ghiara, S. Censini, G. Volpini, L. Villa and D. Boraschi, *J. Immunol.*, 137 (1986) 3201.
153. J.W. Schrader, *Annu. Rev. Immunol.*, 4 (1986) 205.
154. M.B. Valloton, *Trends Pharmacol. Sci.*, 8 (1987) 69.
155. G.P. Lewis, in *Ref.19 Ch.2*, pp. 10-15.
- 155A. R.E. Carraway, D.E. Cochrane, W. Boucher and S.P. Mitra, *J. Immunol.*, 143 (1989) 1680.
156. D.E. Cochrane, W. Boucher and R.E. Carraway, *BR. J. Pharmacol.*, 97 (1989) 524.

157. R.F. Lemanske, Jr. and M. Kaliner, *Clin. Immunol. Rev.*, 4 (1982) 547.
158. L.H. Lazarus, M.H. Perridin, M.R. Brown and J.E. Rivier, *J. Biol. Chem.*, 252 (1977) 7180.
159. R.E. Carraway, D.E. Cochrane and S.P. Mitra, *Reg. Pept.*, 22 (1988) 303.
160. P. Kitabgi, F. Checler, J. Mazella and J.P. Vincent, *Rev. Clin. Basic Pharmacol.* 5,(1985) 397.
161. S.J. Bhatena, J. Lovie, P. Schechter, R.S. Redman, L. Wahl and L. Recant, *Diabetes*, 30 (1981) 127.
162. C. Sakamoto, I.D. Goldfine and J.A. Williams, *J. Biol. Chem.*, 259 (1984) 9623.
163. J.P. Esteve, C. Susini, N. Vaysse, H. Antoniotti, E. Wunsch, G. Berthan and A. Ribet, *Am. J. Physiol.*, 247 (1984) G62.
164. A. Enjalbert, L. Tapia-Arancibia, M. Rieutort, P. Braceau, C. Kordon and J. Epelbaum, *Endocrinology*, 110 (1982) 1634.
165. B. Jasani and D.R. Stanworth, *Int. Arch. Allergy Appl. Immunol.*, 45 (1973)74.
166. B. Jasani, G. Kreil, B.F. Mackler and D.R. Stanworth, *Biochem. J.*, 181 (1979) 623.
167. D.P. Roy, D.M. Moran, V. Bryant, R. Stevenson and D.R. Stanworth, *Biochem. J.*, 191 (1980) 233.
168. M.J. Dufton, R.J. Cherry, J.W. Coleman and D.R. Stanworth, *Biochem. J.*,223 (1984) 67.
169. D.R. Stanworth, *Mol. Immunol.*, 21 (1984) 1183.
170. N. Mazurek, I. Pecht, V.I. Teichberg and S. Blumberg, *Neuropharmacology*, 20 (1981) 1025.
171. T.C. Theoharides and W.W. Douglas, *Eur. J. Pharmacol.*, 73 (1981) 131.
172. H. Repke and M. Bienert, *Agents Actions*, 23 (1988) 207.
173. L.V. Podinsh, Ya.R. Betinsh, G.V. Nikiforovich and G.I. Chipens, *FEBS Let.*, 153 (1983) 25.
174. H. Repke and M. Bienert, *FEBS Let.*, 221 (1987) 236.
175. H. Repke, W. Piotrowski, M. Bienert and J.C. Foreman, *J. Pharmacol. Exp. Ther.*, 243 (1987) 317.
176. H. Shibata, M. Mio and K. Tasaka, *Biochim Biophys. Acta*, 846 (1985) 1.
177. R.R. Siraganian, in ref. 25, pp. 513-542.
178. S. Ringer, *J. Physiol.*, 11 (1980) 79.
179. W.W. Douglas, *Br. J. Pharmacol. Chemother.*, 34 (1968) 451.
180. W.W. Douglas, in *Calcium Transport in Contraction and Secretion* eds. E. Carafoli, F. Clementi, W. Drabikowski and A. Margeth (American Elsevier, 1975) pp. 167-174.
181. A.K. Campbell, in *Intracellular Calcium: Its Universal Role as Regulator* (John Wiley, New York, 1983) pp. 305-361.
182. D.E. Knight, in *Calcium and the Cell*, Ciba Found. Symp., 122 (John Wiley, Chichester, 1986) pp. 250-265.
183. F.L. Pearce, *Br. J. Clin. Pharmacol.* 20 (1985) 2675.
184. J.C. Foreman and J.L. Mongar, *J. Physiol.*, 224 (1972) 753.
185. D.E. Cochrane and W.W. Douglas, *Proc. Natl. Acad. Sci. USA*, 70 (1974) 408.
186. J.C. Foreman, M.B. Hallett and J. Mongar, *J. Physiol.*, 271 (1977) 193.
187. M. Ennis, A. Truneh, J. White, and F.L. Pearce, *Int. Arch. Allergy Appl. Immunol.*, 62 (1982) 467.
188. D.E. Cochrane and D.L. Distel, *J. Physiol.*, 330 (1982) 413.
189. N.S. Ranadive and N. Dhanani, *Int. Arch. Allergy Appl. Immunol.*, 61 (1980) 9.
190. J.C. Foreman, J.L. Mongar and B.D. Gomperts, *Nature (London)*, 245 (1973) 249.
191. M. Kagayama and W.W. Douglas, *J. Cell Biol.*, 62 (1974) 519.
192. T. Kanno, D.E. Cochrane and W.W. Douglas, *Can. J. Physiol. Pharmacol.*, 51 (1973) 1001.

193. T. Theoharides and W.W. Douglas, *Science* (Washington, DC), 201 (1978) 1143.
194. J.R. White, T. Ishizaka, K. Ikshizaka and R.I. Sha'ati, *Proc. Natl. Acad. Sci. USA*, 81 (1984) 3978.
195. M.A. Beaven, J.P. Rogers, J. Moore, T.R. Hesketh, G.A. Smith and J.C. Metcalf, *J. Biol. Chem.*, 259 (1984) 7129.
196. P.C. Bibb, D.E. Cochrane and N. Morel-Laurens, *FEBS Lett.*, 209 (1986) 169.
197. M. Lindau and J.M. Fernandez, *Nature* (London), 319 (1986) 150.
198. R. Penner, G. Matthews and E. Neher, *Nature* (London), 334 (1988) 499.
199. P.C. Bibb and D.E. Cochrane, *Agents Actions*, 25 (1988) 27.
200. T. Ishizaka, F. Hirata, K. Ishizaka and J. Axelrod, *Proc. Natl. Acad. Sci. USA*, 77 (1980) 1903.
201. F. Hirata, J. Axelrod and F.T. Crews, *Proc. Natl. Acad. Sci. USA*, 76 (1979) 4813.
202. J.M. Fernandez, M. Lindau and F. Eckstein, *FEBS Lett.*, 216 (1987) 89.
203. T. Nakamura and M. Vi, *Biochem. Pharmacol.*, 32 (1983) 3435.
204. T. Nakamura and M. Vi, *FEBS Lett.*, 173 (1984) 414.
205. J.R. Williamson, *News Physiol. Sci.*, 1 (1986) 72.
206. B.D. Gomperts, *Trends Biochem. Sci.*, 11 (1986) 290.
207. D.A. Kennerly, T.J. Sullivan and C.W. Parker, *J. Immunol.*, 122 (1979) 152.
208. Y. Ishizuka, A. Imai and Y. Nozawa, *Biochem. Biophys. Res. Commun.*, 123 (1984) 875.
209. S.K. Joseph, *Trends Biochem. Sci.*, 10 (1985) 297.
210. J.R. White, D.H. Pluznik, K. Ishizaka and T. Ishizaka, *Proc. Natl. Acad. Sci. USA*, 82 (1985) 8193.
211. W. Sieghart, T.C. Theoharides, S. Alper, W.W. Douglas and P. Greengard, *Nature* (London), 275 (1978) 329.
212. T.C. Theoharides, W. Sieghart, P. Greengard and W.W. Douglas, *Science* (Washington, DC), 207 (1980) 80.
213. T.C. Theoharides, W. Sieghart, P. Greengard and W.W. Douglas, *Biochem. Pharmacol.*, 30 (1981) 2735.
214. W. Sieghart, T.C. Theoharides, W.W. Douglas and P. Greengard, *Biochem. Pharmacol.*, 30 (1981) 2737.

5 Biological Effects of Mercuric Chloride, Nickel Sulphate and Nickel Chloride

KLAS NORDLIND, M.D., Ph.D.

*Department of Dermatology, Karolinska Hospital, Stockholm, S-104 01,
Sweden*

INTRODUCTION	190
MERCURIC CHLORIDE	190
Metabolism	191
<i>Ingestion</i>	191
<i>Skin uptake</i>	191
<i>Transport</i>	191
<i>Distribution</i>	192
<i>Excretion</i>	193
<i>Biotransformation</i>	194
Chemical interactions	195
<i>Proteins</i>	195
<i>Nucleic acids</i>	197
<i>Lipids</i>	198
<i>Selenium</i>	198
Effects on the nervous system	199
Effects on the endocrine system	199
Effects on the immune system	200
<i>Lymphocytes</i>	200
<i>Polymorphonuclear cells</i>	201
<i>Macrophages</i>	202
<i>Autoimmunity</i>	202
<i>Contact allergy</i>	204
Effects on the renal system	204
Effects on the reproductive system	205
Teratogenicity	206
Genotoxicity	206
NICKEL SULPHATE AND NICKEL CHLORIDE	207
Metabolism	207
<i>Inhalation</i>	207
<i>Ingestion</i>	207
<i>Skin uptake</i>	208

<i>Transport</i>	208
<i>Distribution</i>	209
<i>Excretion</i>	210
Chemical interactions	211
<i>Proteins</i>	211
<i>Nucleic acids</i>	212
<i>Lipids</i>	213
Effects on the respiratory system	213
Effects on muscular tissue	214
Effects on the immune system	214
<i>Lymphocytes</i>	214
<i>Contact allergy</i>	216
<i>Immediate allergic reactions</i>	217
Effects on the renal system	218
Teratogenicity	218
Genotoxicity	219
Carcinogenesis	220
CONCLUDING REMARKS	221
REFERENCES	221

INTRODUCTION

Mercuric chloride, nickel sulphate and nickel chloride are water-soluble salts. The present knowledge of these compounds regarding metabolism, chemical interactions and biological effects on different tissues will be reviewed.

MERCURIC CHLORIDE (HgCl₂, MERCURY BICHLORIDE; MERCURY PERCHLORIDE; CORROSIVE SUBLIMATE)

Mercuric chloride has been a popular antiseptic and disinfectant. The handling of mercuric salts in the chemical industry, however, may result in exposure to aerosols of inorganic mercury.

The mercuric ion, Hg²⁺, which is obtained after oxidation in the red blood cells and other tissues, is able to form many stable complexes with biologically important molecules or moieties such as sulphhydryl groups. The affinity of mercury for sulphhydryl groups is a major factor in the understanding of the biochemical properties of mercuric compounds, resulting in interference with membrane structure and function and with enzyme activity.

METABOLISM

Ingestion

Less than 10% (probably around 2%) of ingested mercuric chloride is absorbed [1-4]. Upon high intake, the corrosive action of mercuric chloride may alter the permeability of the gastrointestinal tract, thereby enhancing absorption. In newborn rats a more effective absorption of mercuric compounds has been reported [5].

With an increase in pH, there is an increased absorption of mercuric chloride [6, 7], whereas accumulation of mercury in the intestinal tissue decreases. Mercury absorption is inversely proportional to its accumulation in the tissue. An increase in water absorption due to hypotonicity or an increase in concentration of sodium ions or urea increases the mercury absorption and accumulation in the epithelial cell, without change in the intracellular distribution pattern [8]. Thus, the absorption of mercury is thought to accompany the solvent drag and to be influenced by pH change in the intestinal lumen.

Skin uptake

In animal studies [9], up to 8% of isotopically labelled mercuric chloride applied to the skin was absorbed within 5 h. The state of the skin is one factor which determines the rate of absorption [10]. Passive diffusion cannot be the only process involved, since the absolute absorption rate of mercury increases with increasing concentration up to a plateau value. In addition, skin absorption probably occurs transepidermally rather than via the follicular pathway [11].

Transport

After injection into mice, mercuric chloride has been found to be distributed equally between erythrocytes and plasma in blood for up to 1 day after the administration [12, 13]. There is, however, a gradual increase in red blood cell/plasma ratio. In the erythrocytes, mercury is probably bound to sulphhydryl groups on the hemoglobin molecule [14], though the binding is readily reversible [15]. There is possibly also a binding to glutathione [16].

Virtually all the mercury in plasma is protein-bound [17, 18]. Haemolyzed samples of blood from rats given radioactive mercuric chloride yielded less than 0.5% ultrafiltrate mercury. The distribution between different plasma-protein fractions varied with dose, time after, and type of, administration [19-21].

Three distinct fractions of protein-bound mercury in plasma of rats have been identified [22]. The highest proportion of mercury was found in the protein fraction containing mainly lipoprotein and benzidine-positive globulins. There has also been an association of inorganic mercury with globulin plasma proteins [20].

Distribution

The rate of uptake from blood and by different organs varies widely, and so does the rate of elimination from different organs. Inorganic mercury is characterized by a markedly non-uniform distribution in the body. Compartmentalization of mercury within different parts of the organ or in subcellular structures, the binding of mercury to various chemical compounds within the cell, and the metabolic transformation of mercury, complicate the evaluation of distribution.

Divalent mercury in rats has been reported to poorly penetrate the blood-brain barrier [23]. However, there is an impairment of the blood-brain barrier within hours after mercury treatment [24, 25]. By means of autoradiographic techniques, it was demonstrated [26] that after a single intravenous injection of labelled mercuric chloride, large portions of the radioactive mercury were detected in the cerebellar grey matter, area postrema, hypothalamus and areas near the lateral ventricle of mice.

Mercuric salts weakly penetrate the placenta barrier; however, they can accumulate in placenta [26–29], foetal membranes and amniotic fluid [30]. In mice, mercuric chloride (1.5 mg per kg) injected on day 14 of gestation resulted in 0.14% of the injected mercury being transferred to foetal tissues 4 days later [27].

The dominant mercury pool in the body is the kidney [23, 31]. The kidneys contained over 85% of the body burden of mercury 15 days or more after a single injection of mercuric chloride into rats [32]. Maximum levels in the rat kidney were attained in less than a day after doses of mercuric chloride [33]. The renal cortex contained the highest levels [34–36], the maximum concentrations being found in the proximal tubular system, while mercury was close to background levels in the glomeruli and collecting ducts.

A large proportion of the mercury in the kidney is bound to metallothionein, which has a capacity to bind mercury strongly [37–39]. The role for metallothionein in the kidney is probably protective [37]. Chronic dosing of rats with mercuric chloride over a period of 3 weeks induced an approximately 6-fold increase in the renal metallothionein levels, which provides an explanation for the almost linear increase of mercury in kidneys over several weeks of daily exposure. A protective role of metallothionein would explain findings that the

kidneys can accumulate during chronic exposure to mercury compounds, much higher levels of inorganic mercury than the toxic level being observed after a single dose, and they do so without any detectable deleterious effects.

Equilibrium dialysis of homogenates of kidneys of rats given mercuric chloride, revealed that over 99% of the mercury was not diffusible [40]. Diffusible compounds of mercury have the opportunity to cross the capillary membrane and enter the tissue spaces; however, due to chemical affinities for cellular binding sites and the diffusible complex, and the ability to penetrate the cell membrane, not all diffusible complexes of mercury present in plasma lead to tissue accumulation.

The next largest pool is the liver [26], where the highest concentration is found in the periportal areas. Other organs in which mercury is likely to accumulate are the mucous membranes, the epithelium of the skin, the spleen, the interstitial cells of the testicles, and some parts of the brain.

As regards cellular uptake, an initial rapid uptake of mercury during the first 5 min of metal incubation was found in rat hepatocytes, which probably represented a non-specific binding of mercury to the cell [41]. This was followed by a slower uptake phase, probably representing only the passive uptake of mercury. A direct binding of $^{203}\text{HgCl}_2$ to the membranes of human thymocytes and peripheral blood lymphocytes can be demonstrated early after isotope addition [42]. An uptake into the lymphocytes and especially into the nuclei was also found with increasing incubation time. A considerable accumulation of labelled mercuric chloride in rat liver and kidney cell nuclei has also been reported [43]. By contrast, in neuronal cells, large amounts of mercury were localized on the nuclear envelope and other membrane systems, only very minimal amounts of mercury being found in the nucleus and nucleolus [25].

A 35- to 40-fold incorporation (relative to other fractions) of labelled mercury into a nonhistone fraction of rat kidney nuclei has been reported [44]. By using flameless atomic absorption, a 12 to 15-fold enrichment of mercury was found in the euchromatin fraction of mouse liver nuclei [45, 46]. Mercury was not detected in the inactive heterochromatin.

Following a single dose of mercuric chloride to rats, mercury also tended to accumulate with time after injection in the lysosome-peroxisome group of particles [47]. This accumulation may represent a detoxication process [48].

Excretion

The major part of absorbed mercuric mercury is excreted in urine and faeces in about equal parts in rat [49] and man [2, 50]. Since absorption rates from the lung or gastrointestinal tract do not vary greatly from one animal species

to another, variation in the steady-state body burdens in animals chemically exposed to the same level of mercury is due mainly to species differences in excretion rates. Most investigators recognize at least three different phases in half-time excretion rates. Thus, when a single subtoxic dose of mercuric chloride is given to rats and excretion is determined by whole body counting [32], the initial rapid phase involves 35% of the dose and lasts for a few days. Then a slower phase (half-time 30 days) follows, involving 50% of the dose, and finally there is a slow phase, accounting for the remaining 15% of the dose and characterized by a half-time of 100 days.

The weight of evidence indicates that glomerular filtration of diffusible mercury may not make an important contribution to urinary excretion [51]. After injection of mercuric chloride into the renal artery in rat, it was shown [52] that mercury is taken up by basal tubuli cells from the capillaries. With chicken kidney, the ability of divalent inorganic mercury to pass across the tubular wall into the urine by direct transport was demonstrated [53]. Using a silver amplification method as a mercury-detecting probe and initially after a single exposure to a high mercury dose in mice, glomerular filtration of mercury, probably bound to plasma proteins, was found to be an important mechanism for the excretion of inorganic mercury [54].

Apart from excretion via saliva [55], mercury is excreted by the liver through the bile [56]. Inorganic mercury is secreted into bile complexed with a low-molecular-weight substance which appears to be glutathione [57] and the mercury secretion is in large part dependent on the biliary transport of glutathione [58].

Biotransformation

A small part of divalent mercury is reduced to mercury vapour. This reduction probably accounts for the ability of certain commonly occurring micro-organisms to volatilize mercury for biological media [59]. Loss of volatile radioactive mercury was observed in rats injected with salts of divalent mercury labelled with the ^{203}Hg isotope [60]. Part of the volatile mercury was exhaled via the lungs, the remainder by way of the skin and fur. The volatile loss accounted for up to 20% of the total rate of excretion of mercury from the animals.

Methylation of divalent inorganic mercury salt has been shown *in vivo* in rat intestine [61] and *in vitro* in human intestine [62], yet it is seldom followed by toxic effects. MeHg has been found in hen tissues [63] and probably in rat brain [64] after ingestion of divalent mercuric salts.

Moreover, there may also be demethylation of organic mercury, giving inorganic mercury [65] probably by microbiological action.

CHEMICAL INTERACTIONS

Mercury is a highly reactive atom. A good correlation exists between the LD₅₀ values of metal ions and the degree of chemical softness (potential to form coordinate covalent bonds), highly toxic metal ions such as Hg²⁺ having a high degree of chemical softness [66].

Proteins

Although mercurials are highly specific for sulphhydryl groups [67–69], they are highly unspecific in terms of proteins, almost all proteins having sulphhydryl groups that are metal-reactive. Thus, mercurials can disturb almost all functions in which proteins are involved [70].

Enzymes are important targets for mercury [71], and sulphhydryl-group-containing enzyme being more sensitive to mercuric compounds than a non sulphhydryl-group-containing enzyme [72]. Enzymes reported to be inhibited include phosphatases [73, 74], dehydrogenases [75, 76] and hexokinases [71].

Mercury can influence ion, water, and nonelectrolyte transport in different cells [14, 77]. The cell membrane is believed to be the first point of attack by heavy metals; however, intracellular enzymes and metabolic processes may also be inhibited [70, 78, 79]. The attachment of heavy metals to ligands in or on the plasma membrane may result in changes in passive permeability or selective blockage of specific transport processes. Many membrane transport systems are known to be sensitive to sulphhydryl-group modification [14, 80, 81].

The inhibition of amino-acid transport has been regarded as the main toxic effect of mercury compounds [82]. The biochemical mechanism underlying the inhibition is unclear. In unfertilized sea-urchin eggs an interaction with the amino-acid carrier was found, whereas in fertilized eggs inhibition of amino-acid transport was indirect and might result from an elevation of the Na⁺ content of the egg caused by the inhibition of the Na⁺ pump [83]. The action on the diffusional process could be mediated by an effect on membrane phospholipids or on membrane proteins, or by interaction with Ca²⁺ which stabilizes membrane structure. Mercuric chloride in skate liver cells inhibited amino acid transport, decreased Na⁺/K⁺-ATPase (adenosinetriphosphatase) activity, impaired volume regulatory mechanisms and increased the permeability of the plasma membrane to potassium [84]. It has been suggested that

mercury interacts with ATPase system due to its high affinity for sulphhydryl groups [85]. The findings are consistent with the hypothesis that the plasma membrane is the target organelle. Hg^{2+} ions could also impair glutamate (a neurotoxic excitatory transmitter) transport reversibly at exposure levels that do not compromise other vital functions [86].

Mercuric chloride is a very effective irreversible inhibitor of sugar transport in the intestine [87–91] partly involving a sulphhydryl group in the inhibitory process [90, 91].

Mercuric chloride gives a decrease in monoamine [85, 92] and choline [92] uptake in brain synaptosomes which may be related to an inhibition of Na^+/K^+ -ATPase [85, 92–94].

Mercuric chloride may induce catecholamine release from adrenals. The initial phase may be due to amine displacement by the mercury ion but the secondary phase probably involves alteration of membrane structures [95]. Mercury compounds have also been shown to increase the efflux of monoamines from mouse striated slices [96] and from adrenergic nerve fibre terminals [97], the effect being attributed to inhibition of Na^+/K^+ -ATPase activity and(or) disruption of intracellular Ca^{2+} regulatory mechanisms [96].

On the other hand, mercuric chloride decreased both spontaneous and evoked transmitter liberation at the frog neuromuscular junction [98] as well as the release of vasopressin from the pituitary gland [99]; it was suggested that these effects are mediated via changes in the intracellular calcium ion concentration.

Mercuric chloride is thought to gain access to the intracellular compartment through Na^+ and Ca^{2+} channels in the membrane [100]. Sulphydryl reagents, including Hg^{2+} , could inhibit K^+ -stimulated uptake of Ca^{2+} into rat brain synaptosomes *in vitro* [101]. In muscle sarcoplasmic reticulum, Hg^{2+} causes inhibition of ATP-dependent Ca^{2+} uptake and loss of accumulated calcium [102, 103]. However, HgCl_2 has been found to inhibit ATP-dependent calcium uptake more strongly than it inhibits potassium-stimulated uptake [104].

In sarcoplasmic reticulum, HgCl_2 inhibited $(\text{Ca}^{2+} + \text{Mg}^{2+})$ -ATPase, transport and ionophore activity [105]. Mercuric chloride probably inhibited ATPase and Ca^{2+} transport by blocking essential sulphhydryl groups; however, blockage of Ca^{2+} transport probably occurred both at sites of essential sulphhydryl groups and at sites of ionophoric activity. It was later suggested that the mechanism of mercuric chloride inhibition of the Ca^{2+} -ionophore was by competition with Ca^{2+} for the Ca^{2+} -ionophoric site, whereas inhibition of the enzyme and Ca^{2+} -transport was due to the blockage of essential sulphhydryl groups [106].

Hg^{2+} has been shown to interact with calmodulin and Hg^{2+} is capable of

inactivating calmodulin conformer independent of the presence of calcium on calmodulin [107].

While studying the binding of mercury by chromatin of rats injected with mercuric chloride, the nonhistone chromatin proteins in rat and kidney cell nuclei were shown to be mainly responsible for the mercury deposition [43]. The mercury-binding nonhistone proteins were found to be heterogeneous by sodium dodecyl sulphate-polyacrylamide gel electrophoresis.

Divalent cations are necessary for the phosphorylation of nucleolar proteins *in vitro* [108]. When studying the phosphorylation of nuclear proteins of peripheral blood T lymphocytes activated by mercuric chloride, using gel electrophoresis and autoradiography, a marked increase of ^{32}P label into nonhistone proteins, especially the 30–40 kDa region, together with an increase in labelling of histone H4, was found [109]. It was postulated that the increase in nuclear protein phosphorylation probably reflected an activation of the lymphocytes. Most of the nuclear proteins were found to be able to bind labelled mercuric chloride [110]; however, four of the proteins were heavily labelled. Of these four proteins, two migrated in the histone region, one co-migrating exactly with histone H3. The other two were nonhistone proteins with molecular weights of approximately 25 and 43 kDa. These proteins were not similar to those which were stimulated in their phosphorylation.

Mercuric chloride has also been shown to inhibit the enzymatic activity of soluble protein kinase A from mice brain, apparently by binding to sulphhydryl groups of the enzyme [111]. The inhibition was of a non-competitive type with respect to H1 histone.

Nucleic acids

The profound and reversible effects of the binding of Hg^{2+} upon the physical properties of DNA has proved to be a complex nature [112, 113]. Hg^{2+} binds to the bases of DNA [114, 115] and there is a binding to both double- and single-stranded DNA [115].

Hg^{2+} selectively binds the AT region, apparently due to its great affinity for thymine. Thus, Hg^{2+} interacts with DNA at nitrogen atoms, replacing hydrogen between the thymine and adenine bases [114]. This interaction results in increased helix stability and an increased diameter of the double helix, approximating the difference between the atomic radius of hydrogen and mercury [116].

A binding has also been observed with the RNA of virus [117] and bacteria [118] as well as in several synthetic polyribonucleotides [119, 120], giving rise to effects on physical properties.

Lipids

Mercury is known to exert an effect on the synthesis of membrane lipids. Mercuric chloride produces lipid alteration in pig kidney epithelial cells (LLC-PK₁ cells), with rapid accumulation of unesterified fatty acids (particularly arachidonic acid) and lysophospholipids and loss of cellular phospholipids [121]. Mercuric chloride after i.p. administration in mice significantly increases the phospholipid content in mouse liver, while the content in kidney is reduced [122]. In isolated mouse nerves, the synthesis of all lipids is reduced after mercuric chloride, but the cholesterol synthesis is inhibited most strongly [123]. It has been suggested that these lipid alterations might participate in the pathogenesis of membrane damage and cell death.

Mercuric chloride in a narrow concentration in 3T3 mouse fibroblasts stimulated phospholipid hydrolysis and prostaglandin release [124]. PGE₂ synthesis was stimulated in rat whole glomeruli and glomerular cells *in vitro* after mercuric chloride [125], and multiple mechanisms were involved. It was suggested that, since the mercuric chloride effect at low doses could be attributed to the indirect activation of phospholipase, the inhibiting effect of lipomodulin on phospholipase was suppressed by mercuric chloride. The latter, together with other substances that activate phospholipase A, increase the rate of collapse of a proton gradient across the apical membrane of rat kidney proximal tubule, giving increased proton permeability of the plasma membrane [126].

Oral or parenteral administration of mercuric chloride promotes lipid peroxidation [127–129], possibly via a reduction of glutathione peroxidase activity. However, several studies argue against lipid peroxidation being responsible, at least for the early hours of cell toxicity of mercury [130–133].

Selenium

Selenium lessens the toxicity of divalent mercury in animals, the protection being less at continuous mercury exposure. Selenium has been found to affect the distribution of mercuric mercury in mice [134], rats [135], rabbits [136, 137] and pigs [138]. Mercury forms a mercury-selenium protein complex with selenium with little biological activity [139]. Mercury is thus retained longer in the blood, liver and spleen and as a consequence lessens accumulation in the kidney. In fish, selenium pretreatment probably retarded mercury uptake rather than promoting mercury excretion [140].

Inorganic mercuric salts inhibit glutathione-metabolizing enzymes and gluta-

thioneperoxidase in the kidney of rodents, and this reaction may be inhibited by selenium [128, 141, 142].

Information concerning the effects of selenium in man is lacking and it is doubtful whether administration of selenium in man has any effect on the toxicity of mercuric mercury. However, mercury and selenium were found in the cellular lysosomes in renal tubular cells in two patients with inorganic mercury poisoning [143].

EFFECTS ON THE NERVOUS SYSTEM

Vacuolization and fragmentation of neurones are induced by mercuric chloride [25]. A large axonal space is created in many axons; vacuolation and collapse are observed in many nerve fibres while the regular lamination and periodicity of the myelin sheath are preserved. Sensory fibres are more sensitive and vulnerable to mercury intoxication. In the cerebellum, extensive coagulative or lucid changes in the granule cells are found with degeneration of the Purkinje cells at a late stage of poisoning.

In mouse glioma cells, many kinds of changes in cell organelles after exposure to 5×10^{-5} M mercuric chloride *in vitro* could be found [144]. Nuclei showed pyknotic and irregular shapes; mitochondria lost their normal cristae and abnormal electron-dense areas were present within the matrix; polyribosomes were dispersed. Numerous electron-dense granules and vacuolations were seen in the cytoplasm, especially around the Golgi region.

An inhibition of DNA and protein synthesis in glioma and neuroblastoma cells has been found at the same mercury concentration [145, 146], neurons being much more sensitive to mercuric chloride than nonneuronal cells [147].

In addition, inorganic mercury induces an acute and severe effect on the neuronal RNA [25]. Thus, upon prolonged intoxication (11 weeks) with mercuric chloride, significant changes are obtained in the RNA base values of the spinal ganglion neurones. There is a definite increase of guanine and a marked decrease of cytosine levels. Upon prolonged intoxication with mercuric chloride, some animals become more tolerant to substantially higher doses of mercury, and show signs of recovery from certain neurological symptoms. It was postulated that the newly produced RNA might be responsible for these phenomena.

EFFECTS ON THE ENDOCRINE SYSTEM

Administration of mercuric chloride to rats within the first few days resulted in an increase in thyroid function, as observed by an increase in secretion rates

[148]. Administration for 40 days gave an enhancement of thyroid activity as shown by an increase in activity of several indices of thyroid function and thyroid weight. A decrease was found in labelling of T_3 (triiodothyronine), and a coupling defect in the synthesis of T_3 , was indicated. Administration of mercury over a longer period, 90 days, gave manifest signs of mercury poisoning together with decreased thyroid radioiodine uptake and depression of thyroid secretion. It was indicated that the influence of mercuric chloride ingestion on thyroid function probably reflected the quantity of mercuric chloride administered and the length of time of exposure.

Mercuric chloride, given for short time, has been reported to inhibit Na^+/K^+ -ATPase in hog thyroid membranous preparation [149]. The blood T_4 (thyroxine) levels were reduced and iodotyrosine deiodinase was inhibited, and it was suggested that mercurials might cause a coupling defect in the synthesis of iodothyronines. In mouse thyroid serum T_4 level was affected by mercuric chloride, while serum T_3 was not [150]. It was suggested that thyroidal secretion of T_4 was inhibited by mercuric chloride, but the peripheral conversion of T_4 to T_3 might not be affected in the maintenance of an active hormone level.

EFFECTS ON THE IMMUNE SYSTEM

Lymphocytes

Depending on inorganic mercury compound concentration, a stimulated DNA synthesis of murine [151] and human [152–158] lymphocytes has been obtained. In addition, blast transformation and stimulation of mitosis index were found [152–154]. The effects were obtained by concentrations of mercury which were close to a toxic level. Both agglutinated and nonagglutinated thymocytes were stimulated [159], indicating that both functionally immature and mature thymocytes may be target cells for the stimulatory effect. When tested on peripheral blood lymphocytes, there was a higher degree of stimulation than in thymocytes [158] and there was also a tendency to higher reactivity to mercuric chloride of thymocytes taken from efferent compared with afferent thymic blood [160]. No difference in transformation rates between control persons and mercuric-allergic subjects has been found [152].

Mercuric chloride was then tested on human thymocytes and peripheral blood lymphocytes, fractionated according to density [161], and it seemed possible that mercuric chloride was a polyclonal stimulator of human peripheral blood T helper lymphocytes and thymocytes with characteristics of medullary cells. When macrophages were depleted, the stimulation remained at about the

same level in the respective thymocyte and peripheral blood lymphocyte populations, suggesting that mercuric chloride might act directly on lymphocytes. In an earlier study, a stimulation of mercury also on nonadherent cells was obtained [154].

Mercuric chloride-stimulated blood lymphocytes were shown to produce migration inhibition in most of the tested autologous leucocyte cultures, while a migration stimulation was found in a minority of cultures [162]. With mercury, murine splenic lymphocytes were found to display lectin-dependent cytotoxicity and to produce acid-labile interferon [163], macrophages being needed for these effects. Different concentrations of mercuric chloride also enhanced IL-2 interleukin production from splenocytes in different rat strains [164]. Moreover, mercuric chloride, as well as PHA (phytohemagglutinin), may enhance the accumulation of β_2 -microglobulin in the medium of human leucocytes parallel to a maximum stimulation of DNA synthesis [165]. It was suggested that there is a close correlation between lymphocyte stimulation and active formation of β_2 -microglobulin by the cells.

Immunosuppressive effects have been obtained *in vitro* with mercuric chloride. A marked inhibition of the mixed lymphocyte reaction in mice as well as PFC (plaque forming cell) response to SRBC (sheep red blood cells) by mercuric chloride [166] has been reported. Chronic exposure to mercury of rabbits gave immunosuppression, measured as low antibody titres to viral agents [167]. A suppression of antibody production in chickens exposed to mercuric chloride has also been reported [168]. Furthermore, an inhibition of mitogenic response to PHA in lymphocytes by mercuric chloride has been obtained [169].

When tested on cell counts, dye exclusion and fine structure of guinea-pig thymocytes, mercuric chloride in concentrations which inhibit DNA synthesis, most often caused cell degeneration, with condensed nuclear chromatin and disintegrating cytoplasmic organelles [170].

Polymorphonuclear cells

Low levels of mercuric chloride in polymorphonuclear cells may profoundly alter the cell respiratory burst, measured as chemiluminescence, oxygen consumption and H_2O_2 production [171–173], depress phagocytic capacity [172, 173] and enhance release of lysosomal enzymes [172] with minimal loss of cell viability. A stimulation of oxygen metabolism *in vivo* might promote tissue injury, via the local production of free oxygen metabolites, in addition to depression of host defence [173].

Macrophages

Mercuric chloride can reduce the superoxide anion production by mouse macrophages [174], but this effect is probably of little toxicological significance in view of the high concentrations required and of its reversibilities. The effect has been suggested to result from loss of the reducing properties of cellular NADPH.

Autoimmunity

Mercuric chloride is able to trigger immune dysregulation in different species depending upon the genetic background of the strain tested. In Brown-Norway (BN) and MAXX rats, a biphasic immune-mediated systemic disease including glomerulonephritis has been found. The initial phase is characterized by IgG antibodies against glomerular basement membrane antigens [175–177] including laminin, type IV collagen, heparan-sulphate proteoglycane, and entactin [178]. It was shown that fixation of linear IgG, IgM and C3 deposits to the glomerular basement membrane developed initially [175, 177, 179, 180]. A nephrotic syndrome appeared. In the second phase of the disease, circulating immune complexes [175, 180–182] were followed by subepithelial and mesangial granular deposits of IgG and C3 in the glomerulus without cell proliferation [183, 184] and at the same time granular deposits containing IgG and C3 systematically in most vascular structures [185]. Similar findings have been reported in the rabbit [186].

The biphasic systemic disease in BN rats was also shown after administration by the respiratory or digestive route [187, 188]. Even mercury-containing pharmaceutical products have been shown to induce immune-type glomerulonephritis [189].

In the circulation of the BN rat there is a simultaneous and transient presence of antiglomerular basement membrane antibodies and circulating immune complexes [175]. Another characteristic is a striking increase in total and antigen-specific IgE level [190], which also has been found in Hooded Lister rats [191], as well as anti-single-stranded DNA antibodies [181] in the BN rat. In PVG/C rats [192, 193], mercuric chloride also induced glomerulopathy and antinuclear antibodies directed against non-histone nucleoprotein.

It was demonstrated in the BN rat that mercuric chloride induced a T-dependent polyclonal activation of B cells [181]. Helper/inducer T cells exposed to mercuric chloride either *in vivo* or *in vitro* could induce the proliferation of normal autologous T lymphocytes. Normal syngeneic Ia⁺ cells were necessary for this proliferation [194]. In BN rats lacking T cells, no auto-

immunity developed following mercuric chloride injection [195] and T cells were thus essential for mercury-induced autoimmunity.

Mercuric chloride in the BN rat gives a lymphoproliferation in spleen and lymph nodes, including B and T helper cells, an increase in the number of Ig containing cells resulting in a rise in all serum Ig isotypes and an early thymic atrophy [196]. The kinetics of the increase in the serum level of various Ig isotypes were similar to that observed for IgE, suggesting spontaneous auto-regulation, which could involve suppressor T cells [197, 198] and/or auto-anti-idiotypic antibodies [199].

It has been shown that both MHC- and non-MHC linked genes are involved in the induction of autoimmune abnormalities in the BN rats [200, 201].

Contrary to the findings in BN rats, in Lewis rats [202] mercuric chloride induces immunosuppression, the number of suppressor/cytotoxic cells increase in the spleen and lymph nodes, an inhibition occurs of T cell responsiveness to mitogens and alloantigens and there is a marked reduction of the local graft versus host reaction.

As regards the autoimmune disease produced by mercury in mice, in some strains, inducibility of antinuclear and antinucleolar antibodies has been found [203–207]. By immunoblot analysis, a single 36 kDa protein of pI 8.6 has been shown to be antigenic for Hg-induced sera [206, 207]. This polypeptide was identical with a polypeptide called fibrillarlin, being associated with U3 small nuclear RNA and against which scleroderma patients may develop antibodies. In addition, in SJL mice, serum antibodies giving a weak homogeneous nuclear staining in some were obtained, and the antigens underlying this staining pattern seemed to be histones [206].

In mice, the I region and/or S region of the H-2 complex appeared to be the major genetic factor controlling the autoimmune response [204]. The genetic activity is determined by at least two different loci, one of which is located in H-2, the murine MHC. In addition, undefined non-MHC genetic factors also play a role. Using a popliteal lymph node assay, 21 out of 22 different inbred mice strains were found to show immunostimulation by various doses of mercuric chloride, as it induced T-cell-dependent enlargement of draining popliteal lymph nodes [208]. The responsiveness appeared to be inherited in a codominant fashion and there was evidence to the effect that the observed genetic differences were determined by both H-2 and non H-2 genes.

Regarding the cellular phenomenon giving the autoimmune disease in Balb mice, the importance of T cells in the induction of the immune-complex disease was found while in another strain, SJL mice, a polyclonal B cell activation was obtained; however, the importance of T cells could not be excluded [209].

Contact allergy

Certain strains of inbred guinea-pigs can be sensitized to mercuric chloride, and the ability to become sensitized appeared to be transmitted as a dominant characteristic which was not sex-linked [210–212]. By the guinea-pig maximisation test and using a mercuric chloride concentration of 0.1%, a sensitization rate of $\frac{8}{25}$ was found and mercuric chloride was graded as a moderate sensitizer [213].

A sensitization potential of sublimate has also been reported in man [214]. In a human assay and using the maximization test, mercuric chloride was found to be an extreme sensitizer [215]. Sensitivity to mercury earlier used to be common, even in children, but is now rare [216]. An incidence of 13.2% of tested children (using 0.1% sublimate) was found in one study [217]; the macroscopic-clinically and histologically eczematous test reactions were toxic. In addition, many of the reactions to mercuric chloride are of low intensity, only a small percentage of positive patients having a history of contact dermatitis due to mercury-containing compounds [218]. Mercuric chloride is a notorious skin irritant. In concentrations up to 0.1% it is normally not a primary irritant to the skin; however, it may give an irritant patch-test reaction even when diluted to a 0.05% solution [218]. Numerous positive tests are likely to represent weak, false-positive irritant reactions and thus, mercuric chloride has been abandoned as a patch-test material in many countries and replaced by other less irritating mercuric compounds [219].

After skin application with mercuric chloride not giving signs of injury that could be detected clinically, changes could be detected at the ultrastructural level, with glycogen deposits in cytoplasm of Langerhans cells, lysosome-like bodies in keratinocytes and Langerhans cells, and electron-dense deposits in these cell types, in addition to melanocytes [220]. There was no apposition of mononuclear cells to Langerhans cells at the site of application of a contact-irritant concentration of mercuric chloride, while juxtaposition of mononuclear cells to Langerhans cells was noted at the site of application of mercuric chloride diluted to a clinically non-irritant concentration [221].

EFFECTS ON THE RENAL SYSTEM

Mercuric chloride is a potent nephrotoxicant in the adult rat, but has little effect on the newborn [222]. There are significant maturational changes in organ, cellular and subcellular distribution of mercury during the first 4 weeks after birth. With increasing age, mercury is redistributed from the renal cytosolic fraction to the nuclear/mitochondrial fraction, where it may be more damaging.

After administration of mercuric chloride to adult rat kidneys, several changes were found, for example, pars recta of the proximal tubular segment showing fragmentation and disruption of the plasma membrane, basophilic staining, vesiculation and disruption of endoplasmic reticulum and other cytoplasmic membranes, mitochondrial swelling, loss of mitochondrial dense granules and condensation of nuclear chromatin [223–225].

It has been suggested that mitochondrial injury was a late and possibly secondary event in mercury nephrotoxicity in rats [224]. However, compromised mitochondrial bioenergetic function was later proposed to be one of the earliest intracellular effects of mercuric chloride in the production of nephrotoxicity [226, 227].

After administration of mercuric chloride to mice, cell necrosis was found to be severest in the S2 and proximal S3 [228] segments of the proximal tubules corresponding to the preferential accumulation of mercury, engaging the convoluted part of the proximal tubular segment [229]. Very large mercury-containing lysosomes developed in the distal S3 segment.

In adult male rats, after mercuric chloride injection, in addition to tubular necrosis and rise in tubular cell counts, transient elevation of urinary glutamic-oxaloacetic transaminase activity has been found [230].

The proposed mechanism for selective straight proximal tubular injury, following *in vivo* exposure to mercuric chloride, has included tubular concentration as it progresses to the proximal tubular nits [231], tubular secretion or selective accumulation of mercuric chloride by the straight proximal tubule [232] and renin-angiotensin-induced ischaemic injury as a feedback response to decreased tubular reabsorption of sodium [225]. The injury to the proximal tubular segment could also be a result of selective uptake mechanisms for these metals by the respective cell types. Alternatively, the distribution of cytoprotective mechanisms for the particular metal might be localized to the protected cell types, leaving the other regions of the proximal tubule susceptible [233]. As another explanation for the mercuric chloride-induced acute renal failure, tubular fluid backleak has been suggested [234].

EFFECTS ON THE REPRODUCTIVE SYSTEM

Binding of Hg^{2+} to DNA may cause degeneration and chromosomal breakage of spermatogenic cells [235]. Moreover, mercuric chloride gives a direct inhibition of sequence synthesis in murine spermatogonial cells and possibly an inhibition of essential spermatogenic enzymes [236].

Mercuric chloride at a dosage of 5 mg/kg daily (i.p.) over a period of 30 days strongly inhibited spermatogenesis in rats and hamsters [237]. In addition,

testicular degeneration and cellular deformation were observed in both the seminiferous tubules and Leydig cells together with a significant decrease of testicular weights. It was suggested that the inhibition of spermatogenesis might be due to inhibition of 3β -hydroxy- δ^5 -steroid dehydrogenase in rats, leading to reduction of testosterone synthesis [238]. Moreover, high cholesterol and low ascorbic acid concentrations have been found in testicular tissue after mercuric chloride [239].

Mercuric chloride in female hamsters caused inhibition of ovulation [240].

TERATOGENICITY

Practically all of the mercuric compounds are teratogenic in animals [241, 242]. Mercuric chloride thus induced cataracts and deaths in rat embryos [243]. In the human, mercuric chloride has been related to abortion [244, 245], possibly through the inactivation of placental sulphhydryl enzymes.

GENOTOXICITY

Low concentrations ($10\ \mu\text{M}$ or less) of mercury have little effect on cellular viability and stimulate RNA and DNA synthesis, whereas higher concentrations are cytotoxic and inhibit DNA, RNA and protein synthesis [145, 146, 246–248]. Mercuric chloride is able to selectively block CHO (Chinese hamster ovary) cells in S phase, which is related to the chemical reactivity and uptake into the cells [249]. The cytotoxicity of mercury(II) compounds is probably related to their ability to inhibit DNA polymerase α activity and inhibit not only DNA synthesis but also DNA repair [250, 251].

On the other hand, mercuric chloride, at a concentration of $50\ \mu\text{M}$, also has been shown to enhance viral transformation of Syrian hamster embryo cells [252].

DNA–DNA crosslinks develop with time following exposure to HgCl_2 , probably resulting from its ability to interact directly with the DNA bases [253], while single-strand breaks may result from the production of oxygen radicals by mercuric chloride and also by its interaction with DNA bases [254, 255]. The single-strand breaks resemble those induced by X-rays [256].

Mercuric chloride at low concentration, in comparison with other metal compounds, induced the least DNA repair [257], despite its demonstrated potency in producing DNA lesions, causing equivalently effective breakage in isolated DNA as well as in DNA from cells previously treated with Hg^{2+} . The degree of modification in DNA repair induced by mercuric chloride may explain why this agent is not severely mutagenic or carcinogenic [253].

Hg^{2+} possesses weak mutagenic activity in bacterial and mammalian systems [258, 259] and may induce a low level of chromosomal aberrations [260], whereas it does not significantly enhance the incidence of sister chromatid exchanges [261]. By contrast, using larvae and embryos of the urodele amphibian *Pleurodeles waltl*, mercuric chloride was found to induce chromosomal breaks and c-mitosis after *in vivo* administration [262]. It is concluded that mercury salts in these organisms were strongly mutagenic and almost as genotoxic as CH_3HgCl .

NICKEL SULPHATE ($\text{NiSO}_4 \cdot 6\text{H}_2\text{O}$) AND NICKEL CHLORIDE ($\text{NiCl}_2 \cdot 6\text{H}_2\text{O}$)

The major contribution to ambient nickel originates from the combustion of fossil fuels; one of the predominant forms in air is nickel sulphate [263]. In electroplating shops and electro-refining plants, workers are exposed to aerosols of dissolved nickel salts; electroplating using nickel sulphate accounts for about 20% of the nickel produced [264].

No nickel-requiring enzymes or proteins are known in vertebrates, although biological roles of nickel enzymes and cofactors have been found in plants and bacteria. Although the role of nickel in human physiology has not been confirmed directly, the evidence strongly suggests that nickel is required by humans [263].

METABOLISM

Inhalation

Inhalation and ingestion are the major routes of nickel intake in humans.

At least 75% of intratracheally deposited nickel chloride had been absorbed 72 h after the operation in rats [265]. Nickel chloride was cleared from the lungs of rats more rapidly after intratracheal instillation compared with nickel oxide [266], the slower clearance being attributed to an increased solubility of nickel chloride compared with the oxide.

Ingestion

Dependent on the dietary intake, human gastrointestinal absorption of nickel may be estimated to fall between a maximum of 4% (165 μg daily intake) and a minimum of 1% (600 $\mu\text{g}/\text{day}$ intake) [263]. 4–20% of administered nickel

sulphate (equivalent to 0.6–2.5 mg of nickel) was estimated to have been absorbed by fasting human subjects [267], while mixing of the nickel sulphate with food prior to consumption apparently suppressed its absorption [268].

Absorption of water-soluble nickel salts administered to rats and mice is also in the range of 3–6% [269].

Skin uptake

Colorimetric, spectrophotometric and histochemical studies have shown that the horny layer is the epidermal barrier to nickel absorption [270]. The carboxyl groups of the keratin have been found to be important in the binding of nickel [271, 272].

Nickel salts penetrate very slowly into the human skin [272–274] and little enhancement by sweat or detergents has been observed [272]. In addition, an initial rapid phase of uptake through the sweat ducts and hair follicles has been suggested [271, 275].

The permeation rate of nickel chloride has been shown to be higher than for nickel sulphate [276, 277], due to a higher nickel ion concentration.

Even nickel ions under occlusion penetrate the human skin very slowly, with a lag-time of about 50 h [276]; there is a reversible binding of nickel to epidermis [278]. Nickel permeation is also highly dependent on the choice of vehicle [277]; a higher penetration rate of metal ions from a solution than from a semisolid suspension has been reported [279].

A reversible binding of nickel to dermis has also been shown [280].

Transport

A two-compartment model suggests that cellular and plasma nickel are in equilibrium [281]. Nickel(II) is transported in the human body by way of plasma where it is bound to carriers of both high and low relative molecular mass. The high-molecular-mass ligand is albumin, and possibly a nickel metalloprotein which has been characterized as an α_2 -macroglobulin, also called nickeloplasmin [282–284]. The low-molecular-mass component, available for urinary excretion, is likely a nickel(II)-amino complex, and of the amino acids tested, the predominant Ni(II)-binding amino acid was histidine [285, 286]. In fact, histidine has been shown to have an affinity for nickel greater than that of albumin [285]. On the contrary, it was proposed that Ni(II)-aspartate complex was the main Ni(II)-binding amino acid complex in serum; however, rabbit instead of human serum was used [287].

The binding to albumin also includes a ternary albumin-nickel-histidine

complex [288], and exchange and transfer of nickel between histidine and albumin appears to be mediated by this complex.

There is no agreement on the exact magnitude of the ultrafiltrable or high-molecular-mass fraction of Ni(II) in human serum. Moreover, pronounced species variations in the proportions of ultrafiltrable and protein-bound serum nickel have been demonstrated [289].

Distribution

In rodents, after intratracheal installation of labelled nickel sulphate [290] or intravenous [291] or intraperitoneal [292] injections of labelled nickel chloride, lungs, trachea, larynx, endocrine glands, liver, kidney and urinary bladder have been found to contain the highest concentrations of nickel. In short-term experiments, the kidney is the target organ for nickel accumulation, while in long-term experiments nickel has been reported to accumulate especially in the lungs [293, 294]. Rodent lungs contain specific nickel-binding proteins that are responsible for the pulmonary uptake and retention of nickel [293, 295]. However, in mice given free access to nickel sulphate in drinking water for 180 days, the kidney was the major organ of nickel accumulation [296].

Nickel chloride has been shown to cross the foetomaternal barrier and enter the foetus [297–301]. After injection of nickel chloride, a marked uptake of nickel already in the 5- and 6-day embryo was obtained [299]. In late gestational stages, ^{63}Ni concentrations in most foetuses increase and can even be higher in foetal organs than in maternal ones [298].

Although available data are limited, the distribution pattern of nickel in humans parallels, to some extent, that observed in animal experiments [263]. There is little long-term compartmentalization.

The cellular uptake of Ni(II) is regulated by the extracellular ligand concentration. Physiological concentrations in serum of histidine and albumin are effective in regulating the amount of ^{63}Ni (II) accumulated by cells, which has been shown for human B lymphoblasts and erythrocytes and rabbit alveolar macrophages [302]. However, in one study, cysteine blocked the uptake of Ni^{2+} by CHO cells as effectively as histidine [303]. Cysteine also competed with bovine serum albumin for $^{63}\text{Ni}^{2+}$. Moreover, the ligands have the ability to sequester Ni^{2+} from cells preloaded with this ion. By using human peripheral blood lymphocytes, it could be shown that more than 90% of the $^{63}\text{Ni}^{2+}$ accumulated by these cells was removed by three washings with culture medium RPMI 1640 [304].

The cellular uptake appears to be a passive process, the cellular distribution being dependent on cell type. In cultured pneumocytes, the cell membrane was

rapidly permeable to nickel chloride [305], nickel then being shown to be distributed to three different compartments in the cells, that is, cell membrane, cytoplasm and intracellular constituents. Also, endocytosis is an important uptake mechanism, as shown for nickel chloride encapsulated in liposomes, which facilitates nickel uptake by CHO cells [306].

Nickel salts have also been shown by autoradiography to bind to mononuclear leucocytes [307–309] and there is also an uptake by these cells [308–309].

There is a high affinity of heavy metals for nucleoli. When the distribution of some metals in nuclei and nucleoli in rat liver was determined, there was a high affinity of nickel to nucleoli, which affinity was more resistant to treatment with nucleases than that of other metals [310].

Ni^{2+} prefers to associate with heterochromatin rather than the genetically active euchromatin [306]. Using *Pseudomonas tabaci* light- and electron-microscope autoradiography, incorporated $^{63}\text{Ni}^{2+}$ -label was found central in the genetically inactive DNA, while peripheral, actively transcribing DNA had little associated radioactivity [311]. It was proposed that nickel is important stabilizing the *in vivo* structure of the DNA, particularly in the absence of associated histones.

Renal cytosol of $^{63}\text{NiCl}_2$ -treated rats contains five macromolecular ^{63}Ni -constituents that may be involved in renal uptake, transport, storage and excretion of $^{63}\text{Ni}(\text{II})$ [312]. In rat kidney, a glycoprotein was reported with a molecular mass of 15–16 kDa which was bound to nickel [313]. It was proposed that the protein was either a part of the renal basal membrane or a part of the procollagen in the process of its conversion to collagen of the renal basement membrane protein. It might play an important role in detoxification and excretion of nickel under conditions of excessive nickel intake. In addition, nickel is bound to ultrafiltrable constituents [312, 314].

Excretion

The manner of nickel excretion depends on the route of exposure and the physicochemical properties of the nickel-containing material. In rodents, the major excretion pathway for absorbed nickel is renal; about 90% of an administered dose is excreted according to this mechanism [281, 315].

In humans, it has been calculated that about 65% of the Ni^{2+} in the glomerular filtrate is reabsorbed by the renal tubular system [263], and after absorption, urine is the major route for excretion.

The half-time for urinary excretion of nickel decreases with increasing dose. About 78% of an injected dose of nickel salts was excreted in the urine during

the first 3 days after exposure in the rat and during the first day in the rabbit [281]. In humans increased nickel excretion was obtained over the days following administration of nickel sulphate orally [316, 317].

Only a few percent of an injected dose of nickel is excreted via the gastrointestinal tract in the rat [315]. In humans, there is indirect evidence of a significant biliary contribution to nickel excretion [263].

CHEMICAL INTERACTIONS

Ni^{2+} is designated as a borderline metal ion. It thus exhibits both oxygen-seeking and nitrogen/sulphur-seeking ligand preferences. Ni^{2+} effectively competes with Ca^{2+} , Mg^{2+} , Mn^{2+} and Zn^{2+} ; the consequence of such substitutions is either stimulatory or antagonistic in enzymes and physiological processes [263, 302]. Thus, much of the known toxicity of Ni^{2+} may be rationalized by its interference with the normal biochemical and physiological roles of Mg^{2+} , Zn^{2+} and especially Ca^{2+} . These metal ions are especially important in, for example, replication, transcription, translation and repair processes [318, 319].

True to its borderline character, Ni^{2+} occurs in a range of donor atom environments. Its agonistic/antagonistic relationship to Ca^{2+} attests to its affinity for oxygen donor centres (for example, carboxylate, peptide carbonyl and phosphate). Its affinity for mixed oxygen/nitrogen coordination polyhedra is typified by its substitution for Zn^{2+} in proteinases and carbonic anhydrase. There is considerable evidence that, in polynucleotides such as DNA and RNA, Ni^{2+} attachment involves both phosphate and base binding. Like Zn^{2+} , Ni^{2+} exhibits considerable partiality for the imidazole ring nitrogen(s) of histidine. In addition, by analogy to Zn^{2+} , Ni^{2+} is known to include sulphur donor atoms in nickel-requiring bacterial hydrogenases [320].

Proteins

Ni^{2+} ion thus binds to several proteins at sites which are normally occupied by other divalent metal ions [321].

Histidine complexes of many metal ions, including Ni^{2+} , are unusually strong and often of great importance biologically. The histidine residue in the third position is important for nickel binding to human serum albumin, where the nickel binding is located to the NH_2 -terminal region, involving the α - NH_2 nitrogen, imidazole nitrogen, two deprotonated peptide nitrogens, and the carboxyl side-chain of an aspartic acid residue [322]. Most Ni^{2+} in plasma is

bound by histidine in a 2:1 complex and exchange of Ni^{2+} between albumin and histidine is slow [286].

For a growing list of enzymes, nickel is one of several divalent metal ions which is necessary for substantial catalytic activity. Ni^{2+} is a cofactor in jack-bean urease [323–325] which was also suggested to be the first example of a nickel metalloenzyme [323]. Induction of heme oxygenase activity occurs in renal microsomes following parenteral administration of NiCl_2 to rodents [326–328]. Ni^{2+} may regulate both bacterial hydrogenase activity and hydrogenase protein level; no other divalent metal cation tested was able to substitute for Ni^{2+} in the formation of active hydrogenase [329, 330].

Ni^{2+} bound to deprotonated peptide nitrogens in tri- and tetrapeptides can be oxidized to Ni^{3+} [331–333]. The presence of Ni^{3+} has been reported in bacterial hydrogenases and dehydrogenases [334, 335], which suggests a biological role for the $\text{Ni}^{3+}/\text{Ni}^{2+}$ redox couple.

Nickel ions have been shown to depress the *in vivo* and *in vitro* release of prolactin [336], while the release of growth hormone was stimulated, and only at relatively high ion concentrations. Hyperglycemia occurs in rats following intraperitoneal or intratracheal injections of NiCl_2 [265, 337, 338]. The mechanism of action of nickel appears to be inhibition of insulin release; this inhibition could be related to the extremely high concentration of nickel found in the pituitary and the effect on the secretion of the pituitary hormones (growth hormone and adrenocorticotrophic hormone).

In isolated nuclei from rat liver and kidney, Ni^{2+} was bound to chromatin, polynucleosomes and to deproteinized DNA [339]. Ni^{2+} directly interacted with stable binding sites on the DNA molecule in chromatin and was associated with histone and nonhistone nuclear proteins [339, 340].

Nickel sulphate in peripheral blood T lymphocytes gave a marked increase of ^{32}P label into nonhistone proteins [109], especially in the 30–40 kDa region. It was postulated that the increase in nuclear protein phosphorylation probably reflected an activation of the lymphocytes.

Nucleic acids

Metal ions usually bind to the commonly occurring pyrimidine bases at the same site, N3, as in the corresponding nucleosides [341]. Adenosine binds Ni^{2+} weakly.

Ni^{2+} is affected profoundly by the phosphates in the nucleotides. The presence of phosphate groups greatly strengthens Ni^{2+} binding to adenosine nucleotides.

Nickel binds to multiple high- and low-affinity sites at the DNA molecule.

The high-affinity Ni^{2+} -binding sites at DNA are phosphate groups [342]. Ni^{2+} , when interacting with DNA in solution, changes the electronic properties of DNA, which leads with some probability to base changes. This in turn causes changes in the double-helix stability and leads to various defects of its structure, in particular, depurination [343]. Thus, Ni^{2+} ions are mutagenous.

Lipids

Lipid peroxidation is enhanced by nickel which is demonstrated by increased concentrations of lipid hydroperoxides in kidney, liver and lungs of NiCl_2 -treated rats [344, 345], characteristic absorbance spectrum of conjugate dienes in hepatic microsomal lipids [345], and increased production of malondialdehyde and related TBA-chromogens during *in vitro* incubation of hepatic microsomes and brain homogenates from Ni^{2+} -treated rats [346, 347]. The findings implicate lipid peroxidation as a molecular mechanism that may contribute to cell injury and death in acute nickel poisoning.

Moreover, the involvement of hydroxyl radicals in the nickel mediated enhancement of lipid peroxidation has been suggested [348], which may have implications in the carcinogenicity of nickel compounds. The enhancement of lipid peroxidation might be the result of depletion in the level of hepatic glutathione peroxidase.

EFFECTS ON THE RESPIRATORY SYSTEM

Nickel salts are highly toxic to the respiratory tract in rodents. After nickel salt inhalation or administration to the whole animal or to the tracheal epithelium directly, ciliostasis is observed both *in vivo* and *in vitro* [349, 350].

After intratracheal instillation of nickel chloride or nickel sulphate in rats, a modest inflammatory response with increased number of macrophages and polynuclear leucocytes was obtained, together with increased activities of lactate dehydrogenase and β -glucuronidase in bronchoalveolar fluid [351]. More severe lesions were characterized by type II cell hyperplasia with epithelialization of alveoli, and in some animals, fibroplasia of the pulmonary interstitium. By inhalation in rats, the nickel salts produced chronic inflammation and degeneration of the bronchiolar epithelium [352, 353]. There was also atrophy of the olfactory epithelium and hyperplasia of the bronchial and mediastinal lymph nodes. Nickel sulphate also produced a low incidence of emphysema and fibrosis [353].

Nickel chloride, by inhalation in rabbits, produced a slight but significant increase in lung weight [354]. In addition, enlarged vacuolated macrophages

in the alveolar spaces, enlarged and an increased number of vacuolated alveolar epithelial type II cells and an increase in the concentration of phospholipids, mainly due to elevated disaturated phosphatidylcholines, were found. Nickel chloride also gave an increase in the number of macrophages in the lavage fluid [355]. The surfaces of most macrophages were rich in microvilli and protrusions. Metabolic activity tended to be elevated at rest, while the capacity to kill *Staphylococcus aureus in vitro* was decreased. In addition, the level of lysozyme activity was decreased [355, 356] which was probably due to a direct effect of nickel on the macrophages [357]. *In vitro* studies with macrophages showed a dose-related inverse relationship between the lysozyme activity and concentration of nickel [358].

EFFECTS ON MUSCULAR TISSUE

Ni^{2+} can assume an agonistic or antagonistic relationship with respect to Ca^{2+} function in excitable tissues.

Hypernickelaemia occurs in patients with acute myocardial infarction or unstable angina pectoris [359]. Trace amounts of exogenous nickel chloride reduce coronary blood flow in dogs or rats by enhancing calcium influx into vascular smooth muscle cells and/or by antagonizing the coronary vasodilatation, which is produced by adenosine [360, 361]. In addition, Ni^{2+} perfusion gave markedly altered ultrastructure of rat heart; 10^{-6} M caused moderate alteration, whereas 10^{-4} M caused fundamental changes [362] with increase of cytosolic glycogen and presence of glycogen in mitochondria.

In addition to modification of calcium influx/efflux, other mechanisms like inhibition of slow inward current [363] and nickel-calcium exchange [364] have been suggested to explain the positive inotropic effects of nickel. Moreover, these inotropic effects might be mediated by an action of nickel on the outside surface of the cardiac cell membrane, where nickel inhibits the ATP-dependent component of the calcium extrusion, thereby causing contraction-enhancement [364, 365].

Ni^{2+} exerts a oxytotic effect on rat uterine muscle *in vitro* [366]. Exposure to nickel also caused mitochondrial structural damage and accumulation of glycogen.

EFFECTS ON THE IMMUNE SYSTEM

Lymphocytes

Nickel sulphate, at concentrations in the range of 10^{-6} – 10^{-8} M, stimulates the DNA synthesis of murine lymphocytes cultured in the absence of serum,

suggesting a non-specific stimulating effect [367]. When tested in children on thymocytes and peripheral blood lymphocytes in the presence of serum, nickel sulphate stimulates the DNA synthesis of both cell types [158]; in peripheral blood lymphocytes the degree of stimulation was higher than in thymocytes. In addition, a stimulation of nickel on human cord blood lymphocytes has been found, supporting a non-specific effect [368].

When nickel sulphate was tested in nickel-allergic subjects, a marked stimulated DNA synthesis was obtained; however, a stimulation at a lower degree was found in control subjects [369], findings which are in accordance with other reports [370].

Nickel sulphate was then tested on human thymocytes fractionated according to density [371]. A small DNA synthesis stimulation was found in the different cell fractions. A nickel-induced stimulation of DNA synthesis was found with peripheral blood lymphocytes from nickel-allergic patients when recovered at densities of 1.046 and 1.058 g/ml [372], the highest stimulation degree being obtained at 1.058 g/ml. Cells from the control group of patients also showed a small stimulation at these densities. By using monoclonal antibodies, cells carrying the specificity of nickel reaction have been found within the helper T cell population [373, 374]. The predominant murine splenic lymphocytes with cell-type proliferation in response to nickel were T cells with the phenotype Thy 1.2 + [375]. Cells with phenotype of Ia + were also required for the initiation of proliferation.

Monocytes have been shown to be of importance for an enhanced response of human lymphocytes to nickel [376–379]. Shelley and Juhlin [380] found a selective uptake of contact allergens like nickel sulphate by the Langerhans cells in the epidermis. They postulated that the Langerhans cells form a reticulo-epithelial system that clears the epidermis of foreign chemicals, the Langerhans cells being the site of hapten binding and antigen formation.

Nickel-specific human T-lymphocyte clones have been isolated from blood [373] and inflammatory infiltrates after nickel application [379, 381]. 7–15% of the CD4⁺ 8⁻ T-lymphocyte clones appeared to be specific for nickel in a proliferation assay [379]; this proliferation response required the presence of antigen-presenting cells and was restricted by HLA class II molecules. Nickel-specific T cells from each nickel-allergic patient were extremely heterogenous with respect to their genetic restriction [381]. Nickel-specific T lymphocytes sometimes show unusual genetic restrictions and might even respond to nickel without the participation of HLA-II molecules.

No difference in the labelling of lymphocytes with ⁶³Ni could be found in lymphocytes from nickel-allergic and control subjects [307, 308], approximately 20% of the lymphocytes being labelled. A difference was found regard-

ing the cellular uptake by peripheral blood T cells between nickel-allergic and control subjects [308], while such a difference, when studying dithiocarbamate-mediated nickel uptake by mononuclear leucocytes, could not be shown [382].

Production of migration inhibitory factors for leucocytes has been used for diagnosis of nickel allergy *in vitro* [370]. There are conflicting reports as regards the results. By using nickel protein-complexes, significant inhibition of leucocyte migration has been obtained [383, 384]. However, when a sealed capillary migration technique was used, and the migration indices of leucocytes to which nickel was added were performed, there was no difference between nickel-allergic and control subjects [385].

Nickel significantly enhanced the synthesis and/or secretion of IL-2 by cultured murine splenocytes and also the expression of the receptor for IL-2 [386]. It was also shown [387] that nickel increased IL-2 production in an antigen-specific (ovalbumin) T cell activation system *in vitro*.

An enhancement of the mixed lymphocyte reaction in mice by nickel and an enhancement of DNA synthesis induced by B cell mitogen lipopolysaccharide has been found [166]; furthermore, nickel was able to enhance the murine *in vitro* PFC response to SRBC [166, 388].

Nickel salts have also been reported to have immunosuppressive properties in rodents, including giving acute thymic involution [389, 390], suppression of T lymphocyte response to T cell mitogens [389], suppression of antibody [389, 391, 392] and interferon production [393] and suppression of natural killer (NK) cell activity [389, 394–397].

Contact allergy

It is believed that nickel penetrates the skin and acts as a hapten, complexing with selected peptide and/or amino-acid ligands to distort intercellular or cellular proteins, stimulating a type IV delayed (cell-mediated) hypersensitivity reaction [398]. Nickel water-soluble salts, like nickel chloride and nickel sulphate, are strong sensitizers [213, 215]. The chloride induced in sweat is apparently an important factor in dissolving the metallic nickel, permitting the soluble nickel salts to act.

In many countries, nickel is the commonest sensitizer in women, causing nickel allergy incidence to be high in a series of reported patch tests [399, 400]. Since 1930, the emphasis has shifted from sensitization at work to sensitization in the home by nickel-plated metal and objects made of nickel alloy. The age of onset has altered to teenagers and young women and the source is now cheap metal jewellery and fasteners on clothing such as jeans studs. Also sensitization in infancy has been reported. Nickel-sensitive patients do not

necessarily develop eczema at every site of nickel contact; the production is determined by sweating, pressure and friction under each piece of metal, and the ease with which the metal releases nickel. A secondary eruption occurs in some of the patients; in most, this is symmetrical and affects the antecubital fossa, eyelids, sides of the neck or inner thighs and sometimes becomes generalized. This secondary spread is not related to nickel contact; it has been suggested that the spread is hematogeneous and resembles the 'id' reaction of a fungus infection.

A provocation of nickel eczema after oral ingestion of nickel has been reported [401, 402]. Ingestion of 2.5 mg nickel as the sulphate aggravated chronic dermatitis in 17 of 28 patients [402]. When these patients were put on a low-nickel diet, 9 of them showed improvement.

A diagnosis of nickel allergy is obtained through patch-testing with nickel sulphate. Nickel salts are also irritants, particularly to the pores of the sweat ducts [399]. At 5% concentration, nickel sulphate is a mild irritant, but 2.5% is practically non-irritant, at least in adults. The most suitable concentration for routine patch testing has been suggested to be 5% nickel sulphate in petrolatum and, because of the mild irritant effect, in some patients, the test should be repeated by using the 5 and 2.5% concentrations. In children, due to the irritant effect, there is a requirement for dilutions of nickel sulphate weaker than for adults [403]. In addition, nickel chloride leads to more positive allergic and toxic reactions than nickel sulphate [404]. This may be due to the higher available content of nickel ions in equal concentrations of nickel chloride and nickel sulphate [405]. Even if most investigators use petrolatum as the diluent vehicle for nickel sulphate, it has been suggested [406] that distilled water is more reliable than petrolatum as a suitable material for patch-testing with metal compounds.

In addition to the patch test for nickel sulphate, intradermal nickel tests have been used [407, 408]. The intradermal testing was recommended for confirmation of doubtful patch-test reactions, particularly to disclose false positive reactions.

For *in vitro* testing of nickel contact sensitivity, the lymphocyte transformation test and leucocyte migration inhibition test have been used [370].

Immediate allergic reactions

In man, nickel may give occupational asthma due to nickel sulphate inhalation, both immediate [409, 410], late [411] and dual [412] types. Nickel-reactive antibodies have been identified in sera of immediate asthmatics by haemagglutination tests [413] and by radioimmunoassay [410, 412], while they

are absent in late asthmatics [411]. Allergic prick test has also shown an immediate reaction [409, 410]. Increased values in sera for IgG, IgA and IgM in workers exposed to nickel have been reported [414].

The nature of the antigenic determinant has been characterized in a male worker with occupational asthma from nickel [415, 416]; the antibody recognized Ni^{2+} bound at the natural $\text{Cu}^{2+}/\text{Ni}^{2+}$ transport site of human albumin. The interpretation was deduced from metal ion blocking experiments and from the good agreement obtained between the pH dependency of the formation of the Ni^{2+} -albumin complex and the antigen-antibody complex. It was suggested that the antibody interaction depended on a special structural feature of the interaction of Ni^{2+} with human serum albumin, and perhaps the ability to form an octahedral complex affords one explanation [417].

Urticaria following internal exposure to nickel has been reported [418]; the urticaria might be due to mechanisms other than delayed hypersensitivity. Precipitating antibodies against nickel sulphate bound to human albumin was found in some patients with widespread erythema after oral challenge. Moreover, patients with immediate patch test reactions to nickel and chronic urticaria have been reported [419].

EFFECTS ON THE RENAL SYSTEM

Aminoaciduria, proteinuria and morphological kidney lesions can be induced in rats with a single [420] dose of NiCl_2 (2–5 mg Ni/kg intraperitoneally). Amino-acid protein excretions consistently returned to normal by day 5 after exposure.

After peroral intake of nickel sulphate in mice, kidney damage appeared at the corticomedullary junction [296]. There was loss of renal tubular epithelial cells and protein loss, giving numerous hyaline casts in the renal tubules and collecting ducts, especially prominent in the renal papillae.

TERATOGENICITY

The water-soluble nickel salts are less teratogenic than the particulate nickel compounds, but also induce prenatal loss. No conclusion can be reached at the present time as to whether the embryonic and foetal toxicity of nickel is, in part, related to mutagenic properties [421].

Some variations exist between the susceptibility of mammalian species to the teratogenic action of nickel salts. No detrimental reproductive and developmental effects have been documented in humans [422]. Yet exposure to nickel salts must be assumed to constitute a teratogenic risk.

An increase in the frequency of runts and a greater prenatal and neonatal mortality were found in rats chronically exposed to nickel chloride or nickel sulphate in food or drinking water [423, 424]. When rats were given single (10–30 mg/kg) and repeated (2 mg/kg) intramuscular injections of nickel chloride on days 8 or 18 and 6 to 10 of gestation, respectively, no malformations were found, but a reduction in the number of live pups was observed [297].

In doses of 1.2 mg Ni/kg and up to 20 mg Ni/kg, nickel chloride caused increased resorption rates and a number of malformations in murine foetuses, specific to the foetal skeletal system, as shown by atomic absorption [425]. It was believed that nickel chloride might influence embryos during the passage through the oviduct, with subsequent effect on the development after implantation [426]. Preimplantation mouse embryos have also been used to investigate toxic effects of nickel chloride on early embryo development *in vitro*, and a dose-dependent effect has been found [427].

In addition, nickel chloride has a teratogenic potential in developing chick embryos, with malformations such as exencephaly, everted viscera, short and twisted neck and limbs, microphthalmia, haemorrhage and reduced body size being obtained [428].

GENOTOXICITY

Water-soluble nickel salts enter the cells with relative ease but are less effective than crystalline particulates in the cell transformation assay, when using hamster cells [429, 430]. However, an enhancement of viral transformation of cells has been found [431, 432]. In addition, a synergistic effect of cigarette smoke extracts, benzo[*a*]pyrene and nickel sulphate on the morphological transformation of hamster embryo cells has also been obtained [433]. It was suggested that nickel salts are more potent as promoters than they are as initiators [434].

Nickel chloride has been reported to induce DNA strand breaks in CHO cells [435] in a concentration, which did not significantly injure normal cellular division, and DNA-protein cross-links, which were concentration- and time-dependent and preferentially occurred in cells in the late S phase of the cell cycle [436]. The nickel cross-linked proteins included nonhistone chromatin proteins, nonhistone DNA-binding proteins and a 30 kDa protein that comigrated electrophoretically with histone H1. Moreover, blocking of cell growth in S phase [249] and induction of DNA repair synthesis in CHO cells [437] and reduction in the fidelity of DNA synthesis [438, 439], have been reported.

Sister chromatid exchanges in Chinese hamster cells [261, 440] and in cultured human lymphocytes [441–443] have been found after nickel salt addition.

Nickel water-soluble salts were also reported to induce chromosome aberrations in CHO cells [444, 445] and in mouse mammary carcinoma cells [260, 446]. Changes in growth control and chromosome aberrations in human bronchial cells were demonstrated *in vitro* after exposure to nickel sulphate; the changes were insufficient to cause the cells to be tumourigenic [447]. Nickel chloride was unable to produce chromosome aberrations *in vivo* in mammalian male germ cells [448].

In nickel refinery workers exposed to nickel chloride and nickel sulphate, only an increase in chromatid gaps (a doubtful type of structural aberrations) was observed [449]. By contrast, there was no increase of the mean sister chromatid exchange value in the group of nickel workers, as compared with the control group.

The pathway of delivery seems to be an important determinant in the genotoxicity of nickel compounds *in vitro*. Regarding X-chromosome fragmentation in CHO cells [306, 444], nickel chloride was reported to be ineffective by contrast to crystalline NiS. Delivery and uptake by phagocytosis of NiCl₂, artificially encapsulated in liposomes, induced fragmentation.

It is not possible to conclude with certainty that Ni(II) is mutagenic in prokaryotic and eukaryotic cell systems. Results for prokaryotes with water-soluble nickel salts have been mostly negative [258, 450–452]. A dose-dependent response has been reported for corynebacterium [453] as well as a potentiation of the mutagenicity of known alkylating agents by NiCl₂ in bacterial systems [454]. Nickel sulphate has also been found to be mutagenic in *Drosophila melanogaster* [455]. Positive mutagenic responses with NiSO₄ or NiCl₂ have been observed in a limited number of mammalian cells, e.g., mouse lymphoma cells [456] and Chinese hamster cells [457]. Nickel sulphate gave apparent chromosome length shortening in cultured human peripheral lymphocytes [458].

CARCINOGENESIS

Animal experiments have shown that nickel compounds may cause tumours, the carcinogenicity being greater the lower the solubility of the compounds in water [459].

After intramuscular injection, nickel sulphate failed to induce tumours in rats [460]. However, orally administered nickel chloride had an apparent promoting effect on chemically-induced renal tumorigenesis [461].

Inconclusive evidence exists for respiratory cancer in men working with soluble nickel compounds [462–464], while an increased risk for gastric cancer has been suggested [465].

CONCLUDING REMARKS

A further exploration of the chemical structural interactions of these metal salts at the cellular and subcellular level, in addition to a further investigation of different biochemical processes of importance for cell functions, is necessary to be able to understand their biological effects.

REFERENCES

1. T.W. Clarkson and R.E. Shapiro, *Proc. R. Soc. Can. Symp.*, (1971) 124.
2. T. Rahola, T. Hattula, A. Korolainen and J.K. Miettinen, *Ann. Clin. Res.*, 5 (1973) 214.
3. J.K. Miettinen, in *Mercury, Mercurials and Mercaptans*, eds. M.W. Miller and T.K. Clarkson (Charles C Thomas, Springfield, IL, 1973) pp. 233–243.
4. M. Berlin, in *Handbook on the Toxicology of Metals*, eds. L. Friberg, G.F. Nordberg and V. Vouk (Elsevier, Amsterdam) 2nd Edn. (1986) pp. 387–445.
5. K.Kostial, D. Kello, S. Jugo, I. Rabar and T. Maljkovic, *Environ. Health Perspect.*, 25 (1978) 81.
6. T. Endo, S. Nakaya, R. Kimura and T. Murata, *Toxicol. Appl. Pharmacol.*, 74 (1984) 223.
7. T. Endo, S. Nakaya, R. Kimura and T. Murata, *Toxicol. Appl. Pharmacol.*, 83 (1986) 187.
8. T. Endo, S. Nakaya and R. Kimura, *Pharmacol. Toxicol.*, 63 (1988) 8.
9. L. Friberg, E. Skog and J.E. Wahlberg, *Acta Dermatoven. (Stockholm)*, 41 (1961) 40.
10. J.E. Wahlberg, *Arch. Environ. Health*, 11 (1965) 201.
11. J.E. Wahlberg, *Acta Dermatoven. (Stockholm)*, 48 (1968) 336.
12. T. Suzuki, T. Miyama and H. Katsunuma, *Ind. Health*, 8 (1970) 39.
13. M. Aihara and R.P. Sharma, *Arch. Environ. Contam. Toxicol.*, 5 (1986) 629.
14. A. Rothstein, in *Current Topics in Membrane and Transport*, eds. F. Bonner and A. Kleinzeller (Academic Press, New York) Vol. I (1970) pp. 135–176.
15. D. Goldblatt, M.R. Greenwood and T.W. Clarkson, *Neurology*, 21 (1971) 439.
16. F. Nielsen-Kudsk, *Acta Pharmacol. Toxicol.*, 27 (1969) 161.
17. H. Passow, A. Rothstein and T.W. Clarkson, *Pharmacol. Rev.*, 13 (1961) 185.
18. M. Berlin and S. Gibson, *Arch. Environ. Health*, 6 (1963) 617.
19. T. Suzuki, T. Miyama and H. Katsunuma, *Ind. Health*, 5 (1967) 290.
20. H. Cember, P. Gallagher and A. Faulkner, *Am. Ind. Hyg. Assoc. J.*, 29 (1968) 233.
21. M.A. Farvar and H. Cember, *J. Occup. Med.*, 11 (1969) 11.
22. M. Jakubowski, J. Piotrowski and B. Trojanowska, *Toxicol. Appl. Pharmacol.*, 16 (1970) 743.
23. L. Friberg, *Acta Pharmacol. Toxicol.*, 12 (1956) 411.
24. O. Steinwall and H. Snyder, *Acta Neurol. Scand.*, 45 (1969) 369.
25. L.W. Chang, *Environ. Res.*, 14 (1977) 329.
26. M. Berlin and S. Ullberg, *Arch. Environ. Health*, 6 (1963) 589, 602.
27. T. Suzuki, N. Matsumoto, T. Miyama and H. Katsunuma, *Ind. Health*, 53 (1967) 219.
28. K. Mitani, T. Nakata and Y. Ose, *J. Hyg. Chem.*, 24 (1978) 102.
29. A. Khayat and L. Dencker, *Biol. Res. Preg. Perin.*, 3 (1982) 38.
30. T. Suzuki, T. Takemoto, S. Shishido and K. Kani, *Scand. J. Work. Environ. Health*, 3 (1977) 32.

31. J.K. Nicholson, D. Osborn and M.D. Kendall, *Comp. Biochem. Physiol.*, 77C (1984) 249.
32. A. Rothstein and A.D. Hayes, *J. Pharmacol. Exp. Ther.*, 130 (1960) 166.
33. T.W. Clarkson and L. Magos, *Biochem. Pharmacol.*, 19 (1970) 3029.
34. R.H. Dreisbach and R. Taugner, *Nuklearmedizin*, 5 (1966) 421.
35. R. Taugner, K. Winkel and J. Iravani, *Virchows Arch. Path. Anat.*, 340 (1966) 369.
36. P. Hultman and S. Eneström, *Br. J. Exp. Pathol.*, 67 (1986) 493.
37. J.K. Piotrowski, B. Trojanowska, J.M. Wisniewska-Knypl and W. Bolanowska, *Toxicol. Appl. Pharmacol.*, 27 (1974) 11.
38. E. Komska-Szumaska, J. Chmielnicka and J. Piotrowski, *Arch. Toxicol.*, 37 (1976) 57.
39. M.G. Cherian and T.W. Clarkson, *Chem.-Biol. Interact.*, 12 (1976) 109.
40. T.W. Clarkson and L. Magos, *Biochem. J.*, 99 (1966) 62.
41. R.J. Gerson and Z.A. Shaikh, *Biochem. Pharmacol.*, 33 (1984) 199.
42. K. Nordlind, *Int. Arch. Allergy Appl. Immunol.*, 77 (1985) 405.
43. M. Rózalski and R. Wierzbicki, *Environ. Res.*, 20 (1979) 465.
44. S.K. Chanda and M.G. Cherian, *Biochem. Biophys. Res. Commun.*, 50 (1973) 1013.
45. S.E. Bryan, C. Lambert, K.J. Hardy and S. Simons, *Science (Washington, DC)*, 186 (1974) 832.
46. S.E. Bryan, S.J. Simons, D.L. Vizard and K.J. Hardy, *Biochemistry*, 15 (1976) 1667.
47. T. Norseth, in *Chemical Fallout: Current Research in Persistent Pesticides*, eds. M.W. Miller and G.G. Berg (Charles C. Thomas, Springfield, IL, 1969) pp. 408-419.
48. T. Norseth and M. Brendeford, *Biochem. Pharmacol.*, 20 (1971) 1101.
49. L. Friberg, *Arch. Ind. Health*, 20 (1959) 42.
50. T. Rahola, T. Hattula, A. Korolainen and J.K. Miettinen, *Scand. J. Clin. Lab. Invest.*, 27, Suppl. 116 (1971) 77.
51. M. Berlin, *Acta Med. Scand.*, Suppl. 396 (1963).
52. W. Wessel, *Verh. Dtsch. Ges. Pathol.*, 51 (1967) 313.
53. J. Vostal and J. Hellers, *Environ. Res.*, 2 (1968) 1.
54. P. Hultman, S. Eneström and H. von Schenck, *Virchows Arch. Cell Pathol.*, 49 (1985) 209.
55. M.M. Joselow, R. Rinz and L.J. Goldwater, *Arch. Environ. Health*, 17 (1968) 35.
56. C.D. Klaassen, *Toxicol. Appl. Pharmacol.*, 33 (1975) 356.
57. N. Ballatori and T.W. Clarkson, *Biochem. Pharmacol.*, 33 (1984) 1087.
58. N. Ballatori and T.W. Clarkson, *Biochem. Pharmacol.*, 33 (1984) 1093.
59. L. Magos, A.A. Tuffery and T.W. Clarkson, *Br. J. Ind. Med.*, 21 (1964) 293.
60. T.W. Clarkson and A. Rothstein, *Health Phys.*, 10 (1964) 1115.
61. M. Abdulla, B. Arnesjö and I. Ihse, *Scand. J. Gastroenterol.*, 8 (1973) 565.
62. I.R. Rowland, P. Grasso and M.J. Davies, *Experientia*, 31 (1975) 1064.
63. A. Kiwimäe, Å. Swensson, U. Ulfvarson and G. Westöb, *J. Agr. Food Chem.*, 17 (1969) 1014.
64. A. Brun, M. Abdulla, I. Ihse and B. Samuelsson, *Histochemistry*, 47 (1976) 23.
65. T. Norseth and T.W. Clarkson, *Arch. Environ. Health*, 22 (1970) 568.
66. M.W. Williams, J.D. Hoeschle, J.E. Turner, K.B. Jacobson, N.T. Christie, C.L. Paton, L.H. Smith, H.R. Witschi and E.H. Lee, *Toxicol. Appl. Pharmacol.*, 63 (1982) 461.
67. P.R. Brown and J.D. Edwards, *Biochemistry*, 8 (1969) 1200.
68. B.L. Vallee and D.D. Ulmer, *Annu. Rev. Biochem.*, 41 (1972) 91.
69. D.N. Kachru and S.K. Tandon, *Res. Commun. Chem. Pathol. Pharmacol.*, 521 (1986) 399.
70. T.W. Clarkson, *Annu. Rev. Pharmacol.*, 12 (1972) 375.
71. J.C.K. Lai and H. Barrow, *Comp. Biochem. Physiol.*, 78C (1984) 81.

72. K. Waku and Y. Nakazawa, *Toxicol. Lett.*, 4 (1979) 49.
73. K.V. Sastry and P.K. Gupta, *Bull. Environ. Contam. Toxicol.*, 20 (1978) 353.
74. K.V. Sastry and K. Sharma, *Bull. Environ. Contam. Toxicol.*, 23 (1979) 74.
75. P.K. Gupta and K.V. Sastry, *Environ. Res.*, 24 (1981) 15.
76. M.P. Dieter, M.I. Luster, G.A. Boorman, C.W. Jameson, J.H. Dean and J.W. Cox, *Toxicol. Appl. Pharmacol.*, 68 (1983) 218.
77. W.B. Kinter and J.B. Pritchard, in *Handbook of Physiology-Reactions to Environmental Agents*, ed. D.H.K. Lee, Sect. 9 (1977) Ch. 36, pp. 563-576.
78. J.L. Webb, in *Enzymes and Metabolic Inhibitors (Academic Press, New York) Vol. II (1966) pp. 729-1070.*
79. E. Walum and H. Marchner, *Toxicol. Lett.*, 18 (1983) 89.
80. J. VanSteveninck, R.I. Weed and A. Rothstein, *J. Gen. Physiol.*, 48 (1965) 617.
81. P.P. Sokol, P.D. Holohan and C.R. Ross, *Biochim. Biophys. Acta*, 862 (1986) 335.
82. I. Tayarini, J.-M. Lefauconnier and J.-M. Bourre, *Neurotoxicology*, 8 (1987) 543.
83. D. Allemand, G. de Renzis, P. Payan, J.-P. Girard and R. Vaissiere, *Toxicology*, 50 (1988) 217.
84. N. Ballatori, C. Shi and J.L. Boyer, *Toxicol. Appl. Pharmacol.*, 95 (1988) 279.
85. B. Rajanna and M. Hobson, *Toxicol. Lett.*, 27 (1985) 7.
86. N. Brookes, *J. Neurochem.*, 50 (1988) 1117.
87. J.F. Schaeffer, R.L. Preston and P.F. Curran, *J. Gen. Physiol.*, 62 (1973) 131.
88. C.E. Stirling, *J. Membr. Biol.*, 23 (1975) 33.
89. J. Lerner, P.A. Sattelmeyer, C.F. Janicki and J.S.P. Estes, *Comp. Biochem. Physiol.*, 56 (1977) 171.
90. A. Klip, S. Grinstein, J. Biber and G. Semenza, *Biochem. Biophys. Acta*, 598 (1980) 100.
91. M.J. Rodríguez-Yoldi, M. Lluch and F. Ponz, *Rev. Español. Fisiol.*, 43 (1987) 239.
92. N.J. Prakash, J. Fontana and R.Z. Henkin, *Life Sci.*, 12 (1973) 249.
93. B.R. Nechay and J.P. Saunders, *J. Environ. Pathol. Toxicol.*, 2 (1978) 283.
94. S. Magour, H. Mäser and H. Greim, *Pharmacol. Toxicol.*, 60 (1987) 184.
95. J.L. Borowitz, *Toxicol. Appl. Pharmacol.*, 28 (1974) 82.
96. S.J. McKay, J.N. Reynolds and W.J. Racz, *Can. J. Physiol. Pharmacol.*, 64 (1986) 1507.
97. Y. Nakazato, T. Asano and A. Ohga, *Toxicol. Appl. Pharmacol.*, 48 (1979) 171.
98. O. Binah, U. Meiri and H. Rahamimoff, *Eur. J. Pharmacol.*, 51 (1978) 453.
99. G.G. Clifton, C.J. Pearce, K. Elliot and J.D. Wallin, *Biochim. Biophys. Acta*, 887 (1986) 189.
100. M.D. Miyamoto, *Brain Res.*, 267 (1983) 375.
101. K.E. Eason and R.S. Aronstam, *Res. Commun. Chem. Pathol. Pharmacol.*, 44 (1984) 503.
102. M. Chiesi and G. Inesi, *J. Biol. Chem.*, 254 (1979) 10370.
103. J.J. Abramson, J.L. Trimm, L. Weden and G. Salama, *Proc. Natl. Acad. Sci. USA*, 80 (1983) 1526.
104. W.F. Hood and R.A. Harris, *Biochem. Pharmacol.*, 29 (1980) 957.
105. A.E. Shamoo and D.H. MacLennan, *J. Membr. Biol.*, 25 (1975) 65.
106. A.E. Shamoo, D.H. MacLennan and M.E. Eldefrawi, *Chem.-Biol. Interact.*, 12 (1976) 41.
107. J.S. Mills and J.D. Johnson, *J. Biol. Chem.*, 260 (1985) 15100.
108. Y.-J. Kang, M.O.J. Olson and H. Busch, *J. Biol. Chem.*, 249 (1974) 5580.
109. M. Holst and K. Nordlind, *Int. Arch. Allergy Appl. Immunol.*, 85 (1988) 337.
110. M. Holst and K. Nordlind, *Int. Arch. Allergy Appl. Immunol.*, 87 (1988) 381.
111. Y. Inoue, J. Saijoh and K. Sumino, *Pharmacol. Toxicol.*, 62 (1988) 278.
112. S. Katz, *J. Am. Chem. Soc.*, 74 (1952) 2238.

113. C.A. Thomas, *J. Am. Chem. Soc.*, 76 (1954) 6052.
114. M. Matsuda and E. Takeuchi, *J. Biochem.*, 61 (1967) 523.
115. A. Casadevall and L.A. Day, *Biochemistry*, 22 (1983) 4831.
116. S. Katz, *Biochim. Biophys. Acta*, 68 (1963) 240.
117. S. Katz and V. Santilli, *Biochim. Biophys. Acta*, 55 (1962) 621.
118. D.B. Millar, *Biochem. Biophys. Res. Commun.*, 28 (1967) 70.
119. Y. Kawade, *Biochem. Biophys. Res. Commun.*, 10 (1963) 204.
120. M.N. Williams and D.M. Crothers, *Biochemistry*, 14 (1975) 1944.
121. D.A. Troyer, J.I. Kreisberg and M.A. Venkatachalam, *Kidney Int.*, 29 (1986) 530.
122. M. Mehra and K.C. Kanwar, *Toxicol. Lett.*, 6 (1980) 319.
123. I. Cloez, O. Dumont, M. Piciotti and J.M. Bourre, *Toxicology*, 46 (1987) 65.
124. W.T. Shier and D.J. DuBourdiou, *Biochem. Biophys. Res. Commun.*, 110 (1983) 758.
125. J.-D. Sraer, L. Baud, J. Sraer, F. Delarue and R. Ardaillou, *Kidney Int.*, 21, Suppl. 11 (1982) S-63.
126. R.M. Lachowicz, N.M. Hammoud, J.L. Teibel and J.A. Dix, *FEBS Lett.*, 234 (1988) 195.
127. T.J. Taylor, F. Rieders and J.J. Kucsis, *Fed. Proc.*, 32 (1973) 261.
128. O. Wada, N. Yamaguchi, T. Ono, M. Nagahashi and T. Morimura, *Environ. Res.*, 12 (1976) 75.
129. R.S. Black, P.D. Whanger and M.J. Tripp, *Biol. Trace Elem. Res.*, 1 (1979) 313.
130. N.H. Stacey and C.D. Klaassen, *J. Toxicol. Environ. Health*, 7 (1981) 139.
131. N.H. Stacey and H. Kappus, *Toxicol. Appl. Pharmacol.*, 63 (1982) 29.
132. C.-P. Siegers, S.C. Sharma and M. Younes, *Toxicol. Lett.*, 34 (1986) 185.
133. D.R. Klonne and D.R. Johnson, *Toxicol. Lett.*, 42 (1988) 199.
134. V. Eybl, J. Sykora and F. Mertl, *Arch. Toxicol.*, 25 (1969) 296.
135. J. Parizek and I. Ostadalova, *Experientia*, 23 (1967) 142.
136. N. Imura and A. Naganuma, *J. Pharmacobio-Dyn.*, 1 (1978) 67.
137. A. Naganuma and N. Imura, *Res. Commun. Chem. Pathol. Pharmacol.*, 27 (1980) 163.
138. J.C. Hansen, P. Kristensen and S.N. Al-Masri, *Nord. Vet. Med.*, 33 (1981) 57.
139. R.F. Burke, K.A. Foster, P.M. Greenfield and K.W. Kiker, *Proc. Soc. Exp. Biol. Med.*, 145 (1974) 782.
140. D. Jorgensen and J.F. Heisinger, *Comp. Biochem. Physiol.*, 87C (1987) 181.
141. J.W. Ridlington and P.O. Whanger, *Fund. Appl. Toxicol.*, 1 (1981) 368.
142. A.-S. Chung, M.D. Maines and W.A. Reynolds, *Biochem. Pharmacol.*, 31 (1982) 3093.
143. T. Aoi, T. Higuchi, R. Kidokoro, R. Fukumura, A. Yagi, S. Ohguchi, A. Sasa, H. Hayashi, N. Sakamoto and T. Hanaichi, *Human Toxicol.*, 4 (1985) 637.
144. K. Miura, S. Nakada, K. Suzuki and N. Imura, *Ecotoxicol. Environ. Safety*, 3 (1979) 352.
145. S. Nakada and N. Imura, *Toxicol. Appl. Pharmacol.*, 53 (1980) 24.
146. S. Nakada, A. Nomoto and N. Imura, *Ecotoxicol. Environ. Safety*, 4 (1980) 184.
147. P. Sangdee, L.M. Partlow and L.G. Bush, *Toxicol. Appl. Pharmacol.*, 60 (1981) 253.
148. M. Goldman and P. Blackburn, *Toxicol. Appl. Pharmacol.*, 48 (1979) 49.
149. J. Kawada, M. Nishida, Y. Yoshimura and K. Mitani, *J. Pharmacobio-Dyn.*, 3 (1980) 149.
150. M. Nishida, T. Yamamoto, Y. Yoshimura and J. Kawada, *J. Pharmacobio-Dyn.*, 9 (1986) 331.
151. J.L. Pauly, G.A. Caron and R.R. Suskind, *J. Cell Biol.*, 40 (1969) 847.
152. E. Schöpf, K.H. Schulz and M. Gromm, *Naturwissenschaften*, 54 (1967) 568.
153. E. Schöpf, K.H. Schulz and I. Isensee, *Arch. Klin. Exp. Dermatol.*, 234 (1969) 420.
154. G.A. Caron, S. Poutala and T.T. Provost, *Int. Arch. Allergy*, 37 (1970) 76.
155. S. Yachnin, *Clin. Exp. Immunol.*, 11 (1972) 109.

156. N.A. Berger and S.A.M. Skinner, *J. Cell Biol.*, 61 (1974) 45.
157. F. Hutchinson, T.M. Macleod and E.J. Raffle, *Clin. Exp. Immunol.*, 26 (1976) 531.
158. K. Nordlind and A. Henze, *Int. Arch. Allergy Appl. Immunol.*, 73 (1984) 162.
159. K. Nordlind, *Int. Arch. Allergy Appl. Immunol.*, 72 (1983) 177.
160. K. Nordlind, U. Ernström and A. Henze, *Int. Arch. Allergy Appl. Immunol.*, 83 (1987) 190.
161. K. Nordlind, *Int. Arch. Allergy Appl. Immunol.*, 75 (1984) 16.
162. G. Lischka, *Arch. Dermatol. Res.*, 255 (1976) 57.
163. C.L. Reardon and D.O. Lucas, *Immunobiology*, 175 (1987) 455.
164. D. Baran, O. Lantz, P. Dosquet, A. Sfaksi and P. Druet, *Clin. Exp. Immunol.*, 73 (1988) 401.
165. M. Ohsawa and M. Kimura, *Biochem. Biophys. Res. Commun.*, 91 (1979) 569.
166. D.A. Lawrence, *Toxicol. Appl. Pharmacol.*, 57 (1981) 439.
167. L.D. Koller, *Am. J. Vet. Res.*, 34 (1973) 1458.
168. M.A. Bridger, *Arch. Environ. Contam. Toxicol.*, 12 (1983) 45.
169. T. Ochi and M. Ohsawa, *J. Toxicol. Sci.*, 7 (1982) 235.
170. K. Nordlind and J. Thyberg, *Int. Arch. Allergy Appl. Immunol.*, 70 (1983) 19.
171. D. Malamud, S.A. Dietrich and I.M. Shapiro, *Biochem. Biophys. Res. Commun.*, 128 (1985) 1145.
172. B. Baginski, *Toxicology*, 50 (1988) 247.
173. J. Contrino, P. Marucha, R. Ribaud, R. Ference, P.E. Bigazzi and D.L. Kreutzer, *Am. J. Pathol.*, 132 (1988) 110.
174. D. Lison, P. Dubois and R. Lauwerys, *Toxicol. Lett.*, 40 (1988) 29.
175. B. Bellon, M. Capron, E. Druet, P. Veroust, M.-C. Vial, C. Sapin, J.F. Girard, J.M. Foidart, P. Mahieu and P. Druet, *Eur. J. Clin. Invest.*, 12 (1982) 127.
176. C. Bowman, D.K. Peters and C.M. Lockwood, *J. Immunol. Methods*, 61 (1983) 325.
177. J.H. Michaelson, J.P. McCoy, P. Hirszel and P.E. Bigazzi, *Surv. Synth. Pathol. Res.*, 4 (1985) 401.
178. A. Fukatsu, J.R. Brentjens, P.D. Killen, H.K. Kleinman, G.R. Mertin and G.A. Andres, *Clin. Immunol. Immunopathol.*, 45 (1987) 35.
179. C. Sapin, E. Druet and P. Druet, *Clin. Exp. Immunol.*, 28 (1977) 173.
180. G.A. Henry, B.M. Jarnot, M.M. Steinhoff and P.E. Bigazzi, *Clin. Immunol. Immunopathol.*, 49 (1988) 187.
181. F. Hirsch, J. Couderc, C. Sapin, G. Fournié and P. Druet, *Eur. J. Immunol.*, 12 (1982) 620.
182. D. Houssin, E. Druet, N. Hinglais, P. Verroust, J. Grossetete, J. Bariety and P. Druet, *Clin. Immunol. Immunopathol.*, 29 (1983) 167.
183. N. Hinglais, P. Druet, J. Grossetete, C. Sapin and J. Bariety, *Lab. Invest.*, 41 (1979) 150.
184. P. Druet, E. Druet, F. Potdevin and C. Sapin, *Ann. Immunol. (Paris)*, 129C (1978) 777.
185. J.F. Bernaudin, E. Druet, M.F. Belair, M.C. Pinchon, C. Sapin and P. Druet, *Clin. Exp. Immunol.*, 38 (1979) 265.
186. A.A. Roman-Franco, M. Turiello, B. Albin, E. Osi, F. Milgrom and G.A. Andres, *Clin. Immunol. Immunopathol.*, 9 (1978) 464.
187. J.F. Bernaudin, E. Druet, P. Druet and R. Masse, *Clin. Immunol. Immunopathol.*, 20 (1981) 129.
188. P. Knoflach, B. Albin and M.M. Weiser, *Toxicol. Pathol.*, 14 (1986) 188.
189. P. Druet, P. Teychenne, C. Mandet, C. Bascou and E. Druet, *Nephron*, 28 (1981) 145.
190. A. Provoust-Danon, A. Abadie, C. Sapin, H. Bazin and P. Druet, *J. Immunol.*, 126 (1981) 699.

191. R.D. Murdoch and J. Pepys, *Int. Arch. Allergy Appl. Immunol.*, 80 (1986) 405.
192. J.J. Weening, G.J. Fleuren and P.J. Hoedemaeker, *Lab. Invest.*, 39 (1978) 405.
193. J.J. Weening, P.J. Hoedemaeker and W.W. Bakker, *Clin. Exp. Immunol.*, 45 (1981) 64.
194. L. Pelletier, R. Pasquier, F. Hirsch, C. Sapin and P. Druet, *J. Immunol.*, 137 (1986) 2548.
195. L. Pelletier, R. Pasquier, M.C. Vial, C. Mandet, R. Moutier, J.C. Salomon and P. Druet, *Nephrol. Dial. Transplant*, 1 (1987) 211.
196. L. Pelletier, R. Pasquier, C. Guettier, M.C. Vial, C. Mandet, D. Nochy, H. Bazin and P. Druet, *Clin. Exp. Immunol.*, 71 (1988) 336.
197. C. Bowman, D.W. Mason, C.D. Pusey and C.M. Lockwood, *Eur. J. Immunol.*, 14 (1984) 464.
198. C. Bowman, C. Green, L. Borysiewicz and C.M. Lockwood, *Immunology*, 61 (1987) 515.
199. J. M. Chalopin and C.M. Lockwood, *Eur. J. Immunol.*, 14 (1984) 470.
200. E. Druet, C. Sapin, E. Gunther, N. Feingold and P. Druet, *Eur. J. Immunol.*, 7 (1977) 348.
201. C. Sapin, C. Mandet, E. Druet, E. Gunther and P. Druet, *Clin. Exp. Immunol.*, 48 (1982) 700.
202. L. Pelletier, R. Pasquier, J. Rossert and P. Druet, *Eur. J. Immunol.*, 17 (1987) 49.
203. G.J.C. Robinson, A.A. Abraham and T. Balazs, *Clin. Exp. Immunol.*, 58 (1984) 300.
204. C.J. Robinson, T. Balazs and I.K. Egorov, *Toxicol. Appl. Pharmacol.*, 86 (1986) 159.
205. P. Hultman and S. Eneström, *Clin. Exp. Immunol.*, 71 (1988) 269.
206. P. Hultman, Effects of inorganic mercury on the murine immune system in vivo. Autoimmunity and systemic immune-complex deposits. Dissertation, Linköping 1989.
207. R. Reuter, G. Tessars, H.-W. Vohr, E. Gleichmann and R. Luhrmann, *Proc. Natl. Acad. Sci. USA*, 86 (1989) 237.
208. R. Stiller-Winkler, T. Radaszkiewicz and E. Gleichmann, *Int. J. Immunopharmacol.*, 10 (1988) 475.
209. P. Hultman and S. Eneström, *J. Clin. Lab. Immunol.* (in press).
210. S. Fregert and N. Hjorth, *Contact Dermatitis Newsletter*, 5 (1969) 88.
211. L. Polák, J.M. Barnes and J.L. Turk, *Immunology*, 14 (1968) 707.
212. J.L. Turk and L. Polák, *Int. Arch. Allergy*, 36 (1969) 75.
213. B. Magnusson and A.M. Kligman, *J. Invest. Dermatol.*, 52 (1969) 268.
214. M. Taugner and R. Schutz, *Dermatologica*, 133 (1966) 245.
215. A.M. Kligman, *J. Invest. Dermatol.*, 47 (1966) 393.
216. N. Hjorth, *Acta Dermatoven. (Stockholm)*, Suppl. 95 (1981) 36.
217. H. Röckl, E. Muller and W. Hiltermann, *Arch. Klin. Exp. Dermatol.*, 226 (1966) 407.
218. R.L. Baer, D.L. Ramsey and E. Biondi, *Arch. Dermatol.*, 108 (1973) 74.
219. E. Epstein, *Arch. Dermatol.*, 109 (1974) 98.
220. I. Silberberg, *J. Invest. Dermatol.*, 56 (1971) 147.
221. I. Silberberg, *Acta Dermatoven. (Stockholm)*, 53 (1973) 1.
222. G.P. Daston, B.F. Rehnberg, L.L. Hall and R.J. Kavlock, *Toxicol. Appl. Pharmacol.*, 85 (1986) 39.
223. T.L. Gritzka and B.F. Trump, *Am. J. Pathol.*, 52 (1968) 1225.
224. C.E. Ganote, K.A. Reimer and R.B. Jennings, *Lab. Invest.*, 31 (1974) 633.
225. B.H. Haagsma and A.W. Pound, *Br. J. Exp. Pathol.*, 60 (1979) 341.
226. J.M. Weinberg, P.G. Harding and H.D. Humes, *J. Biol. Chem.*, 257 (1982) 60.
227. J.M. Weinberg, P.G. Harding and H.D. Humes, *J. Biol. Chem.*, 257 (1982) 68.
228. A.B. Maunsbach, *J. Ultrastruct. Res.*, 16 (1966) 239.
229. P. Hultman and S. Eneström, *Br. J. Exp. Pathol.*, 67 (1986) 493.
230. L.F. Prescott and S. Ansari, *Toxicol. Appl. Pharmacol.*, 14 (1969) 97.

231. F.L. Siegel and R.E. Bulger, *Virchows Arch. Cell Pathol.*, 18 (1975) 243.
232. R.C. Zalme, E.M. McDowell, R.B. Nagle, J.S. McNeil, W. Flamenbaum and B.F. Trump, *Virchows Arch. Cell Pathol.*, 22 (1976) 197.
233. C.E. Ruegg, A.J. Gandolfi, R.B. Nagle and K. Brendel, *Toxicol. Appl. Pharmacol.*, 90 (1987) 261.
234. J.D. Conger and S.A. Falk, *J. Lab. Clin. Med.*, 107 (1986) 281.
235. S. Skerfving, K. Hansson and J. Lindsten, *Arch. Environ. Health*, 21 (1970) 133.
236. I.P. Lee and R.L. Dixon, *J. Pharmacol. Exp. Ther.*, 194 (1975) 171.
237. A.R. Chowdhury and U. Arora, *Indian J. Physiol. Pharmacol.*, 26 (1982) 246.
238. A.R. Chowdhury, K.D. Vachhrajani and B.B. Chatterjee, *Toxicol. Lett.*, 27 (1985) 45.
239. A.R. Chowdhury, K.D. Vachhrajani, S. Makhija and S.K. Kashyap, *Biomed. Biochim. Acta*, 45 (1986) 949.
240. T. Watanabe, T. Shimada and A. Endo, *Teratology*, 25 (1982) 381.
241. B.J. Koos and L.D. Longo, *Am. J. Obstet. Gynecol.*, 126 (1976) 390.
242. J.L. Schardein, in *Chemically Induced Birth Defects* (Marcel Dekker, New York and Basel, 1985) pp. 622-632.
243. T. Miyoshi, *J. Osaka City Med. Cent.*, 8 (1959) 309.
244. L. Derobert, S. Tara and M. Leroux, *Ann. Med. Leg. Criminal Police Sci Toxicol.*, 30 (1950) 222.
245. J.F. Afonso and R.R. de Alvarez, *Am. J. Obstet. Gynecol.*, 80 (1960) 145.
246. N. Nakazawa, F. Makino and S. Okada, *Biochem. Pharmacol.*, 24 (1975) 489.
247. M. Rozalski and R. Wierzbicki, *Biochem. Pharmacol.*, 32 (1983) 2124.
248. E.S.-E. Chao, J.F. Gierthy and G.D. Frenkel, *Biochem. Pharmacol.*, 33 (1984) 1941.
249. M. Costa, O. Cantoni, M. De Mars and D.E. Schwarzendruber, *Res. Commun. Chem. Pathol. Pharmacol.*, 38 (1982) 405.
250. S.H. Robison, O. Cantoni and M. Costa, *Mutat. Res.*, 131 (1984) 173.
251. N.T. Christie, O. Cantoni, M. Sugiyama, F. Cattabeni and M. Costa, *Mol. Pharmacol.*, 229 (1986) 173.
252. B.C. Casto, J. Meyers and J.A. DiPaolo, *Cancer Res.*, 39 (1979) 193.
253. O. Cantoni and M. Costa, *Mol. Pharmacol.*, 24 (1983) 84.
254. O. Cantoni, S.H. Robison, R.M. Evans, N.T. Christie, D.B. Drath and M. Costa, *Fed. Proc.*, 42 (1983) 1135.
255. O. Cantoni, N.T. Christie, A. Swann, D.B. Drath and M. Costa, *Mol. Pharmacol.*, 26 (1984) 360.
256. O. Cantoni, R.M. Evans and M. Costa, *Res. Commun. Chem. Pathol. Pharmacol.*, 38 (1982) 405.
257. S.H. Robison, O. Cantoni and M. Costa, *Mutat. Res.*, 131 (1984) 173.
258. N. Kanematsu, M. Hara and T. Kada, *Mutat. Res.*, 77 (1980) 109.
259. T.J. Oberly, C.E. Piper and D.S. McDonald, *J. Toxicol. Environ. Health*, 9 (1982) 367.
260. M. Umeda and M. Nishimura, *Mutat. Res.*, 67 (1979) 221.
261. H. Ohno, F. Hananoka and M.A. Yamada, *Mutat. Res.*, 104 (1982) 141.
262. C. Zoll, E. Saouter, A. Boudou, F. Ribeyre and A. Jaylet, *Mutagenesis*, 3 (1988) 337.
263. E. Nieboer, R.T. Tom and W.E. Sanford, *Metal Ions Biol. Systems*, 23 (1988) 91.
264. T. Norseth, in *Ref. 4*, pp. 462-481.
265. J.J. Clary, *Toxicol. Appl. Pharmacol.*, 31 (1975) 55.
266. J.C. English, R.D.R. Parker, R.P. Sharma and S.G. Oberg, *Am. Ind. Hyg. Assoc. J.*, 42 (1981) 486.
267. E. Cronin, A.D. DiMichiel and S.S. Brown, in *Nickel Toxicology*, eds. S.S. Brown and F.W. Sunderman, Jr. (Academic Press, London, 1980) pp. 149-152.

268. N.W. Solomons, F. Viteri, T.R. Schuler and F.H. Nielsen, *J. Nutr.*, 112 (1982) 39.
269. W. Ho and A. Furst, *Proc. West. Pharmacol. Soc.*, 16 (1973) 245.
270. F.I. Kolpakov, *Fed. Proc.*, 23 (1964) T475.
271. G.C. Wells, *Br. J. Dermatol.*, 68 (1956) 237.
272. M.H. Samitz and S.A. Katz, *Environ. Res.*, 11 (1976) 34.
273. T. Fischer and H.I. Maibach, *Contact Dermatitis*, 11 (1984) 134.
274. K. Kalimo, K. Lammintausta, J. Maki, J. Teuho and C.T. Jansen, *Contact Dermatitis*, 12 (1985) 255.
275. G.K. Lloyd, in Ref. 267, pp. 145-148.
276. A. Fullerton, J.R. Andersen, A. Hoelgaard and T. Menné, *Contact Dermatitis*, 15 (1986) 173.
277. A. Fullerton, J.R. Andersen and A. Hoelgaard, *Br. J. Dermatol.*, 118 (1988) 509.
278. A. Fullerton and A. Hoelgaard, *Br. J. Dermatol.*, 119 (1988) 675.
279. J.E. Wahlberg, *Acta Dermatoven. (Stockholm)*, 45 (1976) 397.
280. D. Spruit, J.W.H. Mali and N.D. Groot, *J. Invest. Dermatol.*, 44 (1965) 103.
281. C. Onkelinx, J. Becker and F.W. Sunderman, Jr., *Res. Commun. Chem. Pathol. Pharmacol.*, 6 (1973) 664.
282. F.W. Sunderman, Jr., *Ann. Clin. Lab. Sci.*, 7 (1977) 377.
283. S. Nomoto, in Ref. 267, pp. 89-90.
284. B.J. Scott and A.R. Bradwell, *Clin. Chem.*, 29 (1983) 629.
285. M. Lucassen and B. Sarkar, *J. Toxicol. Environ. Health*, 5 (1979) 897.
286. S.H. Laurie and D.E. Pratt, *J. Inorg. Biochem.*, 28 (1986) 431.
287. N. Asato, M. van Soestbergen and F.W. Sunderman, Jr., *Clin. Chem.*, 21 (1975) 521.
288. J.D. Glennon and B. Sarkar, *Biochem. J.*, 203 (1982) 15.
289. R.C. Hendel and F.W. Sunderman, Jr., *Res. Commun. Chem. Pathol. Pharmacol.*, 4 (1972) 141.
290. M.A. Medinsky, J.M. Benson and C.H. Hobbs, *Environ. Res.*, 43 (1987) 168.
291. K. Parker and F.W. Sunderman, Jr., *Res. Commun. Chem. Pathol. Pharmacol.*, 7 (1974) 755.
292. B. Sarkar, *Metal Ions Biol. Systems*, 12 (1981) 233.
293. M.C. Herlant-Peers, H.F. Hildebrand and J.P. Kerckaert, *Carcinogenesis*, 4 (1983) 387.
294. J.A. Knight, W.N. Rezuke, C.G. Gillies, S.M. Hopfer and F.W. Sunderman, Jr., *Toxicol. Pathol.*, 16 (1988) 350.
295. A. Oskarsson and H. Tjälve, *Acta Pharmacol. Toxicol.*, 45 (1979) 306.
296. M.P. Dieter, C.W. Jameson, A.N. Tucker, M.I. Luster, J.E. French, H.L. Hong and G.A. Boorman, *J. Toxicol. Environ. Health*, 24 (1988) 357.
297. F.W. Sunderman, Jr., S.K. Shen, I.M. Mitchell, P.R. Allpass and I. Damjanov, *Toxicol. Appl. Pharmacol.*, 43 (1978) 381.
298. N. Jacobsen, I. Alfheim and J. Jonsen, *Res. Commun. Chem. Pathol. Pharmacol.*, 20 (1978) 571.
299. I. Olsen and J. Jonsen, *Toxicology*, 12 (1979) 165.
300. B. Bergman, M. Bergman, B. Magnusson and R. Soremark, *Oral Rehab.*, 7 (1980) 319.
301. C.C. Lu, N. Matsumoto and S. Iijima, *Toxicol. Appl. Pharmacol.*, 59 (1981) 409.
302. E. Nieboer, A.R. Stafford, S.L. Evans and J. Dolovich, in *Nickel in the Human Environment*, ed. F.W. Sunderman, Jr., (IARC Sci. Publ. No. 53; 1984) pp. 321-331.
303. M. P. Abbraccio, R.M. Evans, J.D. Heck, O. Cantoni and M. Costa, *Biol. Trace Elem. Res.*, 4 (1982) 289.
304. N.K. Veien, N. Morling and E. Svejgaard, *Acta Dermatoven. (Stockholm)*, 61 (1980) 64.

305. K. Saito and D.B. Menzel, *Tohoku J. Exp. Med.*, 148 (1986) 295.
306. P. Sen and M. Costa, *Toxicol. Appl. Pharmacol.*, 84 (1986) 278.
307. F. Hutchinson, T.M. MacLeod and E.J. Raffle, *Br. J. Dermatol.*, 93 (1975) 557.
308. K. Nordlind, *Int. Arch. Allergy Appl. Immunol.*, 78 (1985) 364.
309. S. Silvennoinen-Kassinen, H. Jakkula and J. Karvonen, *Clin. Exp. Dermatol.*, 12 (1987) 265.
310. H. Ono, O. Wada and T. Ono, *J. Toxicol. Environ. Health*, 8 (1981) 947.
311. R.H. Al-Rabae and D.C. Sigeo, *J. Cell Sci.*, 69 (1984) 87.
312. F.W. Sunderman, Jr., E.R. Costa, C. Fraser, G. Hui, J.J. Levine and T.P.H. Tse, *Ann. Clin. Lab. Sci.*, 11 (1981) 488.
313. A.W. Abdulwajid and B. Sarkar, *Proc. Natl. Acad. Sci. USA*, 80 (1983) 4509.
314. B. Sarkar, in Ref. 267, pp. 81-84.
315. F.W. Sunderman, Jr. and C.E. Selin, *Toxicol. Appl. Pharmacol.*, 12 (1968) 207.
316. D. Spruit and P.J.M. Bongaarts, *Dermatologica*, 154 (1977) 291.
317. T. Menné, H.I. Mikkelsen and P. Solgaard, *Contact Dermatitis*, 4 (1978) 106.
318. G.L. Eichhorn, in *Inorganic Biochemistry*, ed. G.L. Eichhorn (Elsevier, Amsterdam, 1975) pp. 1210-1243.
319. T.G. Spiro, *Nucleic Acid-Metal Ion Interactions* (John Wiley & Sons, New York, 1980).
320. S.P.J. Albracht, A. Kröger, J.W. van der Zwaan, G. Unden, R. Böcher, H. Mell and R.D. Fontijn, *Biochim. Biophys. Acta*, 874 (1986) 116.
321. R.K. Andrews, R.L. Blakeley and B. Zerner, *Metal Ions Biol. Systems*, 23 (1988) 165.
322. B. Sarkar, in Ref. 302, pp. 367-384.
323. N.E. Dixon, C. Gazzola, R.L. Blakeley and B. Zerner, *J. Am. Chem. Soc.*, 97 (1975) 4131.
324. J.C. Polacco, *Plant Sci. Lett.*, 10 (1977) 249.
325. N.E. Dixon, C. Gazzola, C.J. Asher, D.S.W. Lee, R.L. Blakeley and B. Zerner, *Can. J. Biochem.*, 58 (1980) 474.
326. M.D. Maines and A. Kappas, in *Clinical Chemistry and Chemical Toxicology of Metals*, ed. S.S. Brown (Elsevier, Amsterdam, 1977) pp. 75-81.
327. D.L. Eaton, N.H. Stacey, K.-L. Wong and C.D. Klaassen, *Toxicol. Appl. Pharmacol.*, 55 (1980) 393.
328. F.W. Sunderman, Jr., M.C. Reid, L.M. Bibeau and J.V. Linden, *Toxicol. Appl. Pharmacol.*, 68 (1983) 87.
329. J.J.G. Moura, I. Moura, M. Teixeira and A.V. Xavier, *Metal Ions Biol. Systems*, 23 (1988) 285.
330. C.M. Doyle and D.J. Arp, *J. Bacteriol.*, 170 (1988) 3891.
331. K. Nag and A. Chakravorty, *Coord. Chem. Rev.*, 33 (1980) 87.
332. R.I. Haines and A. McAuley, *Coord. Chem. Rev.*, 39 (1981) 77.
333. A.A.G. Tomlinson, *Coord. Chem. Rev.*, 37 (1981) 221.
334. R.K. Thauer, G. Diekert and P. Schönheit, *Trends Biochem. Sci.*, 5 (1980) 304.
335. A.J. Thomson, *Nature (London)*, 298 (1982) 602.
336. F.S. LaBella, R. Dular, P. Lemon, S. Vivian and G. Queen, *Nature (London)*, 245 (1973) 330.
337. E. Horak and F.W. Sunderman, Jr., *Toxicol. Appl. Pharmacol.*, 32 (1975) 316.
338. E. Horak and F.W. Sunderman, Jr., *Toxicol. Appl. Pharmacol.*, 33 (1975) 388.
339. R.B. Ciccarelli and K.E. Wetterhahn, *Chem.-Biol. Interact.*, 52 (1985) 347.
340. S.R. Patierno and M. Costa, *Cancer Biochem. Biophys.*, 9 (1987) 113.
341. R.B. Martin, *Metal Ions Biol. Systems*, 23 (1988) 315.
342. K.S. Kasprzak, M.P. Waalkes and L.A. Poirier, *Toxicol. Appl. Pharmacol.*, 82 (1986) 336.

343. E.L. Andronikashvili, V.G. Bregadze and J.R. Monaselidze, *Metal Ions Biol. Systems*, 23 (1988) 331.
344. F.W. Sunderman, Jr., A. Marzouk, S.M. Hopfer, O. Zaharia and M.C. Reid, *Ann. Clin. Lab. Sci.*, 15 (1985) 229.
345. E. Donskoy, M. Donskoy, F. Forouhar, C.G. Gillies, A. Marzouk, M.C. Reid, O. Zaharia and F.W. Sunderman, Jr., *Ann. Clin. Lab. Sci.*, 16 (1986) 108.
346. M. Hasan and S.F. Ali, *Toxicol. Appl. Pharmacol.*, 57 (1981) 8.
347. M.M. Fawade and S.S. Pawar, *Indian J. Exp. Biol.*, 21 (1983) 343.
348. M. Athar, S.K. Hasan and R.C. Srivastava, *Biochem. Biophys. Res. Commun.*, 147 (1987) 1276.
349. D. Adalis, D.E. Gardner and F.J. Miller, *Am. Rev. Respir. Dis.*, 118 (1978) 347.
350. I. Olsen and J. Jonsen, *Acta Pharmacol. Toxicol.*, 44 (1979) 120.
351. J.M. Benson, R.F. Henderson, R.O. McClellan, R.L. Hanson and A.H. Rebar, *Fund. Appl. Toxicol.*, 7 (1986) 340.
352. J.M. Benson, D.G. Burt, R.L. Carpenter, A.F. Eidson, F.F. Hahn, P.J. Haley, R.L. Hanson, C.H. Hobbs, J.A. Pickrell and J.K. Dunnick, *Fund. Appl. Toxicol.*, 10 (1988) 164.
353. J.K. Dunnick, J.M. Benson, C.H. Hobbs, F.F. Hahn, Y.S. Cheng and A.F. Eidson, *Toxicology*, 50 (1988) 145.
354. A. Johansson, T. Curstedt, B. Robertson and P. Camner, *Environ. Res.*, 31 (1983) 399.
355. A. Wiernik, A. Johansson, C. Jarstrand and P. Camner, *Environ. Res.*, 30 (1983) 129.
356. M.D. Waters, D.E. Gardner, C. Aranyi and D.L. Coffin, *Environ. Res.*, 9 (1975) 32.
357. A. Johansson, M. Lundborg, S. Skog, C. Jarstrand and P. Camner, *Br. J. Ind. Med.*, 44 (1987) 47.
358. M. Lundborg, A. Johansson and P. Camner, *Toxicology*, 46 (1987) 191.
359. C.N. Leach, Jr., J.V. Linden, S.M. Hopfer, M.C. Crisostomo and F.W. Sunderman, Jr., *Clin. Chem.*, 31 (1985) 556.
360. G. Rubányi and A.G.B. Kovách, *Acta Physiol. Acad. Sci. Hung.*, 55 (1980) 345.
361. G. Rubányi, L. Ligeti and A. Koller, *J. Mol. Cell. Cardiol.*, 13 (1981) 1023.
362. G. Rubányi, I. Balogh, E. Somogyi, A.G.B. Kovách and P. Sótöny, *J. Mol. Cell. Cardiol.*, 12 (1980) 609.
363. M. Kohlhardt, B. Bauer, H. Krause and A. Fleckenstein, *Pfluegers Arch.*, 338 (1973) 115.
364. G. Brommundt and F. Kavalier, *Am. J. Physiol.*, 253 (Cell Physiol. 22) (1987) C45-C51.
365. F. Kavalier and G. Brommundt, *Am. J. Physiol.* 253 (Cell Physiol. 22) (1987) C52-C59.
366. G. Rubányi and I. Balogh, *Am. J. Obstet. Gynecol.*, 142 (1982) 1016.
367. K. Nordlind, *Int. Arch. Allergy Appl. Immunol.*, 69 (1982) 12.
368. N.G. Al-Tawil, J.A. Marcus and E. Möller, *Acta Dermatoven. (Stockholm)*, 61 (1981) 511.
369. K. Nordlind, *Int. Arch. Allergy Appl. Immunol.*, 73 (1984) 151.
370. M. van Blomberg-van der Flier, C.K.H. van der Burg, O. Pos, E.M. van de Plassche-Boers, D.P. Bruynzeel, G. Garotta and R.J. Scheper, *J. Invest. Dermatol.*, 88 (1987) 362.
371. K. Nordlind and A. Henze, *Int. Arch. Allergy Appl. Immunol.*, 75 (1984) 330.
372. K. Nordlind, *Int. Arch. Allergy Appl. Immunol.*, 75 (1984) 333.
373. F. Sinigaglia, D. Scheidegger, G. Garotta, R. Scheper, M. Pletscher and A. Lanzavecchia, *J. Immunol.*, 135 (1985) 3929.
374. S. Silvennoinen-Kassinen, H. Jakkula and J. Karvonen, *J. Invest. Dermatol.*, 86 (1986) 18.
375. G.L. Warner and D.A. Lawrence, *Eur. J. Immunol.*, 16 (1986) 1337.
376. L.R. Braathen, *Br. J. Dermatol.*, 103 (1980) 517.

377. S. Silvennoinen-Kassinen, *Scand. J. Immunol.*, 12 (1980) 61.
378. P. Res, M.L. Kapsenberg, J.D. Bos and F. Stiekema, *J. Invest. Dermatol.*, 88 (1987) 550.
379. M.L. Kapsenberg, P. Res, J.D. Bos, A. Schootemijer, M.B.M. Teunissen and W.V. Schooten, *Eur. J. Immunol.*, 17 (1987) 861.
380. W.B. Shelley and L. Juhlin, *Arch. Dermatol.*, 113 (1977) 187.
381. M.L. Kapsenberg, T. van der Pouw-Kraan, F.E. Stiekema, A. Schooteneijer and J.D. Bos, *Eur. J. Immunol.*, 18 (1988) 977.
382. C.R. Menon and E. Nieboer, *J. Inorg. Biochem.*, 28 (1986) 217.
383. A.M. Mirza, M.G. Perera, C.A. Maccia, O.G. Dziubynskij and I.L. Bernstein, *Int. Arch. Allergy Appl. Immunol.*, 49 (1975) 782.
384. H. Thulin, *Acta Dermatoven. (Stockholm)*, 56 (1976) 377.
385. K. Nordlind and G. Sandberg, *Int. Arch. Allergy Appl. Immunol.*, 70 (1983) 30.
386. G.L. Warner and D.A. Lawrence, *Int. J. Immunopharmacol.*, 10 (1988) 629.
387. K.L. Smith and D.A. Lawrence, *Toxicol. Appl. Pharmacol.*, 96 (1988) 476.
388. G.L. Warner and D.A. Lawrence, *Cell. Immunol.*, 101 (1986) 425.
389. R.J. Smialowicz, R.R. Rogers, M.M. Riddle and G.A. Stott, *Environ. Res.*, 33 (1984) 413.
390. J.A. Knight, W.N. Rezuke, S.H.-Y. Wong, S.M. Hopfer, O. Zaharia and F.W. Sunderman Jr., *Res. Commun. Chem. Pathol. Pharmacol.*, 55 (1987) 291.
391. R.A. Figoni and L. Treagan, *Res. Commun. Chem. Pathol. Pharmacol.*, 11 (1975) 335.
392. J.A. Graham, D.E. Gardner, F.J. Miller, M.J. Daniels and D.L. Coffin, *Environ. Health Perspect.*, 12 (1975) 109.
393. L. Treagan and A. Furst, *Res. Commun. Chem. Pathol. Pharmacol.*, 1 (1970) 395.
394. R.J. Smialowicz, R.R. Rogers, M.M. Riddle, R.J. Garner, D.G. Rowe and R.W. Luebke, *Environ. Res.*, 36 (1985) 56.
395. R.J. Smialowicz, R.R. Rogers, M.M. Riddle, D.G. Rowe and R.W. Luebke, *Toxicology*, 38 (1986) 293.
396. M.J. Daniels, M.G. Ménache, G.R. Burtleson, J.A. Graham and M.-J.K. Selgrade, *Fund. Appl. Toxicol.*, 8 (1987) 443.
397. R.J. Smialowicz, R.R. Rogers, D.G. Rowe, M.M. Riddle and R.W. Luebke, *Toxicology*, 44 (1987) 271.
398. K. Thestrup-Pedersen, C.G. Larsen and J. Rönnevig, *Contact Dermatitis*, 20 (1989) 81.
399. E. Cronin, in *Contact Dermatitis* (Churchill Livingstone, Edinburgh, 1980) pp. 338–367.
400. A.A. Fisher, in *Contact Dermatitis* (Lea Febiger, Philadelphia, PA) 3rd Edn. (1986) pp. 745–761.
401. O.B. Christensen and H. Möller, *Contact Dermatitis*, 1 (1975) 136.
402. K. Kaaber, N.K. Veien and J.C. Tjell, *Br. J. Dermatol.*, 98 (1978) 197.
403. P.V. Marcussen, *Acta Dermatoven. (Stockholm)*, 43 (1963) 219.
404. K. Kalimo and K. Lammintausta, *Contact Dermatitis*, 10 (1984) 25.
405. L.M. Wall and C.D. Calnan, *Contact Dermatitis*, 6 (1980) 414.
406. J.E. Wahlberg, *Contact Dermatitis*, 6 (1980) 134.
407. P.V. Marcussen, *J. Invest. Dermatol.*, 40 (1963) 263.
408. H. Möller, *Contact Dermatitis*, 20 (1989) 120.
409. G.T. Block and M. Yeung, *J. Am. Med. Assoc.*, 247 (1982) 1600.
410. J.-L. Malo, A. Cartier, M. Doepner, E. Nieboer, S. Evans and J. Dolovich, *J. Allergy Clin. Immunol.*, 69 (1982) 55.
411. J.-L. Malo, A. Cartier, G. Gagnon, S. Evans and J. Dolowich, *Clin. Allergy*, 15 (1985) 95.
412. H.S. Novey, M. Habib and I.D. Wells, *J. Allergy Clin. Immunol.*, 72 (1983) 407.
413. L.H. McConnel, J.N. Fink, D.P. Schlueter and M.G. Schmidt, *Ann. Intern. Med.*, 78 (1973) 888.

414. V. Bencko, V. Wagner, M. Wagnerova and E. Reichrtova, *J. Hyg. Epidemiol. Microbiol. Immunol.*, 27 (1983) 387.
415. J. Dolovich, S.L. Evans and E. Nieboer, *Br. J. Ind. Med.*, 41 (1984) 51.
416. E. Nieboer, S.L. Evans and J. Dolovich, *Br. J. Ind. Med.*, 41 (1984) 56.
417. E. Nieboer, F.E. Rosetto and C.R. Menon, *Metal Ions Biol. Systems*, 23 (1988) 359.
418. N.K. Veien, A.H. Christiansen, E. Svejgaard and K. Kaaber, *Contact Dermatitis*, 5 (1979) 378.
419. R.P. Warin and R.J. Smith, *Contact Dermatitis*, 8 (1982) 117.
420. P.H. Gitlitz, F.W. Sunderman, Jr., P.J. Goldblatt, *Toxicol. Appl. Pharmacol.*, 34 (1975) 430.
421. A. Léonard and P. Jaquet, in Ref. 302, pp. 277-291.
422. T.W. Clarkson, G.F. Nordberg and P.R. Sager, *Scand. J. Work Environ. Health*, 11 (1985) 145.
423. H.A. Schroeder and M. Mitchener, *Arch. Environ. Health*, 23 (1971) 102.
424. A.M. Ambrose, P.S. Larson, J.F. Borzelleca and G.R. Hennigar, Jr., *J. Food Sci. Technol.*, 13 (1976) 181.
425. C.C. Lu, N. Matsumoto and S. Iijima, *Teratology*, 19 (1979) 137.
426. R. Storeng and J. Jonsen, *Toxicology*, 20 (1981) 45.
427. R. Storeng and J. Jonsen, *Toxicology*, 17 (1980) 183.
428. S.H. Gilani and M. Marano, *Arch. Environ. Contam. Toxicol.*, 9 (1980) 17.
429. J.A. DiPaolo and B.C. Casto, *Cancer Res.*, 39 (1979) 1008.
430. M. Costa, J. Simmons-Hansen, C.W.M. Bedrossian, J. Bonura and R.M. Caprioli, *Cancer Res.*, 41 (1981) 2868.
431. B.C. Casto, J. Meyers and J.A. DiPaolo, *Cancer Res.*, 39 (1979) 193.
432. Y. Wu, H. Luo and D.R. Johnson, *Cancer Lett.*, 32 (1986) 171.
433. E. Rivedal and T. Sanner, *Cancer Lett.*, 8 (1980) 203.
434. E. Rivedal and T. Sanner, *Cancer Res.*, 41 (1981) 2950.
435. S.H. Robison and M. Costa, *Cancer Lett.*, 15 (1982) 35.
436. S.R. Patierno, M. Sugiyama, J.P. Basilion and M. Costa, *Cancer Res.*, 45 (1985) 5787.
437. S.H. Robison, O. Cantoni, J.D. Heck and M. Costa, *Cancer Lett.*, 17 (1983) 273.
438. M.A. Sirover and L.A. Loeb, *Science (Washington, DC)* 194 (1976) 1434.
439. L.A. Loeb, M.A. Sirover, L.A. Weymouth, D.K. Dube, G. Seal, S.S. Agarwal and E. Katz, *J. Toxicol. Environ. Health*, 21 (1977) 1297.
440. P. Sen and M. Costa, *Carcinogenesis*, 7 (1986) 1527.
441. H.C. Wulf, *Dan. Med. Bull.*, 27 (1980) 40.
442. H.J.K. Saxholm, A. Reith and A. Brogger, *Cancer Res.*, 41 (1981) 4136.
443. S.M. Newman, R.L. Summitt and L.J. Nunez, *Mutat. Res.*, 101 (1982) 67.
444. P. Sen and M. Costa, *Cancer Res.*, 45 (1985) 2320.
445. P. Sen, K. Conway and M. Costa, *Cancer Res.*, 47 (1987) 2142.
446. M. Nishimura and M. Umeda, *Mutat. Res.*, 68 (1979) 337.
447. J.F. Lechner, T. Tokiwa, I.A. McClendon and A. Haugen, *Carcinogenesis*, 5 (1984) 1697.
448. G.H. Deknudt and A. Léonard, *Toxicology*, 25 (1982) 289.
449. H. Waksvik and M. Boysen, *Mutat. Res.*, 103 (1982) 185.
450. M.H.L. Green, W.J. Muriel and B.A. Bridges, *Mutat. Res.*, 38 (1976) 33.
451. A. Arlauskas, R.S.U. Baker, A.M. Bonin, R.K. Tandon, P.T. Crisp and J. Ellis, *Environ. Res.*, 36 (1985) 379.
452. N.W. Biggart and M. Costa, *Mutat. Res.*, 175 (1986) 209.
453. P. Pikálek and J. Necásek, *Folia Microbiol.*, 28 (1983) 17.

454. J.S. Dubins and J.M. LaVelle, *Mutat. Res.*, 162 (1986) 187.
455. R. Rodriguez-Arnaiz and R. Ramos, *Mutat. Res.*, 170 (1986) 115.
456. D.E. Amacher and S.C. Paillet, *Mutat. Res.*, 78 (1980) 279.
457. M. Miyaki, N. Akamatsu, T. Ono and H. Koyama, *Mutat. Res.*, 68 (1979) 259.
458. O. Andersen, *Res. Commun. Chem. Pathol. Pharmacol.*, 50 (1985) 379.
459. D. Dewally, in Ref. 302, pp. 215–226.
460. J.P.W. Gilman, *Cancer Res.*, 22 (1962) 158.
461. Y. Kurokawa, M. Matsushima, T. Imazawa, N. Takamura, M. Takahashi and Y. Hayashi,

462. E.A. Pedersen, C. Högetveit and A. Andersen, *Int. J. Cancer*, 12 (1973) 32.
463. H. Cuckle, R. Doll and L.G. Morgan, in Ref. 267, pp. 11–14.
464. T. Norseth, *J. Toxicol. Environ. Health*, 6 (1980) 1219.
465. D.C.L. Burges, in Ref. 267, pp. 15–18.

This Page Intentionally Left Blank

6 The Fluoroquinolone Antibacterial Agents

TERRY ROSEN, Ph.D.

*Department of Medicinal Chemistry, Pfizer Central Research, Groton, CT
06340, U.S.A.*

INTRODUCTION	236
GENERAL CONSIDERATIONS	238
Mechanism and mode of action	238
Antibacterial spectra	243
Resistance development	244
Overview of clinical experience and adverse reactions	245
STRUCTURE–ACTIVITY STUDIES	248
Early 6-fluoro-7-piperazinylquinolones: the discoveries of norfloxacin and related compounds	248
Amino-substituted alicyclicamino groups as replacements for the 7-piperazine substituent	254
1-Arylquinolones: difloxacin and related analogues	255
7-(Alkylaminomethylpyrrolidin-1-yl)quinolones: CI934	258
Substitutions at the 1- and 8-positions of the quinolone nucleus: PD 117558	262
Homochiral quinolones	267
Conformationally constrained analogues	277
7-Heteroarylquinolones	280
Substitutions at the 5-position of the quinolone nucleus	283
7-Diazabicycloalkylquinolones with activity against veterinary pathogenic bacteria: danofloxacin	285
Prodrugs with improved oral absorption properties	287
SUMMARY	289
ACKNOWLEDGEMENTS	290
REFERENCES	290

INTRODUCTION

The quinolone carboxylic acids are a class of highly potent and orally active broad-spectrum antibacterial agents. Structurally, members of this class are defined generally as 1-substituted-1,4-dihydropyridine-3-carboxylic acids with a fused ring at the 5- and 6-positions, although very recently, effective replacements for the carboxylic acid moiety have been reported. These agents are often referred to simply as quinolones. The prototypical member of this important group of synthetic antimicrobials, nalidixic acid (1), was reported in 1962 [1]. This agent, which shows moderate activity versus Gram-negative organisms, has been used primarily for the treatment of urinary tract infections. During the period between the discovery of (1) and *ca.* 1980, structure-activity studies led to the development of analogues with moderate improvements in overall properties [2]. The structures of several of these older congeners are shown in *Figure 6.1*. However, early in the 1980's new agents such as norfloxacin (2a)

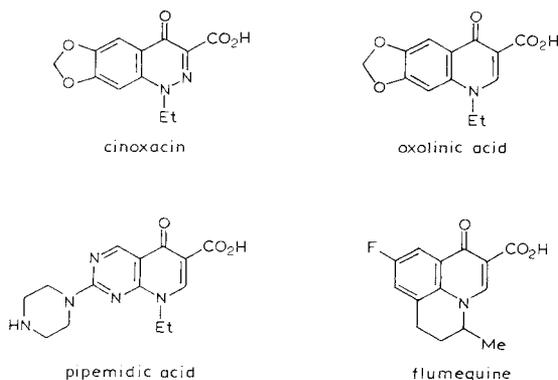
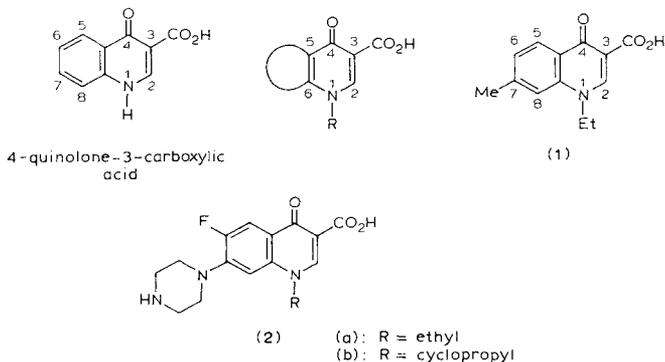

Figure 6.1. Representative structures of early nalidixic analogues.

[3] and ciprofloxacin (2b) [4], possessing both a 6-fluoro substituent and a 7-piperazinyl group on the quinolone pharmacophore (structural features found individually in flumequine and pipemidic acid, respectively) (*Figure 6.1*), were reported to possess greatly improved potency and antibacterial spectra relative to (1). Subsequently, effort in this area became and continues to be amongst the most intense in pharmaceutical research. The agents which have been marketed recently or are undergoing clinical development generally possess a fluoro substituent at the 6-position of the quinolone nucleus and are



often referred to as fluoroquinolones or 6-fluoro-1,4-dihydro-4-oxo-3-quinolincarboxylic acids; this structural feature distinguishes the newer compounds from most of the earlier nalidixic acid analogues.

The therapeutic indications for quinolone antibacterials have expanded greatly from their initial role in treating urinary tract infections (UTI). The fluoroquinolones show excellent activity against Gram-positive organisms as well as Gram-negative species, including *Pseudomonas aeruginosa*, and have been demonstrated to be useful for the oral and parenteral treatment of systemic infections other than UTI. As this class of agents has evolved, compounds have emerged with antibacterial spectra that also include highly potent activity against anaerobes. Some of the newer agents have demonstrated clinical efficacy rates as high as 90% [5d]. Furthermore, clinical studies have shown that this class of agents is generally very well tolerated while exhibiting only few adverse effects.

During the rapid expansion of this field, several excellent reviews have appeared periodically updating progress with respect to medicinal chemical studies [5] and microbiological issues [6] as well as describing biochemical and molecular biological approaches to understanding the mechanism of action of quinolones and their interactions with topoisomerases and DNA [7a-f]. Also, the Computer Automated Structure Evaluation (CASE) program has been used to study a series of quinolone antibacterial agents, generating a series of molecular fragments relevant to DNA gyrase inhibition and *in vitro* activity in whole cells; the significance of these fragments to biological activity has been discussed [7g].

This article will focus primarily on recent medicinal chemical studies aimed at addressing or studying particular issues which include inherent activity (versus the enzymatic target as well as in whole cells), *in vivo* efficacy, pharmacokinetics, physicochemical properties and efforts to elucidate salient features

of these molecules responsible for related pharmacological properties; an effort is made to underscore the primary issues driving current research. It should be noted that many of the molecular modifications described in this review have their fundamental precedent in medicinal chemical research done prior to the discovery of the highly potent fluoroquinolones; these earlier structure–activity studies have been the subject of a thorough and comprehensive review [2]. In order to place these new studies in their appropriate context, brief sections highlighting the current understanding of the mode of action of these agents, their present and potential role as therapeutants and their current limitations are included. Several excellent reviews in these areas have also been published, and these articles are identified in the appropriate sections.

GENERAL CONSIDERATIONS

MECHANISM AND MODE OF ACTION

Although nalidixic acid and its antibacterial properties were reported in 1962, it was not until 1976 that the target of the quinolone antibacterials, DNA gyrase (bacterial topoisomerase II), was first isolated from *Escherichia coli* [8, 9]. The enzyme is a tetramer, containing two A subunits (105 kDa in mass) and two B subunits (95 kDa in mass) [10]. The genes (*gyrA* gene located at 48 min on the *E. coli* map, *gyrB* gene located at 83 min on the *E. coli* map) which encode the respective subunits have been cloned and sequenced [7d]. DNA gyrase catalyzes bacterial DNA supercoiling and appears to be involved in numerous other bacterial reactions and processes including catenation-decatenation, which mediates the separation of interlocked DNA during chromosome segregation, and aspects of transcription and DNA repair [7d, 9]. The enzyme plays an important role in the initiation, elongation and termination phases of DNA replication [7d].

Supercoiling of bacterial DNA is a critical process which allows bacteria to accommodate their very long (*ca.* 1300 μm) chromosomes within the cell (maximum dimensions of $2 \times 1 \mu\text{m}$) [11] and is essential for the replication of circular chromosomes [7f]. The negative supercoiling of bacterial DNA by DNA gyrase influences most metabolic processes involving DNA. The energy for this process is supplied by ATP hydrolysis [12]. The steps involved in the supercoiling process are summarized in *Table 6.1* [9, 13–15]. The B subunits of DNA gyrase are believed to be responsible for the energy transduction process mediating the introduction of negative supercoils into double-stranded DNA. The DNA is nicked by a process involving the A subunits, and a negative

Table 6.1. STEPS IN THE SUPERCOILING MECHANISM OF DNA GYRASE
[9, 13–15]

-
- (a) DNA gyrase binds to DNA substrate, stabilizing a positive DNA node.
 - (b) DNA is cleaved at 4-basepair staggered sites at the node, and covalent linkages are formed between a tyrosine group on gyrase subunit A and the 5'-end of the DNA chain.
 - (c) A remote DNA segment is passed through the cleaved DNA gate, inverting the sign of the node.
 - (d) The DNA break is resealed.
-

supercoiling run is subsequently completed by a DNA resealing action of the A subunits [9, 13–15].

The B subunit of the enzyme is the target of coumermycin and related antibiotics [10, 12, 16]. The A subunit is a primary target of the quinolones [17, 18], and it has been suggested that these agents inhibit the resealing step of the overall supercoiling process (*Table 6.1*, step (d)). A mechanism of action involving the A subunits is clearly involved in the activity of the quinolones. However, the overall manner in which these compounds act on gyrase on a molecular level is still not well understood. Although the majority of quinolone resistance mutations that affect DNA gyrase occur in the *gyrA* gene [7d], mutations encoding nalidixic acid resistance have been identified in the *gyrB* gene [19]. It is not known whether this effect is related to a direct action of drug on this subunit or whether it involves an indirect process through the A subunit. An important effect of quinolones on purified DNA gyrase, which has been utilized as the basis for a biochemical assay, involves their stabilization of double-strand breaks in DNA that are induced by the enzyme at specific sites; these sites are subsequently revealed upon addition of a protein denaturant to the reaction medium, resulting in cleaved DNA products [20–23]. This type of action, which prevents the rejoining of DNA by DNA gyrase, both *in vitro* and *in vivo*, may be a critical mechanism by which the quinolones exert their effect in whole cells.

The quinolones are rapidly bactericidal. Interestingly, this killing effect is significantly diminished by agents such as rifampicin which inhibit protein synthesis, suggesting that the bactericidal effect may be dependent upon the synthesis of one or more proteins [7a]. An excellent discussion of the biochemical studies concerning the killing effects of quinolones has been published [7a]. It has also been suggested that the quinolones may actually form a complex with the enzyme that, in effect, poisons the cell [9, 24]. Recently, it has been shown that quinolones induce the SOS DNA repair system (a DNA repair response noted by cessation of cell division and formation of filamentous

cells) [25], consistent with a possible mechanism involving a quinolone-induced DNA gyrase damage of DNA by induction of a lesion that is not reparable or caused to be nonreparable upon alteration by repair enzymes [7d].

Another interesting general observation is that the concentrations of quinolones necessary to inhibit the enzyme are significantly (sometimes more than 100-fold) greater than the corresponding minimum inhibitory concentrations in whole cells. Although this observation has sometimes been interpreted as indicating that the intracellular target of the quinolones may involve a site other than DNA gyrase, it has been pointed out [7d] that such a suggestion need not necessarily be invoked. Conditions employed to evaluate inhibition of purified enzyme may not reflect the intracellular environment, and the inhibitory event within a cell might involve a subtle perturbation of enzymatic activity.

In general, it has been found that the DNA gyrase isolated from various species of bacterium is susceptible to inhibition by the quinolones, although the magnitude of the effect of a given agent against the enzyme often varies from organism to organism. An example of this phenomenon is found in the comparative activities of several agents against gyrase isolated from *E. coli* and *M. luteus*, the enzyme from the former having greater susceptibility to the action of quinolones [17, 26]. There has been a report that DNA gyrase isolated from *S. aureus* is not inhibited by the quinolones [27], although another study has indicated that gyrase from *S. aureus* is sensitive to the quinolones [28].

A series of papers concerned with the mechanism of inhibition of DNA gyrase by quinolones on a molecular level, leading to the proposal of a cooperative drug-DNA binding model, has appeared [29–32]. Several of the key observations leading to the model follow. Initially, it was shown that norfloxacin does not bind appreciably to DNA gyrase at concentrations near the drug's supercoiling inhibition constant (K_i), although it binds to DNA to various degrees, depending on the structural form of the DNA. Binding of quinolones to relaxed double-stranded DNA is weak and unsaturable; binding to linearized ColE1 DNA, to relaxed circular ColE1 DNA or to the complex formed upon addition of DNA gyrase to relaxed DNA in the absence of ATP gives molar binding ratios of *ca.* 1 drug molecule/DNA molecule at a drug concentration near the K_i . Studies with a synthetic double-stranded polydeoxynucleotide further suggest that the drug does not bind to double-stranded DNA *per se*. Quinolones bind preferentially to single-stranded DNA in a nonspecific and noncooperative manner. However, they bind specifically to a saturable site on supercoiled DNA in a highly cooperative manner (binding of the drug to this site is dependent on a high power of the drug concentration), and it is suggested that this site is a small denatured bubble or an easily denaturable region in the supercoil and that this binding represents the actual binding mode of quinolones

during the inhibition of DNA gyrase. It has also been demonstrated that drug binding may be enhanced by the addition of DNA gyrase to relaxed DNA in the presence of a nonhydrolyzable ATP analogue. This observation, along with other results, suggests that the quinolones bind to a gyrase-induced DNA site, which is locally unwound during the intermediate gate-opening step.

Based on the above observations, as well as other evidence, the proposed model (*Figure 6.2*) has as its essential feature that bound gyrase induces a

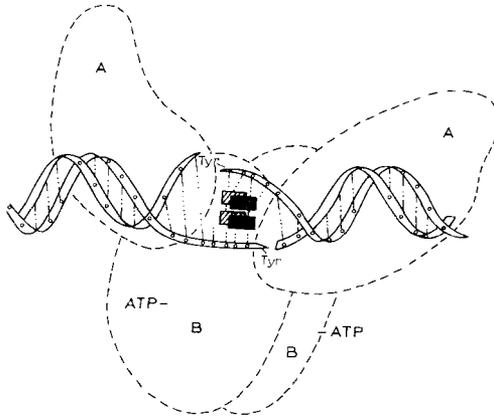

Figure 6.2. Proposed model for quinolone-DNA cooperative binding in the inhibition of DNA gyrase [32]. (Reprinted with permission; American Chemical Society.)

binding site for the drug in the relaxed DNA substrate in the presence of ATP in the following manner: (a) DNA gyrase acts first by cutting both strands at 4-basepair staggered positions, (b) the protruding 4-base single-stranded segments, with subunit A covalently attached to the 5'-end, are moved apart to allow the strand passing process to occur, and (c) this single-stranded DNA gate acts as the drug binding pocket; subsequent binding of drug locks the strands in place, inhibiting the enzyme and preventing its turnover. The details of the proposed drug interactions at the DNA binding pocket are illustrated in *Figure 6.3* (TGTG is arbitrarily chosen as the nucleotide sequence at the binding site). In this model, drug molecules interact through hydrogen bonds between the 4-carbonyl groups of the quinolones and hydrogen bond donor sites of the DNA bases on the separated DNA strands. Drug-drug interactions include the stacking of two adjacent quinolone rings, oriented such that the keto groups point in the same direction, toward the DNA, with the carboxyl groups located on opposite sides in order to avoid charge repulsion. Also present are

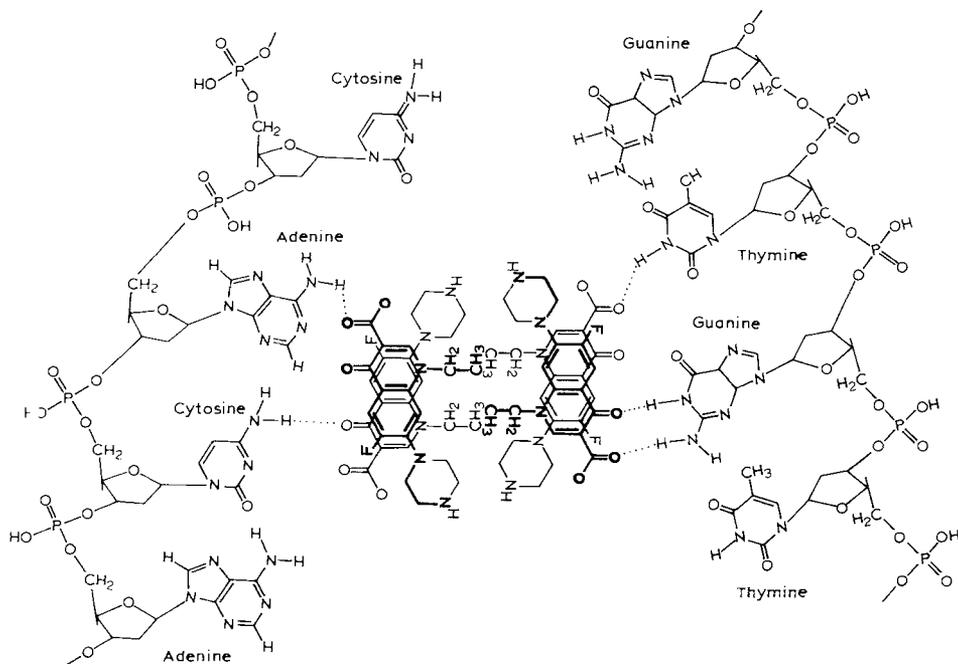
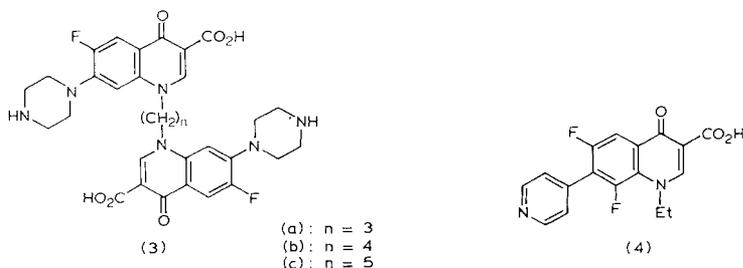

Figure 6.3. Proposed drug self-association mode at the quinolone binding site in a single-stranded DNA pocket [32]. (Reprinted with permission, American Chemical Society.)

tail-to-tail hydrophobic interactions between the drug molecules hydrogen-bonded to the two opposite DNA strands. These types of drug–drug interaction are also present in the nalidixic acid crystal structure [33]. Based on this model, explanations for several structure–activity features and biochemical observations are suggested. Particularly interesting are the supercoiling inhibition results for a series of norfloxacin dimer-like compounds (3) synthesized to test this model [32]; the IC_{50} values for the inhibition of DNA gyrase isolated from *E. coli* for (3a), (3b) and (3c) are *ca.* 30, 1.3, and 20 $\mu\text{g ml}^{-1}$, respectively. Based on the interactions of pairs of nalidixic acid molecules in its crystal structure and computer modeling studies, it was predicted that (3b), in which four methylene groups link the quinolone nuclei, most mimics the norfloxacin dimer which is suggested to be involved in inhibiting the enzyme (Figure 6.3), and indeed (3b) exhibits an IC_{50} value roughly equal to that of norfloxacin. The results of future biochemical and structure–activity relationship (SAR) studies should provide interesting tests as well as refinements for this model.



A final important point relating to the mode of action is the issue of selectivity, which is so critical to the remarkable success of this class of agents. Although human cells also contain type II topoisomerases, the quinolones are 100- to 1000-fold more potent against purified DNA gyrase than mammalian topoisomerase II [34, 35]; furthermore, the eucaryotic enzyme differs from DNA gyrase both structurally and functionally, removing as opposed to inducing supertwists into DNA [7d]. Recently, *in vitro* cleavage assays utilizing topoisomerase II isolated from calf thymus have been described as useful for the preliminary evaluation of quinolones for their ability to stimulate DNA cleavage in mammalian systems [36a]. Compounds such as nalidixic acid, oxolinic acid, norfloxacin and ciprofloxacin are not active in these assays. However, an unusual 7-(pyrid-4-yl) derivative (4) more resembles antitumour agents in potency in these assays; the topoisomerase II-mediated cleavage of DNA by this agent is consistent with its clastogenic effect on DNA in cell culture [36b].

ANTIBACTERIAL SPECTRA

The increased potency and spectrum of the new fluoroquinolones relative to nalidixic acid and its closely related congeners have broadened their use greatly beyond urinary tract infections (UTI) to include both the oral and parenteral treatment of many other types of systemic infection. There have been several excellent reviews on the comparative *in vitro* antimicrobial properties of these agents [6]. As a class, these compounds show excellent activity against enteric bacilli and cocci as well as other Gram-negative species including *P. aeruginosa*, *Haemophilus influenzae* and *Legionella pneumophila*. Ciprofloxacin still remains among the most potent clinically used agents versus Enterobacteriaceae and *Pseudomonas* and a standard to which newer compounds are compared.

The first members of the new fluoroquinolone class (such as norfloxacin (2a), enoxacin (5), pefloxacin (6), ciprofloxacin (2b) and ofloxacin (7)), are generally somewhat less active versus Gram-positive species than Gram-negative

organisms. However, more recent agents have emerged out of the studies described in this review which have greatly improved Gram-positive spectra. In particular, compounds such as PD 117558 (8) [37], AM1091 (9) [38] and tosylloxacin (10) [39], have excellent activity versus Gram-positive organisms, including *Streptococci*. The quinolones also possess excellent *in vitro* activity versus bacterial pathogens of the intestinal tract such as *Campylobacter jejuni*, *Salmonella* spp. and *Shigella* spp.

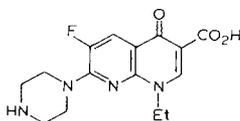

(5)

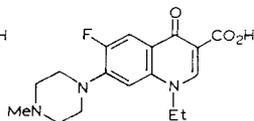

(6)

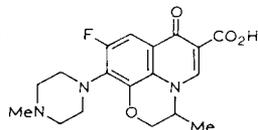

(7)

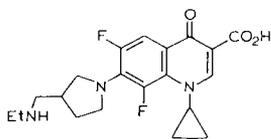

(8)

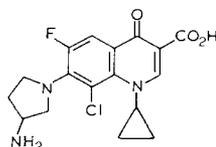

(9)

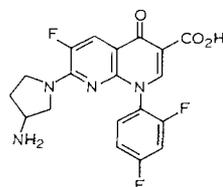

(10)

Recent compounds such as tosylloxacin and AM1091 also exhibit improved effectiveness against anaerobes [38, 39]; the earlier fluoroquinolones have MIC values against these types of organism suggesting only marginally useful activity. *Bacteroides* species other than *B. fragilis* are generally resistant to the quinolones [6c]. The fluoroquinolones also show activity against *Neisseria gonorrhoeae* (including β -lactamase-producing *N. gonorrhoeae*), as well as difficult-to-treat pathogens such as methicillin-resistant *Staphylococcus aureus*. *Chlamydia*, *Mycoplasma* and *Ureaplasma* species generally exhibit reduced susceptibility to the quinolones [6c]. In addition to their excellent *in vitro* spectra and potency, the quinolones are generally rapidly bactericidal.

RESISTANCE DEVELOPMENT

In general, from a clinical standpoint, the development of resistance to the quinolones has not emerged as a major problem. Recent reviews have placed this issue in appropriate perspective [40]. Resistance to the new quinolones, as the result of single-step mutation occurs at a very low frequency ($\leq 10^{-9}$); high-level resistance may be obtained by *in vitro* multiple exposures of organisms

to increasing concentrations of a quinolone. Such resistant organisms usually exhibit cross-resistance to other fluoroquinolones [7d]. Some resistant strains, selected in such a manner, also show decreased susceptibility to other antimicrobial agents, such as the β -lactams, suggesting the resistance is related to permeability factors; rarely has high-level resistance associated with an alteration in the A subunit of DNA gyrase been reported [40a]. There have been several reports of resistance development in a clinical setting; interestingly, cross-resistance does not always occur between the new and the old quinolones [41]. Thus far, the most frequent occurrences of resistance to the quinolones have involved *Serratia marcescens*, *S. aureus* and *P. aeruginosa*, in particular *Pseudomonas* isolates from patients with cystic fibrosis [40a]. Based on the data accumulated thus far, it is suggested that it appears that the major problem of resistance to quinolones will be in patients with cystic fibrosis and in patients with wounds and poor vascular supply, although further careful observations will be necessary to determine the clinical frequency of this problem and the risk to other patients [40a]. Plasmid-mediated resistance to the fluoroquinolones has not been detected. However, there has been a single report of a case of plasmid-mediated resistance to nalidixic acid from Bangladesh involving *Shigella dysenteriae*; the resistance gene was found on a large plasmid, bearing resistance to multiple antibiotics [42].

OVERVIEW OF CLINICAL EXPERIENCE AND ADVERSE REACTIONS

The majority of the clinical data for these agents accumulated thus far, both concerning efficacy as well as adverse effects, have derived from experience with norfloxacin, pefloxacin, enoxacin, ciprofloxacin and ofloxacin [43]. As a class, the quinolones offer the opportunity for the oral treatment of infections that have traditionally required parenteral antibiotics. Ciprofloxacin is the most potent of these agents *in vitro*; however, enoxacin, pefloxacin, and in particular, ofloxacin appear to exhibit superior pharmacokinetic properties. Among the numerous infections against which these compounds have demonstrated efficacy are complicated UTI, bacteremia, deep soft tissue infections and abscesses, ophthalmological infections, gastrointestinal infections and pulmonary infections. These compounds also have shown excellent efficacy, upon single dose treatment, against gonorrhoea, including examples against penicillin-resistant *N. gonorrhoeae* [44], although comparable with the results observed *in vitro*, they tend to exhibit less efficacy for the treatment of *Chlamydia*. Intravenous pefloxacin has been shown to penetrate human bone and is efficacious in the treatment of chronic staphylococcal osteomyelitis [45]. Many of the quinolones exhibit excellent tissue penetration; norfloxacin concentra-

tions have been measured in several tissues as well as body fluids [46]. Long-term ofloxacin treatment has been successful for otherwise resistant cases of tuberculosis [47]. Ciprofloxacin and norfloxacin have also been demonstrated to be effective for the prevention of infection in immunosuppressed patients [48]. Although effective in the treatment of some respiratory tract infections, the quinolones have generally less than optimum activity against streptococci and enterococci, limiting their use in such infections. This area has represented a weakness of the current agents. However, recent studies with temafloxacin (11) have shown that it is effective against *S. pneumoniae* infections, presumably due to a combination of its excellent *in vitro* potency and pharmacokinetic profile [49]. It is also effective versus methicillin-resistant *S. aureus* and *S. epidermidis* [49]. Norfloxacin has been shown to be effective for the prophylaxis of traveller's diarrhoea [50] and appears to be promising for the treatment of shigellosis, typhoid salmonellosis and *Campylobacter* and *Yersina* infections. Several of the quinolones, such as ofloxacin and ciprofloxacin, show good *in vitro* activity versus *Campylobacter pylori*, which has been suggested to be a causative factor in gastritis and duodenal ulcers [51]. Trials in this area with ofloxacin resulted in the isolation of resistant organisms [52]; however, treatment with a combination of ofloxacin and ranitidine affords an enhanced cure rate relative to that observed upon treatment with ranitidine alone [53].

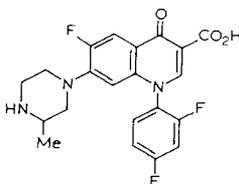

(11)

The data on the adverse reactions of the fluoroquinolones which have received the most extensive clinical evaluation (ciprofloxacin, ofloxacin, pefloxacin, norfloxacin and enoxacin), involving about 30,000 patients, have been the subject of a review [54a]. An important point noted in this review involves the difficulty in detecting an important severe adverse reaction if it is of relatively low frequency, until there has been a very large patient exposure (some examples are provided in which at least 150,000–300,000 exposures would be required to observe the importance of side-effects, resulting in an alert, which have been discovered with specific drugs). However, the majority of side-effects observed thus far with the fluoroquinolones have been minor,

transient and reversible. In the population described above, the overall rates of adverse reaction are 4–8%, with 1–2.6% of patients necessitating discontinuation of therapy. For comparison, it is noted that the overall rate of adverse reactions associated with the third-generation cephalosporin ceftazidime is 6.2% [54b].

In general, the adverse effects associated with these agents have included primarily CNS disturbances (such as dizziness, headache, insomnia) and gastrointestinal effects (such as nausea, vomiting, diarrhoea or abdominal pain). At present, good models do not exist for the prediction of the CNS effects; however, some compounds which are less effective at penetrating into the CNS, such as NY-198 (12) [55, 5c], might be expected to be less predisposed to such occurrences. In this pooled data study [54a], the adverse reaction profile, in terms of affected body system, is generally similar for all of the quinolones. Nausea, vomiting and diarrhoea were the most frequent factors resulting in discontinuation of therapy. Skin reactions occurred in 0.5–2.2% of the patients, and elevation of hepatic enzymes occurred in 1.8–2.5% of the population; these effects were reversible and generally not dose-dependent.

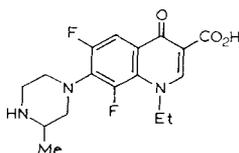

(12)

The quinolones have been found to cause erosion of cartilage in the joints of immature animals [56]. This observation, which has been seen in several studies, has resulted in the contraindication of quinolones for the treatment of children. A study analyzing the risk-benefit situation for the use of pefloxacin in children (clinically, several adverse athralgic effects have been attributed to this agent) has appeared [57]. The underlying mechanism responsible for these effects has yet to be established, and the development of an agent which is safe for paediatric use would be a major advance in quinolone therapy. Some of the quinolones, such as enoxacin, have been shown to interfere with theophylline metabolism [58], and side-effects associated with this agent may be related to this property.

The potential toxicological effects [59] as well as an overview of the adverse experiences [60] for ciprofloxacin have been reported. Since some quinolones

have been shown to cause cataracts in animals, special investigations were carried out; in addition to routine ophthalmologic examinations and based on both animal and human experience, it is concluded that ciprofloxacin should not produce cataracts in humans [59]. In animal studies, it was found that obstructive nephropathy was observed only when analysis of the urinary sediment showed distinct crystalluria [59]. Clinical experience thus far reported suggests that crystalluria related to ciprofloxacin therapy is rare, and only one case of interstitial nephritis has been reported [61]. Indeed, although there has been a significant general concern with the quinolones over the potential development of crystalluria, thus far the problem does not appear to be clinically important [62].

A concern with these compounds, based on their mode of action, has been the potential for genotoxicity. Several quinolones, including ciprofloxacin were found to be active in an *in vitro* hepatocyte primary culture-DNA repair test, suggesting potential genotoxicity [63]. However, it is reported that in a related *in vivo* assay, the results for ciprofloxacin were negative [63]. These investigators suggest caution in categorizing compounds as genotoxic on the basis of results of limited *in vitro* testing. This area remains the focus of much research as well as controversy and requires further study.

In summary, the adverse effects associated with the quinolones appear presently to be mild to moderate in severity and reversible upon discontinuation of therapy. Severe systemic adverse reactions are rare [62]. It is suggested that the use of these agents should be avoided, as far as possible, in children and pregnant women and that caution be used in their administration to patients with a seizure disorder or those taking theophylline or warfarin [62]. Articles suggesting the appropriate clinical usage for these important antibacterials have appeared [64].

STRUCTURE-ACTIVITY STUDIES

EARLY 6-FLUORO-7-PIPERAZINYLQUINOLONES: THE DISCOVERIES OF NORFLOXACIN AND RELATED COMPOUNDS

The synthesis and antibacterial properties of norfloxacin (2a) were described in 1980 [65]. In this key paper in the evolution of quinolone antibacterial agents, a series of 6,7,8-polysubstituted-1-ethyl-1,4-dihydro-4-oxoquinoline-3-carboxylic acids (13) was synthesized, employing previously developed quantitative structure-activity relationships (QSAR) for the corresponding 6-, 7- and 8-monosubstituted derivatives versus *Escherichia coli*. The QSAR analysis

indicated that the antibacterial properties of monosubstituted versions of (13) correlate parabolically with steric parameters for R^1 and R^3 . No correlation relating physicochemical constants for R^2 and the activities of (13) was found. However, it was observed empirically that of the substituents evaluated at this position (acetyl, chloro, dimethylamino, hydrogen, methoxy, methyl, nitro and piperazinyl), the piperazinyl substituent appears to confer the best antibacterial properties. The minimum inhibitory concentrations (MIC) of several 6-substituted-7-piperazinyl analogues (13) versus three strains of bacteria are shown in Table 6.2. The corresponding data for nalidixic acid (1) and pipemidic acid

Table 6.2. ANTIBACTERIAL ACTIVITY OF 7-PIPERAZINYLQUINOLONE DERIVATIVES (13) [65]

Compound No.	Structure			Minimum inhibitory concentrations (MIC, $\mu\text{g ml}^{-1}$)		
	R^1	R^2	R^3	<i>S. aureus</i> 209P	<i>E. coli</i> NIHJ JC-2	<i>P. aeruginosa</i> V-1
(2a)	F	piperazin-1-yl	H	0.39	0.05	0.39
(13a)	Cl	piperazin-1-yl	H	1.56	0.20	3.13
(13b)	Br	piperazin-1-yl	H	3.13	0.39	12.5
(13c)	Me	piperazin-1-yl	H	3.13	0.39	6.25
(13d)	SMe	piperazin-1-yl	H	25	0.78	12.5
(13e)	Ac	piperazin-1-yl	H	100	100	> 100
(13f)	CN	piperazin-1-yl	H	12.5	0.39	6.25
(13g)	NO ₂	piperazin-1-yl	H	25	0.78	12.5
(13h)	H	piperazin-1-yl	H	12.5	0.78	3.13
(1)		nalidixic acid		> 100	3.13	100
-		pipemidic acid		25	1.56	12.5

(Figure 6.1) are shown for comparison. These *in vitro* data illustrate the significant enhancement of antimicrobial potency (3–5 log₂ dilutions) conferred by introduction of the 6-fluoro substituent (2a) relative to the 6-unsubstituted analogue (13h). Even more striking is the remarkable improvement in potency with respect to nalidixic acid (1); these representative data also show the lack of activity of (1) versus Gram-positive pathogens as well as against *P. aeruginosa*. This structure–activity feature is still considered to be an optimum, and all quinolones reportedly undergoing clinical development have a 6-fluoro substituent.

Several other important observations are noted in this study. The decarboxylated analogue (14) and the ester derivative (15a) are devoid of

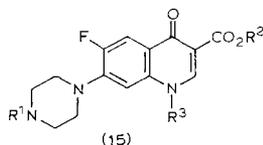
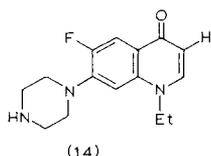
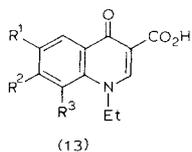

- (a): $R^1 = H, R^2 = R^3 = Et$
 (b): $R^1 = R^2 = H, R^3 = 2-FCH_2CH_2$
 (c): $R^1 = R^2 = H, R^3 = H_2C=CH$
 (d): $R^1 = Me, R^2 = H, R^3 = Et$
 (e): $R^1 = MeCO, R^2 = H, R^3 = Et$

significant antibacterial activity. Substituents at the 1-position that are sterically comparable with an ethyl group, such as in (15b) and (15c), confer antimicrobial potency comparable to that of norfloxacin, while smaller or larger groups at this position decrease activity; as is discussed in later sections, several compounds possessing substituents at the 1-position that are larger than ethyl have been found subsequently to exhibit excellent antibacterial properties. It was also noted that the *N*-methylated and *N*-acetylated piperazine derivatives, (6) and (15d) possess reduced *in vitro* potency against *P. aeruginosa* (particularly (15d)). The decreased *in vitro* activity associated with methylation of the piperazine moiety appears to be a general SAR feature associated with related analogues; however, this modification is also often associated with improved pharmacokinetic properties, as is discussed subsequently. Indeed, pefloxacin (6) [66] is a marketed agent.

A similar study resulted in the preparation and subsequent development of the 1,8-naphthyridine derivative enoxacin (5) [67]; again, the fluoro substituent at the 6-position was found to be optimum. The SAR for the C-7 substituent closely parallels earlier work with pyrido[2,3-*d*]pyrimidine analogues [68]. Biological data for (5) as well as several analogues (16) with various substituents at *N*-1 as well as on the piperazine nitrogen are shown in *Table 6.3*. The unsubstituted piperazine derivatives (5, 16b, 16d) are generally more active *in vitro* than their corresponding *N*-methylated derivatives (16a, 16c and 16e, respectively). However, the *N*-methylated compounds show comparable or superior efficacy relative to their respective *N*-H counterparts in mouse protection tests. This *in vivo* effect is most pronounced for the pair of 1-fluoroethyl analogues (16d) and (16e). The *N*-methylated derivatives also show increased acute toxicity (p.o. LD₅₀ value, mice). The improved *in vivo* efficacies as well as the enhanced relative toxicities of the *N*-methylated compounds probably reflect superior bioavailability and pharmacokinetic properties. Thus,

Table 6.3. BIOLOGICAL PROPERTIES OF NAPHTHYRIDINES (16) [67]

Compound No.	Structure		$ED_{50}, p.o.^a$ (MIC) ^b			LD_{50} value ($mg\ kg^{-1}, p.o.$)
	R ¹	R ²	S. aureus 50774	E. coli P-5101	P. aeruginosa 12	
(5)	H	Et	10 (0.78)	1.8 (0.1)	9.0 (0.78)	> 2000
(16a)	Me	Et	4.8 (1.56)	1.2 (3.13)	10.6 (0.2)	210
(16b)	H	CH ₂ =CH	33.4 (3.13)	1.3 (0.1)	2.4 (0.39)	> 2000
(16c)	Me	CH ₂ =CH	10.5 (3.13)	1.1 (0.1)	3.7 (1.56)	354
(16d)	H	FCH ₂ CH ₂	11.5 (1.56)	3.0 (0.1)	27.2 (0.78)	> 2000
(16e)	Me	FCH ₂ CH ₂	1.4 (0.39)	0.52 (0.1)	4.2 (1.56)	1866

^a mg kg⁻¹.^b μg ml⁻¹.

the very low acute toxicity of enoxacin (5) was a factor in its selection versus (16e) for development.

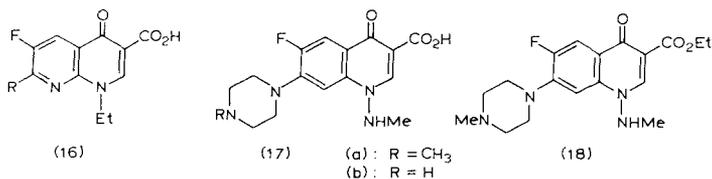

In searching for a replacement for the *N*-1 substituent of earlier agents, workers at Sterling-Winthrop discovered amifloxacin (17a) [69]. In compounds (17a) and (17b) the ethyl groups in pefloxacin and norfloxacin, respectively are replaced by a methylamino moiety. Methylamino and ethyl groups have similar steric bulk, with MR (bulk factors) of 10.33 and 10.30, respectively [70]. The comparative biological properties of (17a) and (17b) with pefloxacin and norfloxacin are shown in *Table 6.4*. These data indicate that (17a) and (17b) exhibit very similar antibacterial properties to pefloxacin and norfloxacin, respectively, both in *in vitro* potency as well as in mouse protection tests (*Escherichia coli* Vogel). Amifloxacin exhibits a superior overall profile relative to its unsubstituted piperazine analogue (17b). Several substituted amino groups were examined as replacements for the 1-methylamino substituent. However, both smaller and larger groups resulted in decreased antimicrobial potency. These results, correlating steric bulk and antibacterial activity, are also consistent with earlier SAR studies in which alkoxy groups

Table 6.4. ANTIBACTERIAL PROPERTIES OF 1-METHYLAMINOQUINOLONES (17) [69]

Compound	No.	MIC ($\mu\text{g ml}^{-1}$)				ED ₅₀ (mg kg ⁻¹) E. coli Vogel	
		E. coli Vogel	K. pneumoniae 39645	P. aeruginosa MGH-2	S. aureus Smith	s.c.	p.o.
Amifloxacin	(17a)	0.25	0.25	1.0	1.0	0.6	1.0
Pefloxacin	(6)	0.25	0.5	1.0	1.0	0.5	1.1
	(17b)	1.0	1.0	1.0	1.95	0.3	6.4
Norfloxacin	(2a)	0.5	0.5	1.0	1.95	0.3	5.9

were investigated as 1-position substituents on the quinolone nucleus [71]. It was also found that the ethyl ester of amifloxacin (compound (18)), although relatively inactive against *E. coli* Vogel *in vitro* (MIC = 62.5 $\mu\text{g ml}^{-1}$), is quite active in mouse protection tests versus the same organism (ED₅₀ value = 4.4 mg kg⁻¹ s.c.). Presumably, (18) is a prodrug of (17a).

The discoveries of ciprofloxacin (2b) [4] and a conformationally constrained 1,8-disubstituted quinolone analogue ofloxacin (7) [72] demonstrated that a group sterically similar to ethyl is neither required nor necessarily optimum for antibacterial potency; indeed, the 1-position cyclopropyl group generally confers the greatest *in vitro* antibacterial activity for a given series of compounds. Ciprofloxacin is presently the standard agent to which newer compounds are compared. Its properties, and perhaps more its limitations, provide much of the impetus upon which newer discovery programmes are based; these features will be discussed subsequently in the context of more recent agents in less advanced stages of development. Ciprofloxacin, as is norfloxacin, is currently marketed in the U.S. and in other countries; several of the other compounds in these studies are marketed in Japan and Europe or are in the later phases of clinical development.

In 1986, both *in vitro* antibacterial activities in whole cells and DNA gyrase inhibition data were published for several important standard agents (side-by-side comparisons) as well as for a series of novel compounds [22]. The results for several of these agents are summarized in Table 6.5. Two separate assays were employed to determine the potency of these compounds against DNA gyrase isolated from *Escherichia coli* H560. The first assay monitors the DNA gyrase-catalyzed conversion of relaxed plasmid DNA to its native supercoiled form, and the value obtained is an *I*₅₀ for the inhibition of supercoiling. The second assay is specific for the quinolone class (versus the coumermycin type) of gyrase inhibitor and monitors the appearance of linear DNA formed from

Table 6.5. *IN VITRO* BIOLOGICAL PROPERTIES OF SEVERAL QUINOLONE ANTIBACTERIAL AGENTS [22]

Compound	I_{50} ($\mu\text{g ml}^{-1}$)	Gyrase cleavage ($\mu\text{g ml}^{-1}$) ^a	MIC ($\mu\text{g ml}^{-1}$)			
			<i>E. coli</i> H560	<i>P. aeruginosa</i> UI-18	<i>S. aureus</i> H228	<i>S. pneumoniae</i> SV-1
Oxolinic acid	25	10	0.2	6.3	1.6	100
Nalidixic acid	> 100	50	6.3	> 100	> 100	> 100
Pipemidic acid	> 100	50	3.1	6.3	50	> 100
Norfloxacin	5.5	1	0.1	0.2	0.8	1.6
Pefloxacin	5.5	1	0.1	0.4	0.2	0.8
Enoxacin	28	5	0.1	0.8	3.1	3.1
Amifloxacin	6.3	2.5	0.025	0.8	1.6	12.5
Ofloxacin	6.3	5	0.1	0.4	0.4	0.8
Ciprofloxacin	5.3	0.5	0.025	0.4	3.1	1.6
AM-833	3.8	2.5	0.1	1.6	0.8	6.3
Defluoronorfloxacin	—	18	6.3	25	> 50	50
6-Fluoronalidixic acid	—	25	3.1	50	25	> 100

^a Minimum concentration at which cleaved DNA (linear) is observed at an intensity relative to oxolinic acid at $10 \mu\text{g ml}^{-1}$.

denaturing the drug-gyrase-DNA complex; in this cleavage assay, the value reflects the amount of drug-gyrase-DNA complex present at equilibrium. For the compounds evaluated in this publication, there are correlations between the MIC values for *E. coli* H560 and the I_{50} and cleavage values. There is a high correlation between the I_{50} values and the gyrase cleavage values. However, the authors note that exceptions, such as enoxacin (cleavage value, $5 \mu\text{g ml}^{-1}$; I_{50} , $27.5 \mu\text{g ml}^{-1}$), exist; ofloxacin has the same cleavage value but an I_{50} ($6.3 \mu\text{g ml}^{-1}$) consistent with the values for other quinolones with low cleavage values. It is suggested, since the I_{50} value is determined by the concentrations of drug that give initial inhibition and complete inhibition, that occasionally a drug, such as enoxacin, while exhibiting a low concentration for initial inhibition (and thereby for the cleavage assay as well), is not as effective in inhibiting completely the super-coiling process, thereby raising the 100% inhibition concentration and thus the I_{50} value. Further possible explanations are discussed concerning this point. However, the key point is that there are generally excellent qualitative correlations between the enzyme assays and the *E. coli* H560 MIC values.

The lack of direct proportionality between the MIC values and the gyrase inhibition values is suggested reasonably to be related to varying relative cell-penetrating properties of the different agents. Thus, enoxacin would appear

to have superior cell permeability abilities relative to norfloxacin, based on its lower efficiency in the enzyme assays but comparable MIC values. By comparing the whole cell activities to the corresponding enzyme inhibiting properties for several 6-fluoroquinolone and defluoro analogue pairs, it is concluded that the 6-fluoro substituent, so important to the potency of the modern agents, appears to improve both gyrase complex binding and cell penetration, with each factor weighted depending on the nature of the C-7 substituent. In the context of these results, it is also important to note that there have been reports which have also shown differing susceptibilities of purified DNA gyrase from various species of bacteria to given quinolone agents [17, 26].

AMINO-SUBSTITUTED ALICYCLICAMINO GROUPS AS REPLACEMENTS FOR THE 7-PIPERAZINE SUBSTITUENT

In 1984, the results of a study investigating amino-substituted alicyclic amino groups as replacements for the 7-piperazinyl group, common to many of the most potent quinolones, was reported [73]. This comprehensive study systematically examined variations at the 7-position of the 1,8-naphthyridine nucleus. The *in vitro* antibacterial activities for several of these enoxacin analogues (19) are summarized in Table 6.6. The most noteworthy feature of these data is that replacement of the piperazin-1-yl group with a 3-aminopyrrolidin-1-yl moiety (compound (19b)) results in an enhancement in potency

Table 6.6. *IN VITRO* ACTIVITY OF 7-(AMINO-SUBSTITUTED ALICYCLICAMINO)NAPHTHYRIDINE DERIVATIVES [73]

Compound (19)	R	MIC ($\mu\text{g ml}^{-1}$)		
		<i>S. aureus</i> 209P JC-1	<i>E. coli</i> NIHJ JC-2	<i>P. aeruginosa</i> <i>Tsuchijima</i>
(a)	3-aminoazetidin-1-yl	0.78	0.2	0.78
(b)	3-aminopyrrolidin-1-yl	0.2	0.1	0.39
(c)	3-aminopiperidin-1-yl	0.78	0.78	6.25
(d)	4-aminopiperidin-1-yl	0.2	0.2	1.56
(e)	4-aminomethylpiperidin-1-yl	0.39	1.56	12.5
(f)	3-methylaminopyrrolidin-1-yl	0.39	0.2	1.56
(g)	3-hydroxyazetidin-1-yl	0.78	0.78	3.13
(h)	3-hydroxypyrrolidin-1-yl	0.39	0.78	0.78
(i)	3-hydroxypiperidin-1-yl	1.56	3.13	25
Enoxacin		0.78	0.2	0.78

against all of the bacteria investigated. The 3-amino and 4-aminopiperidin-1-yl analogues (19c) and (19d) also show improved activity versus *S. aureus*, but diminished potency against *P. aeruginosa*; the aminoazetidine analogue (19a) shows activity identical with that obtained with the parent piperazine analogue enoxacin. Replacement of the amino group in these analogues with a hydroxyl substituent ((19g)–(19i)) results in a significant loss of Gram-negative activity. The aminomethyl replacement for amino in the piperidine series also has a deleterious effect on *in vitro* potency. Similarly, introduction of an alkyl substituent on the amino group in the pyrrolidine series results in decreased potency. In mouse protection tests, the aminopyrrolidine analogue (19b), exhibits improved efficacy relative to enoxacin, particularly against *S. aureus* and *P. aeruginosa* infections. This series of 7-substituents was also investigated in systems with 1-substituents other ethyl. The 1-vinyl analogue of (19b), compound (20), shows excellent antibacterial properties; it is somewhat more potent than (19b) *in vitro*, as well as significantly (approximately 2-fold) more efficacious in mouse protection models.

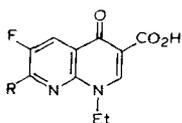

(19)

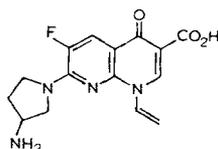

(20)

1-ARYLQUINOLONES: DIFLOXACIN AND RELATED ANALOGUES

In 1985, the discovery of potent antibacterial agents possessing a substituted phenyl group at the 1-position of the quinolone nucleus was reported, and it became clear that electronic and spatial properties as well as steric bulk are important in considering the SAR for this position [74]. The *in vitro* antibacterial properties for several of these compounds against representative bacteria are summarized in *Table 6.7*. A large number of substituted phenyl analogues (21) were synthesized. It was found that the unsubstituted phenyl derivative (21a) exhibits activity comparable with norfloxacin while the *p*-fluorophenyl analogue (21b) (A-56620) is somewhat more active, particularly versus Gram-positive organisms. *p*-Hydroxy (compound (21d)) and *o*, *p*-difluoro (compound (21e)) were also found to be effective substituents for conferring potent antibacterial activity in this system. The other substituents investigated show generally a deleterious effect on potency or spectrum of activity relative to the unsubstituted congener (21a). Compounds (21b)

Table 6.7. *IN VITRO* ANTIBACTERIAL ACTIVITY OF 7-PIPERAZINYL-1-(SUBSTITUTED-PHENYL)QUINOLONES (21) [74]

Compound No.	Structure		<i>(MIC) (μg ml⁻¹)</i>			
	<i>R</i> ¹	<i>R</i> ²	<i>S. aureus</i> <i>ATCC 6538P</i>	<i>S. pyogenes</i> <i>930</i>	<i>E. coli</i> <i>Juhl</i>	<i>P. aeruginosa</i> <i>5007</i>
	(21a)	H	H	0.39	1.56	0.2
(21b)	2-F	H	0.2	0.78	0.05	0.39
(21c)	2-F	Me	0.2	1.56	0.2	1.56
(21d)	4-HO	Me	0.05	0.2	0.1	0.39
(21e)	2,4-diF	Me	0.1	0.78	0.2	1.56
(2a)	norfloxacin		0.78	3.1	0.1	0.39

(A-56620) and (21c) (difloxacin) were compared with the corresponding 1-ethyl derivatives, norfloxacin and pefloxacin in mouse protection tests versus *E. coli* Juhl (Table 6.8). The two 7-(4-methylpiperazin-1-yl)quinolone derivatives, difloxacin and pefloxacin show enhanced oral activity relative to the 7-(piperazin-1-yl)quinolones, A-56620 and norfloxacin, respectively; the absolute improvement in ED₅₀ values in the 1-phenyl series is less dramatic. However, it should be noted that difloxacin, the more active agent *in vivo*, is 2 log₂ dilutions less active *in vitro*.

Table 6.8. COMPARISON OF 1-(*p*-FLUOROPHENYL)- AND 1-(ETHYL)-QUINOLONES IN *E. COLI* MOUSE PROTECTION TESTS [74]

Compound No.	<i>E. coli</i> Juhl <i>MIC (μg ml⁻¹)</i>	<i>(ED₅₀) (mg kg⁻¹)</i>	
		<i>s.c.</i>	<i>p.o.</i>
A-56620 (21b)	0.05	0.6	4.3
Norfloxacin (2a)	0.1	0.6	15.1
Difloxacin (21c)	0.2	1.6	3.1
Pefloxacin (6)	0.1	0.5	3.2

Several replacements for the 7-piperazin-1-yl substituent were also examined in this 1-fluorophenyl series of compounds. The morpholine, thiomorpholine and piperidine analogues (22)–(24) also show good antibacterial activity; in general, replacing the basic nitrogen of the piperazine moiety with a non-basic group results in improved activity against Gram-positive bacteria and slightly decreased potency versus Gram-negative species. The aminopyrrolidine

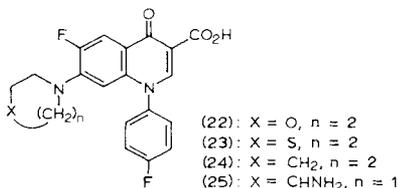
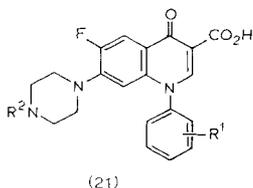

analogue (25), exhibits the most potent *in vitro* antibacterial properties of the agents reported in this study.

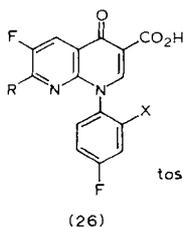

tosufloxacin: X = F, R = 3-aminopyrrolidin-1-yl

Since enoxacin, the naphthyridine analogue of norfloxacin, was found to have increased relative efficacy upon oral administration in systemic mouse protection tests, several 1-arylnaphthyridines related to (21) of the general form (26) were synthesized and evaluated biologically [75]. Two series of compounds (26) were synthesized, one in which X = hydrogen and the other in which X = fluoro. In both series of compounds, the *in vitro* activity against Gram-negative organisms increases in the order of R = 3-hydroxypyrrolidinyl < 4-methylpiperazinyl ≤ 3-methylpiperazinyl < piperazinyl < 3-aminopyrrolidinyl. With respect to Gram-positive organisms, activity increases in the order of R = piperazinyl < 3-methylpiperazinyl ≤ 4-methylpiperazinyl < 3-hydroxypyrrolidinyl ≤ 3-aminopyrrolidinyl. The *in vitro* antimicrobial properties of these naphthyridine agents are comparable with those of the corresponding quinolone analogues. The antibacterial properties of several of the more interesting naphthyridine agents as well as the corresponding data for ciprofloxacin are shown in Table 6.9. Comparative data are also shown for the quinolone analogue of the naphthyridine (17a), A-56620. The naphthyridine derivative exhibits somewhat enhanced oral activity relative to A-56620 in mouse protection tests for *E. coli* and *P. aeruginosa* and only slightly less oral activity in a similar model for *S. aureus*, even though it is one log₂ dilution less active against this organism *in vitro*. Thus, the qualitative trend observed is consistent with the earlier observation that enoxacin shows increased oral activity against systemic infections in mice when compared with its quinolone

Table 6.9. ANTIBACTERIAL PROPERTIES OF 1-ARYLNAPHTHYRIDINE DERIVATIVES (26) [75]

Compound No.	Structure		Organism	MIC ($\mu\text{g ml}^{-1}$)	ED ₅₀ (mg kg ⁻¹)	
	R	X			s.c.	p.o.
(26a)	PIP ^a	H	<i>S. aureus</i> NCTC 10649	0.25	1.6	7.5
(26b)	AMPYR ^b	H		0.06	0.5	1.6
(26c)	PIP	F		0.12	0.6	2.4
(26d)	AMPYR	F		0.03	0.2	1.4
(21b)	A-56620		<i>E. coli</i> Juhl	0.12	1.6	6.5
(2b)	ciprofloxacin			0.25	1.6	15.5
(26a)	PIP	H		0.05	1.0	2.8
(26d)	AMPYR	F	<i>P. aeruginosa</i> 5007	0.02	0.2	1.3
(21b)	A-56620			0.05	0.6	4.3
(2b)	ciprofloxacin			0.02	0.2	1.9
(26a)	PIP	H		0.39	6.9	19.9
(26b)	AMPYR	H		0.1	7.4	18.2
(26c)	PIP	F		0.39	4.6	7.0
(26d)	AMPYR	F		0.2	3.6	4.9
	A-56620			0.39	1.6	21.4
(2b)	ciprofloxacin			0.1	2.1	13.3

^a Piperazin-1-yl.

^b 3-Aminopyrrolidin-1-yl.

counterpart norfloxacin. Of primary importance in this work was the discovery of tosufloxacin (26d) which possesses a 3-aminopyrrolidin-1-yl substituent and an *o*, *p*-difluorophenyl group at the 7- and 1-positions of the naphthyridine moiety, respectively. This compound exhibits broad spectrum and highly potent antibacterial activity. In mouse protection tests, it exhibits superior oral activity versus *S. aureus* relative to ciprofloxacin (ciprofloxacin is generally less active against Gram-positive than Gram-negative organisms, and several recent studies have targeted this area for improvement). Furthermore, tosufloxacin shows improved oral activity against *P. aeruginosa* when compared with ciprofloxacin, and this agent is presently in advanced stages of clinical development.

7-(ALKYLAMINOMETHYLPYRROLIDIN-1-YL)QUINOLONES: CI934

As discussed above, many of the initial fluoroquinolones, although exhibiting exceptional Gram-negative activity, still possess weaknesses in their Gram-positive antibacterial spectra. Noting that the piperazine group, although bene-

ficial, is not essential for obtaining low MIC values or inhibitory activity against DNA gyrase and further that it confers proportionally good *in vivo* activity to those compounds to which it is appended, a study was undertaken to improve the spectrum of antibacterial activity without losing the benefits associated with this substituent [76]. Molecular modelling and computer graphics studies suggested that the amino group in a 3-aminomethylpyrrolidin-1-yl group might mimic the 4-piperazin-1-yl nitrogen in known active drugs (Figure 6.4).



Figure 6.4. 3-Alkylaminomethylpyrrolidine as a potential piperazine replacement.

Furthermore, the added degrees of freedom associated with the aminomethyl group offered the potential of conferring unique properties to such an agent. Several 7-(aminomethylpyrrolidin-1-yl)quinolones of the general structure (27) were synthesized and evaluated in *in vitro* assays (Table 6.10) as well as in mouse protection tests (Table 6.11). Compounds (27a–c), in which the substituent attached to the aminomethyl group is varied, all show excellent activity against Gram-positive organisms *in vitro*, with MIC values less than those of ciprofloxacin. However, these compounds show only marginal activity in mouse protection tests (Table 6.11). Introduction of an 8-fluoro substituent, however, affords compounds (27d–f), which exhibit similar *in vitro* antibacterial properties to their respective 8-defluoro analogues but possess greatly enhanced *in vivo* efficacy. In particular, compound (27f) (CI934) exhibits excellent Gram-positive activity, both *in vitro* and *in vivo*, p.o. Most notable is the oral efficacy of CI934 against *Streptococcus pneumoniae*; streptococci are often relatively resistant to even the most potent quinolone agents. The enhanced oral activity of CI934 relative to its 8-defluoro analogue is consistent with the earlier report of a similar enhancement of activity associated with the 8-fluoro substituent in AM833 (28) [77].

Interestingly, this modification is not necessarily general insofar as improving *in vivo* properties relative to an 8-unsubstituted analogue. A series of 6,8-difluoro-1-arylquinolones (29) was reported in 1987 [78]. Six new compounds, consisting of the monofluorophenyl (X = H) and difluorophenyl (X = F) derivatives of (29) in which R is 3-aminopyrrolidin-1-yl, piperazin-1-yl and 4-methylpiperazin-1-yl, respectively, were evaluated. The 6,8-difluoroarylquinolones are generally one log₂ dilution less active than the corresponding 6-fluoroarylquinolones prepared earlier [74]. However, when the 7-substituent is 3-aminopyrrolidin-1-yl, the 8-fluoro substituent has a surprisingly deleterious

Table 6.10. *IN VITRO* ACTIVITY OF 7-(3-AMINOMETHYLPYRROLIDIN-1-YL)QUINOLONES (27) [76]

Compound No.	Structure		MIC ($\mu\text{g ml}^{-1}$)						Gyrase drug-induced cleavage ($\mu\text{g ml}^{-1}$) ^a
	X	R	E. coli Vogel	E. coli H560	P. aeruginosa UI-18	S. aureus UC-76	S. pneumoniae SV-1	S. pyogenes C203	
(27a)	H	H	0.8	0.4	1.6	0.05	0.2	0.2	3.0
(27b)	H	Me	0.2	0.2	1.6	0.013	0.2	0.1	—
(27c)	H	Et	0.1	0.1	1.6	0.05	0.2	0.1	2.5
(27d)	F	H	0.1	0.1	0.8	0.1	0.2	0.1	0.5
(27e)	F	Me	0.4	0.2	1.6	0.1	0.1	0.1	0.5
(27f)	F	Et	0.1	0.1	1.6	0.05	0.1	0.1	2.5
(2b)	ciprofloxacin		0.05	0.025	0.4	0.2	1.6	0.8	0.5

^a Minimum concentration of drug needed to produce linear DNA at an intensity relative to oxolinic acid at $10 \mu\text{g ml}^{-1}$.

Table 6.11. *IN VIVO* ACTIVITY OF 7-(3-AMINOMETHYLPYRROLIDIN-1-YL)QUINOLONES (27) [76]

Compound No.	ED_{50} (mg kg ⁻¹)					
	E. coli <i>Vogel</i>		S. aureus <i>UC-76</i>		S. pneumoniae <i>SV-1</i>	
	<i>s.c.</i>	<i>p.o.</i>	<i>s.c.</i>	<i>p.o.</i>	<i>s.c.</i>	<i>p.o.</i>
(27a)	25	> 100	6	> 50	—	—
(27b)	18	> 100	8	> 50	> 25	> 100
(27c)	15	> 100	3.0	35	—	—
(27d)	1.2	90	—	—	5	100
(27e)	1.9	6.9	—	—	11	37
(27f)	1.7	12	1.6	2.8	4.4	20
Ciprofloxacin	0.25	1.2	3.0	9.5	18	> 100 ^a

^a Norfloxacin, pefloxacin, enoxacin and amifloxacin also have ED_{50} values of > 100 mg kg⁻¹ in this model.

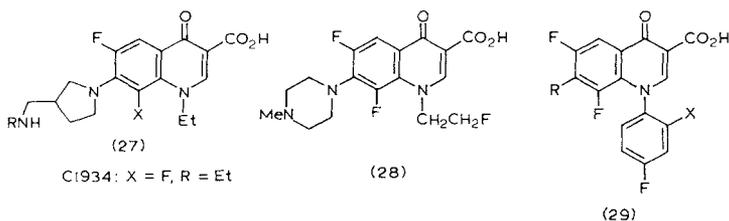

effect on *in vitro* potency, resulting in a 2–4 log₂ reduction in activity. A comparison between the *in vivo* properties of (29a) (X = H, R = piperazin-1-yl) and its 8-defluoro analogue A-56620 (Table 6.12) indicates that the two agents

Table 6.12. COMPARATIVE PROPERTIES OF (29a) AND A-56620 [78]

Compound No.	Organism	MIC (μg ml ⁻¹)	ED_{50} (mg kg ⁻¹)	
			<i>s.c.</i>	<i>p.o.</i>
(29a)	<i>S. aureus</i> NCTC 10649	—	1.6	12.5
A-56620		0.12	1.6	6.5
(29a)	<i>E. coli</i> Juhl	0.1	1.0	3.2
A-56620		0.05	0.6	4.3
(29a)	<i>P. aeruginosa</i> 5007	0.78	6.3	25.0
A-56620		0.39	1.6	21.4

show comparable oral activity in mouse protection tests, with neither agent exhibiting a clear advantage. Thus, the results of this study suggest that for 1-arylquinolones, the 8-fluoro substituent is not beneficial and in some cases is detrimental to antibacterial activity.

SUBSTITUTIONS AT THE 1- AND 8-POSITIONS OF THE QUINOLONE NUCLEUS:
PD 117558

A related study systematically evaluated a large series of 1-cyclopropyl and benzoxazine analogues of general structures (30) and (31), respectively [79]. The substituents evaluated at the 7-position (10-position of the pyridobenzoxazine nucleus) included piperazin-1-yl, 3-aminopyrrolidin-1-yl, 3-aminomethylpyrrolidin-1-yl and 3-alkylaminomethylpyrrolidin-1-yl. Variations at the 8-position of the quinolone nucleus included fluoro, chloro, hydrogen, nitro and amino groups. Naphthyridine analogues (30, X = N) were also investigated. Based on the results of both *in vitro* and *in vivo* evaluations, several general SAR features are suggested. By examination of the geometric means of the MIC values against Gram-negative and Gram-positive organisms, the *in vitro* activity associated with an 8-unsubstituted quinolone (30, X = CH) is comparable with

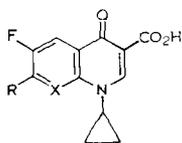

(30)

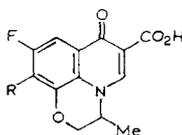

(31)

that of the corresponding naphthyridine. However, the *in vivo* potencies of the naphthyridines are generally superior, possibly due to the achievement of better blood levels. The relative *in vitro* activities of the 7-substituent amine side-chains against Gram-negative organisms are summarized in *Figure 6.5*. For Gram-positive organisms, the order of effectiveness is slightly different: (a) and (c) > (b), (d), (f) ≧ (g).

Incorporation of a fluoro substituent at C-8 (30, X = CF) results in a 2–13-fold increase in *in vitro* potency against Gram-positive organisms relative to 8-unsubstituted derivatives; Gram-negative activity is retained or improved. The increase in *in vitro* potency correlates well with *in vivo* efficacy. Incorporation of an 8-chloro substituent results in similar improvements in *in vitro* activity. However, in general the 8-chloro derivatives are not as effective as their 8-fluoro counterparts, although they are more active than the 8-unsubstituted analogues.

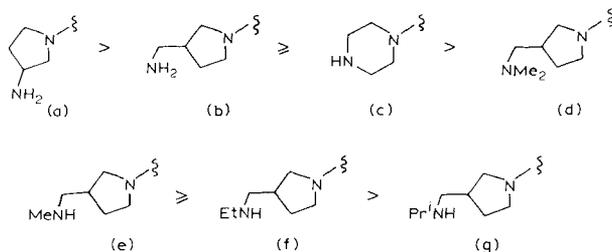

Figure 6.5. Relative effectiveness of 7-substituents for 8-unsubstituted quinolones and 1,8-naphthyridines against Gram-negative organisms, *in vitro*.

No general trends were observed relative to the naphthyridine series; the relative activities are dependent on the particular side-chain as well as organism.

Introduction of an 8-amino substituent results in a deleterious effect on both *in vitro* and *in vivo* activity regardless of the 7-substituent examined. Several compounds with an electron-withdrawing 8-nitro substituent were found to exhibit *in vitro* activity comparable with the corresponding 8-amino derivatives; the 8-nitro series is 10–20-fold less active than the 8-chloro and 8-fluoro series.

The benzoxazine tricyclic compounds, related to ofloxacin, are as a series 3–20-fold less active than the 8-unsubstituted analogues against Gram-negative organisms and exhibit comparable activity against Gram-positive organisms. For those compounds evaluated, these tricyclic derivatives (31) are generally less active in mouse protection tests than the corresponding analogues (30) ($X = \text{CH}$ or $X = \text{N}$). It is suggested that based on both the *in vitro* and *in vivo* data, compound (30) ($X = \text{CF}$, $R = 3\text{-aminopyrrolidin-1-yl}$) exhibits the best overall antibacterial properties of compounds in this study.

Very recently, in the context of a QSAR study for the 1-position of the quinolone nucleus, the 1-cyclopropyl analogue of CI934, compound (8) (PD 117558) was reported to have significantly improved overall properties relative to CI934 [80]. This compound has excellent broad spectrum activity, both *in vitro* and *in vivo*. The replacement of the ethyl group in CI934 with a cyclopropyl substituent confers a 2–10-fold improvement in *in vitro* activity against Gram-negative organisms and a 2–4-fold improvement versus Gram-positive species. The improved *in vitro* potency translates well into enhanced *in vivo* efficacy. Comparative mouse protection data for (8), CI934, difloxacin and ciprofloxacin are shown in *Table 6.13*. Compound (8) shows the best oral activity against streptococci, while CI934 and difloxacin are several-fold less active. Ciprofloxacin exhibits ED_{50} values of greater than $100 \text{ mg kg}^{-1} \text{ p.o.}$ for both species of streptococci examined. On the other hand, difloxacin and

Table 6.13. MOUSE PROTECTION DATA FOR PD 117558 AND SELECTED STANDARD AGENTS [80]

Compound	ED_{50} ($mg\ kg^{-1}$)							
	E. coli		P. aeruginosa		S. pyogenes		S. pneumoniae	
	s.c.	p.o.	s.c.	p.o.	s.c.	p.o.	s.c.	p.o.
PD 117558	1	4	13	40	0.5	2	2	3
CI934	2	12	76	>200	3	9	4	20
Ciprofloxacin	0.3	1	5	25	20	>100	29	>100
Difloxacin	2	2	14	14	7	7	13	16

ciprofloxacin show the best oral activity against the Gram-negative pathogens. The data in Table 6.13 also illustrate the outstanding oral absorption properties of difloxacin; the subcutaneous and oral ED_{50} values for the agent are virtually identical for all of the pathogens examined.

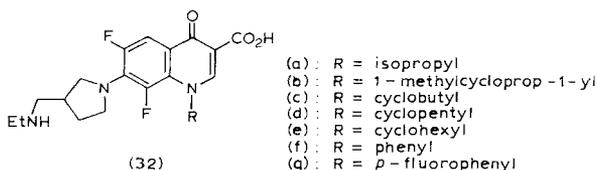

In this systematic study, a series of 18 *N*-1 analogues (32) of CI934 was prepared and evaluated for *in vitro* antibacterial activity and DNA-gyrase inhibition. Correlations between the inhibition of DNA gyrase and antibacterial potency were established, and a QSAR was derived by using the antibacterial potencies against each of 11 strains of bacteria and the Gram-negative mean. The equations indicate that antibacterial potency is strongly dependent on STERIMOL length and width and the level of unsaturation of the *N*-1 substituent. Some strains of bacteria also show a dependence on the presence of heteroatoms in the *N*-1 group. No significant correlations, however, were found between combinations of these parameters and gyrase inhibition. The authors note that, although steric bulk and unsaturation are important descriptors for the calculation of potency, how these variables actually affect relative activity is not clear. For example, the fact that cyclopropyl and phenyl substituents confer superior activity to isopropyl and cyclohexyl groups, respectively, is considered. Within the data set examined, no significant differences or trends emerge upon consideration of charge density or pK_a of the carboxylic acid. This

result is interpreted to imply that the π -electronic character of the *N*-1 substituent does not significantly perturb the electronics of the quinolone ring system. Furthermore, molecular modelling studies for ethyl and cyclopropyl derivatives indicate a preferential orientation of the group on *N*-1 above (or below) the plane of the quinolone nucleus. A conformation allowing the cyclopropyl group π -electron delocalization through the ring is attainable; however, in the case of the phenyl substituent, a conformation allowing delocalization between the rings is highly energetically unfavourable. Thus, it is suggested that the beneficial effect of the phenyl substituent is mediated through space, perhaps through an interaction with the enzyme, and that the same is likely to be true for the cyclopropyl group as well.

As is discussed at a later point in this review, it has been shown that the enantiomer (33) of ofloxacin [81] and the related enantiomer (34) of S-25930 [82] are each significantly more potent antibacterial agents than their respective enantiomers; furthermore, the *gem*-dimethyl analogue (35) is as inactive as the

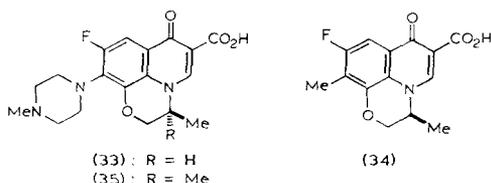

enantiomer of (33). Thus, in the context of the above discussion, it is noted that a substituent above the plane of the quinolone nucleus in these constrained analogues (as drawn in (33) and (34)) is beneficial to activity, while the opposite configuration is deleterious, suggesting that groups which can fill limited space above the plane of the nucleus without occupying simultaneously space below will be favoured. Since all two-atom (not including hydrogen substituents) groups can fulfill this requirement, most confer activity comparable with that obtained with an ethyl group. The observed decreased activities of the isopropyl analogue (32a) as well as the 1-methylcycloprop-1-yl derivative (32b) and the larger ring analogues (32c–e) are also consistent with this notion. It is suggested that the phenyl-substituted analogues (32f) and (32g) are less potent than the corresponding cyclopropyl derivative because the phenyl group simultaneously occupies volume above and below the quinolone plane; however, the phenyl group confers enhanced potency relative to the cyclohexyl moiety (comparable steric bulk) due to its unsaturation. Finally, it is hypothesized that the outstanding relative properties associated with the cyclopropyl substituent may

result from a fortuitous optimum blend of through-space electronic interactions and occupied volume above the plane of the quinolone nucleus.

Surprisingly, in the light of the results of studies such as those described above, the 1-*t*-butyl analogues (36) exhibit excellent antibacterial properties [83]. The results for the *in vitro* evaluation of these agents relative to ciprofloxacin are shown in Table 6.14. Compound (36a), the 1-*t*-butyl analogue of

Table 6.14. *IN VITRO* ACTIVITY OF 1-*t*-BUTYLQUINOLONES [83]

Compound	MIC ($\mu\text{g ml}^{-1}$)					
	<i>S. aureus</i> <i>Smith A9537</i>	<i>E. coli</i> <i>A 15119</i>	<i>K. pneumoniae</i> <i>A 9664</i>	<i>E. cloacae</i> <i>A 9656</i>	<i>M. morgani</i> <i>A 15153</i>	<i>P. aeruginosa</i> <i>A 9843</i>
(36a)	0.06	0.06	0.13	0.13	0.25	0.5
(36b)	0.25	0.06	0.25	0.25	0.5	4
(36c)	0.06	0.015	0.13	0.06	0.25	1
(37)	1	0.5	1	2	0.25	1
Ciprofloxacin	0.13	0.03	0.03	0.008	0.015	0.13

ciprofloxacin, and the related naphthyridine derivative (36c) exhibit excellent MIC values, although they are significantly less active than ciprofloxacin against Gram-negative pathogens. However, the 1-*t*-butyl analogue (36a) is clearly more potent than the 1-isopropyl derivative (37) in whole cells; these

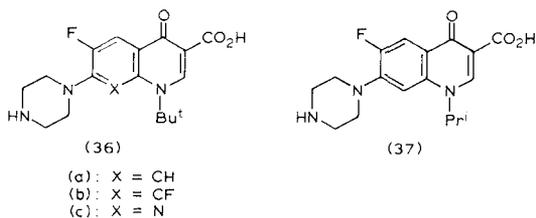

relative activities are difficult to rationalize with respect to the above arguments concerning spatial and electronic properties. It is interesting to note that again when the 1-substituent is relatively large, as in the case of phenyl, introduction of an 8-fluoro substituent (compound (36b)) does not enhance antibacterial activity. Both compounds (36a) and (36c) show good activity in mouse protection tests; (36c) appears to be somewhat more active than (36a), with ED₅₀ values comparable with norfloxacin versus Gram-negative organisms

and better in an *S. aureus* model. The naphthyridine analogue (36c) also exhibits enhanced aqueous solubility (0.82 mg ml^{-1}) relative to (36a) (0.13 mg ml^{-1}), although the two agents exhibit similar pharmacokinetic properties (C_{max} , $t_{1/2}$, AUC) after oral administration in dog.

HOMOCHIRAL QUINOLONES

Quinolones possessing a 7-(3-aminopyrrolidin-1-yl) substituent are particularly potent antibacterial agents. However, they often have very low solubility. Based on the observations that the hydroxymethylpyrrolidine (38) is significantly more potent against bacteria than its enantiomer (39) (the hydroxymethyl substituent in (39) apparently has a deleterious effect on activity while the same substituent in (38) has little effect on potency based on comparisons with the unsubstituted pyrrolidine analogue (40)) [84] and the enantiomer (41) is at least as potent as,

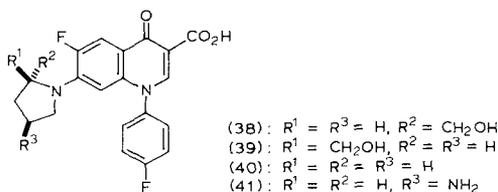

and perhaps more potent than the corresponding racemic mixture, an approach was undertaken to utilize the 2-position of the pyrrolidine ring as a handle to modify the physicochemical properties associated with highly potent 7-(3-aminopyrrolidin-1-yl)quinolones [85]. One may envision two ways of hybridizing the substituted pyrrolidine moieties of the active enantiomer (38) and (41) (Figure 6.6). This study focused on a series of (4*S*)-4-amino-2-substi-

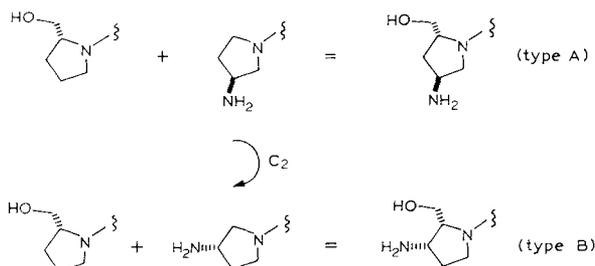

Figure 6.6. Potential 7-(substituted-aminopyrrolidin-1-yl) substituents.

tuted pyrrolidines (type A) as 7-substituents on the quinolone nucleus, with the goal of maintaining the excellent antibacterial activity associated with compounds such as (41), but with improved physicochemical and oral absorption properties. The structures of several of these compounds and their *in vitro* antibacterial activities are shown in *Table 6.15*. The properties of the unsubsti-

Table 6.15. STRUCTURES AND ANTIBACTERIAL ACTIVITY OF (4*S*)-7-(4-AMINO-2-SUBSTITUTED-PYRROLIDIN-1-YL)QUINOLONES [85]

Compound	R	X	MIC ($\mu\text{g ml}^{-1}$)			
			<i>S. aureus</i> ATCC 6538P	<i>S. epidermidis</i> 3519	<i>E. coli</i> Juhl	<i>P. aeruginosa</i> 5007
(42)		CH	0.1	0.78	0.78	0.78
(43)		CH	1.56	12.5	3.1	12.5
(44)		CH	0.05	0.1	0.1	6.2
(45)		CH	0.02	0.2	0.05	3.1
(46)		CH	0.39	0.78	0.78	5.0

Table 6.15. continued

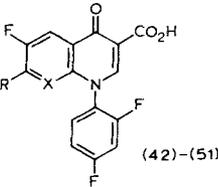
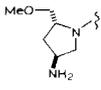
 (42)-(51)			<i>MIC</i> ($\mu\text{g ml}^{-1}$)			
<i>Compound</i>	<i>R</i>	<i>X</i>	<i>S. aureus</i> <i>ATCC 6538P</i>	<i>S. epidermidis</i> <i>3519</i>	<i>E. coli</i> <i>Juhl</i>	<i>P. aeruginosa</i> <i>5007</i>
(47)		N	0.02	0.05	0.02	0.78
(48)		N	0.2	0.39	0.39	12.5
(49)		N	0.1	0.39	0.05	0.39
(50)		N	0.1	0.39	0.2	1.56
(51)		N	0.05	0.2	0.1	0.78
Tosufloxacin		N	0.02	0.1	0.02	0.78

tuted aminopyrrolidine analogue tosufloxacin are shown for comparison. The initial pair of diastereomeric analogues prepared, (42) and (43), exhibit the same trend as observed for the enantiomeric hydroxymethylpyrrolidine derivatives (38) and (39) which provided the basis for this study; the (2*R*)-analogue (42) is significantly more active (approximately 4 log₂ dilutions) than the (2*S*)-compound (43). However, (42) is appreciably less active than tosufloxacin (or the related quinolone, X = CH), which is unsubstituted at the 2-position of the pyrrolidine moiety. The 2-ethylpyrrolidinyl analogue (44) shows excellent *in vitro* activity, although it is less active against *P. aeruginosa* than is desirable. The 2-methylpyrrolidinyl derivative (45) is perhaps 1 log₂ dilution more active. It is important to note that the epimer of (45), compound (46) (absolute stereochemistry at the 2-position of the pyrrolidine ring the same as (39) and (43)), shows diminished activity. This result combined with the data obtained for the related pairs (38)/(39), and (42)/(43) suggests that the decreased activities of (46), (39) and (43) relative to (45), (38) and (42), respectively, are due to some type of negative steric interaction (molecular nature not presently understood), as opposed to a negative polar interaction (same trend for CH₂OH and Me), which affects the ability of these agents to effectively inhibit the supercoiling process. The naphthyridine analogue of (45), compound (47) (A-65485) is the most potent member of this series, both *in vitro* as well as in mouse protection tests. It has been evaluated against approximately 200 strains of bacteria and is generally as potent or more potent than ciprofloxacin against all species except for *P. aeruginosa*, against which it is 1 log₂ dilution less active. The related bicyclic analogue (49) also shows excellent antibacterial activity.

Several of these agents were evaluated for their ability to inhibit supercoiling, using DNA gyrase isolated from *E. coli* (Table 6.16). The most important

Table 6.16. SUPERCOILING INHIBITION ACTIVITY OF (4*S*)-7-(4-AMINO-2-SUBSTITUTED)QUINOLONES [85]

Compound	I ₅₀ (μg ml ⁻¹)
Tosufloxacin	0.4
(42)	0.4
(43)	10
(45)	0.9
(46)	18
(47)	0.6
(48)	7.5
(51)	0.75
Ciprofloxacin	0.9

feature of these data is the difference in activity within each of the pairs of epimers (42)/(43), (45)/(46), (47)/(48), indicating that the observed differences in MIC values for each of the pairs is related to inherent activity at the enzymatic level as opposed to permeability or transport differences.

In general, the differences in I_{50} values correspond well with the differences in MIC values. However, although the hydroxymethyl analogue (42) has an I_{50} against purified gyrase that is a factor of 2 better than the methyl analogue (45), its activity in whole cells is significantly lower than that of (45). This discrepancy may be related to a negative effect (on transport or permeability) of the polar hydroxyl substituent in whole cells. The fluoromethyl analogue (51) was prepared as a potential isosteric derivative of the hydroxymethyl derivative (42), lacking the polar hydroxyl substituent, and this compound exhibits activity quite comparable with (47) against bacteria as well as versus the purified enzyme. Similarly, the methoxy derivative (50) also shows improved whole cell activity relative to (42).

Physicochemical (aqueous solubility, $\log P$) and pharmacokinetic properties for several of these compounds are shown in *Table 6.17*. All of the compounds investigated exhibit improved solubility relative to the 2-unsubstituted analogue tosylfloxacin. Substitution at this position of the pyrrolidine ring apparently results in a perturbation of the symmetry of this system that is associated with the intermolecular packing (high melting point, low solubility). Therefore, introduction of the methyl substituent in (47) results not only in improved aqueous solubility but also better solubility in general; although (47) is approximately 20-times more soluble in an aqueous medium than tosylfloxacin, the introduction of the methyl group results in the expected slight increase in lipophilicity and $\log P$ ($-0.46 \rightarrow -0.20$), indicating that there is an even greater increase in lipid (octanol) solubility in going from tosylfloxacin to (47) than the corresponding increase in aqueous solubility. These results suggest that the 2-position substituents on the pyrrolidine ring improve solubility not by changing the overall polar nature of the molecule but instead by reducing intermolecular binding.

The improved solubility properties of these compounds lead to excellent oral absorption properties. Compound (47), which exhibits the best overall properties in this study, attains better blood levels in mouse when administered at 25 mg kg^{-1} , p.o. than does tosylfloxacin at 100 mg kg^{-1} , p.o. It is interesting to note that the epimer of (47) (compound (48)), which is less active inherently but possesses even better solubility, achieves an outstanding C_{\max} of $12.4 \mu\text{g ml}^{-1}$. Compound (47) also exhibits excellent pharmacokinetic properties after oral administration in dog.

The enantiomers of the tricyclic quinolone ofloxacin and several structurally

Table 6.17. PHYSIOCHEMICAL PROPERTIES AND PHARMACOKINETICS OF
(4*S*)-7-(4-AMINO-2-SUBSTITUTED)QUINOLONES IN MICE [85]

Compound	Solubility (mg ml ⁻¹) ^a	log P ^b	Dose (mg kg ⁻¹) p.o.	Blood level of compound (µg ml ⁻¹) at t (h)					
				0.5	1.0	2.0	3.0	6.0	24
Tosufloxacin	0.008	-0.46	100	-	2.3	1.7	1.7	0.9	-
(42)	0.06	-0.98	-	-	-	-	-	-	-
(43)	0.06	-	-	-	-	-	-	-	-
(45)	0.053	+0.085	25	3.7	4.3	2.8	1.1	0.1	0.0
(46)	0.182	+0.03	-	-	-	-	-	-	-
(47)	0.15	-0.20	25	5.9	3.2	3.3	2.8	1.3	0.2
(48)	0.34	-0.11	25	5.3	12.4	3.7	2.2	1.1	0.0
Ciprofloxacin	0.092 ^c	-1.16	25	1.3	0.8	0.3	0.1	0.0	0.0

^a Solubility in Ringer's buffer solution.

^b Octanol/water partition coefficient.

^c Solubility determined in pH 7.4 phosphate buffer solution (0.05 M).

related analogues have been prepared and evaluated biologically [81, 82, 86, 88]. In all cases, the (*S*)-enantiomers (52) are more active than their respective (*R*)-antipodes. *In vitro* antibacterial activity as well as data for the inhibition of DNA gyrase isolated from both *E. coli* and *M. luteus* have been reported for the enantiomers of ofloxacin [81b]. A portion of these data is summarized in Table 6.18. Consistent with the results of an earlier study, the (*S*)-enantiomer

Table 6.18. BIOLOGICAL PROPERTIES OF THE ENANTIOMERS OF OFLOXACIN [81b]

Compound	MIC ($\mu\text{g ml}^{-1}$)				K _i ($\mu\text{g ml}^{-1}$)	
	<i>S. aureus</i> ATCC 6538P	<i>M. luteus</i> 9341	<i>E. coli</i> H560	<i>P. aeruginosa</i> K799/61	<i>M. luteus</i>	<i>E. coli</i>
(<i>R</i>)-Enantiomer	9.75	>9.75	9.75	1.21	105	27
(<i>S</i>)-Enantiomer	0.30	1.21	0.04	0.07	36	0.9
Racemic compound	0.39	3.1	0.1	0.1	84	1.6
Norfloxacin	—	—	—	—	72	1.0

was found to be 3–8 log₂ dilutions more potent than the (*R*)-enantiomer in whole cells. Inspection of the inhibition constants against purified DNA gyrase reveals not only differences in activity between the enantiomers but also significant differences between the respective susceptibilities of the enzyme isolated from different species of bacteria. The relative differences in magnitude when comparing the enzyme data with the corresponding data in whole cells suggest that the chiral preference of the enzyme can be exaggerated or diminished by cellular penetration factors. A similar phenomenon is observed for the highly potent pyridyl-substituted analogue (53) (CP-92, 121) [87]. While this compound is approximately 30-times (5 log₂ dilutions) more potent than its antipode against *E. coli* (intact organism), in a bacterial DNA gyrase inhibition assay (*E. coli*), the cleavage endpoint values suggest an enhancement in activity of only 4-fold for (53) relative to its enantiomer. The (*S*)-enantiomer of the fluoromethyl derivative of ofloxacin (54) also shows significantly enhanced antibacterial activity compared with the corresponding (*R*)-enantiomer [88].

A prototypical series of monocyclic and tricyclic agents with potency in the nalidixic acid – oxolinic acid range has been reported [89]. The enantiomers of the tricycle (55), which lacks the ring fused to the 5- and 6-positions of the pyridine portion common to most quinolones, have been evaluated *in vitro*, and

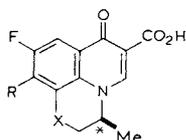

(52)

(S)-enantiomer of:

flumequine: R = H, X = CH₂
 methylflumequine: R = Me, X = CH₂
 ofloxacin: R = piperazin-1-yl, X = O

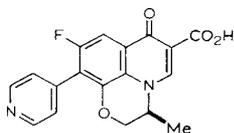

(53)

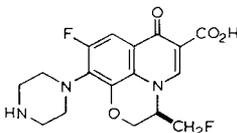

(54)

in contrast to the results observed for the S-25930 and ofloxacin ring systems, the (*R*)-enantiomer is considerably more potent than the (*S*)-enantiomer.

In contrast to the large differences in antibacterial and DNA gyrase inhibitory properties between the respective antipodes of ofloxacin and related analogues and the 7-(2-hydroxymethylpyrrolidin-1-yl)quinolones (38) and (39) [84] described earlier, there have been several studies suggesting diminished chiral recognition for substituents at the 3-position of 7-(3-substituted pyrrolidin-1-yl) and 7-(3-substituted piperazin-1-yl)quinolones such as in the agents CI934 [90], tosufloxacin [91], ternaflaxacin [92] and the 3-hydroxypyrrolidine derivative (56) [93]. The (*S*)-enantiomer of (56) is approximately 2 log₂ dilutions more active than the (*R*)-enantiomer. It is also interesting to note the beneficial effect of the hydroxyl substituent on *in vivo* activity (for both enantiomers) relative to the unsubstituted pyrrolidine derivative (57) (Table 6.19); both enantiomers of (56) exhibit significantly greater activity in mouse protection tests for *S. aureus* and *E. coli*, even though the dehydroxyl derivative has comparable MIC values with (56) versus these organisms (the *in vitro* data provided are not for the specific strains of bacteria used in the mouse protection tests).

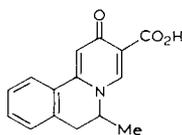

(55)

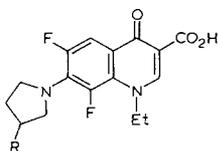

(56): R = OH
 (57): R = H

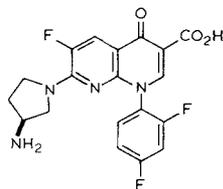

(58)

(S)-enantiomer of tosufloxacin

Table 6.19. EFFECT OF 3-HYDROXYL SUBSTITUENT ON *IN VIVO* ACTIVITY OF A 7-(PYRROLIDIN-1-YL)QUINOLONE [93]

Compound	ED_{50} , <i>p.o.</i> ($mg\ kg^{-1}$)	
	<i>S. aureus</i> IID-803	<i>E. coli</i> KC-14
(<i>R</i>)-(56)	10.1	7.2
(<i>S</i>)-(56)	8.1	4.3
(57)	> 100	53.6

The (*S*)-enantiomer of tosofloxacin (58) is also only moderately more active (1–2 \log_2 dilutions) *in vitro* against aerobic organisms than the (*R*)-enantiomer [91]; it also exhibits an I_{50} approximately 7–8-fold better than the (*R*)-enantiomer in a supercoiling inhibition assay. Interestingly, there seems to be enhanced chiral differentiation for these enantiomers in several strains of anaerobes, resulting in larger separations in MIC values for the respective antipodes. It was also found that the (*S*)-enantiomer of this agent exhibits improved aqueous solubility properties relative to the racemic mixture in media including urine (pH 5.1–7.0) and Ringer's buffer solution.

The enantiomers of CI934 have been prepared, and it was found that there is no significant difference in their potencies at the enzyme or bacterial levels, although the (*S*)-enantiomer (59) shows a consistent trend toward increased potency against Gram-positive organisms (the magnitude of the difference is within the margin of experimental error) [90]. The enantiomers exhibit identical I_{50} values ($2.5\ \mu g\ ml^{-1}$) in an assay for the inhibition of DNA gyrase isolated from *E. coli*. In mouse protection tests, (59) is approximately 3-fold more active, both upon oral and subcutaneous administration, than its enantiomer versus *S. pneumoniae* and *S. pyogenes* infections. This observation is quite interesting and is an excellent illustration of the often surprisingly different properties exhibited by optical isomers *in vivo*. It is likely that the 3-fold superiority results not solely because of the slightly better MIC values but also

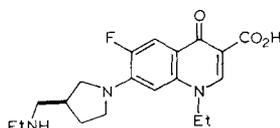

(59)

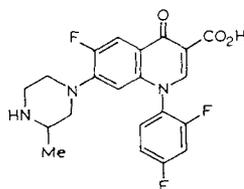
(*S*)-enantiomer of CI934

temafloxacin

may reflect pharmacokinetic or metabolic differences in the whole animal model.

Similar to the results observed with 3-substituted pyrrolidine derivatives, it has also been found that the enantiomers of temafloxacin (a 3-substituted piperazine analogue) do not show significantly different antibacterial properties [92].

In a study aimed at examining both the electronic influence of attaching a phenyl ring to the cyclopropyl ring of ciprofloxacin and the tolerance to this added steric bulk, the enantiomeric *trans*-disubstituted cyclopropane analogues (60) and (61) were prepared [94]. In general, the (1*S*,2*R*)-enantiomer (61) is

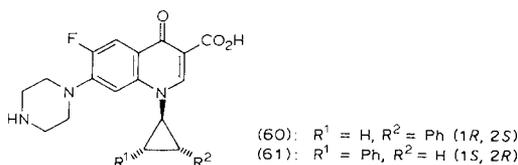

approximately 2 log₂ dilutions more active against bacteria than (60); (61) exhibits comparable *in vitro* activity with norfloxacin against Gram-positive organisms but greatly reduced relative potency against Gram-negative species. There is essentially no difference in the inhibitory properties of (60) and (61) with respect to enzyme isolated from *E. coli* (Table 6.20). However, against enzyme isolated from *M. luteus*, (61) is observed to exhibit greater inhibitory properties; interestingly, the enantiomer (61) is presently the most active inhibitor known against this particular enzyme. The relative differences in susceptibility of these enantiomers have been discussed in terms of a proposed model for the interaction of quinolones and DNA gyrase [32].

Table 6.20. INHIBITION OF DNA GYRASE BY PHENYLCYCLOPROPYL ENANTIOMERS (60) AND (61) [94]

Compound	K_i ($\mu\text{g ml}^{-1}$)	
	<i>M. luteus</i>	<i>E. coli H560</i>
(60)	38	14.2
(61)	9.6	12.1
Ciprofloxacin	38	0.9
Norfloxacin	72	1.0

CONFORMATIONALLY CONSTRAINED ANALOGUES

In another study concerning the conformational requirements of 1-cyclopropylquinolones and their relationship to DNA gyrase inhibition, the conformationally constrained cyclopropane derivative (62), related to ofloxacin was prepared and evaluated in whole cells and for inhibition of DNA gyrase [95]; the *gem*-dimethyl analogue (35), discussed earlier in the context of QSAR studies

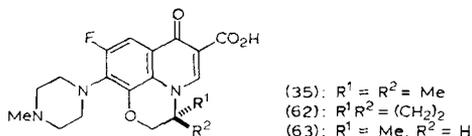

relating antibacterial potency and *N*-1 substituents, was prepared for comparison. Both compounds show potent inhibition of the target enzyme with I_{50} values the same as that of ofloxacin (3-fold less potent than ciprofloxacin) (Table 6.21). These results are quite interesting in light of the gyrase inhibitory data reported for the enantiomers of ofloxacin, which seem to suggest that a methyl substituent with α -configuration in this series (such as in compound (63), the *R*-enantiomer of ofloxacin) is deleterious to biological activity (in whole cells as well as in cell-free systems). However, these results indicate that disubstituted analogues, such as (35) or the spirocyclopropyl analogue (62), also can be potent DNA gyrase inhibitors. It is thus suggested, based on these results, that binding of quinolones to their biochemical target is facilitated by a substituent with β -configuration, while it is not affected appreciably by a substituent of α -orientation. Consistent with the earlier discussion concerning the overall effects of substituents simultaneously occupying regions of space

Table 6.21. BIOLOGICAL PROPERTIES OF THE CONFORMATIONALLY RESTRICTED SPIROCYCLOPROPYLQUINOLONE (62) [95]

Compound	MIC ($\mu\text{g ml}^{-1}$)				I_{50} ($\mu\text{g ml}^{-1}$)
	E. coli ATCC 1-25922	P. aeruginosa ATCC 27853	S. aureus ATCC 29213	B. fragilis ATCC 25285	E. coli gyrase
(62)	0.125	4	2	8	1
(35)	0.5	32	2	16	1
Ofloxacin	0.008	0.5	0.25	0.5	1
Ciprofloxacin	0.004	0.125	0.25	2	0.3

above and below the plane of the quinolone nucleus, the new analogue (62) shows greatly reduced antibacterial activity in whole cells relative to both ofloxacin and ciprofloxacin.

A study has appeared aimed at determining the effect of restricting the *N*-1 phenyl substituent into a rigid planar conformation on antibacterial activity [96]. Generally, the addition of alkyl substituents at the 2-position of the quinolone nucleus results in the loss of antibacterial activity. However, based on a report that 5-oxo-1,2-dihydro-5*H*-thiazolo[3,2-*a*]quinolone-4-carboxylic acids are good antibacterial agents [97], indicating tolerance to the substitution of a sulphur atom at the 2-position of the quinolone nucleus, a sulphur atom was employed to bridge the phenyl and quinolone rings, leading to the synthesis of the analogues (64). The *in vitro* antibacterial activities of (64) as well as several related analogues are shown in Table 6.22. The conformationally re-

Table 6.22. *IN VITRO* ACTIVITY OF CONFORMATIONALLY RESTRICTED 1-PHENYLQUINOLONES [96]

Compound	MIC ($\mu\text{g ml}^{-1}$)				
	<i>S. aureus</i> ATCC 6538P	<i>S. pyogenes</i> 930	<i>E. coli</i> Juhl	<i>K. pneumoniae</i> 8045	<i>P. aeruginosa</i> 5007
(64a)	0.39	0.78	0.2	0.2	1.56
(64b)	0.39	1.56	0.78	0.39	6.2
(65)	0.39	1.56	0.2	0.1	0.78
(21a)	0.78	3.1	0.78	0.2	6.2
(66)	> 100	> 100	> 100	> 100	> 100

stricted analogues (64a) and (64b) exhibit potent antibacterial activity and, importantly, activity very comparable to their related nonconstrained phenyl derivatives (21a) and (65), respectively. The 2,6-dimethylphenyl analogue (66) exhibits essentially no antibacterial activity; based on molecular models, the

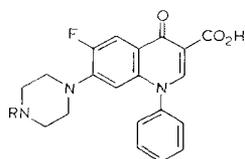

(21a): R = H
(65): R = Me

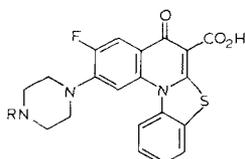

(64)
(a): R = H
(b): R = Me

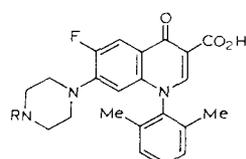

(66)

phenyl ring in this analogue is presumably approximately perpendicular to the quinolone nucleus, avoiding the steric interactions associated with the two *ortho*-substituents. Based on these combined results, it is postulated that the favourable biologically active conformation of 1-arylquinolones may be one in which the phenyl ring and quinolone nucleus are close to being coplanar, rather than in a perpendicular, relationship.

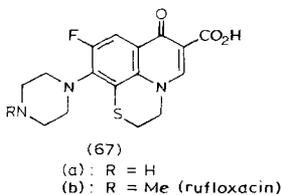

The SAR for a series of pyridobenzothiazine analogues (67) including structures (67a) and (67b) has been reported recently [98]. This ring system is similar to the tricyclic nucleus of ofloxacin. However, the ring oxygen is replaced with sulphur, and they lack the ring-methyl present in ofloxacin. Compounds (67a) and (67b) (rufloxacin) exhibit overall good antibacterial activity, although their respective MIC values (Table 6.23) are clearly diminished relative to

Table 6.23. ANTIBACTERIAL ACTIVITY OF PYRIDOBENZOTHAZINE DERIVATIVES (67) [98]

Compound	MIC ($\mu\text{g ml}^{-1}$)					
	<i>S. aureus</i> 18773	<i>E. coli</i> 15	<i>P. aeruginosa</i> 2437	<i>P. morgani</i> 27	<i>K. pneumoniae</i> 4	<i>E. cloacae</i> 041
(67a)	0.78	0.39	12.5	1.56	<0.39	<0.39
(67b)	0.78	0.78	12.5	1.56	<0.39	<0.39
Ofloxacin	0.19	0.19	1.56	0.78	0.39	0.19

ofloxacin. Pharmacokinetic studies indicate that (67b) exhibits a long half-life in rat, dog, monkey and man. In the rat, the results of urinary recovery studies suggest the presence of active metabolite(s); the SAR studies suggest that the sulphoxide or sulphone derivatives of (67) would have significantly diminished activity relative to the parent compound. Thus, such oxidized analogues are unlikely candidates for the identity of the active metabolites. Compound (67a), which is unsubstituted on the piperazine nitrogen, is suggested from urinary

recovery studies to be either sparingly absorbed or inactivated by metabolic pathways. This observation is consistent with earlier investigations which have indicated that *N*-methylpiperazine analogues show better *in vivo* efficacy than their *N*-unsubstituted counterparts. In the earlier studies which led to the development of ofloxacin, it was reported that a related nitrogen-containing tricyclic analogue (versus sulphur in this case) has reduced antibacterial properties relative to ofloxacin, particularly versus opportunistic pathogens such as *Pseudomonas* and Gram-positive bacteria [99].

7-HETEROARYLQUINOLONES

The majority of the new fluoroquinolones undergoing development possess a substituted piperazine or pyrrolidine group at the 7-position of the quinolone nucleus. As is clear from the above results, very subtle changes in this portion of the molecule can have profound effects on potency, spectrum of activity, pharmacokinetics and physiochemical properties. Structure-activity studies have also indicated that certain heteroaromatic substituents at this position can confer excellent antibacterial properties. Based on the structure of rosoxacin (68) [100], one of the earlier quinolone antibacterials which lacks a 7-fluoro substituent, a series of related naphthyridine analogues (69) was prepared which incorporate the fluoro substituent and various *N*-1 substituents [101]. The *in vitro* results for these analogues are summarized in Table 6.24. Based on the enhancement in activity ($\geq 4 \log_2$ dilutions) associated with the introduction of a 6-fluoro substituent in the naphthyridine analogue defluoroenoxa-

Table 6.24. ANTIBACTERIAL ACTIVITY OF 7-(4-PYRIDYL)NAPHTHYRIDINE ANALOGUES [101]

Compound	R	(MIC) ($\mu\text{g ml}^{-1}$)		
		<i>S. aureus</i> 209P JC-1	<i>E. coli</i> NIHJ JC-2	<i>P. aeruginosa</i> 12
(69a)	Et	0.39	0.2	3.13
(69b)	(CH ₂) ₂ F	0.39	0.2	1.56
(69c)	(CH ₂) ₂ OH	50	1.56	50
(69d)	CH = CH ₂	1.56	0.78	6.25
(69e)	cyclopropyl	0.2	0.1	0.78
(70)	-	1.56	0.78	12.5
Rosoxacin (68)		0.78	0.39	3.13
Enoxacin		0.78	0.2	0.78

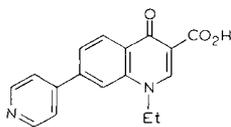

(68)

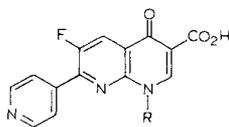

(69)

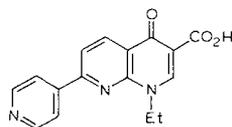

(70)

cin to give enoxacin, a similar increase in potency was expected in going from (70) (naphthyridine analogue of rosoxacin) to its 6-fluoro congener (69a). However, the improvement in potency is less dramatic than observed previously; in this case, introduction of fluorine results in only a 2 log₂ dilution improvement in antibacterial potency. Comparison of the data for (69a) and enoxacin versus these limited organisms suggests that the pyridine replacement for piperazine can confer comparable potency (*S. aureus*, *E. coli*), although there appears to be somewhat diminished activity against the *Pseudomonas* organism investigated. The cyclopropyl derivative (69e) was found to be the most potent member of this new series; in mouse protection tests this compound exhibits oral activity less than that of enoxacin against *E. coli* and *P. aeruginosa* and somewhat better against *S. aureus*. An example of a highly potent (particularly against Gram-positive organisms) 7-(4-pyridyl)quinolone is (53) [87], discussed earlier in the context of chiral recognition by DNA gyrase, which contains the tricyclic nucleus found in ofloxacin. This compound has the following MIC values ($\mu\text{g ml}^{-1}$): *S. aureus*, 0.001; *E. coli*, 0.012; *P. aeruginosa*, 0.2. The corresponding values for ciprofloxacin are 0.39, 0.001 and 0.05 $\mu\text{g ml}^{-1}$, respectively.

Another study concerning heteroaromatic substituents has focused on the evaluation of a series of 6-fluoro- and 6,8-difluoro-7-azolyquinolone derivatives [102]. Representative microbiological data for several of these compounds are summarized in Table 6.25. Amongst the monofluoro derivatives (71), the pyrrole analogue (71c) exhibits the most potent activity against Gram-positive organisms; the imidazole derivative (71a), although less active against Gram-positive organisms, exhibits comparable activity with (71c) versus Gram-negative species (ca. 1–3 log₂ dilutions less active than norfloxacin). The 6,8-difluoro-7-imidazole analogue (72b) exhibits enhanced antibacterial potency relative to its monofluoro analogue (71a) with overall spectrum and potency comparable with those of norfloxacin (as well as 8-fluoronorfloxacin), with the exception of *P. aeruginosa*. Several substituted imidazole analogues were also evaluated, and the 4-methyl derivative (72d) exhibits *in vitro* potency comparable with that of (72b). The enhancement in *in vitro* activity in going from (71a) to (72b) (6-fluoro to 6,8-difluoro) is not observed in the case of the

Table 6.25. ANTIBACTERIAL ACTIVITY OF 7-AZOLEQUINOLONES (71) AND (72) [102]

Compound	MIC ($\mu\text{g ml}^{-1}$)					
	S. aureus FDA 209P	B. subtilis ATCC 6633	E. coli NIHJJC-2	K. pneumoniae PCI-602	S. paratyphi 1015	P. aeruginosa IFO 3445
(71a)	6.25	0.78	1.56	0.20	0.10	12.5
(71b)	6.25	0.78	12.5	0.78	0.39	25
(71c)	0.39	0.05	3.13	0.20	0.10	12.5
(71d)	25	25	25	12.5	3.13	25
(72a)	0.39	0.05	3.13	0.20	0.20	12.5
(72b)	0.39	0.10	0.20	0.05	0.05	6.25
(72c)	6.25	0.78	3.13	0.39	0.39	25
(72d)	0.78	0.05	0.39	0.10	0.10	6.25
Norfloxacin	0.39	0.39	0.39	0.10	0.10	1.56

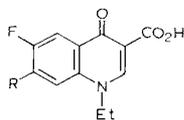

- (a): R = imidazol-1-yl
 (b): R = pyrazol-1-yl
 (c): R = pyrrol-1-yl
 (d): R = 1,2,4-triazol-4-yl

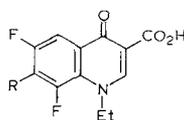

- (a): R = pyrrol-1-yl
 (b): R = imidazol-1-yl
 (c): R = 2-methylimidazol-1-yl
 (d): R = 4-methylimidazol-1-yl

same modification to the pyrrole derivative (71c) (to give 72a); these two compounds possess virtually identical MIC values.

The monofluoro analogues (71) possess very weak oral activity in a mouse protection test against *E. coli*. On the other hand the difluoro analogues (72b) and (72d) were found to be about 2-fold more active than norfloxacin in this

Table 6.26. PHARMACOKINETIC EVALUATION^a OF 7-(IMIDAZOL-1-YL)QUINOLONES IN MICE [102]

Compound	Blood level of compound ($\mu\text{g ml}^{-1}$) at t (min)			
	30	60	120	240
(72b)	44.8	39.3	7.6	1.7
(72d)	49.2	29.4	10.0	6.3
Norfloxacin	1.05	0.69	0.40	0.36

^a Compounds were administered orally at a dose of 50 mg kg^{-1} .

paradigm, although they are 2 log₂ dilutions less active against this pathogen *in vitro*. Pharmacokinetic data for these two compounds are shown in *Table 6.26*. These results indicate that the excellent *in vivo* results obtained with (72b) and (72d) are, to a large extent, apparently related to excellent oral absorption properties.

SUBSTITUTIONS AT THE 5-POSITION OF THE QUINOLONE NUCLEUS

Studies concerning modifications at the 5-position of the quinolone nucleus have been relatively limited. However, a recent study suggests that an amino group at this position can in some cases significantly enhance antibacterial activity [103]. In particular, a series of 5-amino-7-(piperazin-1-yl) and 5-amino-7-(pyrrolidin-1-yl)quinolones of general structures (73) and (74), respectively, was investigated; the *in vitro* properties of several of these agents are summarized in *Table 6.27*. Data for 8-fluorociprofloxacin (73e) [104] are shown for comparison; this agent exhibits comparable activity with ciprofloxacin *in vitro*, while showing slightly improved efficacy in mouse protection tests. In general, 5-unsubstituted 7-pyrrolidin-1-yl derivatives such as (8) (R¹ = H, R² = CH₂NHEt) (PD117558) exhibit especially potent activity versus streptococci and staphylococci, while the piperazine moiety in similar systems confers particularly potent activity against Gram-negative pathogens. Introduction of a 5-amino substituent on the nucleus of the 8-fluoro ciprofloxacin analogue (73e) to give (73a) confers a 1–4 log₂ dilution improvement in potency against both Gram-negative and Gram-positive organisms; the authors of this work note that this compound exhibits more potent *in vitro* activity against staphylococci and streptococci than any of the piperazine-containing quinolone reference agents evaluated in their laboratories and suggest that introduction of this group appears to compensate for the relatively weaker Gram-positive activity associated with the piperazine group. The *N*-methylpiperazine analogue (73b) also exhibits a 2–4 log₂ dilution improvement in activity relative to its 5-unsubstituted congener. In the pyrrolidine series (74), introduction of a 5-amino substituent affords several agents with excellent antimicrobial activity. However, the improvement in activity relative to the 5-unsubstituted analogues

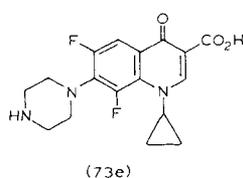
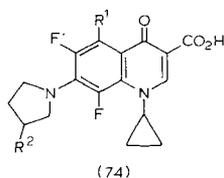
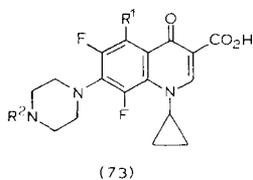
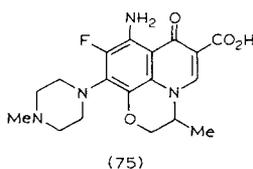

Table 6.27. *IN VITRO* PROPERTIES OF 5-AMINOQUINOLONE DERIVATIVES [103]

Compound	R^1	R^2	I_{50} ($\mu\text{g ml}^{-1}$)		MIC ($\mu\text{g ml}^{-1}$)					
			E. coli <i>DNA gyrase</i>	E. coli <i>H560</i>	K. pneumoniae <i>MGH-2</i>	P. aeruginosa <i>UI-18</i>	S. aureus <i>H-228</i>	S. faecalis <i>MGH-2</i>	S. pneumoniae <i>SV-1</i>	S. pyogenes <i>C203</i>
(73a)	NH ₂	H	2.8	0.003	0.025	0.025	0.05	0.05	0.05	0.2
(73b)	NH ₂	Me	2.8	0.003	0.013	0.1	0.05	0.1	0.2	0.4
(73c)	NHMe	H	13.8	0.025	0.1	1.6	0.8	1.6	0.8	3.1
(73d)	NMe ₂	Me	> 200	> 25	> 25	> 25	> 25	> 25	> 25	> 25
(73e)	H	H	2.8	0.025	0.05	0.2	0.4	0.4	0.8	0.8
(74a)	NH ₂	NH ₂	2.6	0.003	0.006	0.05	0.013	0.025	0.006	0.025
(74b)	NH ₂	CH ₂ NH ₂	2.9	0.003	0.025	0.1	0.006	0.013	0.003	0.003
(74c)	NH ₂	CH ₂ NHEt	2.7	0.013	0.05	0.4	0.013	0.025	0.003	0.013

associated with this modification is much less dramatic than in the case of the piperazine analogues. Substitution on the 5-amino group ((73c), (73d)) as well as acetylation of this moiety results in greatly decreased activity.

In general, the introduction of the amino moiety causes little effect on the enzyme inhibitory properties; thus, the effects on antibacterial activity appear to be a result of whole cell phenomena. There are only a small number of direct comparisons available concerning the *in vivo* activities of these new 5-amino compounds and their unsubstituted analogues, precluding generalizations regarding *in vivo* efficacy. However, both (73a) and (74c), 5-amino analogues, are somewhat less active orally than their respective 5-unsubstituted analogues in mouse protection tests for *E. coli*. Although the 5-amino group appears to be beneficial with respect to antibacterial spectrum and potency in 6,8-difluoroquinolones, the trend is not necessarily general; the 8-amino analogue of ofloxacin (75) is substantially less active than ofloxacin. As final points, it is noted that the 5-amino group in these structures is non-basic (pK_b of (74a); 2.7) and has little effect on water solubility.



7-DIAZABICYCLOALKYLQUINOLONES WITH ACTIVITY AGAINST VETERINARY PATHOGENIC BACTERIA: DANOFLOXACIN

A series of 7-diazabicycloalkyl quinolones has been prepared and found to exhibit excellent broad spectrum activity against important veterinary pathogenic bacteria [105]. The structures of several of these interesting bicyclic analogues (76) as well as MIC data are summarized in *Table 6.28*. Compound (76e) (danofloxacin), which also exhibits excellent p.o. and s.c. activity in a mouse protection model for *Pasteurella multocida* [106], is undergoing development for use in veterinary medicine. It has been shown to exhibit excellent bioavailability properties in cattle, swine and poultry [107] and is efficacious in models for the treatment of respiratory diseases in food-producing animals [108].

Table 6.28. 7-DIAZABICYCLOALKYLQUINOLONE ANALOGUES – STRUCTURES AND *IN VITRO* ACTIVITY [105]

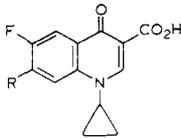
 (76)		<i>MIC</i> ($\mu\text{g ml}^{-1}$)		
		<i>E. coli</i>	<i>P. haemolytica</i>	<i>A. pleuropneumoniae</i>
(a)		0.025	0.006	< 0.05
(b)		< 0.05	< 0.05	< 0.05
(c)		0.20	< 0.05	< 0.05
(d)		0.20	< 0.05	< 0.05
(e) (danofloxacin)		< 0.05	< 0.05	< 0.05

PRODRUGS WITH IMPROVED ORAL ABSORPTION PROPERTIES

In attempts to improve the oral activity of norfloxacin, prodrug techniques have been employed. In an initial approach, the (5-methyl-2-oxo-1,3-diox-4-yl)-methyl group, which had been shown previously to be effective in a novel ampicillin prodrug, was investigated as a promoiety [109]. However, although the ester (77) liberates norfloxacin in the presence of mouse blood, after oral administration to mice, it was found that the blood levels of norfloxacin achieved are lower (approximately $1/2$, with respect to C_{max}) than those achieved upon oral administration of an equimolar dose of norfloxacin, itself. This observation has been assumed to be due to an instability of this ester prior to absorption rather than an inability to liberate the parent drug after absorption.

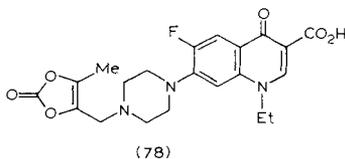
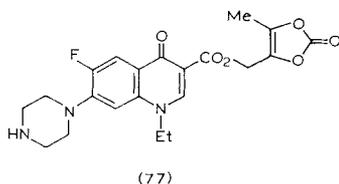

Based on the observation that pefloxacin (*N*-methylnorfloxacin) exhibits enhanced *in vivo* activity upon oral administration (although it is less active *in vitro*) relative to norfloxacin, the same promoiety was investigated as an approach to blocking the secondary amine group, which seems to be associated with reduced oral absorption. Indeed, compound (78) was shown to produce about 5-fold higher serum levels of norfloxacin, after oral administration to mice than did the parent drug, itself.

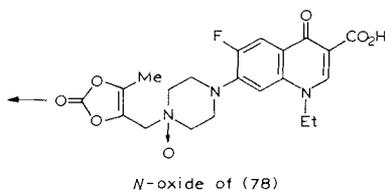
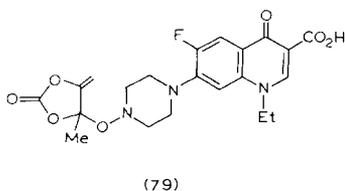

The related derivative (79), obtained by thermal rearrangement of the *N*-oxide of (78), also exhibits excellent prodrug properties [110]. This compound, when administered orally to mice, liberates excellent levels of norfloxacin and is slightly more effective in mouse protection tests than (78) and significantly better than norfloxacin.

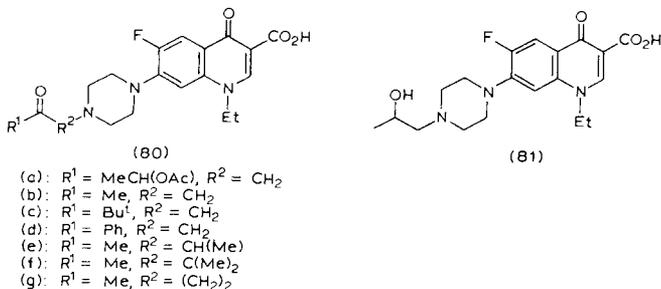

Subsequently, the same group of workers prepared a series of *N*-(oxoalkyl)-norfloxacin derivatives (80) as potential prodrugs [111]. *In vitro*, these compounds generally exhibit activity against Gram-positive organisms comparable with norfloxacin and reduced potency against Gram-negative species; compounds (80b–g) are stable in the same pH buffer solution in which the MIC values were determined, although (80a) is not and could not therefore be assayed. Mouse protection studies (Table 6.29) indicate that (80b) shows

Table 6.29. COMPARISON OF THE ORAL EFFICACIES OF PRODRUG (80b) AND NORFLOXACIN IN MOUSE PROTECTION TESTS [111]

Compound	ED_{50} (mg kg ⁻¹ , p.o.)		
	<i>S. aureus</i> Smith	<i>E. coli</i> KC-14	<i>P. aeruginosa</i> E2
(80b)	12.6	0.95	18.5
Norfloxacin	36.4	4.38	59.0

greatly improved efficacy relative to norfloxacin. Further investigations in mice demonstrate that (80b) not only liberates norfloxacin but also the reduced metabolite (81), as well as maintaining high blood levels, itself (Table 6.30). Interestingly, the metabolite (81) is not transformed to either (80b) or norfloxacin upon oral administration, although it possesses significant *in vitro* antibacterial activity, itself. Thus, the significantly enhanced activity of (80b) in mouse protection tests appears to be the result of a combination of factors; it is absorbed better than norfloxacin, it is active itself and it affords another active metabolite. This compound exhibits similar properties upon oral administration to rat.

The 3-formyl analogues of norfloxacin, pefloxacin and ciprofloxacin, (82a–c) have also been shown to function as prodrugs of their respective parent

Table 6.30. SERUM CONCENTRATIONS OF (80b), (81) AND NORFLOXACIN AFTER ORAL ADMINISTRATION TO MICE [111]

Compound	Serum concentration ($\mu\text{g ml}^{-1}$) at t (h)			
	0.5	1.0	2.0	4.0
(80b) ^a (100 mg kg ⁻¹)				
(80b)	23.6	7.3	2.7	0.46
(81)	19.5	20.2	6.9	2.8
Norfloxacin	6.3	5.7	4.0	2.6
(81) ^{a,b} (100 mg kg ⁻¹)				
(81)	13.6	27.1	11.8	2.2
Norfloxacin (100 mg kg ⁻¹) (norfloxacin)	3.5	2.0	1.1	0.56

^a A dose equivalent to 100 mg kg⁻¹ of norfloxacin.

^b Norfloxacin or (80b) was not detected in the serum.

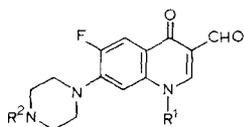

(82)

- (a): R¹ = Et, R² = H
 (b): R¹ = Et, R² = Me
 (c): R¹ = cyclopropyl, R² = H

quinolones [112]; these compounds exhibit enhanced oral activity in *E. coli* mouse protection tests. The log *P* values of norfloxacin and its formyl analogue (82a) are virtually identical (-0.57 and -0.58, respectively). Therefore, it is unlikely that the enhanced oral absorption properties are related to a change in lipophilicity. It is suggested that the lack of amphoteric properties associated with the zwitterionic parent drugs may be a prime factor in the observed increased oral absorption of these analogues.

SUMMARY

In summary, the last decade has been a highly fertile and productive period in quinolone medicinal chemistry, resulting in major improvements in potency, antibacterial spectra, oral absorption and pharmacokinetic properties as well as an increased knowledge of the molecular features important to conferring these various properties. Very recent discoveries concerning replacements for the 3-carboxylic acid moiety, previously thought to be uniquely essential for activity, to give highly potent antibacterials such as (83) illustrate the potential

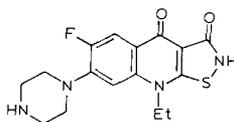

(83)

for new breakthroughs in this field [113]. Among the major goals for future research remains the understanding of the potential cartilage toxicity associated with this class of agents, such that an agent useful for pediatric indications may be developed. Future studies can also be expected to further enhance and refine the level of current insight into the manner by which these agents inhibit the target enzyme on a molecular level.

ACKNOWLEDGEMENTS

I express great appreciation to Drs. John Barrett and Paul McGuirk (Pfizer Central Research) and Dr. Linus Shen (Abbott Pharmaceutical Discovery) for their expert opinions, comments and suggestions concerning this review.

REFERENCES

1. G.Y. Leshner, E.J. Froelich, M.D. Gruett, J.H. Bailey and R.P. Brundage, *J. Med. Chem.*, 5 (1962) 1063.
2. R. Albrecht, *Prog. Drug Res.*, 21 (1977) 9.
3. H.C. Neu and P. Labthavikul, *Antimicrob. Agents Chemother.*, 22 (1982) 23.
4. R. Wise, J.M. Andrews and L.J. Edwards, *Antimicrob. Agents Chemother.*, 23 (1983) 559.
5. (a) M.P. Wentland and J.B. Cornett, *Annu. Rep. Med. Chem.*, 20 (1985) 145; (b) J.B. Cornett and M.P. Wentland, *Annu. Rep. Med. Chem.*, 21 (1986) 139; (c) P.B. Fernandes and D.T.W. Chu, *Annu. Rep. Med. Chem.*, 22 (1987) 117; (d) P.B. Fernandes and D.T.W. Chu, *Annu. Rep. Med. Chem.*, 23 (1988) 133; (e) J.J. Schentag and J.M. Domagala, *Res. Clin. Forums*, 7 (1985) 10; (f) G.C. Crumplin, *Rev. Infect. Dis.*, 10 (1988) Suppl. 1 S2; (g) D.T.W. Chu and P.B. Fernandes, *Antimicrob. Agents Chemother.*, 33 (1989) 131; (h) L.A. Mitscher, R.M. Zavod, P.N. Sharma, D.T.W. Chu, L.L. Shen and A.G. Pernet, in *Horizons on Antibiotic Research*, eds. B.D. Davis, T. Ichikawa, K. Maeda and L.A. Mitscher (Japan Antibiotics Research Association, Tokyo; 1988) pp. 166-193.
6. (a) R. Janknegt, *Pharm. Week. Sci. Ed.*, 8 (1986) 1; (b) J.H. Paton and D.S. Reeves, *Drugs*, 36 (1988) 192; (c) P.B. Fernandes, *J. Clin. Pharmacol.*, 28 (1988) 156; (d) G.M. Eliopoulos and C.T. Eliopoulos, in *Quinolone Antimicrobial Agents*, eds. J.S. Wolfson and D.C. Hooper (American Society for Microbiology Washington, DC; 1989) pp. 35-70.
7. (a) J.T. Smith, *Pharm. J.*, 233 (1984) 299; (b) J.S. Wolfson and D.C. Hooper, *Antimicrob. Agents Chemother.*, 28 (1985) 581; (c) D.C. Hooper and J.S. Wolfson, *Rev. Infect. Dis.*,

- 10 (1988) Suppl. 1 S14; (d) J.S. Wolfson, D.C. Hooper and M.H. Swartz, in *Quinolone Antimicrobial Agents*, eds. J.S. Wolfson and D.C. Hooper (American Society for Microbiology, Washington DC; 1989) pp. 5–34; (e) F.H. Kayser, *Res. Clin. Forums*, 7 (1985) 17; (f) *The Molecular Basis of Antibiotic Action*, eds. E.F. Gale, E. Cundliffe, P.E. Reynolds, M.H. Richmond and M.J. Waring (John Wiley & Sons, Chichester), 2nd Edn. (1981) pp. 377–382; (g) G. Klopman, O.T. Macina, M.E. Levinson and H.S. Rosenkranz, *Antimicrob. Agents Chemother.*, 31 (1987) 1831.
8. M. Gellert, K. Mizuuchi, M.H. O'Dea and H.A. Nash, *Proc. Natl. Acad. Sci. USA*, 73 (1976) 3872.
 9. The properties of DNA gyrase and the supercoiling of DNA have been reviewed; N.R. Cozzarelli, *Science* (Washington, DC), 207 (1980) 953.
 10. N.P. Higgins, C.L. Peebles, A. Sugino and N.R. Cozzarelli, *Proc. Natl. Acad. Sci. USA*, 75 (1978) 1773.
 11. J.T. Smith, *J. Antimicrob. Chemother.*, 18 (1986) Suppl. D 21.
 12. A. Sugino, N.P. Higgins, P.O. Brown, C.L. Peebles and N.R. Cozzarelli, *Proc. Natl. Acad. Sci. USA*, 75 (1978) 4838.
 13. P.O. Brown and N.R. Cozzarelli, *Science* (Washington, DC), 206 (1979) 1081.
 14. M. Gellert, *Annu. Rev. Biochem.*, 50 (1981) 879.
 15. J.C. Wang, *Annu. Rev. Biochem.*, 54 (1985) 665.
 16. K. Mizuuchi, M.H. O'Dea and M. Gellert, *Proc. Natl. Acad. Sci. USA*, 75 (1978) 5960.
 17. A. Sugino, C.L. Peebles, K.N. Kreuzer and N.R. Cozzarelli, *Proc. Natl. Acad. Sci. USA*, 74 (1977) 4767.
 18. M. Gellert, K. Mizuuchi, M.H. O'Dea, T. Itoh and J.-I. Tomizawa, *Proc. Natl. Acad. Sci. USA*, 74 (1977) 4772.
 19. (a) S. Inoue, T. Ohue, J. Yamagashi, S. Nakamura and M. Shimizu, *Antimicrob. Agents Chemother.*, 14 (1978) 240; (b) J.-I. Yamagishi, Y. Furutani, S. Inoue, T. Ohue, S. Nakamura and M. Shimizu, *J. Bacteriol.*, 148 (1981) 450; (c) J.-I. Yamagishi, H. Yoshida, M. Yamayoshi and S. Nakamura, *Mol. Gen. Genet.*, 204 (1986) 367.
 20. A. Morrison and N.R. Cozzarelli, *Cell*, 17 (1979) 175.
 21. L.M. Fisher, K. Mizuuchi, M.H. O'Dea, H. Ohmori and M. Gellert, *Proc. Natl. Acad. Sci. USA*, 78 (1981) 4165.
 22. J.M. Domagala, L.D. Hanna, C.L. Heifetz, M.P. Hutt, T.F. Mich, J.P. Sanchez and M. Solomon, *J. Med. Chem.*, 29 (1986) 394.
 23. L. Walton and L.P. Elwell, *Antimicrob. Agents Chemother.*, 32 (1988) 1086.
 24. K.N. Kreuzer and N. Cozzarelli, *J. Bacteriol.*, 140 (1979) 424.
 25. L.J.V. Piddock and R. Wise, *FEMS Microbiol. Lett.*, 41 (1987) 289.
 26. For example, see (a) M.M. Zweerink and A. Edison, *Antimicrob. Agents Chemother.*, 29 (1986) 598; (b) L.F. Liu and J.C. Wang, *Proc. Natl. Acad. Sci. USA*, 5 (1978) 2098 and Ref. 81(b).
 27. N.H. Georgopapadakou and D.A. Russo, *Abstracts of the 87th ASM*, A-107 (1987).
 28. M. Takahata and T. Nishino, *Antimicrob. Agents and Chemother.*, 32 (1988) 1192.
 29. L.L. Shen and A.G. Pernet, *Proc. Natl. Acad. Sci. USA*, 82 (1985) 307.
 30. L.L. Shen, W.E. Kohlbrenner, D. Weigl and J. Baranowski, *J. Biol. Chem.*, 264 (1989) 2973.
 31. L.L. Shen, J. Baranowski and A.G. Pernet, *Biochemistry*, 28 (1989) 3879.
 32. L.L. Shen, L.A. Mitscher, P.H. Sharma, T.J. O'Donnell, D.T.W. Chu, C.S. Cooper, T. Rosen and A.G. Pernet, *Biochemistry*, 28 (1989) 3886.
 33. (a) A. Achari and S. Neidle, *Acta Cryst.*, B32 (1976) 600; (b) C.P. Huber, D.S.S. Gowda and K.R. Acharya, *Acta Cryst.*, B36 (1980) 497, in ref. 32.

34. P. Hussy, G. Maass, F. Tümmeler, F. Grosse and U. Schomburg, *Antimicrob. Agents Chemother.*, 29 (1986) 1073.
35. J.T. Smith, *Infection*, 14 (1986) S3.
36. (a) J.F. Barrett, T.D. Gootz, P.R. McGuirk, C. Farrell, S. Sokolowski and M. Frescura, *Abstracts of the 27th ICAAC*, 249 (1987); (b) H.E. Holden J.F. Barrett, C.M. Huntington, P.A. Muehlbauer and M.G. Wahrenburg, *Environ. Mol. Mut.*, 13 (1989) 238.
37. M.A. Cohen, P.A. Bien, T.J. Griffin and C.L. Heifetz, *Abstracts of the 26th ICAAC*, 423 (1986).
38. K. Hirai, T. Ishizaki, T. Koike, K. Iwase, M. Hosaka, Y. Niwata, Y. Asahina, S. Suzue and K. Masuzawa, *Abstracts of the 26th ICAAC*, 436 (1986).
39. J. Stamm, C. Vojtko, J. Weisz, C. Hanson, D.T.W. Chu and P.B. Fernandes, *Abstracts of the 25th ICAAC*, 132 (1985).
40. (a) H.C. Neu, *Rev. Infect. Dis.*, 10 (1988) Suppl. 1 S57; (b) L.J.V. Piddock and R. Wise, *J. Antimicrob. Chemother.*, 23 (1989) 475.
41. D.L. van Caekenberghe and S.R. Pattyn, *J. Antimicrob. Chemother.*, 19 (1987) 404.
42. M.H. Munshi, K. Haider, M.M. Rahaman, D.A. Sack, Z.U. Ahmed and M.G. Morshed, *Lancet*, ii (1987) 419.
43. For reviews, see refs. 5-7, and references therein.
44. S.R. Crider, S.D. Colby, L.K. Miller, W.O. Harrison, S.B.J. Kerbs and S.W. Berg, *N. Engl. J. Med.*, 311 (1984) 137.
45. P. Dellamonica, E. Bernard, H. Etesse and R. Garraffo, *J. Antimicrob. Chemother.*, 17 (1986) Suppl. B.93.
46. B. Holmes, R. Brogden and D. Richards, *Drugs*, 30 (1985) 482.
47. M. Tsukamura, E. Nakamura, S. Yoshii and H. Amano, *Am. Rev. Resp. Dis.*, 131 (1985) 352.
48. (a) D.J. Winston, W.G. Ho, R.E. Champlin, J. Karp, J. Bartlett, R.S. Finley, J.H. Joshi, G. Talbot, L. Levitt, S. Deresinski and M. Corrado, *Am. J. Med.*, 82 (1987) Suppl. 6B; (b) A.W. Dekker, M. Rozenberg-Arska and J. Verhoef, *Ann. Intern. Med.*, 106 (1987) 7.
49. A.G. Pernet, personal communication.
50. P.C. Johnson, C.D. Ericsson, D.R. Morgan, H.L. Dupont and F.J. Cabada, *Antimicrob. Agents Chemother.*, 30 (1986) 671.
51. B. Drumm, P. Sherman, E. Cutz and M. Karmali, *N. Engl. J. Med.*, 316 (1987) 1557.
52. Y. Glupczynski, M. Labbe, A. Burette, M. Delmee, V. Avesani and C. Bruck, *Lancet*, i (1987) 1096.
53. E. Bayerdorffer, G. Kasper, T. Pirllet, A. Sommer and R. Ottenjann, *Dtsch. Med. Wochenschr.*, 112 (1987) 1407 in ref. 5(d).
54. (a) H. Halkin, *Rev. Infect. Dis.*, 10 (1988) Suppl. 1 S25B; (b) B.R. Meyers, *Am. J. Med.*, 79 (1985) Suppl. 2A 96.
55. *Drugs of the Future*, 11 (1986) 578.
56. (a) H. Tatsumi, H. Senda, S. Yatera, Y. Takemoto, M. Yamayoshi and K. Ohnishi, *J. Toxicol. Sci.*, 3 (1978) 357; (b) A. Gough, N.J. Barsoum, L. Mitchell, E.J. McGuire and F.A. de la Iglesia, *Toxicol. Appl. Pharmacol.*, 51 (1979) 177; (c) H. Bouissou, D. Caujolle, P. Dhermy and J. Meynier, *J. Fr. Ophtalmol.*, 3 (1980) 607, in ref. 5(a).
57. M. Chevais, P. Reinert, M.C. Rondeau, R. Tobelem, E. Albengres, P. Riant and J.P. Tillement, *Intl. J. Clin. Pharmacol. Ther. Toxicol.*, 25 (1987) 306.
58. For example, see (a) W.J.A. Wijnands, T.B. Vree and C.L.A. van Herwaarden, *Br. J. Clin. Pharm.*, 20 (1985) 583; (b) F.P.V. Maesen, J.P. Teengs, C. Baur and B.I. Davies, *Lancet* ii (1984) 530.

59. G. Schlüter, *Am. J. Med.*, 82 (1987) Suppl. 4A 91.
60. P. Ball, *J. Antimicrob. Chemother.*, 18 (1986) Suppl. D 187.
61. G. Arcieri, R. August, N. Becker, C. Doyle, E. Griffith, G. Gruenwaldt, *et al.*, *Eur. J. Clin. Microbiol.*, 5 (1986) 220, in ref. 60.
62. C.R. Smith, *J. Antimicrob. Chemother.*, 19 (1987) 709.
63. C.A. McQueen and G.M. Williams, *Am. J. Med.*, 82 (1987) Suppl. 4A 94.
64. (a) H.C. Neu, *J. Infect. Dis.*, 155 (1987) 403; (b) H.C. Neu, *Lancet*, ii (1987) 1319.
65. H. Koga, A. Itoh, S. Murayama, S. Suzue and T. Irikura, *J. Med. Chem.*, 23 (1980) 1358.
66. Y. Goueffon, G. Montay, F. Roquet and M. Pesson, *C.R. Hebd. Seances Acad. Sci., Ser. 2*, 292 (1981) 37, in ref. 112.
67. J.-I. Matsumoto, T. Miyamoto, A. Minamida, Y. Nishimura, H. Egawa and H. Nishimura, *J. Med. Chem.*, 27 (1984) 292.
68. (a) S. Minami, T. Shono and J.-I. Matsumoto, *J. Chem. Pharm. Bull.*, 19 (1971) 1426; (b) J.-I. Matsumoto and S. Minami, *J. Med. Chem.*, 18 (1975) 74.
69. M.P. Wentland, D.M. Bailey, J.B. Cornett, R.A. Dobson, R.G. Powles and R.B. Wagner, *J. Med. Chem.*, 27 (1984) 1103.
70. C. Hansch and A. Leo, *Substituent Constants for Correlation Analysis in Chemistry and Biology*, (Wiley-Interscience, New York; 1978) pp. 49–51.
71. H. Agui, T. Mitani, A. Izawa, T. Komatsu and T. Nakagome, *J. Med. Chem.*, 20 (1977) 791.
72. K. Sato, Y. Matsuura, M. Inoue, T. Une, Y. Osada, H. Ogawa and S. Mitsuhashi, *Antimicrob. Agents Chemother.*, 22 (1982) 548.
73. H. Egawa, T. Miyamoto, A. Minamida, Y. Nishimura, H. Okada, H. Uno and J.-I. Matsumoto, *J. Med. Chem.*, 27 (1984) 1543.
74. D.T.W. Chu, P.B. Fernandes, A.K. Claiborne, E. Pihuleac, C.W. Nordeen, R.E. Maleczka, Jr. and A.G. Pernet, *J. Med. Chem.*, 28 (1985) 1558.
75. D.T.W. Chu, P.B. Fernandes, A.K. Claiborne, E.H. Gracey and A.G. Pernet, *J. Med. Chem.*, 29 (1986) 2363.
76. J.M. Domagala, C.L. Heifetz, T.F. Mich and J.B. Nichols, *J. Med. Chem.*, 29 (1986) 445.
77. K. Kirai, M. Hosaka, Y. Oomori, S. Murayama, A. Ito, K. Takagi, T. Irikura and S. Mitsuhashi, *Abstracts of the 23rd ICAAC*, 658 (1983).
78. D.T.W. Chu, P.B. Fernandes, R.E. Maleczka, Jr., C.W. Nordeen and A.G. Pernet, *J. Med. Chem.*, 30 (1987) 504.
79. J.P. Sanchez, J.M. Domagala, S.E. Hagen, C.L. Heifetz, M.P. Hutt, J.B. Nichols and A.K. Trehan, *J. Med. Chem.*, 31 (1988) 983.
80. J.M. Domagala, C.L. Heifetz, M.P. Hutt, T.F. Mich, J.B. Nichols, M. Solomon and D.F. Worth, *J. Med. Chem.*, 31 (1988) 991.
81. (a) I. Hayakawa, S. Atarashi, S. Yokohama, M. Imamura, K.-I. Sakano and M. Furukawa, *Antimicrob. Agents Chemother.*, 29 (1986) 163; (b) L.A. Mitscher, P.N. Sharma, D.T.W. Chu, L.L. Shen and A.G. Pernet, *J. Med. Chem.*, 30 (1987) 2283; (c) M. Imamura, S. Shibamura, I. Hayakawa and Y. Osada, *Antimicrob. Agents Chemother.*, 31 (1987) 325; (d) O. Okazaki, T. Kurata and H. Tachizawa, *Xenobiotica*, 19 (1989) 419.
82. J.S. Wolfson, D.C. Hooper, E.Y. Ng, K.S. Souza, G.L. McHugh and M.N. Swartz, *Antimicrob. Agents Chemother.*, 31 (1987) 1861.
83. D. Bouzard, P. Di Cesare, M. Essiz, J.P. Jacquet, P. Remuzon, A. Weber, T. Oki and M. Masuyoshi, *J. Med. Chem.*, 32 (1989) 537.
84. C.S. Cooper, D.T.W. Chu, P.B. Fernandes, E. Pihuleac and A.G. Pernet, *Abstracts of the 25th ICAAC*, 130 (1985).

85. T. Rosen, D.T.W. Chu, I.M. Lico, P.B. Fernandes, K. Marsh, L.L. Shen, V.G. Cepa and A.G. Pernet, *J. Med. Chem.*, 31 (1988) 1598.
86. J.F. Gerster, S.R. Rohlfling, S.E. Pecore, R.M. Winandy, R.M. Stern, J.E. Landmesser, R.A. Olsen and W.B. Gleason, *J. Med. Chem.*, 30 (1987) 839.
87. M.R. Jefson, P.R. McGuirk, A.E. Girard, T.D. Gootz and J.F. Barrett, Abstracts of the 29th ICAAC, submitted (1989).
88. S. Atarashi, S. Yokohama, K.-I. Yamazaki, K.-I. Sakano, M. Imamura and I. Hayakawa, *Chem. Pharm. Bull.*, 35 (1987) 1896.
89. (a) N.H. Georgopapadakou, B.A. Dix, P. Angehrn, A. Wick and G.L. Olson, Abstracts of the 25th ICAAC, 129 (1985); (b) N.H. Georgopapadakou, B.A. Dix, P. Angehrn, A. Wick and G.L. Olson, *Antimicrob. Agents Chemother.*, 31 (1987) 614.
90. T.P. Culbertson, J.M. Domagala, J.B. Nichols, S. Priebe and R.W. Skeeane, *J. Med. Chem.*, 30 (1987) 1715.
91. T. Rosen, D.T.W. Chu, I.M. Lico, P.B. Fernandes, L.L. Shen, S. Borodkin and A.G. Pernet, *J. Med. Chem.*, 31 (1988) 1586.
92. D.T.W. Chu, P.B. Fernandes, A.K. Claiborne, R.E. Maleczka, P. Klock, L.L. Shen, J. Patel and A.G. Pernet, Abstracts of the 26th ICAAC, 428 (1986).
93. T. Uno, K. Iuchi, Y. Kawahata and G. Tsukamoto, *J. Heterocycl. Chem.*, 24 (1987) 1025.
94. L.A. Mitscher, P.N. Sharma, D.T.W. Chu, L.L. Shen and A.G. Pernet, *J. Med. Chem.*, 29 (1986) 2044.
95. M.P. Wentland, R.B. Perni, P.H. Dorff and J.B. Rake, *J. Med. Chem.*, 31 (1988) 1694.
96. D.T.W. Chu, P.B. Fernandes and A.G. Pernet, *J. Med. Chem.*, 29 (1986) 1531.
97. S. Matsumura, M. Kise, M. Ozaki, S. Tada, K. Kazuno, H. Watanabe, K. Kunitomo and M. Tsuda, *U.S. Patent* 4, 426, 381 (1984); *Eur. Pat. Appl. EP* 58392; *Chem. Abstr.*, 98 (1983) 53877.
98. V. Cecchetti, A. Fravolini, R. Fringuelli, G. Mascellani, P. Pagella, M. Palmioli, G. Segre and P. Terni, *J. Med. Chem.*, 30 (1987) 465.
99. I. Hayakawa, T. Hiramitsu and Y. Tanaka, *Chem. Pharm. Bull.*, 32 (1984) 4907.
100. P.M. Carabateas, R.P. Brundage, K.O. Gelotte, M.D. Gruett, R.R. Lorenz, C.J. Opalka, Jr., B. Singh, W.H. Thielking, G.L. Williams and G.Y. Leshner, *J. Heterocycl. Chem.*, 21 (1984) 1857.
101. Y. Nishimura and J.-I. Matsumoto, *J. Med. Chem.*, 30 (1987) 1622.
102. T. Uno, M. Takamatsu, Y. Inoue, Y. Kawahata, K. Iuchi and G. Tsukamoto, *J. Med. Chem.*, 30 (1987) 2163.
103. J.M. Domagala, S.E. Hagen, C.L. Heifetz, M.P. Hutt, T.F. Mich, J.P. Sanchez and A.K. Trehan, *J. Med. Chem.*, 31 (1988) 506.
104. K. Grohe, U. Petersen, H.J. Zeiler and K.G. Metzger, *U.S. Patent* 4, 556, 658 (1985); *Ger. Offen. DE* 3318145; *Chem. Abstr.*, 102 (1985) 78744.
105. P.R. McGuirk, M.R. Jefson, D.D. Mann, M.S. Hindahl, C.P. Cornell and F.H. Weber, Abstracts of the 29th ICAAC, 1186 (1989).
106. P.R. McGuirk, M.R. Jefson, T.R. Shryock and T.K. Schaaf, Abstracts of the 29th ICAAC, 1187 (1989).
107. G.M. Frame, D.D. Mann and M.J. Lynch, Abstracts of the 29th ICAAC, 1188 (1989).
108. D.D. Mann, Abstracts of the 29th ICAAC, 1189 (1989).
109. F. Sakamoto, S. Ikeda, H. Kondo and G. Tsukamoto, *Chem. Pharm. Bull.*, 33 (1985) 4870.

110. H. Kondo, F. Sakamoto, T. Uno, Y. Kawahata and G. Tsukamoto, *J. Med. Chem.*, 32 (1989) 671.
111. H. Kondo, F. Sakamoto, Y. Koderu and G. Tsukamoto, *J. Med. Chem.*, 29 (1986) 2020.
112. H. Kondo, F. Sakamoto, K. Kawakami and G. Tsukamoto, *J. Med. Chem.*, 31 (1988) 221.
113. D.T.W. Chu, P.B. Fernandes, A.K. Claiborne, L.L. Shen and A.G. Pernet, Abstracts of the 27th ICAAC, 250 (1987).

This Page Intentionally Left Blank

7 Developments in the Antiemetic Area: Chemistry, Pharmacology and Therapy

I. MONKOVIĆ, Ph.D.¹ and J.A. GYLYS, Ph.D.²

¹*Anti-Tumor Chemistry*, ²*CNS Biology, Bristol-Myers Squibb Company, Pharmaceutical Research and Development Division, Wallingford, CT 06492-7660, U.S.A.*

INTRODUCTION	298
MEDICINAL CHEMICAL DEVELOPMENTS	298
Modification of 2-substituent of benzamides	299
Modification of the basic side-chain and aromatic substitution	302
Nonbenzamide antiemetics	304
NEUROPHARMACOLOGY OF EMESIS	306
Vomiting among animal species	307
Somatic and autonomic efferent output	307
Afferent input	307
Area postrema	308
Role of area postrema and afferent input	309
Vomiting centre and functional considerations	309
5-HT MECHANISMS IN EMESIS	310
Role of D ₂ -dopamine and 5-HT ₃ mechanisms	310
Function and localization of 5-HT ₃ receptors	311
5-HT ₃ receptor affinity, inhibition of Bezold-Jarisch reflex and antiemetic action	312
5-HT ₃ agonists and emesis	313
Site of action of 5-HT ₃ antagonists	313
Role of endogenous 5-HT	314
Gastroprokinetic effect and antiemetic action	314
TREATMENT OF CANCER-CHEMOTHERAPY-INDUCED EMESIS	315
Cannabinoids	316
Phenothiazines and butyrophenones	316
Domperidone	317
Metoclopramide	317
Corticosteroids	317
Benzodiazepines	317
5-HT ₃ antagonists	318

ACKNOWLEDGEMENTS	319
ADDENDUM	319
REFERENCES	319

INTRODUCTION

Aggressive cancer chemotherapy and associated severe nausea and emesis have created an urgent need for more effective antiemetic agents, as standard treatment based on phenothazines or metoclopramide (low dose) has proved to be inadequate. Consequently, research efforts have been initiated particularly in the area of benzamides, to improve potency and selectivity of metoclopramide. These efforts lead to the observation that dopamine D_2 receptor antagonism, common to both phenothiazines and benzamides, does not provide significant protection against cytotoxic drug-induced emesis in laboratory animals. In clinical investigations, high-dose metoclopramide demonstrated superior protection from emesis compared with more potent dopamine D_2 antagonists. Thus, these findings strongly implicated the existence of an alternative mechanism by which metoclopramide controls emesis.

An important advance in this field has been made by the discovery of selective serotonin ($5-HT_3$) receptor antagonists that are effective inhibitors of cytotoxic drug-induced emesis in laboratory animals. The new agents have been found to be free of the undesirable side-effects associated with dopaminergic blockade and have shown significant protection from emesis in early clinical trials.

The present review covers progress in medical chemistry, basic mechanisms of emesis, role of serotonergic mechanism, and treatment of cancer-chemotherapy-induced emesis.

MEDICINAL CHEMICAL DEVELOPMENTS

Most of the antiemetic clinical trials in the last decade have involved metoclopramide (1) either as a single agent or in combination with other drugs. Similarly, most of the chemical modification studies have been designed to optimize antiemetic and/or gastroprokinetic properties of metoclopramide and to eliminate undesirable CNS side-effects which are the consequence of its dopamine D_2 receptor blockade [1-3].

MODIFICATION OF 2-SUBSTITUENT OF BENZAMIDES

Early investigations in our own laboratories in the metoclopramide area indicated that the dopaminergic D₂ antagonist activity was highly dependent upon 2-substituent on the aromatic ring [4]. Replacement of the OMe group with a variety of β -functionalized substituents via reaction sequence shown in *Scheme 7.1* resulted in a loss of dopamine D₂-antagonist activity both *in vitro*

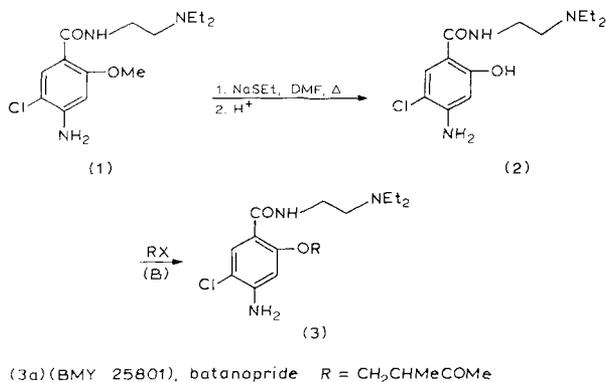

Scheme 7.1

([³H]spiperone binding test) and *in vivo* (catalepsy induction, and antagonism of apomorphine-induced stereotypy in rats; antagonism of apomorphine-induced emesis in dogs). On the other hand, antagonism of cisplatin-induced emesis in the dog and ferret was retained. Several representative β -keto, β -hydroxy and β -methoxy analogues are shown in *Table 7.1*.

In general, ketones, alcohols and ethers of formula (3) showed comparable protection against cisplatin-induced emesis in the dog and ferret with that of metoclopramide. Erythro (*cis*) alcohols (3c, 3g, 3i) were found to be more potent than the corresponding *threo*-(*trans*) isomers (3d, 3h, 3j). Optical isomer (*R*) (3e) was found to be somewhat more potent than its (*S*)-enantiomer (3f) as an antagonist of cisplatin-induced emesis in the ferret. In the dog, both isomers showed similar activity. A number of heterocyclic analogues were also studied but with the exception of (3k), all were inferior in potency as antiemetic agents compared with other compounds (3) shown in *Table 7.1*. Lead compound, BMY 25801, batanopride, (3a) is presently under clinical investigation.

Whereas modification of the 2-substituent of metoclopramide was fruitful, similar modification of 2-substituent of alizapride (4a) [5] was not, as illustrated

Table 7.1. ANTAGONISM OF CISPLATIN-INDUCED EMESIS BY 2-SUBSTITUTED ANALOGUES (3) OF METOCLOPRAMIDE

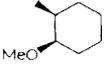
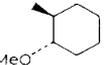
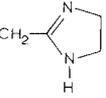
R	Dog		Ferret	
	mg/kg, s.c., × 2	% protection	mg/kg, i.v., × 2	% protection
3a CHMeCOME	1	96	0.3	90
3b 	1	100	0.3	62
3c $\begin{array}{c} \text{CHMeCHMe} \\ \\ \text{OH} \end{array}$ <i>erythro</i>	1	100	1	82
3d $\begin{array}{c} \text{CHMeCHMe} \\ \\ \text{OH} \end{array}$ <i>threo</i>	1	75	1	68
3e $\begin{array}{c} (R)\text{-CH}_2\text{CHMe} \\ \\ \text{OH} \end{array}$	1	92	1	73
3f $\begin{array}{c} (S)\text{-CH}_2\text{CHMe} \\ \\ \text{OH} \end{array}$	1	100	1	22
3g 	1	100	3	64
3h 	1	66	3	60
3i 	1	100	0.3	77
3j 	1	15	1	69
3k 	1	88	3	86
Metoclopramide	2.5	92	2.5	90

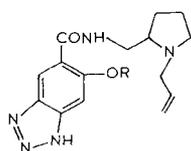

(4a) R = Me

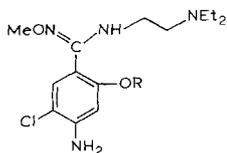
(4b) R = CH₂CHMeCOMe

(5)

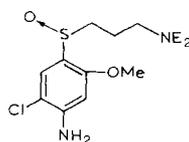

(6)

by (4b), which was virtually inactive as antiemetic in the ferret. Alizapride was also inactive in the same test and clinically less effective than metoclopramide [3]. Similarly potential amide isomers (5), (6), substituted amide (7) and cyclic analogues, in which 2-oxygen atom is bridged to amide nitrogen (8), (9) or basic nitrogen atom (10a), (10b), displayed low to moderate activity in the ferret; none was considered to represent a significant lead. Similar results were obtained by cyclization of (3a) to give benzofuran analogue (11).

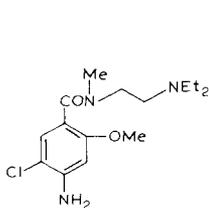

(7)

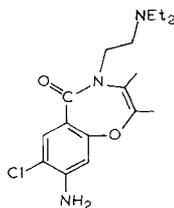

(8)

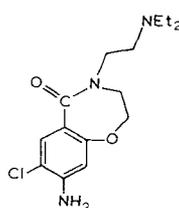

(9)

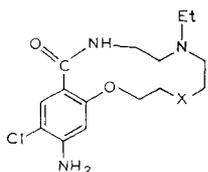
(10a) X = CH₂

(10b) X = O

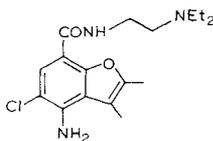

(11)

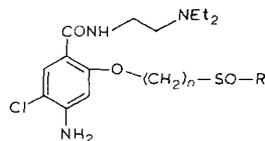

(12)

Replacement of 2-OMe group with alkylsulphonylalkyl substituents as illustrated by general formula (12) also resulted in a loss of dopamine D₂ antagonist activity [6]. However, enhancement of gastro-intestinal motility was retained. The synthesis of a lead compound, BMY 25989 (14) is depicted in *Scheme 7.2*. In pharmacological tests BMY 25989 was shown to be devoid of dopamine D₂-receptor antagonist activity and free of CNS side-effects. BMY 25989 was relatively ineffective as antagonist of cisplatin-induced emesis in the ferret [6]. In assays for gastroprokinetic activity (field-stimulated guinea-pig ileum con-

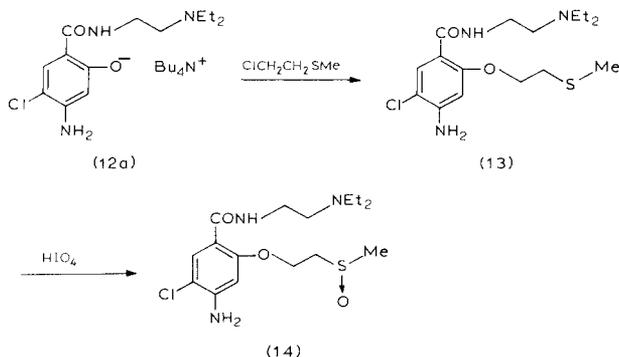

Scheme 7.2

tractions and rat stomach emptying), BMY 25989 was comparable with metoclopramide, cisapride and BRL 20627. Developments in the gastroprokinetic field have been reviewed recently [7].

MODIFICATION OF THE BASIC SIDE-CHAIN AND AROMATIC SUBSTITUTION

Modification of the basic side-chain of metoclopramide has been the subject of numerous investigations. Earlier work led to the synthesis of YM 09151-2 (15a) [8], clebopride (15b) [9], dazopride (15c) [10] and cisapride (15d) [11]. Modification of the basic side-chain and aromatic ring substitution led to the synthesis of alizapride (4a) [5], sulpiride (16a) [12] and cinitapride (16b) [13]. Although a number of analogues have found clinical use for various indications,

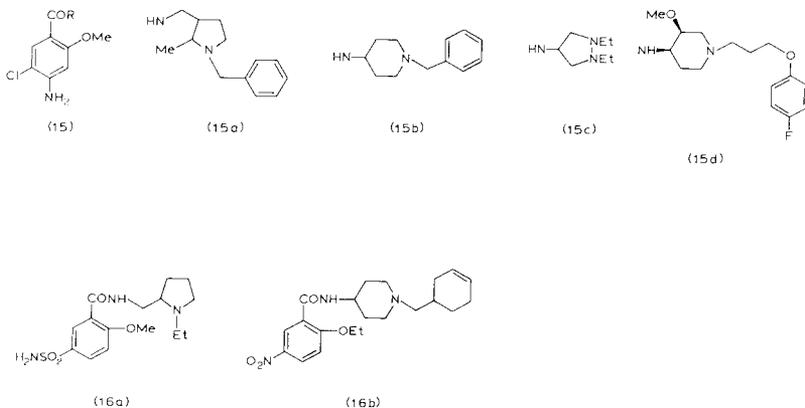

primarily enhancement of gastrointestinal motility, none have been found to be equal to metoclopramide as an antagonist of chemotherapy-induced emesis.

More recently, in a study designed to investigate a conformationally restricted side-chain of metoclopramide, a number of quinolizidine analogues (21) were synthesized as depicted in *Scheme 7.3* [14]. In total, eight isomers were screened for gastroprokinetic and dopamine D₂ receptor antagonist activity. Only compounds with the benzamide moiety at position 2 of the quinolizidine ring (BRL 20627 (21a) and (21b)) retained gastroprokinetic activity.

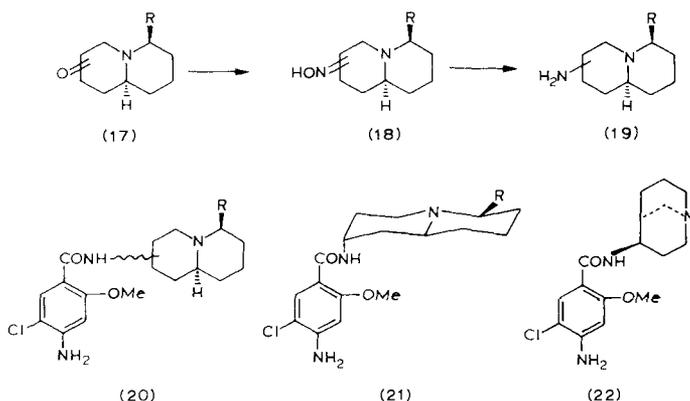

Scheme 7.3 a, R = Me; b, R = H

Spectroscopic evidence was used to assign conformation of the quinolizidine ring in (21a) and (21b) as *trans chair-chair* with a benzamide group in an axial orientation. This line of research has been extended to the 4-amino-9-methyl-9-azabicyclo[3.3.1]nonane system to give BRL 24924 (22) [15], a more restricted analogue of metoclopramide and more potent gastroprokinetic agent [16]. This approach culminated in the synthesis of zacopride (23) [17] which is a bicyclic analogue of metoclopramide with restricted freedom of nitrogen to invert.

Another approach combined modification of the 2-substituent yielding dihydrobenzofuran and pyrrolidinemethyl side-chain with unsubstituted (secondary) nitrogen to give ADR 851 (24) and ADR 847 (25) [18]. Both were reported to be somewhat more effective than metoclopramide as antagonists of cisplatin-induced emesis in the dog. In addition, ADR 847 enhanced gastric emptying [19].

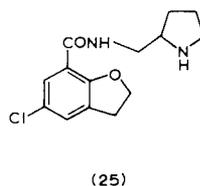
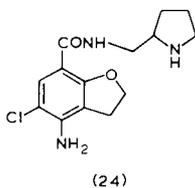
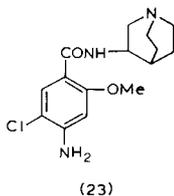

NONBENZAMIDE ANTIEMETICS

Parallel with the developments in the benzamide area, progress was also made in several nonbenzamide series of compounds. MDL 72222 (26) [20], a tropane ester of 3,5-dichlorobenzoic acid, was the first selective 5-HT₃ receptor antagonist and a potent antagonist of cisplatin-induced emesis in the ferret [21]. ICS 205-930 (27) [22, 23], the tropane ester of 3-indolecarboxylic acid, exhibited similar pharmacological and antiemetic profiles.

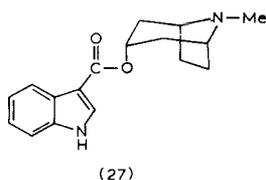
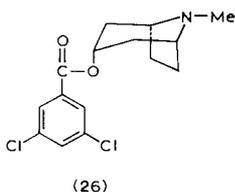

A number of potent 5-HT₃ receptor antagonists has been reported (test used: Bezold–Jarisch reflex) in the indazole series as indicated in *Scheme 7.4* [24]. Indazole-3-carboxylic acid (28) was esterified with tropane to give ester (29a), and condensed with 3 α -tropyamine to give the corresponding amide (29b). Alternatively, *N*-methyl analogues were synthesized via a three-step reaction sequence, that is, exhaustive methylation of (28) to give a mixture of the corresponding methyl esters of the 1- and 2-methylindazole-3-carboxylic acids. The esters were separated by chromatography, hydrolyzed and condensed with 3 α -tropyamine to give (30) and (31), respectively. The regiochemistry of *N*-methyl groups was determined by spectroscopy and confirmed by X-ray crystallographic analysis of the final products (30) and (31).

Compounds (29) and (30) were found to be comparable in potency to (27) as 5-HT₃ receptor antagonists; analogue (31) was substantially less potent. The loss of activity found with (31) was attributed to steric interactions of the *N*-methyl group and amide NH as well as the ethylene bridge of the tropane

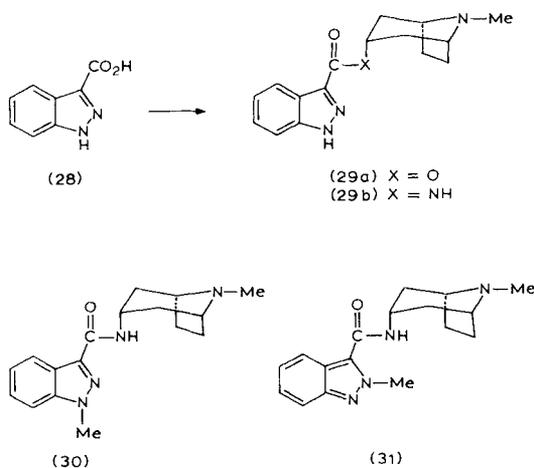

Scheme 7.4

ring system. Examination of X-ray structures showed that (30) in the solid-state adopts the extended conformation, whereas (31) adopts the folded conformation. The extended conformation of (31) is precluded by the above-mentioned steric interactions.

In the 1-methylindazole series the synthesis of a potent 5-HT₃ receptor antagonist BRL-43694, granisetron, (32) has also been reported [25, 26].

Further divergence from classical benzamide structure is represented by the synthesis of ondansetron (GRF 38032F, (33)), a potent 5-HT₃ receptor antagonist where the basic nitrogen atom is part of an imidazole ring and the aromatic ring is part of tetrahydrocarbazolone ring system [27].

The indole analogue GR 65630 (34) has been used as a radioactive ligand in studies of binding of various 5-HT₃ receptor agonists and antagonists [28].

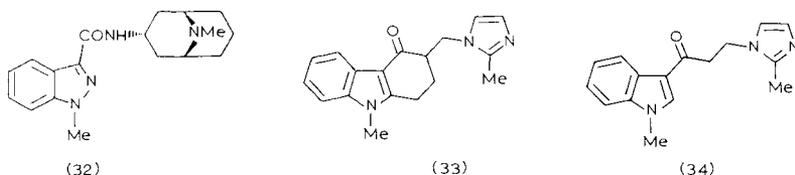

NEUROPHARMACOLOGY OF EMESIS

The classical review by Borison and Wang [29] on the neuropharmacology and neurophysiology of vomiting stands out even after 30 years. Recent comprehensive reviews add to the continuous in-depth coverage of this area [30, 31].

Prior to the advent of 5-HT₃ antagonists, Borison and McCarthy [32] suggested a multifactorial etiology of emesis involving endogenous opioid peptides and neurotransmitters, as originally proposed by Peroutka and Snyder [33]. The distribution of classical and putative neurotransmitters in the dorsal vagal complex of the medulla oblongata, an area closely associated with emesis, has been reviewed [34]. However, the unique effectiveness of 5-HT₃ antagonists as antiemetics focused attention on 5-HT mechanisms [35].

The reader is referred to comprehensive reviews and monographs on the subject matter: neuroanatomy and functions of the area postrema [36], nausea and vomiting mechanisms and treatment [37] and a recent multidisciplinary symposium on vomiting [38].

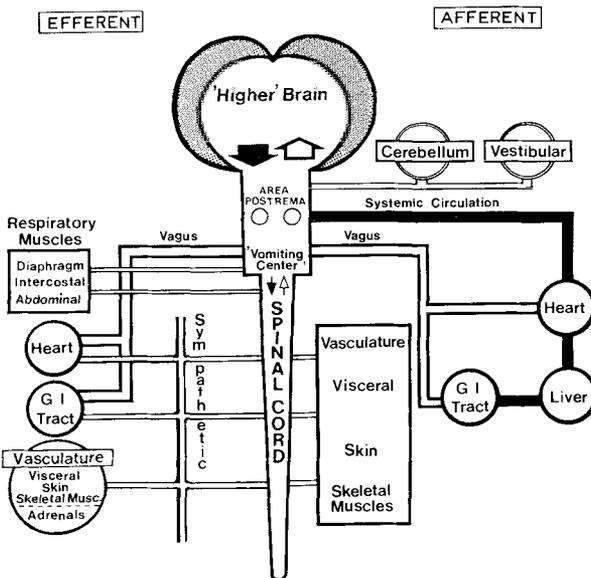

Figure 7.1. Vomiting Mechanisms. The afferent nervous (peripheral and central) and humoral inputs converge to the medullary area. Here the signals are examined and integrated and may lead to emesis (expulsion of gastrointestinal contents). The efferent output involves respiratory muscles, visceral organs, cardiovascular system, visceral and cutaneous vasculature. The endogenous factors are released into the systemic circulation.

VOMITING AMONG ANIMAL SPECIES

Vomiting is a protective reflex of high complexity and integration involving autonomic and somatic nervous system components which results in an ejection of the gastrointestinal (GI) contents. This reflex is widely distributed among animals, including some insectivores [39], but absent in laboratory rodents [40].

There are marked species differences in susceptibility to specific emetogens. For example, dog and man are very sensitive to apomorphine [40], while the rhesus monkey is completely resistant [41]. The ferret exhibits intermediate sensitivity to apomorphine, but there may be some controversy regarding this species [42–44]. On the other hand, the ferret shows high sensitivity to radiation-induced emesis [44] followed by dog, man, monkey and cat. The cat in general is more resistant to apomorphine and radiation-induced emesis than dog or man [40, 45].

The following discussion deals with basic mechanisms involved in the vomiting reflex and *Figure 7.1* represents a simplified diagram of this complex response.

SOMATIC AND AUTONOMIC EFFERENT OUTPUT

Vomiting is a predominant somatic event involving thoracic and abdominal skeletal muscles [46–48] which create pressure gradients affecting the GI tract and its motility patterns, leading to ejection of GI contents. This should not imply that the GI tract plays a passive role, merely responding to pressure changes created by skeletal muscles. In fact, there are numerous functional electrophysiological and motility correlates (pauses, retroperistalsis) exhibited by enteric smooth muscle which are mediated by the vagus nerve, intrinsic myoneural plexi, and humoral factors [49–51]. In addition, there are significant vagal and sympathetic outputs affecting cardiovascular responses (heart rate, blood pressure, cutaneous vascular resistance).

AFFERENT INPUT

The abdominal vagus and sympathetic nerves are the most important afferent inputs involved in vomiting induced by chemotherapy and radiation [31]. The input from vestibular nerves and the cerebellum plays an important role in the motion disease [52]. The afferent inputs from vagal, trigeminal and glossopharyngeal nerves terminate eventually in the nucleus solitarius tract located in the medulla oblongata which has neuronal connections with other medullary areas involved in emesis, for example, area postrema [53].

AREA POSTREMA

In view of the universal role of the area postrema (AP) in emesis among animal species, including man [54], an analysis of this structure in terms of receptors, neurotransmitters and neurophysiological responses is indicated. The AP has also been implicated in several other functions (cardiovascular, caloric intake, osmotic water balance) unrelated to emesis [55]. The reader is referred to general and comprehensive references on this neuronal structure [36, 37, 56].

Neuroanatomy. It is a circumventricular organ resting bilaterally on the floor of the caudal end of the IV ventricle. It is highly vascular, with ependymal and neuronal components interfaced, thus uniquely fitted to monitor humoral, cerebrospinal and subarachnoid fluids [57]. Structurally and functionally, the AP is located outside the blood-brain barrier. The main neuronal afferents are vagal, glossopharyngeal, trigeminal nerves, dorsal hypothalamus and possible inputs from cortical and vestibular sites [53]. The neuronal efferents lead to the parabrachial nuclei, trigeminal sites, nucleus tractus solitarius and dorsal vagal nucleus.

Neurochemistry. Recent studies on the AP have revealed recognition sites for several receptors: D₂ [58, 59], muscarinic, enkephalin [59] and 5-HT₃ [60, 61]. It is noteworthy that the AP had the highest density of 5-HT₃ receptors by a factor 30 or greater in comparison with other brain sites. On the other hand, the AP had negligible levels of H₁ receptors, although histamine and L-histidine decarboxylase were readily detectable [59]. There were several other neurochemical markers: catecholaminergic, gabaergic, opioid, serotonergic and substance P [59,62].

Neurophysiology. Neuronal responses to a variety of endogenous substances administered electrophoretically to the AP were recorded in the anaesthetized dog [63]. Normally, these neurons are quiescent but they were activated by numerous neurotransmitters or substances (glutamate, 5-HT, norepinephrine, dopamine, apomorphine) and peptides (angiotensin II, neurotensin, TRH, VIP, gastrin, vasopressin, substance P, leucine-enkephalin). Only a few substances were inactive, for example, acetylcholine, somatostatin and cholecystokinin. In general, there was correlation between positive electrophysiological response in the area postrema and emetic liability of an agent when administered systemically. The ablation of AP eliminated emesis to apomorphine, neurotensin, leucine-enkephalin and angiotensin II. Thus, these results reveal a broad-spectrum sensitivity of this organ to endogenous substances. However, there might be species differences and procedural aspects which may limit assessment of the biological significance of these observations. It is noteworthy that 2-Me-5-HT administered directly onto the AP failed to induce emetic response in the ferret [64].

ROLE OF AREA POSTREMA AND AFFERENT INPUTS

The relative importance of these two functional systems can be readily demonstrated. For example, apomorphine-induced emesis was entirely dependent on the intact AP in the dog and cat, and was not affected even by removal of the GI tract. In contrast copper-sulphate-induced emesis was completely dependent on an intact abdominal vagus [29].

Sympathectomy and vagotomy alone or combined did not have any effect on radiation-induced emesis in dogs, while ablation of the AP abolished it [65–67]. On the other hand, a triple intervention (ablation of area postrema and nerve sectionings) was required to prevent delayed emesis [65]. The rhesus monkey was similar to the dog, that is, the radiation-induced emesis was prevented by ablation of the area postrema [41].

Ablation of AP did not prevent radiation-induced emesis in cats, while abdominal vagotomy did [68]. In contrast, the cisplatin-induced emesis required the intact AP in the same species [69].

Abdominal vagotomy antagonized radiation-induced prodromal emesis without having any effect on delayed emesis in ferrets [70]. In the same species, a combination of vagotomy and sympathectomy abolished cisplatin or cyclophosphamide-induced emesis. Sympathectomy alone had no significant effect, while vagotomy prevented vomiting but facilitated retching [71]. There are no reports on the AP ablation and incidence of emesis in the ferret.

Thus, there are significant differences among species in terms of relative sensitivity to specific emetogens and functional roles of the AP and afferent vagus in emetic process. It is safe to conclude that the vagal input plays a definite modulating role; however, it is not a necessary condition because vomiting (retching) can occur even after removal of GI tract [29]. It is obvious that all these factors may contribute to difficulties in selection of proper experimental animal model, and extrapolation of results to other animal species or proposing of unifying mechanism of emesis.

VOMITING CENTRE AND FUNCTIONAL CONSIDERATIONS

The existence of anatomically defined vomiting centre has been discussed. Borison and Wang [72] induced emesis in cats from sites located in the dorsolateral medulla closely associated with the AP and inspiratory centre. Miller and Wilson [73] did not reproduce these observations and questioned the existence of a vomiting centre. In fact, the site from which emesis can be induced should not be readily equated with the vomiting centre. For example, projectile vomiting could be induced by stimulation of the forebrain, which has

neuroconnections with the parvicellular reticular formation (PCRF) [52]. It was concluded that the PCRF is an important structural substrate for the vomiting reflex because of the proximity and neuronal connections to visceral pathways involved in emesis without commitment to the concept of a vomiting centre.

The control of such a complex phenomenon as emesis cannot be explained in terms of 'central black box' but might rather be envisioned as the expression of the integrated activity of the numerous nuclei which ordinarily serve the separate functions of the phenomena in question, that is, vomiting [45]. The existence of the vomiting centre remains to be demonstrated unequivocally by the means of electrical stimulation, which in turn results in vomiting accompanied by all the other signs. Alternatively, the sequential activating model assumes that various physiological components are activated in temporal sequential fashion without necessarily leading to emesis. Only when summation of these individual events exceeds threshold does vomiting result [45].

5-HT MECHANISMS IN EMESIS

This discussion will be limited to the neural serotonin 5-HT₃ receptors which came to the forefront with the advent of antiemetic agents exhibiting 5-HT₃ antagonist properties. At the present time, there is no evidence that 5-HT₁ and 5-HT₂ receptors play an important role in vomiting [64].

The biochemistry and pharmacology of 5-HT receptors have been reviewed [74], therapeutic implications presented [75, 76], and functional classification proposed [77]. Recently, the neuroanatomy, physiology and pharmacology of 5-HT₃ receptors have been reviewed [78]. It is evident that major advances have been made since the Gaddum and Picarelli proposal to subdivide 5-HT receptors into 'D' (dibenzylamine sensitive) and 'M' (morphine sensitive) types [79]. Subsequently, the 'D' and 'M' receptors have been identified as 5-HT₂ and 5-HT₃ type, respectively.

ROLE OF D₂-DOPAMINE AND 5-HT₃ MECHANISMS

Metoclopramide, administered at doses higher than those required to inhibit apomorphine-induced emesis, was more effective than haloperidol in antagonizing cisplatin-induced emesis in dogs [80]. This was observed despite the fact that metoclopramide was considerably weaker than haloperidol as a D₂-dopamine antagonist [43]. Subsequently, antiemetic efficacy of metoclopramide administered at high doses has been reported in cancer patients

Table 7.2. RELATIONSHIP BETWEEN 5-HT₃ RECEPTOR AFFINITY AND *IN VIVO* FUNCTIONAL TESTS

<i>Compound</i>	<i>5-HT₃ receptor affinity</i> <i>K_i, nM</i>	<i>B-J reflex</i> <i>(μg/kg) i.v.^a</i>	<i>Antiemetic activity</i> <i>appr. ED 90 μg/kg, i.v.^b</i>
GR 65630	1.4 [93]	–	100 [64]
BRL 43694, granisetron	2.7 [93]	0.7 [26]	50 [102]
ICS 205-930	2.0 [93]	0.4 [99]	100 [103]
<i>Zacopride</i>	2.0 [93]	0.1 [99]	28 [17]
GR 38032F, ondansetron	4.8 [93]	0.4 [100]	100 [104]
MDL 72222	55.0 [28]	42.0 [99]	1000 [64]
Metoclopramide	326.0 [93]	390.0 [43]	2500 [43]
BRL 24924	8.1 [98]	3.7 [101]	1500 [83]
BMY 25801, batanopride	241.0 ^c	70.0 [43]	1000 [43]

^a Inhibition of Bezold–Jarisch reflex in rats.

^b Antagonism of cisplatin-induced emesis in ferrets and dogs.

^c L.M. Pinkus, personal communication.

receiving cisplatin [81], while the clinical efficacy of D₂-dopamine antagonists in this area remains to be established. In general, the latter agents were either inactive or marginally effective against cisplatin or radiation-induced emesis in laboratory animals [43, 82, 83] in contrast to the high efficacy observed with 5-HT₃ antagonists (*Table 7.2*). Thus, these findings strongly suggest that presence of D₂-dopaminergic blocking properties is not essential for antagonism of emesis induced by cancer chemotherapeutic agents or radiation.

FUNCTION AND LOCALIZATION OF 5-HT₃ RECEPTORS

Functionally and anatomically 5-HT₃ receptors are associated with peripheral neuronal structures such as the vagal nerve, nodose ganglion, superior cervical ganglion, sympathetic nerves and enteric nerves [77]. Recently, they have been identified in hippocampal cells where they may function in membrane conductance [84]. They function in nerve depolarization or impulse conduction, transmitter release and vagal sensory reception (for example, Bezold–Jarisch reflex). They also play a role in pain transmission in the spinal cord [85] or skin [22] or are involved in peripheral vasodilation [86]. They may function in reinforcement mechanisms for morphine or nicotine [87] or processes underlying anxiety. For example, GR 38032F was found to be active in selected laboratory anxiolytic tests [88]. Originally, metoclopramide [89], MDL 72222 [20] and ICS 205-930 [22] were described as functional antagonists of 5-HT₃

receptors in periphery and 2-Me-5HT was identified as a selective 5-HT₃ agonist [22].

There was a time lapse between functional description and identification of 5-HT₃ recognition sites in the brain. It should be mentioned that 5-HT₃ antagonists show high selectivity and affinity to the 5-HT₃ recognition sites with negligible affinity to other receptors. Almost simultaneously, 5-HT₃ receptors were identified in the neuroblastoma-glioma [90] and rat brain [28], respectively, using [³H]ICS 205-930 and [³H]GR 65630 as radioligands. High affinity and selective binding of [³H]quipazine [91], quaternized [³H]ICS 205-930 [92] and [³H]zacopride [93] were demonstrated in the rat cortex. The 5-HT₃ recognition sites have been identified in human brain (amygdala and hippocampus) using [³H]zacopride as a ligand [94]. However, Peroutka [95] failed to demonstrate any specific binding of [³H]quipazine in brain cortex of several animals (mouse, guinea-pig, dog, rabbit), including man. These negative results remain to be replicated employing different radioligands in view of positive finding in the man [94].

A directly proportional correlation has been reported [28] between 5-HT₃ binding and inhibition of 5-HT-induced nerve depolarization with selected compounds: BRL 43594, GR 65630, GR 38032F, quipazine, ICS 205-530, MDL 72222 and metoclopramide (listed in order of decreasing potency). Thus, a linkage between functional and receptor affinity has been established *in vitro*.

There were regional differences [28] in 5-HT₃ receptor densities in various brain areas: entorhinal, cortex, amygdala, frontal and cingulate cortex, hippocampus and nucleus accumbens (listed in order of decreasing density). Glaum and Anderson [96] identified 5-HT₃ binding in dorsal spinal cord. The 5-HT₃ receptors were visualized autoradiographically [97] in selected medullary areas (spinal tract of trigeminal nerve, vagal nuclei, nucleus solitarius) in the mouse. High density of 5-HT₃ receptors has been demonstrated in the area postrema in rats and ferrets and the right vagus in rats [60, 61]. The relative ligand binding in these structures was considerably higher than previously reported in the brain. Thus these observations indicate a close anatomical and possible functional relationship between 5-HT₃ recognition sites and medullary neuronal structures involved in emesis.

5-HT₃ RECEPTOR AFFINITY, INHIBITION OF BEZOLD-JARISCH REFLEX AND ANTIEMETIC ACTION

There was a direct correlation between 5-HT₃ receptor affinity and antagonism of 5-HT induced-depolarization of vagal nerve *in vitro* [28]. It is pertinent to examine a relationship between *in vitro* findings (5-HT₃ receptor affinity) and

in vivo functional tests: antagonism of 5-HT-induced Bezold–Jarisch (B–J) reflex and antiemetic activity. The literature results are summarized in *Table 7.2*.

In general, test compounds exhibited a similar rank order in antiemetic potency in several animal species (ferret, dog, cat) and there was a direct positive correlation between these three specific activities (*Table 7.2*) [105]. For example, BRL 43694, ICS 205-930, GR 38032F and zacopride were potent antiemetics, exhibited high activity in B–J reflex and had relatively high 5-HT₃ receptor affinity. Metoclopramide, which had the lowest binding affinity, was also least potent in other two tests. MDL 72222, a moderately active antiemetic, exhibited appropriate correlation between these three parameters. BMY 25801 showed the expected correlation between inhibition of B–J reflex and antiemetic activity and binding affinity. Interestingly, the high 5-HT₃ affinity and inhibition potency on B–J reflex observed with BRL 24624 did not carry over to antiemetic activity to the same degree as seen with other compounds.

Selected compounds were tested on radiation-induced emesis in ferrets or dogs and found to be active: metoclopramide and BMY 25801 [43], BRL 24924 [83], GR 38032F [104] and BRL 43694 [102,106].

5-HT₃ AGONISTS AND EMESIS

Despite the fact that 5-HT₃ antagonists are effective antiemetics, there is no positive evidence that 2-Me-5-HT, the specific 5-HT₃ agonist, is emetogenic. It failed to produce emesis (up to 0.2 mg/kg i.v.) in the dog and ferret [107]. Even direct intraventricular administration of this agent did not induce a well-defined emesis in the ferret [64]. Thus, exogenous 2-Me-5-HT was not emetogenic. On the other hand, 5-HT, which is a potent but not selective 5-HT₃ agonist, administered iontophoretically directly to the area postrema excited about 60% of neurons measured in the anaesthetized dog [63]. Thus, the biological significance of these observations and the functional relationship to emetic response remains unclear.

SITE OF ACTION OF 5-HT₃ ANTAGONISTS

There are a few reports on possible sites of action of 5-HT₃ antagonists. Low doses of zacopride administered directly into the fourth ventricle (i.c.v.) antagonized cisplatin (i.v.)-induced emesis in the cat [108]. A similar antagonism was demonstrated when routes of drug administration were interchanged. Similarly, GR 38032F, GR 65630 and MDL 72222, administered i.c.v. onto the area postrema at very low doses, antagonized cisplatin-induced

emesis in the ferret, while ketanserin and methiothepin were inactive [64]. Thus, these findings support a functional role of 5-HT₃ receptors in emetic mechanisms involving neuronal structures in this medullary region. The involvement of the area postrema is supported by ablation experiments because its destruction prevented cisplatin-induced emesis in the cat [69] or radiation-induced emesis in the dog [65–67]. So far, no ablation experiments have been reported in the ferret.

ROLE OF ENDOGENOUS 5-HT

Involvement of endogenous 5-HT in emesis was investigated. It was found that reserpine, *p*-chlorophenylalanine (PCPA) and fenfluramine antagonized cisplatin-induced emesis in the ferret [109]. The real role of 5-HT was difficult to assess, as all these agents with a possible exception of PCPA, depleted 5-HT, dopamine (DA) and noradrenaline (NE), unselectively. Cisplatin, the potent emetogenic agent, moderately increased brain levels of DA and decreased NE, while it had no significant effect on 5-HT or 5-hydroxyindoleacetic acid.

Several compounds affecting various 5-HT functional parameters (uptake inhibition (fluoxetine), metabolism (tranylcypromine) or synthesis (5-OH tryptophan, 5-HTP)) had no effect on subemetic doses of cisplatin [110]. In fact, tranylcypromine and 5-HTP antagonized emesis of cisplatin. Thus these results would favour an inhibitory role of 5-HT instead of emetogenic. It is conceivable that an excess of 5-HT may desensitize 5-HT₃ receptors that may result in a reduced sensitivity to emetogenic stimuli.

GR 38032F had no significant effects on brain levels of DA or 5-HT or their oxidative metabolites in various brain regions in rats [111]. However, this compound selectively antagonized DA metabolism in rats with activated mesolimbic system.

It had been reported that 5-HT and 2-Me-5-HT released DA in striatal slices [112]. The functional importance of this response is unknown, because the D₂-dopamine antagonists are not efficient antiemetics against radiation- or chemotherapy-induced emesis.

It can be concluded that direct evidence linking endogenous 5-HT to emesis is not convincing. On the other hand, selective effectiveness of 5-HT₃ antagonists as antiemetic agents and presence of 5-HT₃ receptors in the area postrema and vagus nerve do implicate 5-HT mechanisms.

GASTROPROKINETIC EFFECT AND ANTIEMETIC ACTION

A functional relationship may exist between gastrointestinal responses and antiemetic action, because selected 5-HT₃ antagonists, zacopride [17], BRL

24924 [16] or GR 38032F [113], have an effect on both parameters. Secondly, functional 5-HT₃ receptors in the GI tract have been demonstrated [22]. Therefore, this question deserves a more detailed analysis.

Dazopride, which was more potent (6-times) than metoclopramide in promoting gastric motility, was weaker against cisplatin-induced emesis in dogs [10]. Similarly, BRL 24924, which was about up to 100-times more potent than metoclopramide on gastric emptying [16], did not exhibit any potency advantage as an antiemetic [83]. In contrast, zacopride [17] and GR 38032F [113], which were more potent than metoclopramide as gastroprokinetic agents, were also more potent as antiemetics [17, 104]. The primary involvement of GI tract effects in antiemetic action of the latter compounds is not very likely, because they exhibited a rapid onset of protection following i.c.v. administration at very small doses [64, 108].

On the other hand, BMY 25801 [114], while lacking significant gastric prokinetic activity, was more potent than metoclopramide as an antiemetic (*Table 7.2*). Finally, BRL 43694, while inconsistently active in gastric emptying and motility tests [26, 115, 116], was one of the most potent antiemetics [102, 106] in laboratory animals, including the dog. In this species, it failed to demonstrate any significant gastric motility activity.

A combined administration of metoclopramide and anticholinergic agent to reduce dystonic reactions of metoclopramide, did not diminish antiemetic efficacy in dogs [117]. Thus, the inhibitory effect on GI smooth muscle by cholinergic blockade had no significant impact on antiemetic activity of metoclopramide.

There were a few experiments where emesis and gastric events were recorded simultaneously in the same animal. Domperidone, a potent D₂-dopamine antagonist and gastric-motility-enhancing agent, antagonized radiation-induced emesis in dogs but had no effect on gastric emptying delay [118]. In monkeys, domperidone did not protect against radiation-induced emesis and had no effect on various gastric functions [119]. In the same experiments, no clear temporal relationship between emesis and gastric motility slowing could be observed. On the other hand, zacopride antagonized both emesis and gastric stasis in monkeys exposed to radiation [120]. In general, these observations do not suggest an obvious functional interdependence between antiemetic action and gastrointestinal effects.

TREATMENT OF CANCER-CHEMOTHERAPY-INDUCED EMESIS

There is an increasing need for more efficient antiemetic therapy because of more aggressive anticancer treatment designed to achieve higher survival or

remission rates. The randomized study with metoclopramide versus placebo and prochlorperazine by Gralla's group [81] was an important milestone in development of novel and efficient antiemetic agents. It is an example of a definitive study where dose size, frequency of administration and selection of patients were properly controlled. In general, most previous antiemetic studies were inclusive because of design deficiencies. Even now there are no definite clinical studies on the therapy of radiation-induced emesis [121].

The following overview is limited to control of emesis induced by cancer chemotherapy and presents more important developments in the last decade. The reader is referred to more extensive reviews and monographs on this subject [30, 37, 122-126].

CANNABINOIDS

The active ingredient of marijuana, Δ^9 -tetrahydrocannabinol (THC, also known as Δ^1 -THC) proved to be superior to placebo and prochlorperazine against emesis induced by anticancer agents [127, 127a]. However, it was inferior to metoclopramide against cisplatin-induced emesis [128]. The cannabinoid CNS side-effects, sedation and disorientation, were the main factors limiting clinical utility of THC. Synthetic cannabinoids (nabilone, levonantradol) did not offer a significant advantage over THC [129].

PHENOTHIAZINES AND BUTYROPHENONES

These compounds belong to a broad class of pharmacological agents possessing D_2 -dopamine blocking properties which are responsible for dystonic reactions. Prochlorperazine, the most widely used phenothiazine, was more effective than placebo but did not offer advantage over the cannabinoids or butyrophenones [123]. It was less effective than metoclopramide against cisplatin [81].

Haloperidol and droperidol were effective in cancer patients, including those receiving cisplatin [123]. A comparative study revealed that haloperidol was slightly less effective than metoclopramide [130]. Droperidol combined with dexamethasone was effective against cisplatin emesis; however, cardiovascular toxicity was a limiting factor [131]. In general, the efficacy of butyrophenones against high-dose cisplatin has not been established. Recently, haloperidol was compared with prochlorperazine, both combined with dexamethasone, in breast cancer patients; however, their antiemetic efficacy was not impressive [132].

DOMPERIDONE

Domperidone [133], one of the most potent D_2 -dopamine blockers and antagonists of apomorphine-induced emesis with limited brain-blood barrier permeability, did not establish a position as an antiemetic, especially against cisplatin [134]. Recently, the use of domperidone as a parenteral antiemetic has been discontinued because of serious cardiovascular toxicity.

METOCLOPRAMIDE

A review by Gralla [135] on metoclopramide outlined progression from animal studies to clinical trials using high intravenous doses of the compound [81]. Metoclopramide was superior over prochloroperazine and THC, especially against high-dose cisplatin. Subsequently, these studies have been confirmed by numerous investigators and metoclopramide became the standard agent against chemotherapy-induced emesis. The success rate in major control of emesis with metoclopramide was not complete and exhibited a rather wide range (50–80%). Therefore, attempts were made to optimize its efficacy by a means of various drug combinations [129, 136, 137] to minimize dystonic side-effects (diphenhydramine), increase its antiemetic effects by adding other drugs acting by different mechanisms (dexamethasone) or prevent anticipatory emesis (lorazepam or diazepam). Recent trials with oral metoclopramide combined with dexamethasone proved to be effective in controlling delayed emesis [129].

CORTICOSTEROIDS

Antiemetic activity of dexamethasone against cancer chemotherapy-induced emesis including cisplatin has been reported [138–140]. However, some investigators found negative results against high-dose cisplatin [141]. One therapeutic value of dexamethasone or other steroidal drugs is their combined use with metoclopramide to increase overall efficacy of antiemetic regimens [129, 142]. They are also used against anticancer agents exhibiting low emetogenic potential.

BENZODIAZEPINES

These compounds alone do not have significant antiemetic activity. Their main value is the adjunct use with other agents to decrease anxiety and anticipatory emesis in cancer patients [129].

5-HT₃ ANTAGONISTS

Metoclopramide may be considered as a prototype 5-HT₃ antagonist because its antiemetic efficacy both in animals and man could not be adequately explained by D₂-dopamine blockade. In fact, metoclopramide was considerably weaker as a D₂-antagonist than haloperidol or domperidone and yet it was effective against emesis induced by anticancer agents both in animals [43, 80] and cancer patients [135].

Recently, several 5-HT₃ antagonists have been identified and found to be effective as antiemetics in animals (*Table 7.2*). These compounds as a class have been proven to be free of D₂-dopamine blocking properties which are responsible for dystonic side-effects seen with metoclopramide.

There are numerous antiemetic studies with these compounds in cancer patients undergoing chemotherapy and examples are listed in *Table 7.3*. The

Table 7.3. CLINICAL ANTIEMETIC ACTIVITY OF 5-HT₃ ANTAGONISTS

Compound	Chemotherapy	Dose	Results (%)		
			CP ^a	MP ^b	Ref.
BRL 43694	cisplatin	0.04–0.1 mg/kg, i.v.	45	65	143
Granisetron	several agents	0.04 mg/kg, i.v.	55	85	144
	cisplatin combined	0.04 mg/kg, i.v.	57	100	145
GR 38032F	several agents	4 mg, i.v. + 4 mg, p.o. × 3	93	93	146
Ondansetron	several agents including cisplatin	0.04–0.35 mg/kg, i.v. × 3	54	76	147
	cisplatin (high dose)	0.18 mg/kg, i.v. × 3	35	55	148
BMY 25801 Batanopride	cisplatin	1–7 mg/kg, i.v. × 3	42	67	149
ICS 205–903	cisplatin, other agents	10–40 mg, i.v. × 2	59	90	150

^a Complete protection (no vomiting).

^b Major protection (<3 emesis).

clinical trials are progressing at a fast pace, but most studies reported are open label and preliminary. In general, 5-HT₃ antagonist antiemetics antagonized emesis induced by various agents, including cisplatin. So far, their side-effect profile has not revealed any specific patterns. Thus they could be differentiated from cannabinoids, phenothiazines or butyrophenones. The final verdict on

their therapeutic efficacy remains to be established in comparative double-blind trials with appropriate reference agents (for example, metoclopramide). Inferior response in anticipatory emesis was observed with BRL 43694 [143] as previously seen with metoclopramide. Likewise, the success rate against more severe emetogenic agents (for example, high-dose cisplatin) may be less satisfactory, probably necessitating the use of drug combinations.

ACKNOWLEDGEMENTS

The authors thank Dr. W.F. Kreighbaum and J.M. Chuang for literature search; D.P. Morse for patience and expert help in preparing the manuscript; C.G. Boissard for art work.

ADDENDUM

ICS 205-930, MDL 72222 and zacopride were inactive against motion-induced emesis in cats. J.B. Lucot, *Pharmacol. Biochem. Behav.*, 32 (1989) 207.

Metoclopramide (low oral doses—10, 20 mg) was inactive against motion sickness in human models. C.M. Lathers, J.B. Charles, and M.W. Bungo, *Trends Pharmacol. Sci.*, 10 (1989) 243.

The 5-HT₄ receptor has been identified in mouse brain (positively coupled to adenylate cyclase) and guinea pig ileum (associated with gastroprokinetic activity) [151].

REFERENCES

1. E. Peringer, P. Jenner, I.M. Donaldson, C.D. Mardsen and R. Miller, *Neuropharmacology*, 15 (1976) 436.
2. A.J. Pench, P. Simon and R. Boissier, *Euro.J. Pharmacol.*, 50 (1978) 291.
3. I. Monković, *Drugs Future*, 14 (1989) 41.
4. I. Monković, D. Willner, M.A. Adam, M. Brown, R.R. Crenshaw, C.E. Fuller, P.F. Juby, G.M. Luke, J.A. Matiskella and T.A. Montzka, *J. Med. Chem.*, 31 (1988) 1548.
5. G. Bulteau, J. Acher, C. Collignon, J.C. Monier, U.S. Patent 4 039 672; *Chem. Abstr.*, 85 (1975) 21382.
6. I. Monković, M. Brown, G.M. Luke, R.T. Standridge, D. Willner, A.R. Crosswell, A. Algieri, J.P. Buynishi, R.R. Crenshaw and P.F. Juby, *Eur. J. Med. Chem.*, 24 (1989) 233.
7. G.J. Sanger and F.D. King, *Drug Design Delivery*, 3 (1988) 273.
8. S. Iwanami, M. Takashima, Y. Hirata, O. Hasegawa and S. Usuda, *J. Med. Chem.*, 24 (1981) 1224.
9. D.J. Roberts, *Curr. Ther. Res.*, 31 (1982) S1.
10. R.S. Alphin, A.G. Proakis, C.A. Leonard, W.L. Smith, W.N. Dannenburg, W.J. Kinnier, D.N. Johnson, L.F. Sancilio and J.W. Ward, *Dig. Dis. Sci.*, 31 (1986) 524.

11. G.H.P. Van Daele, M.F.L. DeBryn, F.M. Sommen, M. Janssen, J.M. Van Neuten, J.A. Schuurkes, C.J.E. Niemegeeres and J.E. Leysen, *Drug Dev. Res.*, 8 (1986) 225.
12. A. Fargione, *Drugs Future*, 12 (1987) 944.
13. R. Massingham, J. Borl and D.J. Roberts, *J. Auton. Pharmacol.*, 5 (1985) 41.
14. M.S. Hadley, F.D. King, B. McRitchie, D.H. Turner and E.A. Watts, *J. Med. Chem.*, 28 (1985) 1843.
15. Anon., *Drugs Future*, 12 (1987) 1007.
16. S.M. Cooper, C.M. McClelland, B. McRitchie and D.H. Turner, *Br. J. Pharmacol.*, 88 (1986) 383P.
17. R.S. Alphin, W.L. Smith, C.B. Jackson, D.A. Droppleman and L.F. Sancilio, *Dig. Dis. Sci.*, 31 (1986) 482 S.
18. J.H. Sun and A.R. Imondi, *FASEB J.*, 2 (1988) A1053.
19. R.L. Schroeder, J.H. Sun, C.K. Wong and A.R. Imondi, *FASEB J.*, 2 (1988) A1052.
20. J.R. Fozard, *Naunyn-Schmiedebergs Arch. Pharmacol.*, 326 (1984) 36.
21. D.W. Miner and G.J. Sanger, *Br. J. Pharmacol.*, 88 (1986) 497.
22. B.P. Richardson, G. Engel, P. Donatsch and P.A. Stadler, *Nature (London)*, 316 (1985) 126.
23. P. Donatsch, G. Engel, B.P. Richardson and P. Stadler, *Br. J. Pharmacol.*, 81 (1984) 34P.
24. P. Fludzinski, D.A. Evrard, W.E. Bloomquist, W.B. Lacefield, W. Pfeifer, N.D. Jones, J.B. Deeter and M.L. Cohen, *J. Med. Chem.*, 30 (1987) 1535.
25. F.D. King, *Europ. Patent 200444*; *Chem. Abstr.*, 106 (1987) 119892.
26. C.S. Fake, F.D. King and G.R. Sanger, *Br. J. Pharmacol.*, 91 (1987) 335P.
27. B. Costall, A.M. Domeney, S.J. Gunning, R.J. Naylor, F.D. Tattersall and M.B. Tyers, *Br. J. Pharmacol.*, 90 (1987) 90P.
28. G.J. Kilpatrick, B.J. Jones and M.B. Tyers, *Nature (London)*, 330 (1987) 746.
29. H.L. Borison and S.C. Wang, *Pharmacol. Rev.*, 5 (1953) 193.
30. J.H. Barnes, *Mol. Aspects Med.*, 7 (1984) 397.
31. P.L.R. Andrews and J. Hawthorn, *Bailliere's Clin. Gastroenterology*, 2 (1988) 141.
32. H.L. Borison and L.E. McCarthy, *Drugs*, 25, Suppl.1 (1983) 8.
33. S.J. Peroutka and S.H. Snyder, *Lancet*, i (1982) 658.
34. R.A. Leslie, *Neurochem. Int.*, 7 (1985) 191.
35. P.L.R. Andrews, W.G. Rapeport and G.J. Sanger, *Trends Pharmacol. Sci.*, 9 (1988) 334.
36. K.R. Brizzee and H.L. Borison, *Fed. Proc.*, 43 (1984) 2937.
37. C.J. Davis, G.V. Lake-Bakaar and D.G. Grahame-Smith, eds., *Nausea and Vomiting; Mechanisms and Treatment* (Springer-Verlag, Berlin, 1986).
38. R.K. Harding and A.D. Miller, *Can. J. Physiol. Pharmacol.*, (1990) in press.
39. N. Matsuki, S. Ueno, T. Kaji, A. Ishihara, C.H. Wang and H. Saito, *Jpn. J. Pharmacol.*, 48 (1988) 303.
40. H.L. Borison, R. Borison and L.E. McCarthy, *J. Clin. Pharmacol.*, 21 (1981) 23 S.
41. K.R. Brizzee, L.M. Neal and P.M. Williams, *Am. J. Physiol.*, 180 (1955) 659.
42. P.L.R. Andrews, C.J. Davis, D.G. Grahame-Smith and L.B. Maskell, *Br. J. Pharmacol.*, 89 (1986) 860P.
43. J.A. Gylys, R.N. Wright, W.D. Nicolosi, J.P. Buyniski and R.R. Crenshaw, *J. Pharmacol. Exp. Ther.*, 244 (1988) 830.
44. G.L. King, *Radiat. Res.*, 114 (1988) 599.
45. C.J. Davis, R.K. Harding, R.A. Leslie and P.L.R. Andrews, in Ref. 37, pp. 65-75.
46. L.E. McCarthy, H.L. Borison, P.K. Spiegel and R.M. Friedlander, *Gastroenterology*, 67 (1974) 1126.

47. L.E. McCarthy and H.L. Borison, *Am. J. Physiol.*, 226 (1974) 738.
48. A.D. Miller, L.K. Tan and I. Suzuki, *J. Neurophysiol.*, 57 (1987) 1854.
49. O.E. Akwari, *Drugs*, 25, Suppl. 1 (1983) 18.
50. I.M. Lang, S.K. Sarna and R.E. Condon, *Gastroenterology*, 90 (1986) 40.
51. J.L. Willems and R.A. Lefebvre, in Ref. 37, pp. 56–64.
52. K.R. Brizzee and W.R. Mehler, in Ref. 37, pp. 31–55.
53. R.A. Leslie and D.G. Gwyn, *Fed. Proc.*, 43 (1984) 2941.
54. P.A. Lindstrom and K.R. Brizzee, *J. Neurosurgery*, 19 (1962) 228.
55. H.L. Borison, *Fed. Proc.*, 43 (1984) 2937.
56. R.A. Leslie, *Cell. Mol. Neurobiol.*, 6 (1986) 95.
57. K.R. Brizzee and P.M. Klara, *Fed. Proc.*, 43 (1984) 2944.
58. E. Stefanini and Y. Clement-Cormier, *Eur. J. Pharmacol.*, 74 (1981) 257.
59. J.C. Schwartz, Y. Agid, M.L. Bouthenet, F. Javoy-Agid, C. Llorens-Cortes, M.P. Martres, H. Pollard, N. Sales and H. Taquet, in Ref. 37, pp. 18–30.
60. G.A. Higgins, G.J. Kilpatrick, K.T. Bunce, B.J. Jones and M.B. Tyers, *Br. J. Pharmacol.*, 95 (1988) 504P.
61. G.J. Kilpatrick, B.J. Jones and M.B. Tyers, *Br. J. Pharmacol.*, 95 (1988) 871P.
62. V.M. Pickel and D.M. Armstrong, *Fed. Proc.*, 43 (1984) 2949.
63. D.O. Carpenter, D.B. Briggs and N. Strominger, *Fed. Proc.*, 43 (1984) 2952.
64. G.A. Higgins, G.J. Kilpatrick, K.T. Bunce, B.J. Jones and M.B. Tyers, *Br. J. Pharmacol.*, 97 (1989) 247.
65. S.C. Wang, A.A. Renzi and H.I. Chinn, *Am. J. Physiol.*, 193 (1958) 335.
66. D.O. Carpenter, D.B. Briggs, A.P. Knox and N.L. Strominger, *Radiat. Res.*, 108 (1986) 307.
67. R.K. Harding, H. Hugenholtz, M. Keane and J. Kucharczyk, *Neurosci. Lett.*, 53 (1985) 95.
68. H.L. Borison, *J. Comp. Neurol.*, 107 (1957) 439.
69. L.E. McCarthy and H.L. Borison, *Cancer Treat. Rep.*, 68 (1984) 401.
70. P.L.R. Andrews and J. Hawthorn, *Neuropharmacology*, 26 (1987) 1367.
71. J. Hawthorn, K.J. Ostler and P.L.R. Andrews, *Q. J. Exp. Physiol.*, 73 (1988) 7.
72. H.L. Borison and S.C. Wang, *J. Neurophysiol.*, 12 (1949) 305.
73. A.D. Miller and V.J. Wilson, *Brain Res.*, 270 (1983) 154.
74. S.J. Peroutka, *Trends Neurol. Sci.*, 11 (1988) 496.
75. R.A. Glennon, *J. Med. Chem.*, 30 (1987) 1.
76. D.W. Robertson and R.W. Fuller, *Annu. Rep. Med. Chem.*, 23 (1988) 49.
77. P.B. Bradley, G. Engel, W. Feniuk, J.R. Fozard, P.P.A. Humphrey, D.N. Middlemiss, E.J. Mylecharane, B.P. Richardson and P.R. Saxena, *Neuropharmacology*, 25 (1986) 563.
78. B.P. Richardson and K.H. Buchheit, *Neuronal Serotonin*, ed. N.N. Osborne and M. Hamon (John Wiley, New York, 1988) pp. 465–505.
79. J.H. Gaddum and Z.P. Picarelli, *Br. J. Pharmacol.*, 12 (1957) 323.
80. J.A. Gylys, K.M. Doran and J.P. Buyniski, *Res. Commun. Chem. Pathol. Pharmacol.*, 23 (1979) 61.
81. R.J. Gralla, L.M. Itzi, S.E. Pisko, A.E. Squillante, D.P. Kelsen, D.W. Braun, L.A. Bordin, T.J. Braun and C.W. Young, *N. Engl. J. Med.*, 305 (1981) 905.
82. B. Costall, A.M. Domeney, R.J. Naylor and F.D. Tattersall, *Neuropharmacology*, 26 (1987) 1321.
83. W.D. Miner, G.J. Sanger and D.H. Turner, *Br. J. Cancer*, 56 (1987) 159.
84. J.L. Yakel and M.B. Jackson, *Neuron*, 1 (1988) 615.

85. S.R. Glaum, H.K. Proudfit and E.G. Anderson, *Neurosci. Lett.*, 95 (1988) 313.
86. G.J. Blauw, P. van Brummelen and P.A. van Zwieten, *Life Sci.*, 43 (1988) 1441.
87. E. Carboni, E. Acquas, P. Leone and G. DiChiara, *Psychopharmacology*, 97 (1989) 175.
88. B.J. Jones, B. Costall, A.M. Domeney, M.E. Kelly, R.J. Naylor, N.R. Oakley and M.B. Tyers, *Br. J. Pharmacol.*, 93 (1988) 985.
89. J.R. Fozard and A.T.M. Mobarok Ali, *Eur. J. Pharmacol.*, 49 (1978) 109.
90. D. Hoyer and H.C. Neijt, *Eur. J. Pharmacol.*, 143 (1987) 291.
91. S.J. Peroutka and A. Hamik, *Eur. J. Pharmacol.*, 148 (1988) 297.
92. K.J. Watling, S. Aspley, C.J. Swain and J. Saunders, *Eur. J. Pharmacol.*, 149 (1988) 397.
93. N.M. Barnes, B. Costall and R.J. Naylor, *J. Pharm. Pharmacol.*, 40 (1988) 548.
94. N.M. Barnes, B. Costall, J.W. Ironside and R.J. Naylor, *J. Pharm. Pharmacol.*, 40 (1988) 668.
95. S.J. Peroutka, *Naunyn-Schmiedeberg's Arch. Pharmacol.*, 338 (1988) 472.
96. S.R. Glaum and E.G. Anderson, *Eur. J. Pharmacol.*, 156 (1988) 287.
97. C. Waeber, K. Dixon, D. Hoyer and J.M. Palacios, *Eur. J. Pharmacol.*, 151 (1988) 351.
98. D. Hoyer, H.C. Neijt and A. Karpf, *J. Receptor Res.*, 9 (1989) 65.
99. W.W. Smith, L.F. Sancilio, J.B. Owers-Atepo, R.J. Naylor and L. Lambert, *J. Pharm. Pharmacol.*, 45 (1988) 301.
100. A. Butler, J.M. Hill, S.J. Ireland, C.C. Jordan and M.B. Tyers, *Br. J. Pharmacol.*, 94 (1988) 397.
101. A.W. Dunbar, C.M. McClelland and G.J. Sanger, *Br. J. Pharmacol.*, 88 (1986) 319P.
102. J. Bermudez, E.A. Boyle, W.D. Miner and G.J. Sanger, *Br. J. Cancer*, 58 (1988) 644.
103. B. Costall, A.M. Domeney, R.J. Naylor and F.D. Tattersall, *Neuropharmacology*, 25 (1986) 959.
104. R. Stables, P.L.R. Andrews, H.E. Bailey, B. Costall, S.J. Gunning, J. Hawthorn, R.J. Naylor and M.B. Tyers, *Cancer Treat. Rev.*, 14 (1987) 333.
105. M.L. Cohen, W. Bloomquist, J.S. Gidda and W. Lacefield, *J. Pharmacol. Exp. Ther.*, 248 (1989) 197.
106. R.K. Harding, K.E. Leach and L. Prud'hommeLalonde, *Pharmacologist*, 30 (1989) 106.
107. J.A. Gylys (unpublished results).
108. W.L. Smith, E.M. Callahan and S. Alphin, *J. Pharm. Pharmacol.*, 40 (1988) 142.
109. J.M. Barnes, N.M. Barnes, B. Costall, R.J. Naylor and F.D. Tattersall, *Neuropharmacology*, 27 (1988) 783.
110. B. Costall, R.J. Naylor and F.D. Tattersall, *Br. J. Pharmacol.*, 95 (1988) 866P.
111. R.M. Hagan, B.J. Jones, C.C. Jordan and M.B. Tyers, *Br. J. Pharmacol.*, 95 (1988) 867P.
112. P. Blandina, J. Goldfarb and J.P. Green, *Eur. J. Pharmacol.*, 155 (1988) 349.
113. B. Costall, S.J. Gunning, R.J. Naylor and M.B. Tyers, *Br. J. Pharmacol.*, 91 (1987) 263.
114. J.A. Gylys (unpublished results).
115. F.D. King and G.J. Sanger, *Annu. Rep. Med. Chem.*, 23 (1988) 201.
116. R. Gamse, K.H. Bucheit, A. Bertholet and H.H. Buscher, in *Symposium on Serotonin (Florence)* (1989) p. 118.
117. W.L. Smith, C.B. Jackson, L.F. Sancilio and R.S. Alphin, *Cancer Treat. Rep.*, 70 (1986) 934.
118. A. Dubois, J.P. Jacobus, M.P. Grissom, R.R. Eng and J.J. Conklin, *Gastroenterology*, 86 (1984) 444.
119. E.D. Dorval, G.P. Mueller, R.R. Eng, A. Durakovic, J.J. Conklin and A. Dubois, *Gastroenterology*, 89 (1985) 374.
120. A. Dubois, N. Fiala and V. Bogo, *Gastroenterology*, 92 (1987) 1376.

121. R.K. Harding, *Pharmacol. Therap.*, 39 (1988) 335.
122. J. Laszlo, *Antiemetics and Cancer Chemotherapy* (Williams & Wilkins, Baltimore) (1983).
123. R.J. Gralla, L.B. Tyson, M.G. Kris and R.A. Clark, *Med. Clin. North Am.*, 71 (1987) 289.
124. C.M. Edwards, *J. R. Soc. Med.*, 81 (1988) 658.
125. M.E.R. O'Brien and M.H. Cullen, *J. Clin. Pharm. Ther.*, 13 (1988) 19.
126. T.J. Kelly, *Clinician*, 6 (1988) 1.
127. B.J. Vincent, D.J. McQuiston, L.H. Einhorn, C.M. Nagy and M.J. Brames, *Drugs*, 25 Suppl., 1 (1983) 52.
- 127a. R. Mechoulam and J.J. Feigenbaum, *Prog. Med. Chem.*, 24 (1987) 182.
128. R.J. Gralla, L.B. Tyson, L.A. Bordin, R.A. Clark, D.P. Kelsen, M.G. Kris, L.B. Kalman and S. Groshen, *Cancer Treat. Rep.*, 68 (1984) 163.
129. R.J. Gralla, *Clinician*, 6 (1988) 26.
130. S.M. Grunberg, K.V. Gala, M. Lampenfeld, D. Jamin, K. Johnson, P. Cariffe, D. Strych and M. Krailo, *J. Clin. Oncol.*, 2 (1984) 782.
131. S.L. Kelley, T.J. Braun, T.J. Meyer, P. Rempel and N.W. Pearlman, *Cancer Treat. Rep.*, 70 (1986) 469.
132. L. Silvey, J.T. Carpenter, Jr., R.H. Wheeler, J. Lee and C. Conolley, *J. Clin. Oncol.*, 6 (1988) 1397.
133. R.N. Brogden, A.A. Carmine, R.C. Heel, T.M. Speight and G.S. Avery, *Drugs*, 24 (1982) 360.
134. J. Penta, D. Poster and S. Bruno, in Ref. 122, pp. 53–92.
135. R.J. Gralla, *Drugs*, 25, Suppl. 1 (1983) 63.
136. P.M. Plezia, D.S. Alberts, J. Kessler, M.S. Aapro, V. Graham and E.A. Surwit, *Cancer Treat. Rep.*, 68 (1984) 1493.
137. M.G. Kris, R.J. Gralla, R.A. Clark, L.B. Tyson, J.J. Fiore, D.P. Kelsen and S. Groshen, *Cancer Treat. Rep.*, 69 (1985) 1257.
138. P.A. Cassileth, E.J. Lusk, S. Torri, N. DiNubile and S.L. Gerson, *Arch. Intern. Med.*, 143 (1983) 1347.
139. M.S. Aapro, P.M. Plezia, D.S. Alberts, V. Graham, S.E. Jones, E.A. Surwit and T.E. Moon, *J. Clin. Oncol.*, 2 (1984) 466.
140. N.E. Zaglama, S.L. Rosenblum, G.P. Sartiano, M. Brady, M.F. Gonzales and J.G. Valdivieso, *Oncol.*, 43 (1986) 27.
141. B.W. Dana, E.C. Everts and D. Dickinson, *Am. J. Clin. Oncol.*, 8 (1985) 426.
142. S.B. Strum, J.E. McDermed and D.F. Liponi, *J. Clin. Oncol.*, 3 (1985) 245.
143. R.A. Joss, J. Richner, K.W. Brunner, D. Rohrbach, M. Pirovino, J.P. Terrey and J. Upward, *J. Natl. Cancer Inst.*, 80 (1988) 1340.
144. J. Cassidy, V. Raina, C. Lewis, L. Adams, M. Soukop, W.G. Rapeport, B.D. Zussman, E.M. Rankin and S.B. Kaye, *Br. J. Cancer*, 58 (1988) 651.
145. J. Carmichael, B. Cantwell, G. Rapeport, P. Coates, S. Thompson and A.L. Harris, *Br. J. Cancer*, 58 (1988) 266.
146. D. Cunningham, A. Pople, H.T. Ford, J. Hawthorn, J.C. Gazet, T. Challoner and R.C. Coombes, *Lancet*, i (1987) 1461.
147. M.G. Kris, R.J. Gralla, R.A. Clark and L.B. Tyson, *J. Clin. Oncol.*, 6 (1988) 659.
148. M.G. Kris, R.J. Gralla, R.A. Clark and L.B. Tyson, *J. Natl. Cancer Inst.*, 81 (1989) 42.
149. L. Smaldone, C. Fairchild, M. Rozenzweig, M. Aapro, G. Sartiano, P. Plezia and D. Alberts, *Proc. Am. Soc. Clin. Oncol.*, 7 (1988) 280.
150. U. Leibundgut, A. Rabineau and J.P. Obrecht, *Proc. Am. Soc. Clin. Oncol.*, 7 (1988) 284.
151. A. Dumuis, M. Sebben and J. Bockaert, Naunyn-Schmiedeberg's *Arch. Pharmacol.*, 340 (1989) 403.

This Page Intentionally Left Blank

8 Antagonists of Platelet-Activating Factor: Chemistry, Pharmacology and Clinical Applications

DAVID HOSFORD, Ph.D. and PIERRE BRAQUET, Ph.D., D.Sc. *

Institut Henri Beaufour Research Labs, 17 Avenue Descartes, 92350 Le Plessis-Robinson, France

INTRODUCTION	326
CHARACTERISTICS OF PAF BINDING SITES	328
NON-SPECIFIC PAF ANTAGONISTS	330
SPECIFIC PAF ANTAGONISTS OF SYNTHETIC ORIGIN	330
Non-constrained PAF framework-related antagonists	331
Constrained PAF framework-related antagonists	334
Synthetic antagonists unrelated to the PAF framework	337
NATURALLY OCCURRING PAF ANTAGONISTS AND THEIR DERIVATIVES	341
Ginkgolides	341
<i>Structure–activity relationships of ginkgolides</i>	343
<i>Pharmacological properties</i>	344
Lignans	350
<i>Benzofuranoid lignans</i>	350
<i>Substituted furanoid lignans</i>	352
<i>Diabenzylbutyrolactone (butanolide)-derived lignans</i>	354
Gliotoxin-related products	355
<i>Structure–activity relationships</i>	356
<i>Pharmacological properties</i>	358
CLINICAL TRIALS WITH PAF ANTAGONISTS	360
CONCLUSION: TOWARDS A MECHANISM OF PAF ANTAGONIST ACTION	362
APPENDIX: RECENTLY REPORTED PAF ANTAGONISTS	366
REFERENCES	369

* Correspondence to Dr. Braquet.

INTRODUCTION

The existence of a platelet-activating substance was first suggested between 1966 and 1969 when evidence was obtained for a complement-independent, antigen-induced activation of rabbit leukocytes that in some way resulted in histamine release from platelets [1–3]. Subsequently, it was proposed that a fluid-phase mediator from leukocytes of immunologically sensitized rabbits might be involved [4, 5]. This observation was confirmed [6, 7] and the name platelet-activating factor (PAF) was attributed to the substance [7], which was determined to be a lipid-like molecule [8]. The structure of PAF was elucidated in 1979 by semi-synthetic approaches. Two groups working in the platelet and leukocyte field simultaneously reported the structure of PAF as 1-*O*-alkyl-2-acetyl-*sn*-glyceryl-3-phosphocholine [9, 10]. Independently, the same structure was deduced for the anti-hypertensive polar renomedullary lipid [11]. In 1980, the structure was confirmed by the analysis of natural PAF from IgE-stimulated rabbit basophils [12].

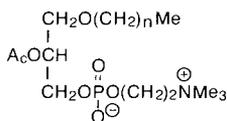

(1) Platelet-activating factor (PAF)
(*n* is usually 15 or 17)

Although the basic structure of PAF (1) is firmly established, some controversy exists regarding the composition of the 1-*O*-alkyl chain. For example, with human Ca^{2+} ionophore A23187-stimulated neutrophils, some investigators have found evidence for only 1-*O*-hexadecyl-PAF [13], while others have detected 16:0, 17:0 and 18:1 1-*O*-alk(en)yl chains [14]. It is interesting to note that the molecular variation in PAF is species-specific [15, 16] and is independent of the cell stimulus and the composition of the 1-alkyl-2-acyl-glycero-3-phosphocholine (1-alkyl-2-acyl-GPC) pool. Knowledge of the detailed composition of the PAF species may be important, because the length and degree of unsaturation of the 1-alkyl chain influences the biological activity [17–20]. Recently, molecules exhibiting PAF activity but differing by the polar head group have been also described [21].

PAF synthesis can be demonstrated upon the appropriate stimulation of a diverse range of cells, including rat and mouse peritoneal macrophages [22], mouse bone marrow-derived mast cells [23, 24], rat kidney cells [25], human cultured lymphoid cell lines [26] and endothelial cells [27–29], human and

rabbit neutrophils [30, 31], eosinophils [32], monocytes [33], natural killer (NK) cells [34] and platelets [35].

The synthesis of PAF upon cell stimulation is generally accepted to involve a deacylation of the precursor molecule 1-alkyl-2-acyl-GPC by a phospholipase A₂ (PLA₂) and a subsequent acetylation of the 2-lyso-PAF to the active PAF molecule by a specific acetyltransferase [36]. The activity of PLA₂ may be regulated by lipocortin [37], or lipocortin-like proteins as demonstrated in rabbit platelets [38]. Phosphorylation, most likely by protein kinase C, regulates the activity of lipocortin [39] and the acetyltransferase involved in PAF biosynthesis [40–42], and thus it may be an important regulatory step in PAF production. However, a large proportion of the fatty acid released upon conversion of the 1-alkyl-2-acyl-GPC to lyso-PAF is arachidonate, and this molecule is an endogenous inhibitor of PLA₂ [43]. Thus, PLA₂ may be regulated by several mechanisms including Ca²⁺ concentration, lipocortin or lipocortin-like proteins and/or free fatty acid availability.

Since the identification of PAF in the early 1970's, the autacoid has steadily emerged as a crucial mediator of diverse pathologies. Indeed, PAF is a potent mediator of anaphylaxis and inflammation and is also implicated in shock, graft rejection, renal disease, ovariimplantation and certain disorders of the central nervous system (CNS) [36, 44]. There is also accumulating evidence that PAF is capable of modulating the immune response [45, 46].

The importance of the pathophysiological role of PAF has been more fully elucidated only since the discovery in the early 1980's of compounds capable of specifically antagonizing PAF-induced bioactions. These compounds are specific and displace the PAF molecule from its receptor-binding sites, in most cases without themselves initiating any response. Their action is therefore a receptor-mediated process, competitive and generally reversible. The fact that PAF is involved in such a diverse range of pathologies means that specific PAF antagonists may be of considerable medicinal value as therapeutic agents. In this review, we will consider the pharmacology of the various specific PAF receptor antagonists. These compounds can generally be classified as (i) synthetic antagonists, either related or not to the PAF framework, and (ii) natural antagonists and their derivatives. In addition to the present article, PAF antagonists have been the subject of several extensive reviews [47–50]. For a detailed insight into the synthesis, metabolism and general pathophysiological role of PAF, the interested reader is referred to numerous publications reviewing this subject area [36, 44, 51–56].

CHARACTERISTICS OF PAF BINDING SITES

Before focusing our attention on PAF antagonists, it is important to consider the specific process with which they interfere: the binding of PAF to its cellular receptors.

The existence of specific binding sites for PAF was first indicated by the demonstration that only the naturally occurring (*R*) stereoisomer was effective in stimulating the aggregation and degranulation of platelets and neutrophils [57–61]. Additional evidence comes from the observations that very low concentrations of PAF (usually lower than 0.1 nM) are necessary to trigger biological effects, that specific desensitization takes place after exposure of the tissue to the mediator, and that PAF antagonists evoke specific inhibition.

The presence of PAF receptors has recently been confirmed by binding experiments using [³H]PAF. High-affinity receptors have been detected in human [62–65] and rabbit platelets [63, 66], human neutrophils [67], human lung membrane [68], gerbil brain [69], rat retinal tissue [70] and pigmented rabbit iris and ciliary body [71]. Investigations with specific PAF antagonists have also revealed binding sites for the mediator in guinea-pig platelets, macrophages and polymorphonuclear leukocytes (PMNL) [72, 73], rabbit PMNL [74] and rabbit and guinea-pig smooth muscle membrane [66]. The affinity and number of these receptors is dependent on type of cell, tissue and species. It is thus apparent that many of the cells and tissues generating the mediator are themselves targets of PAF-induced bioactions [75]. Interestingly, rat platelets do not aggregate, secrete or demonstrate Ca²⁺ uptake in response to PAF [76] or possess high-affinity binding sites for the mediator [63]. In platelet plasma membranes, a heat-labile and proteinase-sensitive PAF receptor has been described [66, 77]. Accordingly, exposure of platelets to PAF for 5 min at 37°C leads to desensitization and decrease in specific binding and aggregation [78, 79].

There is no correlation between the effects of PAF on platelet aggregation and various physical properties of pure dipalmitoylphosphatidylcholine bilayers as detected by differential scanning calorimetry [66], indicating that PAF receptor sites may not be phospholipids. Indeed, Valone [77] has presented evidence that the high-affinity PAF binding site on human platelets may be a protein. Using chromatography of membrane preparations on a Sepharose column loaded with PAF associated to human serum albumin, the latter author attempted to characterize the high-affinity PAF binding site present in this cell type. Sodium dodecyl sulphate (SDS) polyacrylamide gel electrophoresis of the eluted material revealed a single protein with an apparent molecular mass of 180 kDa. Subsequently, the isolation of a 160 kDa PAF-binding protein from

the same source was reported [80], this being obtained by sequential chromatography of [^3H]PAF-binding proteins. However, lack of a consistent procedure to solubilize the membrane-binding protein and a reliable method to prepare high-titre specific antibodies to PAF [81] has hampered more detailed biochemical characterization of the PAF receptor.

Monovalent and divalent cations and GTP regulate the specific binding of PAF to platelet plasma membranes. It has been demonstrated that inhibition of [^3H]PAF binding to rabbit platelets is sodium-specific, with an ED_{50} value of 6 mM [66]. High concentrations of Li^+ inhibit binding (ED_{50} value = 150 mM) while K^+ , Cs^+ and Rb^+ and the divalent cations Mg^{2+} , Ca^{2+} and Mn^{2+} have an enhancing effect. A total inhibition of PAF-induced aggregation is caused when H_2O is replaced by D_2O in the incubation medium, although binding is not affected [66]. Whereas the unnatural (*S*) enantiomer is inactive up to 10 μM , (*R*)-PAF stimulates hydrolysis of GTP [66, 82], suggesting that the receptor may be linked to the adenylate cyclase system via an inhibitory guanine nucleotide regulatory protein.

QSAR studies with various agonists, including variations on C_1 , C_2 and C_3 of the PAF glyceryl framework, have suggested a putative conformation of high-affinity membrane binding sites for the autacoid [44, 49]. Three interactions may be of particular importance in the binding process: (a) the long fatty chain of PAF deeply enters the membrane in a hydrophobic area exchanging hydrophobic bonds with the vicinity; (b) membrane activation may possibly derive from an electronic transfer from oxygen doublets of the etheroxide function to an unknown membrane target (possibly a G protein subunit). The presence of non-delocalized doublets could be made necessary by a possible protonation from the active site; (c) the short chain on C_2 may take part in the anchorage of PAF to its receptor, using a small hydrophobic area of $< 6.5 \text{ \AA}$ in length. The membrane receptor protein may subsequently stimulate a GTP-binding protein, leading to hydrolysis of GTP and activation of phospholipase C. The resultant phosphoinositide breakdown may be accompanied by formation of the second messenger's inositol trisphosphate and diacylglycerol [83] and increased cytosolic calcium. This latter process may open Ca^{2+} -independent K^+ channels, as observed in PAF-activated mouse macrophages [84]. On the other hand, diacylglycerol may induce protein kinase C activation, leading to phosphorylation of specific cellular proteins, which contribute to processes such as secretion and proliferation.

NON-SPECIFIC PAF ANTAGONISTS

Although this review is devoted mostly to specific PAF antagonists, it is interesting to note the wide range of compounds capable of antagonizing PAF-induced effects in a non-specific manner. Indeed, the first compounds reported to have PAF antagonistic properties were non-specific inhibitors. Sulphinpyrazone exerts a suppressive effect on PAF-induced bioactions [85], while non-specific antagonism of PAF-induced effects is elicited by a combination of aspirin, indomethacin or salicylic acid with mepyramine and methysergide [86]. Aminophylline also antagonizes PAF-induced bronchoconstriction at doses which do not affect the unrelated bronchoconstrictor agents, arachidonic acid and serotonin [87].

The cell response to PAF, both *in vitro* and *in vivo* is also counteracted by various drugs acting on intracellular calcium, either directly by calcium channel antagonists [88–92], calmodulin inhibitors [93–95], calcium chelators [91] and local anaesthetics [96], or indirectly by compounds such as salbutamol, which modulate the level of cyclic nucleotides [97]. In addition, PAF effects are antagonized by various compounds such as cromoglycate [98], thyrotropin-releasing hormone and its analogue MK 771 [99], naloxone, ticlopidine [100], atropine [101], doxepin, an antidepressant agent [102], some quaternarized derivatives of promethazine [103] and C-reactive protein [104]. Similar non-specific inhibition takes place with phospholipase [105], thromboxane and leukotriene [106–108] inhibitors.

SPECIFIC PAF ANTAGONISTS OF SYNTHETIC ORIGIN

We first direct our attention to specific PAF antagonists of synthetic origin. The majority of these compounds are modified derivatives of the PAF framework, the glycerol backbone (or modified glycerol backbone) either being non-constrained, as is the case with CV-3988 [109], Ro 19-3704 [110, 111], SRI 63-119 [112] and RU 45703 [113], or constrained, as in SRI 63-072 [114] and SRI 63-675 [115]. There are relatively few antagonists of synthetic origin unrelated to the PAF structure, although 48740 RP and 52770 RP [116] deriving from a (3-pyridyl)-1*H*,3*H*-pyrrolo[1,2-*c*]thiazole framework and the pharmacological agents, alprazolam, triazolam [117], brotizolam, WEB 2086 and WEB 2170 [118, 119] show potent PAF-antagonistic properties.

NON-CONSTRAINED PAF FRAMEWORK-RELATED ANTAGONISTS

These antagonists derive directly from the PAF structure and are open chain analogues of the mediator. CV-3988, (2; Takeda) was the first product described in this series. Incorporating an octadecyl carbamate in position 1, a methoxy in position 2 and a thiazolium-ethyl phosphate in position 3, this compound was discovered during an investigation of carbamate analogues of lysophospholipids as potential anti-fungal and cytotoxic agents [109]. The K_i values of CV-3988 for the specific binding of [^3H]PAF to human, rabbit and guinea-pig platelets are, respectively 0.16, 0.12 and 0.18 μM [109], showing it to be an orally active and potent antagonist. A weak agonistic activity has also been described, but only at high doses. The first report by Terashita *et al.* [109] claimed that CV-3988 specifically inhibited PAF-induced platelet aggregation; however, more recent studies have shown that at higher concentrations, the compound also displays antagonistic properties against arachidonic acid, ADP and collagen [120].

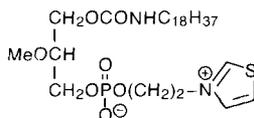

(2) CV 3988

CV-3988 effectively antagonizes endotoxin-induced shock in the rat [121], the related gastrointestinal damages [122] and disseminated intravascular coagulation [123]. This compound also counteracts the decrease in blood pressure induced by unclipping of renal artery in the one-kidney, one-clip hypertensive rat [124] and evokes a dose-dependent inhibition of the vascular permeability increase induced by PAF in rat skin [125]. The antagonist prevents the alteration of mucus secretion, respiratory and circulatory changes caused by administration of the mediator in the ferret [126] and the airway hyperresponsiveness observed in beagles subjected to ozone inhalation [127]. Human volunteers who received an i.v. infusion of CV-3988 (750–2000 $\mu\text{g}/\text{kg}$) in a double-blind, placebo-controlled study, showed reduced platelet sensitivity to PAF. Blood pressure, pulse, and respiratory rate were unaffected, while a small but clinically insignificant change in plasma haemoglobin and serum haptoglobin was observed [128].

CV-6209 (3), is an analogue of CV-3988 where the phosphate group has been replaced by an acetylcarnamate group. This modification produces a marked

increase in PAF inhibitory activity and the compound is some 80-fold more active than CV-3988. The analogue specifically inhibits PAF-induced aggregation of rabbit and human platelets (IC_{50} values = 75 nM and 0.17 μ M, respectively) and abolishes PAF-induced hypotension in rats [129].

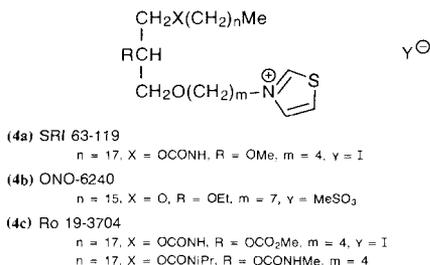
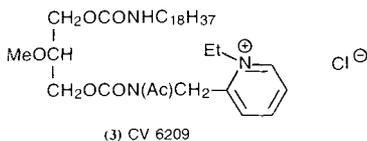

SRI 63-119 (4a), a compound recently described by Sandoz, is a non-phosphorous thiazolium PAF receptor antagonist that inhibits PAF-induced human platelet aggregation with an IC_{50} value of 3.8 μ M [130]. It also counteracts PAF-induced hypotension in the rat [131], haemoconcentration, bronchoconstriction [132] and microvascular leakage in the guinea-pig [133], and haemoconcentration in the primate [134]. In addition, studies in the rat have demonstrated that the compound effectively inhibits effects produced by endotoxin and PAF-induced bowel necrosis [135]. The (+)- and (-)-forms of SRI 63-119 are equipotent against PAF-induced bronchoconstriction and haemoconcentration in the guinea-pig, indicating a lack of enantiomeric selectivity [136]. It is interesting to note, however, that SRI 63-119 only partially inhibits dermal extravasation in the reverse Arthus reaction, suggesting the involvement of vasoactive mediators other than PAF [137].

Replacement of the phosphoryl moiety of CV-3988 with a heptamethylene thiazolium yields another series of antagonists, among which Ono-6240 (4b) is the most potent [121]. This compound protects against PAF-induced guinea-pig platelet aggregation (IC_{50} value = 0.2 μ M), and at 0.1–1 mg/kg i.v. prevents hypotension and bronchoconstriction in rats and guinea-pigs [138]. Ono-6240 also partially prevents the decrease in cardiac output and systemic arterial pressure in the *E. coli* endotoxin sheep model [139].

Other modifications of the non-constrained PAF framework have led Hoffmann La Roche's group to develop a further series of antagonistic compounds. The two closely related tetramethylene derivatives, both designated Ro 19-3704 (4c), are the most efficient and inhibit PAF-induced rabbit platelet aggregation with an IC_{50} value of 3.0 and 0.4 μ M respectively [113].

These compounds inhibit PAF-induced aggregation of rabbit, human and guinea-pig platelets, as well as bronchoconstriction, hypotension, thrombocytopenia, leukopenia and vasopermeation in the guinea-pig [140]. In addition, they prevent PAF-induced activation of alveolar macrophages, and the formation of thromboxane by isolated and perfused PAF-stimulated guinea-pig lungs. Although this antagonist fails to counteract bronchoconstriction of homologous passive systemic anaphylaxis, it does inhibit bronchospasm due to aerosolized antigen [140].

Replacement of the PO_3 group in CV-3988 with COCH_3 and alteration of the OCH_2 moiety leads to the structures Ro 18-8736, Ro 19-1400 and Ro 18-7953 (5a,b,c) [111]. These antagonists have IC_{50} values against PAF-induced human platelet aggregation of 0.5, 0.4 and $0.7 \mu\text{M}$ respectively [141]. The closely related Hoechst-Roussel compound, RU 45703 (5d), is obtained by substitution of the phosphoryl group by an ester linkage. This antagonist is a potent inhibitor of PAF-induced rabbit platelet aggregation with an IC_{50} value of $8 \mu\text{M}$ and also protects against PAF-induced bronchoconstriction and hypotension *in vivo*.

Very recently, two further series of non-constrained PAF-related antagonists have been reported. The Sankyo product, designated 137-224 (6) and structurally defined as 2- $\{[N$ -acetyl- N -[3-(heptadecylcarbamoyloxy)-2-(3-isoxazolyloxy)propoxy]carbonyl]aminomethyl}-1-ethylpyridinium chloride [142] is a potent PAF antagonist which inhibits PAF-induced hypotension in rats (ID_{50} value = 0.004 mg/kg i.v.) and PAF-induced rabbit platelet aggregation *in vitro* (IC_{50} value = $0.081 \mu\text{M}$). The compound displays good duration of action and bioavailability, and a variety of glycerol derivatives of the parent

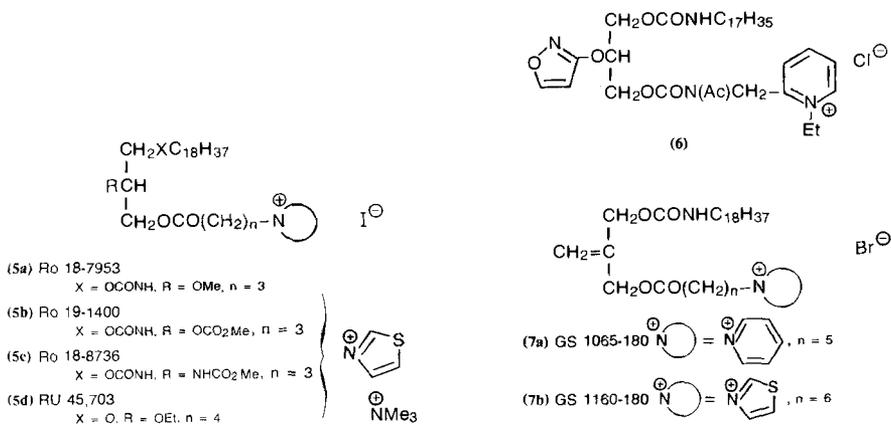

structure have been synthesized to establish structure–activity relationships in this series.

Finally, researchers from Leo Pharmaceuticals have reported the synthesis of two new achiral PAF antagonists, GS 1065-180 (7a) and GS 1160-180 (7b) from 2-methyleneprobane-1,3-diol [143]. *In vitro* platelet aggregation experiments with platelet-rich plasma (PRP) from rabbits revealed GS 1160-180 as the most effective PAF antagonist (EC_{50} value = $0.25 \mu\text{M}$) being twice as active as GS 1065-180 and 80-times more active than CV-3988 in their experimental system. Neither GS 1065-180 nor GS 1160-180 induced platelet aggregation at concentrations $\leq 10^{-4} \text{ M}$, or exhibited any inhibitory effect on platelet aggregation induced by collagen or adenosine diphosphate (ADP).

In vivo experiments with PAF-induced bronchoconstriction in guinea-pigs demonstrated that GS 1160-180 (ED_{50} value = 0.1 mg/kg i.v.) was twice as active as GS 1065-180 and 35-times more active than CV-3988. In this system, the difference in activity was less marked than with PAF-induced hypotension in rats, the two antagonists being equipotent (ED_{50} value = 0.5 mg/kg i.v.) and only twice as active as CV-3988 [143].

CONSTRAINED PAF FRAMEWORK-RELATED ANTAGONISTS

Cyclization of parts of the PAF molecular backbone produces the second family of PAF-related antagonists, those with a constrained framework. For example, insertion of a tetrahydrofuran ring has led to derivatives such as SRI 63-072 (8), SRI 63-441 (9a), SRI 63-675 (9b) and BN 55009 (10). The

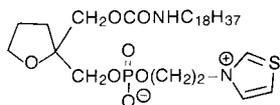

(8)

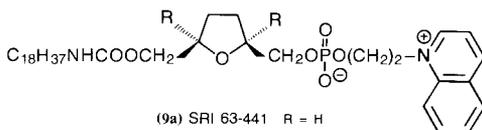

(9a) SRI 63-441 R = H

(9b) SRI 63-675 R = Me

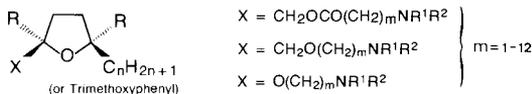

(10)

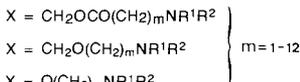

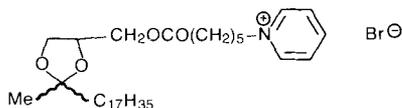

(11)

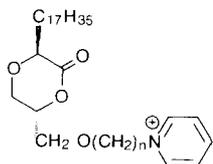

(12)

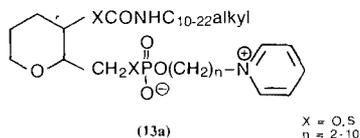

(13a)

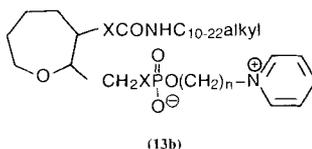

(13b)

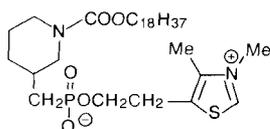

(14) SRI 63-073

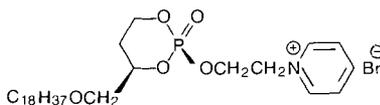

(15) Ro 18-6977

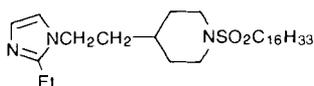

(16) SRI 62-586

inclusion of a 1,3-dioxolane has given rise to BN 52111 (11) and analogues, while Roche have synthesized a series of 1,4-dioxane-2-one antagonists, exemplified by (12). Other constrained framework inhibitors, (13a) and (13b), contain a tetrahydropyran ring, while inclusion of a piperidine produces the Roche inhibitor, SRI 63-073 (14). Incorporation of a 2-oxo-1,3,2-dioxaphosphorinane gives (15) and related antagonists. Finally, Sandoz have also synthesized an antagonist containing a piperidine, designated SRI 62-586 (16).

SRI 63-072 (8) [114] is an inhibitor of PAF-induced guinea-pig, rabbit, dog, baboon and human platelet aggregation with IC_{50} values of 1.4, 4.7, < 100, 19.0 and 22.3 μM , respectively [144]. The antagonist also prevents PAF-induced

bronchoconstriction and haemoconcentration in the guinea-pig [136] and haemoconcentration in the cebus appella primate [134]. In the rat, SRI 63-072 abolishes not only PAF-induced ischemic bowel necrosis [145], but also PAF-, endotoxin- and human IgC-induced hypotension [146]. In the primate, the antagonist also protects against the PAF-induced airways response [147]. Further studies have shown that SRI 63-072 partially inhibits dermal extravasation in the reverse, passive Arthus reaction in guinea-pigs [148] and rats [149], and also in this latter species diminishes glomerulonephritis induced by immune complexes. SRI 63-072, similar to SRI 63-119, does not exhibit enantiospecificity either *in vitro* or *in vivo* [136].

The closely related *cis*-2,5-disubstituted tetrahydrofuran analogue, SRI 63-441 (9a), is a more potent PAF antagonist. It inhibits PAF binding to human platelets with an IC_{50} value of $0.35 \mu M$ [150] and PAF-induced guinea-pig, rabbit, dog, baboon and human platelet aggregation with IC_{50} values of 0.3, 0.8, 10.2, 0.3 and $3.3 \mu M$, respectively. *In vivo* SRI 63-441 effectively inhibits many of the PAF responses in the guinea-pig, rat, dog and primate [151]. However, the antagonist does not block the acute IgE-mediated airways response to *Ascaris suum* [152] and has no effect on the allergen reaction in awake dogs with natural asthma [153]. It also fails to prolong renal xenograft survival and function in a model of pig-to-dog heterotransplantation [154].

SRI 63-675 (9b), the *cis*-2,5-dimethyl analogue of SRI 63-441, shows a similar profile of activity against PAF-induced bioactions both *in vitro* and *in vivo* [115]. For example, at doses of 0.1 mg/kg i.v., SRI 63-675 prevents PAF-induced airway microvascular leakage of colloidal carbon tracer in the tracheobronchial region of conscious guinea-pigs [155]. We have also recently developed a series of tetrahydrofuran-containing antagonists as exemplified by BN 55009 (10) and the pharmacological activity is currently being investigated.

BN 52111 (11) and related analogues which contain a 1,3-dioxolane ring are another series of PAF inhibitors developed by our laboratories [156]. BN 52111 inhibits [3H]PAF binding to its rabbit platelet membrane receptor and PAF-induced aggregation of this cell type with IC_{50} values of $0.35 \mu M$ and 0.4 nM, respectively. The antagonist also blocks PAF-induced aggregation of rat neutrophils *in vitro* (IC_{50} value = $0.5 \mu M$), prevents calcium mobilization evoked by PAF in washed rabbit platelets and enhances binding of benzodiazepine to their receptors in the rat cortex. When supplied intravenously, BN 52111 and analogues prevent PAF-induced thrombus formation in the rat mesenteric artery and counteract PAF-induced bronchoconstriction and hypotension in the guinea-pig [156]. However, the antagonists in this interesting series are inactive when administered orally and also show a high degree of toxicity, and thus are not likely to constitute future pharmacological agents.

Interestingly, moderate PAF antagonism has also been reported for a series of 1,4-dioxanes, of which (12) is representative [111].

Developed by Sankyo, the tetrahydropyran-based constrained framework antagonist (13a) inhibits hypotension induced by PAF (ED_{50} value = 0.8 mg/kg, i.v.) or endotoxin (ED_{50} value = 0.058 mg/kg, i.v.) in the rat [157]. The related oxethane derivative (13b) also displays similar PAF antagonistic activity.

The novel piperidine derivative SRI 63-073 (14) was designed by including a polar head of thiamine phosphate in the modified PAF framework [158]. This compound has a relatively low potency, inhibiting PAF-induced aggregation of human and guinea-pig platelets with IC_{50} values of 37 and 15 μ M, respectively. Although five-membered cyclic phosphorodiamidic-derivatives of this compound are devoid of any PAF-antagonistic activity, six-membered cyclic phosphates, especially the equatorial isomer, Ro 18-6977 (15), has an IC_{50} value of 2.1 μ M against PAF-induced rabbit platelet aggregation [159].

Finally, with respect to the family of constrained antagonists, the Sandoz piperidine derivative SRI 62-586 (16) shows moderate inhibition of PAF-induced human platelet aggregation (IC_{50} value = 32.6 μ M) and [3 H]PAF receptor binding (IC_{50} value = 22.7 μ M) [112]. Administered to guinea-pigs at 2.45 mg/kg i.v., it inhibits PAF-induced haemoconcentration by 70% and increase of pulmonary inflation pressure by 85% [112].

SYNTHETIC ANTAGONISTS UNRELATED TO THE PAF FRAMEWORK

There are relatively few PAF inhibitors which are not structurally related to the mediator itself or to the various naturally occurring antagonistic compounds. However, although small, this significant group contains antagonists including 48740 RP, which derives from a (3-pyridyl)-1*H*,3*H*-pyrrolo[1,2-*c*]thiazole framework, the calcium channel blocker, diltiazem [159a], and various benzodiazepine-derived pharmacological agents such as WEB 2086, which exhibits highly potent PAF antagonistic properties

48740 RP (17a) inhibits PAF-induced human (IC_{50} value = 69 μ M) and rabbit (IC_{50} value = 16 μ M) platelet aggregation, binding of [3 H]PAF to rabbit platelets (K_i = 2.3 μ M) [116, 160] and PAF-elicited elastase release by human neutrophils [161]. At 10 mg/kg i.v., the antagonist suppresses PAF-induced bronchoconstriction in the guinea-pig [160] and thrombocytopenia in the rabbit [116]. Recently, a more potent analogue has been reported; 52770 RP (17b) inhibits [3 H]PAF binding on crude rabbit membranes preparation with a K_i of 7 nM [162, 163]. The (+)-52770 RP isomer is *ca.* 300-times more potent

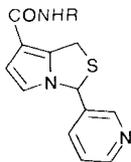

(17a) RP 48740 R = H

(17b) RP 52770 R = *m*-Cl-C₆H₄

(18) diltiazem

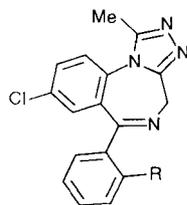

(19a) alprazolam R = H

(19b) triazolam R = Cl

than the (-)-isomer at displacing [³H]52770 RP from intact rabbit platelets [164].

Diltiazem (18), a drug used clinically as a Ca²⁺ antagonist, shows selective and competitive inhibition of PAF-induced aggregation of human (IC₅₀ value = 28 μM) and rabbit (IC₅₀ value = 13 μM) platelets and inhibits [³H]PAF binding to human platelets (IC₅₀ value = 47 μM) [165]. The PAF antagonistic properties of diltiazem and other Ca²⁺ channel blockers suggest that the PAF receptor and membrane Ca²⁺ channels may be linked in some way in the platelet [165].

The triazolobenzodiazepines alprazolam (19a) and triazolam (19b) are widely used psychotropic drugs. These compounds are also specific inhibitors of PAF-induced human platelet aggregation with respective IC₅₀ values of *ca.* 5 and 3 μM [117], rabbit platelet aggregation with IC₅₀ values of 2.5 and 0.6 μM [166], and [³H]PAF receptor binding on human platelets (IC₅₀ values = *ca.* 5 μM and 1 μM) [119]. The inhibitory activity of triazolam against PAF-induced platelet aggregation is not blocked by the benzodiazepine receptor antagonist Ro 15-1788, indicating that the PAF and CNS properties can be separated [167]. Pretreatment with triazolam (20–100 mg/kg *p.o.*) inhibited the intrathoracic accumulation and aggregation of ¹¹¹In-labelled platelets in the guinea-pig after a PAF challenge [168].

Brotizolam (20a) is a thieno[3,2-*f*]-1,2,4-triazolo[4,3-*a*][1,4]diazepine which is clinically useful as hypnotic agent. It inhibits PAF-induced human platelet (IC₅₀ value = 0.54 μM) and neutrophil (IC₅₀ value = 0.21 μM) aggregation [168], and [³H]PAF receptor binding (IC₅₀ value = 0.5 μM) [167]. Administered at 0.05–1.0 mg/kg *i.v.* or 1.0–10.0 mg/kg *p.o.*, brotizolam dose-dependently inhibits PAF-induced bronchoconstriction in the guinea-pig, hypotension in the rat and intrathoracic accumulation of ¹¹¹In-labelled platelets in the guinea-pig [169]. Interestingly, the PAF inhibiting activity of brotizolam is not blocked when co-administered with the benzodiazepine receptor antagonist Ro 15-1788 [167]. Etizolam (20b), another clinically useful drug

administered for relief of anxiety, inhibits PAF-induced rabbit platelet aggregation (IC_{50} value = $1.3 \mu\text{g/ml}$) and at doses of 0.01–1 mg/kg i.v. or 1–10 mg/kg p.o. prevents PAF-induced bronchoconstriction in the guinea-pig, hypotension in the rat, and lethal shock in the mouse [170].

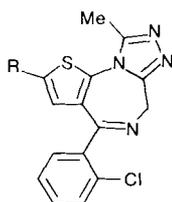

(20a) brotizolam R = Br

(20b) etizolam R = Et

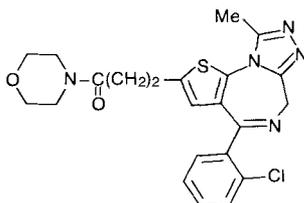

(21) WEB 2086

A separation of the CNS and PAF antagonistic properties in the thienotriazolodiazepine series has been achieved with the synthesis of WEB 2086 (21). This compound selectively inhibits PAF-induced human platelet (IC_{50} value = $0.17 \mu\text{M}$) and neutrophil aggregation (IC_{50} value = $0.36 \mu\text{M}$) and [^3H]PAF receptor binding (K_D = $0.15 \mu\text{M}$) [171]. WEB 2086 inhibits PAF-induced bronchoconstriction (IC_{50} value = 0.07 mg/kg, p.o. and 0.017 mg/kg, i.v.), hypotension (IC_{50} value = 0.066 mg/kg, p.o. and 0.015 mg/kg, i.v.), thrombocytopenia and neutropenia in the guinea-pig [169] and hypotension (ED_{50} value = 0.052 mg/kg, i.v.) in the rat [168]. It also protects against PAF-induced gastric lesions in the rat and mortality in the mouse [169] and intrathoracic accumulation of ^{111}In -labelled platelets in the guinea-pig [172]. In addition, the antagonist protects against *E. coli* endotoxin-induced hypotension in the rat [172], decreases bronchoconstriction and leukopenia induced by antigen in mepyramine-treated passively sensitized guinea-pigs, and decreases the ovalbumin-induced anaphylactic effects in the mouse and guinea-pig [169]. In the rat isolated lungs, WEB 2086 dose-dependently inhibits the increase in PAF-induced pulmonary artery perfusion and bronchial inflation pressure [169].

Restricting the rotation of the alkylene side-chain in WEB 2086 by forming a cyclopentane ring between the αC carbon and C-7 produces WEB 2170 (22a) and the CH_2 analogue STY 2108 (22b). Both WEB 2170 and STY 2108 inhibit PAF-induced human platelet aggregation (IC_{50} value = 0.30 and $0.04 \mu\text{M}$, respectively) with no significant effect on that induced by ADP, adrenaline, collagen, 5-HT, or arachidonic acid [167]. *In vivo*, WEB 2170 and STY 2108 inhibit PAF-induced bronchoconstriction (ED_{50} value = 0.008 mg/kg i.v.,

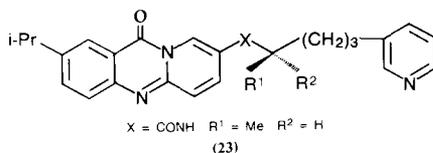
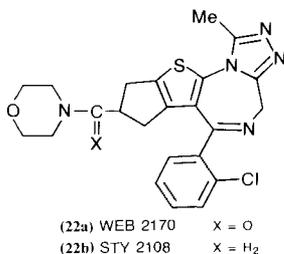

0.16 mg/kg, p.o. and 0.007 mg/kg, i.v., 0.033 mg/kg p.o. respectively) in the guinea-pig, and hypotension (ED₅₀ value = 0.011 mg/kg i.v. and 0.013 mg/kg i.v., respectively), in the rat [173]. *E. coli* endotoxin-induced hypotension in the rat was also blocked in a dose-dependent manner by both compounds [168].

Recently, a series of *N*-[(heteroaryl)alkyl]pyrido[2,1-*b*]quinazolines have been synthesized and evaluated for their PAF antagonistic properties [174]. The most potent compounds in this series were found to be pyrido[2,1-*b*]quinazolin-8-carboxamides possessing a 4- or 6-carbon chain between the carboxamide *N* and a 3-pyridinyl or 5-pyrimidinyl moiety. The most potent antagonists were found to be the racemic compound 2-(1-methylethyl)-*N*-[1-methyl-4-(3-pyridinyl)butyl]-11-oxo-11*H*-pyrido-[2,1-*b*]quinazolin-8-carboxamide (23) and the corresponding (*R*)-enantiomer. These compounds inhibited the binding of [³H]PAF to its receptor on dog platelets with IC₅₀ values of 0.4 and 0.25 μM, respectively. The former of these antagonists (23), also inhibited transient PAF-induced thrombocytopenia and decreases in blood pressure in guinea-pigs after i.v. or oral administration and has a duration of action of over 5 h after an oral dose of 200 mg/kg. Thus, these compounds represent prototypes of a new class of orally active PAF antagonists.

Finally, with regard to synthetic structurally unrelated PAF antagonists, it has been recently reported that a series of 5-aryl-2,3-dihydroimidazo[2,1-*a*]isoquinolines, as represented by (24), display PAF antagonistic properties [175]. However, the effectiveness of these compounds in inhibiting the binding of [³H]PAF to its various receptors remains to be reported.

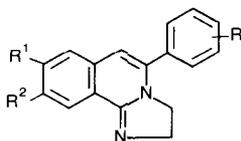

R = H, Cl, alkyl, alkoxy, alkylthio
R¹ = R² = H, Cl, F, alkyl (C₁-C₃)

(24)

NATURALLY OCCURRING PAF ANTAGONISTS AND THEIR DERIVATIVES

The second class of PAF antagonists are natural products and their synthetic derivatives. Indeed, it appears that PAF antagonists may have been amongst the first indigenous natural drugs utilized by man. The Chinese, in particular, have always placed great importance on herbal medicines and still use a considerable number of plants for their medicinal properties. One of the oldest of these natural therapeutic agents is a leaf-extract of the fossil tree, *Ginkgo biloba*. This tree has apparently always been part of the traditional Chinese pharmacopoeia, being referred to in the medicinal book, Chen NOUNG PEN T'sao, published in 2800 BC. In the modern Chinese pharmacopoeia, *Ginkgo* is still recommended as beneficial for the heart and lungs and inhalation of a decoction of the leaves is used to alleviate asthma. Another plant of therapeutic value is *Piper futokadsurae*, which is widely used in Southern China for its antirheumatic and anti-allergic properties.

These plants are of particular importance to the present review; *Ginkgo biloba* provides the only natural source of the unique C₂₀ cage molecules, the ginkgolides, while kadsurenone and other lignans with interesting pharmacological properties have been isolated from *Piper futokadsurae*. These two groups of chemicals, together with some gliotoxin-related compounds produced by various fungi and bacteria, constitute the three groups of naturally occurring PAF antagonists. Indeed, the traditional medicinal properties of the plant extracts can be largely explained by modern pharmacology in terms of their inhibition of PAF-induced bioactions.

GINKGOLIDES

Ginkgolides (25a-e) are unique twenty-carbon cage molecules, incorporating a *t*-butyl group and six 5-membered rings A to F including a spiro[4.4]nonane, a tetrahydrofuran ring and three lactone rings. The *cis*-fused cyclopentanoid rings F,A,D and C are folded in such a way that a semi-spherical cavity of significant size is formed (*ca.* 4 Å wide × 5 Å deep). In relative molecular terms, the cavity is sufficiently large to receive most atoms (for example, Fe²⁺, Ca²⁺) or organic moieties (for example, the trimethylammonium group). The two parallel sides of the cavity are defined by the C₁₁ and C₁₅ lactone carbonyls included in the F and C rings, respectively. The head or the cap of the cavity is defined by rings A and D. The tetrahydrofuran ring (D) occupies a central position in the cage; its ethereal oxygen, along with F and C ring ester oxygens and the C₁₀ hydroxy oxygen constitute a polydentate system similar to that

observed in the crown ether series. This electron rich cavity is ideally suited to the charged binding of cationic or positively polarized molecules. It is important to note that the *t*-butyl group is very prominent outside the main framework. Due to the shape of the cavity, if binding does occur, it may well be stereospecific.

These compounds were first isolated in 1932 by Furukawa [176] from the bitter principles of *Ginkgo biloba*, but their structures have been resolved only recently. In 1967, Nakanishi's group reported their structures and called them 'Ginkgolides A, B, C and M' (25a,b,c,e) [177–181]. These are termed BN 52020, BN 52021, BN 52022 and BN 52023, respectively, in IHB nomenclature. A new ginkgolide, 'J' (BN 52024; 25d) has been recently identified [182]. All these compounds differ only by the number and the position of hydroxy groups, which may be present on C₁, C₃ or C₇ of the spirononane framework.

Compound n ^o	Ginkgolide	IHB nomenclature	R ¹	R ²	R ³
2	A	BN 52020	OH	H	H
3	B	BN 52021	OH	OH	H
4	C	BN 52022	OH	OH	OH
5	J	BN 52024	OH	H	OH
6	M	BN 52023	H	OH	OH
7	synthetic	BN 50580	OH	OMe	H
8	synthetic	BN 50585	OH	OEt	H

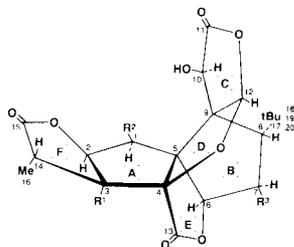

(25) ginkgolides A, B, C, J, M, and the 1-methoxy and 1-ethoxy derivatives of ginkgolide B

The ginkgolide structures, which were deduced mainly by chemical methods [177, 180], have been confirmed by 500 MHz NMR and X-ray crystallography [183]. Recently, very-high-field proton- and ¹³C-NMR experiments have been carried out to determine the unequivocal structural assignment [184]. These high-field studies confirmed the structures already reported, but showed that the stereochemistry of the H/R₂ arrangement at the 1-position of the A ring is the reverse of that previously described. This feature may be important, as OH–OH interactions of the C₁ and C₁₀ positions may influence conformational changes during binding. The structures of compounds (25a–e) presented diagrammatically are those unequivocally determined by high-field ¹³C-NMR.

While *Ginkgo biloba* achieves total biosynthesis of ginkgolides with great ease, it is only recently that chemical synthesis of these compounds has been accomplished. Initially, only the synthesis of hexahydro-5*H*-dicyclopenta[*b,c*]furan-5*a*(6*H*)-ol, which represents the main framework of ginkgolides (rings A,B,D), was achieved [185]. Recently, however, using a sophisticated

and elegant synthetic pathway, comprising more than twenty steps, the first total synthesis of ginkgolide B has been accomplished [186].

Structure-activity relationships of ginkgolides

Ginkgolides inhibit the binding of [^3H]PAF to its membrane platelet receptor [187, 188]. This inhibition is competitive, ginkgolides displacing [^3H]PAF in an excess of unlabelled PAF. The IC_{50} values obtained are 0.25, 0.74, 7.1 and 54.0 μM for BN 52021, BN 52020, BN 52022 and BN 52024, respectively [187]. Characterized by the presence of two hydroxy groups on C_1 and C_3 , ginkgolide B is the most powerful antagonist. Conversely, BN 52022 and BN 52024 which have a hydroxy group on C_7 , in the α position of the lipophilic *t*-butyl moiety, are less active. As for BN 52024, the loss of the hydroxy group on C_1 further decreases the activity in comparison with BN 52022. The 1-methoxy (BN 50580; 25f) and 1-ethoxy (BN 50585; 25G) derivatives of BN 52021 have also been prepared and show activity similar to that of the natural product (P. Braquet, unpublished data).

A substantial loss of antagonism is also apparent after opening of the ginkgolide lactone rings. Relative to the natural product, the inhibitory activity of BN 52021 (10 μM) with opened lactone rings on PAF-induced rabbit platelet aggregation is decreased by 64% and the IC_{50} is shifted to 0.2–0.8 mM (M.T. Domingo, personal communication).

It is interesting to note that the ginkgolide structure bears a close resemblance to that of bilobalide, another sesquiterpene found in *Ginkgo biloba* which contains three γ -lactone rings and a *t*-butyl group but which is devoid of the spiro[4.4]nonane nucleus and tetrahydrofuran cycle [189]. Interestingly, bilobalide does not inhibit PAF-induced platelet aggregation, suggesting the importance of the two latter moieties for activity (P. Braquet, unpublished data).

The fact that BN 52021 displaces the [^3H]PAF from its receptor like unlabelled PAF in both human [120, 190] and rabbit [187] platelets further demonstrates its high specificity as an antagonist. The potent binding capacity of BN 52021 to PAF receptors is also evidenced by the fact that platelets pretreated with the antagonist and then washed do not respond to further stimulation by PAF [120, 190].

These binding data are further corroborated by the results on the inhibition of PAF-induced aggregation of washed human [120, 190] and rabbit [187] platelets. BN 52021 is the most efficient compound with IC_{50} values of 1.8 and 0.18 μM for human and rabbit platelets, respectively. BN 52022 is the least effective, with IC_{50} values of 12.1 and 1.53 μM , respectively, for inhibition of

aggregation of the above cell types. The antagonism induced by ginkgolides is specific for PAF; they do not inhibit other pro-aggregating agents such as ADP, collagen, arachidonic acid, thrombin and A23187.

Pharmacological properties

BN 52021 and related ginkgolides are the most advanced PAF antagonists in terms of pharmacological and clinical investigation. A complete description of their pharmacology is beyond the scope of the present review and thus in this section their effects on processes such as airway hyperreactivity, shock, cellular immunity, cardiac anaphylaxis, kidney physiology and cerebral ischaemia are only briefly considered. For a more extensive review of the effects of BN 52021 on the above pathologies and other biological processes, the interested reader is referred to a recent publication edited by Braquet [191].

The importance of PAF in airway hypersensitivity has been confirmed by the protective effect exerted by BN 52021 and related ginkgolides [192] in: (i) PAF-induced bronchoconstriction and airway hyperreactivity in both humans and animals; (ii) various models of immune anaphylaxis and airway hyperreactivity in animals; and, as we shall discuss later (iii) antigen-induced bronchial provocation tests in asthmatic patients.

BN 52021 given i.v. (0.5 to 2 mg/kg) or orally (5 to 15 mg/kg) dose-dependently antagonizes both the cardiovascular impairments and the bronchoconstriction induced by PAF [187, 193]. For example, BN 52021 administered at a dose of 2 mg/kg i.v. almost completely prevents the lowering of blood pressure, alterations in heart rate and the bronchoconstrictive effect on PAF. Furthermore, BN 52021 significantly inhibits the PAF-induced airway vascular permeability [194, 195] and hypertension and oedema in isolated perfused lungs [196]. The effect of BN 52021 results from its high binding capacity to the PAF lung receptor. Interestingly, synthetic products which are better inhibitors of the binding of [³H]PAF to platelets such as L-652731, L-653150, SRI 63441 and Ro 193704 have a lower affinity for pulmonary PAF receptors, suggesting the existence of a receptor subtype in the lungs different from that detected in platelets. This may explain why BN 52021 is more effective than other antagonists in immune lung anaphylaxis [197].

BN 52021 also antagonizes PAF-induced airway hyperresponsiveness in guinea-pigs, its effect again being greater than those of other PAF antagonists like L-653731, kadsurenone, 48740 RP (C. Touvay, unpublished data). BN 52021 also dose-dependently prevents thrombopenia, leukopenia and the increase in circulating thromboxane induced by PAF [198]. The antagonistic activity of BN 52021 seems to be long-lasting, since bronchoconstriction is still

markedly inhibited after 40 min [199]. In these studies, the order of antagonistic activity observed is: BN 52021 > BN 52020 > BN 52022 > BN 52024.

In isolated perfused lungs, PAF activates the arachidonic acid cascade with a dose-dependent generation of thromboxane, suggesting that the lungs stimulated by PAF participate in the production of lipidic substances which are detrimental to the cardiovascular and respiratory functions [200]. BN 52021 suppresses the PAF-induced generation of thromboxane without affecting the conversion of arachidonic acid [201, 202]. Thus it seems likely that BN 52021 does not interfere with cyclooxygenase but rather at an early step involving PAF receptors and phospholipase activation.

Eosinophil infiltration is a major feature of asthma and allergic reactions [203]. These cells are not abundant during the acute phase of the response, but increase in number and account for 10–80% of the total cell infiltrate during the late phase. Furthermore, major basic protein (MBP), which is released from eosinophil granules, causes respiratory epithelial damage [204]. Since PAF is a potent activator of eosinophil functions [205], BN 52021 may interfere with the late phase response.

Ginkgolides also inhibit antigen-induced pulmonary impairments. BN 52021 given i.v. (0.1 to 2 mg/kg) or orally (10 to 15 mg/kg) significantly antagonizes both homologous [206, 207] and heterologous [186] passive anaphylaxis in guinea-pigs. This antagonist (2 to 4 mg/kg, i.v.) also prevents mortality and counteracts the sustained bronchoconstriction observed in actively sensitized guinea-pigs [199].

The protective effect of BN 52021 and other ginkgolides (mainly BN 52020) on immune bronchoconstriction is associated with the return to normal of blood pH, p_{O_2} and thromboxane B_2 (TxB_2) levels impaired by antigen challenge [201]. Interestingly, in passive anaphylaxis, BN 52021 moderately antagonizes the antigen-induced thrombopenia but the accompanying leukopenia is unaffected [193, 207]. BN 52021 also antagonizes immune bronchoconstriction when antigen is given by aerosol in passively sensitized guinea-pigs [140].

BN 52021 inhibits antigen-induced TxB_2 , 6-keto-PGF_{1 α} , and prostaglandin E₂ (PGE₂) formation by isolated lungs from both passively [207] and actively [208, 209] sensitized guinea-pigs. This effect of the antagonist is not due to thromboxane synthetase or cyclooxygenase inhibition, since the drug is completely inactive against the arachidonic acid (AA) cascade when AA is used for lung challenge [198]. In active anaphylaxis of guinea-pig isolated lung, leukotriene B₄ and D₄ (LTB₄ and LTD₄) formation is also antagonized by BN 52021 [210]. The protection exerted by BN 52021 seems to result from

either a specific, PAF independent effect, since it blocks IgE-induced histamine release in rat mast cells [211] or a PAF-dependent phenomenon, as the mediator and LTD₄ may be able to evoke histamine release in lung tissue of sensitized animals [212]. Formation of PAF by a lung component may thus contribute to histamine release in anaphylaxis and BN 52021 may exert a protective effect by modulating this process.

In addition to air hyperreactivity, ginkgolides also protect against endotoxin and IgG-induced shock. In endotoxic shock, BN 52021 provides significant protection both preventively and curatively. In rats treated preventively (5 to 15 mg/kg, s.c.; 10 to 30 mg/kg, p.o.) 30 min before injection of *Salmonella enteritidis* endotoxin (16 mg/kg, p.o.), a significant dose-dependent inhibition of the lethality is observed, complete protection being provided by the highest dose of the antagonist [213, 214]. The other ginkgolides, BN 52020 and BN 52022 do not afford any protection at 20 mg/kg (orally, 30 min before endotoxin). However, they do act synergistically with BN 52021 (A. Etienne, unpublished data), an effect also observed with a combination of BN 52021 and indomethacin. In guinea-pigs injected with *Salmonella thyphimurium* endotoxin, protection by BN 52021 is also observed [215, 216], this being accompanied by a partial inhibition of the associated thrombopenia and leukopenia. In platelet-depleted animals, BN 52021 affords total protection against the drop in arterial pressure, suggesting that platelets contribute to hypotension by the release of an unknown factor, not inhibited by ginkgolide B [215, 216].

Administered curatively in the late phase of shock, BN 52021 (6 mg/kg, i.v.) is able to restore arterial pressure, the latter parameter returning to basal levels immediately following injection of the antagonist [215, 216]. An identical curative effect is observed when BN 52021 is administered after injection of PAF or aggregates of human IgG [217]. In the dog kidney, BN 52021 significantly restores the functional alterations induced by a local injection of endotoxin in the renal artery *in vivo* (A. Etienne, unpublished data), while in the guinea-pig lung, the antagonist dose-dependently inhibits platelets accumulation after endotoxin aerosol [218]. BN 52021 (5 mg/kg, i.v., 5 min before challenge) also inhibits the haemodynamic changes induced by i.v. injection of 40 mg/kg of human IgG aggregates in rats [217]. This protection is accompanied by a significant inhibition of plasmatic extravasation and mortality.

Recent studies with BN 52021 have demonstrated that PAF can modulate various immune processes. BN 52021 can inhibit the suppressive effect of PAF on T-lymphocyte proliferation and cytokine production. When PAF is added to human peripheral blood lymphocyte cultures (containing 5–10% monocytes) stimulated with phytohaemagglutinin (PHA) or concanavalin A (Con A), a non-toxic concentration-dependent inhibition of lymphocyte proliferation is

observed [219]. This effect is prevented by BN 52021. The antagonist also reverses the PAF-induced suppression of interleukin 2 (IL-2) production by human lymphocytes [219, 220]. PAF inhibition of lymphocyte proliferation and IL-2 production appears to be due to the activation of T-suppressor cells [221]. Thus, it is interesting to note that BN 52021 itself generates some suppressor cell activity, although to a lesser extent, than the mediator [221]. BN 52021 also counteracts the effects of PAF on IL-1 production by lipopolysaccharide (LPS)-stimulated human monocytes, inhibiting both its enhancing effect on IL-1 production at low concentrations (1.0 pM to 0.1 nM) and its suppressive action at high concentrations (0.1 nM to 1.0 μ M) [222, 223].

Cell-mediated graft rejection is another area in which BN 52021 has been studied. The antagonist increases cardiac allograft survival in rats, acting synergistically with azathioprine and cyclosporin A (CSA) [224]. BN 52021 also prevents CSA-induced nephrotoxicity without altering the immunosuppressive effect of the drug [225]. In addition, concomitant treatment with CSA and BN 52063 (a ginkgolide mixture of BN 52020, BN 52021 and BN 52022, weight ratio 2 : 2 : 1) produces greater immunosuppression than that induced by CSA alone [226]. Both of these results suggest that PAF may be generated in response to CSA treatment. Although the precise mechanism of ginkgolide protection in graft rejection remains to be defined, it is apparent that these compounds may offer considerable therapeutic potential for treatment of this condition [227].

Studies with BN 52021 are also leading to an improved understanding of the role of PAF in the generation of cytotoxic lymphocytes. The ginkgolide potentiates alloantigen recognition in primary and secondary mixed lymphocyte cultures and enhances the generation of cytotoxic lymphocytes *in vitro* [228], its presence throughout the duration of the culture period having the greatest enhancing effect on cell proliferation. Similar effects are observed in mixed cultures employed to generate cytotoxic T lymphocytes. Again, the presence of BN 52021 throughout the entire culture period produces an enhanced level of cell-mediated cytotoxicity. This potentiating effect of BN 52021 on alloantigen recognition is not due to an enhanced production of IL-2 in the antagonist-treated cultures [228]. Recently, the effect of BN 52021, on *in vitro* rat splenic lymphocyte-induced cytotoxicity of Langerhans islets has been examined [229]. When these latter cells are pretreated with BN 52021 almost total inhibition of cellular destruction relative to the control is observed, representing a direct effect of BN 52021 on the target cells. When splenic lymphocytes are pretreated with BN 52021, the inhibition of islet destruction is significant with respect to the control cytotoxicity, but slightly lower than that in the above circumstances. As cytotoxic and/or suppressor T lymphoblasts have been

shown to accumulate around Langerhans islets and thus may participate in development of diabetes, the results [229] provide further support for the use of PAF antagonists in the prevention of the autoimmune form of this disease.

BN 52021 has also been examined in cardiac anaphylaxis. The PAF-induced decrease in myocardial contractility and coronary flow in the perfused guinea-pig heart is antagonized by BN 52021 and BN 52020 [230–232]. BN 52021 considerably reduces the decrease in contractile force and the rise of perfusion pressure due to antigen challenge of perfused hearts from passively sensitized guinea-pigs [233]. In hearts from actively sensitized animals, BN 52021 also inhibits the antigen-induced increase in coronary perfusion pressure, this protection being accompanied by a decrease in the release of histamine and TxB_2 [234]. It should be noted, however, that reduction in histamine and TxB_2 release is not a consistent feature of protection by BN 52021 against PAF-induced bioactions [234].

The discovery that PAF is operative in kidney pathophysiology has led to a number of studies on the effects of ginkgolides on kidney disorders. PAF is released by isolated perfused rat kidneys and glomeruli, as well as by suspensions of medullary cells, although not by tubules, upon stimulation with the calcium ionophore A23187 or antigen, when the organ originates from immunized animals [25, 235]. Indeed, the mesangial cells appear to be the major source of PAF in the glomerulus [236, 237]. BN 52021 and other ginkgolides effectively inhibit PAF-induced release of TxB_2 and prostaglandins from primary cultures of human and rat glomerular mesangial cells [238]. BN 52021 also inhibits PAF-induced formation of reactive oxygen species from cultured mesangial cells and the decrease in planar surface of the glomeruli [239]. In addition, this antagonist inhibits PAF-induced decreases in renal blood flow, glomerular filtration and urinary sodium excretion [240, 241].

Evidence for the involvement of PAF in renal immune injury has been provided by the observations that PAF is released during kidney hyperacute allograft rejection [242]. It has been proposed that PAF participates in glomerular immune complex deposition in experimental serum sickness [243] and in systemic lupus erythematosus [33]. The use of BN 52021 upholds this assumption, since the antagonist reduces proteinuria and the histopathological lesions in models of nephrotoxic serum in rabbits [244]. Given preventively, or even curatively, BN 52021 (5 mg/kg, i.p.) abolishes the adriamycin-induced lethality and proteinuria in rats [244]. This protection is associated with a significant reversal of the ultrastructural glomerular alterations induced by the drug. Also in this species, BN 52021 (1 mg/kg preventively, or curatively, 6 h after challenge) prevents acute renal failure induced by glycerol injection [245].

As we have seen, a potential role for PAF in the central nervous system was

first suggested by the discovery that pharmacological agents such as doxepin [102], alprazolam and triazolam [117] and WEB 2086 [118, 119] antagonize PAF. Results obtained with BN 52021 and related ginkgolides confirm the involvement of PAF in panic disorders [246]. In mice, administration of ginkgolides does not modify the behavioural pattern (open field, tetrabenazine test, electroconvulsive shock) or induce myorelaxation. However, in the despair test, even at very low doses (1 mg/kg, p.o.), BN 52021 significantly reduces the immobility of the animals [247], a similar result being obtained with imipramine. The range of antagonist activity in this test is BN 52021 > BN 52020 > BN 52022 > BN 52024, which corresponds to the same range of activity as that reported for the inhibition of [^3H]PAF binding to its receptor.

In rabbits, PAF injection induces a rapid and transient biphasic (decrease/increase) impairment of p_{O_2} and cerebral blood flow, a phenomenon antagonized by BN 52021 (R. Bourgain, personal communication). PAF injection in brain also induces a substantial extravasation which is also prevented by BN 52021 [248]. *Ginkgo biloba* extract (GBE 761) improves cerebral metabolism [247] and protects brain against hypoxic damage [249] in various models of cerebral ischaemia. Again, this protection appears to be mainly due to the PAF antagonistic properties of the ginkgolides. In gerbils, BN 52021 and related ginkgolides, given preventively (10 mg/kg, p.o.), significantly antagonize cerebral ischaemia produced by bilateral ligation of the common carotid arteries [250].

As observed in cerebral ischaemia, BN 52021 antagonizes lipid peroxidation in intestinal ischaemia [251]. Oxygen free-radicals play a very important role in ischaemic diseases and there is much evidence that degradation of membrane lipids and accumulation of free fatty acids (FFA) contributes to the pathological consequences of brain injury [252]. PAF is a potent amplifier of the leukocyte respiratory burst since at very low doses (0.10 fM to 10 pM), it dramatically potentiates the release of O_2^- and OH^\bullet from PMNL induced by various stimuli [253]. BN 52021 can inhibit this activity and this may explain why the PAF antagonist, which is not a direct free radical scavenger, inhibits lipid peroxidation occurring in post ischaemic lesions. It has recently been demonstrated that in the gerbil brain BN 52021 attenuates ischaemic injury-induced activation of phospholipase A_2 , which mediates the release of polyunsaturated fatty acids. Phospholipase C activity also appears to be reduced as levels of phosphatidylinositol 4,5-bisphosphate (PIP_2) are increased in BN 52021-treated animals [254].

LIGNANS

Natural lignans and neolignans are an immense chemical family formed by the oxidative dimerization of various C_6C_3 phenols [255]. The distinction between the terms lignan and neolignan has led to much confusion over the years, since at least two conflicting definitions have been proposed. Traditionally, the term lignan was reserved for compounds in which the two C_6C_3 units are linked by a bond connecting the central β -carbon atoms of each side-chain [256]. The term neolignan was introduced to designate compounds in which the two C_6C_3 units are not linked by a β - β bond [257, 258]. Recently, however, lignans have been defined as being formed by oxidative coupling of cinnamyl alcohols and/or cinnamic acids, while neolignans as originating from oxidative coupling of propenylphenols and/or allyl phenols [259]. As pointed out by Ward [260], in an extensive review of the synthesis of these compounds, the latter definition does not identify any fundamental chemical difference between the two series of compounds and thus the former definition is preferred.

Lignans and neolignans have attracted much interest over the years because of their widespread occurrence in nature and broad range of biological effects. Several lignans and neolignans are known to exhibit antitumour activity [261–265] and inhibit fungal growth [266, 267].

Benzofuranoid lignans

A neolignan isolated by the Merck group from the plant *Piper futokadsurae*, was the first natural product discovered as a potent inhibitor of the binding of [3H]PAF to rabbit platelet membrane preparation with an IC_{50} close to $0.1 \mu M$ [268]. Named kadsurenone (26), it was also shown to be a specific and potent inhibitor of PAF-induced rabbit platelet aggregation with an IC_{50} value of $0.99 \mu M$.

This result reflects the potent effect of kadsurenone in inhibiting the binding of [3H]PAF to both its platelet and lung receptors [269, 270]. The weak activity of several related compounds isolated from the same plant (for example, kadsurin A, kadsurin B, and piperenone; 27, 28 and 29, respectively) and several synthetic analogues with altered stereochemistry or ring substituents demonstrate the chemical specificity of kadsurenone. Only the dihydro derivative, obtained by hydrogenation of the allyl side-chain, retains full activity [271]. The inversion of the configuration at either the 2- or 3a-position results in a significant decrease of activity. Furthermore, the 6-oxo group appears fundamental for antagonism, since the related methoxyamino or alcohol analogues are only weak inhibitors. Interestingly, desallylkadsurenone is relatively

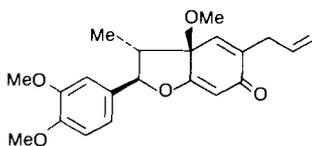
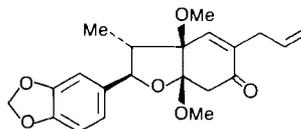
(26) kadsurenone
(mirandin series)

(27) kadsurin A

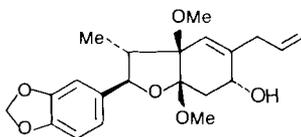

(28) kadsurin B

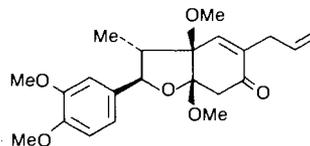

(29) piperenone

inactive, indicating the contribution of a lipophilic allyl or propyl side-chain at the 5-position [49].

Kadsurenone inhibits PAF-induced aggregation and degranulation of human neutrophils [268]. In the Langendorff preparation of isolated guinea-pig heart perfused at constant pressure, kadsurenone ($1 \mu\text{M}$) effectively antagonizes the PAF-induced decrease in contractility and coronary flow [272]. The neolignan is also active in antagonizing various PAF-induced phenomena such as increases in cutaneous permeability in the guinea-pig [273] and elevated hematocrit and circulating *N*-acetylglucosaminidase levels in the rat. Kadsurenone also partially antagonizes endotoxic shock in this species [274]. However, the compound has a relatively short duration of action, with a half-life from 30 min to 2 h in animals. In a study on rhesus monkeys, metabolism has been observed by alkyl side-chain oxidation and glucuronide formation (K. Thompson, personal communication).

Recently, the structure-activity relationships of the benzofuranoid series has been extended [275]. Generally, placement of the allyl chain on position 3a of the benzofuranoid framework (kadsurenone (26), burchellin (30) and

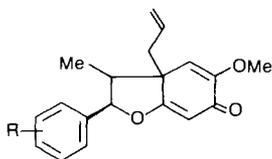

(30) burchellin series

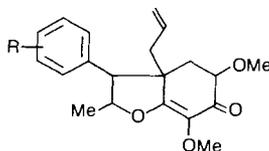

(31) chrysophyllin series

chrysophyllin (31) series), decreases activity. A similar result is obtained by changing the position of the aryl group from C₂ (mirandin (kadsurenone, 26) and burchellin (30)) to C₃ (chrysophyllin series (31)). In agreement with these considerations, megaphone, a benzofuranoid lignan extracted from *Aniba megaphylla*, displays only a moderate activity (A. Esanu and P. Braquet, unpublished data).

Substituted furanoid lignans

Several structures in this lignan series are also potent PAF-antagonists such as some tetrahydrofuran compounds belonging to types A (32) and C (33) lignans in Haworth's classification. Isolated from *Bursera microphylla* A (Burseraceae), burseran (34) is a moderate specific inhibitor of PAF-induced rabbit platelet aggregation. Similar results are obtained with 2,3,4,5-tetra-substituted furanoid lignans such as some furoguaiacidin derivatives isolated from *Guaiacum officinale* L. or *Guaiacum sanctum* L. (Zygophyllaceae) or Nectandrin A (BN 52010) and Nectandrin B (BN 52011) isolated from the Brazilian *Nectandra rigida*. Magno-salicin (BN 52004), a 2,3,4-trisubstituted furanoid lignan isolated from *Magnolia salicifolia* and used for treating nasal allergy in China, also has specific PAF antagonizing properties.

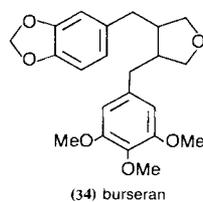
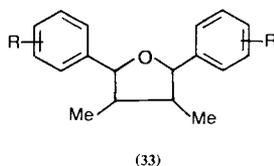
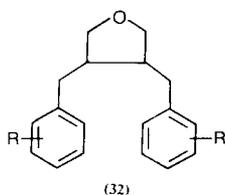

Shen's group synthesized a series of dinor type C tetrahydrofuran lignans ((35) and related compounds). *trans*-2,5-Bis(3,4,5-trimethoxyphenyl)tetrahydrofuran (L-652731; (35a)) is orally active and several times more potent than kadsurenone *in vitro* and *in vivo* [276]. With an IC₅₀ value of 19 nM, it inhibits [³H]PAF binding and is a very potent inhibitor of PAF-induced rabbit and human platelet aggregation. The *trans* isomers are generally 10-fold more potent than the corresponding *cis* isomers in this series. The IC₅₀ value for inhibition of [³H]PAF to its platelet receptor is increased by three orders of magnitude with the *cis* analogue of L-652731 (22 μM). As demonstrated by Hwang and colleagues [276], aromatic ring substitutions are also relatively specific, with a decrease in OMe substitution generally leading to reduced activity ((35b) and (35c)). With a different methoxy substitution of the phenyl rings (for example,

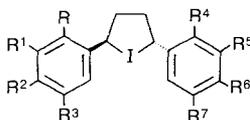

Compound	I	R	R ¹	R ²	R ³	R ⁴	R ⁵	R ⁶	R ⁷	ED ₅₀ [*]
a	O	H	OMe	OMe	OMe	H	OMe	OH	OMe	2 × 10 ⁻⁸ M
b	O	H	H	OMe	OMe	H	H	OEt	OMe	2 × 10 ⁻⁷ M
c	O	H	OMe	OMe	OMe	H	OMe	H	OMe	8 × 10 ⁻⁷ M
d	O	H	OMe	OEt	OMe	H	OMe	H	OMe	4 × 10 ⁻⁷ M
e	O	H	OMe	O <i>i</i> -Pr	OMe	H	OMe	O <i>i</i> -Pr	OMe	3 × 10 ⁻⁵ M
f	O	H	OMe	OMe	OMe	OMe	H	OMe	OMe	<30 μM
g	O	OMe	OMe	OMe	H	OMe	OMe	OMe	H	1 × 10 ⁻³ M
h	O	H	OMe	OMe	OMe	H	SO ₂ Me	OPr	OMe	3 × 10 ⁻⁹ M
i	S	H	OMe	OMe	OMe	H	OMe	OH	OMe	2 × 10 ⁻⁸ M
j	CH ₂	H	OMe	OMe	OMe	H	OMe	OH	OMe	2 × 10 ⁻⁸ M

* ED₅₀ values for inhibition of [³H] PAF binding to rabbit platelet membranes.

(35) and related compounds

positions 2,3,4), the bistrimethoxyphenyl isomer of L-652731 (35g) is three orders of magnitude less efficient than the corresponding bis-3,4,5-trimethoxyphenyl analogue. Similarly, the substitution of methoxy groups by isopropoxy moieties significantly reduces activity (35e).

The most potent member of this series synthesized to date is *trans*-2-(3-methoxy-5-methylsulphonyl-4-propoxyphenyl)-5-(3,4,5-trimethoxyphenyl)tetrahydrofuran (L-659989; (35h)). This inhibits ³H-binding to rabbit platelet membranes with an ED₅₀ value of 3 nM and prevents PAF-induced extravasation and lysosomal enzyme release in rats when the antagonist is infused i.v. 1 min before PAF administration [277]. L-659989 is also orally active in female (ED₅₀ value = 0.2 mg/kg), but not in male rats, with an oral duration of action of 12–16 h when given p.o. at a dose of 1 mg/kg. The origin of this gender difference is presently unknown.

Recently, the thioisoster of 35a, *trans*-2,5-bis(3,4,5-trimethoxyphenyl)tetrahydrothiophene, was synthesized [278]. Denoted L-653150 (35i), it was found to inhibit the binding of 1 nM [³H]PAF to isolated rabbit platelet membranes with an IC₅₀ value of 19 nM. In addition, it inhibited the rat basophilic leukaemia cell 5-lipoxygenase catalyzed transformation of [¹⁴C]arachidonic acid to 5-HETE with an IC₅₀ value of 5 μM [278]. The superior efficacy and longer duration of action of L-653150 as compared with those of L-652731, was demonstrated in a variety of *in vitro* (PAF-induced human neutrophil degranulation and aggregation of rabbit platelets, human PMNL and guinea-pig PMNL) and *in vivo* (PAF-induced enzyme release, vascular permeability and hypotension) assays. In addition to the thioisoster of (35a), Chaing *et al.* [279]

have reported that the cyclopentane isoster (35j) and derivatives are also specific PAF antagonists. The substitution of H borne by CH_2 in position 1 with various groups possessing a heteroatom (N or O) can reinforce the inhibitory activity, providing the steric hindrance is relatively small and lipophilic. In contrast to these data, we have recently observed that other lignan series such as tetralines, dibenzo[4,5,6,7]cyclooctadienes (stegane-derived compounds) and furo[3,4-*c*]furanoids do not have any significant effect on PAF-induced rabbit platelet aggregation (P. Braquet, unpublished data).

Dibenzylbutyrolactone (butanolide)-derived lignans

Most lignans originate from higher plants; recently, however, these compounds have also been identified in human and animal urines [280, 281]. These lignans (see (36) and related compounds) are characterized by the presence of a dibenzyl- γ -butyrolactone framework and one *meta*-OH group in each aryl ring [282]. The main lignan identified in mammalian urine is enterolactone [280, 281]. Methyl derivatives have also been detected in minor quantities [281]. These lignans are weak inhibitors of PAF-induced rabbit platelet aggregation with an IC_{50} value of 1 mM [283].



Enterolactone and other mammalian lignans

R	R ¹	R ²	R ³	R ⁴	PRODUCT	ORIGIN
H	H	H	H	H	Enterolactone	Mammalian urines
Me	H	H	H	H	3-O-methylenterolactone	Mammalian urines
Me	H	H	H	Me	Di-O-methylenterolactone	Mammalian urines
Me	OMe	H	OMe	H	Prestegane A	Mammalian urines
H	OMe	H	OMe	H	Prestegane B	Mammalian urines
Me	OMe	H	OMe	Me	Di-O-methylmatairesinol	and Steganotaenia araliacea
Me	OMe	OMe	OMe	Me	5'-methoxymatairesinol	Synthetic

(36) and related compounds

The biological role of mammalian lignans has never been clearly evaluated; however, their renal excretion increases during the luteal phase of the menstrual cycle and pregnancy in woman and the vervet monkey [280, 281]. In contrast, decreased levels are observed in postmenopausal women and during breast cancer [284]. It is also of interest to note that some lignans may exert a protective effect against intestinal cancer [285]. Various authors have drawn attention to the structural analogy between mammalian lignans and digitalis, since these two classes of compounds have a common lactone cycle, a butanolide and butenolide, respectively [47]. These chemical similarities suggest that mammalian lignans could interact at the digitalis receptor site of the Na^+/K^+ pump. Indeed, these lignans have been reported to inhibit this

pump in human erythrocytes and human and guinea-pig hearts [286], suggesting that PAF may influence K^+ movements [84]. In a detailed study of their action on the Na^+/K^+ pump in human erythrocytes, an inhibition by 3-*O*-methyleterolactone, prestegane B and enterolactone with decreasing potentiality (IC_{50} values ranging from 0.5 to 9.0 mM) was noted [286]. In the same system, the IC_{50} value for ouabain ($0.7 \mu M$) was not modified by the lignans, indicating a non-competitive inhibition. It thus appears that these compounds do not act at the digitalis receptor site. As the level of mammalian lignans is high during early pregnancy [280, 281], it has been postulated that these compounds may produce a negative feedback against PAF and plasminogen released during pregnancy [47]. However, at the present time, their physiological role and possible relationship with PAF or the proposed, but unidentified, endogenous digitalis is still unknown.

GLIOTOXIN-RELATED PRODUCTS

Gliotoxin (37) and other epipolythiodioxopiperazines (ETPs) are toxins produced by a wide range of fungi. This group of chemicals has received considerable attention due to their various biological activities [287]. Indeed, the inhibitory effects of gliotoxins on fungal growth were first reported by Weindling in 1932. The biological effects of ETPs include inhibition of proliferation of some viruses, bacteria, fungi and mammalian cells. The structural feature common to this group of toxins is the ETP nucleus, and the critical role of the sulphur bridge in the biological activity has been demonstrated by chemical modifications (methylation or elimination of the sulphur) which diminish the effects of the toxins on virus, bacteria and eukaryotic cell growth [288–290].



(37) gliotoxin

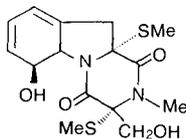

(38) FR 49175

With the biological activities of the ETP series being well-defined, it is of particular interest to note that researchers of the Fusijawa Pharmaceutical Company recently isolated some PAF antagonists, structurally related to the ETPs from the fermentation products of certain fungi and actinomycetes [291–295]. Most of these products possess a dialkylthiopiperazinedione skeleton and are derived from bis(dethio)bis(methylthio)gliotoxin (FR 49175;

(38)). This was originally isolated from the wood fungus *G. deliquescens* as a minor metabolite [296], but its PAF inhibitory activity was not reported.

The three most potent antagonists have been designated FR 49175 (38) [292, 293], FR 106969 (39) [297] and FR 900452 (40) [294, 295]. Isolated from the culture filtrate of *Penicillium terlikowskii*, *P. citrinum* and *Streptomyces phaeofaciens*, FR 49175, FR 106969 and FR 900452, inhibit PAF-induced rabbit platelet aggregation with IC_{50} values of 4.9, 16.9 and 0.26 μM , respectively. FR 49175 and FR 900452 slightly inhibit collagen-induced aggregation but are inactive against aggregation induced by ADP or arachidonic acid. Interestingly, these compounds do not possess a closed bridge across the ETP nucleus, as the sulphur groups are methylated. Thus, while the sulphur bridge is critical for the toxic properties of the ETPs, its absence is desirable for PAF antagonistic activity. Indeed, FR 49175 is a far more potent PAF-antagonist than gliotoxin, which is relatively inactive.

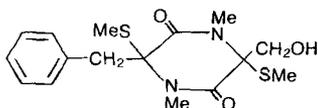

(39) FR 106969

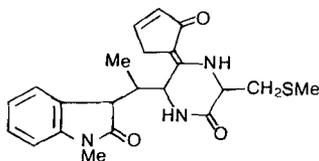

(40) FR 900452

Structure-activity relationships

Various structure-activity relationships have been deduced from studies using synthetic analogues in PAF-induced *in vitro* platelet aggregation [297]. Cleavage of the C-N bond of FR 49175 leads to compounds of the FR 106969 type such as (41) and (42). The IC_{50} values of these compounds are 12.3 and 9.7 μM , respectively, similar to that shown by FR 106969. Alterations at the *para* position of the phenyl ring produce (43a,b,c). The IC_{50} values of these decline from 16.9 to 5.2 μM , indicating that hydrophobic, electron-donating substituents in this position are desirable for activity. Replacing the methylthio groups of (43a) with phenylthio groups to give (44a) doubles the activity. When the phenyl ring *para* position of this compound is substituted as shown (44a,b,c), a similar effect on the resulting IC_{50} values is observed, which decline from 5.2 (44a) to 0.69 μM (44c).

Compound (45) is also inhibitory with an IC_{50} value of 14.5 μM , only 2.8-times less potent than compound (44c). This latter compound (FR 65049) is 6-fold more potent than the natural product, FR 49175, and thus, is the most

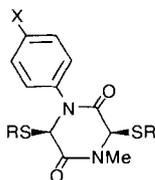
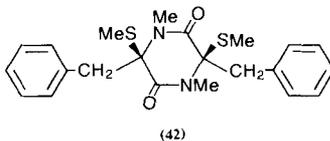
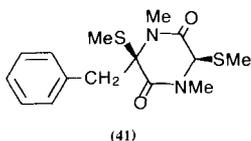

- (43a) X = H, R = Me (44a) X = H, R = Ph
 (43b) X = Cl, R = Me (44b) X = Cl, R = Ph
 (43c) X = OMe, R = Me (44c) X = OMe, R = Ph

active compound in this series. In addition, it is a specific PAF inhibitor, as it has no effect on rabbit platelet aggregation induced by other trigger factors. From a comparison of the structure of FR 900452 with those of (39) and (44c), it was deduced that the oxocyclopentyl residue could be removed in favour of the simpler diketopiperazine itself and further, that the oxyindole moiety could be replaced by other similar aromatic nuclei such as *N*-methylindole and 1-naphthalene without loss of activity [297]. These findings indicate the importance of the substitution of the (*R*) configuration at the C₆ position and the irrelevance of the substitution on the diketopiperazine nitrogens group for the biological activity.

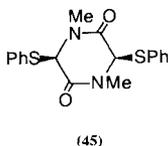

The length of the alkylsulphide chain on the piperazine skeleton also modulates the activity. Thus, the methionine derivative (46e), shows an activity superior to (46a), while the compound without the alkylsulphide is inactive. Antagonistic activity towards PAF is also conferred by the stereochemistry of the tertiary carbon bonded to the aromatic nucleus. Hence, (46g (*R* configuration)) possesses an IC₅₀ value of 0.18 μM and is 10-times more active than the corresponding (*S*) configuration (46h), and (46f) which has no methyl group

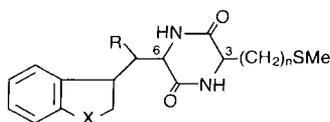

Compound	X	R	n	Configuration		IC ₅₀ μM*
				C-3	C-6	
a	NMe	H	1	S	R	7.9
b	NMe	H	1	R	R	36.0
c	NMe	H	1	R	S	>250
d	NMe	H	1	S	S	142
e	NMe	H	2	R	R	2.1
f	(CH ₂) ₂	H	2	R	R	1.4
g	(CH ₂) ₂	(R)-Me	2	R	R	0.18
h	(CH ₂) ₂	(S)-Me	2	R	R	1.9

* IC₅₀ values for inhibition of PAF-induced rabbit platelet aggregation

(46) and related compounds

at this carbon. Compound 46g (FR 72112) is the most potent derivative in this series, being a specific antagonist of PAF-induced platelet aggregation and 1.5-times more active than the natural product, FR 900452. From the studies on the structure–activity relationship of chemically synthesized derivatives, it can be concluded that the stereochemistry of the diketopiperazine moiety is the most important structural requirement for PAF inhibitory activity [297].

Pharmacological properties

The pharmacology of these PAF antagonists have been examined in various animal models of inflammation and allergy. FR 49175 significantly inhibits PAF-induced bronchoconstriction in guinea-pigs (ED₅₀ value = 0.26 mg/kg i.v.) but fails to prevent PAF-induced hypotension in rats, vascular permeability increase in mice and immune anaphylaxis in guinea-pigs [294, 295]. FR 900452 is also inactive on antigen-induced increase of airway resistance or hypotension [297]. The effect of FR 900452 was also evaluated on carrageenan oedema, passive cutaneous anaphylaxis (IgE-mediated) and the Arthus reaction in rats, where at 10 mg/kg i.v., it does not show any significant activity in these models. However, antigen-induced hypotension in passively sensitized adrenalectomized rats is inhibited by 40% with pretreatment by FR 900452 (10 mg/kg, i.v.). Thus, although this compound appears to be a specific inhibitor of PAF-induced hypotension, it does not suppress that evoked by acetylcholine, histamine, bradykinin or isoproterenol [293, 294].

The antagonistic properties of FR 900452 have also been examined in a model of endotoxin shock, the haemodynamic and haematological manifestations of this condition closely resembling the changes induced by PAF. FR 900452 (10 mg/kg, i.v.) almost completely prevents PAF (1 μ g/kg, i.v.)-induced thrombocytopenia and leukocytopenia in rabbits [295]. It also significantly inhibits endotoxin (*E. coli* LPS, 30 μ g/kg, i.v.)-induced thrombocytopenia but not leukocytopenia. The same dose of FR 900452 also causes the decreased arterial blood pressure to return to normal in the endotoxin-induced rat hypotension model, an effect also reported for other PAF inhibitors [121, 274]. Finally, FR 900452 has been tested for its therapeutic effect on rat nephrosis induced by aminonucleoside (puromycin, 100 mg/kg, i.p.). At 100 mg/kg twice a day orally for 6 days, the agent significantly reduces urinary protein loss in nephrotic rats [298].

With regard to the most potent synthetic derivatives, FR 72112 (46g) showed significant effects on both rat hypotension and mouse vascular permeability tests. This compound inhibited PAF-induced hypotension by 51% (3 mg/kg, i.v.) and the increased vascular permeability by 40% (10 mg/kg, i.v.). However, FR 69049 ((44c); 10 mg/kg, i.v.) failed to inhibit PAF-induced hypotension in rats, suggesting the existence of at least two types of PAF receptor *in vivo*, that is, a platelet type and a vascular type.

Given the recent interest in the potential immunomodulatory properties of PAF, it is interesting to note the specific effects of the ETPs on immune function. The most potent *in vitro* effects of the ETPs are inhibition of proliferation of some RNA viruses [299] and cytopathic effects on mammalian cells in culture [300]. Mason and Kidd [288] reported that exposure of transplantable murine lymphosarcoma cells to gliotoxin, prior to injection of the cells into recipient mice, completely inhibited the subsequent growth of the tumour cells *in vivo*. It has also been demonstrated that gliotoxin, at concentrations lower than 0.1 μ M ml⁻¹, inhibits a number of immune and immune-related functions *in vitro*, including mitogen stimulation of lymphocytes, induction of alloreactive and major histocompatibility complex-restricted cytotoxic T-cell responses in mixed lymphocyte reactions and phagocytosis by macrophages [290]. These latter authors suggested that the *in vitro* immunomodulating activities of gliotoxin may be due to specific effects on macrophages which have an essential role in the induction of cytotoxic T-cell responses.

Although no direct immunoregulatory effects have been reported for the PAF antagonistic bis(dethio)bis(methylthio)gliotoxin derivatives, these compounds may express immunoregulatory activity via their inhibitory effects on PAF. The toxic action of the ETPs may be mediated by molecular oxygen, the oxidation of the dithiol leading to the production of superoxide anion (O_2^-), and subse-

quently to other cytotoxic oxygen species [301]. The unbridged gliotoxin-related compounds may thus be rendered non-toxic by the inability to generate superoxides. However, these compounds are able to antagonize PAF, which itself is a potent inducer of free-radical generation from various cell types. Since various members of this interesting group of natural products show either cytotoxic activity or PAF antagonistic properties, they may prove to be of potential therapeutic value.

CLINICAL TRIALS WITH PAF ANTAGONISTS

It is thus apparent that a diverse range of natural and synthetic compounds antagonise PAF-induced effects in various animal models. Whether any of the existing classes of PAF antagonists constitute therapeutically valuable drugs in man is currently under investigation in various clinical trials. It is interesting to note that the ginkgolides and WEB 2086, which are most advanced compounds in terms of clinical investigation, are antagonists structurally unrelated to PAF. Indeed, PAF analogues with antagonistic activity generally show poor oral absorption, short half-life, irritation at the site of injection, haemolysis and can exhibit potential agonistic activity. Thus, although many PAF-related antagonists are potent and can be synthesized in bulk, their clinical development may be delayed until the former problems can be overcome.

BN 52063 (a standardized mixture of ginkgolides BN 52020, BN 52021 and BN 52022, molar ratio 2 : 2 : 1) was the first drug demonstrated to be a potent PAF antagonist in man [302] and is currently undergoing phase 2 clinical trials. Studies have demonstrated the effectiveness of the drug in preventing various effects of PAF in human volunteers, for example, *ex vivo* PAF-induced platelet aggregation, skin test and bronchoconstriction [303]. In the skin test in atopic patients, BN 52063 inhibits the infiltration of both eosinophils and mononuclear cells induced by PAF challenge. In addition, BN 52063 also counteracts antigen-induced bronchoconstriction in asthmatic patients and antagonizes antigen-induced skin tests. Asthmatic patients treated with BN 52063 require 6-times more allergen to provoke the same degree of bronchial response as those not receiving the drug [303]. Further studies on asthmatics have shown that the ginkgolide mixture administered orally alleviates the prolonged reduction in peak expiratory flow rates observed during asthma. In addition to this effect, when BN 52063 is provided either orally (240 mg) or by inhalation (5 mg) it diminishes the increase in plasma concentrations of platelet factor 4 (PF4) and β -thromboglobulin (β -TGB) observed in exercise-induced asthma (P. Guinot, personal communication).

An open study has also shown that 1 month's treatment of severe asthmatic patients with BN 52063 improves both FEV1 and inhibits eosinophil infiltration induced by PAF in the skin test [188]. In another study, severely asthmatic children were treated with the Ginkgo extract, GBE 761 (1 drop/kg three times a day). Complete recovery was observed in 60% of the children as determined by both clinical and spirometric (FEV1) parameters. Of the remainder, 30% showed moderate improvement and only 10% were resistant to therapy [188].

Very promising preliminary results have also been obtained in various types of shock: the perfusion of IPS 200 (the lyophilized *Ginkgo* extract for parental use) in patients suffering from Atkinson's syndrome (monoclonal gammopathy) led to a very significant improvement in the clinical outcome with normalization of the respiratory functions and decreased requirement of resuscitative fluid [188].

Preliminary studies in man substantiate the *in vivo* immunomodulatory activity of BN 52063 demonstrated in experimental animals. In a randomized double-blind pilot study, 18 healthy male volunteers were treated for 15 days with BN 52063 (80 or 240 mg/day) or placebo ($n = 6$, in each group). Results showed a dose-related reduction in the CD4+ /CD8+ cell ratio on days 4, 8 and 15 in individuals receiving BN 52063, but no change in the control group. With 240 mg/day BN 52063, there was a 43% decrease in the CD4+ /CD8+ T-cell ratio at day 15, a 17.5% decrease with 80 mg/day and a 2.5% decrease with the placebo. The CD4+ /CD8+ T-cell ratio returned to normal values after the end of treatment (P. Guinot, personal communication). This effect may explain the potentiation recorded when the ginkgolide mixture is associated with cyclosporine for the prevention of graft rejection. BN 52063 also counteracts the effects of the benzodiazepine, flunidrazepam, in normal patients, again conforming the findings obtained in animal models which show a decrease of tritiated benzodiazepine binding in the brain of animals treated with BN 52021 [188].

Recently, BN 52063 has been demonstrated to be effective against mastocytosis [304], a condition which was previously incurable. This suggests that PAF, as well as mast cell degranulation, may have a role in systemic mastocytosis. The injectable (pure) form of BN 52021 is much more powerful than BN 52063. Preliminary clinical investigations have shown a long and intense inhibition of *ex vivo* PAF-induced platelet aggregation. The injectable form is now under clinical trials in graft rejection, stroke, haemodialysis and shock.

Very recently, preliminary clinical investigations have commenced with WEB 2086. In a double-blind and placebo-controlled phase 1 clinical trial, the drug completely inhibited PAF-induced *ex vivo* platelet aggregation 45 min after single oral administration of 20–400 mg [305]. The effect of single

increasing intravenous doses infused over 30 min or single increasing inhaled doses of WEB 2086 to human volunteers on *ex vivo* PAF-induced platelet aggregation was also studied in a placebo controlled group comparison with increasing doses [306]. Infusions of 0.5–50 mg WEB 2086 resulted in significant inhibition of platelet aggregation. Even in the lowest group (0.5 mg), PAF-induced platelet aggregation *ex vivo* was inhibited by 68% [306], dose of 10, 20 or 50 mg exhibiting complete inhibition. Inhalative administration of 0.5 mg or 1 mg WEB 2086 inhibited PAF-induced *ex vivo* platelet aggregation by 46% and 64%, respectively, whereas inhalation of single doses of 0.05 mg or 0.25 mg had no significant effect [307].

Dose dependency and duration of PAF-antagonistic action of peroral WEB 2086 in man was also studied in a randomized double-blind, placebo-controlled cross-over study in 12 healthy male volunteers receiving oral doses of 5, 30 or 90 mg of the antagonist. WEB 2086 counteracted *ex vivo* PAF-induced aggregation at all doses tested, maximum inhibition occurring between 1 and 2 h after administration [308]. Magnitude and duration of inhibition was dose-dependent; a significant effect was still detectable 10 h after administration at all three dose levels, and at 12 h after administration at the two highest doses (30 and 90 mg) [308]. In further multiple oral dose tolerance studies, administered at 40 or 100 mg three times (dose interval 8 h), both doses of WEB 2086 caused almost complete inhibition of PAF-induced *ex vivo* platelet aggregation throughout the 7 day study period [309].

With regard to the structural relationship of WEB 2086 to triazolodiazepines, it is interesting to note that up to the highest dose tested (400 mg) no diazepam-characteristic central nervous adverse effects were observed, confirming in man the dissociation of PAF- and benzodiazepine-like effects reported in animals.

Finally, with regard to clinical trials, a 7-day clinical study in four human volunteers administered with 48740 RP at 1000 mg/day orally gave more than 60% inhibition of PAF-induced platelet aggregation and a slight inhibition of TXB₂ production in *ex vivo* studies [310].

CONCLUSION: TOWARDS A MECHANISM OF PAF ANTAGONIST ACTION

In this article, we have presented an overview of the development and pharmacology of the different classes of PAF antagonists. These compounds counteract diverse pathologies in various animal models and are now undergoing clinical investigation in human disease, where the initial results seem en-

couraging. The numerous studies on PAF antagonists reviewed here raise the fundamental question: why are these compounds effective in such a broad range of pathologies? To attempt to answer this question, we must consider the role of PAF in the inflammatory process, the way in which it interacts with other vectors of intercellular communication and how these mediators combine to modulate the activity of the various inflammatory cell types.

Inflammation is usually a tightly controlled process which confines tissue damage, prevents infection and assists in cellular regeneration. However, when the inflammatory response becomes unregulated, this normally beneficial local event may escalate into a wider malignant activity, characterized by endothelial injury, excessive cell infiltration and vascular leakage. These phenomena lead to microcirculatory damage, which is a common factor underlying pathologies such as shock, sepsis, asthma, ischaemia and graft rejection [311]. Neutrophils (PMN) appear to play a particularly important role in these conditions. In the inflammatory microenvironment, PMN become activated by various agonists, adhere to the endothelial surface and release lysosomal proteases. Activated PMN also undergo a respiratory burst, which results in the reduction of molecular oxygen to superoxide. This latter product is rapidly converted to hydrogen peroxide and toxic free radicals which damage the endothelium. As we have seen, PAF is a potent chemotactic agent for neutrophils, inducing superoxide release, aggregation and degranulation in this cell type [311]. PAF is also one of the most active chemotactic factors for eosinophils, cells from which it elicits the release of major basic protein (MBP), free radicals and leukotriene C_4 (LTC_4), products extremely damaging to microvascular integrity [311]. Eosinophil infiltration is another prominent feature of certain inflammatory lesions and may play a particularly important role in asthma and graft rejection.

In addition to directly eliciting cell chemotaxis and free-radical production, PAF can also induce the release of various inflammatory cytokines, amongst which tumour necrosis factor (TNF) is of particular importance [312]. We have recently shown that PAF stimulates TNF production from peripheral blood derived monocytes and at picomolar concentrations amplifies lipopolysaccharide (LPS)-induced TNF production, effects inhibited by various PAF antagonists [313]. PAF also acts synergistically with interferon- γ (IFN- γ) to increase the monocyte cytotoxicity. Furthermore, PAF can modulate the production of both interleukin 1 and interleukin 2 (IL-1, IL-2) from rat monocytes and lymphocytes, respectively [222, 223], cytokines which in turn elicit the release of other mediators and growth factors.

Similarly to PAF, TNF also enhances neutrophil superoxide production and adherence [314]. TNF may also indirectly regulate eosinophil cytotoxicity via

its effect on the release of other cytokines and growth factors. In addition to directly modulating PMN activity, at very low concentrations both PAF and TNF can prime PMN to respond in an enhanced manner to subsequent agonistic stimuli that would otherwise be ineffectual. Amplified responses such as aggregation, adhesiveness and superoxide production have been reported using *N*-formylmethionylleucyl phenylalanine (FMLP) as the inducing agonist following priming with PAF [315]. Furthermore, we have shown that PAF can amplify TNF-induced superoxide generation by human PMN [316], the effect of the mediator being completely abolished by BN 52021, kadsurenone, BN 52111 and WEB 2086. The PAF antagonists also decrease by 50% the superoxide production elicited solely by TNF, indicating that TNF-induced superoxide generation is partially mediated by a mechanism involving endogenous PAF [311].

Apart from inducing vascular damage via infiltration and degranulation of various blood cells, PAF and TNF exert also direct effects in the endothelium. *In vitro*, both substances cause contraction of endothelial cells, which may partially account for the increased vascular permeability and plasma extravasation observed in many species following PAF or TNF administration [311]. While it has been known for some time that endothelial cells produce PAF when stimulated with various agonists such as thrombin, it has recently been established that TNF and IL-1 also induce cultured endothelial cells to synthesize PAF, the majority of which remains associated with the cells [317].

Thus, it is apparent that numerous interactions exist between the mediators and cells involved in the inflammatory response. The fact that PAF is only *one* of the many components in this process cannot be overemphasized. Indeed, we propose that the effectiveness of PAF antagonists is not due to the individual importance of PAF as a mediator of inflammation, but rather because PAF is part of a complex integrated system. The fact that PAF, IL-1 and TNF can induce the release of each other indicates that self-generating positive feedback cycles may become established. PAF and TNF may play pivotal roles in the formation of initial loops, which subsequently recruit other cytokines and growth factors into the feedback network [318–321]. For example, it is possible to envisage that PAF primes the release of IL-1 and TNF from activated monocytes and leukotriene and free radical production from stimulated polymorphonuclear cells. PAF may also activate platelets to form (i) platelet factor 4 (PF₄), platelet-derived growth factor (PDGF) which may account for eosinophil chemotaxis and (ii) thrombin and ATP which in turn, as IL-1 and TNF, act on the endothelium to produce more PAF resulting in increased PMN chemotaxis. These cells may then be primed by TNF for PAF-induced superoxide generation. In addition, PAF generated by the endothelium may

amplify the TNF- and IL-1-activated production of IL-6 and granulocyte/monocyte colony-stimulating factor (GM-CSF) from endothelial cells. GM-CSF, which is also produced by stimulated monocytes, potently enhances release of superoxide and LTC₄ by eosinophils. Furthermore, in combination with interleukin 3 (IL-3), it elicits monocyte cytotoxicity by inducing TNF secretion from this cell type [322]. Feedback processes between PAF and proteinase activity may also be important for destabilization of the endothelium.

The priming ability of these mediators indicates the extreme sensitivity of the inflammatory process and the rigid controls which must usually operate to stop excessive inflammatory responses. It may be that an equilibrium exists between the mediators involved in the priming and feedback processes and internal mechanisms which down-regulate these loops and confine cytotoxic reactions to a specific site. Indeed, several endogenous inhibitors of PAF, TNF, IL-1 and IL-2 have been reported [311, 321]. Under normal physiological conditions, a balance may be maintained between cytotoxic and inhibitory mechanisms, which would strictly control the inflammatory process and prevent endothelial injury. In contrast, in pathologies where there may be an overloading of the system by excessive mediator production or a critical reduction in inhibitory factors, it is possible that the feedback cycles may become unregulated and the toxicity converted into a systemic process, resulting in free-radical production, endothelial damage, cell infiltration, vascular leakage and microcirculatory collapse.

This fine balance between the protection and destruction of the processes maintaining life is a reminiscent of the catastrophe theory proposed by Rene Thom in the early 1970's [323]. We are currently applying mathematical modelling to this biological feedback system in order to establish its relationship with the catastrophe hypothesis.

Support for the PAF-cytokine feedback system is not only provided by our *in vitro* data demonstrating that PAF antagonists drastically reduce TNF-stimulated PMN superoxide generation, but also by the *in vivo* observations of Sun and Hsueh [324] who have shown that the PAF antagonist SRI 63-119 prevents TNF-induced bowel necrosis in the rat.

We propose that the effectiveness of PAF antagonists in protecting against shock, sepsis, graft rejection, ischaemia and bronchial anaphylaxis is due to the interdependence of the various components of the inflammatory response [311, 321]. Because PAF is an integral part of this system, the ability of PAF antagonists to inhibit PAF priming and PAF-dependent feedback processes may be sufficient in certain pathologies to prevent escalation of auto-generated inflammatory damage.

Thus, PAF antagonists may constitute valuable drugs in pathologies involving microvascular damage such as acute ischaemia, graft rejection, shock, organ preservation, and pulmonary hyperreactivity where control of the inflammatory response has to be reinstated therapeutically. However, it should be emphasized that PAF antagonists alone are capable of blocking only those pathological processes directly or indirectly dependent on PAF, no matter how diverse they may be. It seems likely that more successful therapy of the above conditions will involve treatment with a combination of drugs, possibly including Ca^{2+} and prostaglandin I_2 (PGI_2) antagonists, interleukin and growth factor inhibitors, anti-TNF antibodies, proteinase inhibitors and PAF antagonists. Only the results of further experimental and clinical investigations will reveal whether the mechanism of action of PAF antagonists proposed above is correct and whether these drugs offer extensive therapeutic potential in man.

APPENDIX

RECENTLY REPORTED PAF ANTAGONISTS

Amongst these are synthetic compounds which are heterocyclic analogues of 1,4-benzodiazepines: WEB 2347 (47) [325], Ro 24-4736 (48) [326] and Y 24 180 (49) [327]. In addition, a pyrrolo[1,2-*c*]thiazole-7-carboxamide

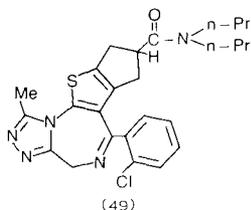
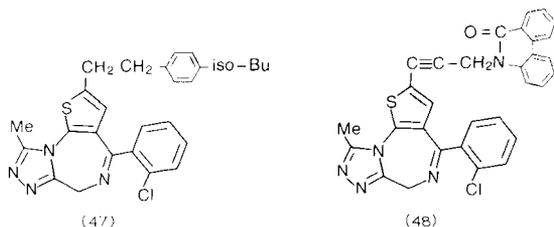

derivative, RP 59227 (50) inhibits PAF-induced human platelet aggregation and has an IC_{50} value of $0.05 \mu M$ [328]. Another synthetic compound, SCH 37370 (51), antagonizes both PAF and histamine; its inhibits PAF-induced human platelet aggregation (IC_{50} value = $0.6 \mu M$) [329].

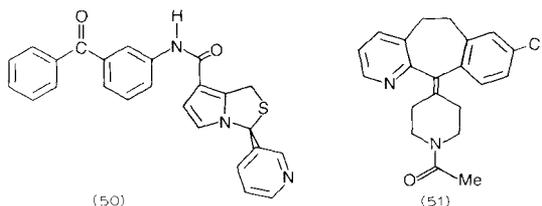

Work on naturally occurring compounds has uncovered several which are of potential interest as PAF antagonists. Analogues (52) of khellactone show activity as inhibitors of PAF-induced rabbit platelet aggregation in platelet-rich plasma and are more selective in inhibiting this aggregation than that induced by ADP, AA or collagen [350]. A compound code-named L-652469 (53),

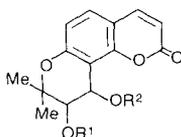

Compound	R ¹	R ²	IC ₅₀ (μM)*
Khellactone	H	H	Inactive
1.		Ac	90
2.			50
3.			40
4.		Ac	50
5.	-COCHMeEt	Ac	50

*Inhibition of PAF-induced rabbit platelet aggregation in platelet-rich plasma
(52)

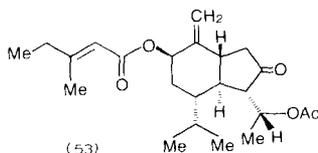

isolated from *Tussilago farfara* and which is a traditional Chinese treatment for asthma, inhibits binding of [³H]PAF to rabbit platelet membranes (IC₅₀ value = 4 μM) [331]. Irreversible inhibition of binding of [³H]PAF to human platelet membranes is claimed for the diepoxide futoxine (crotepoxide, 54) isolated from haifenteng (*Piper futokadsura*) [332]. Several diphenylcyclopentane sulphones (55) inhibit PAF binding to human platelet membranes [333]. Finally, tetranortriterpenoids (56) and (57) from *Swietenia mahogani*, a traditional Indonesian medicinal plant, inhibit PAF-induced rabbit platelet aggregation in platelet-rich plasma [334].

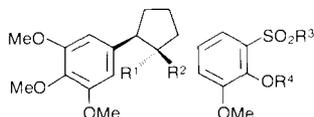
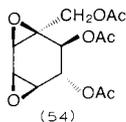

R ¹	R ²	aryl stereo	R ³	R ⁴	30 nM*	3 nM*
H	OMe	<i>β</i>	Me	n-Pr	33 [▲]	
OMe	H	<i>α</i>	Me	n-Pr	88 [▲]	43 [▲]
H	OMe	<i>α</i>	Me	n-Pr	77 [▲]	24 [▲]
OCH ₂ C≡CH	H	<i>α</i>	Me	n-Pr	43	20
H	OCH ₂ C≡CH	<i>α</i>	Me	n-Pr	85	60
H	OCH ₂ C≡CH	<i>α</i>	n-Pr	Et	92	56

* % inhibition of PAF binding to human or [▲]rabbit platelet membranes

(55)

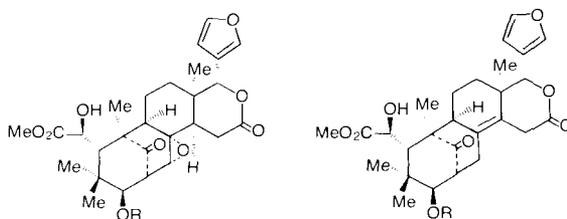

Compound	R	% inhibition 100 μM*	Compound	R	% inhibition 100 μM*
Swietemahonin A	-COEt	97.4 %	Swietenolide	H	35 %
Swietemahonin E		91.0 %	3-acetylswietenolide	-Ac	91.6 %

* Inhibition of PAF-induced rabbit platelet aggregation in platelet-rich plasma

(56)

(57)

REFERENCES

1. J.F. Barbaro and N.J. Zvaifler, *Proc. Soc. Exp. Biol. Med.*, 122 (1966) 1245.
2. R.P. Siraganian and B. Oliveira, *Fed. Proc.*, 27 (1968) 315.
3. R.P. Siraganian and A.G. Osler, *J. Allergy*, 43 (1969) 167.
4. P.M. Henson, *Fed. Proc.*, 28 (1969) 1721.
5. P.M. Henson, *J. Exp. Med.*, 131 (1970) 287.
6. R.P. Siraganian and A.G. Osler, *J. Immunol.*, 106 (1971) 1244.
7. J. Benveniste, P.M. Henson and C.G. Cochrane, *J. Exp. Med.*, 136 (1972) 1356-1377.
8. J. Benveniste, J.P. Le Couedic, J. Polonsky and M. Tencé, *Nature (London)*, 269 (1977) 170.
9. J. Benveniste, M. Tencé, P. Varenne, J. Bidault, C. Boulet and J. Polonsky, *C.R. Hebd. Seances Acad. Sci., Series D*, 289 (1979) 1037.
10. C.A. Demopoulos, R.N. Pinckard and D.J. Hanahan, *J. Biol. Chem.*, 254 (1979) 9355.
11. M.L. Blank, F. Snyder, L.W. Byers, B. Brooks and E.E. Muirhead, *Biochem. Biophys. Res. Commun.*, 90 (1979) 1194.
12. D.J. Hanahan, C.A. Demopoulos, J. Liehr and R.N. Pinckard, *J. Biol. Chem.*, 255 (1980) 5514.
13. C.L. Keith, R.C. Murphy, J.L. Andres, J. Lynch and P.M. Henson, *Biochem. Biophys. Res. Commun.*, 121 (1984) 815.
14. M. Oda, K. Satouchi, K. Yasunage and J. Saito, *J. Immunol.*, 135 (1985) 1090.
15. H.W. Mueller, J.T. O'Flaherty and R.L. Wykle, *J. Biol. Chem.*, 259 (1984) 14554.
16. C.S. Ramesha and W.C. Pickett, *J. Immunol.*, 138 (1987) 1559.
17. K. Satouchi, R.N. Pinckard and D.J. Hanahan, *Arch. Biochem. Biophys.*, 211 (1981) 683.
18. M. Tencé, E. Coeffier, F. Heymans, J. Polonsky, J.J. Godfroid and J. Benveniste, *Biochimie*, 63 (1981) 723.
19. M.L. Blank, E.A. Cress, T.C. Lee, B. Malone, J.R. Surles, C. Piantadosi, J. Hajou and F. Snyder, *Res. Commun. Chem. Pathol. Pharmacol.*, 38 (1982) 3.
20. J.T. O'Flaherty, W.L. Salzer, S. Cousart, C.E. McCall, C. Piantadosi, J.R. Surles, M.J. Hammett and R.L. Wykle, *Res. Commun. Chem. Pathol. Pharmacol.*, 39 (1983) 291.
21. J.C. Ludwig and R.N. Pinckard, in *New Horizons in Platelet-Activating Factor Research*, eds. C.M. Winslow and M.L. Lee (John Wiley, New York, 1987) pp. 59-65.
22. J.M. Mencia-Huerta and J. Benveniste, *Eur. J. Immunol.*, 9 (1979) 409.
23. J.M. Mencia-Huerta, R.A. Lewis, E. Razin and K.F. Austen, *Immunology*, 131 (1983) 2958.
24. M. Benhamou, E. Ninio, P. Salem, C. Hieblot, G. Bessou, C. Pitton, F.T. Li and J.M. Mencia-Huerta, *J. Immunol.*, 136 (1986) 1385.
25. E. Pirotzky, E. Ninio, J. Bidault, P. Pfister and J. Benveniste, *Lab. Invest.*, 51 (1984) 567.
26. F. Bussolino, R. Foa, F. Malavasi, M.L. Ferrando and G. Camussi, *Exp. Haematol.*, 12 (1984) 688.
27. G. Camussi, M. Aglietta, F. Malavasi, C. Tetta, W. Piacibello, F. Sanavio and F. Bussolino, *J. Immunol.*, 131 (1983) 2397.
28. S.M. Prescott, G.A. Zimmerman and T.M. McIntyre, *Med. Sci.* 81 (1984) 3534.
29. F. Bussolino, F. Brevario, C. Tetta, M. Aglietta, A. Mantovani and E. Dejana, *J. Clin. Invest.*, 77 (1986) 2027.
30. J.M. Lynch, G.Z. Lotner, S.J. Betz and P.M. Henson, *J. Immunol.*, 123 (1979) 1219.
31. G.Z. Lotner, J.M. Lynch, J.S. Betz and P.M. Henson, *J. Immunol.*, 124 (1980) 676.

32. T.C. Lee, D.J. Lenihan, B. Malone, L.L. Roddy and S.I. Wasserman, *J. Biol. Chem.*, 259 (1984) 5530.
33. G. Camussi, M. Aglietta, R. Coda, F. Bussolino, W. Piacibello and C. Tetta, *Immunology*, 42 (1981) 191.
34. F. Malavasi, C. Tetta, A. Funaro, G. Bellone, E. Ferrero, A.C. Franzone, P. Dellabona, R. Rusci, L. Matera, G. Camussi and F. Caligaris-Cappio, *Proc. Natl. Acad. Sci. USA*, 83 (1986) 2443.
35. M. Chignard, J.P. Le Couedic, M. Tencé, B.B. Vargaftig and J. Benveniste, *Nature (London)*, 275 (1979) 799.
36. F. Snyder, *Med. Res. Rev.*, 5 (1985) 107.
37. M. Di Rosa, R.J. Flower, F. Hirata, L. Parente and F. Russo-Marie, *Prostaglandins*, 28 (1984) 441.
38. L. Touqui, B. Rothhut, A.M. Shaw, A. Fradin, B.B. Vargaftig and F. Russo-Marie, *Nature (London)*, 321 (1986) 177.
39. F. Hirata, *J. Biol. Chem.*, 258 (1981) 7730.
40. D.J. Lenihan and T.C. Lee, *Biochem. Biophys. Res. Commun.* 120 (1984) 834.
41. J. Gomez-Cambrenero, M.L. Neito, J.M. Mato and M. Sanchez-Crespo, *Biochim. Biophys. Acta*, 845 (1987) 511.
42. E. Ninio, F. Joly, C. Hieblot, G. Bessous, J.M. Mencia-Huerta and J. Benveniste, *J. Immunol.*, 139 (1987) 154.
43. L.R. Ballou and W.Y. Cheung, *Proc. Natl. Acad. Sci. USA*, 82 (1985) 371.
44. P. Braquet, L. Touqui, T.S. Shen and B.B. Vargaftig, *Pharmacol. Rev.* 39 (1987) 97.
45. P. Braquet and M. Rola-Pleszczynski, *Immunol. Today*, 8 (1987) 345.
46. D. Hosford, J.M. Mencia-Huerta and P. Braquet, in *Eicosanoids, Lipid Peroxidation and Cancer*, eds. S. Nigam and T.S. Slater (Springer Verlag, Berlin, 1989) pp. 53-65.
47. D. Hosford, J.M. Mencia-Huerta, C. Page and P. Braquet, *Phytotherapy Res.* 2 (1988) 1.
48. P. Braquet, *Drugs Future*, 12 (1987) 643.
49. P. Braquet and J.J. Godfroid, *Trends Pharmacol. Sci.*, (1986) 397.
50. P. Braquet, P.E. Chabrier and J.M. Mencia-Huerta, *Adv. Inflammation Res.* 12 (1987) 135.
51. H.K. Mangold and F. Paltauf, *Ether Lipids* (Academic Press, New York, 1983).
52. F. Snyder, *PAF and Related Lipid Mediators* (Plenum Press, New York, 1987).
53. D.J. Hanahan, *Annu. Rev. Biochem.*, 55 (1986) 483.
54. P. Braquet, M. Paubert-Braquet and B.B. Vargaftig, in *Advances in Prostaglandin, Thromboxane and Leukotriene Research*, ed. B. Samuelsson (Raven Press, New York) Vol. 17 (1987) p. 818.
55. B.B. Vargaftig and P. Braquet, *Br. Med. Bull.*, 43 (1987) 312.
56. A. Sturk, J.W. ten Cate, D. Hosford, J.M. Mencia-Huerta and P. Braquet, in *Advances in Lipid Research*, eds. R. Paoletti and D. Kritchevsky (Academic Press, London) Vol. 23 (1989) 219.
57. F. Heymans, E. Michel, M.C. Borrel, B. Wichrowski and J.J. Godfroid, *C.R. Hebd. Seances Acad. Sci., Ser. A*, 293 (1981) 49.
58. F. Heymans, E. Michel, M. Borrel, B. Wichrowski, J. Godfroid, O. Convert, E. Coefficient, M. Tencé and J. Benveniste, *Biochim. Biophys. Acta*, 666 (1981) 230.
59. R.L. Wykle, C.H. Miller, J.C. Lewis, J.D. Schmitt, J.A. Smith, J.R. Surles, C. Piantadosi and J.T. O'Flaherty, *Biochem. Biophys. Res. Commun.*, 100 (1981) 1651.
60. T.C. Lee, B. Malone, S.I. Wasserman, V. Fitzgerald and F. Snyder, *Biochem. Biophys. Res. Commun.*, 105 (1982) 1303.

61. B.B. Vargaftig and J. Benveniste, *Trends Pharmacol. Sci.*, 4 (1983) 341.
62. F.H. Valone, E. Coles, V.R. Reinhold and E.J. Goetzl, *J. Immunol.*, 129 (1982) 1637.
63. P. Inarrea, J. Gomez-Cambronero, M. Nieto and M. Sanchez-Crespo, *Eur. J. Pharmacol.*, 105 (1984) 309.
64. E. Klopogge and J.W.N. Akkerman, *Biochem. J.*, 223 (1984) 901.
65. P.J. Wade, D.O. Lunt, N. Lad, D.P. Tuffin and K.G. McCullagh, *Thromb. Res.*, 41 (1986) 251.
66. S.B. Hwang, C.S.C. Lee, M.J. Cheah and T.Y. Shen, *Biochemistry*, 22 (1983) 4756.
67. F.H. Valone and E.J. Goetzl, *Immunology*, 48 (1983) 141.
68. S.B. Hwang, M.H. Lam and T.Y. Shen, *Biochem. Biophys. Res. Commun.*, 128 (1985) 972.
69. M.T. Domingo, B. Spinnewyn, P.E. Chabrier and P. Braquet, *Biochem. Biophys. Res. Commun.*, 151 (1988) 730.
70. M. Doly, P. Braquet, G. Bonhomme and P. Meyniel, *Int. J. Tiss. React.*, 9 (1987) 33.
71. M.T. Domingo, G.L. Van Delst, M.L.G. Nerbey, N.G. van Haerijnen, P.E. Chabrier and P. Braquet, *Proc. Br. Pharmacol. Soc.* 6-8th Jan. (1988) C106.
72. G. Lambrecht and M.J. Parnham, *Br. J. Pharmacol.*, 87 (1986) 287.
73. A.G. Stewart and G.J. Dustin, *Br. J. Pharmacol.*, 94 (1988) 1225.
74. N.F. Voelkel, S. Worthen, J.T. Reeves, P.M. Henson and R.C. Murphy, *Science* (Washington, DC), 218 (1982) 286.
75. D.A. Handley, R.G. Van Valen, M.K. Melden and R.N. Saunders, *Thromb. Haemost.*, 52 (1984) 34.
76. M. Sanchez-Crespo, F. Alonso, P. Inarrea and J. Egido, *Agents Actions*, 11 (1981) 565.
77. F.H. Valone, *Immunology*, 52 (1984) 169.
78. C. Lalau Keraly and J. Benveniste, *Br. J. Haematol.*, 51 (1982) 313.
79. C.M. Chesney, D.D. Pifer and K.M. Huch, *Biochem. Biophys. Res. Commun.*, 127 (1985) 24.
80. J. Nishihira, T. Ishibashi, Y. Imai and T. Muramatsu, *Tohoku J. Exp. Med.*, 147 (1985) 145.
81. J. Nishihira, T. Ishibashi, Y. Imai and T. Muramatsu, *Lipids*, 19 (1984) 907.
82. P.B. Avdonin, I.V. Svitina-Ulitina and V.I. Kulikov, *Biochem. Biophys. Res. Commun.*, 131 (1985) 307.
83. E.G. Lapetina, *J. Biol. Chem.* 257 (1982) 7314.
84. R. Garay and P. Braquet, *Biochem. Pharmacol.*, 35 (1986) 2811.
85. M. Chignard, F. Wal, J. Lefort and B.B. Vargaftig, *Eur. J. Pharmacol.*, 78 (1982) 71.
86. B.B. Vargaftig, J. Lefort, F. Wal, M. Chignard and M.C. Medeiros, *Eur. J. Pharmacol.*, 82 (1982) 121.
87. M.C. Medeiros, J. Lefort, D. Joseph and B.B. Vargaftig, *J. Pharmacol. (Paris)*, 14 (suppl.) (1983) 98.
88. J.O. Shaw and R.M. Lyons, *Biochim. Biophys. Acta*, 714 (1982) 492.
89. E. Couffier, J. Cerrina, E. Jouvin-Marche and J. Benveniste, *Thromb. Res.*, 31 (1983) 565.
90. E. Jouvin-Marche, J. Cerrina, E. Coeffier, P. Duroux and J. Benveniste, *Eur. J. Pharmacol.*, 89 (1983) 19.
91. D.E. McIntyre, A.M. Shaw, *Thromb. Res.* 31 (1983) 833.
92. S. Nawaz-Khan, P.A. Lane and A.D. Smith, *Eur. J. Pharmacol.*, 107 (1985) 189.
93. Hantung, H.P., *FEBS Lett.*, 160 (1983) 209.
94. Levy, J.V., *FEBS Lett.*, 154 (1983) 262.
95. M.M. Billah and M.I. Siegel, *Biochem. Biophys. Res. Commun.*, 117 (1984) 629.
96. J.P. Cazenave, J. Benveniste and J.F. Mustard, *Lab. Invest.*, 41 (1979) 275.

97. M. Criscuoli and A. Subirissi, *Br. J. Pharmacol.*, 90 (1987) 203.
98. G.S. Basran, C.P. Page, W. Paul and J. Morley, *Eur. J. Pharmacol.*, 86 (1983) 143.
99. G. Feuerstein, W.E. Lux, D. Ezra, E.C. Hayes, F. Snyder and A.I. Faden, *J. Cardiovasc. Pharmacol.*, 7 (1985) 335.
100. C. Lecrubier, J. Conard, M.H. Horellou and M. Samama, *Agents Actions*, 13 (1983) 77.
101. S. Sipka, S. Sigam, D. Balazs, E. Kiss, J. Fachel and G. Szegedi, 6th Int. Conference on Prostaglandins and Related Compounds, Florence (Italy) June 3-6, (1986) Abstr. p. 291.
102. K.E. Grandel, R.S. Farr, A.A. Wanderer, T.C. Eisenstadt and S.I.N. Hasserman, *N. Engl. J. Med.*, 313 (1985) 405.
103. M. Criscuoli, A. Subissi, L. Daffonchio and C. Omini, *Agents Actions*, 19 (1986) 246.
104. C. Vigo, *J. Biol. Chem.*, 260 (1985) 3418.
105. R.H. Bourgain, L. Maes, P. Braquet, R. Andries, L. Touqui and M. Braquet, *Prostaglandins*, 30 (1985) 185.
106. F.H. Chilton, J.T. O'Flaherty, C.E. Walsh, M.J. Thomas, R.L. Wykle, L.R. DeChatelet and B.M. Waite, *J. Biol. Chem.*, 257 (1982) 5402.
107. O.V. Miller, D.E. Ayer and R.R. Gorman, *Biochem. Biophys. Acta*, 711 (1982) 445.
108. R.J. Smith and B.J. Bowman, *Biochem. Biophys. Res. Commun.*, 104 (1982) 1495.
109. Z. Terashita, S. Tsushima, Y. Yhoshioka, H. Nomura, Y. Inada and K. Nishikawa, *Life Sci.*, 32 (1983) 1975.
110. R. Barner, P. Hadvary, K. Burri, G. Hirth, J.M. Cassal and K. Muller, *Eur. Patent* 147, 768; *Chem. Abstr.*, 104 (1985) 88939n.
111. K. Burri, R. Barner, J.M. Cassal, P. Hadvary, G. Hirth and K. Muller, *Prostaglandins*, 30 (1985) 691.
112. C.M. Winslow, S.R. Vallespir, G.E. Frisch, F.J. D'Aries, A.K. DeLillo, W.J. Houlihan, V. Parrino, G. Schmitt and R.N. Saunders, *Prostaglandins*, 30 (1985) 697.
113. B. Wichrowski, S. Jouquey, F. Heymans, C. Broquet, J.J. Godfroid, J. Fichelle and M. Worcel, in Ref. 101, Abstr. p. 309.
114. R. Saunders, R. Anderson, D. Handley, W. Houlihan, M. Lee, J. Tomesch and C. Winslow, Second International Conference on Platelet-Activating Factor and Structurally Related Alkyl Ether Lipids, Gatlinburg, TN, October 26-29 (1986) Abstr. p. 33.
115. D.A. Handley, R.G. Van Valen, C.M. Winslow, J.C. Tomesch and R.N. Saunders, *Thromb. Haemost.*, 57 (1987) 187.
116. P. Sedivy, C.G. Caillard, A. Floch, F. Folliard, S. Mondot, C. Robaut and B. Terlain, *Prostaglandins*, 30 (1985) 688.
117. E. Kornecki, Y.H. Ehrlich and R.H. Lenox, *Science (Washington, DC)*, 226 (1985) 1454.
118. J. Casals-Stenzel, G. Muacevic and K.H. Weber, *Arch. Pharmacol.*, 334 (suppl.) (1986) R44.
119. J. Casals-Stenzel, K.H. Weber, G. Walther and A. Harreus, *Ger. Offen. DE 3435, 974*; *Chem. Abstr.*, 105 (1986) 146245s.
120. D. Nunez, M. Chignard, R. Korth, J.P. Le Couedic, X. Norel, B. Spinnewyn, P. Braquet and J. Benveniste, *Eur. J. Pharmacol.*, 123 (1986) 197.
121. Z. Terashita, Y. Imura, K. Nishikawa and S. Sumida, *Eur. J. Pharmacol.*, 109 (1985) 257.
122. J.L. Wallace and B.J.R. Whittle, *Eur. J. Pharmacol.*, 124 (1986) 209.
123. Y. Imura, Z. Terashita and K. Nishikawa, *Life Sci.*, 39 (1986) 111.
124. F. Masugi, T. Ogihara, A. Otsuka, S. Saeki and Y. Kumajara, *Life Sci.* 34 (1984) 197.
125. J.L. Wallace, G. Steel and B.J. Whittle, *Can. J. Physiol. Pharmacol.*, 65 (1987) 1428.
126. M. Lang, D. Hansen and H.L. Hahn, *Agents Actions*, 21 (suppl.) (1987) 245.

127. H. Satoh, T. Adachi, T. Imai, A. Okazawa, T. Kamiya, N. Nishikata, H. Kobayashi, T. Takahashi and H. Yamagushi, *Atherosclerosis*, 36 (1987) 306–312.
128. J. Arnout, A. van Hecken, I. Delepeleire, Y. Miyamoto, I. Holmes, P. Deschepper and J. Vermynen, *Thromb. Haemostasis*, 58 (1987) 20.
129. Z. Terashita, Y. Imura, M. Takatani, S. Tsushima and K. Nishikawa, *J. Pharmacol. Exp. Ther.*, 242 (1987) 263.
130. M.L. Lee, C.M. Winslow, G.E. Frisch, Ch. Jaeggi, F.J. D'Aries, A.K. DeLillo and R.C. Anderson, in Ref. 21, pp. 145–152.
131. M.K. Melden, S. Flury, R.N. Saunders and D.A. Handley, *Fed. Proc.*, 45 (1986) 856.
132. C. Farley, M.K. Melden, R.G. Van Valen, R.W. Deacon, R.C. Anderson, M.L. Lee, R.N. Saunders and D.A. Handley, *Fed. Proc.* 45 (1986) 855.
133. S.R. O'Donnell and C.J.L. Barnett, *Eur. J. Pharmacol.*, 138 (1987) 385.
134. D.A. Handley, R.G. Van Valen and R.N. Saunders, *Immunopharmacology*, 11 (1986) 175.
135. W. Hseuh, F. Gonzalez-Crussi, J.L. Arroyana, R.C. Anderson, M.L. Lee, R.N. Saunders and D.A. Handley, in Ref. 21, p. 347.
136. D.A. Handley, R.C. Anderson and R.N. Saunders, *Eur. J. Pharmacol.*, 141 (1987) 409.
137. D.A. Handley, R.W. Deacon, M.L. Lee and R.N. Saunders, in *New Horizons in Platelet-Activating Factor Research* (Oct. 15–18, 1985) Hilton Head Island, (1987) Abstr. p. 82.
138. T. Miyamoto, H. Ohno, T. Yano, T. Okada, N. Hamanaka and A. Kawasaki, *Adv. Prostaglandins, Thromboxane Leukotriene Res.*, 15 (1985) 719–720.
139. T. Toyofuku, K. Keishi, T. Kobayashi and S. Kusama, *Prostaglandins*, 31 (1986) 271.
140. M. Cirino, V. Lagente, J. Lefort and B.B. Vargaftig, *Prostaglandins*, 32 (1986) 121.
141. P. Hadvary and H.R. Baumgartner, *Prostaglandins*, 30 (1985) 694.
142. N. Nakamura, N. Ookawa, H. Koke, T. Sada, T. Oshima and Y. Iizuka, *Eur. Pat.* 238, 202; *Chem. Abstr.*, 109 (1988) 73852.
143. G. Grue-Sorensen, I.M. Nielsen and C.K. Nielsen, *J. Med. Chem.*, 31 (1988) 1174.
144. C.M. Winslow, R.C. Anderson, F.J. D'Aries, G.E. Frisch, A.K. DeLillo, M.L. Lee and R.N. Saunders, in Ref. 21, p. 153.
145. W. Hseuh, F. Gonzalez-Crussi, J.L. Arroyave, R.C. Anderson, M.L. Lee and W.J. Houlihan, *Eur. J. Pharmacol.*, 123 (1986) 79.
146. D.A. Handley, R.G. Van Valen, M.K. Melden, S. Flury, M.L. Lee and R.N. Saunders, *Immunopharmacology*, 12 (1986) 11.
147. R. Patterson, K.E. Harris, M.L. Lee and W.J. Houlihan, *Int. Arch. Allergy Appl. Immunol.*, 81 (1986) 168.
148. R.W. Deacon, M.K. Melden, R.N. Saunders and D.A. Handley, *Fed. Proc.*, 45 (1986) Abstr. 995.
149. G. Camussi, I. Pawlowski, R. Saunders, J. Brentjeans and G. Andres, *J. Lab. Clin. Med.*, 110 (1987) 196.
150. C.M. Winslow, H.U. Gubler, A.K. DeLillo, F.J. D'Aries, J.C. Tomesch and R.N. Saunders, in Ref. 114, p. 33 (Abstr.).
151. D.A. Handley, *Drugs Future*, 13 (1988) 137.
152. R. Patterson, K.E. Harris, D.A. Handley and R.N. Saunders, *J. Lab. Clin. Med.*, 110 (1987) 606.
153. H. Stenzel, B. Hummer and H.L. Han, *Agents Actions*, 21 (suppl.) (1987) 253.
154. L. Makowka, C. Miller, P. Chapchap, L. Podesta, C. Pan, D. Pressley, V. Mazzaferro, C.O. Esquivel, S. Todo and B. Banner, *Ann. Surg.* 206 (1987) 482.
155. S.L. Jones, S.R. O'Donnell and C.J.K. Barnette, *Recent Advances in Platelet Activating Factor*, Brisbane, Australia, September 3–5 (1987) Abstr. 13.

156. C. Broquet and P. Braquet, *Drugs Future*, (1989) In press.
157. N. Nakamura, N. Ookawa, H. Koke, T. Sada, T. Oshima and Y. Iizuka, *Eur. Pat.* 210, 804; *Chem Abstr.*, 106 (1987) 169044k.
158. M.L. Lee, C.M. Winslow, Ch. Jaeggi, F. D'Aries, G. Frisch and C. Farley, *Prostaglandins*, 30 (1985) 690.
159. P. Hadvary and T. Weller, *Helv. Chim. Acta*, 69 (1986) 1862.
- 159a. H.E. Kendall and D.K. Luscombe, *Prog. Med. Chem.*, 24 (1987) 249.
160. A. Floch, P. Sedivy and C.G. Caillard, *J. Pharmacol. (Paris)*, 17 (1986) 177.
161. B. Dewald and M. Baggiolini, *Biochem. Pharmacol.*, 36 (1987) 2505.
162. I. Cavero, D. Lave, O. Marquis and C. Robaut, *Br. J. Pharmacol.*, 90 (1987) 116.
163. O. Marquis, C. Robaut and M. Icilio, in Ref. 155, Abstr. 3.
164. C. Robaut G. Durand, C. James, D. Lave, P. Sedivy, A. Floch, S. Mondot, D. Pacot, I. Cavero and G. Le Fur, *Biochem. Pharmacol.*, 36 (1987) 3221.
165. F.H. Valone, *Thromb. Res.*, 45 (1987) 427.
166. C.P. Cox and K.L. Wood, *Thromb. Res.*, 47 (1987) 249-257.
167. J. Casals-Stenzel and K.H. Weber, *Br. J. Pharmacol.*, 90 (1987) 139.
168. J. Casals-Stenzel, *Arch. Pharmacol.*, 335 (1987) 351.
169. J. Casals-Stenzel, *Immunopharmacology*, 13 (1987) 117.
170. T. Tahara, H. Mikashima, M. Terasawa and Y. Maruyama, *Chem. Pharm. Bull.*, 35 (1987) 2119.
171. F.W. Birke and K.H. Weber, in Ref. 155, Abstr. 48.
172. J. Casals-Stenzel, *Eur. J. Pharmacol.*, 135 (1987) 117.
173. H. Heuer, J. Casals-Stenzel, G. Muacevic, W. Stransky and K.H. Weber, in Ref. 155, Abstr. 4.
174. J.W. Tilley, B. Burghardt, C. Burghardt, T.F. Mowles, F.J. Leinweber, L. Klevans, R. Young, G. Hirkaler, K. Fahrenholtz, S. Zawoiski, and L.J. Todaro. *J. Med. Chem.*, 31 (1988) 466.
175. W.J. Houlihan, S.H. Cheon, D.A. Handley, D. Larson, V.A. Parrino, B. Reitter, G. Schmitt and C.M. Winslow, *Prostaglandins*, 35 (1988) 848.
176. S. Furukawa, *Sci. Papers Inst. Phys. Chem. Res. Tokyo*, 19 (1932) 27.
177. M. Maruyama, A. Terahara, Y. Itagaki and K. Nakanishi, *Tetrahedron Lett.*, 4 (1967) 299.
178. M. Maruyama, A. Terahara, Y. Itagaki, and K. Nakanishi, *Tetrahedron Lett.*, 4 (1967) 303.
179. M. Maruyama, A. Terahara, Y. Nakadaira, M.C. Woods, K. Nakanishi, *Tetrahedron Lett.*, 4 (1967) 309.
180. M. Maruyama, A. Terahara, Y. Nakadaira, M.C. Woods, Y. Takagi and K. Nakanishi, *Tetrahedron*, 4 (1967) 314.
181. K. Nakanishi, *Pure Appl. Chem.*, 14 (1967) 89.
182. K. Weinges, M. Hepp and H. Jaggy, *Liebigs Ann. Chem.*, 6 (1987) 521.
183. L. Dupont, G. Germain and O. Dideberg, *Pharmacol. Res. Commun.*, 18 (1986) 25.
184. C. Roumestand, B. Perly, D. Hosford and P. Braquet, *Tetrahedron Lett.* 45 (1988) 1975.
185. K. Weinges, M. Hepp, Huber-Patz, H. Rodewald and H. Irngartinger, *Liebigs Ann. Chem.*, 105 (1986) 1057.
186. E.J. Corey, M.C. Kang, M.C. Desai, A.K. Ghosh and I.N. Houppis, *J. Am. Chem. Soc.*, 110 (1988) 649.
187. P. Braquet, B. Spinnewyn, M. Braquet, R.H. Bourgain, J.E. Taylor, A. Etienne and K. Drieu, *Blood Vessel*, 16 (1985) 559.
188. P. Braquet, in *Adv. Prostaglandin, Thromboxane Leukotriene Res.*, 16 (1986) 179.

189. K. Nakanishi, K. Habaguchi, Y. Nakadaira, M.C. Woods, M. Maruyama, R.T. Major, M. Alauddin, A.R. Patel, K. Weinges, W. Bähr, *J. Am. Chem. Soc.*, 93 (1971) 3544.
190. D. Nunez, D. Delautier, P. Braquet and J. Benveniste, in Ref. 101, Abstr. p. 319.
191. P. Braquet, *Ginkgolides: Chemistry, Biology, Pharmacology and Clinical Perspectives*, ed. P. Braquet (J.R. Prous Science Publishers, Barcelona, 1988).
192. P. Braquet, Ph. Guinot and C. Touvay, *Agents Actions*, 21 (1987) 97.
193. C. Touvay, B. Vilain, J.E. Taylor, A. Etienne and P. Braquet, *Prog., Lipid. Res.*, 25 (1985) 277.
194. P.J. Barnes, K.S. Chung, T.W. Evans and D.S. Rogers, *Br. J. Pharmacol.*, 89 (1986) 764P.
195. T.W. Evans, K.F. Chung, D.F. Rogers and P.J. Barnes, *J. Appl. Physiol.*, 63 (1987) 47.
196. F. Berti and G. Rossoni, in Ref. 191, p. 399.
197. P. Braquet and J.J. Godfroid, in *Platelet Activating Factor*, ed. F. Snyder (Plenum Press, New York, 1987) p. 191.
198. S. Desquand, C. Touvay, J. Randon, V. Lagente, I. Maridonneau-Parini, J. Lefort, A. Etienne, P. Braquet and B.B. Vargaftig, *Eur. J. Pharmacol.*, 127 (1986) 83.
199. S. Desquand, B. Vilain, V. Lagente, J. Randon, C. Touvay, J. Lefort, P. Braquet and B.B. Vargaftig, *Adv. Prostaglandin, Thromboxane Leukotriene Res.* 17 (1987) 814.
200. Y. Hamasaki, M. Mojarad, T. Saga H-H Tai and S.I. Said, *AM. Rev. Resp. Dis.*, 129 (1984) 742.
201. J. Berti, C. Omini, G. Rossoni and P. Braquet, *Pharm. Res. Commun.*, 18 (1986) 775.
202. S. Desquand and B.B. Vargaftig, in Ref. 191, pp. 271–281.
203. J.G. De Monchy, H.F. Kauffman, P. Vense, G.H. Koster, H.M. Jansan, H.J. Sluiter and K. De Vries, *Am. Rev. Respir. Dis.*, 135 (1985) 373.
204. W.V. Filley, G.M. Kephart, K.E. Holley and G.J. Gleich, *Lancet*, ii (1982) 11.
205. A.J. Wardlaw and A.B. Kay, *Br. Med. Bull.*, 43 (1986) 312.
206. B. Vilain, V. Lagente, C. Touvay, S. Desquand, J. Randon, P. Lefort, P. Braquet and B.B. Vargaftig, *Pharmacol. Res. Commun.*, 18 (1986) 119.
207. V. Lagente, C. Touvay, J. Randon, S. Desquand, M. Cirino, B. Vilain, J. Lefort, P. Braquet and B.B. Vargaftig, *Prostaglandins*, 33 (1987) 264.
208. M. Harczy, J. Maclouf, P. Pradelles, P. Braquet, P. Borgeat and P. Sirois, *Pharmacol. Res. Commun.*, 19 (1986) 111.
209. P. Sirois, M. Harczy, C. Robidoux, P. Borgeat and P. Braquet, in *Lipid Mediators in Immunology of Burn and Sepsis*, eds. M. Paubert-Braquet, P. Braquet, R. Demling, R. Fletcher and M. Foegh (Plenum Press, New York, 1987) pp. 187–196.
210. S. Jancar, P. Sirois and P. Braquet, in Ref. 191, pp. 493–506.
211. D.R. Stanworth, H.R. Griffiths and P. Braquet, in 2nd World Conference on Inflammation, Monte-Carlo, March 19–22, A193. (1986) Abstr.
212. J. Lefort, E. Malenchère, M. Pretolani and B.B. Vargaftig, *Br. J. Pharmacol.*, 89 (1986) 768P.
213. A. Etienne, F. Hecquet, C. Soulard, B. Spinnewyn, F. Clostre and P. Braquet, *Agents Actions*, 17 (1985) 368.
214. A. Etienne, C. Guilnard, C. Soulard, F. Clostre and P. Braquet, *Circ. Shock.*, 21 (1987) 368.
215. A. Adnot, J. Lefort, P. Braquet and B.B. Vargaftig, *Prostaglandins*, 32 (1986) 791.
216. S. Adnot, J. Lefort, V. Lagente, P. Braquet and B.B. Vargaftig, *Pharmacol. Res. Commun.*, 18 (1986) 197.
217. M. Sanchez-Crespo, S. Fernandez-Gallardo, M.L. Nieto, J. Baranès and P. Braquet, *Immunopharmacology*, 10 (1985) 69.

218. L. Beijer, J. Botting, A.O. Oyekan, C. Page and R. Rylander, *Br. J. Pharmacol.*, 90 (1987) 118 Abstr.
219. M. Rola-Pleszczynski, B. Pignol, C. Pouliot and P. Braquet, *Biochem. Biophys. Res. Commun.*, 142 (1987) 754.
220. B. Pignol, S. Henane, J.M. Mencia-Huerta, P. Braquet and M. Rola-Pleszczynski, in 10th International Congress of Pharmacology, Sydney, Australia, 3–5th September (1987).
221. M. Rola-Pleszczynski, C. Pouliot, B. Pignol and P. Braquet, *Fed. Proc.*, 46 (1987) 444. Abstr. 743.
222. B. Pignol, S. Henane, J.M. Mencia-Huerta, M. Rola-Pleszczynski, P. Braquet, *Prostaglandins*, 33 (1987) 931.
223. B. Pignol, S. Henane and B. Sorlin, in *New Trends in Lipid Mediator Research*, Vol 1, ed. P. Braquet (Karger, Basel, 1988) pp. 38–43.
224. M.L. Foegh, B.S. Khrabadi, J.R. Rowles, P. Braquet and P.W. Ramwell, *Transplantation*, 42 (1986) 86–88.
225. E. Pirotzky, Ph. Colliciez, C. Guimard, J. Schaefferbeke and P. Braquet, *Transplant. Proc.*, 20 (1988) 199.
226. B. Pignol, S. Henane, E. Pirotzky, J.M. Mencia-Huerta and P. Braquet, *Transplant. Proc.* 20 (1988) 259.
227. E. Pirotzky, J. Egido, P. Colliciez, D. Hosford, G. Plante and P. Braquet, in Ref. 56, In press.
228. P.B. Gebhardt, H.E.P. Bazan, P. Braquet and N.G. Bazan, in Ref. 223, pp. 99–107.
229. G. Farkas, Y. Mandi, M. Koltai and P. Braquet, in Ref. 191, pp. 737–748.
230. J. Baranes, A. Hellegouarch, M. Le Hegarat, I. Viossat, M. Auguet, P.E. Chabrier, F. Clostre and P. Braquet, *Pharmacol. Res. Commun.*, 18 (1986) 717.
231. P.J. Piper and A.G. Stewart, *Br. J. Pharmacol.*, 88 (1986) 238.
232. P.J. Piper and A.G. Stewart, *Br. J. Pharmacol.*, 90 (1987) 771.
233. M. Koltai, I. Lepran, L. Szekeres, I. Viossat, P.E. Chabrier and P. Braquet, *Eur. J. Pharmacol.*, 130 (1986) 133.
234. F. Berti and G. Rossoni, in Ref. 191, pp. 399–410.
235. E. Pirotzky, J. Bidault, C. Burtin, M.C. Gubler and J. Benveniste, *Kidney Int.*, 25 (1984) 404.
236. D. Schlondorff, J.A. Satriano, J. Hagege, J. Perez and L. Baud, *J. Clin. Invest.*, 73 (1984) 1227.
237. D. Schlondorff, P. Goldwasser, R. Neuwirth, J.A. Satriano and K.L. Clay, *Am. J. Physiol.*, 250 (1986) F1123.
238. R. Neuwirth, P. Singhal, J.A. Satriano, P. Braquet, T.Y. Shen and D. Schlondorff, in Ref. 101, p. 320, Abstr.
239. G. De Arriba, V. Barrio, L. Hernando, J.M. Lopez-Novoa and D. Rodriguez-Puyol, *J. Nephrology, Dialysis Transplant.*, 2 (1987) 224–227.
240. G. Plante, R.L. Hebert, P. Braquet and P. Sirois, *Pharmacol. Res. Commun.* 18 (1986) 173.
241. G.E. Plante and R.L. Hebert, in Ref. 191, (1988) pp. 575–602.
242. O. Ito, G. Camussi, C. Tetta, F. Milgrom and G. Andres, *Lab. Invest.*, 51 (1984) 148.
243. M. Sanchez-Crespo, F. Alonso, A. Barat and J. Egido, *Clin. Exp. Immunol.*, 49 (1982) 631.
244. J. Egido, A. Robles, A. Ortiz, E. Gonzalez, F. Ramirez, F. Mampaso, P. Braquet and L. Hernando, *Eur. J. Pharmacol.*, 138 (1987) 119.
245. E. Pirotzky and P. Braquet, in *Progress in Biochemical Pharmacology*, eds. P. Braquet, H.K. Mangold and B.B. Vargaftig, Vol. 22 (Karger, Basel, 1988) pp. 168–190.

246. F. Clostre, M. Millerin, C. Betin, N. Bazan and P. Braquet in Ref. 191, pp. 649-664.
247. J. Krieglstein, T. Beck and A. Seibert, *Life Sci.*, 39 (1986) 2327.
248. M. Plotkine, L. Massad, M. Alleix, C. Capdeville and R.G. Boulu, in Ref. 101, p. 300 (Abstr.).
249. B. Spinnewyn, N. Blavet and F. Clostre, *Presse Méd.*, 15 (1986) 1511.
250. P. Braquet, B. Spinnewyn, N. Blavet and F. Clostre, in Ref. 70, Abstr.
251. C. Tagesson, M. Lendahl and T. Otamiri, in Ref. 191, pp. 553-562.
252. P. Braquet, F.V. DeFeudis, C. Deby and M. Braquet, in *Excerpta Medica Int. Congress Series 654*, eds. A. Bes., P. Braquet, R. Paoletti and B. Siesjo (Elsevier, Amsterdam, 1984) pp. 265-283.
253. N.W.R. Wickham, G.M. Verceletti, H.Q. Yin, C.F. Moldow and H.S. Jacob, *Clin. Pharmacol.*, 35 (1987) 603.
254. T. Panetta, V.L. Marcheselli, P. Braquet, B. Spinnewyn and N.G. Bazan, *Biochem. Biophys. Res. Commun.*, 149 (1987) 580.
255. C.B.S. Rao, *Chemistry of Lignans* (Andhra University Press, India, 1978).
256. R.D. Haworth, *J. Chem. Soc.*, (1942) 448-456.
257. O.R. Gottlieb, *Phytochemistry*, 11 (1972) 1537.
258. O.R. Gottlieb, *Rev. Latinoamer. Quim.*, 5 (1974) 1.
259. O.R. Gottlieb, *Fortschr. Chem. Org. Natur.*, 35 (1978) 1.
260. R.S. Ward, *Chem. Soc. Rev.*, (1982) 11, 75.
261. C. Keller-Justen, M. Kuhn, A. Von Wartburg and H. Stähelin, *J. Med. Chem.*, 14 (1971) 936.
262. S. Kupchan, R.W. Britton, M.F. Ziegler, J. Gilmore, R.J. Restivo and R.F. Bryan, *J. Am. Chem. Soc.*, 95 (1973) 1325.
263. S.G. Weiss, M. Tin-Wa, R.E. Perdue and N.R. Farnsworth, *J. Pharm. Sci.*, 64 (1975) 95.
264. S.K. Carter and R.B. Livingston, *Cancer Treat. Rep.*, 60 (1976) 1141.
265. L. Hartwell, *Cancer Treat. Rep.*, 60 (1976) 1031.
266. T. Kamikado, C. Chang, S. Murakoshi, A. Sakurai and S. Tamura, *Agric. Biol. Chem.*, 39 (1975) 833.
267. G.B. Russell, P. Singh and P.G. Fenemore, *J. Biol. Sci.*, 29 (1976) 99.
268. T.Y. Shen, S.B. Hwang, M.N. Chang, T.W. Doebber, M.H. Lam, M.S. Wu, X. Wang, G.Q. Han and R.Z. Li, *Proc. Natl. Acad. Sci. USA*, 82 (1985) 672.
269. M.M. Pompipom, R.L. Bugianesi, D.R. Brooker, Y. Bao-Zhen, S.B. Hwang and T.Y. Shen, *J. Med. Chem.*, 30 (1987) 136.
270. J.J. Godfroid, C. Broquet, M. Jouquey-Lebbarn, F. Heymans, E. Steiner, E. Michel, E. Coeffier, J. Fichelle and W. Worcel, *J. Med. Chem.*, 30 (1987) 792.
271. S.B. Hwang, M.H. Lam, T. Biftu, T.R. Beattie and T.Y. Shen, *J. Biol. Chem.*, 260 (1985) 15639.
272. R. Levi, J.A. Burke, Z.G. Guo, Y. Hattori, C.M. Hoppens, L.M. McManus, D.J. Hanahan and R.N. Pinckard, *Circ. Res.*, 54 (1984) 117.
273. S.B. Hwang, C.L. Li, M.H. Lam and T.Y. Shen, *Lab. Invest.*, 52 (1985) 617.
274. T.W. Doebber, M.S. Wu, J.C. Robbins, B.M. Choy, M.N. Chang and T.Y. Shen, *Biochem. Biophys. Res. Commun.*, 29 (1985) 799.
275. O.R. Gottlieb, M. Yoshida and B.B. Vargaftig, in *Franco-Brasilian Symposium on Chemistry and Pharmacology of Natural Products in Inflammation Allergy and Thrombosis*, (Rio de Janeiro, Brazil) November 16-19, (1986) Abstr. 23.
276. S.B. Hwang, M.H. Lam and M.N. Chang, *J. Biol. Chem.*, 261 (1986) 13720.
277. M.M. Pompipom, S.B. Hwang, W. Doebber, J.J. Acton, A.W. Alberts, T. Biftu, D.R.

- Brooker, R.L. Bugianesi, J.C. Chabala, N.L. Gamble, D.W. Graham, M.H. Lam and M.S. Wu, *Biochem. Biophys. Res. Commun.*, 150 (1988) 1213.
278. T. Biftu, N.F. Gamble, T. Doebber, S.B. Hwang, T.Y. Shen, J. Snyder, J.P. Springer and R. Stevenson, *J. Med. Chem.* 29 (1986) 1912.
279. Y.C.P. Chaing, T. Biftu, D.W. Graham, S.S. Yang, M.N. Chang and J.C. Chabala, *Eur. Patent*, 257-921 (1988) A2.
280. K.D. Setchell, A.M. Lawson, F.L. Mitchell, H. Adlercreutz, D.N. Kirk and M. Axelson, *Nature (London)*, 287 (1983) 740.
281. S.R. Stitch, J.K. Toumba, M.B. Groen, C.W. Funke, J. Leemhuis, J. Vink and G.F. Woods, *Nature (London)*, 287 (1980) 738.
282. K.D. Setchell, A.M. Lawson, E. Conway, N.F. Taylor, D.N. Kirk, G. Cooley, R.D. Farrant, S. Wynn and M. Axelson, *Biochem. J.*, 197 (1981) 447.
283. P. Braquet, A. Esanu, A. Etienne and J.P. Robin, in Ref. 21, pp 86-91.
284. H. Adlercreutz, T. Fotsis, R. Heikkinen, J.T. Dwyer, M. Woods, B.R. Goldin and S.L. Gorbach, *Lancet*, ii (1982) 1295.
285. K.D. Setchell, A.M. Lawson, S.P. Borriello, R. Harkness, H. Gordon and D.M. Morgan, *Lancet*, ii (1981) 4.
286. P. Braquet, N. Senn, J.P. Robin, A. Esanu, T. Godfraind and R. Garay, *Pharmacol. Res. Commun.*, 18 (1986) 239.
287. R. Nagarajan, in *Mycotoxins; Production, Isolation, Separation and Purification*, ed. V. Betina (Elsevier, Amsterdam, 1984) pp. 351-385.
288. J.W. Mason and J.G. Kidd, *J. Immunol.*, 66 (1951) 99.
289. S.T. Cordiner and T.W. Jordan, *Biochem. J.*, 73 (1983) 204.
290. A. Mullbacher, P. Waring, U. Tiwari-Palni and R.D. Eichner, *Mol. Immunol.*, 23 (1986) 231.
291. M. Okamoto, K. Yoshida, M. Nishikawa, T. Ando, M. Iwami, M. Kohsaka and H. Aoki, *J. Antibiot.*, 39 (1986) 204.
292. M. Okamoto, K. Yoshida, I. Ushida, M. Nishikawa, M. Kohsaka and H. Aoki, *Chem. Pharm. Bull.*, 34 (1986) 344.
293. M. Okamoto, K. Yoshida, I. Uchida, M. Kohsaka and H. Aoki, *Chem. Pharm. Bull.*, 34 (1986) 345.
294. M. Okamoto, K. Yoshida, M. Nishikawa, K. Hayashi, I. Uchida, M. Kohsaka and H. Aoki, *Chem. Pharm. Bull.*, 34 (1986) 3005.
295. M. Okamoto, K. Yoshida, M. Nishikawa, M. Kohsaka and H. Aoki, *Thromb. Res.* 42 (1986) 661.
296. G.W. Kirby, D.J. Robins, M.A. Sefton and R.R. Talekar, *J. Chem. Soc. Perkin Trans. 1*, (1980) 121.
297. K. Yoshida, M. Okamoto, N. Shimazaki and K. Hemmi, *Prog. Biochem. Pharmacol.*, 22 (1988) 66-80.
298. K. Mimura, S. Yukawa, T. Goto, Y. Mori, M. Mune, A. Yukawa, M. Kishino, K. Bando, Y. Yamada and H. Nomoto, *Proc. Japanese Conference on the Biochemistry of Lipids*, 28 (1986) 253.
299. P.W. Trown, *Biochem. Biophys. Res. Commun.*, 33 (1968) 407.
300. P.H. Mortimer and B.S. Collins, *Rev. Vet. Sci.*, 9 (1968) 142.
301. R. Munday, *Chem.-Biol. Interact.*, 41 (1982) 361.
302. Ph. Guinot, P. Braquet, J. Duchier and A. Cournot, *Prostaglandins*, 32 (1986) 163.
303. Ph. Guinot, C. Brambilla, J. Duchier, A. Taytard and C. Summerhayes, in Ref. 191, pp. 345-354.

304. Ph. Guinot, C. Summerhayes, L. Berdah, J. Duchier and R.J. Revillaud, *Lancet*, 2 (1988) 114.
305. W.S. Adamus, H. Heuer, C.J. Meade and H.M. Brecht, *Prostaglandins*, 35 (1988) 836.
306. W.S. Adamus, H. Heuer, C.J. Meade, E.R. Kempe and H.M. Brecht, *Prostaglandins*, 35 (1988) 797.
307. W.S. Adamus, H. Heuer, C.J. Meade, V. Haselbarth and H.M. Brecht, *Allergy*, 43 (1988) 124.
308. W.S. Adamus, H. Heuer, C.J. Meade, G. Frey and H.M. Brecht, *Eur. J. Clin. Pharmacol.*, 35 (1988) 237.
309. H. Heuer, J. Casals-Stenzel, C. Muacevic, W. Stransky, K.H. Weber, *Prostaglandins*, 35 (1988) 798.
310. P. Sedivy, S. Weber, J. Gergoire, F. Gaisne, G. Strauch, D. DeLauture and A. Floch, in *Ref. 70*, A345.
311. P. Braquet, M. Paubert-Braquet, R. Bourgain, F. Bussolino and D. Hosford, *J. Lipid Mediators* 2 (1989) 75.
312. A. Cerami and B. Beutler, *Immunol. Today*, 9 (1988) 31.
313. B. Bonavida and P. Braquet, *Prostaglandins*, 35 (1988) 802 (Abstr.).
314. R.L. Berkow, D. Wang, J.W. Larrich and T.H. Howard, *Blood*, 68 (1986) 80a.
315. G.M. Vercellotti, H.Q. Yin, K.S. Gustafson, P.O. Nelson and P.S. Jacob, *Blood*, 71 (1988) 1100.
316. M. Paubert-Braquet, M.O. Longchamp, P.L. Koltz and J. Guibaud, *Prostaglandins*, 35 (1988) 803 (Abstr.).
317. F. Bussolino, G. Camussi and C. Baglioni, *J. Biol. Chem.*, 263 (1988) 11856.
318. D. Hosford and P. Braquet, in *Immune Consequences of Trauma, Shock and Sepsis* (Springer Verlag, Berlin, 1989) p. 297.
319. P. Braquet, D. Hosford, M. Pauber-Braquet, R. Bourgain and F. Bussolino, *Int. Arch. Allergy Appl. Immunol.*, 88 (1989) 88.
320. M. Paubert-Braquet, D. Hosford and P. Braquet, in *Proceedings of Conference on Drugs Affecting PAF: An Update on their Therapeutic Applications*. London, Sept. 14–15 (1988) pp. 37–42.
321. P. Braquet, M. Paubert-Braquet, M. Koltai, R. Bourgain, F. Bussolino and D. Hosford, *Trends Pharmacol. Sci.* 10 (1989) 23.
322. S.A. Cannistra, E. Vellenga, P. Groshek, A. Rambaldi and J.D. Griffin, *Blood*, 71 (1988) 672.
323. R. Thom, *Structural Stability and Morphogenesis* (translated by D.H. Fowler) (Benjamin-Addison Wesley, New York, 1975).
324. X. Sun and W. Hsueh, *J. Clin. Invest.*, 81 (1988) 1328.
325. K.H. Weber, A. Harreus, W. Stransky, G. Walter, J. Casals-Stenzel, G. Muacevic, H. Heuer and W.D. Dietrich. *Eur. Pat.* 254, 254; *Chem. Abstr.*, 109 (1989) 129067a.
326. A. Walsler, *Eur. Pat.* 320, 992. (Chem Abstr. not yet published.)
327. T. Tahara, M. Moriwaki, M. Abe and S. Yuasa. *Eur. Pat.* 268, 242; *Chem. Abstr.* 109 (1989) 211069t.
328. D. Lave, C. James, H. Rajoharison, P.E. Bost and I. Cavero. *Drugs Future* 14 (1989) 891.
329. J.J. Piwinski, A.K. Ganguly, M.J. Green, F.J. Villani and J. Wong. *Eur. Pat.* 270, 818; *Chem. Abstr.* 110 (1989) 8053e.
330. N. Takeuchi, T. Kasama, K. Mayuzumi, K. Tamaru, H. Fukaya, T. Ohno and S. Tobinaga. *Chem. Pharm. Bull* 36 (1988) 4221.
331. S.B. Hwang, M.N. Chang, M.L. Garcia, Q.Q. Han, L. Huang, V.F. King, G.J. Kaczorowski and R.J. Winquist. *European J. Pharmacol.* 141 (1989) 269.

332. T.Y. Shen, I. Hussaini, S.B. Hwang and M.N. Chang. *Adv. in Prostaglandin, Thromboxane and Leukotriene Research.* 19 (1989) 359.
333. Y.C.P. Chiang, T. Biftu, D.W. Graham, S.S. Yang, M.N. Chang, J.C. Chabala and K.L. Thomson. *Eur. Pat.* 257, 921; *Chem. Abstr.* 110 (1989) 57297w.
334. S. Kadota, L. Marpaung, T. Kikuchi and H. Ekimoto. *Tetrahedron Lett.* 30 (1989) 1111.

Index

- A-56620, antibacterial agent, 256, 258
Acetaminophen, synergy with emorfazone, 5
Acetylsulfamethoxypyridazine, 26
ACTH, 150
ADR 847, antiemetic agent, 303
ADR 851, antiemetic agent, 303
Adrenaline, *photodegradation*, 60
Adrenochrome, *photodegradation* product, 60
Ag 246, analgesic, 8
Agr 620, antidepressant, 11
Albumin, peptides from, 165
Alizapride, 299–302
Allergy to Hg or Ni salts, 204, 216
Alprazolam, as PAF antagonist, 330, 338, 349
AM 1091, antibacterial agent, 244
Amidopyrine, *photodegradation*, 84
Amifloxacin, 251, 253
Amino acid, transport inhibition by Hg salts, 195
Amino acids, effect of Hg salts, 195
 photodegradation, 58, 59, 63
p-Aminobenzoic acid, *photodegradation*, 63
Aminophylline, *photodegradation*, 90
Aminopterin, *photodegradation*, 103
Amiodarone, metabolite, 54
 photodegradation, 87
Amipizone, 18
Analgesics, 1-benzazepines as, 135
 photodegradation, 84
 pyridazines as, 3
 pyridazinones as, 3
Angiotensin-converting enzyme, 130
 inhibitors, 131, 132, 134
Antiallergic agents, pyridazines as, 34
 pyridazinones as, 34
Antiamoebic agents, *photodegradation*, 107
Antianginal agents, *photodegradation*, 87
Antiarrhythmic agents, 1-benzazepines as, 128, 129
Antibacterial agents, 235
 photodegradation, 85, 94, 95, 102
 pyridazines as, 25
Antibiotics, *photodegradation*, 62, 76
Anticoagulants, *photodegradation*, 103
Anticonvulsants, 1-benzazepines as, 125, 127, 135
 pyridazinediones as, 14
 pyridazines as, 13
 pyridazinones as, 14
Antidepressants, *photodegradation*, 76, 112
 pyridazines as, 10
Antiemetic drugs, 297
 benzamides, 299
 butyrophenones, 316
 cannabinoids, 316, 319
 phenothiazines, 316
 stereoisomers, 299
 structure–activity relationships, 299
Antifungal agents, *photodegradation*, 95
 pyridazines as, 33
 pyridazinethiones as, 32, 33
 pyridazinones as, 32
Antihistamines, *photodegradation*, 61
 pyridazines as, 34
Antihypertensive agents, 1-benzazepines as, 130–133
 photodegradation, 89, 93
 substance P, 155
Anti-inflammatory agents, 1-benzazepines as, 134
 photodegradation, 75, 86, 88
 pyridazines as, 5
 pyridazinones as, 3
Antimalarial drugs, *photodegradation*, 100
Antiparkinsonism agents, *photodegradation* of levodopa, 59
 pyridazines as, 15
 pyridazinones as, 15
Antisecretory agents, 1-benzazepines as, 34
 pyridazines as, 8

- Antithrombotic agents, pyridazinones as, 17–19
 Antitumour agents, 1-benzazepines as, 135
 photodegradation, 85, 90, 103
 pyridazine *N*-oxides as, 20, 23
 pyridazinediones as, 21
 pyridazinones as, 21, 23
 Antiulcer agents, 1-benzazepines as, 34
 pyridazines as, 8
 Antiviral agents, pyridazine aldehyde thiosemicarbazone, 25
 pyridazinones as, 24
 Antrimycin, 31
 Anxiolytics, pyridazinones as, 12
 1,2,4-triazolo[4,3-*a*]benzazepines as, 125
 Area postrema, in emesis, 306–309
 Arthritis, mast cell count in rheumatoid, 146
 Substance P and, 146
 Aspartic acid from benorylate, 58
 Atropine, antagonism of PAF, 330
 Azathioprine, metabolite and photodegradation, 54
 photodegradation, 91
 Azinotrizin, 32
- Barbitone, photodegradation, 97
 Barbiturates, photodegradation, 97
 Batanopride, 299, 318
 comparative potency, 311
 BBM-928, 22, 31
 antibacterial action, 31
 Benorylate, photodegradation, 57
 photostability, 54
 1-Benzazepines, 123
 actions on cardiovascular system, 128
 actions on CNS, 124
 enzyme inhibition, 131–134
 gastric secretory inhibition, 134
 hypoglycaemic action, 135
 miscellaneous actions, 135
 serotonin antagonism, 134
 synthesis, 135
 1-Benzazocines as drugs, 131, 132
 1,4-Benzodiazepines, antiemetic action, 317
 photodegradation, 109
 Benzofurans, antiemetic, 303, 304
 Benzoxapofen, photodegradation, 75, 88
 Betamethasone, photodegradation, 80
 Bezold–Jarisch reflex, test for antiemetic action, 304, 311, 313
 Bithional, as photoallergen, 54
 BMY 25801, antiemetic agent, 299, 313, 318
 comparative potency, 311
 BMY 25989, antiemetic agent, 301, 302
 BN 52004, PAF antagonist, 352
 BN 52010, PAF antagonist, 352
 BN 52011, PAF antagonist, 352
 BN 52020, PAF antagonist, 345–349
 BN 52021, PAF antagonist, 343–349
 clinical studies, 360
 BN 52022, PAF antagonist, 343–347
 clinical studies, 360
 BN 52063, PAF antagonist, 360, 361
 BN 52111, PAF antagonist, 335, 336
 BN 55009, PAF antagonist, 334
 Bradykinin, 146, 150, 158
 biological effects, 164, 169
 BRL 20627, antiemetic agent, 302, 303
 BRL 24924, antiemetic agent, 303, 313, 315
 comparative potency, 311
 BRL 43594, antiemetic agent, 312
 BRL 43694, antiemetic agent, 313, 318, 319
 BRL 43994, antiemetic agent, 311
 Brotizolam, as PAF antagonist, 330
 Burchellin, 351, 352
 Burseran, 352
 Butyrophenones, antiemetic action, 316
- Calciferol, photodegradation, 69
 Calcitonin-gene related peptide, 150, 158
 Calcium-induced secretion, 179
 Calmodulin, reaction with Hg salts, 196
 Cannabinoids, antiemetic action, 316, 319
 Cantor, 11
 Captopril, 130, 131
 Carbutamide, photodegradation, 64
 Cardiotonic agents, 1-benzazepines as, 128
 Catecholamines, photodegradation, 60
 CCI 17810, platelet aggregation inhibitor, 17
 Cephalosporins, pyridazine-containing, 30
 Cetohezazine, 13
 CGS 12831, antihypertensive agent, 132

- CGS 14824A, antihypertensive agent, 132
CGS 16617, antihypertensive agent, 133
Chloramphenicol, photodegradation, 62
Chlordiazepoxide, photodegradation, 111
Chloroform, photodegradation, 56
Chlorprothixene, photodegradation, 104
Chloroquine, photodegradation, 100
Chlorothiazide, photostability, 54
Chlorpromazine, as photoallergen, 54
 photodegradation, 105
 phototoxicity, 54
Chlorpropamide, photodegradation, 64
Chlortetracycline, photodegradation, 76
Cholecystokinin antagonists, 134
Choroquine, phototoxicity, 54
Chrysophyllin, 352
C1934, antibacterial agent, 259, 263, 264
 enantiomers, 275
Cinchona alkaloid, photodegradation, 100
Cinchonidine, photodegradation, 100
Cinchonine, photodegradation, 101
Cinitapride, 302
Ciproflaxin, 258
Ciprofloxacin, 236, 243, 246, 259
 adverse reactions, 247
 analogues, 252, 288
 comparative potency, 264, 266, 281
Cirratiomycin A, 31
Cisapride, 302
Cisplatin-induced emesis, 299, 301, 303, 304,
 311, 313–319
 antidotes, 299, 301, 303, 304, 311, 313,
 315, 316–319
Clebopride, 302
Clomiphene, photodegradation, 67
Clozapine, 125–127
Clopenthixol, photodegradation, 104
CM 30366, antidepressant, 12
CM 40907, anticonvulsant, 14
 antidepressant, 14
Cocaine, photodegradation, 89
Compound 137-224, PAF antagonist, 333
Compound 30038CM, antidepressant, 11
Compound 48740 RP, PAF antagonist, 330,
 337
 clinical studies, 362
Compound 52770 RP, PAF antagonist, 330
 stereoisomers, 337, 338
Corticosteroids, antiemetic action, 317
Coumermycin, mode of action, 239
CP-9212, antibacterial agent, 273
Crabrolin, 150
Crotepoxide, PAF antagonist, 368
CS 61, antibacterial action, 26
CV-3988, PAF antagonist, 330–334
 use in humans, 331
CV-6209, PAF antagonist, 331
Cyclobarbitone, photodegradation, 98
Cyclohexane diepoxide derivative, PAF an-
 tagonist, 367
Cyclopenthiazole, photostability, 54

Dacarbazine, photodegradation, 85
Danofloxacin, 285
Dazopride, 302, 315
Delibryl, 13
Demeclocycline, photodegradation, 76, 77
Denpidazone, 15
Depsipeptides, pyridazine-containing, 31
Dexamethasone, antiemetic action, 317
 photodegradation, 80
Diacylglycerol and protein kinase, 329
2,3-Diazabicyclo[2.2.1]heptanes, anticonvul-
 sants, 14
Diazepam, photodegradation, 55, 109
Diazoide, photostability, 54
Dienoestrol, photodegradation, 68
Diethyl ether, photodegradation, 56
Difloxacin, 255, 256
 comparative potency, 264
Dihydroergotamine, photodegradation, 92
3,4-Dihydroxyphenylalanine, from benorylate, 58
 photodegradation, 63
Diltiazem, 337, 338
Dimeclocycline, photodegradation, 76
Diphenhydramine, photodegradation, 61
Diphenylcyclopentane sulphones as PAF an-
 tagonists, 367
Dipyridamole, photodegradation, 103
Dipyron, synergy with emorfazone, 5
Disodium cromoglycate, 153–155, 181
 antagonism of PAF, 330
Dithranol, mode of action, 55
 photodegradation, 74

- Diuretics, photodegradation, 80, 89, 90, 102
- DNA gyrase (bacterial topoisomerase), 238, 252, 259, 276
- inhibition and antibacterial potency of drugs, 264, 274
 - inhibition by fluoroquinolones, 240, 270
- DNA, role of bacterial, 238
- DOPA, photodegradation product, 58, 59
- Dopamine (D₂) receptor, blockade, 298, 299, 301, 303
- emesis and, 310, 318
- Dothiepin, photodegradation, 112
- Doxepin, antagonism of PAF, 330, 349
- photodegradation, 112
- Doxycycline, photodegradation, 76
- Droperidol, antiemetic action, 316
- Dynorphin, 150
- Eledosin, 156
- Emesis, antagonists of 5-HT₃ in, 313
- apomorphine-induced, 299, 308, 309
 - area postrema in, 308, 309
 - cisplatin-induced, 299, 301, 303, 304, 311, 313–319
 - copper sulphate-induced, 309
 - 5-HT and, 310–312
 - in animals, 307, 312, 313
 - neuropharmacology, 305
 - radiation-induced, 309
 - spiperone-binding test, 299
- Emetine, photodegradation, 107
- Emorfazone, 3–5
- Enalapril, 131
- Endocrine system, effect of Hg salts, 199
- β -Endorphin, 150
- Enoxacin, 243, 246, 253, 280
- side-effects, 247, 251
 - structure–activity relationships, 250, 257
- Enzymes, effect of Hg salts, 195
- Ephedrine, photodegradation, 59
- Epinephrine – *see* Adrenaline
- Ergoline derivatives, tranquilizers, 13
- Ergotamine, photodegradation, 92
- Ethinylloestradiol, photodegradation, 78
- Etizolam as PAF antagonist, 338
- Flumequine, 236, 274
- methyl-, 274
- Fluoroquinolones, adverse reactions, 245
- antibacterial properties, 235, 237
 - bactericidal action, 239
 - clinical studies, 245
 - conformationally constrained, 277
 - effect of rifampicin, 239
 - mode of action, 238
 - N*-oxide, 287
 - prodrug, 287
 - resistance to, 244
 - spectrum of action, 243
 - spiro analogues, 277
 - stereoisomers, 265, 267, 271–276
 - structure–activity relationships, 248, 254
- Flupenthixol, photodegradation, 104
- Fluperlapine, 125, 127
- Folic acid, photodegradation, 103
- FR 49174, PAF antagonist, 355–359
- FR 65049, PAF antagonist, 356
- FR 72112, PAF antagonist, 358, 359
- FR 106969, PAF antagonist, 356
- FR 900452, PAF antagonist, 356–359
- Frusemide, photodegradation, 80
- phototoxicity, 54
- Furazolidone, photodegradation, 81
- Furosemide – *see* Frusemide
- Futoxine, PAF antagonist, 368
- GABA, antagonists, 16
- blocking uptake of, 14
 - transmission, 15
- Gastrin, 150, 161
- GBE 761, PAF antagonist, 361
- Ginkgolides, 341, 360
- synthesis, 342
- Gliotoxin, PAF antagonist, 355
- stereoisomers, 357
 - structure–activity relationships, 356
- GR 38032F, antiemetic agent, 305, 311–315
- comparative potency, 311
- GR 65630, antiemetic agent, 305, 312
- comparative potency, 311, 318
- Grafinin, synergy with emorfazone, 5
- Granisetron, comparative potency, 311, 318
- GS 1065-180, PAF antagonist, 333, 334
- GS 1160-180, PAF antagonist, 333, 334

- Haloperidol, antiemetic action, 310, 316
Hexachlorophene, photodegradation, 65
Histamine, in mast cells, 144
 release by peptides, 148, 159
Hydrochlorothiazide, photodegradation, 102
 photostability, 54
4-Hydroxy-3-methoxybenzaldehyde, photodegradation, 57
Hydroxychloroquine, photodegradation, 100
5-Hydroxytryptamine (5-HT), antagonist, 134
 emesis and, 298
 role of, 314
Hypnotics, photodegradation, 95, 101
 pyridazines as, 13
Hypoglycaemic agents, 1-benzazepines as, 135
- ICS 205-930, antiemetic agent, 304, 312, 313
 comparative potency, 311, 318, 319
Imidazo[2,1-*a*]isoquinolines, PAF antagonist, 340
Immune function, effect of peptides, 145
Immune system, effect of Hg salts, 200
 effect of Ni salts, 214
Immunosuppressants, photodegradation, 91
 pyridazinones as, 24
Indapamide, photodegradation, 89
Indoles as PAF antagonist, 355–359
Interleukins, 149, 150, 163, 363–366
Ionophores and Hg salts, 196
Isamfazon, 6
Isoniazid, photodegradation, 94
Isoprenaline, photodegradation, 60
Isoproterenol – *see* Isoprenaline
Isopulsan, 11
- Kadsurenone, PAF antagonist, 344, 350–352
Kadsurins, 350
Kantor, 11
Ketanserine, 313
Khellactone analogues, PAF antagonists, 367
Kidneys, effect of Hg or Ni salts, 204, 218
Kinotensin, 165
L-652469, PAF antagonist, 367
L-652731, PAF antagonist, 352
L-653150, PAF antagonist, 353
L-659989, PAF antagonist, 353
Leukotriene in anaphylaxis, 345
Levodopa, photodegradation, 59
Lignans, benzofuranoid, 350
 butanolide, 354
 PAF antagonist, 350
 structure–activity relationships, 351
Lipids, reaction with Hg salts, 198
 reaction with Ni salts, 213
Local anaesthetics, 1-benzazepines as, 134, 135
Lu 23051, platelet aggregation inhibitor, 18
Luzopeptin, 31
Lymphocytes, effect of Hg salts, 200
 effect of Ni salts, 214
- M 73101, analgesic, 3
Magno-salicin, 352
Malazin, 26
Mast cells, arthritis and, 146
 binding of peptides, 168
 blocking of histamine release, 346
 histamine in, 144, 179
 hypersensitivity, role in, 144
 inflammatory response and, 145, 161, 166
 locations, 144
 morphology, 146
 nervous system and, 147
 peptides as regulators and, 145, 149
 regulation of function, 144
 secretion-stimulation coupling, 176, 178
Mastoparan, 150, 158
MDL 72222, antiemetic agent, 304, 312
 comparative potency, 311, 319
Melantin, 150
Menadione, photodegradation, 70, 72, 73
Menaquinone-1, photodegradation, 71
Mercaptopurine, photodegradation, 90
Mercaptopurine, phototoxicity, 54
Mercury(II) chloride, absorption through skin, 191
 biological properties, 190
 clearance, 193
 effect on mice and rats, 203

- genotoxicity, 206
 - in organs, 192
 - in plasma, 191
 - interactions, 195
 - teratogenicity, 206
- Metamfazon, 8
- Methaqualone, metabolite and photodegradation, 54
 - photodegradation, 101
- Methiothepin, 313
- Methotrexate, photodegradation, 103
- Methoxsalen, photodegradation, 91, 92
- Methoxypsoralen, photodegradation, 91, 92
- Methylflumequine, 274
- Methylphenobarbitone, photodegradation, 98
- Methypylone, photodegradation, 95
- Metoclopramide, 298, 299, 312, 313
 - analogues, 299, 302
 - antiemetic properties, 310, 315, 316–319
- Matronidazole, photodegradation, 85
- Milrinone, 128
- Minaprine, 11, 12
- MK-421, antihypertensive drug, 131
- Monoamine oxidase inhibition, 12
- Motapizone, antithrombotic action, 17
- Muscle relaxants, pyridazinediones as, 15
 - pyridazinones as, 15
- Muscular tissue, effect of Ni salts, 214

- Nalidixic acid, 236, 253
 - photodegradation, 102
 - phototoxicity, 54
- Naloxone, antagonism of PAF, 330
- Nandron, 5
- 1,8-Naphthyridines, antibacterial, 250, 251, 254–258, 262
- Naproxen, photodegradation, 75
 - phototoxicity, 54
- NAT 05-239, antithrombotic action, 17
- Nectandrin, 352
- Neolignan, definition, 350
- Nerve growth factor, 150, 159
- Nervous system, effect of Hg salts, 199
- Neurokinin A, 147, 156
- Neuroleptics, 1-benzazepines as, 125
 - pyridazinones as, 12
- Neuromedin K, 156

- Neurotensin, 146, 150, 151
- Nickel(II) sulphate and chloride, carcinogenesis, 220
 - clearance, 210
 - genotoxicity, 219
 - intake routes, 207
 - interactions, 211
 - skin allergy, 216
 - teratogenesis, 218
- Nicotine, photodegradation, 82
- Nicotinic acid, photodegradation, 94
- Nifedipine, photodegradation, 96
- Nifurprazine, 26
- Nitrazepam, photodegradation, 110
- 5-Nitrofurans, photodegradation, 81
- Nitrofurantoin, photodegradation, 81
- Nitrofurazone, photodegradation, 81
- 5-Nitrofurfural and derivatives, 27
 - photodegradation, 81
- Noradrenaline, photodegradation, 60
- Norepinephrine – *see* Noradrenaline
- Norethindrone, photodegradation, 77
- Norethisterone, photodegradation, 77
- Norfloxacin, 236, 240, 246, 252, 287
 - analogues, 248, 288, 289
 - comparative potency, 253, 255, 266, 281, 282, 287
 - dimer, 242
- Nortimic, 11
- Nucleic acids, reaction with Hg salts, 197
 - reaction with Ni salts, 212

- Oestrogens, photodegradation of synthetic, 67
- Oestrone, photodegradation, 78
- Ofloxacin, 243, 246, 253, 277
 - comparative potency, 263, 264, 279, 285
 - enantiomers, 265, 271–274
 - prodrug, 287
- Ondansetron, 305
 - comparative potency, 311, 318
- Ono-6240, PAF antagonist, 332
- Opiates, 145, 160
- Oxolinic acid, 253, 273
 - photodegradation, 102, 103
- Oxytetracycline, photodegradation, 76

- Paracetamol, synergy with emorfazone, 5
- Parathormone, 150, 160
- PD117558, antibacterial agent, 244, 264, 283
- Pefloxacin, 243, 246, 250, 252
- analogues, 288
 - comparative potency, 253, 256, 287
- Penicillins containing pyridazine, 30, 31
- Pentobarbitone, photodegradation, 98
- Pentoil, 5
- Pentoil, 5
- Peptides, binding to mast cells, 168
- C3a and C5a, 150
 - delivery at mast cells, 147
 - effect on mast cell function, 149, 150
 - from albumin, 165
 - from inflammatory cells, 161
 - histamine release by, 146
 - immune function and, 145
 - mechanism of action, 168
 - secretion by mast cells, 147
 - structure–activity relationships, 171
 - vasoactive intestinal, 146
- Perphenazine, photodegradation, 105
- Phenazone, photodegradation, 82
- Phenothiazines, antiemetic action, 316
- photodegradation, 105
- Phenylalanine, photodegradation, 58
- Phenylbutazone, photodegradation, 86
- synergy with emorfazone, 5
- Phenylephrine, photodegradation, 61
- Phenytol, photodegradation, 84
- Photoallergy, 54, 55
- Photodecarboxylation, 88
- Photodecomposition of drugs, 51
- analytical use, 112
 - classified list, 113
- Photodecomposition of vitamins, 69
- Photodemethylation, 89
- Photo-Fries reaction on drugs, 58
- Photosensitization by drugs, 54, 88, 91
- Photosensitizer, definition, 55
- Phototoxicity, 54, 55
- Phthalylsulfapyridazine, 26, 27
- Phylloquinone, photodegradation, 71
- Physostigmine, photodegradation, 92
- Pipemic acid, 236, 249, 253
- Pir 353, anti-inflammatory agent, 6
- Platelet aggregation inhibitors, 17
- Platelet-activating factor (PAF), binding sites, 328
- naturally occurring, 341
 - physiological role, 327
 - structure, 326
 - structure–activity relationships, 329
 - synthesis, 327
- Platelet-activating factor antagonists, bronchoconstricting effect, 344
- clinical studies, 360
 - effect on blood pressure, 346
 - effect on CNS, 349
 - effect on immune processes, 346
 - effect on intestinal ischaemia, 349
 - effect on shock, 346
 - mechanism of action, 362
 - pharmacology, 344
 - prostaglandin formation, 345
 - pulmonary effects, 345
 - stereoisomers, 332, 352
 - sterically constrained, 334
 - synthetic, 330
- Polythiazide, photostability, 54
- Prednisolone, photodegradation, 79
- Prednisone, photodegradation, 78
- Prochlorperazine, photodegradation, 105
- Prodrug for fluoroquinolones, 287
- Promazine, photodegradation, 105
- Promethazine, as photoallergen, 54
- photodegradation, 106
- Prostacyclin biosynthesis, inhibitors of, 7
- Prostaglandins release by Hg salts, 198
- Proteins, interaction with Hg salts, 195
- interaction with Ni salts, 211
- Protryptiline, photodegradation, 76
- Proxibarbitone, photodegradation, 98
- Psoralens, mode of action, 55
- photodegradation, 91
 - phototoxicity, 54
- Pyrazolones, photodegradation, 82
- Pyridazine, 3-amino-4-mercapto-6-methyl-, 5, 6
- S₁, 5
- Pyridazinediones, antibacterial action, 88
- anticonvulsant action, 14
 - antitumour action, 21
- Pyridazines, analgesic action, 25
- antiallergic action, 34

- antibacterial action, 25
- antidepressant action, 10
- antifungal action, 32
- anti-inflammatory action, 3
- antisecretory action, 8
- antithrombotic action, 17
- antitumour action, 20
- antiulcer action, 8
- beta-lactam-containing, 30
- biological action, 1
- GABA antagonists, 16
- muscle relaxant action, 15
- naturally occurring, 2
- neuroleptic action, 12
- N*-oxides, 20, 23
- sulpha drug analogues, 26, 27
- tranquillizing action, 13
- Pyridazinium salts, antibacterial action, 29
- antifungal action, 34
- nucleosides, 30
- Pyridazinomycin, 2, 33
- Pyridazinones, analgesic, 3
 - antibacterial action, 27, 28
 - anti-inflammatory, 5
 - antisecretory, 9
 - antithrombotic action, 17–19
 - antitubercular action, 29
 - antitumour action, 21, 23
 - antiulcer, 9
 - antiviral action, 24
 - benzofuran derivatives, 29
 - immunosuppressant action, 24
 - nucleoside, 23
 - platelet aggregation inhibition, 17, 18
 - sedative, 13
 - tranquillizer action, 13
- Pyrido[1,2,3-*de*]-1,4-benzothiazine-6-carboxylic acid, 279
- Pyrido[2,1-*b*]quinazolines, PAF antagonist, 340
 - stereoisomers, 340
- Pyridoxal phosphate, photodegradation, 96
- Pyridoxine, photodegradation, 96
- Pyrithione, photodegradation, 95
- Pyrrolo[1,2-*c*]thiazole derivative, PAF antagonist, 337, 344, 366
- Quinalbarbitone, photodegradation, 98
- Quinidine, photodegradation, 101
- Quinine, photodegradation, 100
- Quinolizidines, antiemetic, 303
- 4-Quinolones, antibacterial action, 235
- Quipazine, 312
- R 62818, analgesic, 7
- Renal system, effect of Hg salts, 204
 - effect of Ni salts, 218
- Reproductive system, effect of Hg salts, 205
- Reserpine, photodegradation, 93
- Respiratory system, effect of Ni salts, 213
- Retinoic acid, photodegradation, 65
- Riboflavin, photodegradation, 108
- Ridaflo*ne or *Ridiflo*ne, 13
- Rifampicin, effect on fluoroquinolones, 239
- Ritodrine, photodegradation, 109
- Ro 18-6977, PAF antagonist, 335, 337
- Ro 18-7953, PAF antagonist, 333
- Ro 18-8736, PAF antagonist, 333
- Ro 19-1400, PAF antagonist, 333
- Ro 19-3704, PAF antagonist, 330, 332, 344
- Ro 24-4736, PAF antagonist, 366
- Rosoxacin, 280, 281
- RP 59227, PAF antagonist, 367
- RU 45 703, PAF antagonist, 330, 333
- Rufloxacin, 279
- S-25930, antibacterial agent, enantiomers, 265
- Salazosulfapyridazine, 26
- SCH 37370, histamine and PAF antagonist, 334, 337
- Sedative-hypnotics, 1-benzazepines as, 125
 - pyridazinones as, 13
- Selenium, effect on toxicity of Hg, 198
- Serotonin antagonists, 134
- Serotonin receptor (5-HT₃), 312
 - antagonists, 298, 304–306, 318
 - emesis and 5-HT, 310
 - function, 311
 - localization, 311, 313
- Sodium nitroprusside, photodegradation, 56
- Somatostatin, 146, 150, 157, 158, 162, 170, 175, 181
- Spirofluoroquinolones, 277

- SR 41378, GABA antagonist, 14
 SR 42641, GABA antagonist, 16
 SR 95103, GABA antagonist, 16
 SR 95191, antidepressant, 12
 SR 955r31, GABA antagonist, 16
 SRI 62-586, PAF antagonist, 335, 337
 SRI 63-072, PAF antagonist, 330, 334–336
 SRI 63-073, PAF antagonist, 335, 336
 SRI 63-119, PAF antagonist, 330, 332
 PAF antagonist, stereoisomers, 332
 SRI 63-441, PAF antagonist, 334
 SRI 63-675, PAF antagonist, 330, 334
 Stereoisomers, antibacterial agents, 265,
 267, 271–276
 antiemetic agents, 299
 PAF antagonists, 332, 337, 352, 357
 Steroids, photodegradation, 77
 Stilboestrol, photodegradation, 68
 STY 2108, PAF antagonist, 339
 SU-13197, antiarrhythmic action, 129
 Substance P, 145, 150, 155, 172
 arthritis and, 146
 histamine release by, 146
 resistance to carboxypeptidase, 146
 Sulfachlorpyridazine, 26
 Sulfamethoxy-pyridazine, 26, 27
 Sulfenazone, 26
 Sulfethoxy-pyridazine, 26
 Sulpha drugs, photodegradation, 63
 Sulphacetamide, photodegradation, 64
 Sulphadiazine, photodegradation, 64
 Sulphadimethoxine, photodegradation, 64
 Sulphaguanidine, photodegradation, 64
 Sulphamethizole, photodegradation, 64
 Sulphanilamide, as photoallergen, 54
 photodegradation, 63
 pyridazinyl, 26
 Sulphapyridine, photodegradation, 64
 Sulphathiazole, photodegradation, 64
 Sulphinpyrazone, PAF and, 330
 Sulpiride, 302
 Sulpyrine, photodegradation, 84
 synergy with emorfazone, 5
 Supercoiling, bacterial, 238, 252, 253, 270
 Tamoxifen, photodegradation, 69
 photostability, 54
 Temafloxacin, 246, 274
 enantiomers, 276
 Tetrachlorosalicylanilide, photodegradation,
 66
 Tetracyclines, photodegradation, 76
 phototoxicity, 54
 Tetranortriterpenoids as PAF antagonists,
 368
 Thiamine, photodegradation, 82
 Thiazolo[3,2-*a*]quinolone-4-carboxylic acids,
 278
 Thiosemicarbazones and antiviral agents, 25
 Thrombin, 150, 161
 Thymidine, photodegradation, 73
 Thyrotropin-releasing hormone, antagonism
 of PAF, 330
 Thyroxine, photodegradation, 66
 Ticlopidine, antagonism of PAF, 330
 α -Tocopherol, photodegradation, 99
 Tolbutamide, photodegradation, 64
 Topoisomerase II, 243
 Tosufloxacin, 244, 258, 271, 275
 enantiomers, 275
 Tranquillizers, photodegradation, 104, 105,
 109
 pyridazinones as, 13
 Triazolam, as PAF antagonist, 330, 338, 349
 1,2,4-Triazolo[4,3-*a*]benzazepines, effect on
 CNS, 125
 Triladine, 8
 Trioxsalen, photodegradation, 92
 Tropine derivatives, antiemetic action, 304,
 305
 Tuftsin, 158
 Tumour necrosis factor, mast cells and, 149
 PAF and, 363–366
 Tyrosine, from benorylate, 59
 photodegradation, 58
 Vanillin, photodegradation, 57
 Vitamin B-1, photodegradation, 82, 94
 Vitamin 5-2, photodegradation, 108
 Vitamin B-6, photodegradation, 96
 Vitamin D group, photodegradation, 69
 Vitamin E, photodegradation, 99
 Vitamin K group, photodegradation, 70

WEB 2086, PAF antagonist, 330, 337, 339
 clinical studies, 361
WEB 2170, PAF antagonist, 330, 339
WEB 2347, PAF antagonist, 366

Xenospin, 150

Y 24 180, PAF antagonist, 366
Y-590, platelet, aggregation inhibitor, 19
YM 09151-2, antiemetic agent, 302

Zacopride, 303, 312
 comparative potency, 311, 313–315, 319

Cumulative Index of Authors for Volumes 1–27

The volume number, (year of publication) and page number are given in that order

- Adams, S.S., 5 (1967) 59
Agrawal, K.C., 15 (1978) 321
Albrecht, W.J., 18 (1981) 135
Andrews, P.R., 23 (1986) 91
Ankier, S.I., 23 (1986) 121
- Bailey, E., 11 (1975) 193
Ballesta, J.P.G., 23 (1986) 219
Banting, L., 26 (1989) 253
Barker, G., 9 (1973) 65
Barnes, J.M., 4 (1965) 18
Beaumont, D., 18 (1981) 45
Beckett, A.H., 2 (1962) 43; 4 (1965) 171
Beddell, C.R., 17 (1980) 1
Beedham, C., 24 (1987) 85
Beisler, J.A., 19 (1982) 247
Benfey, B.G., 12 (1975) 293
Black, M.E., 11 (1975) 67
Blandina, P., 22 (1985) 267
Bond, P.A., 11 (1975) 193
Bonta, I.I., 17 (1980) 185
Booth, A.G., 26 (1989) 323
Boreham, P.F.I., 13 (1976) 159
Bowman, W.C., 2 (1962) 88
Bradner, W.T., 24 (1987) 129
Bragt, P.C., 17 (1980) 185
Branch, S.K., 26 (1989) 355
Braquet, P., 27 (1990) 325
Březina, M., 12 (1975) 247
Brooks, B.A., 11 (1975) 193
Brown, J.R., 15 (1978) 125
Brunelleschi, S., 22 (1985) 267
Bruni, A., 19 (1982) 111
Buckingham, J.C., 15 (1978) 165
Bulman, R.A., 20 (1983) 225
- Čarman-Kržan, M., 23 (1986) 41
Cassells, A.C., 20 (1983) 119
Casy, A.F., 2 (1962) 43; 4 (1965) 171; 7
(1970) 229; 11 (1975) 1; 26 (1989) 355
Caton, M.P.L., 8 (1971) 217; 15 (1978) 357
Chang, J., 22 (1985) 293
Chappel, C.I., 3 (1963) 89
Chawla, A.S., 17 (1980) 151; 22 (1985) 243
Cheng, C.C., 6 (1969) 67; 7 (1970) 285; 8
(1971) 61; 13 (1976) 303; 19 (1982) 269;
20 (1983) 83; 25 (1988) 35
Clark, R.D., 23 (1986) 1
Cobb, R., 5 (1967) 59
Cochrane, D.E., 27 (1990) 143
Crossland, J., 5 (1967) 251
Crowshaw, K., 15 (1978) 357
Cushman, D.W., 17 (1980) 41
Cuthbert, A.W., 14 (1977) 1
- Dabrowiak, J.C., 24 (1987) 129
Daly, M.J., 20 (1983) 337
D'Arcy, P.F., 1 (1961) 220
Daves, G.D., 13 (1976) 303; 22 (1985) 1
Davies, G.E., 2 (1962) 176
De, A., 18 (1981) 117
De Clercq, E., 23 (1986) 187
De Gregorio, M., 21 (1984) 111
Dimitrakoudi, M., 11 (1975) 1
Draffan, G.H., 12 (1975) 1
Durant, G.J., 7 (1970) 124
- Edwards, D.I., 18 (1981) 87
Ellis, G.P., 6 (1969) 266; 9 (1973) 65; 10
(1974) 245

- Falch, E., 22 (1985) 67
 Fantozzi, R., 22 (1985) 267
 Feigenbaum, J.J., 24 (1987) 159
 Feuer, G., 10 (1974) 85
 Finberg, J.P.M., 21 (1984) 137
 Frank, H., 27 (1990) 1
- Garratt, C.J., 17 (1980) 105
 Gill, E.W., 4 (1965) 39
 Ginsburg, M., 1 (1961) 132
 Goldberg, D.M., 13 (1976) 1
 Gould, J., 24 (1987) 1
 Graham, J.D.P., 2 (1962) 132
 Green, A.L., 7 (1970) 124
 Greenhill, J.V., 27 (1990) 51
 Griffiths, D., 24 (1987) 1
 Griffiths, K., 26 (1989) 299
 Gunda, E.T., 12 (1975) 395; 14 (1977) 181
 Gyllys, J.A., 27 (1990) 297
- Hacksell, U., 22 (1985) 1
 Halliday, D., 15 (1978) 1
 Hammond, S.M., 14 (1977) 105; 16 (1979) 223
 Hamor, T.A., 20 (1983) 157
 Harris, J.B., 21 (1984) 63
 Hartley, A.J., 10 (1974) 1
 Hartog, J., 15 (1978) 261
 Heacock, R.A., 9 (1973) 275; 11 (1975) 91
 Heinisch, G., 27 (1990) 1
 Heller, H., 1 (1961) 132
 Hill, S.J., 24 (1987) 30
 Hillen, F.C., 15 (1978) 261
 Hino, K., 2/ (1990) 123
 Hjeds, H., 22 (1985) 67
 Hooper, M., 20 (1983) 1
 Hopwood, D., 13 (1976) 271
 Hosford, D., 27 (1990) 325
 Hubbard, R.E., 17 (1980) 105
 Hughes, R.E., 14 (1977) 285
 Humber, L.G., 24 (1987) 299
- Iman, S.H., 21 (1984) 169
- Jacques, L.B., 5 (1967) 139
 James, K.C., 10 (1974) 203
 Jászberényi, J.C., 12 (1975) 395; 14 (1977) 181
 Jenner, F.D., 11 (1975) 193
 Jewers, K., 9 (1973) 1
 Jones, D.W., 10 (1974) 159
 Judd, A., 11 (1975) 193
- Kapoor, V.K., 16 (1979) 35; 17 (1980) 151; 22 (1985) 243
 Kelly, M.J., 25 (1988) 249
 Kendall, H.E., 24 (1987) 249
 Khan, M.A., 9 (1973) 117
 Kitteringham, G.R., 6 (1969) 1
 Kino, K., 27 (1990) 123
 Kobayashi, Y., 9 (1973) 1
 Koch, H.P., 22 (1985) 165
 Kramer, M.J., 18 (1981) 1
 Krogsgaard-Larsen, P., 22 (1985) 67
- Lambert, P.A., 15 (1978) 87
 Launchbury, A.P., 7 (1970) 1
 Law, H.D., 4 (1965) 86
 Lawson, A.M., 12 (1975) 1
 Lee, C.R., 11 (1975) 193
 Lenton, E.A., 11 (1975) 193
 Levin, R.H., 18 (1981) 135
 Lewis, A.J., 19 (1982) 1; 22 (1985) 293
 Lien, E.L., 24 (1987) 209
 Lloyd, E.J., 23 (1986) 91
 Lockhart, I.M., 15 (1978) 1
 Lord, J.M., 24 (1987) 1
 Lowe, I.A., 17 (1980) 1
 Lucas, R.A., 3 (1963) 146
 Luscombe, D.K., 24 (1987) 249
- Mackay, D., 5 (1967) 199
 Main, B.G., 22 (1985) 121
 Malhotra, R.K., 17 (1980) 151
 Manchanda, A.H., 9 (1973) 1
 Mannaioni, P.F., 22 (1985) 267
 Martin, I.L., 20 (1983) 157
 Masini, F., 22 (1985) 267
 Matthews, R.S., 10 (1974) 159

- Matsumoto, J., 27 (1990) 123
 Maudsley, D.V., 9 (1973) 133
 May, P.M., 20 (1983) 225
 McLelland, M.A., 27 (1990) 51
 McNeil, S., 11 (1975) 193
 Mechoulam, R., 24 (1987) 159
 Michel, A.D., 23 (1986) 1
 Miura, K., 5 (1967) 320
 Moncada, S., 21 (1984) 237
 Monković, I., 27 (1990) 297
 Montgomery, J.A., 7 (1970) 69
 Moody, G.J., 14 (1977) 51
 Morris, A., 8 (1971) 39; 12 (1975) 333
 Murphy, F., 2 (1962) 1; 16 (1979) 1
 Musser, J.H., 22 (1985) 293
- Natoff, I.L., 8 (1971) 1
 Neidle, S., 16 (1979) 151
 Nicholls, P.J., 26 (1989) 253
 Nordlind, K., 27 (1990) 189
- O'Harc, M., 24 (1987) 1
 Ondetti, M.A., 17 (1980) 41
 Ottenheim, H.C.J., 23 (1986) 219
- Paget, G.E., 4 (1965) 18
 Palatini, P., 19 (1982) 111
 Palazzo, G., 21 (1984) 111
 Palmer, D.C., 25 (1988) 85
 Parratt, J.R. 6 (1969) 11
 Parkes, M.W., 1 (1961) 72
 Parnham, M.J., 17 (1980) 185
 Paul, D., 16 (1979) 35; 17 (1980) 151
 Pearce, F.L., 19 (1982) 59
 Peart, W.S., 7 (1970) 215
 Petrow, V., 8 (1971) 171
 Pinder, R.M., 8 (1971) 231; 9 (1973) 191
 Ponnudurai, T.B., 17 (1980) 105
 Powell, W.S., 9 (1973) 275
 Price, B.J., 20 (1983) 1
 Prior, B., 24 (1987) 1
 Purohit, M.G., 20 (1983) 1
- Richards, W.G., 11 (1975) 67
 Richardson, P.T., 24 (1987) 1
 Roberts, L.M., 24 (1987) 1
 Roe, A.M., 7 (1970) 124
 Rose, H.M., 9 (1973) 1
 Rosen, T., 27 (1990) 235
 Roth, B., 7 (1970) 285; 8 (1971) 61; 19 (1982) 269
 Russell, A.D., 6 (1969) 135; 8 (1971) 39; 13 (1976) 271
 Ruthven, C.R.J., 6 (1969) 200
- Sadler, P.J., 12 (1975) 159
 Sampson, G.A., 11 (1975) 193
 Sandler, M., 6 (1969) 200
 Sarges, R., 18 (1981) 191
 Sartorelli, A.C., 15 (1978) 321
 Sewell, R.D.E., 14 (1977) 249
 Shaw, M.A., 26 (1989) 253
 Sheard, P., 21 (1984) 1
 Shepherd, D.M., 5 (1967) 199
 Silver, P.J., 22 (1985) 293
 Silvestrini, B., 21 (1984) 111
 Singh, H., 16 (1979) 35; 17 (1980) 151
 Skotnicki, J.S., 25 (1988) 85
 Slater, J.D.H., 1 (1961) 187
 Smith, H.J., 26 (1989) 253
 Smith, R.C., 12 (1975) 105
 Smith, W.G., 1 (1961) 1; 10 (1974) 11
 Sorenson, J.R.J., 15 (1978) 211; 26 (1989) 437
 Spencer, P.S.J., 4 (1965) 1; 14 (1977) 249
 Spinks, A., 3 (1963) 261
 Stähle, L., 25 (1988) 291
 Steiner, K.E., 24 (1987) 209
 Stenlake, J.B., 3 (1963) 1; 16 (1979) 257
 Stevens, M.F.G., 13 (1976) 205
 Stewart, G.A., 3 (1963) 187
 Studer, R.O., 5 (1963) 1
 Suschitzky, J.L., 21 (1984) 1
 Swallow, D.L., 8 (1971) 119
 Sykes, R.B., 12 (1975) 333
- Taylor, E.C., 25 (1988) 85
 Taylor, E.P., 1 (1961) 220
- Ram, S., 25 (1988) 233
 Reckendorf, H.K., 5 (1967) 320

- Tegner, C., 3 (1963) 332
Thomas, I.L., 10 (1974) 245
Thomas, J.D.R., 14 (1977) 51
Thompson, E.A., 11 (1975) 193
Tilley, J.W., 18 (1981) 1
Traber, R., 25 (1988) 1
Tucker, H., 22 (1985) 121
- Van den Broek, L.A.G.M., 23 (1986) 219
Van Dijk, J., 15 (1978) 261
Vincent, J.E., 17 (1980) 185
Volke, J., 12 (1975) 247
Von Seeman, C., 3 (1963) 89
Von Wartburg, A., 25 (1988) 1
- Waigh, R.D., 18 (1981) 45
Wajsbort, J., 21 (1984) 137
Walker, R.T., 23 (1986) 187
Walls, L.P., 3 (1963) 52
Walz, D.T., 19 (1982) 1
Waring, W.S., 3 (1963) 261
- West, G.B., 4 (1965) 1
Whiting, R.L., 23 (1986) 1
Whittle, B.J.R., 21 (1984) 237
Wiedling, S., 3 (1963) 332
Wien, R., 1 (1961) 34
Wilkinson, S., 17 (1980) 1
Williams, K.W., 12 (1975) 105
Williams-Smith, D.L., 12 (1975) 191
Wilson, H.K., 14 (1977) 285
Witte, E.C., 11 (1975) 119
Wold, S., 25 (1988) 291
Wood, E.J., 26 (1989) 323
Wright, I.G., 13 (1976) 159
Wynd, S.J., 12 (1975) 191
- Youdim, M.B.H., 21 (1984) 137
Young, P.A., 3 (1963) 187
- Zee-Cheng, R.K.Y., 20 (1983) 83
Zon, G., 19 (1982) 205
Zylicz, Z., 23 (1986) 219

Cumulative Index of Subjects for Volumes 1–27

The volume number, (year of publication) and page number are given in that order

- Adamantane, amino derivatives, 18 (1981) 1
Adenosine triphosphate, 16 (1979) 223
Adenylate cyclase, 12 (1975) 293
Adipose tissue, 17 (1980) 105
Adrenergic blockers, α -, 23 (1986) 1
 β -, 22 (1985) 121
Adrenoceptors, α_2 -, antagonists, 23 (1986) 1
Adrenochrome derivatives, 9 (1973) 275
Adriamycin, 15 (1978) 125; 21 (1984) 169
Aldose reductase inhibitors, 24 (1987) 299
Allergy, chemotherapy of, 21 (1984) 1; 22
 (1985) 293
Aminoadamantane derivatives, 18 (1981) 1
Aminopterins as antitumour agents, 25
 (1988) 85
Analgesic drugs, 2 (1962) 43; 4 (1965) 171; 7
 (1970) 229; 14 (1977) 249
Anaphylactic reactions, 2 (1962) 176
Angiotensin, 17 (1980) 41
Anthraquinones, antineoplastic, 20 (1983) 83
Antiallergic drugs, 21 (1984) 1; 22 (1985)
 293; 27 (1990) 34
Anti-arthritic agents, 15 (1978) 211; 19
 (1982) 1
Antibacterial agents, 6 (1969) 135; 12 (1975)
 333; 19 (1982) 269; 27 (1990) 235
Antibiotics, 12 (1975) 395; 14 (1977) 105; 14
 (1977) 181; 19 (1982) 249; 23 (1986)
 219
Anticancer agents – *see* Antitumour agents
Anticonvulsant drugs, 3 (1963) 261
Antidepressant drugs, 15 (1978) 261; 23
 (1986) 121
Antiemetic drugs, 27 (1990) 297
Antifilarial benzimidazoles, 25 (1988) 233
Antifolates as anticancer agents, 25 (1988)
 85; 26 (1989) 1
Antifungal agents, 1 (1961) 220
Antihyperlipidaemic agents, 11 (1975) 119
Anti-inflammatory action of thalidomide, 22
 (1985) 165
Antineoplastic agents, a new approach, 25
 (1988) 35
 anthraquinones as, 20 (1983) 83
Anti-rheumatic drugs, 17 (1980) 185; 19
 (1982) 1
Antitumour agents, 9 (1973) 1; 19 (1982)
 249; 20 (1983) 83; 23 (1986) 219; 24
 (1987) 1; 24 (1987) 129; 25 (1988) 35;
 25 (1988) 85; 26 (1989) 253; 26 (1989)
 299
Antitussive drugs, 3 (1963) 89
Antiviral agents, 8 (1971) 119; 23 (1986) 187
Aromatase inhibition and breast cancer, 26
 (1989) 253
Asthma, drugs for, 21 (1984) 1

1-Benzazepines, medicinal chemistry of, 27
 (1990) 123
Benzimidazole carbamates, antifilarial, 25
 (1988) 233
Benzisothiazole derivatives, 18 (1981) 117
Benzodiazepines, 20 (1983) 157
Beta-adrenergic blockers, 22 (1985) 121
British Pharmacopoeia Commission, 6
 (1969) 1
Bronchodilator and antiallergic therapy, 22
 (1985) 293

Calcium and histamine secretion from mast
 cells, 19 (1982) 59
Calcium channel blocking drugs, 24 (1987)
 249

- Cancer, aromatase inhibition and breast, 26 (1989) 253
 endocrine treatment of prostate, 26 (1989) 299
- Cannabinoid drugs, 24 (1987) 159
- Carcinogenicity of polycyclic hydrocarbons, 10 (1974) 159
- Catecholamines, 6 (1969) 200
- Cell membrane transfer, 14 (1977) 1
- Central nervous system, drugs, transmitters and peptides, 23 (1986) 91
- Chartreusin, 19 (1982) 249
- Chelating agents, 20 (1983) 225
- Cholinergic receptors, 16 (1976) 257
- Chromatography, 12 (1975) 1; 12 (1975) 105
- Chromone carboxylic acids, 9 (1973) 65
- Clinical enzymology, 13 (1976) 1
- Column chromatography, 12 (1975) 105
- Computers in biomedical education, 26 (1989) 323
 Medlars information retrieval, 10 (1974) 1
- Copper complexes, 15 (1978) 211; 26 (1989) 437
- Coronary circulation, 6 (1969) 11
- Coumarins, metabolism and biological actions, 10 (1975) 85
- Cyclic AMP, 12 (1975) 293
- Cyclophosphamide analogues, 19 (1982) 205
- Cyclosporins as immunosuppressants, 25 (1988) 1
- Data analysis in biomedical research, 25 (1988) 291
- Diaminopyrimidines, 19 (1982) 269
- Diuretic drugs, 1 (1961) 132
- DNA-binding drugs, 16 (1979) 151
- Doxorubicin, 15 (1978) 125; 21 (1984) 169
- Drug-receptor interactions, 4 (1965) 39
- Drugs, transmitters and peptides, 23 (1986) 91
- Electron spin resonance, 12 (1975) 191
- Endorphins, 17 (1980) 1
- Enkephalins, 17 (1980) 1
- Enzymes, inhibitors of, 16 (1979) 223; 26 (1989) 253
- Enzymology, clinical use of, 10 (1974) 1
 in pharmacology and toxicology, 10 (1974) 11
- Flavonoids, physiological and nutritional aspects, 14 (1977) 285
- Fluoroquinolone antibacterial agents, 27 (1990) 235
- Folic acid and analogues, 25 (1988) 85; 26 (1989) 1
- Free energy, biological action and linear, 10 (1974) 205
- GABA, heterocyclic analogues, 22 (1985) 67
- Gas-liquid chromatography and mass spectrometry, 12 (1975) 1
- Glutaraldehyde, biological uses, 13 (1976) 271
- Gold, immunopharmacology of, 19 (1982) 1
- Guanidines, 7 (1970) 124
- Halogenoalkylamines, 2 (1962) 132
- Heparin and heparinoids, 5 (1967) 139
- Herpes virus, chemotherapy, 23 (1986) 187
- Heterocyclic analogues of GABA, 22 (1985) 67
- Heterocyclic carboxaldehyde thiosemicarbazones, 16 (1979) 35
- Histamine H₂-antagonists, 20 (1983) 337
 receptors, 24 (1987) 30
 release, 22 (1985) 26
 secretion, calcium and, 19 (1982) 59
- Histidine decarboxylases, 5 (1967) 199
- Hydrocarbons, carcinogenicity of, 10 (1974) 159
- Hypersensitivity reactions, 4 (1965) 1
- Hypoglycaemic drugs, 1 (1961) 187; 18 (1981) 191; 24 (1987) 209
- Hypotensive agents, 1 (1961) 34
- Immunopharmacology of gold, 19 (1982) 1
- Immunosuppressant cyclosporins, 25 (1988) 1
- India, medicinal research in, 22 (1985) 243

- Information retrieval, 10 (1974) 1
Insulin, obesity and, 17 (1980) 105
Ion-selective membrane electrodes, 14 (1977) 51
Ion transfer, 14 (1977) 1
Isotopes, in drug metabolism, 9 (1973) 133
stable, 15 (1978) 1
- Lactam antibiotics, 12 (1975) 395; 14 (1977) 181
Leprosy, chemotherapy, 20 (1983) 1
Ligand-receptor binding, 23 (1986) 41
Linear free energy, 10 (1974) 205
Literature of medicinal chemistry, 6 (1969) 66
Lithium, medicinal use of, 11 (1975) 193
Local anaesthetics, 3 (1963) 332
Lonidamine and related compounds, 21 (1984) 111
- Malaria, drugs for, 8 (1971) 231; 19 (1982) 269
Mass spectrometry and GLC, 12 (1975) 1
Mast cells, calcium and histamine secretion, 19 (1982) 59
cholinergic histamine release, 22 (1985) 267
peptide regulation of, 27 (1990) 143
Medicinal chemistry, literature of, 6 (1969) 66
Medlars computer information retrieval, 10 (1974) 1
Membrane receptors, 23 (1986) 41
Membranes, 14 (1977) 1; 15 (1978) 87; 16 (1979) 223
Mercury(II) chloride, biological effects, 27 (1990) 189
Methotrexate analogues as anticancer drugs, 25 (1988) 85; 26 (1989) 1
Microcomputers in biomedical education, 26 (1989) 323
Molybdenum hydroxylases, 24 (1987) 85
Monoamine oxidase inhibitors, 21 (1984) 137
Multivariate data analysis and experimental design, 25 (1988) 291
Neuromuscular blockade, 2 (1962) 88; 3 (1963) 1; 16 (1979) 257
Next decade, drugs for, 7 (1970) 215
Nickel(II) chloride and sulphate, biological effects, 27 (1990) 189
Nitriles, synthesis of, 10 (1974) 245
Nitrofurans, 5 (1967) 320
Nitroimidazoles, cytotoxicity of, 18 (1981) 87
NMR spectroscopy, 12 (1975) 159
high-field, 26 (1989) 355
Non-steroidal anti-inflammatory drugs, 5 (1967) 59
Non-tricyclic antidepressants, 15 (1978) 261
Novobiocin, mode of action, 8 (1971) 39
C-Nucleosides, 13 (1976) 303; 22 (1985) 1
- Obesity and insulin, 17 (1980) 105
Opioid peptides, 17 (1980) 1
Organophosphorus pesticides, pharmacology of, 8 (1971) 1
Oxopyranoazines and oxopyranoazoles, 9 (1973) 117
- Parasitic infections, 13 (1976) 159
Parasympathomimetics, 11 (1975) 1
Parkinsonism, pharmacotherapy of, 9 (1973) 191; 21 (1984) 137
Patenting of drugs, 2 (1962) 1; 16 (1979) 1
Peptides, antibiotics, 5 (1967) 1
mast cell regulators, 27 (1990) 143
opioid, 17 (1980) 1
Pharmacology of vitamin E, 25 (1988) 249
Phospholipids, 19 (1982) 111
Photodecomposition of drugs, 27 (1990) 51
Platelet-aggregating factor, antagonists, 27 (1990) 325
Platinum antitumour agents, 24 (1987) 129
Polarography, 12 (1975) 247
Polycyclic hydrocarbons, 10 (1974) 159
Polyene antibiotics, 14 (1977) 105
Polypeptide antibiotics, 5 (1967) 1
Polypeptides, 4 (1965) 86
from snake venom, 21 (1984) 63
Prostacyclins, 21 (1984) 237
Prostaglandins, 8 (1971) 317; 15 (1978) 357

- Pseudomonas aeruginosa*, resistance of, 12 (1975) 333
- Psychotomimetics, 11 (1975) 91
- Psychotropic drugs, 5 (1967) 251
- Purines, 7 (1970) 69
- Pyridazines, pharmacological actions of, 27 (1990) 1
- Pyrimidines, 6 (1969) 67; 7 (1970) 285; 8 (1971) 61; 19 (1982) 269
- Quantum chemistry, 11 (1975) 67
- 4-Quinolones as antibacterial agents, 27 (1990) 235
- Radioligand-receptor binding, 23 (1986) 417
- Ranitidine and H₂-antagonists, 20 (1983) 337
- Rauwolfia alkaloids, 3 (1963) 146
- Recent drugs, 7 (1970) 1
- Receptors, adrenergic, 22 (1985) 121; 23 (1986) 1
histamine, 24 (1987) 29
- Ricin, 24 (1987) 1
- Screening tests, 1 (1961) 1
- Snake venoms, neuroactive, 21 (1984) 63
- Sodium cromoglycate analogues, 21 (1984) 1
- Sparsomycin, 23 (1986) 219
- Spectroscopy in biology, 12 (1975) 159; 12 (1975) 191; 26 (1989) 355
- Statistics in biological screening, 3 (1963) 187; 25 (1988) 291
- Tetrahydroisoquinolines, β -adrenomimetic activity, 18 (1981) 45
- Tetrahydronaphthalenes, β -adrenomimetic activity, 18 (1981) 45
- Tetrazoles, 17 (1980) 151
- Thalidomide as anti-inflammatory agent, 22 (1985) 165
- Thiosemicarbazones, 15 (1978) 321
- Thromboxanes, 15 (1978) 357
- Tilorone and related compounds, 18 (1981) 135
- Toxic actions, mechanisms of, 4 (1965) 18
- Tranquillizers, 1 (1961) 72
- 1,2,3-Triazines, medicinal chemistry of, 13 (1976) 205
- Trypanosomiasis, 3 (1963) 52
- Venoms, neuroactive, snake, 21 (1984) 63
- Virus diseases of plants, 20 (1983) 119
- Viruses, chemotherapy of, 8 (1971) 119; 23 (1986) 187
- Vitamin E, pharmacology of, 25 (1988) 249