

**ACI 117M-10**

**(metric)**

**Specification for Tolerances for  
Concrete Construction and Materials  
(ACI 117M-10) and Commentary**

An ACI Standard

Reported by ACI Committee 117



**American Concrete Institute®**



First printing  
July 2010

American Concrete Institute®  
*Advancing concrete knowledge*

## Specification for Tolerances for Concrete Construction and Materials and Commentary

Copyright by the American Concrete Institute, Farmington Hills, MI. All rights reserved. This material may not be reproduced or copied, in whole or part, in any printed, mechanical, electronic, film, or other distribution and storage media, without the written consent of ACI.

The technical committees responsible for ACI committee reports and standards strive to avoid ambiguities, omissions, and errors in these documents. In spite of these efforts, the users of ACI documents occasionally find information or requirements that may be subject to more than one interpretation or may be incomplete or incorrect. Users who have suggestions for the improvement of ACI documents are requested to contact ACI. Proper use of this document includes periodically checking for errata at [www.concrete.org/committees/errata.asp](http://www.concrete.org/committees/errata.asp) for the most up-to-date revisions.

ACI committee documents are intended for the use of individuals who are competent to evaluate the significance and limitations of its content and recommendations and who will accept responsibility for the application of the material it contains. Individuals who use this publication in any way assume all risk and accept total responsibility for the application and use of this information.

All information in this publication is provided "as is" without warranty of any kind, either express or implied, including but not limited to, the implied warranties of merchantability, fitness for a particular purpose or non-infringement.

ACI and its members disclaim liability for damages of any kind, including any special, indirect, incidental, or consequential damages, including without limitation, lost revenues or lost profits, which may result from the use of this publication.

It is the responsibility of the user of this document to establish health and safety practices appropriate to the specific circumstances involved with its use. ACI does not make any representations with regard to health and safety issues and the use of this document. The user must determine the applicability of all regulatory limitations before applying the document and must comply with all applicable laws and regulations, including but not limited to, United States Occupational Safety and Health Administration (OSHA) health and safety standards.

**Order information:** ACI documents are available in print, by download, on CD-ROM, through electronic subscription, or reprint and may be obtained by contacting ACI.

Most ACI standards and committee reports are gathered together in the annually revised *ACI Manual of Concrete Practice* (MCP).

**American Concrete Institute**  
**38800 Country Club Drive**  
**Farmington Hills, MI 48331**  
**U.S.A.**

**Phone: 248-848-3700**  
**Fax: 248-848-3701**

[www.concrete.org](http://www.concrete.org)

ISBN 978-0-87031-385-1

# Specification for Tolerances for Concrete Construction and Materials (ACI 117M-10) and Commentary

An ACI Standard

Reported by ACI Committee 117

Eldon G. Tipping  
Chair

Scott Michael Anderson  
Secretary

Scott M. Anderson  
Karl J. Bakke  
David K. Ballast  
Bryan M. Birdwell  
Gregory P. Birley  
Thomas J. Downs  
Ron Eldridge

Allen Face  
Robert A. Halvorson  
Mark G. Josten  
Richard L. Knox  
Jeff L. LaRue  
Michael W. Lee  
Michael L. Leming

Donald M. Marks  
Ross S. Martin  
Steven W. McCrary  
Arthur W. McKinney  
Colin T. Milberg  
William R. Nash  
Bob L. Payne

David N. Peterson  
William S. Phelan  
B. Duke Pointer  
Peter J. Ruttura  
Michael J. Schneider  
Bruce A. Suprenant  
Michael A. West

*Specification synopsis: This specification provides standard tolerances for concrete construction and materials. This document is intended to be used by specification writers and ACI committees writing standards as the reference document for establishing tolerances for concrete construction and materials.*

*Commentary synopsis: This report is a commentary on the "Specifications for Tolerances for Concrete Construction and Materials (ACI 117M)." It is intended to be used with ACI 117M for clarity of interpretation and insight into the intent of the committee regarding the application of the tolerances set forth therein.*

**Keywords:** architectural concrete; concrete; construction; drilled piers; formwork; foundation; mass concrete; pier; precast concrete; prestressed concrete; reinforced concrete; reinforcement; specification; splice; tilt-up concrete; tolerances.

ACI Committee Reports, Guides, Manuals, and Commentaries are intended for guidance in planning, designing, executing, and inspecting construction. This document is intended for the use of individuals who are competent to evaluate the significance and limitations of its content and recommendations and who will accept responsibility for the application of the material it contains. The American Concrete Institute disclaims any and all responsibility for the stated principles. The Institute shall not be liable for any loss or damage arising therefrom.

Reference to this document shall not be made in contract documents. If items found in this document are desired by the Architect/Engineer to be a part of the contract documents, they shall be restated in mandatory language for incorporation by the Architect/Engineer.

ACI 117M Specification and Commentary are presented in a side-by-side column format, with code text placed in the left column and the corresponding commentary text aligned in the right column. To distinguish the specification from the commentary, the specification has been printed in Helvetica, which is the typeface for this paragraph.

The Commentary is printed in Times Roman, which is the typeface for this paragraph. Commentary section numbers are preceded by the letter "R" to distinguish them from specification section numbers. The commentary is not a part of ACI Specification 117M-10.

ACI 117M-10 supersedes ACI 117-06 and was adopted March 1, 2010 and published July 2010.

Copyright © 2010, American Concrete Institute.

All rights reserved including rights of reproduction and use in any form or by any means, including the making of copies by any photo process, or by electronic or mechanical device, printed, written, or oral, or recording for sound or visual reproduction or for use in any knowledge or retrieval system or device, unless permission in writing is obtained from the copyright proprietors.

## CONTENTS

### Introduction, p. 117M-3

#### Section 1—General requirements, p. 117M-5

- 1.1—Scope
- 1.2—Requirements
- 1.3—Definitions
- 1.4—Referenced standards

#### Section 2—Materials, p. 117M-13

- 2.1—Reinforcing steel fabrication and assembly
- 2.2—Reinforcement location
- 2.3—Placement of embedded items, excluding dowels in slabs-on-ground
- 2.4—Concrete batching
- 2.5—Concrete properties

#### Section 3—Foundations, p. 117M-25

- 3.1—Deviation from plumb
- 3.2—Deviation from location
- 3.3—Deviation from elevation
- 3.4—Deviation from plane
- 3.5—Deviation from cross-sectional dimensions of foundations

#### Section 4—Cast-in-place concrete for buildings, p. 117M-31

- 4.1—Deviation from plumb
- 4.2—Deviation from location
- 4.3—Not used
- 4.4—Deviation from elevation
- 4.5—Deviation from cross-sectional dimensions
- 4.6—Deviation from formed opening width or height
- 4.7—Deviation from relative elevations or widths for stairs
- 4.8—Deviation from slope or plane
- 4.9—Sawcut depth in slab-on-ground

#### Section 5—Cast-in-place concrete at interface with precast concrete (except tilt-up concrete), p. 117M-45

- 5.1—Deviation from elevation—cast-in-place concrete
- 5.2—Deviation from location—cast-in-place concrete
- 5.3—Deviation from dimension—cast-in-place concrete
- 5.4—Deviation from plane at bearing surface—cast-in-place concrete measured over length or width of bearing surface

#### Section 6—Masonry, p. 117M-51

This section has been removed.

#### Section 7—Cast-in-place, vertically slipformed building elements, p. 117M-53

- 7.1—Deviation from plumb for buildings and cores
- 7.2—Horizontal deviation
- 7.3—Cross-sectional dimensions
- 7.4—Openings through elements
- 7.5—Embedded plates
- 7.6—Deviation from plumb for slipformed and jump-formed silos

#### Section 8—Mass concrete, p. 117M-55

- 8.1—Deviation from plumb

- 8.2—Horizontal deviation
- 8.3—Vertical deviation
- 8.4—Cross-sectional dimension
- 8.5—Deviation from plane

#### Section 9—Canal lining, p. 117M-57

- 9.1—Horizontal deviation
- 9.2—Vertical deviation
- 9.3—Cross-sectional dimensions

#### Section 10—Monolithic water-conveying tunnels, siphons, conduits, and spillways, p. 117M-59

- 10.1—Horizontal deviation
- 10.2—Vertical deviation
- 10.3—Cross-sectional dimensions
- 10.4—Deviation from plane

#### Section 11—Cast-in-place bridges, p. 117M-61

- 11.1—Deviation from plumb
- 11.2—Horizontal deviation
- 11.3—Vertical deviation
- 11.4—Length, width, or depth of specified elements
- 11.5—Deviation from plane
- 11.6—Deck reinforcement cover
- 11.7—Bearing pads

#### Section 12—Exterior pavements and sidewalks, p. 117M-63

- 12.1—Horizontal deviation
- 12.2—Vertical deviation of surface

#### Section 13—Chimneys and cooling towers, p. 117M-65

- 13.1—Deviation from plumb
- 13.2—Outside shell diameter
- 13.3—Wall thickness

#### Section 14—Cast-in-place nonreinforced pipe, p. 117M-67

- 14.1—Wall thickness
- 14.2—Pipe diameter
- 14.3—Offsets
- 14.4—Surface indentations
- 14.5—Grade and alignment
- 14.6—Concrete slump

#### Section 15—Tilt-up concrete, p. 117M-69

- 15.1—Panel forming
- 15.2—Deviation from plumb
- 15.3—Deviation from elevation
- 15.4—Deviation from location
- 15.5—Deviation from slope or plane
- 15.6—Deviation from relative widths

#### Notes to Specifier, p. 117M-73

General notes

#### Foreword to checklists, p. 117M-75

#### Mandatory Requirements Checklist, p. 117M-75

#### Optional Requirements Checklist, p. 117M-76

# INTRODUCTION

## SPECIFICATION

## COMMENTARY

This commentary pertains to “Specifications for Tolerances for Concrete Construction and Materials (ACI 117M-10).” The purpose of the commentary is to provide an illustrative and narrative complement to the specification; it is not a part of the specification.

No structure is exactly level, plumb, straight, and true. Tolerances are a means to establish permissible variation in dimension and location, giving both the designer and the contractor limits within which the work is to be performed. They are the means by which the designer conveys to the contractor the performance expectations upon which the design is based or that the project requires. Such specified tolerances should reflect design assumptions and project needs, being neither overly restrictive nor lenient.

Necessity rather than desirability should be the basis of selecting tolerances.

As the title “Specifications for Tolerances for Concrete Construction and Materials (ACI 117M)” implies, the tolerances given are standard or usual tolerances that apply to various types and uses of concrete construction. They are based on normal needs and common construction techniques and practices. Specified tolerances at variance with the standard values can cause both increases and decreases in the cost of construction.

*Economic feasibility*—The specified degree of accuracy has a direct impact on the cost of production and the construction method. In general, the higher degree of construction accuracy required, the higher the construction cost, and the lower the degree of construction accuracy, the higher the cost of required repairs.

*Relationship of all components*—The required degree of accuracy of individual parts can be influenced by adjacent units and materials, joint and connection details, and the possibility of the accumulation of tolerances in critical dimensions.

*Construction techniques*—The feasibility of a tolerance depends on available craftsmanship, technology, materials, and project management.

*Compatibility*—Designers are cautioned to use finish and architectural details that are compatible with the type and anticipated method of construction. The finish and architectural details used should be compatible with achievable concrete tolerances.

**SPECIFICATION****COMMENTARY****Contract document references**

*ACI specification documents*—The following American Concrete Institute standards provide mandatory tolerance requirements for concrete construction and can be referenced in Contract Documents:

117M	Specification for Tolerances for Concrete Construction and Materials and Commentary
ITG-7M	Specification for Tolerances for Precast Concrete
301M	Specifications for Structural Concrete
303.1	Standard Specification for Cast-in-Place Architectural Concrete
336.1	Specification for the Construction of Drilled Piers
530.1/ASCE 6/	
TMS 602	Specification for Masonry Structures and Commentary

*ACI informative documents*—The documents of the following American Concrete Institute committees cover practice, procedures, and state-of-the-art guidance for the categories of construction as listed:

General building.....	ACI 302, 303, 304, 305, 311, 315, 336, 347
Special structures.....	ACI 207, 307, 313, 325, 332, 334, 358
Materials.....	211, 223
Other.....	228

# SECTION 1—GENERAL REQUIREMENTS

## SPECIFICATION

### 1.1—Scope

**1.1.1** This specification designates standard tolerances for concrete construction.

**1.1.2** The indicated tolerances govern unless otherwise specified.

Tolerances in this specification are for typical concrete construction and construction procedures and are applicable to exposed concrete and to architectural concrete. Materials that interface with or connect to concrete elements may have tolerance requirements that are not compatible with those contained in this document.

This specification does not apply to specialized structures, such as nuclear reactors and containment vessels, bins, prestressed circular structures, and single-family residential construction. It also does not apply to precast concrete or to shotcrete.

Tolerances for specialized concrete construction that is outside the scope of this specification shall be specified in Contract Documents.

**1.1.3** A series of preconstruction tolerance coordination meetings shall be scheduled and held prior to the commencement of the Work. The Contractor, subcontractors, material suppliers, and other key parties shall attend. All parties shall be given the opportunity to identify any tolerance questions and conflicts that are applicable to the work with materials, prefabricated elements, and Work assembled/installed in the field by the Contractor.

### 1.2—Requirements

**1.2.1** Concrete construction and materials shall comply with specified tolerances.

## COMMENTARY

### R1.1—Scope

**R1.1.2** Specification of more restrictive tolerances for specialized construction, such as architectural concrete, often results in an increase in material cost and time of construction.

**R1.1.3** Preconstruction tolerance coordination meetings provide an opportunity for key participants to identify and to resolve tolerance compatibility issues prior to construction.

### R1.2—Requirements

An example of a specific application that uses a multiple of tolerated items that together yield a tolerated result is the location of the face of a concrete wall. The wall has a tolerance on location (Section 4.2.1), measured at the foundation of the wall, and is allowed to deviate from the specified plane (Sections 4.1 and 4.8.2). The application of the location tolerance (Section 4.2.1) cannot be used to increase the plumb tolerance contained in Section 4.1. Similarly, the tolerance on member thickness (Section 4.5) shall not be allowed to increase the tolerance envelope resulting from the application of Sections 4.1, 4.2.1, and 4.8.2. If the base of the wall is incorrectly located by the maximum amount allowed by Section 4.2.1, then the plumb tolerance (Section 4.1) dictates that the face of the wall move back toward the correct location, and at a rate that does not exceed the provisions of Section 4.8.2. Refer to Fig. R1.2.3.

## SPECIFICATION

## COMMENTARY

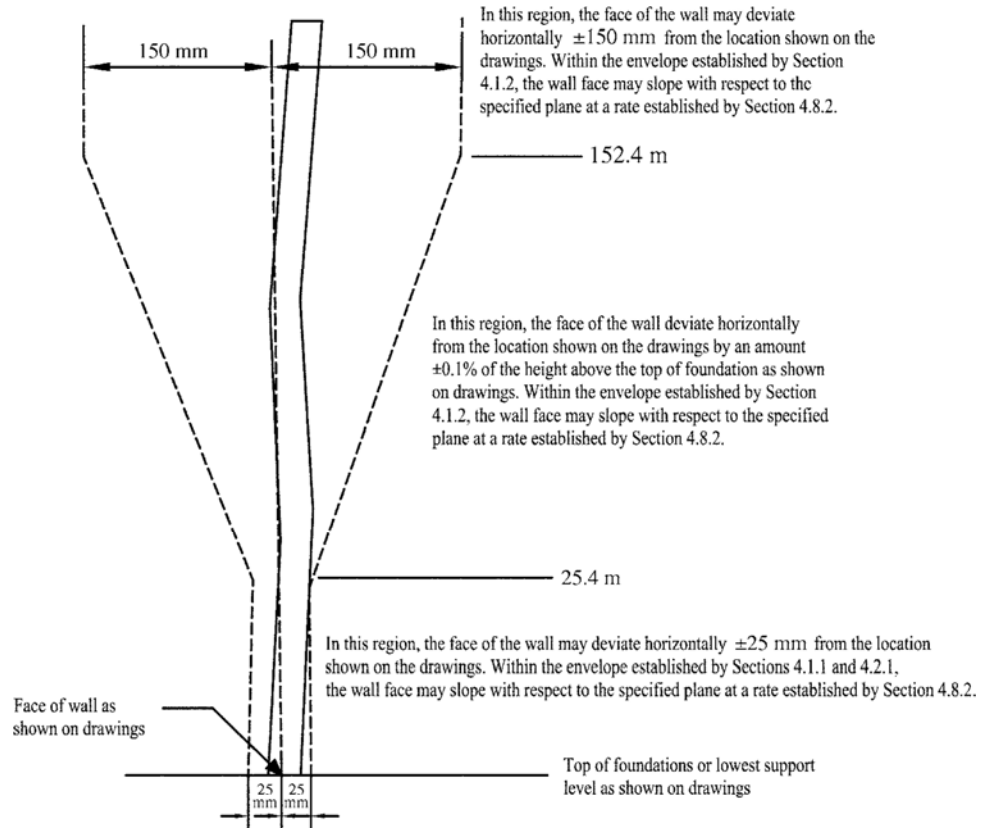

Fig. R1.2.3—Use of multiple of toleranced items to yield toleranced result.

**1.2.2** Tolerances shall not extend the structure beyond legal boundaries. Tolerances are measured from the points, lines, and surfaces defined in Contract Documents. If application of tolerances causes the extension of the structure beyond legal boundaries, the tolerance must be reduced.

**1.2.3** Tolerances are not cumulative. The most restrictive tolerance controls.

**1.2.4** Plus (+) tolerance increases the amount or dimension to which it applies, or raises a deviation from level. Minus (–) tolerance decreases the amount or dimension to which it applies, or lowers a deviation from level. Where only one signed tolerance is specified (+ or –), there is no specified tolerance in the opposing direction.

**R1.2.2** If the application of tolerances causes the extension of the structure beyond legal boundaries, the Architect/Engineer should be notified to initiate conflict resolution.

**R1.2.3** Accumulations of individual tolerances on a single item should not be used to increase an established tolerance. Individual tolerances are unique to their specific application and should not be combined with other tolerances to form a tolerance envelope. The separately specified tolerances must remain separate and not cumulative.

Each tolerance stands alone when evaluating the acceptability of concrete construction. Refer to Fig. R1.2.3.



## SPECIFICATION

**1.2.5** If the tolerances in this document are exceeded for structural concrete, refer to Contact Documents for acceptance criteria. For other concrete, the Architect/Engineer may accept the element if it meets one of the following criteria:

- a) Exceeding the tolerances does not affect the structural integrity, legal boundaries, or architectural requirements of the element; or
- b) The element or total erected assembly can be modified to meet all structural and architectural requirements.

### 1.3—Definitions

ACI provides a comprehensive list of definitions through an online resource, "ACI Concrete Terminology," <http://terminology.concrete.org>. Definitions provided here complement that resource.

**Architect/Engineer**—the architect, engineer, architectural firm, or engineering firm issuing Contract Documents or administering the Work under Contract Documents, or both.

**arris**—the sharp external corner edge that is formed at the junction of two planes or surfaces.

**bowing**—deviation of the edge or surface of a planar element from a line passing through any two corners of the element.

**bundled bar equivalent area**—total area of reinforcing bars contained in the bundle.

**concrete, exposed**—concrete surfaces formed so as to yield an acceptable texture and finish for permanent exposure to view.

**Contract Documents**—a set of documents supplied by the Owner to the Contractor that serve as the basis for construction; these documents contain contract forms, contract conditions, specifications, drawings, addenda, and contract changes.

**Contractor**—the person, firm, or entity under contract for construction of the Work.

## COMMENTARY

**R1.2.5** For acceptance criteria for structural concrete, refer to ACI 301M, Section 1.7.

### R1.3—Definitions

**arris**—refer to Fig. R1.3.1.

**bowing**—refer to Fig. R1.3.2.

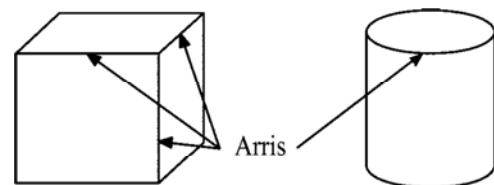

Fig. R1.3.1—Arris.

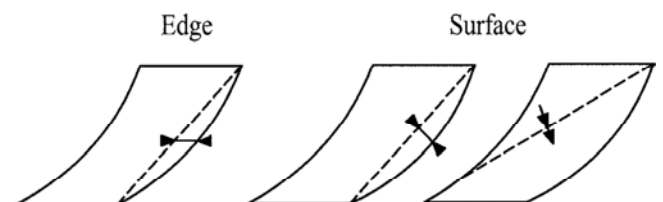

Fig. R1.3.2—Bowing.

## SPECIFICATION

**cover**—the least distance between the surface of embedded reinforcement and the surface of the concrete.

**deviation**—departure from an established point, line, or surface; measured normal (perpendicular) to the reference line or surface.

**deviation from plane**—the distance between a point on a reference plane and the corresponding point on the actual plane.

## COMMENTARY

**cover**—refer to Fig. R1.3.3.

**deviation**—refer to Fig. R1.3.4.

**deviation from plane**—refer to Fig. R1.3.5(a) and (b).

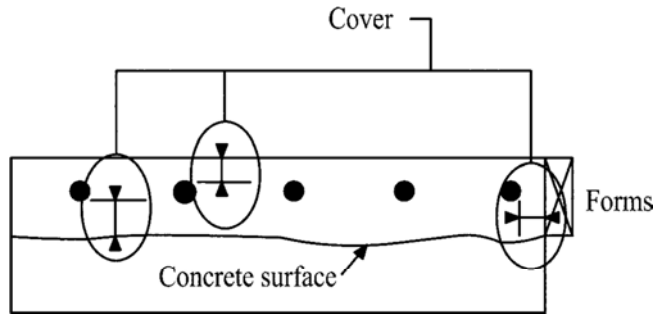

Fig. R1.3.3—Cover.

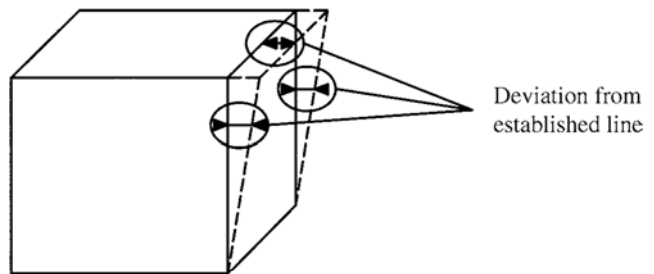
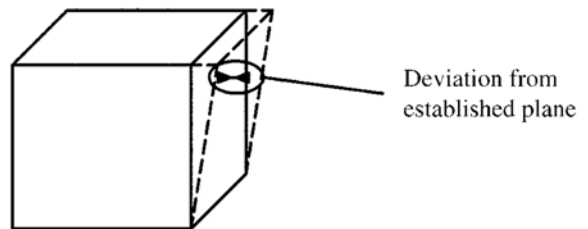
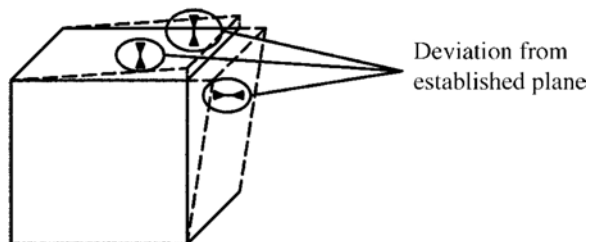

Fig. R1.3.4—Deviation.



(a)



(b)

Fig. R1.3.5—Deviation from plane.

**SPECIFICATION**

**deviation, horizontal**—departure from an established point, line, or surface, measured normal (perpendicular) to a vertical line through the point of interest.

**deviation, vertical**—departure from an established point, line, or surface, measured normal (perpendicular) to a horizontal line through the point of interest.

**COMMENTARY**

**deviation, horizontal**—refer to Fig. R1.3.6(a), (b), and (c).

**deviation, vertical**—refer to Fig. R1.3.7(a) and (b).

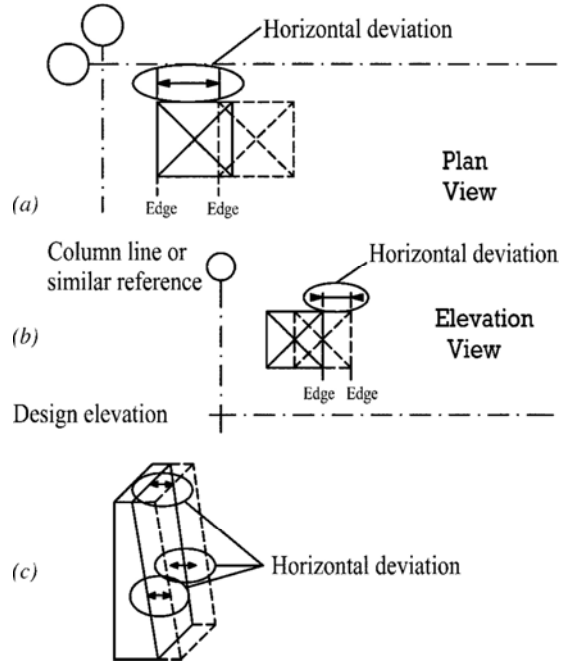

Fig. R1.3.6—Horizontal deviation.

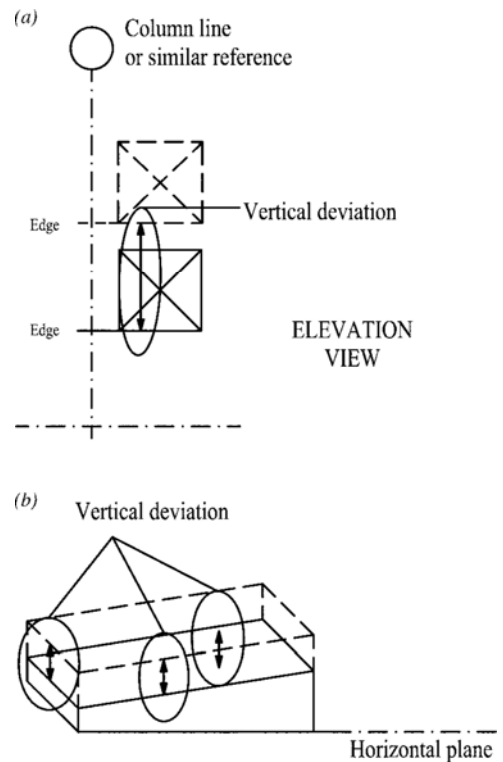

Fig. R1.3.7—Vertical deviation

## SPECIFICATION

**flatness**—deviation of a surface from a plane.

**footing**—a structural element of a foundation that transmits loads directly to the soil.

**foundation**—a system of structural elements that transmit loads from the structure above to the earth.

**levelness**—deviation of a line or surface from a horizontal line or surface.

**Project Drawings**—graphic presentation of project requirements.

**Project Specification**—the written document that details requirements for the Work in accordance with service parameters and other specific criteria.

**tolerance**—the permitted deviation from a specified dimension, location, or quantity.

**Work**—the entire construction or separately identifiable parts thereof required to be furnished under Contract Documents.

## COMMENTARY

Vertical deviation, horizontal deviation, and deviation from plumb are individually used to establish a tolerance envelope for each deviation type within which permissible variations can occur. Deviation from plane is used to determine the rate of change of adjacent points (slope tolerance) occurring within the tolerance envelope. In this fashion, the slope and smoothness of surfaces and lines within a tolerance envelope are controlled. Abrupt changes such as offsets, saw-toothing, and sloping of lines and surfaces properly located within a tolerance envelope may be objectionable for exposed concrete. The acceptable relative alignment of points on a surface or line is determined by using a slope tolerance. Effective use of a slope tolerance requires that the specific distance over which the slope is to be measured is established, and that the measurement device only contacts the surface at this specific distance.

**flatness**—refer to Fig. R1.3.8.

**levelness**—refer to Fig. R1.3.8.

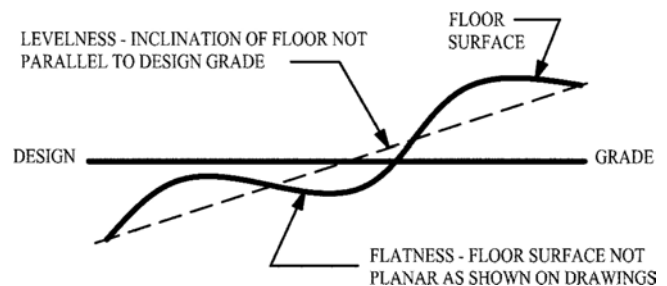

Fig. R1.3.8—Flatness and levelness.

**SPECIFICATION****1.4—Reference standards***ASTM International*

C94/C94M-09	Standard Specification for Ready-Mixed Concrete
C174/C174M-06	Standard Test Method for Measuring Thickness of Concrete Elements Using Drilled Concrete Cores
C1383-04	Standard Test Method for Measuring the P-Wave Speed and the Thickness of Concrete Plates Using the Impact-Echo Method
D4748-06	Standard Test Method for Determining Thickness of Bound Pavement Layers Using Short-Pulse Radar
E1155M-96(2008)	Standard Test Method for Determining $F_F$ Floor Flatness and $F_L$ Floor Levelness Numbers
E1486M-98(2004)	Standard Test Method for Determining Floor Tolerances Using Waviness, Wheel Path and Levelness Criteria

**COMMENTARY****R1.4—Informative references**

The documents listed below were the latest editions at the time this document was prepared. Because these documents are revised frequently, the reader is advised to contact the proper sponsoring group if it is desired to refer to the latest version.

*American Concrete Institute*

301M	Specifications for Structural Concrete
304.6R	Guide for the Use of Volumetric-Measuring and Continuous Mixing Concrete Equipment
318M	Building Code Requirements for Structural Concrete and Commentary

*American Institute of Steel Construction*

Design Guide 1: Base Plates and Anchor Rod Design

*American Society of Concrete Contractors*

Position Statement #14—Anchor Bolt Tolerances

*ASTM International*

C685/C685M	Standard Specification for Concrete Made by Volumetric Batching and Continuous Mixing
------------	---

*Concrete Reinforcing Steel Institute*

10MSP	Manual of Standard Practice
-------	-----------------------------

*Precast/Prestressed Concrete Institute*

MNL-116	Manual for Quality Control for Plants and Production of Structural Precast Concrete Products
MNL-135	Tolerance Manual for Precast and Prestressed Concrete Construction

*National Ready Mixed Concrete Association*

Quality Control Manual—Section 3; Certification of Ready Mixed Concrete Production Facilities (Checklist)

*Volumetric Mixer Manufacturers Bureau*

VMMB 100	Volumetric Mixer Standards of the Volumetric Mixer Manufacturers Bureau
----------	---

These publications may be obtained from:

American Concrete Institute  
38800 Country Club Drive  
Farmington Hills, MI 48331  
[www.concrete.org](http://www.concrete.org)

American Institute of Steel Construction  
One East Wacker Dr., Suite 700  
Chicago, IL 60601  
[www.aisc.org](http://www.aisc.org)

**SPECIFICATION****COMMENTARY**

American Society of Concrete Contractors  
2025 Brentwood Blvd.  
St. Louis, MO 63144  
[www.asconline.org](http://www.asconline.org)

ASTM International  
100 Barr Harbor Dr.  
West Conshohocken, PA 19428  
[www.astm.org](http://www.astm.org)

Concrete Reinforcing Steel Institute  
933 North Plum Grove Rd.  
Schaumburg, IL 60173  
[www.crsi.org](http://www.crsi.org)

Precast/Prestressed Concrete Institute  
200 W. Adams St., #2100  
Chicago, IL 60606  
[www.pci.org](http://www.pci.org)

National Ready Mixed Concrete Association  
900 Spring Street  
Silver Spring, MD 20910  
[www.nrmca.org](http://www.nrmca.org)

Volumetric Mixer Manufacturers Bureau  
900 Spring Street  
Silver Spring, MD 20910  
[www.vmmmb.org](http://www.vmmmb.org)

# SECTION 2—MATERIALS

## SPECIFICATION

### 2.1—Reinforcing steel fabrication and assembly

For bars No. 10 through 36 in size, refer to Fig. 2.1(a).

For bars No. 43 and 57 in size, refer to Fig. 2.1(b).

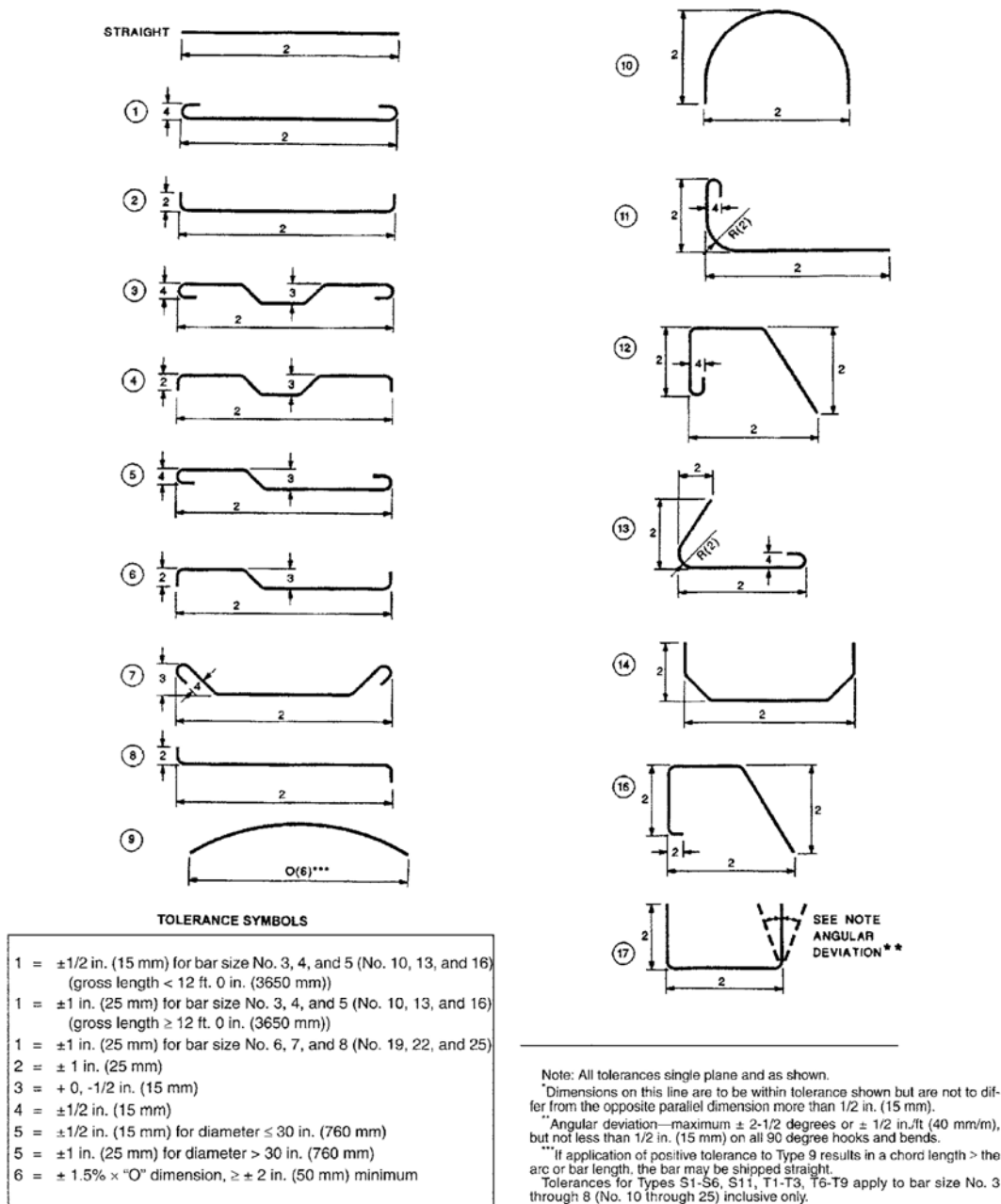
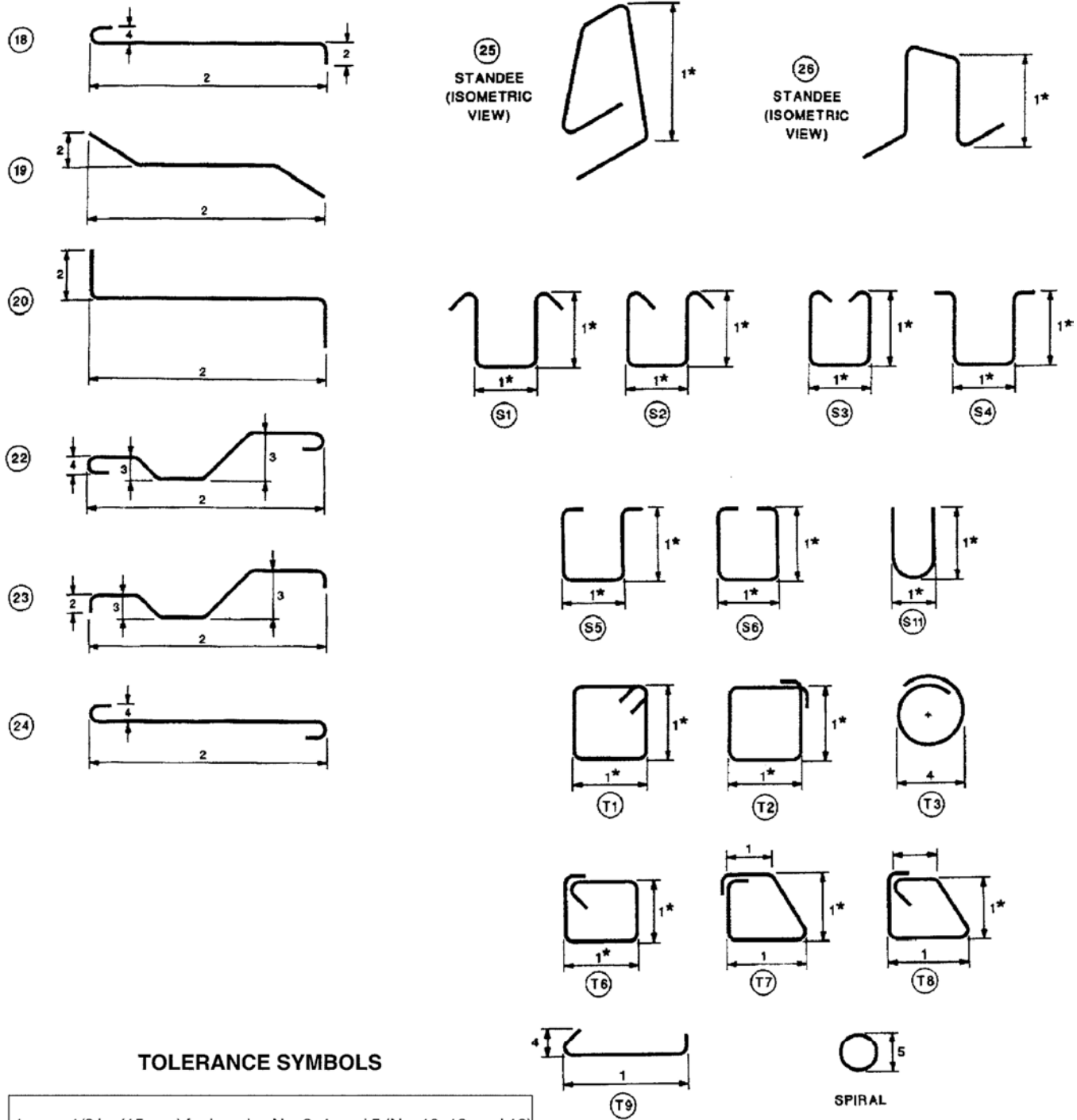

Fig. 2.1(a)—Standard fabricating tolerances for bar sizes No. 10 through 36. (Figure courtesy of Concrete Reinforcing Steel Institute.)

**SPECIFICATION**



**TOLERANCE SYMBOLS**

- 1 = ±1/2 in. (15 mm) for bar size No. 3, 4, and 5 (No. 10, 13, and 16) (gross length < 12 ft. 0 in. (3650 mm))
- 1 = ±1 in. (25 mm) for bar size No. 3, 4, and 5 (No. 10, 13, and 16) (gross length ≥ 12 ft. 0 in. (3650 mm))
- 1 = ±1 in. (25 mm) for bar size No. 6, 7, and 8 (No. 19, 22, and 25)
- 2 = ± 1 in. (25 mm)
- 3 = + 0, -1/2 in. (15 mm)
- 4 = ±1/2 in. (15 mm)
- 5 = ±1/2 in. (15 mm) for diameter ≤ 30 in. (760 mm)
- 5 = ±1 in. (25 mm) for diameter > 30 in. (760 mm)
- 6 = ± 1.5% × "O" dimension, ≥ ± 2 in. (50 mm) minimum

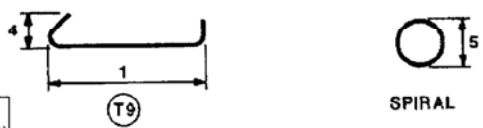

Note: All tolerances single plane and as shown.  
 \*Dimensions on this line are to be within tolerance shown but are not to differ from the opposite parallel dimension more than 1/2 in. (15 mm).  
 \*\*Angular deviation—maximum ± 2-1/2 degrees or ± 1/2 in./ft (40 mm/m), but not less than 1/2 in. (15 mm) on all 90 degree hooks and bends.  
 \*\*\*If application of positive tolerance to Type 9 results in a chord length ≥ the arc or bar length, the bar may be shipped straight.  
 Tolerances for Types S1-S6, S11, T1-T3, T6-T9 apply to bar size No. 3 through 8 (No. 10 through 25) inclusive only.

Fig. 2.1(a) (cont.)—Standard fabricating tolerances for bar sizes No. 10 through 36. (Figure courtesy of Concrete Reinforcing Steel Institute.)



**SPECIFICATION**

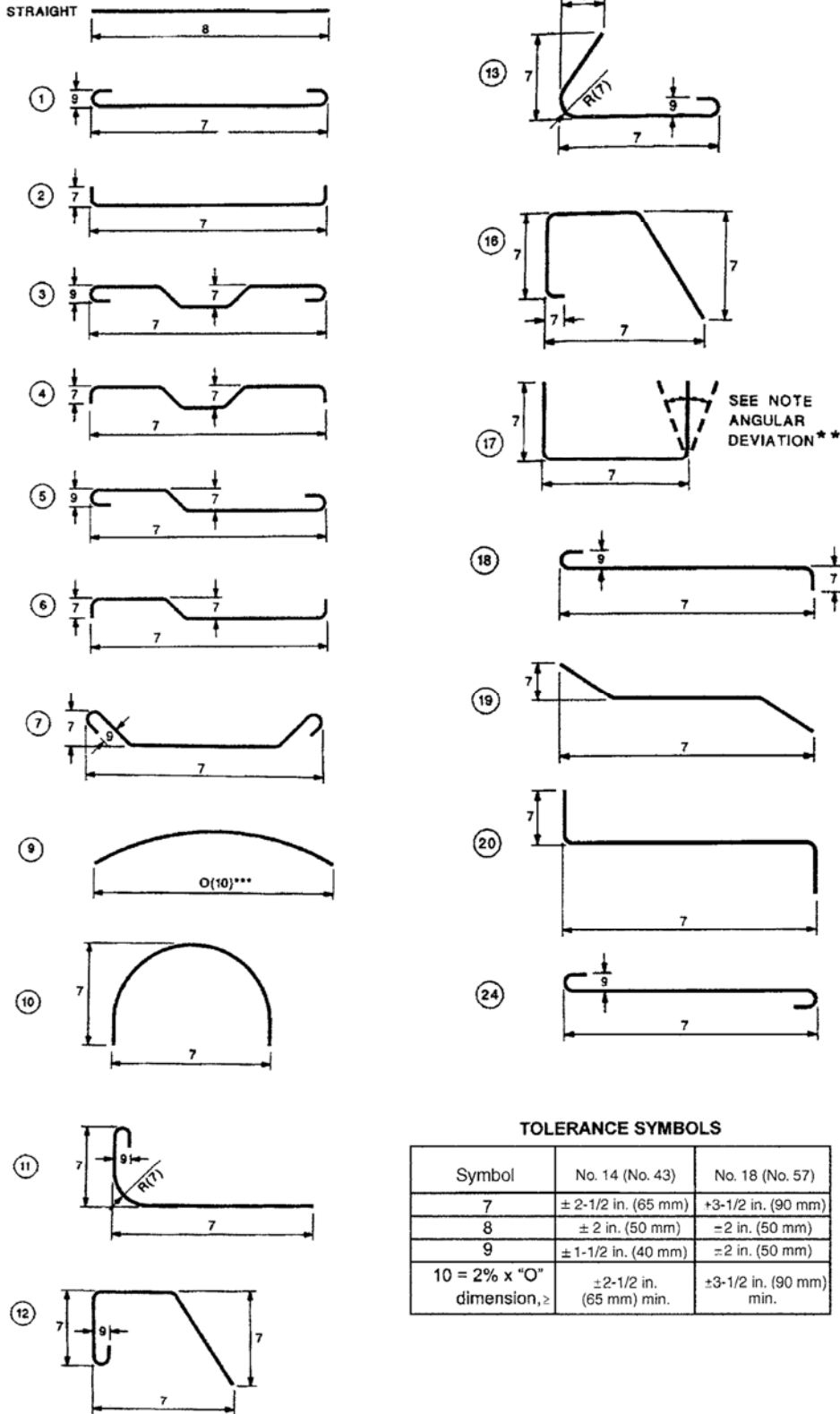

Note: All tolerances single plane as shown.

\*Saw-cut both ends—Overall length ± 1/2 in. (15 mm).

\*\*Angular deviation—Maximum ± 2 1/2 degrees or ± 1/2 in./ft (40 mm/m) on all 90 degree hooks and bends.

\*\*\*If application of positive tolerance to Type 9 results in a chord length ≥ the arc or bar length, the bar may be shipped straight.

Fig. 2.1(b)—Standard fabricating tolerances for bar sizes No. 43 and 57. (Figure courtesy of Concrete Reinforcing Steel Institute.)

**SPECIFICATION**

**COMMENTARY**

For bars No. 25 through 57 in size used in end-bearing splices, refer to Fig. 2.1(c).

For all end-bearing splice assemblies, refer to Fig. 2.1(d).

For all bar sizes, specified minimum inside radius of bend ..... -0 mm

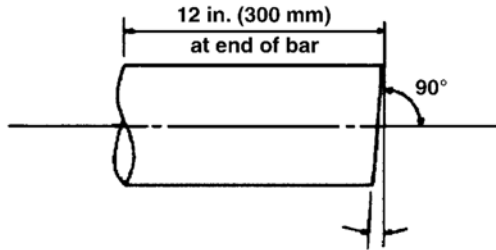

Maximum deviation from "square" to the end 12 in. [300 mm] of the bar (bar sizes #8 through #18 [#25 through #57]) should be 1-1/2° for compression connections.

Fig. 2.1(c)—Maximum end deviation for bars No. 25 through 57 in size used in end-bearing splices. (Figure courtesy of Concrete Reinforcing Steel Institute.)

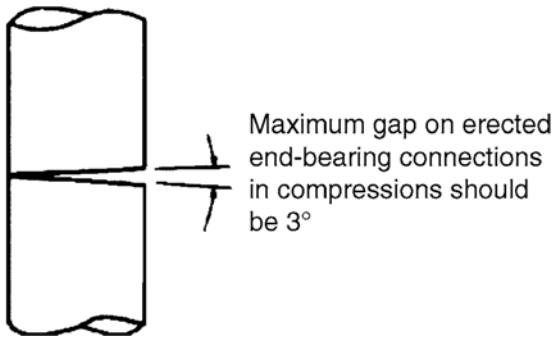

Fig. 2.1(d)—Maximum assembled gap for all bars used in end-bearing splices. (Figure courtesy of Concrete Reinforcing Steel Institute.)

**SPECIFICATION**

**2.2—Reinforcement location**

**2.2.1 Placement of nonprestressed reinforcement**

When member depth (or thickness) is 100 mm or less  
.....±6 mm

When member depth (or thickness) is over 100 mm  
and not over 300 mm.....±10 mm

When member depth (or thickness) is over 300 mm  
.....±13 mm

**2.2.2 Concrete cover measured perpendicular to concrete surface**

When member depth (or thickness) is 300 mm or less  
.....-10 mm

When member depth (or thickness) is over 300 mm  
.....-13 mm

Reduction in cover shall not exceed 1/3 the specified concrete cover.

Reduction in cover to formed soffits shall not exceed 6 mm.

**2.2.3 Vertical deviation for slab-on-ground reinforcement**

.....±20 mm

**COMMENTARY**

**R2.2—Reinforcement location**

The tolerance for *d*, as stated in ACI 318M, is for use in a strength calculation and should not be used as a placement tolerance for construction.

**R2.2.1, R2.2.2, and R2.2.3** Tolerances for fabrication, placement, and lap splices for welded wire reinforcement are not covered by ACI 117M and, if required, should be specified by the Specifier. Before placement of concrete, inspection of reinforcing bars for conformance to specified placement tolerances may involve measurements to formwork or soil. Refer to Fig. R2.2.1(a), (b), and (c). An absolute limitation on one side of the reinforcement placement is established by the limit on the reduction in cover. Refer to Fig. R2.2.2(a) to (d) and Fig. R2.2.3.

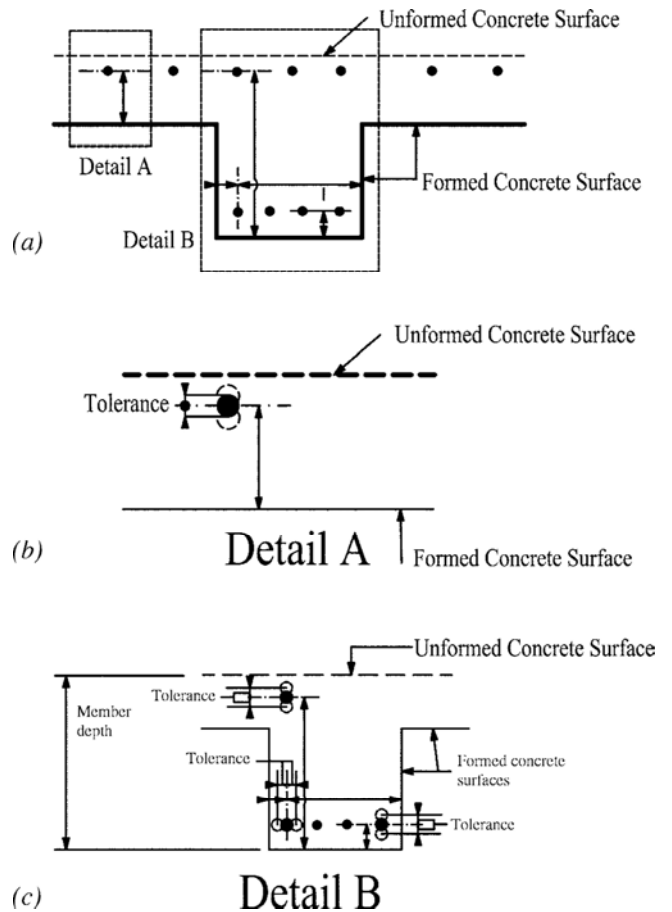

Fig. R2.2.1—Placement.

**SPECIFICATION**

**COMMENTARY**

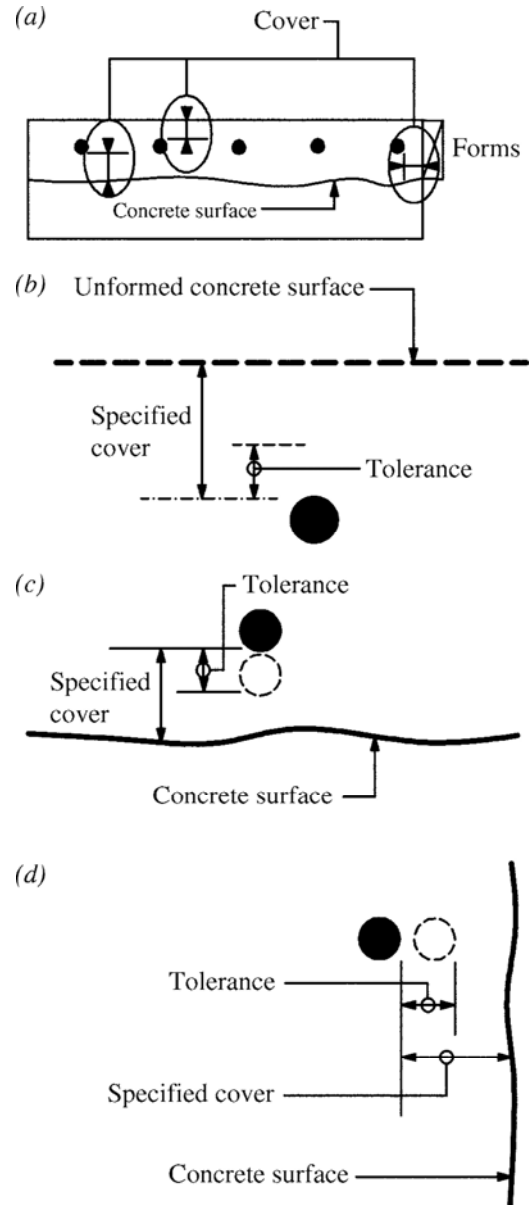

Fig. R2.2.2—Cover.

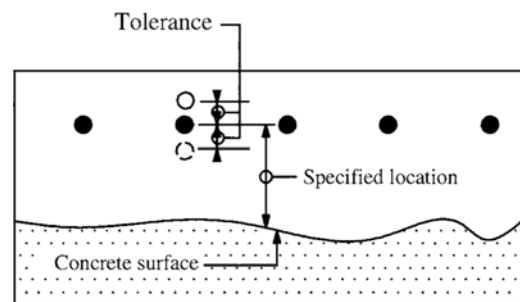

Fig. R2.2.3—Vertical placement.

**SPECIFICATION**

**2.2.4 Clearance between reinforcement or between reinforcement and embedment**

One-quarter specified distance not to exceed  
 .....±25 mm

Distance between reinforcement shall not be less than the greater of the bar diameter or 25 mm for unbundled bars.

For bundled bars, the distance between bundles shall not be less than the greater of 25 mm or a bar diameter derived from the equivalent total area of all bars in the bundle.

**2.2.5 Spacing of nonprestressed reinforcement, measured along a line parallel to the specified spacing**

Except as noted below.....±75 mm

Stirrups, the lesser of ±75 mm or ±25 mm per 300 mm of beam depth

Ties, the lesser of ±75 mm or ±25 mm per 300 mm of least column width

The total number of bars shall not be fewer than that specified.

**COMMENTARY**

**R2.2.4 and R2.2.5** The spacing tolerance of reinforcement consists of an envelope with an absolute limitation on one side of the envelope determined by the limit on the reduction in distance between reinforcement. In addition, the allowable tolerance on spacing should not cause a reduction in the specified number of reinforcing bars used. Designers are cautioned that selecting a beam width that exactly meets their design requirements may not allow for reinforcement placement tolerance. This sometimes happens when lap-spliced bars take up extra space and cannot accommodate the placement tolerance. Where reinforcement quantities and available space are in conflict with spacing requirements of these sections, the Contractor and designer might consider bundling a portion of the reinforcement. Bundling of bars requires approval of the designer. Refer to Fig. R2.2.4(a) to (e) and **R2.2.5**.

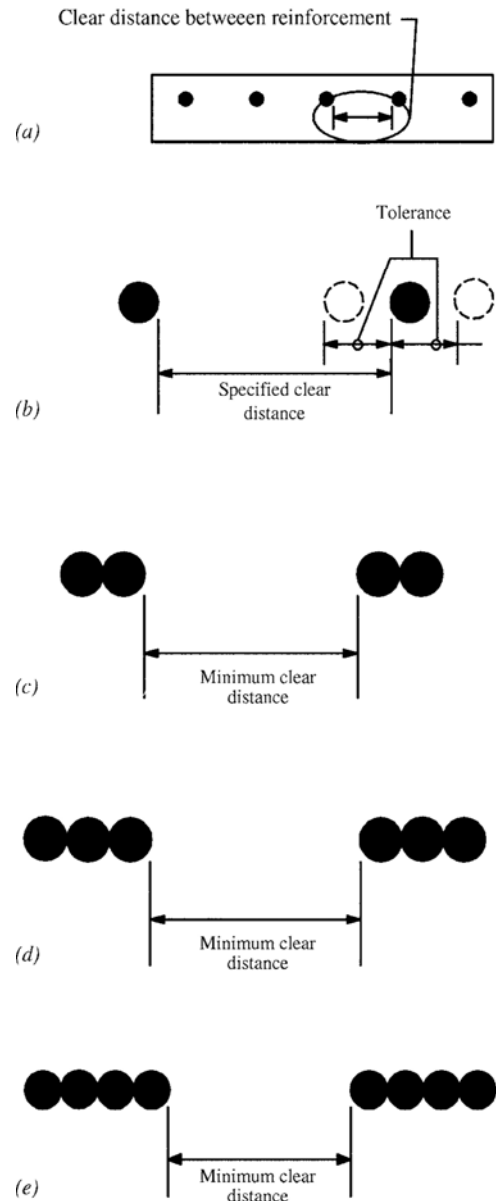

Fig. R2.2.4—Clear distance.

**SPECIFICATION**

**COMMENTARY**

**2.2.6 Placement of prestressing reinforcement or prestressing ducts, measured from form surface**

**2.2.6.1 Horizontal deviation**

Element depth (or thickness) 600 mm or less.....  $\pm 13$  mm

Element depth (or thickness) over 600 mm ..  $\pm 25$  mm

**2.2.6.2 Vertical deviation**

Element depth (or thickness) 200 mm or less ...  $\pm 6$  mm

Element depth (or thickness) over 200 mm and not over 600 mm.....  $\pm 10$  mm

Element depth (or thickness) more than 600 mm .....  $\pm 13$  mm

**2.2.7 Longitudinal location of bends in bars and ends of bars**

At discontinuous ends of corbels and brackets ..  $\pm 13$  mm

At discontinuous ends of other elements .....  $\pm 25$  mm

At other locations.....  $\pm 50$  mm

**2.2.8 Embedded length of bars and length of bar laps**

No. 10 through 36 bar sizes .....  $-25$  mm

No. 43 and 57 bar sizes.....  $-50$  mm

Note: Total number of bars shall not be fewer than specified

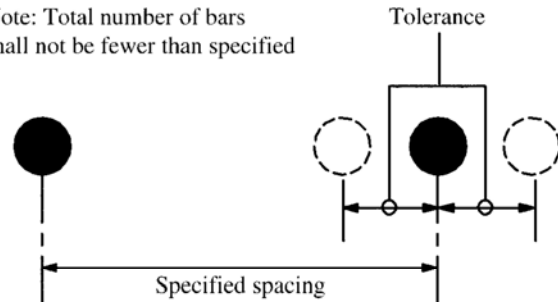

Fig. R2.2.5—Reinforcement spacing.

**R.2.2.6** The vertical deviation tolerance should be considered in establishing minimum prestressing tendon covers, particularly in applications exposed to deicer chemicals or salt-water environments where use of additional cover is recommended to compensate for placing tolerances. Slab behavior is relatively insensitive to horizontal location of tendons. Refer to Fig. R2.2.6(a) and (b).

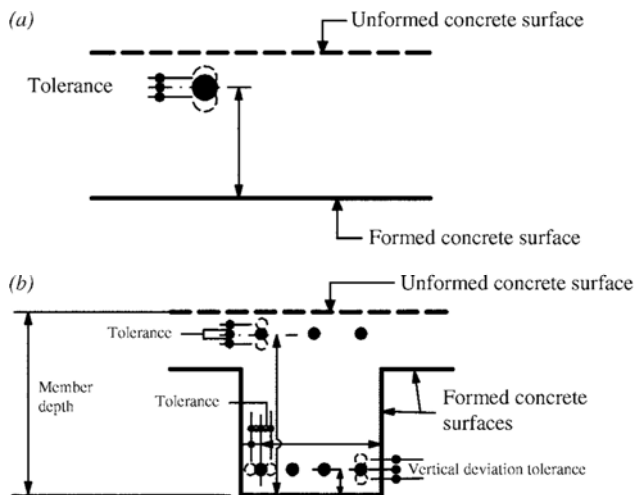

Fig. R2.2.6—Prestressing reinforcement placement.

**R2.2.7 and R2.2.8** The tolerance for the location of the ends of reinforcing steel is determined by these two sections.

**SPECIFICATION**

**2.2.9** Bearing plate for prestressing tendons, deviation from specified plane  
 .....  $\pm 20$  mm per m, but not less than  $\pm 3$  mm

**2.2.10** Placement of smooth rod or plate dowels in slabs-on-ground

**2.2.10.1** Centerline of dowel, vertical deviation measured from bottom of concrete slab at the joint for element depth 200 mm or less .....  $\pm 13$  mm

When element depth is over 200 mm .....  $\pm 25$  mm

**2.2.10.2** Spacing of dowels, measured along a line parallel to the specified spacing .....  $\pm 75$  mm

The total number of dowels shall not be fewer than that specified.

**2.2.10.3** Centerline of dowel with respect to a horizontal line that is perpendicular to the plane established by the joint

Horizontal deviation .....  $\pm 13$  mm

Vertical deviation .....  $\pm 13$  mm

**COMMENTARY**

**R2.2.9** The tolerance for conformance of prestressing tendon bearing plates to the specified plane is established by this section. Refer to Fig. R2.2.9.

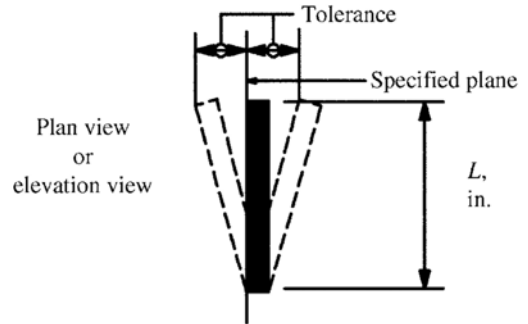

Fig. R2.2.9—Bearing plate for prestressing tendons.

**R2.2.10** The tolerance for placement of dowels is determined by this section. Refer to Fig. R2.2.10.1, R2.2.10.2, and R2.2.10.3.

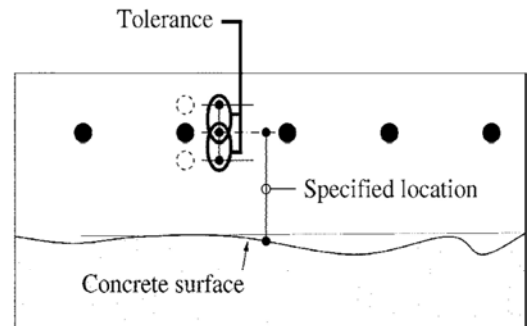

Fig. R2.2.10.1—Dowel placement.

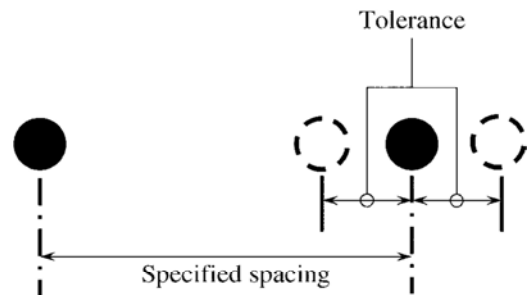

Fig. R2.2.10.2—Dowel spacing.

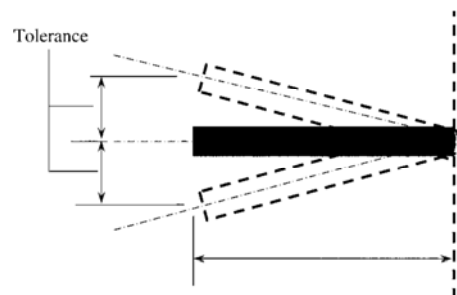

Fig. R2.2.10.3—Dowel deviation from line.

**SPECIFICATION**

**2.3—Placement of embedded items, excluding dowels in slabs-on-ground**

**2.3.1** Clearance to nearest reinforcement shall be the greater of the bar diameter, largest aggregate size, or ..... 25 mm

**2.3.2** *Centerline of assembly from specified location*

Horizontal deviation ..... ±25 mm

Vertical deviation ..... ±25 mm

**2.3.3** *Surface of assembly from surface of element*

Assembly dimension 300 mm or smaller ..... ±40 mm per m but not less than ..... ±6 mm

Assembly dimension greater than 300 mm ..... ±13 mm

**2.3.4** *Anchor bolts in concrete*

**2.3.4.1** *Top of anchor bolt from specified elevation*

Vertical deviation ..... ±13 mm

**2.3.4.2** *Centerline of individual anchor bolts from specified location*

Horizontal deviation  
 for M20 and M22 bolts ..... ±6 mm  
 for M24, M27, M30, M33, and M36 bolts ..... ±10 mm  
 for larger than M36 bolts ..... ±13 mm

**COMMENTARY**

**R2.3—Placement of embedded items, excluding dowels in slabs-on-ground**

**R2.3.1** The minimum clearance between reinforcement and embedded items is determined by this section. Refer to Fig. R2.3.1(a) and (b).

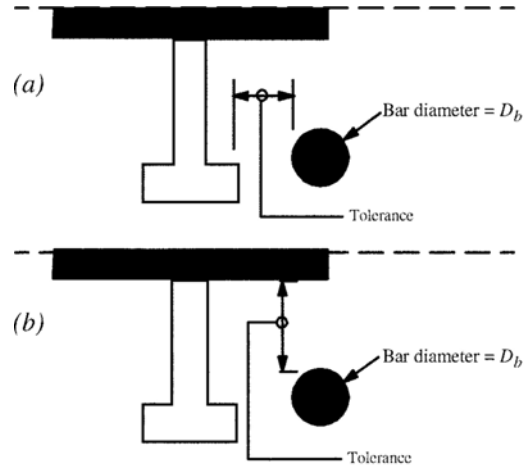

Fig. R2.3.1—Clear distance.

**R2.3.3** The tolerance for the elevation of the top of anchor bolts is consistent with that contained in the American Institute of Steel Construction’s Code of Standard Practice (10MSP). The tolerance for the location of anchor bolts is based on using oversized holes per the *AISC Design Guide 1: Base Plates and Anchor Rod Design*, recommendations of the Structural Steel Educational Council, and concrete contractor anchor bolt placement techniques. Refer to the American Society of Concrete Contractor’s *Position Statement #14*.



**SPECIFICATION**

**COMMENTARY**

**2.4—Concrete batching**

**R2.4—Concrete batching**

Refer to Table 2.4.

Refer to ASTM C94/C94M and ACI 304.6R for additional information regarding concrete batching. ASTM C685/C685M provides information for concrete made with materials continuously batched by volume. The Volumetric Mixer Manufacturers Bureau (VMMB 100) provides standardized information concerning volumetric mixers.

**Table 2.4—Concrete batching tolerances (ASTM C94/C94M)**

Material	Tolerance
<i>Cementitious materials</i>	
30% of scale capacity or greater	±1% of required mass
Less than 30% of scale capacity	-0 to +4% of the required mass
<i>Water</i>	
Added water or ice, and free water on aggregates	±1% of the total water content (including added water, ice, and water on aggregates)
Total water content (measured by weight or volume)	±3% of total water content
<i>Aggregates</i>	
Cumulative batching:	
Over 30% of scale capacity	±1% of the required mass
30% of scale capacity or less	±0.3% of scale capacity or 3% of the required mass, whichever is less
Individual material batching	±2% of the required mass
<i>Admixtures</i>	±3% of the required amount or plus or minus the amount of dosage required for 50 kg of cement, whichever is greater

**2.5—Concrete properties**

**R2.5—Concrete properties**

**2.5.1 Slump**

**R2.5.1** Where the specification has specified slump as a maximum, the Project Specifications should provide for one addition of water at the job site for slump adjustment, per ASTM C94/C94M, Section 6. Concrete slump should include a tolerance that allows for both plus or minus deviations so that concrete slumps are not underdesigned to avoid rejection. The water added at the job site should be within the water-cementitious material ratio (*w/cm*) limitations of the specifications or approved mixture proportions.

Where slump is specified as "maximum" or "not to exceed"

For all values.....+0 mm

Specified slump 75 mm or less.....-40 mm

Specified slump more than 75 mm .....-65 mm

Where slump is specified as a single value

Specified slump 50 mm and less.....±13 mm

Specified slump more than 50 mm but not greater than 100 mm .....±25 mm

Specified slump more than 100 mm.....±40 mm

Where slump is specified as a range.....no tolerance

Flowing concrete achieved by the incorporation of high-range water-reducing admixtures (HRWRAs) (also called superplasticizers) are regularly used at specified slumps of 190 mm or greater. In addition, it is difficult to measure high slumps accurately. Consideration should be given to eliminating a maximum slump when a HRWRA is used to achieve flowing concrete. When HRWRAs are used, concrete slump should be specified for the concrete mixture prior to the addition of the HRWRA.

The slump specified should always be evaluated to determine if it is suitable for delivery, placing, and reinforcement clearance.

**SPECIFICATION**

**COMMENTARY**

**2.5.2** *Air content: where no range is specified, the air content tolerance is .....  $\pm 1\frac{1}{2}\%$*

**R2.5.2** When an air content range is specified, care should be given to address aggregate size and job-site requirements. The range should be adequately wide to accommodate the preceding.

## SECTION 3—FOUNDATIONS

### SPECIFICATION

#### 3.1—Deviation from plumb

**Note:** Excavation shall be measured before concrete placement.

**3.1.1 Category A**—For unreinforced concrete piers extending through materials offering no or minimal lateral restraint (for example, water, normally consolidated organic soils, and soils that might liquefy during an earthquake)— $\pm 12.5\%$  of shaft diameter.

**3.1.2 Category B**—For unreinforced concrete piers extending through materials offering lateral restraint (soils other than those indicated in Category A)— $\pm 1.5\%$  of shaft length.

**3.1.3 Category C**—For reinforced concrete piers— $\pm 2.0\%$  of shaft length.

### COMMENTARY

#### R3.1—Deviation from plumb

Refer to Fig. R3.1.1, R3.1.2, and R3.1.3.

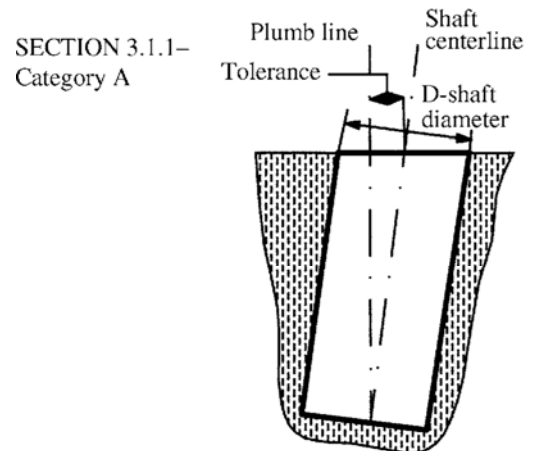

Fig. R3.1.1—Category A.

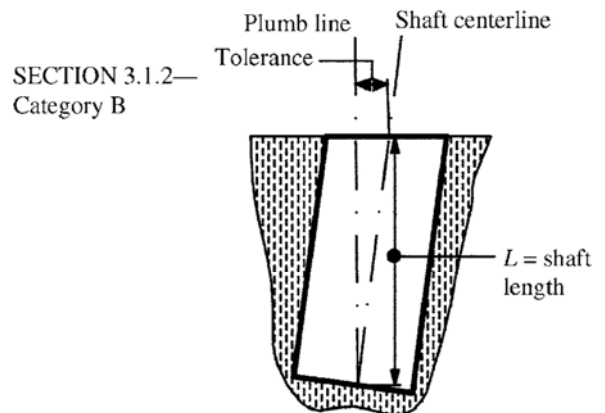

Fig. R3.1.2—Category B.

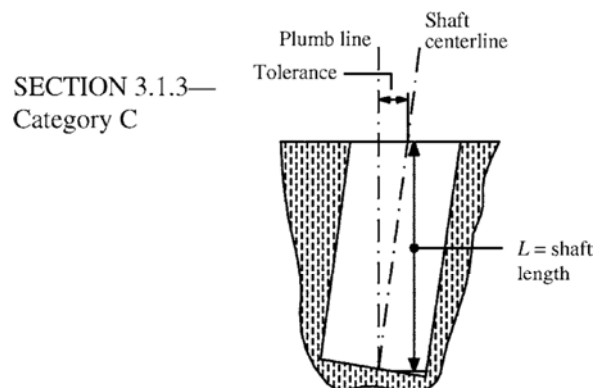

Fig. R3.1.3—Category C.

### SPECIFICATION

#### 3.2—Deviation from location

3.2.1 Foundations, unless noted otherwise in this section

Horizontal deviation of the as-cast edge:

Where dimension is 2.4 m or more ..... ±50 mm

Where dimension is less than 2.4 m

...the greater of ±2% of specified dimension or 13 mm

### COMMENTARY

#### R3.2—Deviation from location

R3.2.1 Determines the permissible location of foundations or piers. The allowable deviation for the location of foundations or piers is governed by the dimension of the foundations or piers with an absolute limit, depending on whether the foundations or piers support concrete or masonry. Refer to Fig. R3.2.1(a) and (b).

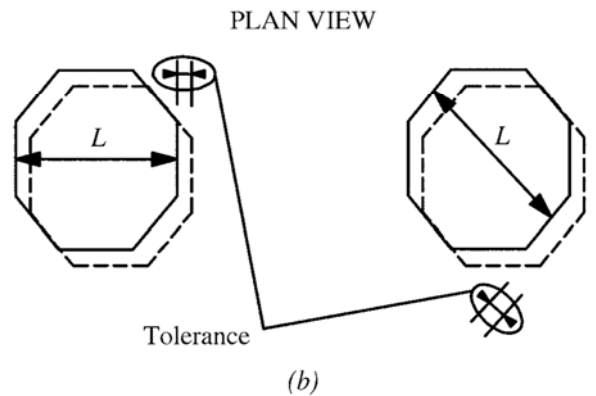
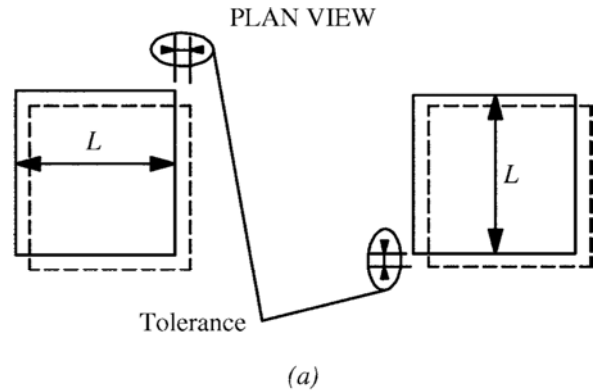

Fig. R3.2.1—Foundations, unless otherwise noted.

**SPECIFICATION**

**3.2.2 Foundations supporting masonry**

Horizontal deviation of the as-cast edge shall be the lesser of  $\pm 2\%$  of the foundation's width or  $\pm 13$  mm.

**COMMENTARY**

**R3.2.2 Foundations supporting masonry**

Refer to Fig. R3.2.2(a) and (b).

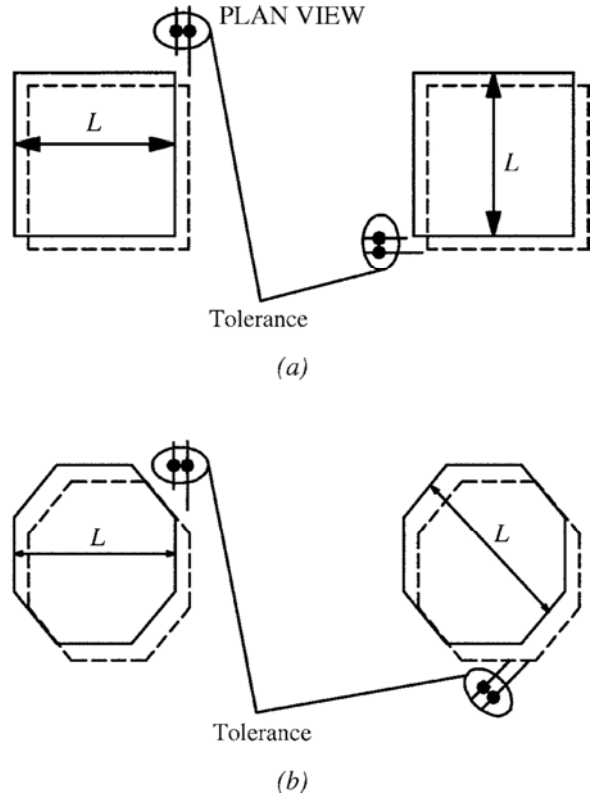

Fig. R3.2.2—Foundations supporting masonry.

**3.2.3 Top of drilled piers**

Horizontal deviation of the as-cast center shall be the lesser of 4.2% of the shaft diameter or  $\pm 75$  mm.

**R3.2.3 Top of drilled piers**

Refer to Fig. R3.2.3.

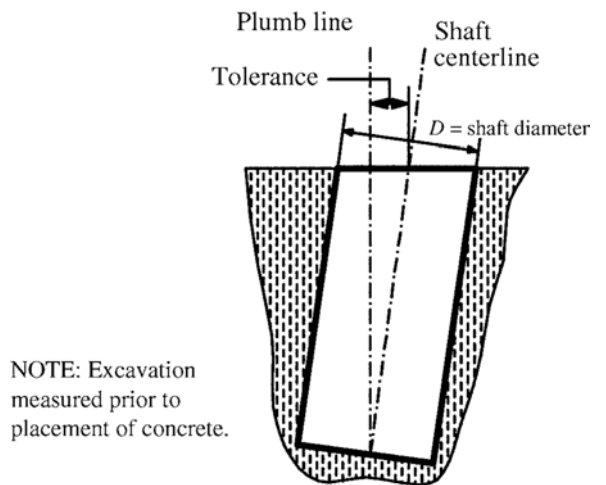

Fig. R3.2.3—Top of drilled piers: horizontal deviation.

**SPECIFICATION**

**3.3—Deviation from elevation**

**3.3.1 Top surface of foundations**

Vertical deviation ..... +13 mm  
 ..... -50 mm

**3.3.2 Top surface of drilled piers**

Vertical deviation ..... +25 mm  
 ..... -75 mm

**3.4—Deviation from plane**

**3.4.1 Base of bell pier**

The lesser of 10% of the bell diameter or  $\pm 75$  mm.

**3.4.2 Top surface of footings at interface with supported element**

Maximum gap between the concrete and the near surface of a 3 m straightedge, measured between the support points, shall not exceed +13 mm

**COMMENTARY**

**R3.3—Deviation from elevation**

Determines the location of any point on the top surface of a footing relative to the specified plane. Refer to Fig. R3.3.1 and R3.3.2.

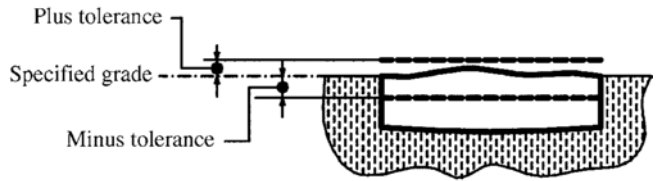

ELEVATION VIEW

*Fig. R3.3.1—Top surface of foundations: vertical deviation.*

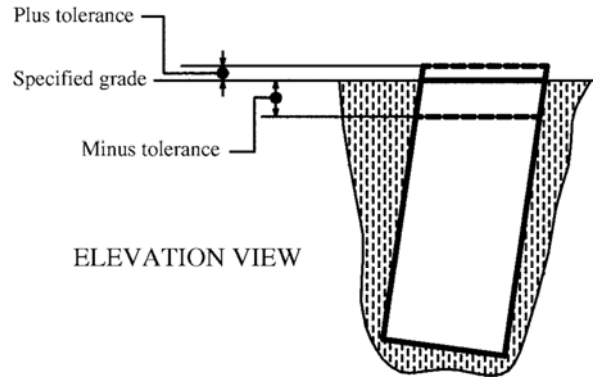

ELEVATION VIEW

*Fig. R3.3.2—Top surface of drilled piers: vertical deviation.*

**R3.4—Deviation from plane**

Determines the allowable slope of the base of a bell pier. Refer to Fig R3.4.1.

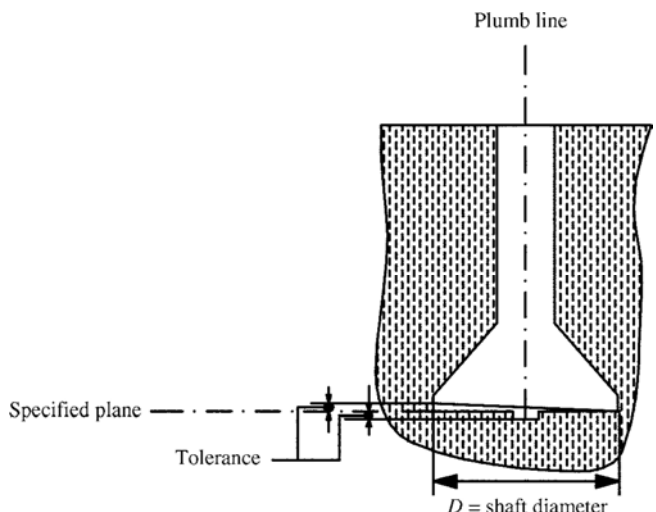

*Fig. R3.4.1—Base of bell pier.*

**SPECIFICATION**

**3.5—Deviation from cross-sectional dimensions of foundations**

**3.5.1 Formed foundations**

Horizontal deviation .....+50 mm  
 .....-13 mm

**3.5.2 Unformed foundations cast against soil**

Horizontal deviation from plan dimension. Excavation shall be measured before concrete placement. Tolerance shall apply at all locations.

Where dimension is 600 mm or less .....+75 mm  
 .....-13 mm

Where dimension is more than 600 mm .....+150 mm  
 .....-13 mm

**3.5.3 Deviation from foundation thickness ( $T$ ).....  $-0.05 T$**

**COMMENTARY**

**R3.5—Deviation from cross-sectional dimensions of foundations**

Determines the permissible size of a foundation. Refer to Fig. R3.5.1, R3.5.2, and R3.5.3.

**R3.5.2** Inspection for conformance to specified thickness tolerances may involve measurements prior to placement of concrete. Specified tolerances apply to the completed concrete element.

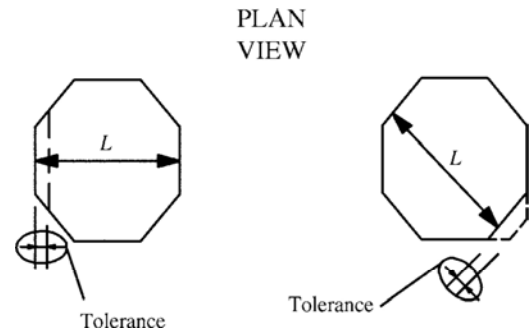

Fig. R3.5.1—Formed foundations: cross-sectional dimensions.

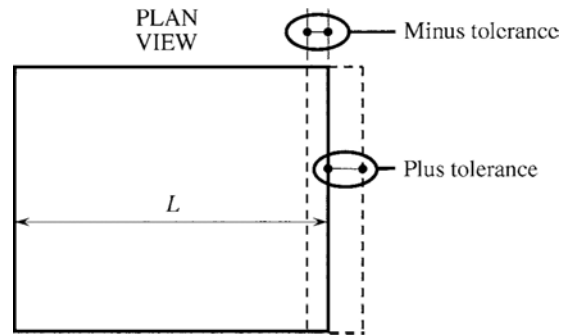

Fig. R3.5.2—Unformed foundations cast against soil.

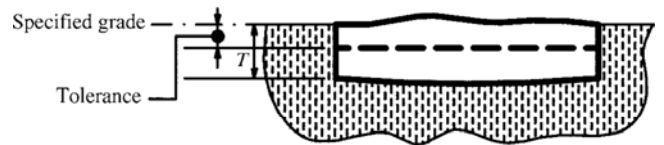

Fig. R3.5.3—Deviation from foundation thickness.

**Notes**



## SECTION 4—CAST-IN-PLACE CONCRETE FOR BUILDINGS

### SPECIFICATION

#### 4.1—Deviation from plumb

##### 4.1.1 For heights less than or equal to 25.4 m

For lines, surfaces, corners, and arrises: the lesser of 0.3% times the height above the top of foundations or lowest support level as shown on Project Drawings or  $\pm 25$  mm. This section shall not be used to evaluate local departure from a specified plane or form irregularities. Refer to [Section 4.8.2](#) and [4.8.3](#), respectively.

For the outside corner of an exposed corner column and grooves in exposed concrete: the lesser of 0.2% times the height above the top of foundations or lowest support level as shown on Project Drawings or  $\pm 13$  mm. This section shall not be used to evaluate local departure from a specified plane or form irregularities. Refer to [Section 4.8.2](#) and [4.8.3](#), respectively.

### COMMENTARY

#### R4.1—Deviation from plumb

**R4.1.1** The tolerance for plumb varies with the height above the top of foundation or the lowest support level of the structure. Between the top of foundation and a height of 25.4 m, the tolerance is 0.3% of the height until a maximum dimension of 25 mm is reached. Refer to Fig. R4.1.1(a) and (b). The tolerance for the outside corner of exposed corner columns and for contraction joint grooves in exposed concrete is more stringent.

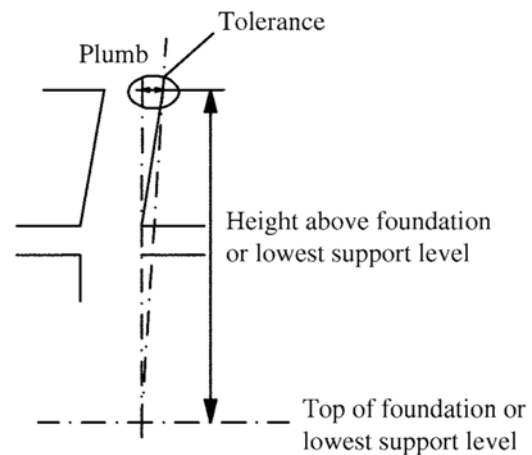

(a)

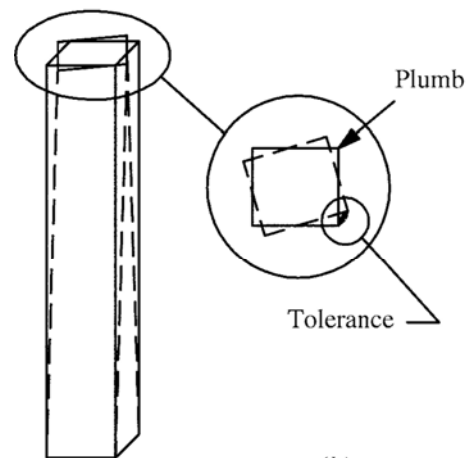

(b)

Fig. R4.1.1—Deviation from plumb.

## SPECIFICATION

### 4.1.2 For heights greater than 25.4 m

For lines, surfaces corners, arrises, and elements: the lesser of 0.1% times the height above the top of foundations or lowest support level as shown on Project Drawings or  $\pm 150$  mm This section shall not be used to evaluate local departure from a specified plane or form irregularities. Refer to Section 4.8.2 and 4.8.3, respectively.

For the outside corner of an exposed corner columns and contraction joint grooves in concrete exposed to view: the lesser of 0.05% times the height above the top of foundations or lowest support level as shown on Project Drawings or 75 mm This section shall not be used to evaluate local departure from a specified plane or form irregularities. Refer to Section 4.8.2 and 4.8.3, respectively.

## COMMENTARY

**R4.1.2** From 25.4 m to 152.4 m above the top of foundation, the tolerance for plumb is 1/1000 (0.1%) times the height. The maximum tolerance is 150 mm at heights more than 152.4 m above the top of foundation of the structure. The structure and exterior cladding should not extend beyond legal boundaries established by the Contract Documents. Refer to Fig. R4.1.2(a) and (b).

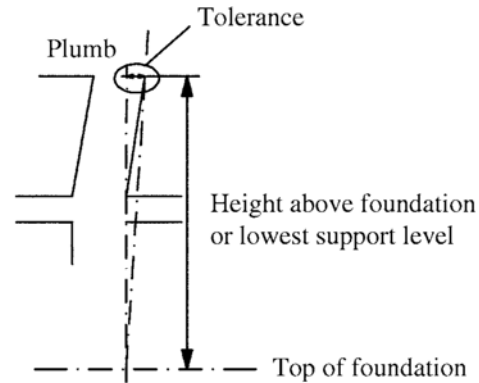

(a)

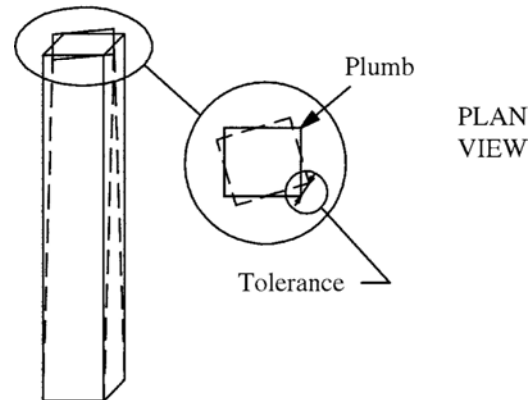

(b)

Fig. R4.1.2—Deviation from plumb.

**4.1.3** Vertical edges of openings larger than 300 mm, measured over the full height of the opening.....  $\pm 13$  mm

**R4.1.3** The plumb tolerance for edges of openings larger than 300 mm is established by this section. Refer to Fig. R4.1.3.

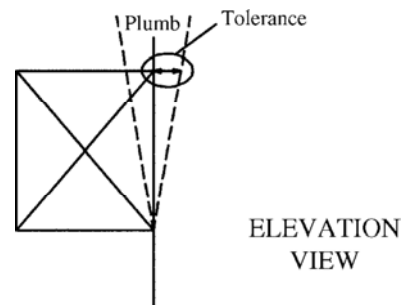

Fig. R4.1.3—Deviation from plumb.

**SPECIFICATION**

**4.2—Deviation from location**

**4.2.1 Horizontal deviation**

Vertical elements, measured at the top of element foundation or lowest support level .....±25 mm

Other elements .....±25 mm

Edge location of all openings .....±13 mm

Sawcuts, joints, and weakened plane embedments in slabs .....±20 mm

**COMMENTARY**

**R4.2—Deviation from location**

**R4.2.1** Horizontal deviation is defined in Section 1.3. The tolerance for horizontal deviation would apply to the plan location of items such as the vertical edge of a floor opening or of a wall, beam, or column. The tolerance for horizontal deviation would also apply to items such as the vertical edges of openings in walls, beams, or columns. Refer to Fig. R4.2.1(a) to (c). The tolerance on sawcut location is driven by aesthetic concerns. Research (Martinez and Davenport 2005) suggests that for a 450 mm dowel the sawcut can be offset from the center as much as 75 mm without impacting joint performance.

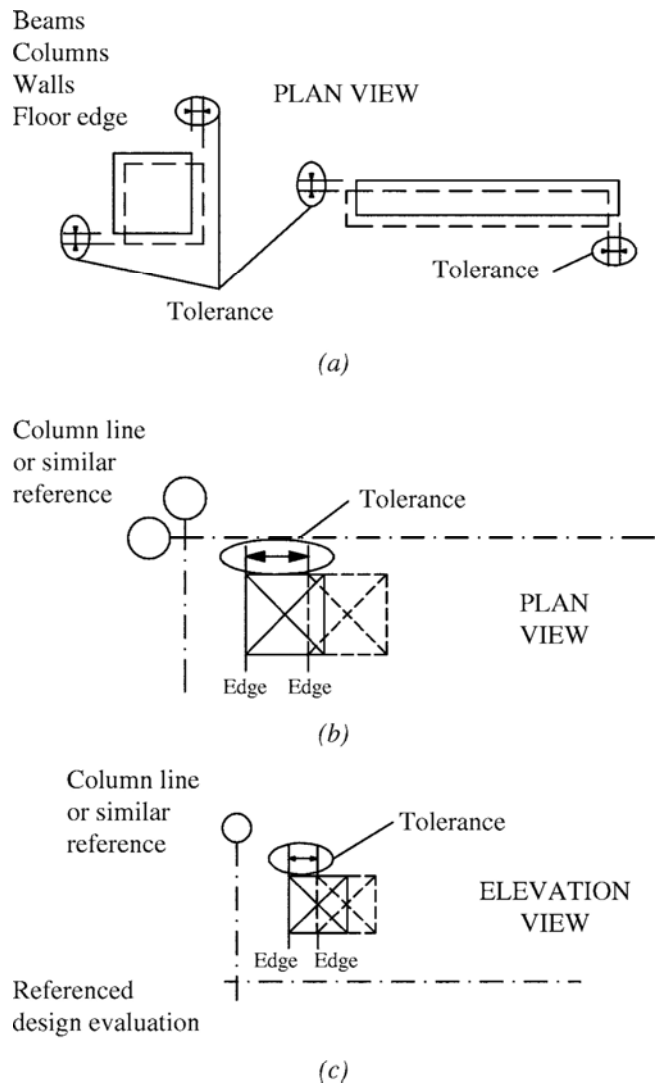

Fig. R4.2.1—Horizontal deviation.

**SPECIFICATION**

**4.2.2 Vertical deviation**

Elements .....	±25 mm
Edge location of all openings .....	±13 mm

**COMMENTARY**

**R4.2.2** Vertical deviation is also defined in [Section 1.3](#). The tolerance for vertical deviation would apply to the location of items such as the horizontal edges of a wall or column opening. The tolerance for vertical deviation would also apply to items such as the horizontal edges of openings in walls, beams, or columns. Refer to Fig. R4.2.2(a) and (b).

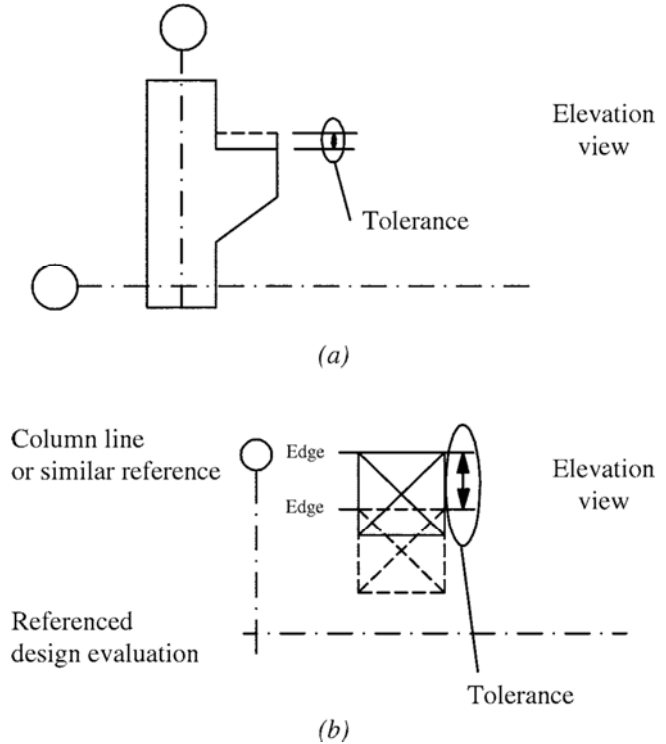

Fig. R4.2.2—Vertical deviation.

**4.3—Not used**

**4.4—Deviation from elevation**

**4.4.1 Top surface of slabs**

Slabs-on-ground .....	±20 mm
Formed suspended slabs, before removal of supporting shores.....	±20 mm
Slabs on structural steel or precast concrete .....	no requirement

**R4.4—Deviation from elevation**

**R4.4.1** The top elevation for slabs on structural steel or precast concrete will be determined by elevation of the supporting steel or precast concrete, plus or minus variations in slab thickness, as specified in [Section 4.5.3](#). In situations where this procedure may result in unsatisfactory slab elevations (for example, unshored beams that deflect or supporting steel or precast set with large deviations from specified elevation), the Architect/Engineer should specify, or the contractors involved should agree on, a satisfactory procedure. The concrete flooring contractor cannot control elevations of steel or precast concrete members upon which concrete slabs are cast. In the instance of slabs cast on metal deck, there is also a practical limitation on the increase of slab thickness to accommodate differential elevations or deflections. If the Specifier requires the concrete slab to be placed level on deflecting or cambered supporting steel or precast, the plus tolerance is likely to be exceeded.

## SPECIFICATION

4.4.2 Formed surfaces before removal of shores  
.....±20 mm

4.4.3 Lintels, sills, parapets, horizontal grooves, and  
other lines in exposed concrete .....±13 mm

4.4.4 Top of walls .....±20 mm

4.4.5 Fine grade of soil immediately below slabs-on-  
ground.....±20 mm

### 4.5—Deviation from cross-sectional dimensions

4.5.1 Thickness of elements, except slabs, where  
specified cross-sectional dimension is  
300 mm or less .....+10 mm  
.....-6 mm

More than 300 mm, and not more than 900 mm  
.....+13 mm  
.....-10 mm

More than 900 mm.....+25 mm  
.....-20 mm

#### 4.5.2 *Unformed beams and walls cast against soil*

Horizontal deviation from plan dimension:  
Where dimension is 600 mm or less.....+75 mm  
.....-13 mm

Where dimension is more than 600 mm .....+150 mm  
.....-13 mm

## COMMENTARY

**R4.4.3** The term “exposed concrete” is used as defined in *ACI Concrete Terminology*. Exposed Concrete is addressed in the [Mandatory Requirements Checklist, Section 1.1.2](#).

**R4.4.5** The elevation of the soil upon which a slab-on-ground is to be placed is generally more difficult to control than that of the concrete surface. The intent of establishing an elevation tolerance of ±20 mm for fine grading below slabs-on-ground is to provide an environment in which a slab-on-ground installation can successfully comply with the thickness requirements established in [Section 4.5.4](#). If more stringent tolerance requirements are deemed necessary by the Specifier, consider a fine grade elevation tolerance of ±13 mm. This tolerance is reasonable for industrial applications because more sophisticated equipment is normally used to establish the fine grade elevation and because of the performance requirements for industrial slabs.

### R4.5—Deviation from cross-sectional dimensions

Cross-sectional dimensions determine the permissible thickness of concrete members, or variation in opening width.

**R4.5.1** Inspection of formwork for conformance to specified placement thickness tolerances may involve measurements prior to placement of concrete. Specified tolerances apply to the completed concrete element.

## SPECIFICATION

### 4.5.3 Thickness of suspended slabs ..... –6 mm

**4.5.3.1** Samples for slab thickness, when taken, shall conform to the requirements of Sections 4.5.4.1 through 4.5.4.6.

### 4.5.4 Thickness of slabs-on-ground

Average of all samples ..... –10 mm

Individual sample ..... –20 mm

**4.5.4.1** Minimum number of slab thickness samples, when taken, shall be four (4) for each 460 m<sup>2</sup> or part thereof.

**4.5.4.2** Samples shall be taken within seven (7) days of placement.

**4.5.4.3** Samples shall be randomly located over the test area and shall be taken by coring of the slab or by using an impact-echo device.

**4.5.4.3.1** Where concrete core samples are taken, the length of each core sample shall be determined using ASTM C174/C174M.

**4.5.4.3.2** An impact-echo device, when used, shall be calibrated using a minimum of three random locations within the test area where the actual concrete thickness is known. The impact-echo test shall be conducted in accordance with ASTM C1383.

## COMMENTARY

**R4.5.3** Suspended (elevated) slabs require only that a tolerance for elevation and cross-sectional dimension be established. Thickness of suspended slabs is of primary concern because insurance carriers establish a fire rating of the structure, depending on the occupancy. The fire rating is derived in part from the insulating properties of concrete and the thickness of the concrete slab. Achieving the minimum period of fire separation between floors depends in part on achieving a minimum thickness. Variations in the elevation of erected steel or precast concrete and in deflections of the supporting metal deck and frame under weight of concrete often make it necessary to provide additional slab thickness in local areas where the intent is to produce a relatively level slab. Care should be taken to ensure that providing additional concrete in local areas does not overload the supporting formwork or metal deck. Significant increase to slab thickness can have a negative impact on structural performance.

**R4.5.4** Specifiers should anticipate localized occurrences of reduced thickness for slabs-on-ground. The slab-on-ground thickness tolerance has been set with respect to both average thickness for all the samples measured and a minimum thickness for individual samples.

Where the Specifier determines requirements of this section are inadequate for a particular application, the Specifier should incorporate within the Project Specifications specific sampling procedures and acceptance criteria for all elements impacting thickness of slabs-on-ground (Sections R4.4.1, R4.4.5, and R4.5.4). In such an instance, consideration might be given to statistical control of the subgrade, elevation of the concrete surface, and slab thickness.

**R4.5.4.1** Thickness samples are sometimes taken in combination with other testing, and the information gathered from that testing is valid for information purposes. Thickness samples taken for purposes of evaluating the slab with respect to tolerances in this specification, however, must meet the requirements of this section.

**R4.5.4.2** Sampling after the specified 7-day period will not adversely affect the measured values; however, it may affect the ability to take corrective action.

**R4.5.4.3** ACI 228.2R contains a discussion of the advantages and limitations of the various test methods. A short-pulse radar device can also provide slab thickness data. The precision of this method may require that a larger number of samples be taken to provide the same degree of reliability as the methods identified in this section. Proper use of the equipment requires calibration as established in ASTM D4748 and data collection in accordance with the provisions of ASTM D4748 using a non-contact horn antenna.

## SPECIFICATION

## COMMENTARY

ASTM D4748 may not be appropriate for use on ACI 302 Class 6-8 floors. ASTM D4748, Table 1, shows that concrete has a dielectric constant range of 6 to 11 for portland-cement concrete, but does not distinguish between high-density or low-density concrete, which could magnify any error associated with incorrectly assuming the average dielectric constant. Section 1.2 of the ASTM test method shows pavements with increased attenuation of the electromagnetic signal should not be measured with this method. The ASTM Standard, Section 7.2.1 requires either actual cores for calibration or “best guess” practices from field operators. It is recommended that “best guess” not be used for purposes of this document.

**4.5.4.4** Location of the samples shall be identified and results recorded in a manner that will allow an independent third party to verify the accuracy of the data.

**4.5.4.5** When computing the average of all samples, samples with a thickness more than 20 mm above the specified thickness shall be assumed to have a thickness 20 mm more than the specified thickness.

**4.5.4.6** When corrective action is required, additional samples shall be taken in the vicinity of unacceptable results to establish the extent of corrective action.

### 4.6—Deviation from formed opening width or height

**4.6.1** Opening width or height.....–13 mm  
.....+25 mm

### 4.7—Deviation from relative elevations or widths for stairs

**4.7.1** *Stairs, measured along a line parallel to the stair axis*

Difference between largest and smallest tread or riser in any flight shall not exceed 10 mm.

Difference in height of adjacent risers measured at the nose shall not exceed 5 mm.

Difference in depth of adjacent treads shall not exceed 5 mm.

### 4.8—Deviation from slope or plane

**4.8.1** Stair tread from back to nosing.....±6 mm

## SPECIFICATION

### 4.8.2 Formed surfaces over distances of 3 m

All conditions, unless noted otherwise in this section  
 .....±0.3%

Outside corner of exposed corner column .....±0.2%

Contraction joint grooves in exposed concrete...±0.2%

### 4.8.3 Formed surface irregularities (gradual or abrupt)

Abrupt irregularities shall be measured within 25 mm of the irregularity. Gradual surface irregularities shall be measured by determining the gap between concrete and near surface of a 1.5 m straightedge, measured between contact points.

Class A Surface..... +3 mm

Class B Surface..... +6 mm

Class C Surface..... +13 mm

Class D Surface..... +25 mm

**4.8.4** Random traffic floor surface finish tolerances shall meet the requirements of **Section 4.8.5** or **4.8.6**, as specified in the Contract Documents.

**4.8.4.1** A specified overall area is the entire floor surface specified to conform to a particular surface classification.

**4.8.4.2** The surface classification of all floors shall be specified in the Contract Documents.

**4.8.4.3** Each individual slab placement shall constitute a separate test surface.

## COMMENTARY

**R4.8.2** This is one of several paragraphs that address the proper location of formed surfaces. Local departure of the formed surface from the specified slope or plane is addressed in this section. A departure of 0.3% is approximately 10 mm over a distance of 3 m. Tolerances are based on a 3 m measured length. Interpolation or extrapolation of tolerances for dimensions greater than or less than 3 m are not permitted. Other sections, such as **Sections 4.1** and **4.4.2**, establish a global tolerance for elements.

**R4.8.3** Specifiers should anticipate local irregularities in formed surfaces. The purpose of establishing different classes of surface is to define the magnitude of irregularities in a manner that is consistent with the exposure of the concrete when in service. As stated in **Section R4.4.3**, the term “exposed concrete” is used as defined in *ACI Concrete Terminology*. Exposed Concrete is addressed in the **Mandatory Requirements Checklist, Section 1.1.2**. The Specifier should also anticipate abrupt transitions at the surface of members where segmental steel void forms are used to form floor framing members. The Specifier should refer to the Mandatory Requirements Checklist.

**R4.8.4** The purpose of establishing floor surface tolerances is to define surface characteristics that are of importance to those who will be using the surface. The two surface characteristics thought to be of greatest importance for concrete floors are flatness and levelness. Flatness can be described as bumpiness of the floor, and is the degree to which a floor surface is smooth or plane. Levelness is the degree to which a floor surface parallels the slope established on the project drawings. Two methods are identified for use in the evaluation of floor surface finish tolerances. The F-Number System uses data taken at regular intervals along lines located in random locations on the test surface. The described methods use different criteria to evaluate the as-constructed data. Therefore, it is important that the Specifier select the method most applicable to the end user of the floor. The Waviness Index may be used instead of the two methods identified in **Sections 4.8.5** and **4.8.6** by specifying parameters established in the Optional Checklist. Before contracting to build to any floor tolerance specification, it is suggested the constructor evaluate data from tests of its own floors. Data should be processed using the proposed floor tolerance specification to confirm an understanding of the specific approach and its implications on proposed construction means and methods. Specifiers may require the constructor to demonstrate proven ability by testing an existing floor slab installed by the constructor.

Each of the methods described herein will yield a slightly different result. Each of the described approaches uses a different method to evaluate flatness. The F-Number System



## SPECIFICATION

## COMMENTARY

uses only 600 mm slope changes (center offset from a 600 mm chord). The manual straightedge and computerized simulation of the manual straightedge methods both use maximum offsets from chords of varying lengths up to 3 m.

To develop an understanding of the relationship among these approaches, the committee undertook a study of six groups of 100 individual profiles each (600 total). The profiles included all quality levels likely to be produced using current construction techniques; each of the profiles was 30 m long. Table R4.8.4 shows partial results of that study. Evaluation of the results resulted in the tolerance values contained in [Sections 4.8.5](#) and [4.8.6](#).

Floor surface classifications shown in [Sections 4.8.5](#) and [4.8.6](#) vary from conventional at the low end to super flat at the high end of the flatness/levelness spectrum. Although there is no direct correlation among the described tolerancing methods, similarly classified floors in [Sections 4.8.5](#) and [4.8.6](#) should provide the user with floor surfaces of approximately the same flatness and levelness.

Floor surfaces in the conventional category can be routinely produced using strikeoff and finishing techniques that include no restraighening operations after initial strikeoff. This classification of floor surface is generally not compatible with floor coverings such as carpeting and vinyl flooring. Conventional floor surface tolerances are appropriately applied to areas such as mechanical rooms, nonpublic areas, or surfaces under raised computer flooring or thick-set tile.

The moderately flat classification of surface tolerances will routinely require the use of float dish attachments to the power float machines or some restraighening of the concrete surface during finishing operations to consistently achieve flatness requirements. The moderately flat surface can routinely be produced by using a wide bull float (2.4 to 3.0 m) to smooth the concrete and a modified highway

**Table R4.8.4—Methods to evaluate flatness**

Floor classification	$F_F$ flatness ( $SO_{F_F}$ )	3 m manual straightedge maximum gap, mm
Conventional	20	16 to 7
Moderately flat	25	15 to 6
Flat	35	9 to 4
Very flat	45	7 to 4
Super flat	60	6 to 3
Floor classification	3 m manual straightedge maximum gap, mm	$SO_{F_F}$ range
Conventional	13	17.4 to 27.7
Moderately flat	10	20.3 to 34.9
Flat	6	24.0 to 45.9
Very flat	5	31.7 to 64.3
Super flat	3	37.7 to 109.3

## SPECIFICATION

## COMMENTARY

straightedge to restraighten the surface after completion of the initial power float pass. The use of a rider with float dishes attached to the trowel blades can reduce the amount of restraightening required by the modified highway straightedge. An appropriate use of floor surfaces with this classification would be carpeted areas of commercial office buildings or industrial buildings with low-speed vehicular traffic.

Flat floor tolerances are appropriate for concrete floors under thin-set ceramic, vinyl tile, or similar coverings. Flat floor tolerances are also appropriate for use in warehouses employing conventional lift trucks and racks. The flat classification requires restraightening after floating and is the highest feasible tolerance level for suspended slabs.

Very flat floor tolerances are generally restricted to high-end industrial applications, such as might be required for successful operation of high-speed lift trucks, air pallets, or similar equipment. Multiple restraightenings in multiple directions following both the floating and initial finishing phases are required to produce floors conforming to very flat tolerances. The use of a laser screed or rigid edge forms up to 9.1 m apart can achieve the required degree of levelness.

The super-flat category is the highest quality random traffic floor surface classification that can be routinely produced using current technology. Only skilled contractors, using sophisticated equipment, will be able to achieve this level of quality. Restraightening operations for this floor category are more rigorous than that described for the very flat category. The super-flat random traffic category is only appropriate for limited applications, such as TV production studios.

Another type of super-flat floor surface, one that falls outside the scope of random traffic specifications, is that which is required for defined traffic applications, such as narrow aisle industrial warehouse floors. The aisle width in these installations is typically about 1.5 m wide, and the narrow clearance between the vehicles and racks requires construction of an extremely smooth and level surface. The tolerance requirements normally dictate strip placement of concrete using closely spaced rigid forms (approximately 4.6 m on center), but they can occasionally be achieved without narrow strip placement by skilled contractors using sophisticated equipment.

The evaluation of the super-flat defined traffic surface classification requires specialized techniques that should be agreed on by all parties before construction. The test method should measure:

1. The maximum transverse elevation difference between wheel tracks;
2. The maximum elevation difference between front and rear axle; and
3. The maximum rate of change per meter for 1 and 2 as the vehicle travels down the aisle.

## SPECIFICATION

**4.8.4.4** Floor test surfaces shall be measured and reported within 72 hours after completion of slab concrete finishing operations and before removal of any supporting shores.

**4.8.4.5** Test reports shall be distributed to the Owner, the Architect, the General Contractor, and the flatwork contractor.

**4.8.4.6** Test surface measurements shall not cross planned changes in floor surface slope.

**4.8.4.7** Test results shall be reported in a manner that will allow the data to be verified or the tests to be replicated.

**4.8.5** Random traffic floor finish tolerances as measured in accordance with ASTM E1155M shall conform to the following requirements:

**4.8.5.1** Specified overall values for flatness ( $SOF_F$ ) and levelness ( $SOF_L$ ) shall conform to the specified Floor Surface Classifications, as listed in [Table 4.8.5.1](#).

## COMMENTARY

Flatness of defined traffic wheel tracks can also be specified by reference to ASTM E1486M, Section 4.9.

The remedy for noncompliance with specified defined flatness tolerances should be included in specification language. For random traffic slabs-on-grade, the remedy can range from liquidated damages, to localized grinding, to application of a topping, to removal and replacement, depending on the purpose for which the slab is being installed. The remedy for defined traffic installations is generally grinding of high spots.

**R4.8.4.4** The purpose for establishing a default 72-hour time limit on the measurement of floor surfaces is to avoid any possible conflict over the acceptability of the floor and to alert the Contractor of the need to modify finishing techniques on subsequent placements, if necessary, to achieve compliance. All slabs will shrink; joints and cracks in slabs-on-ground will curl with time, resulting in a surface that is less flat with the passage of time. If the needs of the user are such that a delay in testing is necessary to allow successful installation of subsequent Work, this requirement for delayed testing should be clearly stated in the specifications.

**R4.8.4.6** Ramped (sloped) surfaces can be tolerated by reference to ASTM E1486M or the average slope of 4.6 m least squares fit of each survey line calculated in accordance with ASTM E1486M, Section 4.11 and Eq. (21), (22), and (23). Survey lines should be parallel to the direction of slope. In instances where the Specifier chooses to provide a tolerance at construction joints, specific provisions for data collection should be included in the Project Specifications.

**R4.8.5** The F-Number System evaluates the flatness of a floor surface by measuring slope changes over a distance of 600 mm. Specifics of the test procedure are dictated by ASTM E1155M. The 600 mm slope change data are evaluated to develop an estimate of the floor's flatness. The system evaluates the levelness of a floor surface by measuring elevation changes relative to a horizontal plane and between points separated by a distance of 3 m. These 3 m elevation differences are evaluated to develop an estimate of the floor's levelness. Higher numbers indicate better quality in the surface characteristic being reported.

## SPECIFICATION

## COMMENTARY

**Table 4.8.5.1—ASTM E1155M method**

Floor surface classification	Specified overall flatness $SOF_F$	Specified overall levelness $SOF_L$
Conventional	20	15
Moderately flat	25	20
Flat	35	25
Very flat	45	35
Super flat	60	40

**4.8.5.2** The  $SOF_F$  and  $SOF_L$  values shall apply solely to the specified overall area and no subdivision thereof.

**4.8.5.3** Minimum local values for flatness ( $MLF_F$ ) and levelness ( $MLF_L$ ) shall equal 3/5 of the  $SOF_F$  and  $SOF_L$  values, respectively, unless noted otherwise.

**4.8.5.4** The  $SOF_L$  and  $MLF_L$  levelness tolerances shall apply only to level slabs-on-ground, or to level suspended slabs that are shored when tested.

**R4.8.5.2** The specified overall values  $SOF_F$  and  $SOF_L$  are the  $F_F$  and  $F_L$  numbers to which the completed project floor surface must conform viewed in its entirety. Daily  $F_F/F_L$  results may vary above and below  $SOF_F/SOF_L$  without consequence, provided: a) that the cumulative results ultimately equal or exceed  $SOF_F/SOF_L$ , and b) that the specified  $MLF_F$  and  $MLF_L$  values are satisfied at all locations. The F-Number System provides daily running totals of the aggregate in-place areas that are less than, equal to, and better than  $SOF_F$  and  $SOF_L$ . Consequently, after the entire floor has been installed, the system permits the immediate calculation of liquidated damages based on the final aggregate areas defective relative to either  $SOF_F$  or  $SOF_L$  (whichever yields the larger penalty).

**R4.8.5.3** Some local variation in floor surface quality should be anticipated by the Specifier, much as one should anticipate variations in results of concrete compressive tests. These variations can be caused by normal occurrences, such as inconsistent setting time of concrete, changes in ambient conditions, or delays in delivery or placement of the concrete. The specified  $MLF_F$  and  $MLF_L$  values establish the minimum surface quality that will be acceptable anywhere on any of the concrete placements. Experience has shown that the use of tools and techniques that will generally meet specific  $SOF_F/SOF_L$  requirements for the overall concrete placement are also sufficient to meet the associated  $MLF_F/MLF_L$  requirements in the minimum local areas. Acceptance or rejection of a minimum local area requires that data collection within the minimum local area in question meet the requirements of ASTM E1155M. Because  $MLF_F$  and  $MLF_L$ , in theory, define the minimum usable floor,  $MLF_F/MLF_L$  defects normally require physical modification (that is, grinding, topping, or removal and replacement) of the entire affected minimum local area.

**R4.8.5.4** Initial camber, curling, and deflection all adversely affect the conformance of a floor surface to a plane. Limiting the use of  $F_L$  to evaluation of level slabs-on-ground and level suspended slabs before shores or forms are removed ensures that the floor's levelness is accurately assessed.

## SPECIFICATION

**4.8.6** Random traffic floor finish tolerances as measured by manually placing a freestanding (unleveled) 3 m straightedge anywhere on the slab and allowing it to rest naturally upon the test surface shall conform to the following requirements:

**4.8.6.1** The gap under the straightedge and between the support points shall not exceed either of the values as listed for the specified Floor Surface Classification in Table 4.8.6.1.

**Table 4.8.6.1—Manual straightedge method**

Floor surface classification	Maximum gap 90% compliance Samples not to exceed	Maximum gap 100% compliance Samples not to exceed
Conventional	13 mm	20 mm
Moderately flat	10 mm	16 mm
Flat	6 mm	10 mm
Very flat	N/A	N/A
Super flat	N/A	N/A

**4.8.6.2** The following minimum sampling requirements shall apply for test surfaces evaluated using this tolerance method:

**4.8.6.2.1** A test surface is deemed to meet specified tolerances if it complies with the maximum-gap-under-the-straightedge limitations given in Section 4.8.6.1 above. The maximum disparity between a taut string stretched between the bottom corners at the ends of the straightedge and the underside of the straightedge shall not exceed 1 mm at any point.

**4.8.6.2.2** The minimum number of samples =  $(0.1)$  area for floor areas measured in  $m^2$ . A sample is a single placement of the straightedge.

**4.8.6.2.3** Orientation of the straightedge shall be parallel, perpendicular, or at a 45-degree angle to longest construction joint bounding the test surface.

**4.8.6.2.4** An equal number of samples shall be taken in perpendicular directions.

**4.8.6.2.5** Samples shall be evenly distributed over the test surface.

**4.8.6.2.6** Straightedge centerpoint locations for samples shall not be closer than 1.5 m.

**4.8.6.2.7** Test results shall be reported in a manner that will allow the data to be verified or the test to be replicated, such as a key plan showing straightedge centerpoint location and straightedge orientation.

## COMMENTARY

**R4.8.6** The manual straightedge approach evaluates the flatness of a floor surface by placing a 3 m long straightedge on the floor surface and measuring the maximum gap that occurs under the straightedge and between the support points.

**R4.8.6.1** Measurements should be taken between straight-edge support points and perpendicular to its base. Smaller gaps between the straightedge and supporting surface are indicative of higher flatness quality. The use of this approach requires that 90% of the data samples should comply with values in the second column, and 100% of the data samples should comply with values in the third column. This method is not sufficiently precise to evaluate very flat and super-flat categories.

**R4.8.6.2** At the time the document was prepared, no nationally accepted specification has been developed to govern evaluation of a floor surface using this procedure; therefore, minimum sampling requirements have been established in this section. The Specifier may provide alternative procedures as long as specific testing requirements and acceptance criteria are established. Test results should be reported in a manner that will allow the data to be verified or the test to be replicated. When using this approach to evaluate floor surfaces, levelness is subject to the provisions of [Section 4.4.1](#); the manual straightedge approach does not directly measure levelness.

## SPECIFICATION

**4.8.6.3** A computerized simulation of a freestanding 3 m straightedge test shall be permitted to be used as an alternative to the test procedure established in the Contract Documents or the previous paragraph. Data collection procedures and evaluation of data shall comply with the requirements established in the Contract Documents or **Section 4.8.6.2**.

**4.8.7** Root mean square (RMS) levelness tolerance in mm/m for floors purposely pitched in one direction shall be obtained per the requirements of Paragraph 4.11 of ASTM E1486M. Each survey line used in the RMS levelness calculation shall be parallel with the others and all lines shall be in the direction of the pitch or tilt.

## 4.9—Sawcut depth in slab-on-ground

**4.9.1** Depth of sawcut joint .....  $\pm 6$  mm

## COMMENTARY

**R4.8.6.3** A computerized simulation of a manual straightedge approach can be used to evaluate the flatness of a floor surface. Data are taken using an instrument other than a straightedge and processed using a computer to produce results similar to that achieved using a manual straightedge. This method requires that data be collected along lines in a manner similar to that described by ASTM E1155M or ASTM E1486M. The flatness is evaluated by moving a simulated 3 m long straightedge along each data line at 0.3 m intervals. No ASTM standard has been developed to govern evaluation of a floor surface using this procedure, so the Specifier should provide specific testing requirements and acceptance criteria as described in the Mandatory Requirements Checklist. Results should be reproducible. When using this approach to evaluate floor surfaces, levelness is subject to the provisions of **Section 4.4.1**; the computerized simulation of a manual straightedge approach does not directly measure levelness. The Specifier is advised that current available software for computerized simulation of a freestanding 3 m straightedge does not meet the requirements of **Section 4.8.6.2**.

# SECTION 5—CAST-IN-PLACE CONCRETE AT INTERFACE WITH PRECAST CONCRETE (EXCEPT TILT-UP CONCRETE)

## SPECIFICATION

## COMMENTARY

Tolerances for construction and erection of precast concrete units are not part of this standard. Refer to ITG-7M, “Specification for Tolerances for Precast Concrete,” for precast concrete tolerances. Tolerances in this standard apply to cast-in-place concrete elements that interface with precast concrete elements.

Tolerances for tilt-up concrete are specified in [Section 15](#).

### 5.1—Deviation from elevation— cast-in-place concrete

### 5.1—Deviation from elevation— cast-in-place concrete

5.1.1 <i>Isolated footing</i> .....	+13 mm
.....	-50 mm
5.1.2 <i>Continuous footing</i> .....	+13 mm
.....	-25 mm

**R5.1.1** *Isolated footing*—Refer to Fig. R5.1.1.

**R5.1.2** *Continuous footing*—Refer to Fig. R5.1.2.

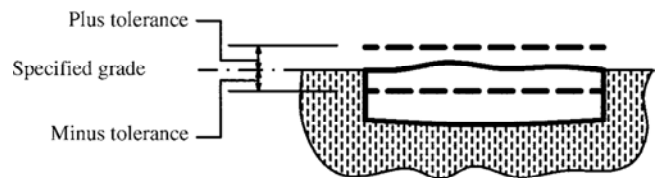

*Fig. R5.1.1—Isolated footing: elevation view.*

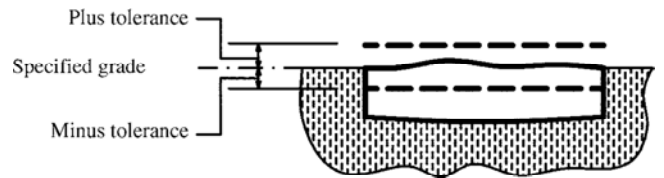

*Fig. R5.1.2—Continuous footing: elevation view.*

**SPECIFICATION**

- 5.1.3 *Pilasters, pedestals, and columns*..... +6 mm  
..... -20 mm
- 5.1.4 *Individual corbels*..... +6 mm  
..... -13 mm
- 5.1.5 *Continuous ledges*..... +6 mm  
..... -13 mm
- 5.1.6 *Walls*..... +6 mm  
..... -20 mm
- 5.1.7 *Embedded fabricated bearing surface assemblies* ..... +6 mm  
..... -13 mm
- 5.1.8 *Grout-filled steel sleeve splice*..... ±13 mm
  - 5.1.8.1 Top of embedded dowel ..... ±13 mm
  - 5.1.8.2 Top of embedded sleeve ..... +25 mm  
..... -6 mm
- 5.1.9 *Anchor bolts* .....refer to **Section 2.3.4**
- 5.1.10 *Embedded plates* ..... ±25 mm
- 5.1.11 *Inserts and assemblies with inserts* ..... ±13 mm
- 5.1.12 *Embedded items flush with unformed concrete surface except grout-filled sleeves*.... ±13 mm

**COMMENTARY**

**R5.1.3** *Pilasters, pedestals, and columns*—Refer to Fig. R5.1.3.

**R5.1.4 and R5.1.5** *Individual corbels and continuous ledges*—Refer to Fig. R5.1.4 and R5.1.5.

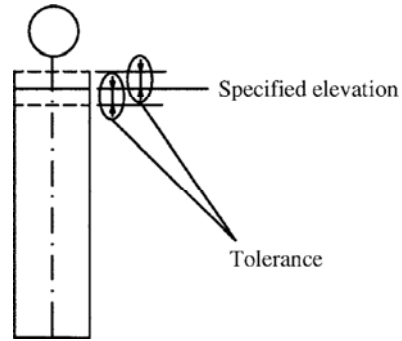

Fig. R5.1.3—Pilasters, pedestals, and columns: elevation view.

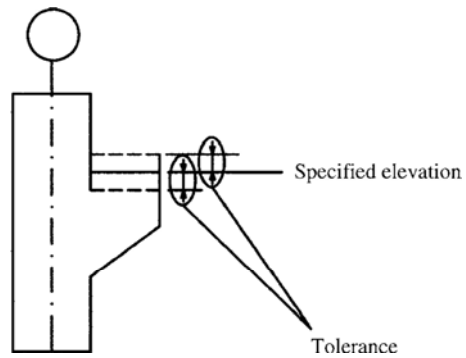

Fig. R5.1.4 and R5.1.5—Individual corbels or continuous ledges: elevation view.



**SPECIFICATION**

**5.2—Deviation from location—  
cast-in-place concrete**

**5.2.1 Horizontal deviation**

**5.2.1.1** To a step down in continuous footing.....+25 mm  
.....-75 mm

**5.2.1.2** Pilasters, pedestals, and columns.....±25 mm

**5.2.1.3** Individual corbels.....±25 mm

**5.2.1.4** Top of walls.....±13 mm

**5.2.1.5** Fabricated bearing surface assemblies flush with concrete surface.....±13 mm

**5.2.1.6 Grout-filled steel sleeve splice**

**5.2.1.6.1** Embedded dowel or sleeve.....±6 mm

**5.2.1.7** Anchor bolts..... refer to **Section 2.3.4**

**5.2.1.8** Distance between vertical surfaces at opposite ends of a precast member .....±25 mm

**5.2.1.9** Embedded plates.....±25 mm

**5.2.1.10** Inserts and assemblies with inserts...±13 mm

**5.2.1.11** Embedded items flush with formed concrete surface .....±13 mm

**COMMENTARY**

**5.2—Deviation from location—  
cast-in-place concrete**

**R5.2.1.1** *To a step down in continuous footing—*Refer to Fig. R5.2.1.1.

**R5.2.1.2** *Pilasters, pedestals, and columns—*Refer to Fig. R5.2.1.2.

**R5.2.1.3** *Individual corbels—*Refer to Fig. R5.2.1.3.

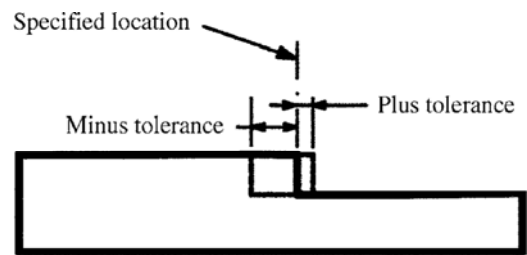

*Fig. R5.2.1.1—Continuous footing: elevation view.*

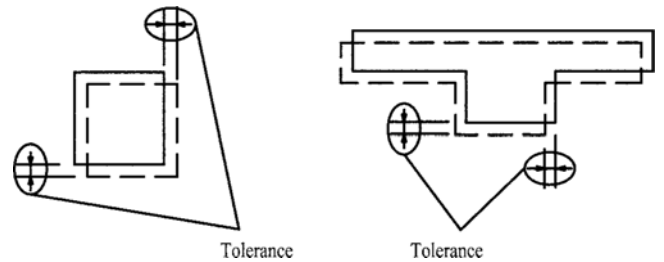

*Fig. R5.2.1.2—Pilasters, pedestals, and columns: plan view.*

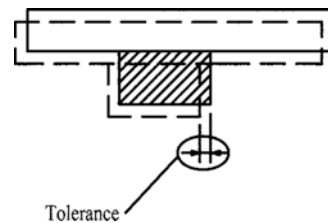

*Fig. R5.2.1.3—Individual corbel: plan view.*

**SPECIFICATION**

**5.3—Deviation from dimension—  
cast-in-place concrete**

**5.3.1 Specified length**

**5.3.1.1** Projection of individual corbels and continuous ledges from face of support .....  $\pm 10$  mm

**5.3.1.2** Walls or beams where precast members abut both ends .....  $-25$  mm  
.....  $+13$  mm

**5.3.1.3** Steel sleeve for grout-filled steel sleeve splice .....  $-6$  mm

**5.3.2 Specified width**

**5.3.2.1** Individual corbels .....  $\pm 10$  mm

**5.3.2.2** Walls, where specified width is 300 mm or less .....  $+10$  mm  
.....  $-6$  mm

More than 300 mm but not more than 900 mm .....  $+13$  mm  
.....  $-10$  mm

More than 900 mm .....  $+25$  mm  
.....  $-20$  mm

**5.3.2.3 Exposed vertical exterior joint with a precast panel**

**5.3.2.3.1** Up to  $\pm 1/3$  of the joint width and not to exceed  $\pm 13$  mm

**5.3.2.3.2** Variation in width over any 3 m portion of the joint length or the full length if less than 3 m .....  $\pm 13$  mm

**COMMENTARY**

**5.3—Deviation from dimension—  
cast-in-place concrete**

**R5.3.1.1** *Projection of individual corbels and continuous ledges from face of support—Refer to Fig. R5.3.1.1(a) and (b).*

**R5.3.2.1** *Individual corbels—Refer to Fig. R5.3.2.1.*

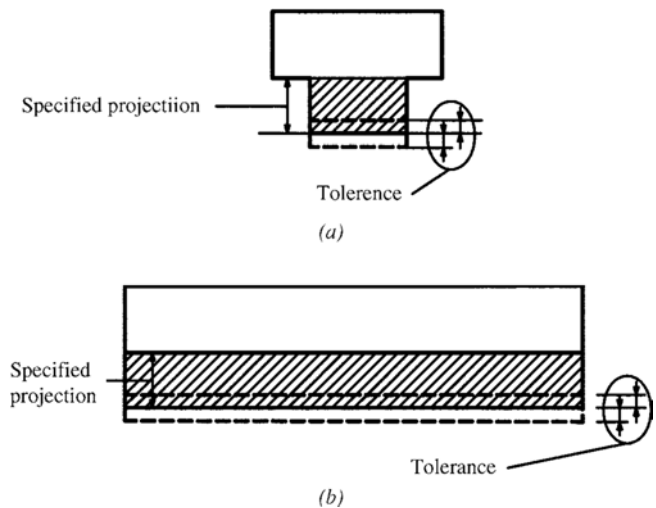

*Fig. R5.3.1.1—Projection of individual corbel and continuous ledges: plan view.*

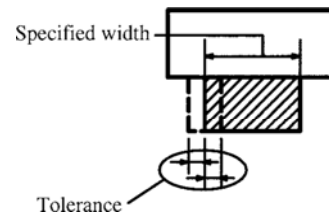

*Fig. R5.3.2.1—Width of individual corbel: plan view.*

**SPECIFICATION**

**5.4—Deviation from plane at bearing surface—cast-in-place concrete measured over length or width of bearing surface**

5.4.1 Walls where specified width is  
 300 mm or less .....±3 mm  
 Greater than 300 mm.....±6 mm

5.4.2 Individual corbels .....±3 mm

5.4.3 Continuous ledges .....±3 mm

**COMMENTARY**

**R.5.4—Deviation from plane at bearing surface—cast-in-place concrete measured over length or width of bearing surface**

Refer to Fig. R5.4.

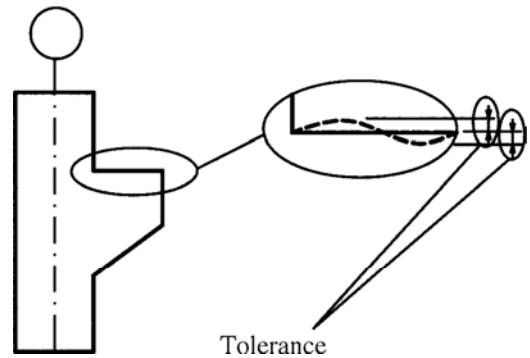

*Fig. R5.4—Deviation from plane at bearing surface: elevation view.*

**Notes**

## SECTION 6—MASONRY

### SPECIFICATION

This specification does not address masonry construction. Refer to ACI 530.1, "Specification for Masonry Structures and Commentary," for masonry tolerances.

### COMMENTARY

For guidance and tolerances for masonry, the Specifier should refer to the most recent edition of "Specification for Masonry Structures (ACI 530.1/ASCE 6/TMS 602)."

**Notes**

# SECTION 7—CAST-IN-PLACE, VERTICALLY SLIPFORMED BUILDING ELEMENTS

## SPECIFICATION

### 7.1—Deviation from plumb for buildings and cores

7.1.1 Translation and rotation from a fixed point at the base of the structure

Heights 30 m or less .....  $\pm 13$  mm per level  
 .....  $\pm 50$  mm maximum

Heights greater than 30 m  
 .....  $\pm 1/600$  times the height  
 .....  $\pm 13$  mm per level  
 .....  $\pm 150$  mm maximum

### 7.2—Horizontal deviation

7.2.1 Between adjacent elements .....  $\pm 25$  mm

7.2.2 Horizontal elements

Edges of openings, sleeves, and embedments 300 mm or smaller .....  $\pm 25$  mm

Edges of openings, sleeves, and embedments greater than 300 mm .....  $\pm 50$  mm

## COMMENTARY

### R7.1—Deviation from plumb for buildings and cores

Refer to Fig. R7.1.

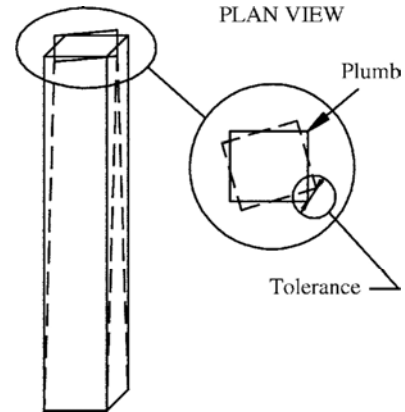

Fig. R7.1—Deviation from plumb for buildings and cores.

### R7.2—Horizontal deviation

Refer to Fig. R7.2.1 and R7.2.2.

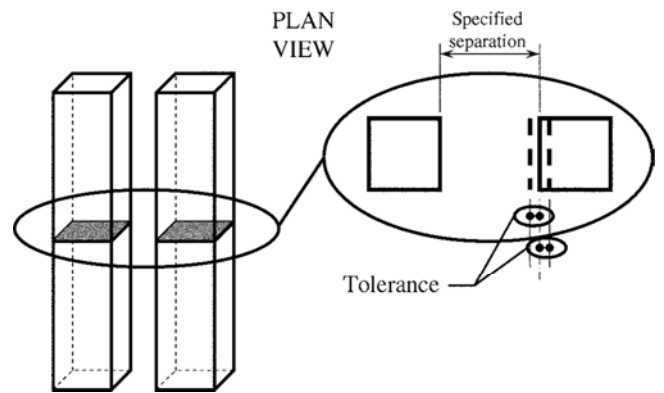

Fig. R7.2.1—Horizontal deviation.

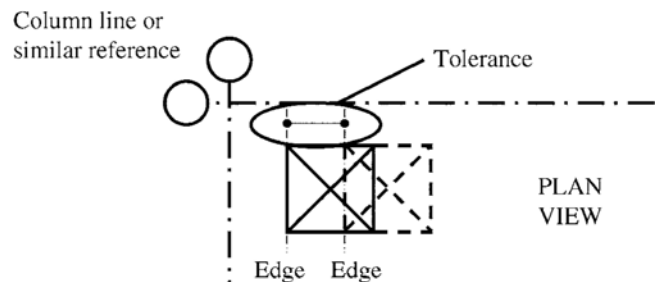

Fig. R7.2.2—Edges of openings, sleeves, and embedments.

**SPECIFICATION**

**7.3—Cross-sectional dimensions**

**7.3.1 Columns and walls**

300 mm or less.....	+10 mm
.....	-6 mm
More than 300 mm and less than 900 mm	
.....	+13 mm
.....	-10 mm
More than 0.90 m .....	+25 mm
.....	-20 mm

**7.4—Openings through elements**

**7.4.1 Door openings or walk-through type openings**

<b>7.4.1.1</b> Length or width of opening.....	+40 mm
.....	-6 mm

**7.4.2 Other openings and sleeves**

<b>7.4.2.1</b> Length or width of opening.....	+25 mm
.....	-0 mm

**7.5—Embedded plates**

<b>7.5.1</b> Length or width of plate.....	+50 mm
.....	-0 mm

**7.6—Deviation from plumb for slipformed and jumpformed silos**

**7.6.1 Deviation from plumb**

Translation of silo centerline, or rotation of silo wall from a fixed point at the base of the structure

30 m or less.....	±75 mm
More than 30 m.....	±1/400 of height

**7.6.2 Inside diameter or distance between walls**

Horizontal deviation.....	±13 mm per 3 m
.....	±75 mm

**7.6.3 Cross-sectional dimensions of component**

.....	+25 mm
.....	-10 mm

**7.6.4 Location of openings, embedded plates, and anchors**

Vertical deviation .....	±75 mm
Horizontal deviation.....	±25 mm

**COMMENTARY**

**R7.3—Cross-sectional dimensions**

Refer to Fig. R7.3.1.

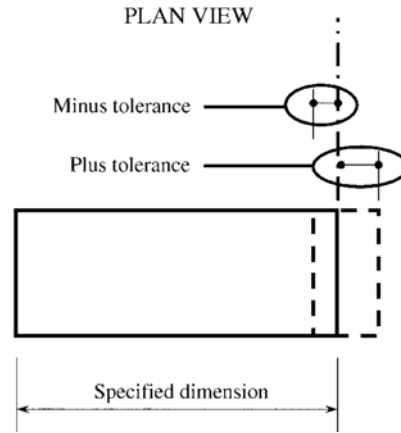

Fig. R7.3.1—Cross-sectional dimensions.



## SECTION 8—MASS CONCRETE

### SPECIFICATION

#### 8.1—Deviation from plumb

##### 8.1.1 Surfaces

Visible surfaces.....±30 mm

Concealed surfaces .....±65 mm

8.1.2 Side walls for radial gates and similar watertight joints .....±5 mm

#### 8.2—Horizontal deviation

Visible surfaces.....±30 mm

Concealed surfaces .....±65 mm

#### 8.3—Vertical deviation

##### 8.3.1 General

Visible flatwork and formed surfaces .....±13 mm

Concealed flatwork and formed surfaces .....±25 mm

8.3.2 Sills of radial gates and similar watertight joints .....±5 mm

#### 8.4—Cross-sectional dimension

Thickness.....+25 mm

.....-20 mm

#### 8.5—Deviation from plane

8.5.1 Slope of formed surfaces with respect to the specified plane shall not exceed the following amounts:

##### 8.5.1.1 Slopes, vertical deviation

Visible surfaces..... ±0.2%

Concealed surfaces ..... ±0.4%

##### 8.5.1.2 Slopes, horizontal deviation

Visible surfaces..... ±0.4%

Concealed surfaces ..... ±0.8%

### COMMENTARY

The Specifier should review the ACI standards referenced in this document and designate which portions of the structure are mass concrete.

**R8.1, R8.2, R8.3, R8.4, and R8.5**

Refer to commentary [Sections R4.1.1, R4.2.1, R4.2.2, R4.5, and R4.8.2](#), respectively.

**Notes**

## SECTION 9—CANAL LINING

### SPECIFICATION

#### 9.1—Horizontal deviation

##### 9.1.1 Surfaces

Visible surfaces.....±30 mm

9.1.2 Alignment of curves .....±100 mm

##### 9.1.3 Width ( $W$ ) of section at any height

.....±(0.0025  $W$  + 25 mm)

#### 9.2—Vertical deviation

9.2.1 Profile grade .....±25 mm

9.2.2 Surface of invert .....±13 mm

9.2.3 Surface of side slope .....±13 mm

9.2.4 Height ( $h$ ) of lining..... ±(0.005  $h$  + 25 mm)

#### 9.3—Cross-sectional dimensions

Thickness of lining cross section

..... ±10% of specified thickness

### COMMENTARY

R9.1, R9.2, and R9.3

Refer to commentary Sections R4.2.1, R4.2.2, and R4.5, respectively.

**Notes**

# SECTION 10—MONOLITHIC WATER-CONVEYING TUNNELS, SIPHONS, CONDUITS, AND SPILLWAYS

## SPECIFICATION

## COMMENTARY

### 10.1—Horizontal deviation

R10.1, R10.2, R10.3, and R10.4

10.1.1 Centerline alignment.....±13 mm

Refer to commentary [Sections R4.2.1, R4.2.2, R4.5, and R4.8.2](#), respectively.

10.1.2 Inside dimensions  
..... ±0.5% times inside dimension

### 10.2—Vertical deviation

10.2.1 Profile grade .....±13 mm

10.2.2 Surface of invert.....±6 mm

10.2.3 Surface of side slope .....±13 mm

### 10.3—Cross-sectional dimensions

10.3.1 *Cross section thickness at any point*  
Increase thickness: greater of 5% of thickness, or  
.....+13 mm

Decrease thickness: greater of 2.5% of thickness, or  
.....-6 mm

### 10.4—Deviation from plane

10.4.1 Slope of formed surfaces with respect to the specified plane shall not exceed the following amounts when measured with a 3 m straightedge:

#### 10.4.1.1 *Vertical deviation*

Visible surfaces..... ±0.2%  
Concealed surfaces ..... ±0.4%

#### 10.4.1.2 *Horizontal deviation*

Visible surfaces..... ±0.4%  
Concealed surfaces ..... ±0.8%

**Notes**

## SECTION 11—CAST-IN-PLACE BRIDGES

### SPECIFICATION

#### 11.1—Deviation from plumb

11.1.1 Exposed surfaces .....±20 mm

11.1.2 Concealed surfaces .....±40 mm

#### 11.2—Horizontal deviation

11.2.1 Centerline alignment.....±13 mm

11.2.2 Centerline of bearing .....±3 mm

11.2.3 Abrupt form offset at barrier rail.....±3 mm

11.2.3.1 Location of openings through concrete elements .....±13 mm

#### 11.3—Vertical deviation

11.3.1 Profile grade .....±25 mm

11.3.2 *Top of other concrete surfaces and horizontal grooves*

Exposed.....±20 mm

Concealed.....±25 mm

11.3.3 Location of openings through concrete elements .....±13 mm

#### 11.4—Length, width, or depth of specified elements

11.4.1 Bridge slab thickness.....+6 mm  
.....-6 mm

11.4.2 Elements such as columns, beams, piers, and walls .....+13 mm  
.....-6 mm

11.4.3 Openings through concrete elements ....±13 mm

### COMMENTARY

#### R11.2—Horizontal deviation

**R11.2.2** Centerline of bearing refers to the primary girders or stringers. On highway plans, dimensions are usually given in hundredths of a meter. Millimeters are used here to conform to the rest of this document.

#### R11.3—Vertical deviation

**R11.3.1** Profile grade refers to the upper surface of an overpass. If the structure creates a highway underpass, then the clearance from the profile grade to the bottom of the lowest structural element should be +25 mm, -0 mm.

**SPECIFICATION**

**COMMENTARY**

**11.5—Deviation from plane**

**11.5.1** Slope of formed and unformed surfaces with respect to the specified plane shall not exceed the following amounts in 3 m:

- Watertight joints ..... ±3 mm
- Other exposed surfaces ..... ±13 mm
- Concealed surfaces..... ±25 mm

**11.5.2** Driving surface finish tolerances and method of measuring..... not specified

**11.6—Deck reinforcement cover**

- ..... +25 mm
- ..... -0 mm

**11.7—Bearing pads**

**11.7.1** Horizontal deviation of centerline ..... ±25 mm

**11.7.2** Edge dimensions in plan ..... ±25 mm

**11.7.3** Deviation from plane..... ±0.10%



## SECTION 12—EXTERIOR PAVEMENTS AND SIDEWALKS

### SPECIFICATION

### COMMENTARY

#### 12.1—Horizontal deviation

12.1.1 Placement of dowels.....±30 mm

12.1.2 *Alignment of dowels, relative to centerline of pavement*

460 mm or less projection.....±6 mm

Greater than 460 mm projection.....not established

#### 12.2—Vertical deviation of surface

12.2.1 Mainline pavements in longitudinal direction, the gap below a 3 m unlevelled straightedge resting on highspots shall not exceed ..... not specified

12.2.2 Mainline pavements in transverse direction, the gap below a 3 m unlevelled straightedge resting on highspots shall not exceed ..... not specified

12.2.3 Ramps, sidewalks, and intersections, in any direction, the gap below a 3 m unlevelled straightedge resting on highspots shall not exceed.....+6 mm

12.2.4 Driving surface finish tolerances as specified in Contract Documents.

**R12.2.1 and R12.2.2** Smoothness tolerances are not addressed within this document. Engineers and contractors should refer to the regional and local highway and roadway departments, including the American Association of State Highway and Transportation Officials (AASHTO).

**Notes**

# SECTION 13—CHIMNEYS AND COOLING TOWERS

## SPECIFICATION

## COMMENTARY

### 13.1—Deviation from plumb

Translation, rotation, or variance from the vertical axis shall not exceed the greater of  $\pm 0.1\%$  times the height at time of measurement or  $\pm 25$  mm.

In any 3 m of height, the geometric center of the chimney or cooling tower element shall not change more than..... $\pm 25$  mm

Tolerance requirements for openings and items embedded within concrete chimneys must be established on an individual basis depending on the specific nature of their use.

### 13.2—Outside shell diameter

Outside shell diameter  $\pm 1\%$  of the specified diameter plus 25 mm.

### 13.3—Wall thickness

The average of four wall thickness measurements taken over a 60-degree arc shall not exceed:

specified wall thickness 250 mm or less  
 .....+13 mm  
 .....-6 mm

specified wall thickness greater than 250 mm  
 .....+25 mm  
 .....-13 mm

**Notes**

## SECTION 14—CAST-IN-PLACE NONREINFORCED PIPE

### SPECIFICATION

### COMMENTARY

#### 14.1—Wall thickness

Wall thickness at any point shall be equal to the specified wall thickness of the pipe but no greater than the specified thickness plus 0.07 multiplied by the specified inside diameter

.....-0 mm, + 0.07 × the specified inside diameter

Cast-in-place concrete pipe tolerances relate to the accuracy of construction that can be achieved using machinery and equipment consistent with the standard practice for local soil types.

#### 14.2—Pipe diameter

The internal diameter at any point shall not be less than 98% of the design diameter.

#### 14.3—Offsets

At form laps and horizontal edges shall not exceed:

For pipe with an internal diameter not less than 1.1 m

.....±13 mm

For pipe with an internal diameter greater than 1.1 m

or less than or equal to 1.8 m .....±20 mm

For pipe with an internal diameter greater than 1.8 m

.....±25 mm

#### 14.4—Surface indentations

Maximum allowable .....±13 mm

#### 14.5—Grade and alignment

##### 14.5.1 Vertical deviation from grade

..... ±25 mm per 3 m

..... ±40 mm maximum

##### 14.5.2 Horizontal deviation from alignment

..... ±50 mm per 3 m

..... ±100 mm maximum

#### 14.6—Concrete slump

For pipe with an internal diameter less than 1.1 m

.....±40 mm

For pipe with an internal diameter from 1.1 m up to 1.8 m

.....±25 mm

For pipe with an internal diameter greater than 1.8 m

.....±13 mm

**Notes**

## SECTION 15—TILT-UP CONCRETE

### SPECIFICATION

### COMMENTARY

#### 15.1—Panel forming

##### 15.1.1 *Deviation from specified height or width*

Where specified height or width is 6 m or less .....±6 mm  
 Each additional 3 m or part thereof .....±3 mm  
 Not to exceed.....±13 mm

##### 15.1.2 *Deviation from specified thickness, measured (before edge form removal) using a string stretched taut over 13 mm thick blocks attached to the tops of the edge forms*

Unformed surface .....-6 mm  
 .....+13 mm

##### 15.1.3 *Difference in length of the two diagonals, of a rectangular member or opening, where length of diagonal is*

1.8 m or less .....±3 mm  
 Each additional 1.8 m or part thereof .....±3 mm  
 Not to exceed.....±13 mm

15.1.4 Opening dimension.....±6 mm

#### 15.2—Deviation from plumb

##### 15.2.1 *For heights less than or equal to 25.4 m*

The lesser of 0.3% times the height above the top of foundations as shown on Project Drawings or.....±25 mm

##### 15.2.2 *For heights greater than 25.4 m*

The lesser of 0.1% times the height above the top of foundations as shown on Project Drawings or.....±50 mm

**R15.1.2** To conform to the +13 mm thickness tolerance, the unformed surface of the panel should not touch the string at any location. To conform to the -6 mm tolerance, the panel should not be more than 20 mm below the string at any location.

Rather than measuring the panel thickness directly, string testing the upper panel surface before form removal infers compliance with the specified thickness tolerances by assuming that:

- The edge form height equals the nominal panel thickness;
- The edge forms are erected directly on the casting bed; and
- The surface profile of the casting bed is no worse than F<sub>F</sub>-18/F<sub>L</sub>-13.

Note that F<sub>F</sub>-18/F<sub>L</sub>-13 is the lowest-quality floor profile discussed in ACI 302.1R, and panels cast on such an irregular surface may have aesthetic problems.

**R15.1.4** A perfectly rectangular opening or member will have diagonals of equal length.

## SPECIFICATION

## COMMENTARY

### 15.3—Deviation from elevation

Top of exposed individual panel .....	±13 mm
Top of non-exposed individual panel .....	±20 mm
Difference at top of adjacent exposed panels .	±13 mm
Difference at top of adjacent non-exposed panels .....	±20 mm
Foundations.....	+6 mm
.....	-13 mm
Base of erected panel .....	±6 mm
Bearing plates or seats.....	±6 mm

### 15.4—Deviation from location

#### 15.4.1 Fabrication

Edge of opening in panel.....	±6 mm
Inserts, bolts, sleeves .....	±10 mm
Flashing reglets .....	±13 mm
Lifting inserts .....	±13 mm
Weld plates.....	±25 mm
Bearing plates or seats.....	±13 mm

#### 15.4.2 Erection

From centerline of steel (governs over grid datum) .....	±13 mm
From building grid datum, measured at base of panel .....	±13 mm

### 15.5—Deviation from slope or plane

#### 15.5.1 Fabrication

Weld plates.....	±6 mm
Bearing plates and seats.....	±3 mm
Edge of panel from centerline of panel.....	±10 mm

#### 15.5.2 Erection

**15.5.2.1 Bowing (due to erection stresses), measured within 72 hours after erection**  
..... 1/360 times the panel diagonal dimension, but not more than ±25 mm



**SPECIFICATION****COMMENTARY**

**15.5.2.2** Differential bowing, as erected, between adjacent members of the same design.....±13 mm

**15.5.2.3** *Warping (due to erection stresses), measured within 72 hours after erection*  
.... 5 mm per meter from nearest adjacent corner, but not more than ± 25 mm

**15.5.2.4** *Joint taper*  
Over panel height .....±13 mm  
Per 3 m .....±10 mm

**15.5.2.5** *Offset in alignment of adjacent matching faces*  
Exposed.....±10 mm  
Non-exposed .....±20 mm

Corners, exposed and non-exposed.....±13 mm

**15.6—Deviation from relative widths**

Joint width (governs over variation in joint width)  
.....±10 mm

Variation in joint width over length of panel.....±13 mm

**Notes**

## COMMENTARY

### NOTES TO SPECIFIER

ACI Specification 117M-10 is incorporated by reference in the Project Specification using the wording in G3 of the General Notes. The Specifier may include information from the Mandatory Requirements Checklist and Optional Requirements Checklist that follow the Specification. The Specifier, however, must select the items and include them separately in the Project Specifications.

#### General notes

**G1.** ACI Specification 117M-10 is intended to be used by reference or incorporation in its entirety in the Project Specification. Do not copy individual Sections, Parts, Articles, or Paragraphs into the Project Specification, because taking them out of context may change their meaning.

**G2.** If Sections or Parts of ACI Specification 117M-10 are copied into the Project Specification or any other document, do not refer to them as an ACI specification because the specification has been altered.

**G3.** A statement such as the following will serve to make ACI Specification 117M-10 a part of the Project Specification:

“Work on (Project Title) shall conform to all requirements of ACI 117M-10, published by the American Concrete Institute, Farmington Hills, Michigan, except as modified by these Contract Documents.”

**G4.** Each technical section of ACI Specification 117M-10 in this Standard associated with items in the Mandatory Requirements Checklist are accompanied by text indicating an item in the section is specified in the Contract Documents. Sections in this Standard associated with items in the Optional Requirements Checklist establish a default value and are accompanied by the following text, “unless noted otherwise.” The language in each technical Section of ACI Specification 117M-10 is imperative and terse.

**G5.** ACI Specification 117M-10 is written to the Contractor. When a provision of this Specification requires action by the Contractor, the verb “shall” is used. If the Contractor is allowed to exercise an option when limited alternatives are available, the phrasing “either... or...” is used. Statements provided in the specification as information to the Contractor use the verbs “may” or “will.” Informational statements typically identify activities or options that “will be taken” or “may be taken” by the Owner or Architect/Engineer.

**SPECIFICATION**

**COMMENTARY**

## COMMENTARY

## FOREWORD TO CHECKLISTS

**F1.** This Foreword is included for explanatory purposes only; it does not form a part of ACI Specification 117M-10.

**F2.** ACI Specification 117M-10 may be referenced by the Specifier in the Project Specification for any building project, together with supplementary requirements for the specific project. Responsibilities for project participants must be defined in the Project Specifications. ACI Specification 117M-10 cannot and does not address responsibilities for any project participant other than the Contractor.

**F3.** Checklists do not form a part of ACI Specification 117M-10. Checklists assist the Specifier in selecting and specifying project requirements in the Project Specifications.

**F4.** Building codes set minimum requirements necessary to protect the public. ACI Specification 117M-10 may stipulate requirements more restrictive than the minimum. The Specifier shall make adjustments to the needs of a particular project by reviewing each of the items in the checklists and including those the Specifier selects as mandatory requirements in the Project Specifications.

**F5.** The Mandatory Requirements Checklist indicates Work requirements regarding specific qualities, procedures,

materials, and performance criteria that are not defined in ACI Specification 117M-10.

**F6.** The Optional Requirements Checklist identifies Specifier choices and alternatives. The Checklist identifies the Sections, Parts, and Articles of the Reference Specification 117M-10 and the action required or available to the Specifier. The Specifier should review each of the items in the Checklist and make adjustments to the needs of a particular project by including those selected alternatives as mandatory requirements in the Project Specifications.

**F7.** *Recommended references*—Documents and publications that are referenced in the Commentary of ACI Specification 117M-10 are listed below. These references provide guidance to the Specifier and are not considered to be part of ACI Specification 117M-10.

Martinez, J., and Davenport, B., 2005, “The Relationship Between Sawed Joints and Dowel Bars,” *Concrete Pavement Progress*, The American Concrete Pavement Association, Skokie, IL, V. 41, No. 3, Mar., 12 pp.; also as an electronic newsletter: <http://www.pavement.com/PPP/2005/PPP-March05.pdf>. (accessed March 16, 2010)

## MANDATORY REQUIREMENTS CHECKLIST

Section/Part/Article	Notes to the Specifier
<b>Section 1—General requirements</b>	
<b>1.1.2 Scope</b>	Tolerance values affect construction cost. Specific use of a tolerance item may warrant less or more stringent tolerances than contained in the specification. Identify in the Contract Documents any tolerances the Contractor is required to achieve, but are not addressed in ACI 117M. Designate Exposed Concrete and Architectural Concrete in the Contract Documents. Coordinate tolerances for concrete construction and those of any materials that interface with, or attach to, the concrete structure. Specify concrete tolerances that are more or less stringent than those contained in this specification. Specification of more restrictive tolerances for specialized constructions, such as architectural concrete, often results in an increase in material cost and time of construction. The Specifier should specify dimensional tolerances considered essential to successful execution of the design. Success may require one or more of the individual tolerances to be more restrictive than those contained in ACI 117M. The preconstruction meeting provides an opportunity for the design/construction team to identify and resolve, before actual construction, any tolerance compatibility issues relative to concrete Work and materials with which concrete interfaces. Successful resolution of any questions will almost certainly require active participation of the Design Professional. Specify acceptance criteria in accordance with ACI 301M or equivalent.
<b>Section 2—Materials</b>	
<b>2.2 Reinforcement</b>	Tolerances for fabrication, placement, and lap splices for welded wire reinforcement must be specified by the Specifier.
<b>Section 3—Foundations</b>	
<b>3.1 Drilled piers</b>	Specify category of drilled pier. The Specifier should be aware that the recommended vertical alignment tolerance of 1.5% of the shaft length indicated in Category B drilled piers is based on experience in a wide variety of soil situations combined with a limited amount of theoretical analysis using the beam on elastic foundation theory and minimum assumed horizontal soil restraint.
<b>Section 4—Cast-in-place concrete for buildings</b>	
<b>4.8.3 Form offsets</b>	Designate class of surface (A, B, C, D) (also refer to ACI 301M and 347): Class A: For surfaces prominently exposed to public view where appearance is of special importance; Class B: Coarse-textured, concrete-formed surfaces intended to receive plaster, stucco, or wainscoting; Class C: General standard for permanently exposed surfaces where other finishes are not specified; and Class D: Minimum quality surface where roughness is not objectionable, usually applied where surfaces will be concealed.
<b>4.8.4 Floor finish</b>	Designate <b>Section 4.8.5</b> and <b>4.8.6</b> . Refer to <b>Table R4.8.4</b> .
<b>4.8.4.1</b>	Designate the surface classification for all floors. Refer to <b>Tables 4.8.5.1</b> and <b>4.8.6.1</b> .
<b>4.8.5.1</b>	Designate Floor Surface Classification.
<b>4.8.6.1</b>	Designate Floor Surface Classification.

## COMMENTARY

### MANDATORY REQUIREMENTS CHECKLIST (cont.)

<b>Section 5—Precast concrete</b>	
	Specify tolerances for precast concrete.
<b>Section 6—Masonry</b>	
	Specify tolerances for masonry elements.
<b>Section 11—Cast-in-place bridges</b>	
<b>11.5.2 Driving surface finish tolerances</b>	Specify driving surface finish tolerances and method of testing.
<b>Section 12—Exterior pavements and sidewalks</b>	
<b>12.2.4</b>	Specify driving surface finish tolerances. Specify method of testing.

### OPTIONAL REQUIREMENTS CHECKLIST

Section/Part/Article	Notes to the Specifier
<b>Section 1—General requirements</b>	
<b>1.1 Scope</b>	Specialized concrete construction or construction procedures require the Specifier to include specialized tolerances. ACI committee documents covering specialized construction may provide guidance on specialized tolerances. Specify tolerances for Architectural Concrete. Refer to ACI 303.1 for guidance.
<b>Section 2—Materials</b>	
<b>2.2</b>	CRSI 10MSP, Appendix C, provides valuable information concerning development of details for placement of reinforcement.
<b>2.2.2 Concrete cover</b>	The tolerance for reduction in cover in reinforcing steel may require a reduction in magnitude where the reinforced concrete is exposed to chlorides or the environment. Where possible, excess cover to other protection of the reinforcing steel should be specified instead of reduced tolerance because of the accuracy of locating reinforcing steel using standard fabrication accessories and installation procedures.
<b>2.2.6.1</b>	The Specifier may elect to specify alternate tolerance for horizontal deviation of prestressing reinforcing or prestressing ducts.
<b>2.3.2 Embedded items</b>	Tolerance given is for general application. Specific design use of embedded items may require the Specifier to designate tolerances of reduced magnitude for various embedded items.
<b>Section 3—Foundations</b>	
<b>3.1, 3.2, 3.3, 3.4, and 3.5</b>	Tolerances given are for general application. Refer to ACI 336.1 for guidance.
<b>3.5.3</b>	Plus tolerance for the vertical dimension is not specified because no limit is imposed. Specifier should designate plus tolerance if desired.
<b>Section 4—Cast-in-place concrete for buildings</b>	
<b>4.5.3</b>	Chose plus tolerance for slab thickness.
<b>4.6.1</b>	Specifiers are cautioned that a tighter tolerance should be specified where there is a potential for cutting reinforcement.
<b>4.8</b>	Choose Waviness Index as alternative to methods specified in <b>Section 4.8.5</b> or <b>4.8.6</b> . Testing shall be in accordance with ASTM E1486M. Specified Overall Surface Waviness Index and Minimum Local Surface Waviness Index must be specified.
<b>4.8.4.3</b>	Designate testing agency.
<b>4.8.4.4</b>	Designate distribution of test reports.
<b>4.8.6.3</b>	Choose computerized simulation of manual straightedge. Specify minimum number of samples, test procedure (must be reproducible), and acceptance criteria.



**American Concrete Institute®**  
*Advancing concrete knowledge*

As ACI begins its second century of advancing concrete knowledge, its original chartered purpose remains "to provide a comradeship in finding the best ways to do concrete work of all kinds and in spreading knowledge." In keeping with this purpose, ACI supports the following activities:

- Technical committees that produce consensus reports, guides, specifications, and codes.
- Spring and fall conventions to facilitate the work of its committees.
- Educational seminars that disseminate reliable information on concrete.
- Certification programs for personnel employed within the concrete industry.
- Student programs such as scholarships, internships, and competitions.
- Sponsoring and co-sponsoring international conferences and symposia.
- Formal coordination with several international concrete related societies.
- Periodicals: the *ACI Structural Journal* and the *ACI Materials Journal*, and *Concrete International*.

Benefits of membership include a subscription to *Concrete International* and to an ACI Journal. ACI members receive discounts of up to 40% on all ACI products and services, including documents, seminars and convention registration fees.

As a member of ACI, you join thousands of practitioners and professionals worldwide who share a commitment to maintain the highest industry standards for concrete technology, construction, and practices. In addition, ACI chapters provide opportunities for interaction of professionals and practitioners at a local level.

**American Concrete Institute**  
**38800 Country Club Drive**  
**Farmington Hills, MI 48331**  
**U.S.A.**  
**Phone: 248-848-3700**  
**Fax: 248-848-3701**

**[www.concrete.org](http://www.concrete.org)**

# Specification for Tolerances for Concrete Construction and Materials and Commentary

## The AMERICAN CONCRETE INSTITUTE

was founded in 1904 as a nonprofit membership organization dedicated to public service and representing the user interest in the field of concrete. ACI gathers and distributes information on the improvement of design, construction and maintenance of concrete products and structures. The work of ACI is conducted by individual ACI members and through volunteer committees composed of both members and non-members.

The committees, as well as ACI as a whole, operate under a consensus format, which assures all participants the right to have their views considered. Committee activities include the development of building codes and specifications; analysis of research and development results; presentation of construction and repair techniques; and education.

Individuals interested in the activities of ACI are encouraged to become a member. There are no educational or employment requirements. ACI's membership is composed of engineers, architects, scientists, contractors, educators, and representatives from a variety of companies and organizations.

Members are encouraged to participate in committee activities that relate to their specific areas of interest. For more information, contact ACI.

**[www.concrete.org](http://www.concrete.org)**



**American Concrete Institute®**

*Advancing concrete knowledge*